



# ***Plastic-Lined Piping Systems***

The Next Generation of Safety, Quality and Innovation



**BAUM America Corp**

46 Mesa Dr. St. Albans, WV 25177

Phone: (304) 755-2571 Fax: (304) 755-2573

E-Mail: [info@baumamericacorp.com](mailto:info@baumamericacorp.com)

[www.baumamericacorp.com](http://www.baumamericacorp.com)

# BAUM America Corp

Baum Kunststoffe GmbH, a German company founded by Roland Baum in 1986, is a world-wide leader in the plastic lined piping industry. They manufacture and stock product in the U.S. through the Baum America Corp. Today they continue as a family owned and operated business and are currently managed by CEO Markus Baum.

Baum offers complete manufacturing capability from steel to plastic. Paste extrusion is done on specially designed extruders and lining uses highly automated production processes. Baum uses assets including state-of-the-art transfer molding to ensure speed to market. Today Baum manufactures plastic lined pipe, fittings, vessels, dip tubes, valves and expansion joints that are protected from corrosion using PTFE, PFA, ETFE, PVDF or PP. All parts are supplied in accordance with ASTM F1545-97 (2009).



*Markus Baum  
Chief Executive Officer  
Baum Kunststoffe GmbH*

## **Before you purchase a corrosion resistant piping system we invite you to compare.**

- Baum PTFE liners are paste extruded. This ensures permeation resistance that exceeds the isostatically molded PTFE products common in the US. This claim is supported by independent testing by the Korrosionsinstitutet of Sweden.
- Many of the Baum fittings will be upgraded to injection molded PFA. This is an even higher quality polymer with mechanical properties and permeation resistance that normally come at a much higher price. Injection molding these fittings means that Baum products come with full penetration welds unlike the welded over designs.
- Baum metal housings will feature rotating A105 forged steel flanges as standard. Most domestic producers typically charge for similar upgrades.
- Quality is verified by rigorous testing and assured with Insurance company certification. The Pressure Equipment Directive (PED) requires not only participation in an ISO quality program but 100% traceability, spark and hydro testing, constant batch testing and permanent marking. Individual Baum components can be traced online for your convenience.
- Greater flexibility in design... (Schedule 10 stainless steel systems, DIN dimensions, electro-polished stainless steel exteriors, conductive PTFE, etc) is available.

With Baum's stringent quality programs, testing, traceability, and permanent marking the highest level of safety and quality are assured. While other manufacturers provide products that simply comply with the current standards, Baum products search for solutions that will last protecting personnel and the environment to a higher set of criteria. The bar has been raised! Baum products represent the next level of safety and product quality.



# Technical Specifications

These specifications define the material, technical data, fitting instructions and quality checks for our PTFE, PFA, ETFE, PVDF and PP lined pipe and fittings.

They are in accordance with the following standards: ASTM F1545-97 (2009) for general requirements and ASME B16.5 and B16.1 for dimensions.

## Contents

	<b>Page</b>
<b>Materials</b>	<b>2</b>
Steel parts	
Lining	
External coating	
<b>General Technical Data</b>	<b>3</b>
Liner thickness	
Operating temperatures	
Vacuum resistance	
Vent holes	
<b>Quality Management</b>	<b>4</b>
Welding	
Material certificates	
Raw materials checks	
Optical and dimensional checks	
Spark tests	
Hydrostatic tests	
Marking	
Identification bands	
<b>Installation Instructions</b>	<b>5</b>
Protective covers	
Gaskets	
Torques	
Welding operations	
Vent holes	
Bolt Lengths	
<b>Chemical Resistance</b>	<b>6</b>
PTFE	
PFA	
PP, PVDF	
ETFE	
<b>Pipe and Flange Dimensions</b>	
Class 150	<b>6</b>
Class 300	<b>7</b>
<b>Product development</b>	<b>8</b>

## Introducing the next level of permeation resistance!

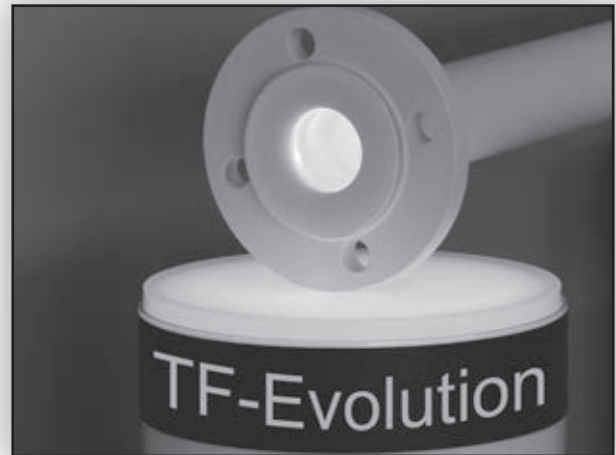

Contact Baum America for information on TF-Evolution – the ultimate solution to your permeation issues.

<b>Products</b>	<b>Page</b>
Pipe	<b>6-8</b>
Spacers/Flanges	<b>9</b>
Elbows 45°/90°	<b>10</b>
Laterals	<b>11</b>
Short Stack Tees and Short Stack Crosses	<b>11</b>
Strainer Tees	<b>11</b>
Tees	<b>12,13</b>
Crosses	<b>14</b>
Instrument Tees	<b>15</b>
Reducing Flanges	<b>16, 17</b>
Concentric Reducers	<b>18</b>
Eccentric Reducers	<b>19</b>
Hose	<b>20</b>
Jacketed Pipe & Fittings	<b>20</b>
Nozzle Liners	<b>25</b>
Expansion Joints	<b>21-25</b>
Dip Tubes & Spargers	
(PTFE Lined & Covered)	<b>26</b>
Dip Tubes & Spargers (Solid PTFE)	<b>27</b>
Fixed, One Piece Threaded Field Flare Flange	<b>27</b>
Two Piece Field Fabrication Flanges	<b>28</b>

# I. Material

## I.1 Steel parts

- I.1.1 All steel pipe (carbon steel) is furnished in either ASTM A106 Gr. B, A587 Gr. B ERW, or A53 Gr. B ERW depending on size and manufacturing location.
- I.1.2 Flanges comply with ASTM A105
- I.1.3 Fittings comply with ASTM A234 Gr. WPB
- I.1.4 Stainless steel is supplied per customer specification.

## I.2 Lining

- I.2.1 Liner Physical Properties (test method:ASTM D638)

PROPERTY	PTFE	PFA	PP	PVDF	ETFE
Sp. Gravity	2.14 - 2.19	2.11 - 2.17	.90	1.75 - 1.78	1.70 - 1.72
Tensile Strength (psi)	4,500	3,800	3,000	5,000	6,700
Elongation (%)	350-400	300	300	50	150-300
Melt Point	625	580	338	340	491
Max. Service Temp. (°F)	450	450	225	275	300
Colors	Natural	Natural	Orange	Black	Natural

- I.2.2 Plastics Conductivity (PTFE)

DIN/EC 60093 and DIN/EC 60167 does not exceed 10° Ohm.

- I.2.3 FDA Compliance

PTFE, PVDF, ETFE, and PP lining of our piping parts complies with the regulations of the Food and Drug Administration (FDA). This includes our conductive liner.

## I.3 External Coating

- I.3.1 Sandblasting

All carbon steel parts are sandblasted according to SA 2.5.

- I.3.2 Paint coating

According to our standard specification all carbon steel pipe is painted with an epoxy primer to protect it from corrosion.



## 2. General Technical Data

### Liner Thickness & Vacuum Resistance

<b>NPS (in)</b>	<b>1"</b>	<b>1-1/2"</b>	<b>2"</b>	<b>3"</b>	<b>4"</b>	<b>6"</b>	<b>8"</b>	<b>10"</b>	<b>12"</b>
<b>PTFE</b>									
Liner Thickness (in)	.130	.150	.160	.160	.160	.275	.310	.310/.42	.310/.45
Vacuum (in. Hg)	Full	Full	Full	Full	Full	Full	Full	*/FV	*/FV
Temperature (°F)	450	450	450	450	450	450	450	250/450	250/450
<b>PP</b>									
Liner Thickness (in)	.150	.175	.175	.175	.220	.250	.280	.280	.300
Vacuum (in. Hg)	Full	Full	Full	Full	Full	Full	Full	Full	Full
Temperature (°F)	225	225	225	225	225	225	225	225	225
<b>PVDF</b>									
Liner Thickness (in)	.150	.175	.175	.175	.220	.250	.220		
Vacuum (in. Hg)	Full	Full	Full	Full	Full	Full	Full		
Temperature (°F)	275	275	275	275	275	275	275		
<b>PFA</b>									
Liner Thickness (in)	.120	.120	.120	.120	.150	.140	.155	O/A	O/A
Vacuum (in. Hg)	Full	Full	Full	Full	Full	Full	Full	Consult	Factory
Temperature	450	450	450	450	450	250	150	Consult	Fact

\*Vacuum ratings for 10" and larger fittings and .31" liner pipe spools have limitations.  
Consult factory.

Note 1: All vacuum data reflects testing done per ASTM F1545-97 (2009)

Note 2: Vacuum Ratings may not apply for short stack crosses, laterals, crosses, special angle elbows and sight indicators 4" and above. Consult factory.

Note 3: Certain chemicals may affect vacuum ratings. Consult factory.

Note 4: Larger sizes require special attention. Factors such as length of spool, rapid cool down and sudden pressure drops should be anticipated and vacuum breakers should be considered.

Note 5: 1"-8" fittings meet or exceed pipe liner thickness and vacuum ratings for same size and liner material.

**2.1 Tolerances:** Defined in ASTM F1545-97 (2009) ANSI B16.1 and ASME B16.5. The liner thickness may vary approximately 10% but always meets or exceeds the ASTM minimum.

## 3. Quality Management

### 3.1 Welding

Our welding processes are subject to the following criteria:

1. We are a recognized manufacturer in accordance with AD-Merkblatt HPO/TRD 201/DIN EN 729-2.
2. Our processes conform to AD-Merkblatt HP 2/1.
3. Our operations are supervised by a recognized welding expert.
4. We only employ welders with a HP 3 certificate.

### 3.2 Material certificates

All pipe, flanges, elbows and welded fittings have a works certificate according to EN 10204-3.1.B.

### 3.3 Raw material checks

Lining materials are only procured with material certificates WAZ 2.3 from manufacturers certified according to ISO 9001.

In addition, our lab continually checks and records the physical data of semi-finished products from the production line.

### 3.4 Optical and dimensional checks

The dimensions of all pipe and fittings are checked visually.

### 3.5 Spark tests

All lined pipes (not conductive) and fittings undergo a 25,000 Volt spark test to make sure the lining is not porous.

### 3.6 Hydrostatic tests

The standard hydrostatic test is carried out with 1.43 times the nominal working pressure (15 bar). Testing with higher pressure and duration is available on a special order basis.

### 3.7 Marking

In accordance with ASTM F1545-97 (2009), every pipe and fitting is marked as follows:

Manufacturer's sign  
Production lot  
Lining material  
Date of production  
CE marking (if applicable)  
Additional markings – e.g. material no.– are available upon customer request.

### 3.7 Identification Bands

All pipe and fittings are shipped with a color coded plastic band. Embossed letters indicate the liner and manufacturer.

## 4. Installation Instructions

### 4.1 Protective covers

Protective covers must only be removed immediately before installation.

### 4.2 Gaskets

Flared surfaces of identical plastic materials do not require gaskets. Gaskets may only be sensible for connections frequently undone or for connections to other materials such as metal, glass, enamel, etc.

### 4.3 Torques (Class 150 and 300)

Details for assembly and operating instructions can be found in our data sheet FB 03.4b assembly and operating instructions. Please see table on cover for additional installation guidelines.

### 4.4 Welding operations

Lined pipes and fittings may not be welded, as the high temperature will destroy the plastic.

### 4.5 Vent holes

Vent holes should at all times be kept open. Care should be taken not to clog them with paint or insulating material.

### 4.6 Bolt/Stud Lengths

Calculated to include two threads past the nut and rounded to the nearest 1/4" to insure commercial availability.

Nominal pipe size NPS	ANSI B16.5 Class 150			ANSI B16.5 Class 300				
	# bolts x size	Bolt Torque (ft-lbs)			# bolts x size	PTFE /PFA bolt torque	PP	PVDF
		PTFE/PFA	PP	PVDF				
1/2"	4 x 1/2"	10	X	X	4 x 1/2"	12	CF	CF
3/4"	4 x 1/2"	10	X	X	4 x 5/8"	12	CF	CF
1"	4 x 1/2"	10	30	35	4 x 5/8"	12	CF	CF
1 1/2"	4 x 1/2"	15	40	50	4 x 3/4"	16	CF	CF
2"	4 x 5/8"	25	45	50	8 x 5/8"	19	CF	CF
2 1/2"	4 x 5/8"	33	80	75	8 x 3/4"	29	CF	CF
3"	4 x 5/8"	40	80	75	8 x 3/4"	33	CF	CF
4"	8 x 5/8"	30	80	75	8 x 3/4"	47	CF	CF
6"	8 x 3/4"	60	120	120	12 x 3/4"	73	CF	CF
8"	8 x 3/4"	75	150	120	12 x 7/8"	76	CF	CF
10"	12 x 7/8"	70	140	140	16 x 1"	83	CF	CF
12"	12 x 7/8"	90	140	140	16 x 1 1/8"	87	CF	CF
14"	12 x 1"	152	CF	CF				
16"	16 x 1"	143	CF	CF				
18"	16 x 1 1/8"	210	CF	CF				
20"	20 x 1 1/8"	190	CF	CF				
24"	20 x 1 1/8"	221	CF	CF				

FxF - Fixed x Fixed  
FxF = Fixed x Rotatable  
RxR = Rotatable x Rotatable

Flange Size	Stud Length			Bolt Length		
	FxF	FxF	RxR	FxF	FxF	RxR
1"	3"	3 1/4"	3 1/4"	2 1/2"	2 3/4"	2 3/4"
1 1/2"	3 1/4"	3 1/2"	3 1/2"	2 3/4"	3"	3"
2"	4"	4"	4 1/4"	3 1/4"	3 1/4"	3 1/2"
2 1/2"	4"	N/A	N/A	3 1/2"	N/A	N/A
3"	4 1/4"	4 1/2"	4 1/2"	3 1/2"	3 3/4"	4"
4"	4 1/4"	4 1/2"	4 1/2"	3 1/2"	3 3/4"	4"
6"	5"	5"	5 1/4"	4 1/4"	4 1/4"	4 1/2"
8"	5"	5 1/4"	5 1/2"	4 1/4"	4 1/2"	4 3/4"
10"	5 1/2"	5 3/4"	6"	4 1/4"	4 3/4"	5 1/4"
12"	5 1/2"	5 3/4"	6 1/4"	4 3/4"	5"	4 1/2"

Flange Size	Stud Length			Bolt Length		
	FxF	FxF	RxR	FxF	FxF	RxR
1"	3 1/2"	3 3/4"	3 3/4"	3"	3 1/4"	3 1/4"
1 1/2"	4"	4 1/4"	4 1/2"	3 1/2"	3 3/4"	3 3/4"
2"	4"	4"	4 1/4"	3 1/4"	3 1/2"	3 3/4"
3"	4 3/4"	5 1/4"	5 1/4"	4 1/4"	4 3/4"	4 3/4"
4"	5"	5 1/2"	5 1/2"	4 1/2"	5"	5"
6"	5 1/2"	5 3/4"	6"	4 3/4"	5 1/4"	5 1/4"
8"	6 1/4"	7"	7"	5 1/4"	5 3/4"	6 1/4"
10"	7"	7 1/4"	7 3/4"	6"	6 1/4"	6 3/4"
12"	7 3/4"	8"	8 1/4"	6 1/2"	6 3/4"	7"

## 5. Chemical Resistance

- 5.1 PTFE - a universal chemical resistance against almost all chemicals and solvents within its continuous operating temperature - with the exception of molten alkalis, elementary fluorine and certain halogens.
- 5.2 PFA identical with PTFE.
- 5.3 PP & PVDF Please refer to the manufacturer's information. Both may vary in temperature capability with various media and concentrations of those media.
- 5.4 ETFE consult factory.

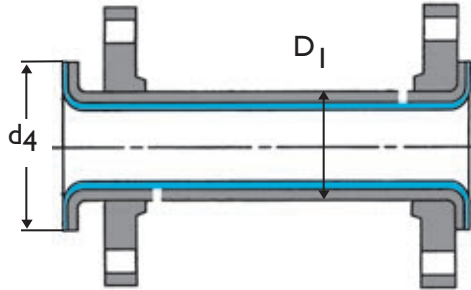

## 6. Pipe and flange dimensions for lined pipe and fittings

### 6.1 Class 150

NPS	Flange OD		Pipe OD $D_1$		Raised Face OD $d_4$		Schedule						Lining Material		
	mm	in.	mm	in.	mm	in.	Sch 20		Sch 30		Sch 40		PTFE	PVDF	PP
1/2"	88.9	3.50	21.3	0.84	35.1	1.38	---	---	---	---	2.8	0.11	●		
3/4"	98.4	3.87	26.7	1.05	42.9	1.69	---	---	---	---	2.9	0.11	●		
1"	107.9	4.25	33.4	1.31	50.8	2.00	---	---	---	---	3.4	0.13	●	●	●
1 1/4"	117.5	4.63	42.2	1.66	63.5	2.50	---	---	---	---	3.6	0.14	●		
1 1/2"	127.0	5.00	48.3	1.90	73.2	2.88	---	---	---	---	3.7	0.15	●	●	●
2"	152.4	6.00	60.3	2.37	91.9	3.62	---	---	---	---	3.9	0.15	●	●	●
2 1/2"	177.8	7.00	73.0	2.87	104.6	4.12	---	---	---	---	5.2	0.20	●	●	●
3"	190.5	7.50	88.9	3.50	127.0	5.00	---	---	---	---	5.5	0.22	●	●	●
4"	228.6	9.00	114.3	4.50	157.2	6.19	---	---	---	---	6.0	0.24	●	●	●
5"	254.0	10.00	141.3	5.56	185.7	7.31	---	---	---	---	6.6	0.26	●		
6"	279.4	11.00	168.3	6.63	215.9	8.50	---	---	---	---	7.1	0.28	●	●	●
8"	342.9	13.50	219.1	8.63	269.7	10.62	---	---	7.0	0.28	8.2	0.32	●	●	●
10"	406.4	16.00	273.0	10.75	323.9	12.75	6.4	0.25	7.8	0.31	9.3	0.37	●		●
12"	482.6	19.00	323.8	12.75	381.0	15.00	6.4	0.25	8.4	0.33	10.3	0.41	●		●
14"	533.4	21.00	355.6	14.00	412.8	16.25	---	---	9.5	0.37	11.1	0.44	●		●
16"	596.9	23.50	406.4	16.00	469.9	18.50	7.9	0.31	9.5	0.37	12.7	0.50	●		●
18"	635.0	25.00	457.2	18.00	533.4	21.00	7.9	0.31	11.1	0.44	14.3	0.56	●		●
20"	698.5	27.50	508.0	20.00	584.2	23.00	9.5	0.37	12.7	0.50	15.1	0.59	●		

D = outer diameter flange  $d_4$  = outer diameter face

$D_1$  = diameter pipe



## 6.2 Class 300

NPS	Flange OD		Pipe OD D <sub>1</sub>		Raised Face OD d <sub>4</sub>		Schedule						Lining Material		
	mm	in.	mm	in.	m m	in.	Sch 20		Sch 30		Sch 40		PTFE	PVDF	PP
							mm	in.	mm	in.	mm	in.			
½"	95.2	3.75	21.3	0.84	35.0	1.38	---	---	---	---	2.8	0.11	●		
¾"	117.3	4.62	26.7	1.05	42.9	1.69	---	---	---	---	2.9	0.11	●		
1"	123.9	4.88	33.5	1.31	50.8	2.00	---	---	---	---	3.4	0.13	●	●	●
1¼"	133.3	5.25	42.2	1.66	63.5	2.50	---	---	---	---	3.6	0.14	●		
1½"	155.4	6.12	48.3	1.90	73.1	2.88	---	---	---	---	3.7	0.15	●	●	●
2"	165.1	6.50	60.4	2.38	91.9	3.62	---	---	---	---	3.9	0.15	●	●	●
2½"	190.5	7.50	73.1	2.88	104.6	4.12	---	---	---	---	5.2	0.20	●		
3"	209.5	8.25	88.9	3.50	127.0	5.00	---	---	---	---	5.5	0.22	●	●	●
4"	254	10.00	114.3	4.50	157.2	6.19	---	---	---	---	6.0	0.24	●	●	●
5"	279.4	11.00	141.3	5.56	185.6	7.31	---	---	---	---	6.6	0.26	●		
6"	317.5	12.50	168.4	6.63	215.9	8.50	---	---	---	---	7.1	0.28	●	●	●
8"	381	15.00	219.2	8.63	269.7	10.62	---	---	7.0	0.28	8.2	0.32	●	●	●
10"	444.5	17.50	273.0	10.75	323.9	12.75	6.4	0.25	7.8	0.31	9.3	0.37	●		●
12"	520.7	20.50	323.8	12.75	381.0	15.00	6.4	0.25	8.4	0.33	10.3	0.41	●		●
14"	584.2	23.00	355.6	14.00	412.7	16.25	---	---	9.5	0.37	11.1	0.44	●		●
16"	647.7	25.50	406.4	16.00	469.9	18.50	7.9	0.31	9.5	0.37	12.7	0.50	●		●
18"	711.2	28.00	457.2	18.00	533.4	21.00	7.9	0.31	11.1	0.44	14.3	0.56	●		●
20"	774.7	30.50	508.0	20.00	584.2	23.00	9.5	0.37	12.7	0.50	15.1	0.59	●		●

D = outer diameter flange d<sub>4</sub> = outer diameter face

D<sub>1</sub> = diameter pipe

## 7. Product development

This documentation is based on the experience we have gained up to now, it is intended to provide the user with advice. All information is to the best of our knowledge, believed correct and given without responsibility.

We assume no liability with respect to the execution and nature of our products as well as their performance.

We reserve the right to make technical changes resulting from the further development of our products without giving prior notice.

We reserve the right to change the lining material between PTFE and PFA for manufacturing improvement.

# Lined Pipe (Class 150 and Class 300)

fixed - fixed



fixed - loose



loose - loose



NPS	Length (L) mm		Length (L) Inches		Lining material		
	max.	min.	max.	min.	PTFE	PVDF	PP
1/2"	6096	65	240.0	2.56	●		
3/4"	6096	75	240.0	2.95	●		
1"	6096	75	240.0	2.95	●	●	●
1 1/4"	6096	80	240.0	3.15	●		
1 1/2"	6096	80	240.0	3.15	●	●	●
2"	6096	90	240.0	3.54	●	●	●
2 1/2"	6096	90	240.0	3.54	●	●	●
3"	6096	100	240.0	3.94	●	●	●
4"	6096	100	240.0	3.94	●	●	●
5"	6096	100	240.0	3.94	●		
6"	6096	100	240.0	3.94	●	●	●
8"	6096	120	240.0	4.72	●	●	●
10"	3048	130	120.0	5.12	●		●
12"	3048	130	120.0	5.12	●		●
14"	3048	130	120.0	5.12	●		
16"	3048	130	120.0	5.12	●		
18"	3048	130	120.0	5.12	●		
20"	2000	140	78.7	5.51	●		

## Pressure Capabilities

Temperature	ANSI	ANSI
	Class 150	Class 300
100°F (38°C)	250 psig	450 psig
150°F (68°C)	242 psig	415 psig
200°F (93°C)	235 psig	390 psig
300°F (149°C)	215 psig	345 psig
400°F (204°C)	200 psig	295 psig
500°F (260°C)	170 psig	245 psig

Plastic-lined pipe and fittings with A105/A395 flanges.

\*Note: Plastic sealing faces are restricted on temperature and pressure.



# Spacers (Class 150 and Class 300)

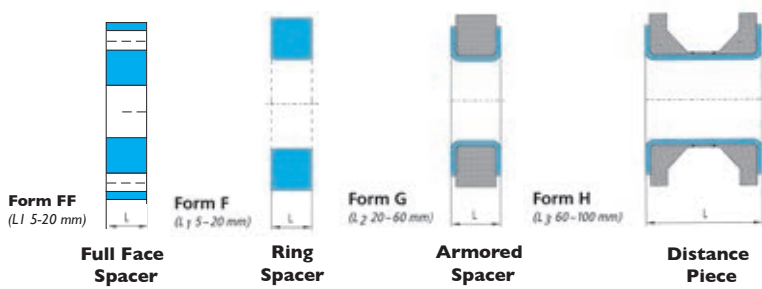

Note: Solid plastic spacers are available with single taper, double taper or taper bore.

NPS	Lining material		
	PTFE	PVDF	PP
1/2"	●		
3/4"	●		
1"	●	●	●
1 1/4"	●		
1 1/2"	●	●	●
2"	●	●	●
2 1/2"	●		
3"	●	●	●
4"	●	●	●
5"	●		
6"	●	●	●
8"	●	●	●
10"	●	●	●
12"	●	●	●
14"	●		
16"	●		
18"	●		
20"	●		

## Flanges

### CLASS 150 ROTATING AND BLIND FLANGES (FORGED STEEL)

Size of Flange	Flange OD A	Hub Diameter B *	Thickness C	Overall Thickness D	Bolt Holes E		Bolt Circle Diameter F	150# Bolt Info.	
					No.	Size		Bolt Size	Nut Thk
1"	4 1/4"	1 5/16"	9/16"	1 1/16"	4	5/8"	3 1/8"	1/2" - 13	.50
1 1/2"	5"	2 9/16"	1 1/16"	7/8"	4	5/8"	3 7/8"	1/2" - 13	.50
2"	6"	3 1/16"	3/4"	1"	4	3/4"	4 3/4"	5/8" - 11	.625
2 1/2"	7"	3 9/16"	7/8"	1 1/8"	4	3/4"	5 1/2"	5/8" - 11	.625
3"	7 1/2"	4 1/4"	15/16"	1 3/16"	4	3/4"	6"	5/8" - 11	.625
4"	9"	5 5/16"	15/16"	1 5/16"	8	3/4"	7 1/2"	5/8" - 11	.625
6"	11"	7 9/16"	1"	1 9/16"	8	7/8"	9 1/2"	3/4" - 10	.750
8"	13 1/2"	9 11/16"	1 1/8"	1 3/4"	8	7/8"	11 3/4"	3/4" - 10	.750
10"	16"	*	-	-	12	1"	14 1/4"	7/8" - 9	.875
12"	19"	*	-	-	12	1"	17"	1 1/8" - 9	.875

\*Blind flange only.

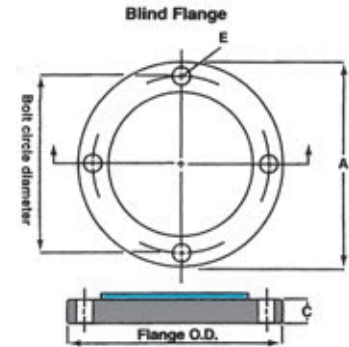

### CASS 300 ROTATING AND BLIND FLANGES

Size of Flange	Flange OD A	Hub Diameter B *	Thickness C	Overall Thickness D	Bolt Holes E		Bolt Circle Diameter F	300# Bolt Info.	
					No.	Size		Bolt Size	Nut Thk
1"	4 7/8"	1/8"	1 1/16"	1 1/16"	4	3/4"	3 1/2"	5/8" - 11	.625
1 1/2"	6 1/8"	2 3/4"	13/16"	1 3/16"	4	7/8"	4 1/2"	3/4" - 10	.750
2"	6 1/2"	3 5/16"	7/8"	1 5/16"	8	3/4"	5"	5/8" - 11	.625
3"	8 1/4"	4 5/8"	1 1/8"	1 11/16"	8	7/8"	6 5/8"	3/4" - 10	.750
4"	10"	5 3/4"	1 1/4"	1 7/8"	8	7/8"	7 7/8"	3/4" - 10	.750
6"	12 1/2"	8 1/8"	1 7/16"	2 1/16"	12	7/8"	10 5/8"	3/4" - 10	.750
8"	15"	10 1/4"	1 5/8"	2 7/16"	12	1"	13"	7/8" - 9	.875
10"	17 1/2"	-	-	-	16	1 1/8"	15 1/4"	1" - 8	1"
12"	20 1/2"	-	-	-	16	1 1/4"	17 3/4"	1 1/8" - 7	1.125

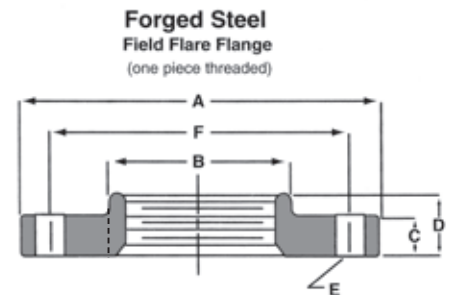

Dimensions for rotating flanges. Consult factory for other styles.

## Elbows 45°

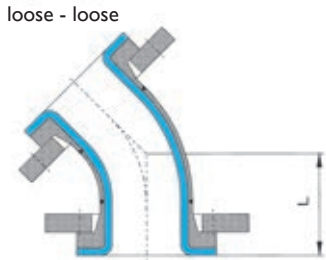
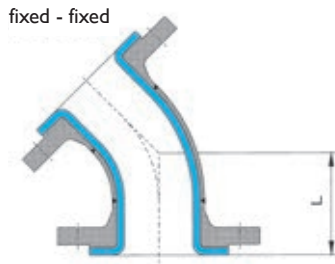

NPS	Class 150		Class 300		Lining material		
	L <sub>inch</sub>	L <sub>mm</sub>	L <sub>inch</sub>	L <sub>mm</sub>	PTFE	PVDF	PP
1/2"	---	---	---	---	●		
3/4"	---	---	---	---	●		●
1"	1.75	45	2.25	57	●	●	●
1 1/4"	2.00	51	2.50	64	●	●	●
1 1/2"	2.25	57	2.75	70	●	●	●
2"	2.50	64	3.00	76	●	●	●
2 1/2"	3.00	76	3.50	89	●	●	●
3"	3.00	76	3.50	89	●	●	●
4"	4.00	102	4.50	114	●	●	●
5"	4.50	114	5.00	127	●	●	●
6"	5.00	127	5.50	140	●	●	●
8"	5.50	140	6.00	152	●	●	●
10"	6.50	165	7.00	178	●	●	●
12"	7.50	191	8.00	203	●	●	●
14"	7.50	191	8.50	216	●	●	●
16"	8.00	203	9.50	241	●	●	●
18"	8.50	216	10.00	254	●	●	●
20"	9.50	241	10.50	267	●	●	●

The nominal pipe sizes 1/2" and 3/4" are not defined in the ASME B16.5. Please consult factory.

## Elbows 90°

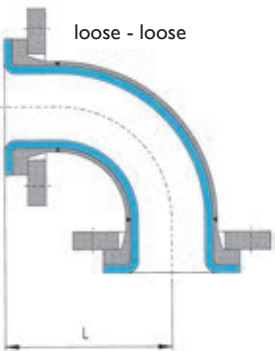
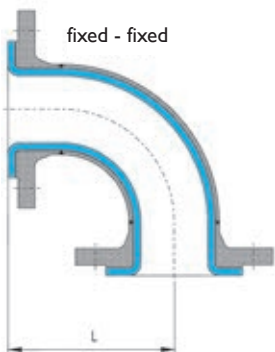

NPS	Class 150			Class 300			Form	Lining materials		
	L <sub>inch</sub>	L <sub>mm</sub>	Radius	L <sub>inch</sub>	L <sub>mm</sub>	Radius		PTFE	PVDF	PP
1/2"	---	---	LR	---	---	LR	---	●		
3/4"	---	---	LR	---	---	LR	---	●	●	●
1"	3.50	89	LR	4.00	102	LR	one-piece	●	●	●
1 1/4"	3.75	95	LR	4.25	108	LR	one-piece	●	●	●
1 1/2"	4.00	102	LR	4.50	114	LR	one-piece	●	●	●
2"	4.50	114	LR	5.00	127	LR	one-piece	●	●	●
2 1/2"	5.00	127	LR	5.50	140	LR	one-piece	●	●	●
3"	5.50	140	LR	6.00	152	LR	one-piece	●	●	●
4"	6.50	165	LR	7.00	178	LR	one-piece	●	●	●
5"	7.50	191	SR	8.00	203	SR	one-piece	●	●	●
6"	8.00	203	SR	8.50	216	SR	one-piece	●	●	●
8"	9.00	229	SR	10.00	254	SR	one-piece	●	●	●
10"	11.00	279	SR	11.00	279	SR	one-piece	●	●	●
10"	16.50	419	LR	16.50	419	LR	one-piece	●	●	●
12"	12.00	305	SR	12.00	305	SR	one-piece	●	●	●
12"	19.00	483	LR	19.00	483	LR	one-piece	●		●
14"	21.50	546	LR	21.50	546	LR	multi-part	●		●
16"	24.00	610	LR	24.00	610	LR	multi-part	●		●
18"	26.50	673	LR	26.50	673	LR	multi-part	●		●
20"	29.00	737	LR	29.00	737	LR	multi-part	●		●

## 45° Lateral

Size	B		C		Lining Material
	150#	300#	150#	300#	
1"	5¾"	6½"	1¾"	2"	PFA/PP/PVDF
1½"	7"	8½"	2"	2½"	PFA/PP/PVDF
2"	8"	9"	2½"	2½"	PFA/PP/PVDF
3"	10"	11"	3"	3"	PFA/PP/PVDF
4"	12"	13½"	3"	3"	PFA/PP/PVDF
6"	14½"	17½"	3½"	4"	PTFE /PP/PVDF

Larger sizes available in PP & PVDF and ETFE.

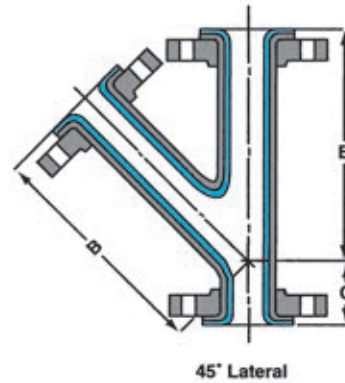

45° Lateral

## Short Stack Cross

Size	A	B
1"	3½"	1¼"
1½"	4"	1½"
2"	4½"	1¾"
3"	5½"	2¼"
4"	6½"	2¾"
6"	8"	3¾"
8"	9"	5"
10"	11"	6"
12"	12"	7"

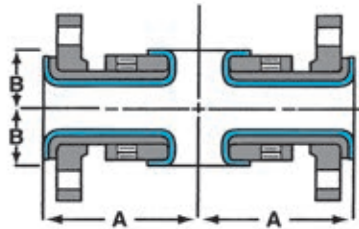

Short Stack Cross

## Short Stack Tee

Size	A	B
1"	3½"	1¼"
1½"	4"	1½"
2"	4½"	1¾"
3"	5½"	2¾"
4"	6½"	2¾"
6"	8"	3¾"
8"	9"	5"
10"	11"	6"
12"	12"	7"

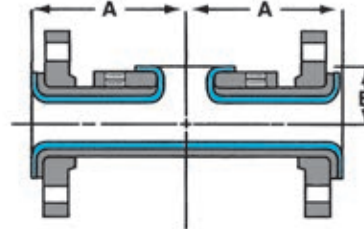

Short Stack Tee  
(tapped holes straddle C<sub>1</sub>)

## Strainer Tee

Size	A	Lining Material
1"	3½"	PFA/PP/PVDF
1½"	4"	PFA/PP/PVDF
2"	4½"	PFA/PP/PVDF
3"	5½"	PFA/PP/PVDF
4"	6½"	PFA/PP/PVDF
6"	8"	PTFE/PP/PVDF
8"	9"	PTFE/PP/PVDF

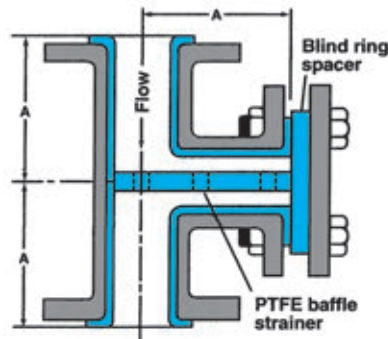

Strainer Tee

# Tees

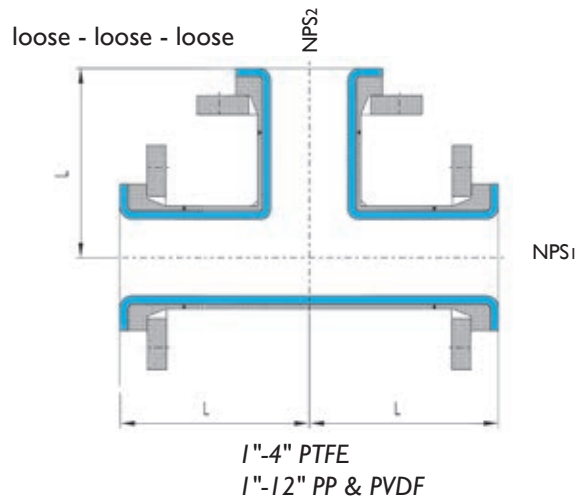

NPS <sub>1</sub>	NPS <sub>2</sub>	Class 150		Class 300		Lining materials		
		L <sub>inch</sub>	L <sub>mm</sub>	L <sub>inch</sub>	L <sub>mm</sub>	PFA	PP	PVDF
1/2"	1/2"	3.00	---	---	---	●		
3/4"	3/4"	3.00	---	---	---	●		
3/4"	1/2"	3.00	---	---	---	●		
1"	1"	3.50	89	4.00	102	●	●	●
1"	3/4"	3.50	89	4.00	102	●		
1"	1/2"	3.50	89	4.00	102	●		
1 1/4"	1 1/4"	3.75	95	4.25	108	●	●	●
1 1/4"	1"	3.75	95	4.25	108	●	●	●
1 1/4"	3/4"	3.75	95	4.25	108	●		
1 1/4"	1/2"	3.75	95	4.25	108	●		
1 1/2"	1 1/2"	4.00	102	4.50	114	●	●	●
1 1/2"	1 1/4"	4.00	102	4.50	114	●	●	●
1 1/2"	1"	4.00	102	4.50	114	●	●	●
1 1/2"	3/4"	4.00	102	4.50	114	●	●	●
2"	2"	4.50	114	5.00	127	●	●	●
2"	1 1/2"	4.50	114	5.00	127	●	●	●
2"	1 1/4"	4.50	114	5.00	127	●	●	●
2"	1"	4.50	114	5.00	127	●	●	●
2 1/2"	2 1/2"	5.00	127	5.50	140	●	●	●
2 1/2"	2"	5.00	127	5.50	140	●	●	●
2 1/2"	1 1/2"	5.00	127	5.50	140	●	●	●
2 1/2"	1 1/4"	5.00	127	5.50	140	●	●	●
2 1/2"	1"	5.00	127	5.50	140	●	●	●
3"	3"	5.50	140	6.00	152	●	●	●
3"	2 1/2"	5.50	140	6.00	152	●	●	●
3"	2"	5.50	140	6.00	152	●	●	●
3"	1 1/2"	5.50	140	6.00	152	●	●	●
3"	1"	5.50	140	6.00	152	●	●	●
4"	4"	6.50	165	7.00	178	●	●	●
4"	3"	6.50	165	7.00	178	●	●	●
4"	2 1/2"	6.50	165	7.00	178	●	●	●
4"	2"	6.50	165	7.00	178	●	●	●
4"	1"	6.50	165	7.00	178	●	●	●

The nominal pipe sizes 1/2" and 3/4" are not defined in the ASME B16.5.  
Please determine the desired length when contacting our sales force.

# Tees

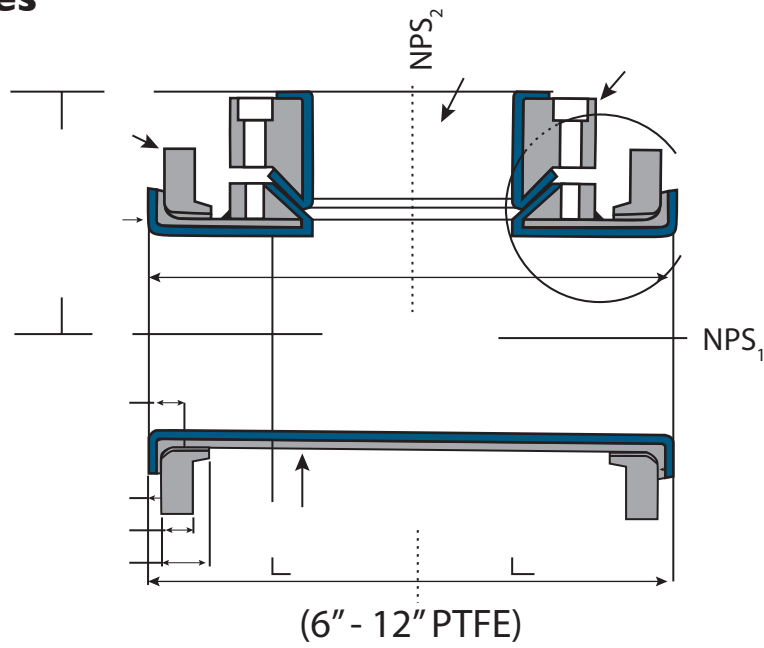

NPS <sub>1</sub>	NPS <sub>2</sub>	Class 150		Class 300		Lining materials			
		L <sub>inch</sub>	L <sub>mm</sub>	L <sub>inch</sub>	L <sub>mm</sub>	PTFE	PFA	PP	PVDF
5"	5"	7.50	190	8.00	203	*	●		
5"	4"	7.50	190	8.00	203	*			
5"	3"	7.50	190	8.00	203	*			
5"	2"	7.50	190	8.00	203	*			
6"	6"	8.00	203	8.50	216	*		●	●
6"	5"	8.00	203	8.50	216	*		●	●
6"	4"	8.00	203	8.50	216	*		●	●
6"	3"	8.00	203	8.50	216	*		●	●
8"	8"	9.00	229	10.00	254	F		●	●
8"	6"	9.00	229	10.00	254	*		●	●
8"	5"	9.00	229	10.00	254	*		●	●
8"	4"	9.00	229	10.00	254	*		●	●
10"	10"	11.00	280	11.50	292	*		●	●
10"	8"	11.00	279	11.50	292	*		●	●
10"	6"	11.00	279	11.50	292	*		●	●
10"	5"	11.00	279	11.50	292	*		●	●
12"	12"	12.00	305	13.00	330	F		●	●
12"	10"	12.00	305	13.00	330	*		●	●
12"	8"	12.00	305	13.00	330	*		●	●
12"	6"	12.00	305	13.00	330	*		●	●

● RxRxR (All flanges rotating)

\* RxRxR (Branch flange fixed)

F - FxFxF (All flanges fixed)

Two piece tees are standard in PTFE 6"-12".

One piece tees are available in PTFE as special order from factory 6" & 8".

Reducing tees available in all reductions. Consult factory.

PP, PVDF, PFA, ETFE Tees are one piece construction.

# Crosses

fixed - fixed - fixed - fixed  $NPS_2$

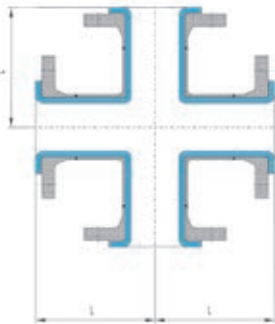

loose - loose - loose - loose  $NPS_2$

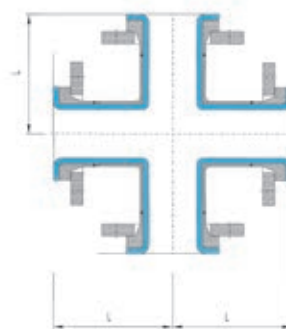

$NPS_1$	$NPS_2$	Class 150		Class 300		Lining materials			
		$L_{inch}$	$L_{mm}$	$L_{inch}$	$L_{mm}$	PTFE	PFA	PP	PVDF
1/2"	1/2"	---	---	---	---		●		
3/4"	3/4"	---	---	---	---		●		
3/4"	1/2"	---	---	---	---		●		
1"	1"	3.50	89	4.00	102		●	●	●
1"	3/4"	3.50	89	4.00	102		●		
1"	1/2"	3.50	89	4.00	102		●		
1 1/4"	1 1/4"	3.75	95	4.25	108		●	●	●
1 1/4"	1"	3.75	95	4.25	108		●	●	●
1 1/4"	3/4"	3.75	95	4.25	108		●	●	●
1 1/4"	1/2"	3.75	95	4.25	108		●		
1 1/2"	1 1/2"	4.00	102	4.50	114		●	●	●
1 1/2"	1 1/4"	4.00	102	4.50	114		●	●	●
1 1/2"	1"	4.00	102	4.50	114		●	●	●
1 1/2"	3/4"	4.00	102	4.50	114		●	●	●
2"	2"	4.50	114	5.00	127		●	●	●
2"	1 1/2"	4.50	114	5.00	127		●	●	●
2"	1 1/4"	4.50	114	5.00	127		●	●	●
2"	1"	4.50	114	5.00	127		●	●	●
2 1/2"	2 1/2"	5.00	127	5.50	140		●	●	●
2 1/2"	2"	5.00	127	5.50	140		●	●	●
2 1/2"	1 1/2"	5.00	127	5.50	140		●	●	●
2 1/2"	1 1/4"	5.00	127	5.50	140		●	●	●
2 1/2"	1"	5.00	127	5.50	140		●	●	●
3"	3"	5.50	140	6.00	152		●	●	●
3"	2 1/2"	5.50	140	6.00	152		●	●	●
3"	2"	5.50	140	6.00	152		●	●	●
3"	1 1/2"	5.50	140	6.00	152		●	●	●
3"	1"	5.50	140	6.00	152		●	●	●
4"	4"	6.50	165	7.00	178		●	●	●
4"	3"	6.50	165	7.00	178		●	●	●
4"	2 1/2"	6.50	165	7.00	178		●	●	●
4"	2"	6.50	165	7.00	178		●	●	●
4"	1"	6.50	165	7.00	178		●	●	●

The nominal pipe sizes 1/2" and 3/4" are not defined in the ASME B16.5.

Please determine the desired length when contacting our sales force.

Larger sizes are available upon request.





# Instrument Tee

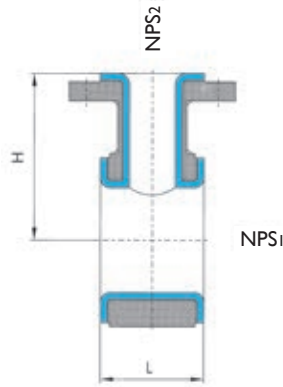

NPS <sub>1</sub>	NPS <sub>2</sub>	Class 150				Class 300				Lining materials		
		L <sub>inch</sub>	H <sub>inch</sub>	L <sub>mm</sub>	H <sub>mm</sub>	L <sub>inch</sub>	H <sub>inch</sub>	L <sub>mm</sub>	H <sub>mm</sub>	PVDF	PFA	PP
1"	1"	1.97	3.54	50	90	1.97	4.33	50	110	●	●	●
1½"	1½"	2.95	4.33	75	110	2.95	---	75	---	●	●	●
1½"	1"	1.97	4.33	50	110	1.97	---	50	---	●	●	●
2"	2"	3.54	4.53	90	115	3.54	5.12	90	130	●	●	●
2"	1½"	2.95	4.53	75	115	2.95	5.12	75	130	●	●	●
2"	1"	1.97	4.53	50	115	1.97	5.12	50	130	●	●	●
3"	2"	3.54	5.31	90	135	3.54	6.30	90	160	●	●	●
3"	1½"	2.95	5.31	75	135	1.97	6.30	50	160	●	●	●
3"	1"	1.97	5.31	50	135	1.97	6.30	50	160	●	●	●
4"	2"	3.54	5.91	90	150	3.54	6.69	90	170	●	●	●
4"	1½"	2.95	5.91	75	150	2.95	6.69	75	170	●	●	●
4"	1"	1.97	5.91	50	150	1.97	6.69	50	170	●	●	●
6"	2"	3.54	7.09	90	180	3.54	8.07	90	205	●	●	●
6"	1½"	2.95	7.09	75	180	2.95	8.07	75	205	●	●	●
6"	1"	1.97	7.09	50	180	1.97	8.07	50	205	●	●	●
8"	2"	3.54	8.27	90	210	3.54	9.45	90	240	●	●	●
8"	1½"	2.95	8.27	75	210	2.95	9.45	75	240	●	●	●
8"	1"	1.97	8.27	50	210	1.97	9.45	50	240	●	●	●
10"	2"	3.54	9.45	90	240	3.54	12.80	90	325	●	●	●
10"	1½"	2.95	9.45	75	240	2.95	12.80	75	325	●	●	●
10"	1"	1.97	9.45	50	240	1.97	12.80	50	325	●	●	●
12"	2"	3.54	11.81	90	300					●	●	●
12"	1½"	2.95	11.81	75	300					●	●	●
12"	1"	1.97	11.81	50	300					●	●	●

The dimensions of instrument tees are not defined in the ASME B16.5.

# Reducing Filler Flanges (tapered bore)

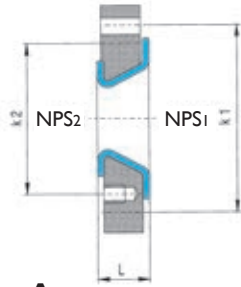

## Form A

NPS<sub>1</sub> through holes  
NPS<sub>2</sub> threaded holes  
Both sets straddle C<sub>L</sub>

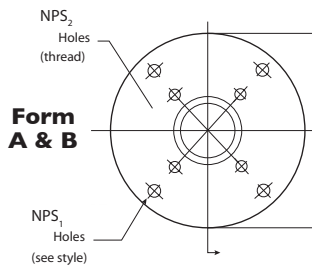

## Form A & B

### Form B

NPS<sub>1</sub> threaded holes  
NPS<sub>2</sub> threaded holes  
Both sets straddle C<sub>L</sub>

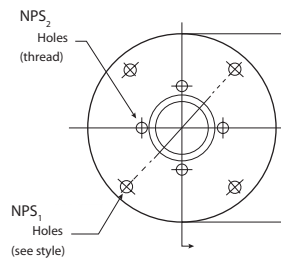

## Form C

NPS<sub>1</sub> threaded holes straddle C<sub>L</sub>  
NPS<sub>2</sub> threaded holes on center line  
One set straddles C<sub>L</sub>

NPS <sub>1</sub>	NPS <sub>2</sub>	Class 150			Lining materials		
		L <sub>inch</sub>	L <sub>mm</sub>	Form	PTFE	PFA	HOLE ROTATION
3/4"	1/2"	1.38	35	C	●		45°
1"	3/4"	1.38	35	C	●		45°
1"	1/2"	1.38	35	C	●		45°
1 1/2"	1"	1.38	35	C	●		45°
2"	1 1/2"	1.38	35	C	●		45°
2"	1"	1.38	35	B	●		none
2 1/2"	2"	1.38	35	C	●		45°
2 1/2"	1 1/2"	1.38	35	C	●		45°
2 1/2"	1"	1.38	35	B		●	none
3"	2 1/2"	1.38	35	B	●		45°
3"	2"	1.38	35	B	●		45°
3"	1 1/2"	1.38	35	B		●	none
3"	1"	1.38	35	A		●	none
4"	3"	1.77	45	C	●		none
4"	2 1/2"	1.77	45	B	●		none
4"	2"	1.77	45	B	●		none
4"	1 1/2"	1.77	45	A		●	none
4"	1"	1.77	45	A		●	none
6"	4"	1.77	45	B	●		none
6"	3"	1.77	45	A		●	none
6"	2 1/2"	1.77	45	A		●	none
6"	2"	1.77	45	A		●	none
6"	1 1/2"	1.77	45	A		●	none
6"	1"	1.77	45	A		●	none

Concentric reducing flanges Class 300 and eccentric reducing flanges upon request.  
PP & PVDF reducing flanges are also available in straight bore and two level designs.

# Reducing Flanges (Two Level Steel) (Tapered Bore) PP, PVDF, PTFE Lined

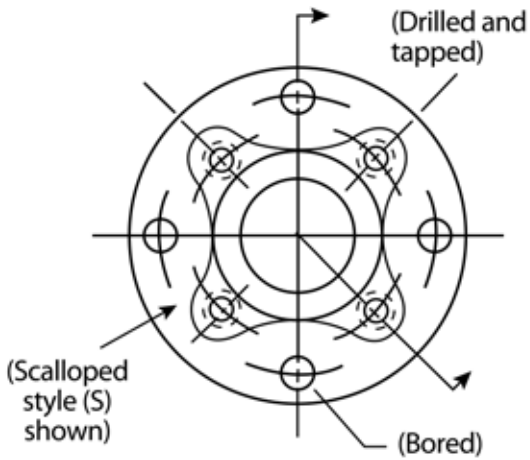
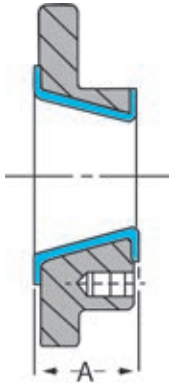

Part #	Size	A ( $\pm 1/8$ )	Bolt Orientation (Sets Straddling $C_L$ )	Design	Liner
I10905	1 x 1/2	1.375	1		PTFE Only
I10975	1 x 3/4	1.375	1		PTFE Only
I15910	1 1/2 x 1	1.625	1	S	All
I20910	2 x 1	1.625	1	S	All
I20915	2 x 1 1/2	1.625	1	S	All
I30910	3 x 1	1.625	1	S	All x PTFE
I30915	3 x 1 1/2	1.625	1	S	All x PTFE
I30920	3 x 2	1.625	1	S	All
I40910	4 x 1	1.75	2		All x PTFE
I40915	4 x 1 1/2	1.75	2		All x PTFE
I40920	4 x 2	1.75	2		All
I40930	4 x 3	1.75	2	S	All
I60910	6 x 1	1.875	2		All x PTFE
I60915	6 x 1 1/2	1.875	2		All x PTFE
I60920	6 x 2	1.875	2		All
I60930	6 x 3	1.875	2		All
I60940	6 x 4	1.875	1	S	All
I80910	8 x 1	2.125	2		All x PTFE
I80915	8 x 1 1/2	2.125	2		All x PTFE
I80920	8 x 2	2.125	2		All
I80930	8 x 3	2.125	2		All
I80940	8 x 4	2.125	1		All
I80960	8 x 6	2.125	1	S	All
I85940	10 x 4	2.25	2		All
I85960	10 x 6	2.25	2		All
I85980	10 x 8	2.25	2	S	All
I90940	12 x 4	2.375	2		All
I90960	12 x 6	2.375	2		All
I90980	12 x 8	2.375	2		All
I98985	12 x 10	2.375	2	S	All

\*1 - One set bolt holes straddle  $C_L$   
 \*2 - Both sets bolt holes straddle  $C_L$   
 S - Scalloped design

# Reducers Concentric

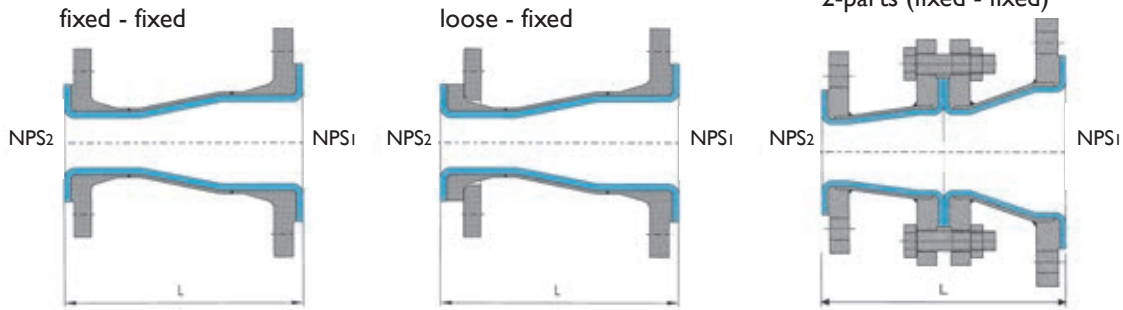

NPS <sub>1</sub>	NPS <sub>2</sub>	Class 150 / Class 300			Lining materials			
		L <sub>inch</sub>	L <sub>mm</sub>	Form	PTFE	PFA	PP	PVDF
3/4"	1/2"	4.49	114		●			
1"	1/2"	4.49	114		●		●	●
1 1/4"	1"	4.49	114		●		●	●
1 1/4"	3/4"	4.49	114		●		●	●
1 1/2"	1 1/4"	4.49	114		●		●	●
1 1/2"	1"	4.49	114			●	●	●
1 1/2"	3/4"	4.49	114			●	●	●
2"	1 1/2"	5.00	127		●		●	●
2"	1 1/4"	5.00	127		●		●	●
2"	1"	5.00	127			●	●	●
2 1/2"	2"	5.51	140		●		●	●
2 1/2"	1 1/2"	5.51	140		●		●	●
2 1/2"	1 1/4"	5.51	140			●	●	●
3"	2 1/2"	5.98	152		●		●	●
3"	2"	5.98	152		●		●	●
3"	1 1/2"	5.98	152			●	●	●
3"	1"	5.98	152			●	●	●
4"	3"	7.01	178		●		●	●
4"	2 1/2"	7.01	178		●		●	●
4"	2"	7.01	178			●	●	●
5"	4"	7.99	203		●		●	●
5"	3"	7.99	203			●	●	●
5"	2 1/2"	7.99	203			●	●	●
6"	5"	9.02	229		●		●	●
6"	4"	9.02	229		●		●	●
6"	3"	9.02	229	2-parts	●		●	●
8"	6"	10.98	279		●		●	●
8"	5"	10.98	279	2-parts	●		●	●
8"	4"	10.98	279	2-parts	●		●	●
10"	8"	12.01	305		●		●	●
10"	6"	12.01	305	2-parts	●		●	●
10"	5"	12.01	305	2-parts	●		●	●
12"	10"	14.02	356		●		●	●
12"	8"	14.02	356	2-parts	●		●	●
12"	6"	14.02	356	2-parts	●		●	●
14"	12"	15.98	406		●		●	●
14"	10"	15.98	406	2-parts	●		●	●
14"	8"	15.98	406	2-parts	●		●	●
16"	14"	17.99	457		●		●	●
16"	12"	17.99	457	2-parts	●		●	●
16"	10"	17.99	457	2-parts	●		●	●
20"	16"	20.00	508		●			
20"	14"	20.00	508	2-parts	●			
20"	12"	20.00	508	2-parts	●			

The nominal pipe sizes 1/2" and 3/4" are not defined in the ASME B16.5. Please determine the desired length when contacting our sales force. PP & PVDF are one piece construction.

(304) 755-2571

# Reducers Eccentric

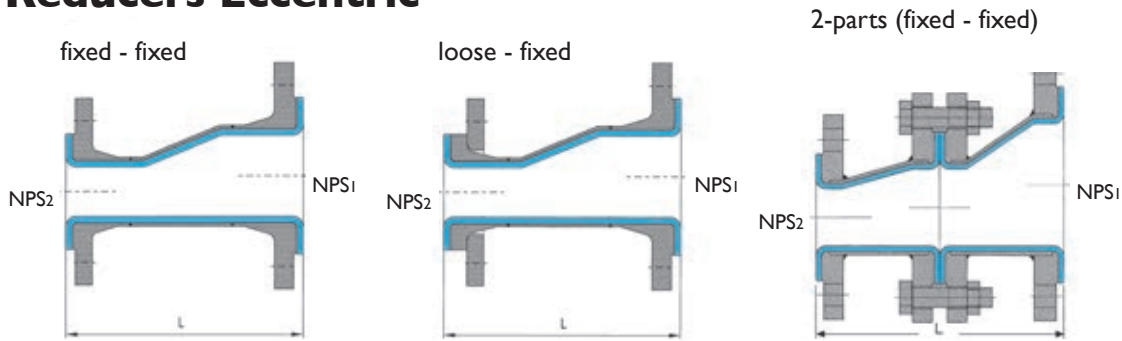

NPS <sub>1</sub>	NPS <sub>2</sub>	Class 150/300			Lining materials			
		L <sub>inch</sub>	L <sub>mm</sub>	Form	PTFE	PFA	PP	PVDF
3/4"	1/2"	4.49	114					
1"	1/2"	4.49	114		●			
1 1/4"	1"	4.49	114		●		●	●
1 1/4"	3/4"	4.49	114		●		●	●
1 1/2"	1 1/4"	4.49	114		●		●	●
1 1/2"	1"	4.49	114		●	●	●	●
1 1/2"	3/4"	4.49	114					
2"	1 1/2"	5.00	127		●		●	●
2"	1 1/4"	5.00	127		●	●	●	●
2"	1"	5.00	127				●	●
2 1/2"	2"	5.51	140		●		●	●
2 1/2"	1 1/2"	5.51	140		●	●	●	●
2 1/2"	1 1/4"	5.51	140				●	●
3"	2 1/2"	5.98	152		●		●	●
3"	2"	5.98	152		●	●	●	●
3"	1 1/2"	5.98	152			●	●	●
3"	1"	5.98	152				●	●
4"	3"	7.01	178		●		●	●
4"	2 1/2"	7.01	178		●	●	●	●
4"	2"	7.01	178				●	●
5"	4"	7.99	203		●		●	●
5"	3"	7.99	203	2-parts	●		●	●
5"	2 1/2"	7.99	203	2-parts	●		●	●
6"	5"	9.02	229		●		●	●
6"	4"	9.02	229	2-parts	●		●	●
6"	3"	9.02	229	2-parts	●		●	●
8"	6"	10.98	279		●		●	●
8"	5"	10.98	279	2-parts	●		●	●
8"	4"	10.98	279	2-parts	●		●	●
10"	8"	12.01	305		●		●	●
10"	6"	12.01	305	2-parts	●		●	●
10"	5"	12.01	305	2-parts	●		●	●
12"	10"	14.02	356		●		●	●
12"	8"	14.02	356	2-parts	●		●	●
12"	6"	14.02	356	2-parts	●		●	●
14"	12"	15.98	406		●		●	●
14"	10"	15.98	406	2-parts	●		●	●
14"	8"	15.98	406	2-parts	●		●	●
16"	14"	17.99	457		●		●	●
16"	12"	17.99	457	2-parts	●		●	●
16"	10"	17.99	457	2-parts	●		●	●
20"	16"	20.00	508		●			
20"	14"	20.00	508	2-parts	●			
20"	12"	20.00	508	2-parts	●			

The nominal pipe sizes 1/2" and 3/4" are not defined in the ASME B16.5.  
PP & PVDF are one piece construction.

(304) 755-2571

# PTFE Chemical Transfer Hose-Smooth Bore With Annular Corrugating and Wire Braid (Class 150)

Nominal I.D.	Working Pressure (psi)		Min. Bend Radius	Vacuum (in. hg.)		PTFE Thickness	Min. Length for 3/4" Offset	Flange Thickness
	@ 70° F	@ 350° F		@ 70° F	@ 350° F			
1"	275	195	12	FV	FV	.130	15	5/8"
1 1/2"	275	195	15	FV	FV	.150	21	5/8"
2"	275	195	21	FV	FV	.160	25	5/8"
3"	275	195	28	FV	FV	.160	35	5/8"
4"	230	195	46	FV	FV	.160	41	5/8"
6"	230	195	65	22	17	.275	72	3/4"
8"	185	160	89	20	17	.220	96	7/8"

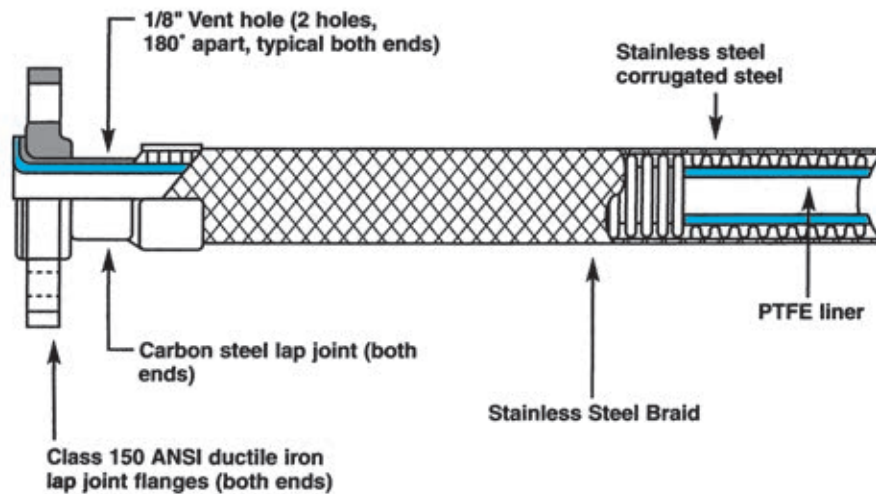

## Jacketed Pipe & Fittings

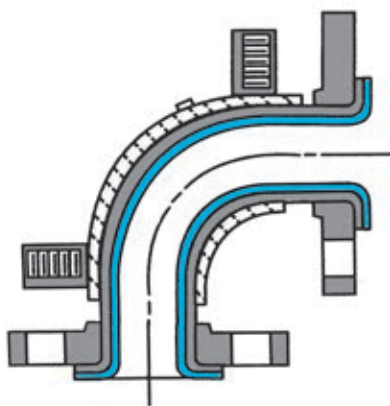

Ideal for circulating hot or cold liquid to control process conditions. Both inside and outside pipes are schedule 40 steel. Flanges are standard lap joint style as pictured below. Jacket can be extended to the flange, if required.

Carrier Size	Jacket OD (A)
1"	2 3/8"
1 1/2"	3 1/2"
2"	4 1/2"
3"	5 9/16"
4"	6 5/8"
6"	8 5/8"
8"	10 3/4"

Standard fitting geometries are also available in jacketed style. Consult factory.

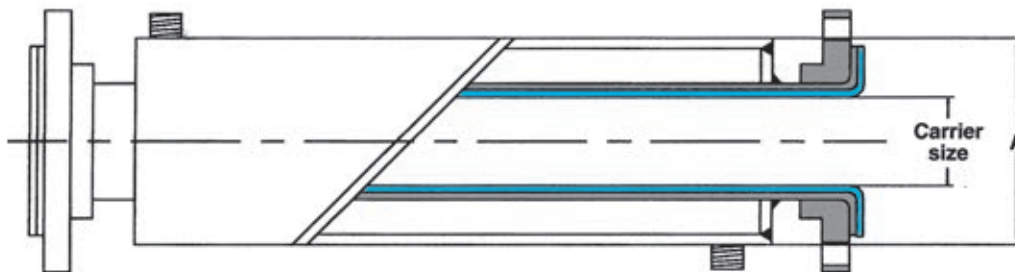

# PTFE-Expansion Joints, 2 Convolute (Class 150)

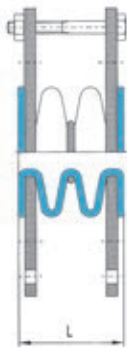

NPS 1/2" - 4"  
NPS 5" - 6"

NPS 8" - 10"  
NPS 12" - 20"

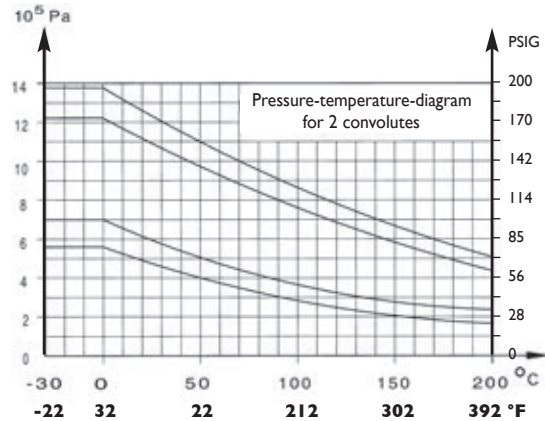

NPS	L		Extension Compr. +/-		Misalignment Max.		Angular Deflection Max. Deg.	Inch HG	Vacuum-Resistance				
	mm	in.	mm	in.	mm	in.			Max °C	Max °F	Inch HG	Max °C	Max °F
1/2"	28	1.10	4	0.16	2	0.08	7	FV	200	392			
3/4"	28	1.10	4	0.16	2	0.08	7	FV	200	392			
1"	35	1.38	6	0.24	3	0.12	7	FV	200	392			
1 1/4"	35	1.38	6	0.24	3	0.12	7	FV	200	392			
1 1/2"	35	1.38	6	0.24	3	0.12	7	FV	200	392			
2"	40	1.57	6	0.24	3	0.12	7	FV	200	392			
2 1/2"	57	2.24	9	0.35	5	0.20	7	FV	200	392			
3"	57	2.24	9	0.35	5	0.20	7	FV	200	392			
4"	67	2.64	13	0.51	6	0.24	7	FV	200	392			
5"	83	3.27	13	0.51	6	0.24	7	FV	150	302			
6"	75	2.95	13	0.51	6	0.24	7	FV	150	302			
8"	102	4.02	13	0.51	6	0.24	7	FV	50	122	23	150	302
10"	140	5.51	15	0.59	6	0.24	7	27	45	113	19	100	212
12"	150	5.91	20	0.79	10	0.39	7	25	45	113	10	100	212
14"	160	6.30	20	0.79	10	0.39	7	25	45	113	10	100	212
16"	178	7.01	25	0.98	10	0.39	7	25	45	113	10	100	212
18"	185	7.28	25	0.98	10	0.39	7	20	45	113	9	100	212
20"	230	9.06	25	0.98	10	0.39	7	6	100	212	4	100	212

The above shown chart is only valid at neutral length and with limit bolts in place.  
Above mentioned types of travel (extension compression, misalignment or angular deflection) are alternatives.  
The percentage values must not exceed 100% when added together.  
The figures stated are average values and apply to room temperature.

Important regarding the holes of the expansion joint flanges:  
Bolt circle: with threaded holes from 1/2" to 24"  
Other design: upon request  
PTFE-Expansion Joints, 2 Convolute (Class 300) upon request.

**BAUM recommends the use of spray shields on all installations particularly when hot, hazardous or corrosive materials are present. Spray shields prevent radial spray of fluids or hot gases in the event of flange connection leakage or failure of the expansion joint.**

# PTFE-Expansion Joints, 3 Convolute (Class I50)

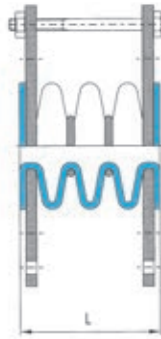

NPS ½"- 4"  
NPS 5"- 6"

NPS 8"-20"

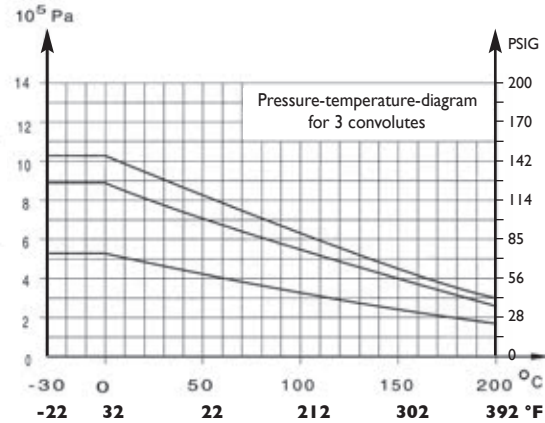

NPS	L		Extension Compr. +/-		Misalignment Max.		Angular Deflection Max. Deg.	Inch HG	Vacuum-Resistance				
	mm	in.	mm	in.	mm	in.			Max °C	Max °F	Inch HG	Max °C	Max °F
½"	37	1.46	6	0.24	4	0.16	14	FV	200	392			
¾"	37	1.46	6	0.24	4	0.16	14	FV	200	392			
1"	46	1.81	13	0.51	6	0.24	14	FV	200	392			
1¼"	46	1.81	13	0.51	6	0.24	14	FV	200	392			
1½"	46	1.81	13	0.51	6	0.24	14	FV	200	392			
2"	56	2.20	15	0.51	9	0.35	14	FV	200	392			
2½"	77	3.03	19	0.59	9	0.35	14	FV	200	392			
3"	77	3.03	25	0.75	13	0.51	14	FV	200	392			
4"	91	3.58	25	0.98	13	0.51	14	FV	200	392			
5"	111	4.37	25	0.98	14	0.55	14	FV	150	302			
6"	101	3.98	28	0.98	14	0.55	14	FV	150	302			
8"	137	5.39	28	1.10	14	0.55	14	FV	50	122	23	150	302
10"	200	7.87	30	1.18	14	0.55	14	27	45	113	19	100	212
12"	196	7.72	30	1.18	15	0.59	14	25	45	113	10	100	212
14"	215	8.46	32	1.26	18	0.71	14	25	45	113	10	100	212
16"	233	9.17	35	1.38	20	0.79	14	25	45	113	10	100	212
18"	280	11.02	30	1.18	20	0.79	14	19	45	113	9	100	212
20"	327	12.87	30	1.18	25	0.98	14	NR			6	100	212

The above shown chart is only valid at neutral length and with limit bolts in place.

Above mentioned types of travel (extension compression, misalignment or angular deflection) are alternatives. The percentage values must not exceed 100% when added together.

The figures stated are average values and apply to room temperature.

Important regarding the holes of the expansion joint flanges:

Bolt circle: with threaded holes from ½" to 24"

Other design: upon request

PTFE-Expansion Joints, 3 Convolute (Class 300) upon request.

**BAUM recommends the use of spray shields on all installations particularly when hot, hazardous or corrosive materials are present. Spray shields prevent radial spray of fluids or hot gases in the event of flange connection leakage or failure of the expansion joint.**



# PTFE-Expansion Joints, 5 Convolute (Class 150)

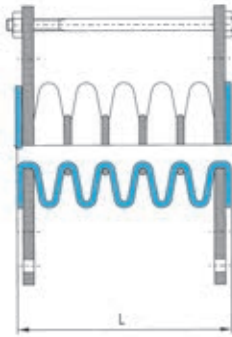

NPS ½" - 20"

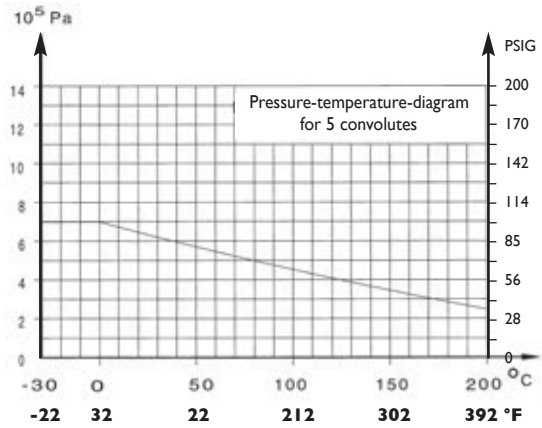

NPS	L		Extension Compr. +/-		Misalignment Max.		Angular Deflection Max. Deg.	Vacuum-Resistance
	mm	in.	mm	in.	mm	in.		
½"	55	2.17	8	0.31	5	0.20	20	<i>not recommended</i>
¾"	55	2.17	8	0.31	5	0.20	20	
1"	68	2.68	8	0.31	12	0.47	20	
1¼"	68	2.68	8	0.31	12	0.47	20	
1½"	80	3.15	13	0.51	12	0.47	20	
2"	88	3.46	19	0.75	12	0.47	20	
2½"	113	4.45	25	0.98	13	0.51	20	
3"	113	4.45	25	0.98	16	0.63	20	
4"	139	5.47	25	0.98	16	0.63	20	
5"	167	6.57	32	1.26	16	0.63	20	
6"	153	6.02	32	1.26	16	0.63	20	
8"	207	8.15	32	1.26	16	0.63	20	
10"	300	11.81	32	1.26	16	0.63	20	
12"	288	11.34	35	1.38	18	0.71	20	
14"	325	12.80	35	1.38	18	0.71	20	
16"	343	13.50	40	1.57	25	0.98	20	
18"	470	18.50	40	1.57	25	0.98	20	
20"	520	20.47	40	1.57	25	0.98	20	

The above movements are only valid at neutral length and with limit bolts in place.  
 Above mentioned types of travel (extension compression, misalignment or angular deflection) are alternatives.  
 The percentage values must not exceed 100% when added together.  
 The figures stated are average values and apply to room temperature.

Important regarding the holes of the expansion joint flanges:  
 Bolt circle: with threaded holes from ½" to 24"  
 Other design: upon request  
 PTFE-Expansion Joints, 5 Convolute (Class 300) upon request.

Special numbers of convolutions are also available, please consult factory for information.

**BAUM recommends the use of spray shields on all installations particularly when hot, hazardous or corrosive materials are present. Spray shields prevent radial spray of fluids or hot gases in the event of flange connection leakage or failure of the expansion joint.**

## PTFE-Lined Stainless Steel Expansion Joint (Class 150)

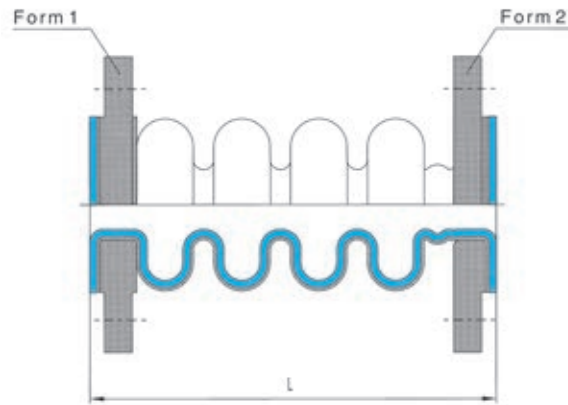

NPS	L mm	Extension Compr. ± mm	Spring rate N/mm	Vacuum-Resistance 10 <sup>5</sup> Pa at	
				23 °C	160 °C
1 1/4"	144	9	260	0.15	0.30
1 1/4"	218	18	130	0.15	0.30
1 1/2"	156	11	272	0.15	0.30
1 1/2"	240	22	136	0.15	0.30
2"	178	13	276	0.15	0.30
2"	291	27	195	0.15	0.30
2 1/2"	179	17	234	0.15	0.30
2 1/2"	282	32	173	0.15	0.30
3"	183	20	220	0.15	0.30
3"	271	35	178	0.15	0.30
4"	175	20	365	0.15	0.30
4"	259	40	183	0.15	0.30
5"	216	29	290	0.25	0.40
5"	353	50	290	0.25	0.40
6"	243	30	560	0.25	0.40
6"	378	60	280	0.25	0.40
8"	241	42	412	0.35	0.50
8"	408	78	335	0.35	0.50
10"	237	44	525	0.40	0.60
10"	381	81	269	0.40	0.60
12"	280	55	480	0.50	0.75
12"	416	95	352	0.50	0.75
14"	289	60	460	0.50	0.75
14"	396	92	378	0.50	0.75
16"	283	52	713	0.70	0.90
16"	421	104	357	0.70	0.90
18"	320	70	548	0.70	0.90
18"	517	130	430	0.70	0.90
20"	303	56	955	<b>not recommended</b>	
20"	493	126	425		
24"	324	70	548		
24"	464	126	305		

Limit stops available upon request.

## PTFE-Vacuum Expansion Joint (Class 150)

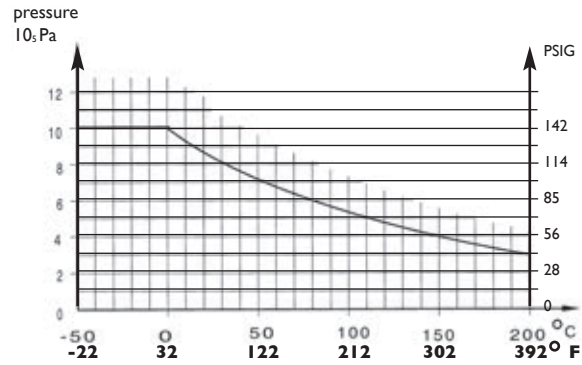
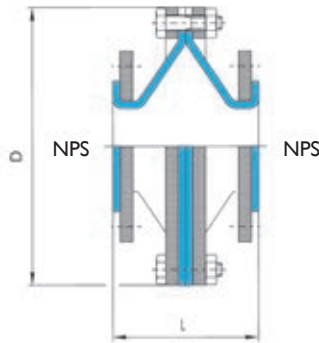

NPS	L		Extension Compr. ±		D	
	mm	in.	mm	in.	mm	in.
4"	95	3.74	10	0.39	285	11.22
6"	100	3.94	15	0.59	350	13.78
8"	105	4.13	15	0.59	410	16.14
10"	110	4.33	18	0.71	465	18.31
12"	115	4.53	18	0.71	520	20.47
14"	120	4.72	18	0.71	590	23.23
16"	135	5.31	20	0.79	670	26.23
18"	150	5.91	20	0.79	695	27.36
20"	150	5.91	20	0.79	770	30.31

PTFE-Vacuum Expansion Joints (Class 300) upon request.

## PTFE-Nozzle Liner

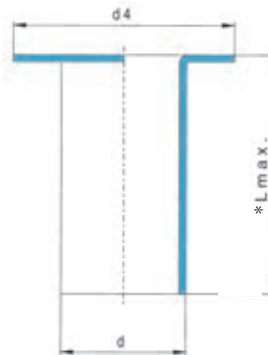

NPS	d Max	d4 Max	Thickness PTFE Max
1"	.947	2.00	.130
1½"	1.49	2.875	.150
2"	1.919	3.625	.160
3"	2.89	5.00	.160
4"	3.816	6.188	.160
6"	5.751	8.50	.275
8"	7.615	10.625	.310
10"	9.554	12.76	.420
12"	11.366	15.00	.470

\* L max is 240"

## Dip Tubes (PTFE Lined & Covered Steel)

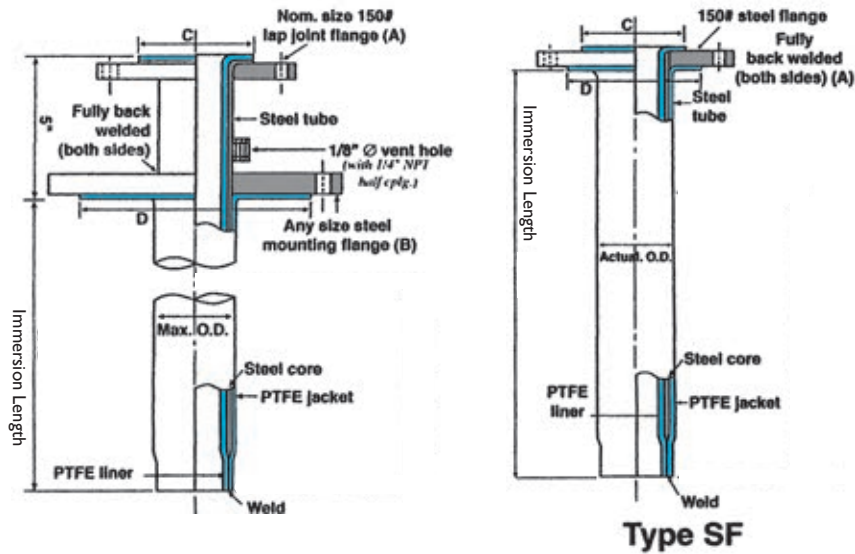

A Nominal Size	B Nozzle Flange Size "N"	C Diameter	D Diameter	Max O.D.
1"	1 1/2"	2"	2 7/8"	1.34"
1 1/2"	2"	2 7/8"	3 5/8"	1.82"
2"	3"	3 3/8"	5"	2.69"
3"	4"	5"	6 3/16"	3.82"
4"	6"	6 3/16"	8 1/2"	5.10"
6"	8"	8 1/2"	10 5/8"	7.13"
8"	10"	10 5/8"	12 3/4"	9.40"
10"	12"	12 3/4"	15"	11.47"

Larger nozzle mount flanges are also available. Consult factory.

## Spargers (PTFE Lined & Covered Steel)

A Nominal Size	B Nozzle Flange Size "N"	C	D	Max O.D.*	G
1"	2"	2"	3 5/8"	1.82	1 1/4"
1 1/2"	3"	2 7/8"	5	2.25	1 3/4"
2"	4"	3 5/8"	6 3/16"	2.82	1 3/4"
3"	6"	5"	8 1/2"	3.82	2 1/4"
4"	6"	6 3/16"	8 1/2"	5.10	2 1/2"
6"	8"	8 1/2"	10 5/8"	7.5	2 3/4"
8"	10"	10 5/8"	12 3/4"	9.40	3"
10"	12"	12 3/4"	15"	11.65	3 1/4"

Larger nozzle mount flanges are also available. Consult factory.

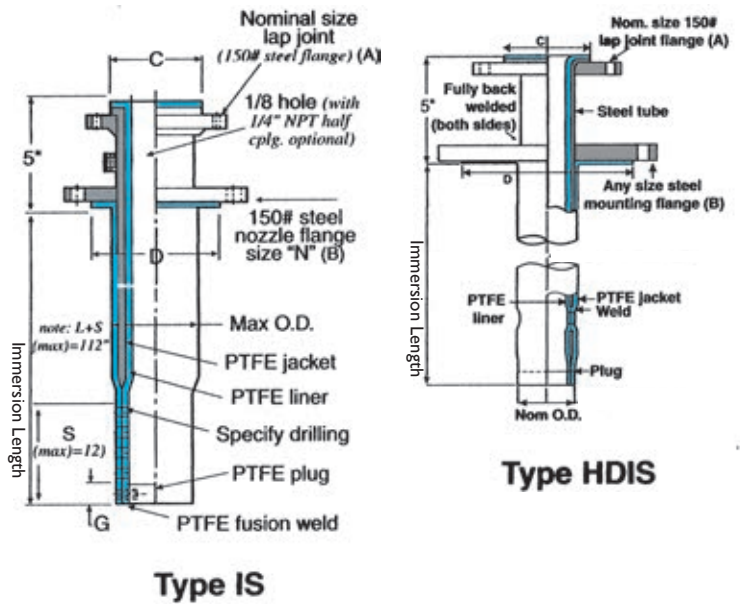

## Solid PTFE Dip Tubes & Spargers

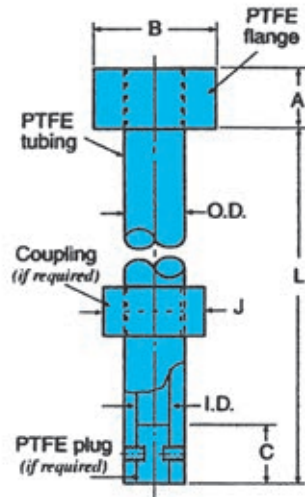

**Type T**

Nominal Size	Nozzle Size	I.D.	O.D.	A	B	C	J
1/2"	1"	5/8"	1"	1"	2"	1"	17/8"
1"	1 1/2"	1"	1 1/2"	1 1/2"	2 7/8"	1"	2 3/8"
1"	2"	1"	1 1/2"	1 1/2"	3 5/8"	1"	2 3/8"
1 1/2"	2"	1 1/2"	1 7/8"	1 3/4"	3 5/8"	1 1/4"	3 1/8"
1 1/2"	3"	1 1/2"	1 7/8"	2"	5"	1 3/4"	3 1/8"
2"	3"	2"	2 3/4"	2"	5"	1 3/4"	4 1/8"
2"	4"	2"	2 3/4"	2 1/2"	6 3/16"	1 3/4"	4 1/8"
3"	4"	3"	3 3/4"	2 3/4"	6 3/16"	2"	5 3/4"
3"	6"	3"	3 3/4"	2 3/4"	8 1/2"	2"	5 3/4"
4"	6"	4"	4 7/8"	3"	8 1/2"	2 1/2"	7 1/4"
6"	8"	6"	7 1/4"	3 1/4"	10 1/2"	2 1/2"	9 5/8"

\* Refer to drawings

**Note:** 118" maximum lengths unless couplings (J) are used.

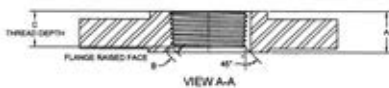
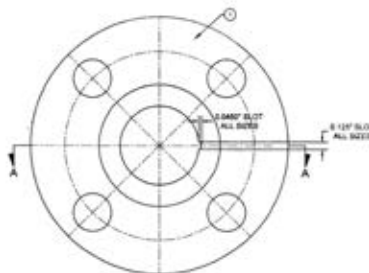

## Fixed, One Piece Field Flare Flange

Bill of Materials			
Item	Description	Material	Qty
2	FLANGE	ASME B16.5 CLASS 150 RAISED FACE THREADED FLANGE MODIFIED (WITH VENT SLOT) - SA105 CARBON STEEL	1

ANSI 150 Lb. Flange Dimensions			
Flange Size	A - Nominal Flange Length thru Hub (in.)	B - Chamfer (in.)	C - Resulting Min. Thread Depth (in.)
1" NPT	0.59"	0.12"	0.61"
1-1/2" NPT	0.88"	0.18"	0.75"
2" NPT	1.00"	0.18"	0.87"
3" NPT	1.19"	0.18"	1.06"
4" NPT	1.31"	0.09"	1.25"
6" NPT	1.66"	0.31"	1.34"

# Rotating, Two Piece Field Flare Flange

Bill of Materials			
Item	Description	Material	Qty
1	HUB	ASTM A106-B, A105 THREADED OR SOCKET	1
2	FLANGE	ASTM A105	1

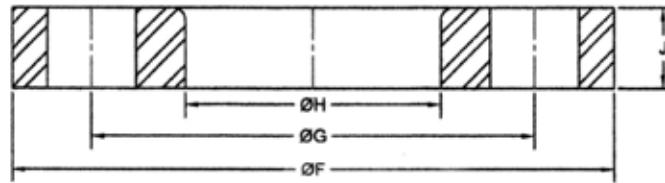
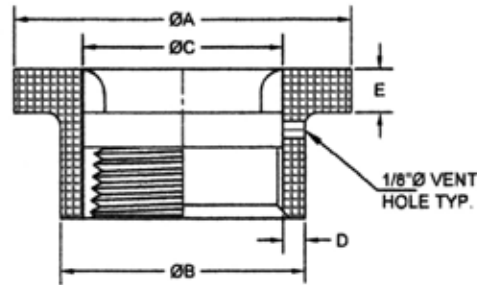
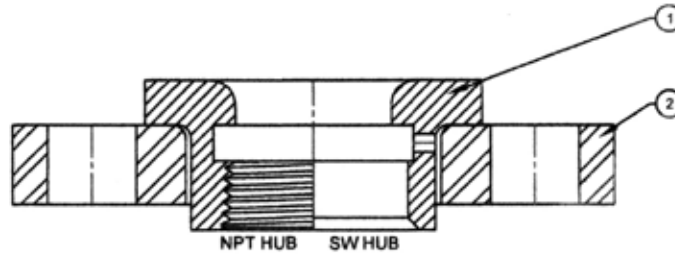

ANSI 150 Lb. Flange Dimensions									
Flange Size	A (in.)	B (in.)	C (in.)	D (in.)	E (in.)	F (in.)	G (in.)	H (in.)	J (in.)
1" NPT/SW	2.375	1.725	1.415	0.155	0.315	4.25	3.125	1.805	0.562
1-1/2" NPT/SW	3.250	2.350	2.00	0.175	0.280	5.00	3.875	2.430	0.687
2" NPT/SW	3.750	2.875	2.475	0.200	0.310	6.00	4.750	2.995	0.750
3" NPT/SW	5.250	4.150	3.630	0.260	0.330	7.50	6.00	4.240	0.937
4" NPT/SW	6.500	5.312	4.630	0.341	0.375	9.00	7.500	5.402	1.00
6" NPT/SW	8.687	7.520	6.755	0.383	0.340	11.00	9.500	7.620	1.125

# Instructions for Handling & Installation of BAUM Lined Pipe & Fittings

**1. Flange Protectors:** DO NOT remove flange protectors until pipe and fittings are ready to be installed. The protectors keep the flare from being damaged and/or recovering. Flange protectors should be replaced after inspection and when removed from service. Scratches or dents not exceeding 20% of liner thickness can be eliminated by hand-polishing with fine abrasive paper or cloth.

**2. Bolting:** Recommended 150# system bolt torques are for lightly oiled A193 B7 bolts and A194 2H nuts as follows in chart below. (torques vary with bolt and nut materials- consult factory).

Bolt Torque (Ft - Lbs.)				Bolt Torque (Ft - Lbs.)			
Pipe Size	PTFE/ PFA	PP	PVDF	Pipe Size	PTFE/ PFA	PP	PVDF
	Min.	Min.	Min.		Min.	Min.	Min.
1"	10	30	35	6"	60	120	120
1 1/2"	15	40	50	8"	75	150	120
2"	25	45	50	10"	70	140	140
3"	40	80	75	12"	90	140	180
4"	30	60	75	14"-40"	Consult Factory		

**Note:** Higher torques are recommended for services at the upper end of pressure, temperature and /or small molecule gas service. Use the lowest torque required to achieve a seal in the required service.

**Torquing of bolts:**

Grease all bolts and nuts with a suitable grease.  
Finger tighten all nuts.  
With a torque wrench, using the criss-cross method, tighten each bolt in 20% increments to the above listed torque.

After 24-30 hours or a temperature or pressure cycle, check the torque for each bolt and retorque those falling below the above-listed torque values.

Torque values listed above should be exceeded only when necessary to effect a seal. Increase in 10% increment of allowed torque. If a seal is not achieved at 150% of published torque disconnect and check for scratches.

Retorque annually.

**3. Gaskets:** PTFE envelope gaskets must be used only when flanging lined items to flanges of dissimilar material.

**4. Vent Holes:**

- A. DO NOT plug vent holes.
- B. DO NOT use a sharp instrument to clean plugged vent holes.
- C. Vent hole extensions are recommended for insulated pipe systems and/or permeating media.

**5. Disassembly:** DO NOT remove pipe spools, fittings or valves from system when temperature exceeds 30° F above ambient. Upon removal of pipe fittings or valves from a system, a flange protector must be bolted to each flange.

**6. Welding:** DO NOT perform any welding on the metal after liner is in place.

**7. Low Temperature:** Cold temperatures can cause brittleness in PP & PVDF lined products. Handle and store with caution below 0°F (-18°C) Heat tracing is advised below 32° F. Temperature should not exceed liner rating. Utilize stand-off strips, heat transfer cement, or high quality tape systems.

**8. Support Spacing:** Plastic-lined piping is considered a schedule 40 flanged system. Supports should follow the outline in the "Piping Handbook" by Crocker & King. Special care should be taken not to overstress the plastic flange faces. Do not exceed 10,000 psi of stress longitudinally or axially. Plan hangers or supports near the flange or where flow changes direction, and in areas of high load to prevent excessive deflection.

**9. Grounding:** The standard epoxy primer will not consistently conduct electricity. Consider grounding studs and jumper cables.

**Paint System:**

BAUM products are blasted to near white metal and painted with epoxy primer for their protection as standard. Special systems or color coding to your specification can be provided. Consult factory for pricing.

**Sandblasting:**

When field blasting, ends must be protected either by installing or by blasting with end covers in place. No other special precautions need to be taken.

**Heat Tracing:**

Steam or electric heat tracing can be used with the following precautions:

- 1. Stand off strips or heat transfer cement should be used to prevent direct contact.
- 2. Tracing temperature must not exceed the maximum recommended liner temperature, with the given media.
- 3. When electric heating cable or tape is used, place cable in "W" wrap and cover with a parallel covering of 2" wide aluminum tape to spread heat.

Heat tracing is recommended for both polypropylene and PVDF at temperatures below freezing.

The information, recommendations and opinions set forth herein are offered solely for your consideration, inquiry and verification, and are not, in part or total, to be construed as constituting a warranty or representation for which we assume legal responsibility.





# **Plastic-Lined Piping Systems**

The Next Generation of Safety, Quality and Innovation



**BAUM America Corp**  
46 Mesa Dr. St. Albans, WV 25177  
Phone: (304) 755-2571 Fax: (304) 755-2573  
E-Mail: info@baumamericacorp.com

[www.baumamericacorp.com](http://www.baumamericacorp.com)