

Platinum Edition 10 Unisaw with 50 Commercial Biesemeyer Fence System (Model 36-945)

INSTRUCTION MANUAL



DATED 6-11-99

PART NO. 422-04-651-0051
©Delta International Machinery Corp. 1999



TABLE OF CONTENTS

SAFETY RULES.....	3
ADDITIONAL SAFETY RULES.....	4
UNPACKING AND CLEANING.....	5
ASSEMBLY INSTRUCTIONS	
Assembling On/Off Switch.....	7
Assembling Extension Wing To Saw Table.....	8
Assembling Guide Rails.....	9
Assembling Table Legs To Extension Table.....	10
Assembling Extension Table To Front And Rear Rails.....	11
Assembling Blade Guard And Splitter Assembly.....	12
Fastening Motor Cord To Saw Frame.....	15
Assembling Motor Cover.....	15
Assembling Miter Gage And Wrench Holder Brackets.....	16
Assembling Rip Fence Holder Brackets.....	17
Attaching Literature Holder To Saw Cabinet.....	17
CONNECTING SAW TO POWER SOURCE	
Grounding Instructions.....	18
Single Phase Operation.....	18
Three Horsepower Motors.....	18
OPERATING CONTROLS AND ADJUSTMENTS	
Starting And Stopping The Saw.....	19
Locking Switch In The “OFF” Position.....	19
Blade Raising Mechanism.....	20
Blade Tilting Mechanism.....	20
Adjusting 90 And 45 Degree Positive Stops.....	21
Adjusting Table.....	21
FENCE OPERATION.....	22
FENCE LUBRICATION.....	22
ADJUSTING FENCE PARALLEL TO MITER GAGE SLOTS.....	23
ADJUSTING CLAMPING ACTION OF FENCE LOCKING HANDLE.....	23
ADJUSTING TABLE INSERT.....	24
MITER GAGE OPERATION AND ADJUSTMENT.....	24
MAINTENANCE.....	25
Changing The Saw Blade.....	25
Replacing Belts And Adjusting Belt Tension.....	25
OPERATION.....	26
Cross-Cutting.....	26
Ripping.....	27
Using Accessory Moulding Cutterhead.....	27
Using Accessory Dado Head.....	29
Using Auxiliary Wood Facing On Rip Fence.....	30
ATTACHING ENGRAVED NAMEPLATE.....	30
CONSTRUCTING A PUSH STICK.....	31
PARTS, SERVICE OR WARRANTY ASSISTANCE.....	31
WARRANTY.....	32

SAFETY RULES

Woodworking can be dangerous if safe and proper operating procedures are not followed. As with all machinery, there are certain hazards involved with the operation of the product. Using the machine with respect and caution will considerably lessen the possibility of personal injury. However, if normal safety precautions are overlooked or ignored, personal injury to the operator may result. Safety equipment such as guards, push sticks, hold-downs, featherboards, goggles, dust masks and hearing protection can reduce your potential for injury. But even the best guard won't make up for poor judgment, carelessness or inattention. Always use common sense and exercise caution in the workshop. If a procedure feels dangerous, don't try it. Figure out an alternative procedure that feels safer. REMEMBER: Your personal safety is your responsibility.

This machine was designed for certain applications only. Delta Machinery strongly recommends that this machine not be modified and/or used for any application other than that for which it was designed. If you have any questions relative to a particular application, DO NOT use the machine until you have first contacted Delta to determine if it can or should be performed on the product.

**DELTA INTERNATIONAL MACHINERY CORP.
MANAGER OF TECHNICAL SERVICES
246 ALPHA DRIVE
PITTSBURGH, PENNSYLVANIA 15238
(IN CANADA: 644 IMPERIAL ROAD, GUELPH, ONTARIO N1H 6M7)**

WARNING: FAILURE TO FOLLOW THESE RULES MAY RESULT IN SERIOUS PERSONAL INJURY

- 1. FOR YOUR OWN SAFETY, READ INSTRUCTION MANUAL BEFORE OPERATING THE TOOL.** Learn the tool's application and limitations as well as the specific hazards peculiar to it.
- 2. KEEP GUARDS IN PLACE** and in working order.
- 3. ALWAYS WEAR EYE PROTECTION.**
- 4. GROUND ALL TOOLS.** If tool is equipped with three-prong plug, it should be plugged into a three-hole electrical receptacle. If an adapter is used to accommodate a two-prong receptacle, the adapter lug must be attached to a known ground. Never remove the third prong.
- 5. REMOVE ADJUSTING KEYS AND WRENCHES.** Form habit of checking to see that keys and adjusting wrenches are removed from tool before turning it "on."
- 6. KEEP WORK AREA CLEAN.** Cluttered areas and benches invite accidents.
- 7. DON'T USE IN DANGEROUS ENVIRONMENT.** Don't use power tools in damp or wet locations, or expose them to rain. Keep work area well-lighted.
- 8. KEEP CHILDREN AND VISITORS AWAY.** All children and visitors should be kept a safe distance from work area.
- 9. MAKE WORKSHOP CHILDPROOF** – with padlocks, master switches, or by removing starter keys.
- 10. DON'T FORCE TOOL.** It will do the job better and be safer at the rate for which it was designed.
- 11. USE RIGHT TOOL.** Don't force tool or attachment to do a job for which it was not designed.
- 12. WEAR PROPER APPAREL.** No loose clothing, gloves, neckties, rings, bracelets, or other jewelry to get caught in moving parts. Nonslip footwear is recommended. Wear protective hair covering to contain long hair.
- 13. ALWAYS USE SAFETY GLASSES.** Wear safety glasses. Everyday eyeglasses only have impact resistant lenses; they are not safety glasses. Also use face or dust mask if cutting operation is dusty.
- 14. SECURE WORK.** Use clamps or a vise to hold work when practical. It's safer than using your hand and frees both hands to operate tool.
- 15. DON'T OVERREACH.** Keep proper footing and balance at all times.
- 16. MAINTAIN TOOLS IN TOP CONDITION.** Keep tools sharp and clean for best and safest performance. Follow instructions for lubricating and changing accessories.
- 17. DISCONNECT TOOLS** before servicing and when changing accessories such as blades, bits, cutters, etc.
- 18. USE RECOMMENDED ACCESSORIES.** The use of accessories and attachments not recommended by Delta may cause hazards or risk of injury to persons.
- 19. REDUCE THE RISK OF UNINTENTIONAL STARTING.** Make sure switch is in "OFF" position before plugging in power cord.
- 20. NEVER STAND ON TOOL.** Serious injury could occur if the tool is tipped or if the cutting tool is accidentally contacted.
- 21. CHECK DAMAGED PARTS.** Before further use of the tool, a guard or other part that is damaged should be carefully checked to ensure that it will operate properly and perform its intended function – check for alignment of moving parts, binding of moving parts, breakage of parts, mounting, and any other conditions that may affect its operation. A guard or other part that is damaged should be properly repaired or replaced.
- 22. DIRECTION OF FEED.** Feed work into a blade or cutter against the direction of rotation of the blade or cutter only.
- 23. NEVER LEAVE TOOL RUNNING UNATTENDED. TURN POWER OFF.** Don't leave tool until it comes to a complete stop.
- 24. DRUGS, ALCOHOL, MEDICATION.** Do not operate tool while under the influence of drugs, alcohol or any medication.
- 25. MAKE SURE TOOL IS DISCONNECTED FROM POWER SUPPLY** while motor is being mounted, connected or re-connected.
- 26. WARNING:** The dust generated by certain woods and wood products can be injurious to your health. Always operate machinery in well ventilated areas and provide for proper dust removal. Use wood dust collection systems whenever

ADDITIONAL SAFETY RULES FOR CIRCULAR SAWS

1. **WARNING:** Do not operate your saw until it is completely assembled and installed according to the instructions.
2. **IF YOU ARE NOT** thoroughly familiar with the operation of circular saws, obtain advice from your supervisor, instructor, or other qualified person.
3. **ALWAYS** use guard, splitter and anti-kickback fingers on all “thru-sawing” operations. Thru-sawing operations are those when the blade cuts completely through the workpiece as in ripping or cross-cutting.
4. **ALWAYS** hold the work firmly against the miter gage or fence.
5. **NEVER** use the fence as a cut-off gage when cross-cutting.
6. **MOVE** the rip fence out of the way when cross-cutting.
7. **NEVER** perform any operation “free-hand” which means using your hands to support or guide the workpiece. Always use either the fence or miter gage to position and guide the work.
8. **ALWAYS** use a push stick for ripping narrow stock. Refer to ripping applications in instruction manual where the push stick is covered in detail.
9. **AVOID** kickbacks (work thrown back toward you) by:
 - A. Keeping blade sharp.
 - B. Keeping rip fence parallel to the saw blade.
 - C. Keeping splitter and anti-kickback fingers and guard in place and operating.
 - D. Not releasing the work before it is pushed all the way past the saw blade.
 - E. Not ripping work that is twisted or warped or does not have a straight edge to guide along the fence.
10. **AVOID** awkward operations and hand positions where a sudden slip could cause your hand to move into the cutting tool.
11. **ALWAYS** keep hands and fingers away from the blade.
12. **NEVER** stand or have any part of your body in line with the path of the saw blade.
13. **NEVER** reach behind or over the cutting tool with either hand for any reason.
14. **DIRECTION OF FEED.** Feed work into blade or cutter against the direction or rotation of the blade or cutter only.
15. **DO NOT** feed the material too fast while cutting. Feed the material only fast enough so that the blade will cut.
16. **NEVER** attempt to free a stalled saw blade without first turning the saw “OFF.”
17. **NEVER** start the saw with the workpiece pressed against the blade.
18. **NEVER** turn the saw “ON” before clearing the table of all objects (tools, scraps of wood, etc.).
19. **ALWAYS STOP** the saw before removing scrap pieces from the table.
20. **NEVER** perform layout, assembly or set-up work on the table while the saw is operating.
21. **PROVIDE** adequate support to the rear and sides of the saw table for wide or long workpieces.
22. **WHEN** cutting mouldings, **NEVER** run the stock between the fence and the moulding cutterhead.
23. **NEVER** use solvents to clean plastic parts. Solvents could possibly dissolve or otherwise damage the material. Only a soft damp cloth should be used to clean plastic parts.
24. **SHOULD** any part of your circular saw be missing, damaged, or fail in any way, or any electrical components fail to perform properly, shut off switch and remove plug from power supply outlet. Replace missing, damaged or failed parts before resuming operation.
25. **ADDITIONAL INFORMATION** regarding the safe and proper operation of this product is available from the National Safety Council, 1121 Spring Lake Drive, Itasca, IL 60143-3201, in the Accident Prevention Manual for Industrial Operations and also in the Safety Data Sheets provided by the NSC. Please also refer to the American National Standards Institute ANSI O1.1 Safety Requirements for Woodworking Machinery and the U.S. Department of Labor OSHA 1910.213 Regulations.

UNPACKING AND CLEANING

Carefully unpack the saw and fence system from the shipping containers. Clean all loose parts and remove the protective coating from the machined surfaces of the saw table. This coating may be removed with a soft cloth moistened with kerosene (do not use acetone, gasoline, or lacquer thinner for this purpose). Figures 2 and 3, illustrate the saw and all loose items supplied with the machine. Figs. 4 and 5, illustrate the items supplied with the fence system. **IMPORTANT:** The saw is shipped with the saw arbor in the 45 degree position. Loosen locking knob (A) Fig. 2, and turn handwheel (B) until the saw arbor is in the 90 degree position and remove the styrofoam packing from inside the saw cabinet. Tighten locking knob (A).

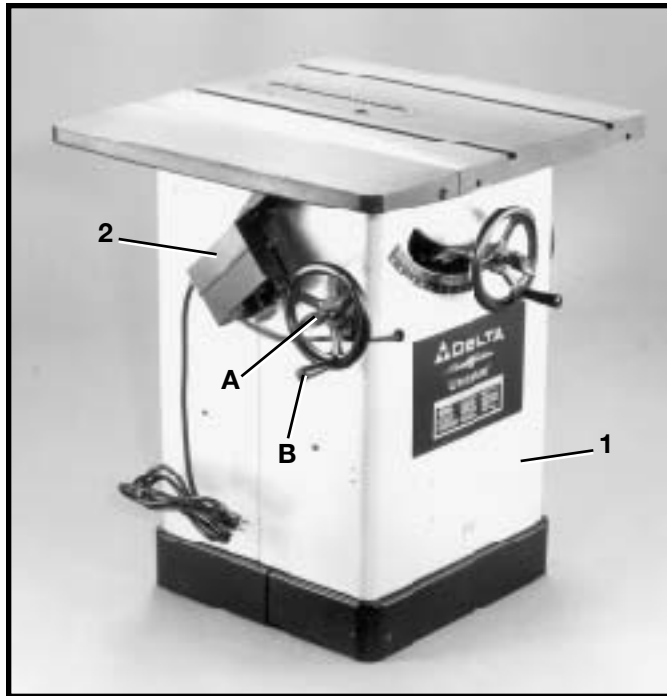

Fig. 2

1. Unisaw
2. Switch
3. Motor cover
4. Blade guard and splitter bracket
5. Support rod
6. 5/8 Internal tooth washer
7. 5/8-18 Jamb nut
8. Upper bracket for splitter
9. Lower bracket for support rod
10. 5/16 I.D. Flat washers (2)
11. 5/16 I.D. Lockwashers (3)
12. 5/16-18 x 1 Hex head cap screws (4)
13. Arbor wrenches (2)
14. 1/4 and 3/8 Hex wrenches
15. Miter gage
16. Flat washer for miter gage
17. Handle for miter gage handle
18. Cap for miter gage handle
19. Storage hook for arbor wrenches
20. #10 x 1/2 hex washer head screws (10)
21. Hanger for miter gage
22. Hangers for rip fence (2)
23. Flat head screw for mounting switch
24. Flat washer for mounting switch
25. Hex nut for mounting switch
26. Gasket for motor cover
27. Cable tie
28. Latch for motor cover
29. Square cornered cast iron extension wing
30. Mounting hardware

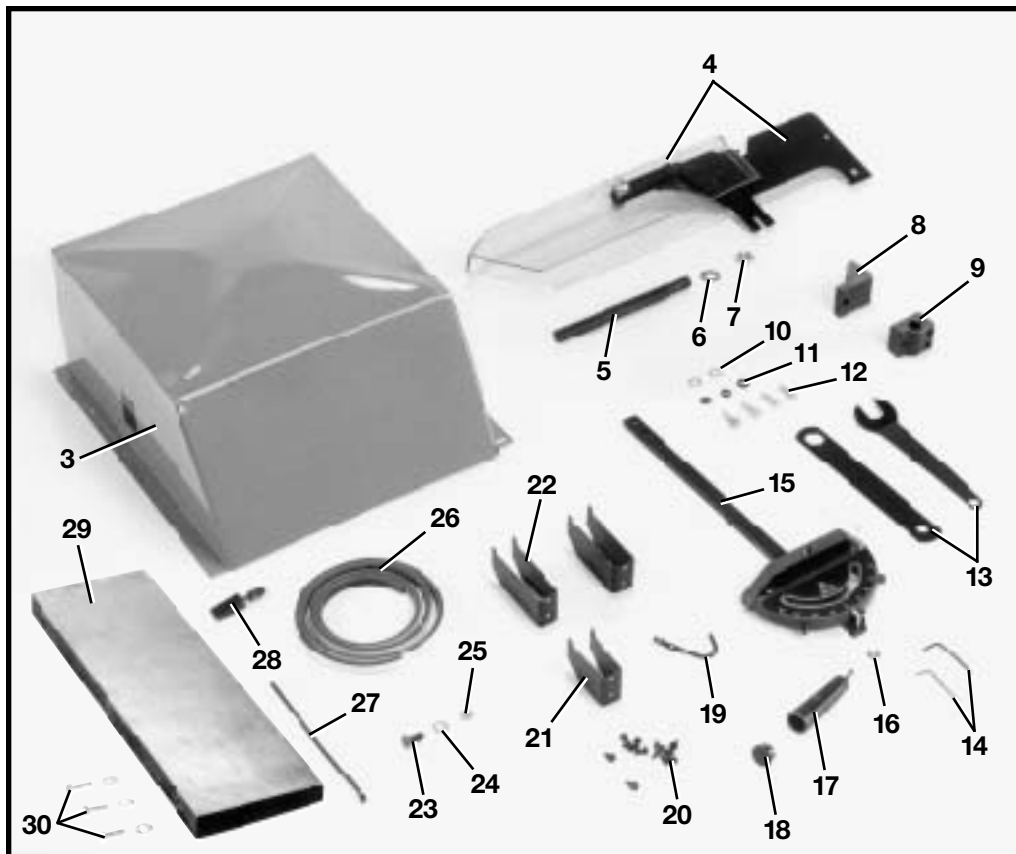

Fig. 3

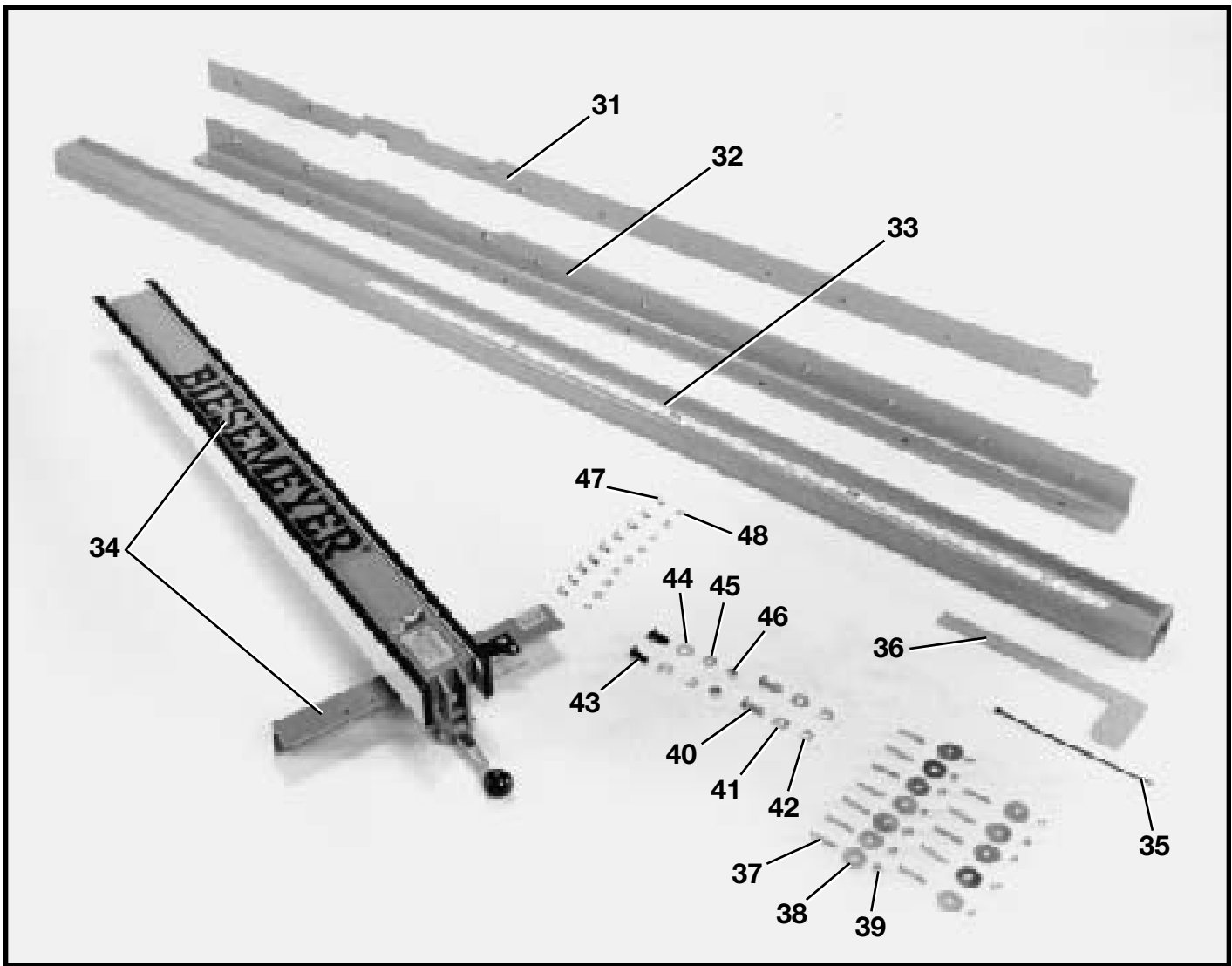

Fig. 4

31 - Rear Rail

32 - Front Rail

33 - Guide Tube

34 - T-Square® Fence Assembly

35 - Cable Strap

36 - Template for aligning front rail to saw table

for fastening front and rear rails to right extension table

37 - 1-1/2 long flat head Phillips screws (12)

38 - 1-1/4 O.D. Flat Washers (12)

39 - 1/4-20 hex nuts (12)

for fastening rear rail to saw table

40 - 3/8-24 x 1-1/4 long hex head cap screws (2)

41 - 7/8 O.D. flat washers (2)

42 - Lock washers (2)

for fastening front rail to saw table

43 - 3/8-16 x 1-1/4 long flat head Phillips screws (2)

44 - 7/8 O.D. flat washers (2)

45 - Lock washers (2)

46 - 3/8-16 hex nuts (2)

for fastening guide tube to front rail

47 - 1/2 long hex screws (9)

48 - Lock washers (9)

* Table board (not shown)

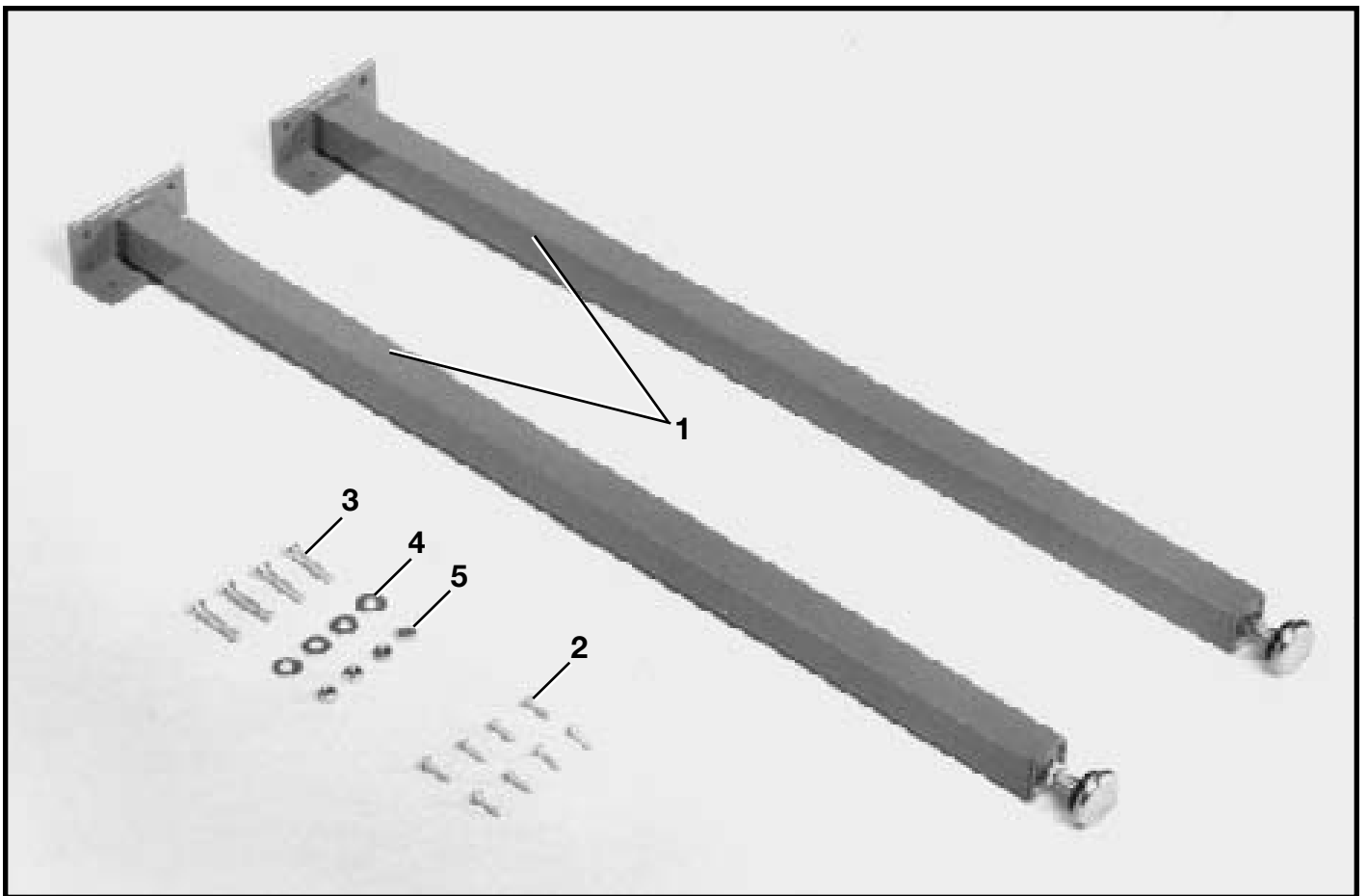

Fig. 5

- 1 - Legs (2)
- 2 - 5/8 long wood screws #8 (8)
- 3 - 1/4-20 x 1-1/2 long flat head Phillips screws (4)
- 4 - 1/4 flat washers (4)
- 5 - 1/4-20 hex nuts (4)

ASSEMBLY INSTRUCTIONS

WARNING: FOR YOUR OWN SAFETY, DO NOT CONNECT THE SAW TO THE POWER SOURCE UNTIL THE SAW IS COMPLETELY ASSEMBLED AND YOU HAVE READ AND UNDERSTOOD THE ENTIRE INSTRUCTION MANU-

ASSEMBLING ON/OFF SWITCH

1. The on/off switch (A) Fig. 6, is shipped attached to a mounting bracket at the left side of the machine.
2. Remove screw and flat washer (B) Fig. 6, that is holding the switch and bracket to the machine. Remove the switch from the side of the machine. **Replace screw and flat washer (B). WARNING: DO NOT REMOVE SCREWS (B) AND (C) AT THE SAME TIME.**
3. Remove screw and flat washer (C) from the underside of the extension table at the front of the saw.

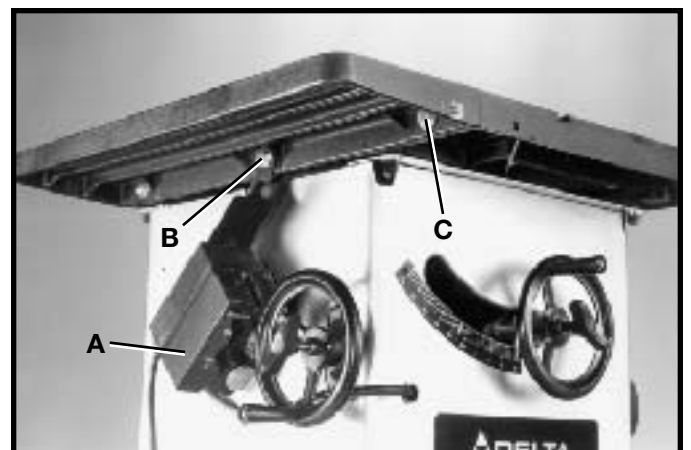

Fig. 6

4. Loosely assemble switch and switch bracket (A) Fig. 7, to the inside front lip of extension table with hex flat head screw (D), flat washer (E), and hex nut (F) through hole (G).

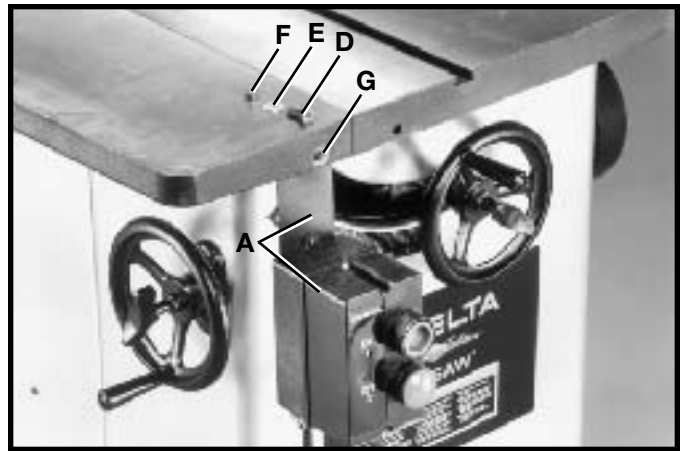

Fig. 7

5. Attach the side of switch bracket (A) Fig. 8, to the inside of extension table at the front of the saw using the 5/8 x 1-1/4 screw and flat washer (C), which were removed in **STEP 3**. Tighten screws (C) and (D).

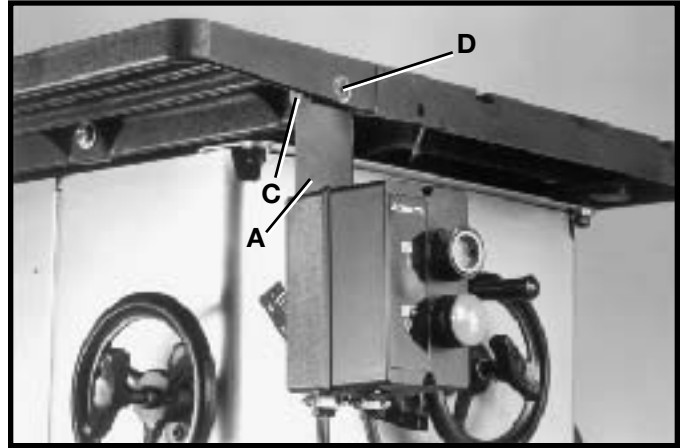

Fig. 8

ASSEMBLING EXTENSION WING TO SAW TABLE

Assemble extension wing (A) Fig. 9, to the right hand side of the saw table using three 1-1/4 inch-long hex head screws (B) and flat washers supplied. Use a straight edge (C) Fig. 10, to make certain the extension wing is level at the front and rear of the saw table before tightening three screws (B) Fig. 9. **NOTE:** Make certain the left extension wing (D) is also level with saw table in the same manner.

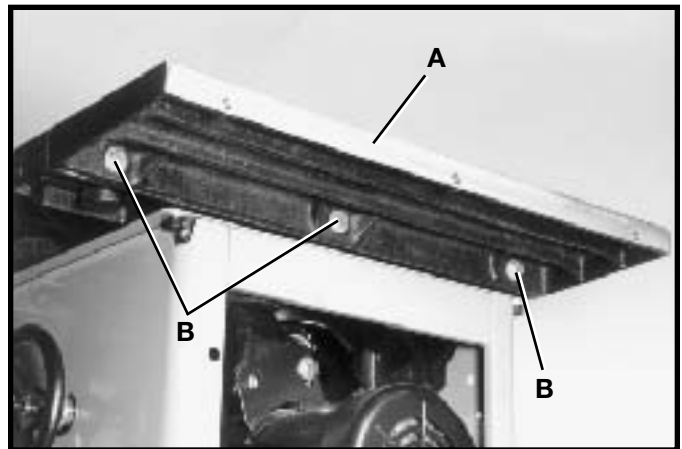

Fig. 9

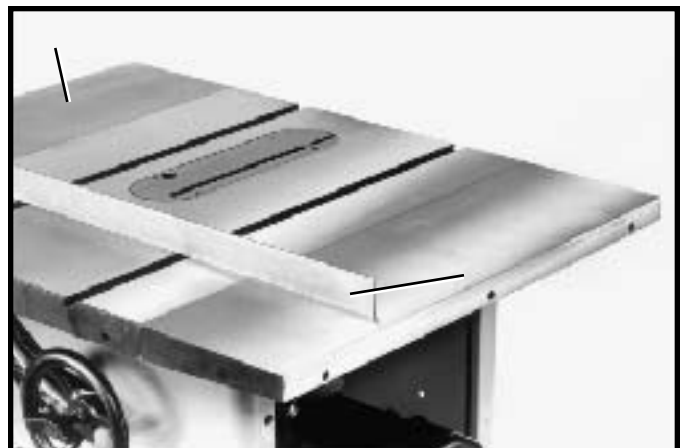

Fig. 10

ASSEMBLING GUIDE RAILS

1. Assemble the front rail (A) Fig. 11, to front of saw table using the two 3/8-16 x 1-1/4 long flat head Phillips screws (B), 7/8 flat washers, lockwashers and 3/8-16 hex nuts supplied. Screws (B) are inserted through the two holes in the front rail, as shown and through the two through holes in the front of the saw table and fastened to the table with the flat washers, lockwashers and hex nuts. **IMPORTANT: Do not completely tighten front rail mounting hardware at this time.**

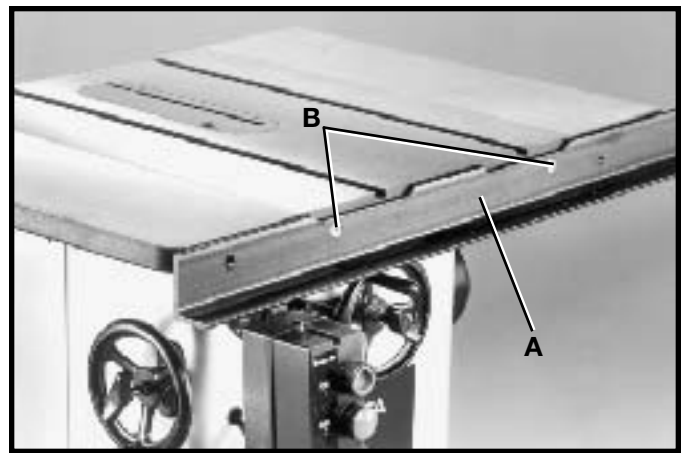

Fig. 11

2. Using the template (D) Figures 12 and 13, check and adjust front rail at both ends of the saw table as shown, to make sure rail (A) is level with table surface and tighten rail mounting hardware (B). **IMPORTANT: Template (D) must be on the saw table when checking, not on extension wing.**

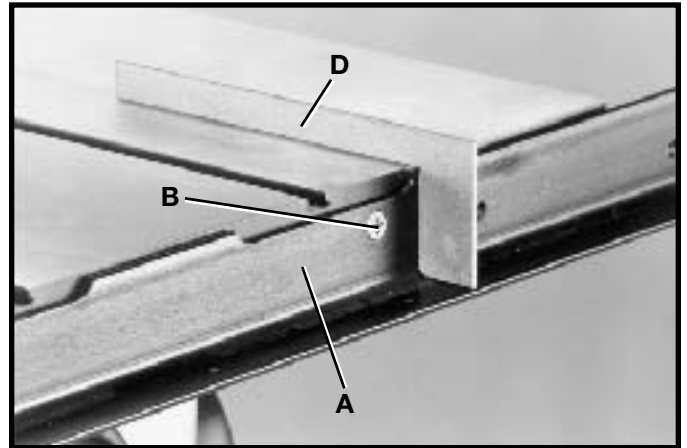

Fig. 12

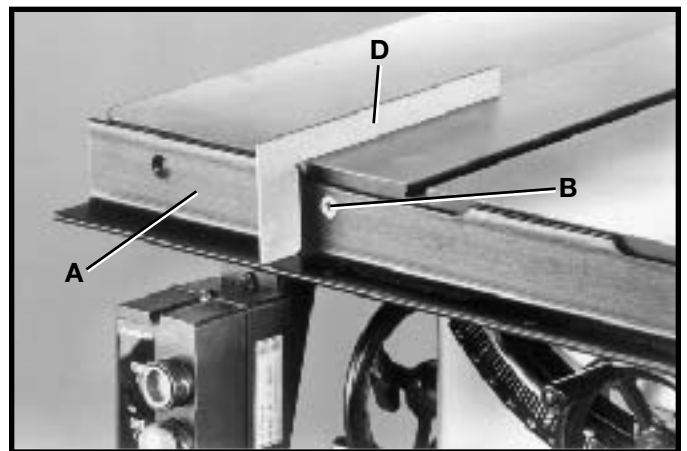

Fig. 13

3. Assemble rear rail (E) Fig. 14, to rear of saw table using the two 3/8-24 x 1-1/4 long hex head screws (F), 7/8 O.D. flat washers, and lockwashers as shown. **NOTE: When mounting, the two screws (F) are threaded into the threaded holes in the saw table, as shown.**

4. Make certain top edge of rail (E) Fig. 14 is below table surface and that top edge of cut-outs (G) are below miter gage slots before tightening screws (F).

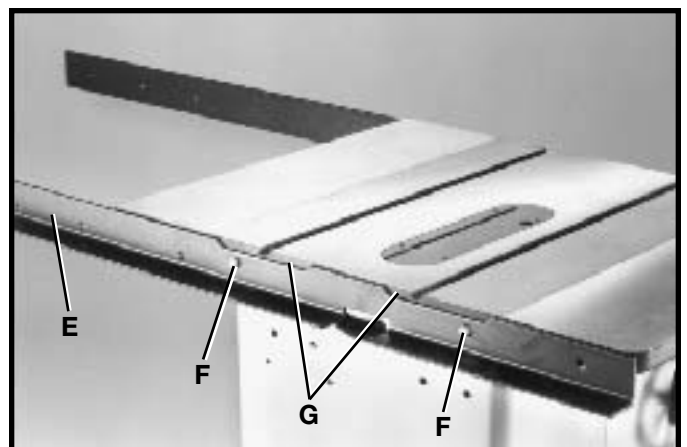

Fig. 14

ASSEMBLING TABLE LEGS TO EXTENSION TABLE

1. Position the two legs (H) Fig. 15, at the two far corners of the inside of one end of the extension table, as shown, and mark the position of the eight holes to be drilled into the bottom of the table. **IMPORTANT: If your saw will be used with a mobile base underneath the saw base and table legs, the position of the legs may have to be changed to fit onto the mobile base.** Remove the two legs (H) and using a 1/16" drill bit, drill the eight holes 1/2" deep. Replace the two legs and fasten to the bottom of the table using the eight 3/4" long wood screws (I) supplied.

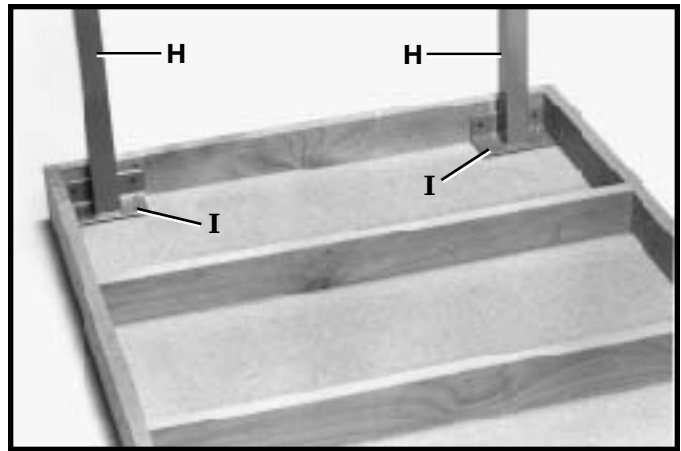

Fig. 15

2. Figure 16 illustrates one of the legs (H) fastened to the bottom of the extension table with the four wood screws (I). Using a 1/4" drill bit, drill two through holes through the end piece (J) of the table using the two holes (K) as a template.

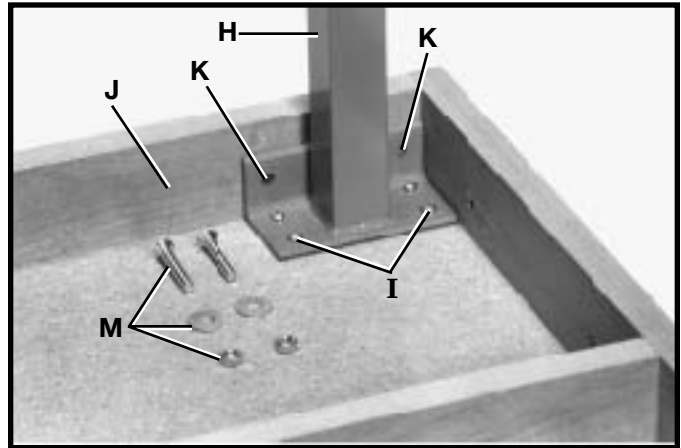

Fig. 16

3. Fasten the leg bracket (L) Fig. 17, to the end piece (J) of the table using the two 1-1/2" long flat head Phillips screws, flat washers and hex nuts (M) Figs. 16 and 17. Fasten the remaining leg to the extension table in the same manner.

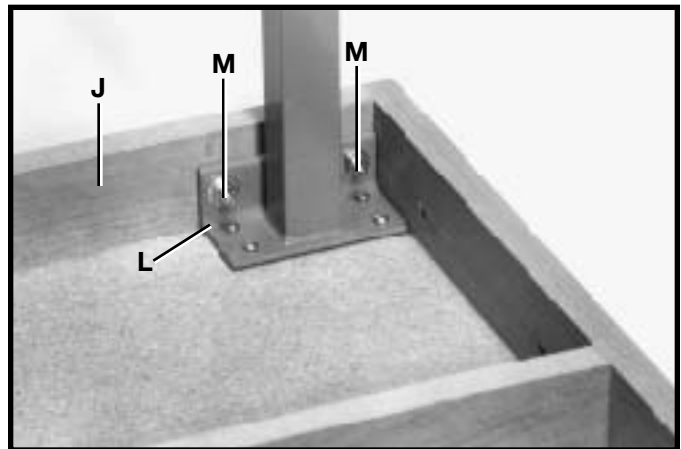

Fig. 17

4. Figure 18 illustrates the two legs (H) assembled to the bottom of the table.

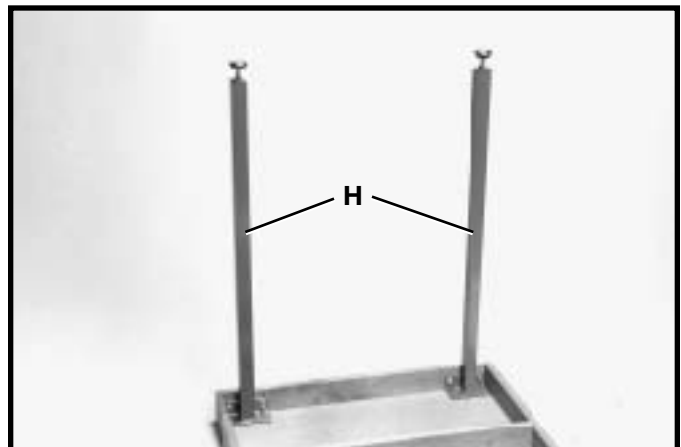

Fig. 18

ASSEMBLING EXTENSION TABLE TO FRONT AND REAR RAILS

1. Place table assembly (N) Fig. 19, in position between the two rails, as shown. Make sure end of table (O) is flush against extension wing (P) and using a bar clamp (T) snug up end of rails to hold table in position. Using a straight edge make sure table (O) is in the same plane and level with saw table (P). Lightly tap table up or down and adjust leveling screws (R) Fig. 20, in bottom of legs to accomplish this. When you are certain table (O) Fig. 19, is level and in the same plane with saw table (P), tighten bar clamp (T) to hold everything in position. Then drill 1/4" through holes through the front and rear of the extension table using the holes (S) provided in rails as template.

2. After the holes have been drilled in the edge of the front and rear extension table board, fasten both front and rear rail to table using the 1-1/2" flat head Phillips screws, flat washers, and hex nuts (M) Fig. 16.

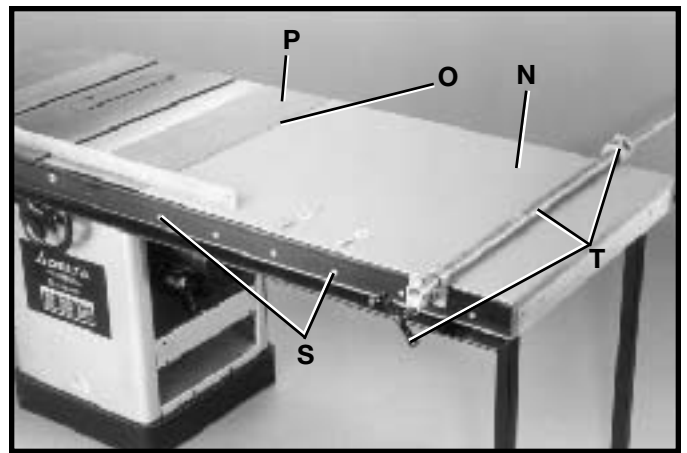

Fig. 19

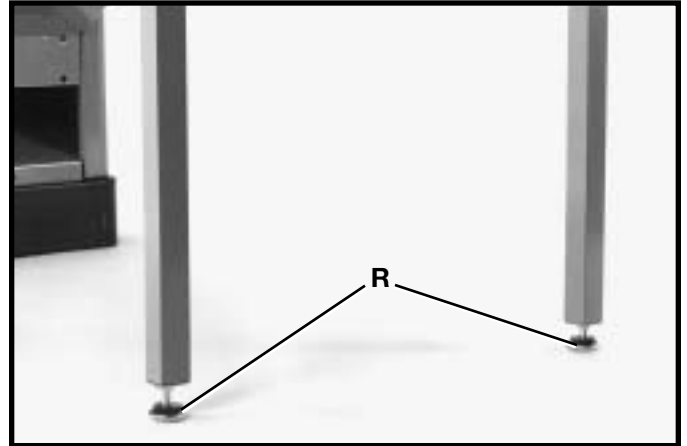

Fig. 20

ASSEMBLING GUIDE TUBE TO FRONT RAIL

1. Lay the guide tube (B) Fig. 21, on the saw table as shown, and line up the threaded holes (C) on bottom of guide tube (B) with the through holes (D) on the front rail (A).

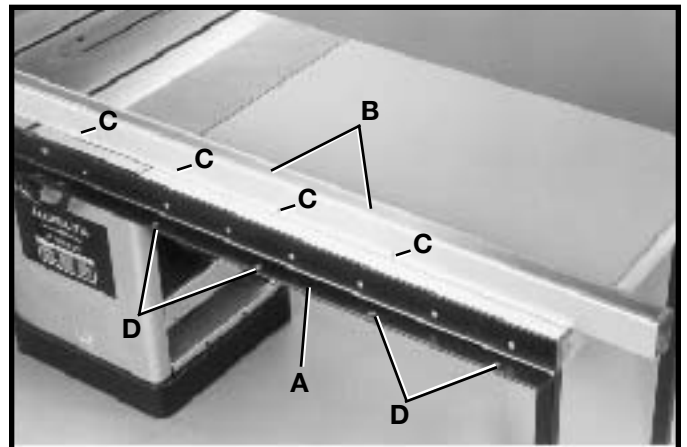

Fig. 21

2. Position the guide tube (B) Fig. 22, on the front rail and fasten the guide tube to the rail using the 1/2" long hex screws (G) and lockwashers in all of the holes.

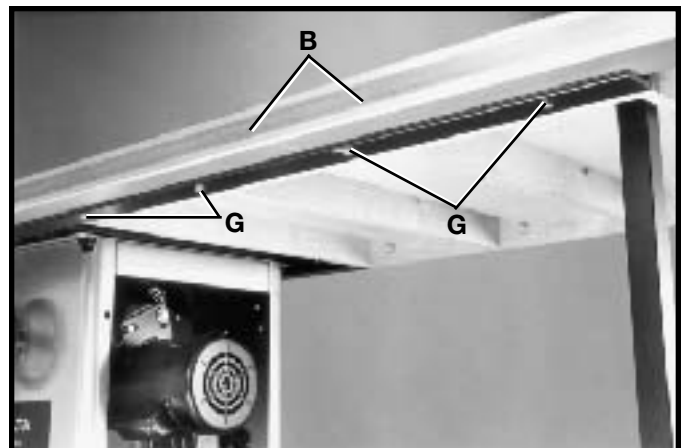

Fig. 22

ASSEMBLING BLADE GUARD AND SPLITTER ASSEMBLY

MAKE CERTAIN THE MACHINE IS DISCONNECTED FROM THE POWER SOURCE.

1. Remove the table insert. Raise the saw arbor as far as it will go and remove the saw blade from the machine by following the instructions in section “**REMOVING THE SAW BLADE**”.

2. The inside splitter mounting bracket (A) Fig. 23, is assembled to the inside of the saw and aligned with the inside blade flange (B) at the factory. To check the alignment, remove screw and fastener plate (C).

3. Using a straight edge (D) Fig. 24, check to see if the splitter bracket (A) is aligned with the inside blade flange (B). Check both the top and bottom of bracket (A) with the top and bottom of flange (B).

4. If an adjustment is necessary, loosen two screws (E) Fig. 25, and adjust splitter bracket (A) until it is aligned with the inside blade flange (B) Fig. 23 . Tighten two screws (F). Loosely assemble screw and fastener plate (C) which were removed in **STEP 2**.

5. Insert threaded end of support rod (G) Fig. 26, through slot in rear of saw and into hole in rear trunnion (H). Fasten support rod (G) to trunnion with star washer and hex nut (J) Fig. 27. **NOTE:** Thread nut (J) Fig. 27, onto threads of support rod (G) as much as possible by hand.

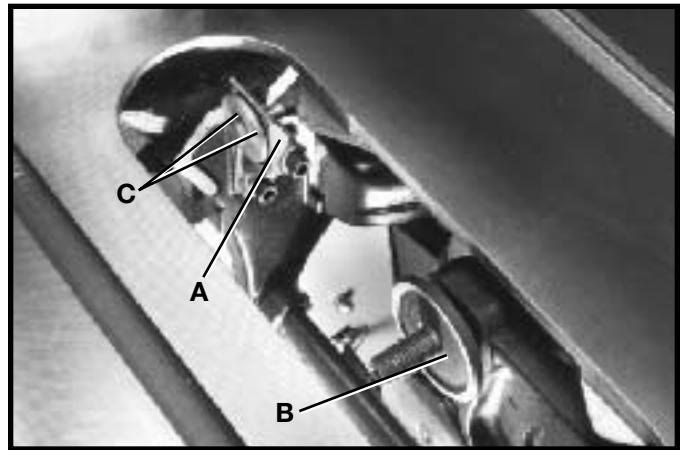

Fig. 23

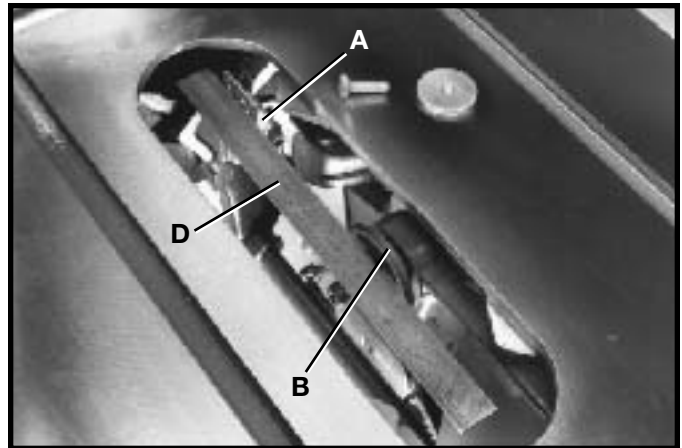

Fig. 24

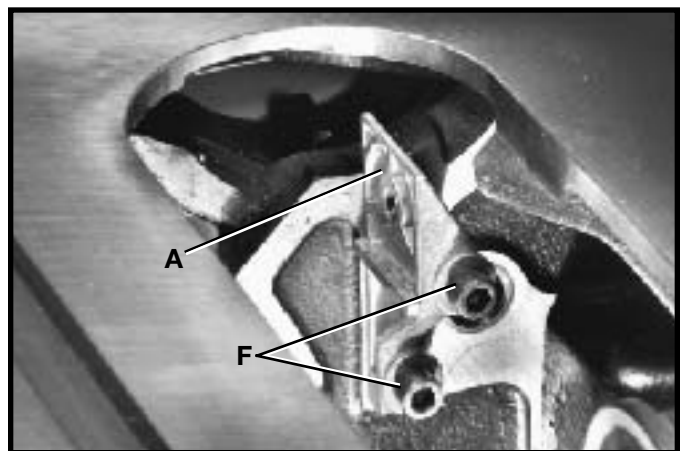

Fig. 25

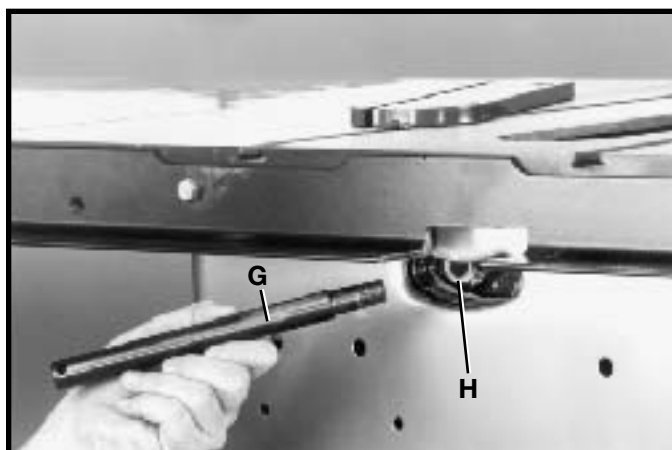

Fig. 26

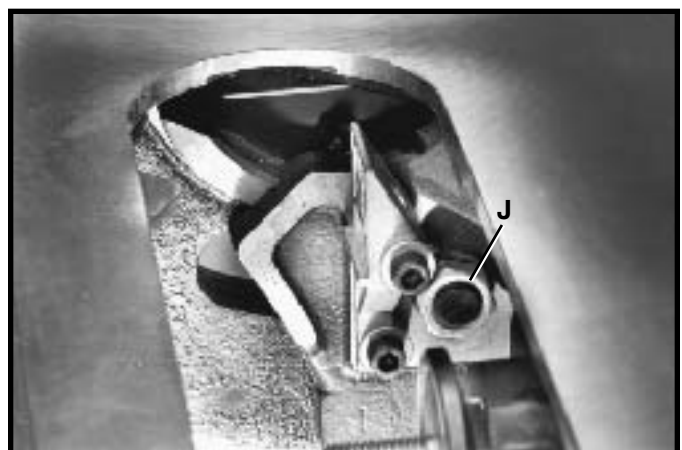

Fig. 27

6. Using a wrench to hold the hex nut (J) Fig. 27, tighten rod (G) Fig. 28, with a small screwdriver (K) or similar device through the hole in the end of the rod as shown.

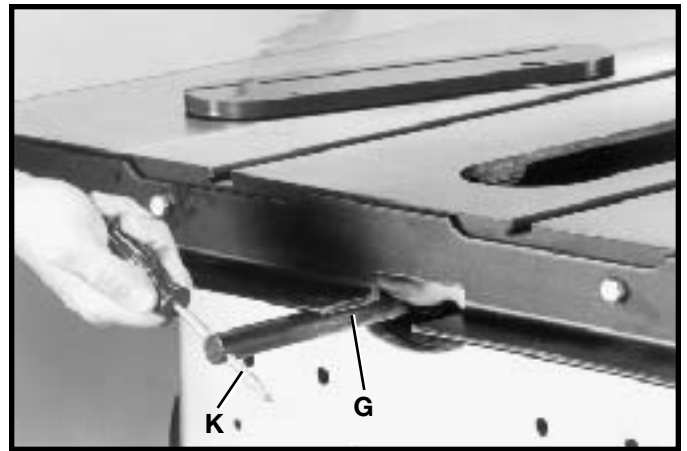

Fig. 28

7. Assemble lower bracket (L) Fig. 29, to rod (G) and snug-up with two one-inch long hex head screws (S) and lockwashers from underneath bracket (L).

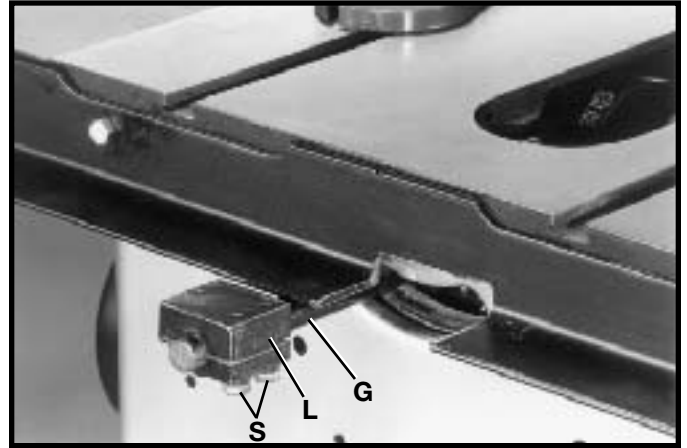

Fig. 29

8. Assemble upper splitter bracket (M) Fig. 30, to lower bracket (L) using one-inch long hex head screw (N) with lockwasher and flat washer. **NOTE:** Do not tighten screw (N) at this time.

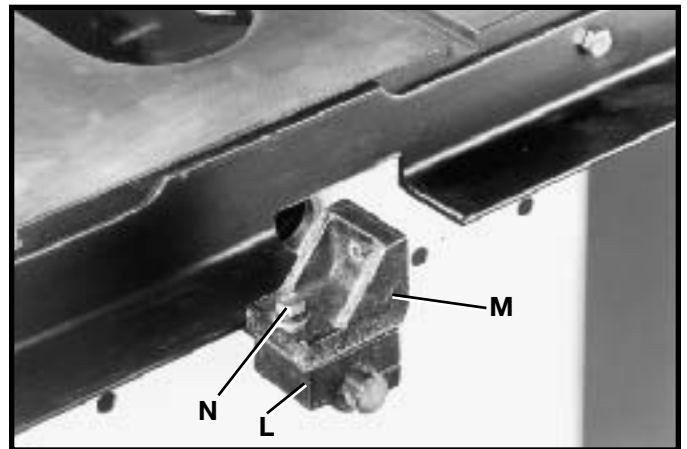

Fig. 30

9. Loosely fasten splitter and blade guard assembly (P) Fig. 31, to bracket (M) using one-inch long screw (V) and flat washer. Insert the front end of splitter (P) Fig. 32, inside the splitter mounting bracket behind splitter fastener plate and screw (C). Push splitter down as far as possible, making certain the bottom edge of splitter (P) is parallel with the table surface. Tighten screw (C).

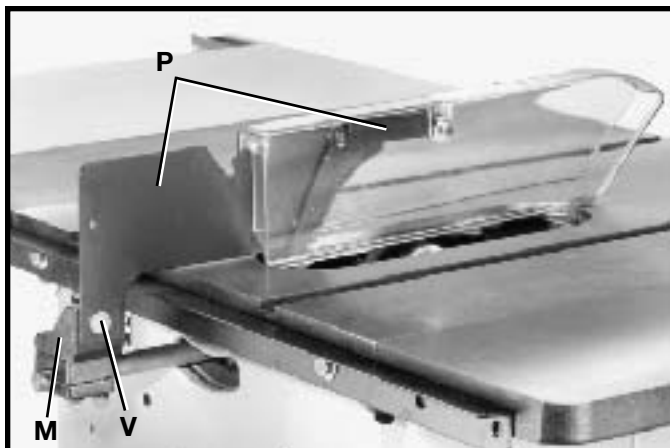

Fig. 31

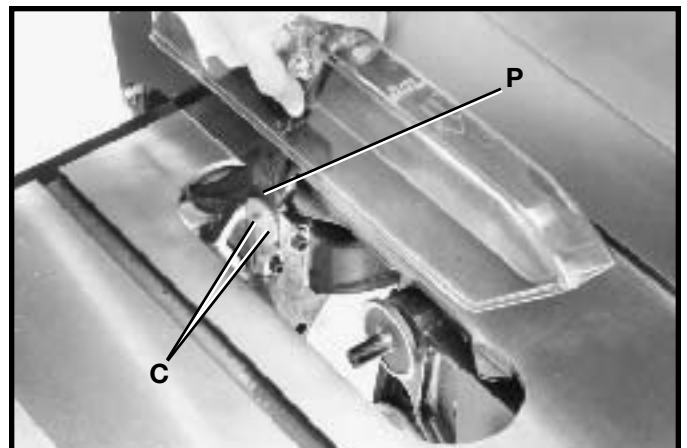

Fig. 32

10. **IMPORTANT:** The splitter (P) Fig. 33, features a notch (W) cut into the top edge. Simply raise the front of the clear blade guard (P) Fig. 33, until the rear edge of the guard slips into notch (W) of the splitter. This notch enables the blade guard to stay in the raised position and makes blade changing easier.

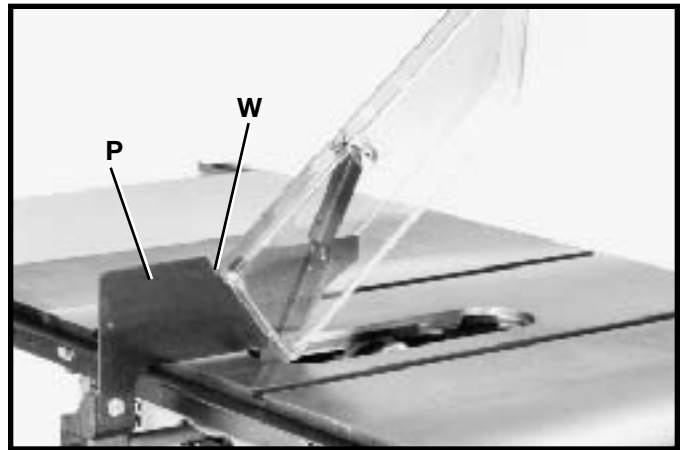

Fig. 33

11. Reassemble the saw blade, making certain the teeth are pointing down at the front of the saw table as shown in Fig. 34, and assemble the outside blade flange and arbor nut (X). With open end wrench (Y) on the flats of the arbor to keep it from turning, tighten arbor nut by turning box end wrench (Z) counterclockwise.

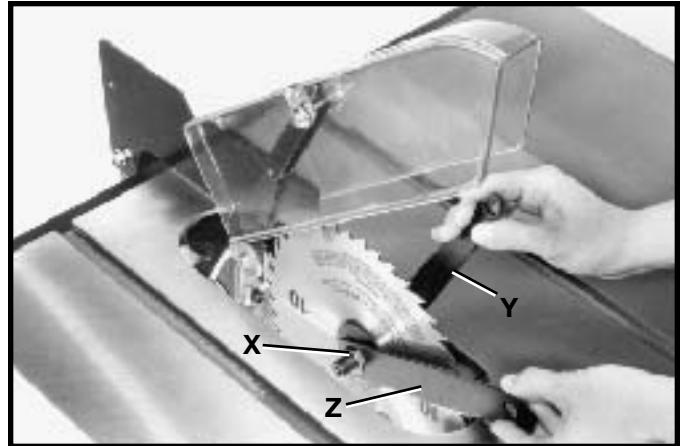

Fig. 34

12. Using a straight edge (A) Fig. 35, make certain the saw blade (B) is aligned with the splitter (P). Using a square (C) Figs. 36 and 37, make certain saw blade (B) Fig. 36, and splitter (P) Fig. 37, are 90 degrees to the table surface. Once you are certain the splitter is aligned to the saw blade and table, tighten all splitter mounting hardware (D) Fig. 37.

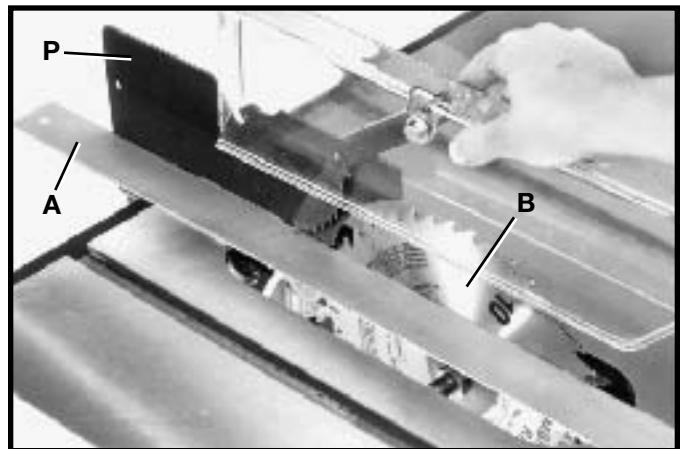

Fig. 35

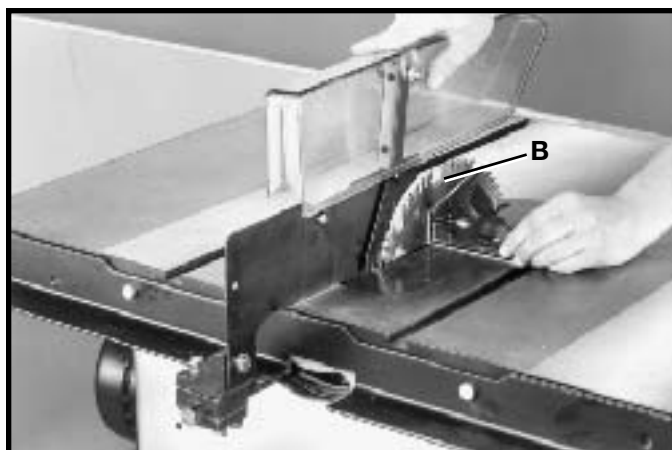

Fig. 36

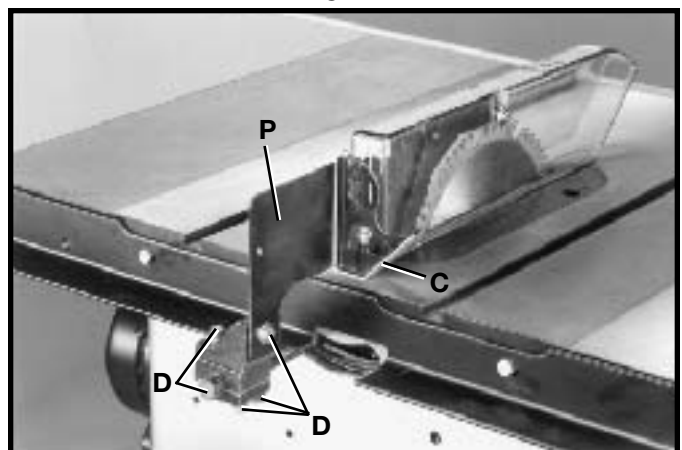

Fig. 37

13. Holding the clear blade guard, lower the saw blade and assemble the table insert (E) Fig. 38, into the opening on the saw table.

FASTENING MOTOR CORD TO SAW FRAME

1. **IMPORTANT:** Turn the blade tilting handwheel counterclockwise as far as it will go until the saw blade is in the 45 degree position.
2. **IMPORTANT:** Turn the blade raising and lowering handwheel counterclockwise until the blade is at its lowest position.
3. Fasten motor cord (A) Fig. 39 to the saw frame cross member (B), using the cable tie (C) supplied with the saw. **CAUTION:** Before tightening the cable tie, make certain that cord (A) is free of any interference from the motor or saw blade at all possible positions of the motor.
4. After the cable tie is tightened, cut off excess tail of cable tie (C) Fig. 39.

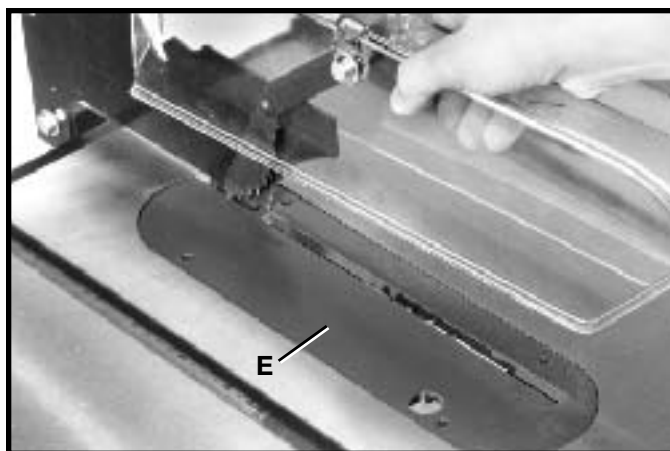

Fig. 38

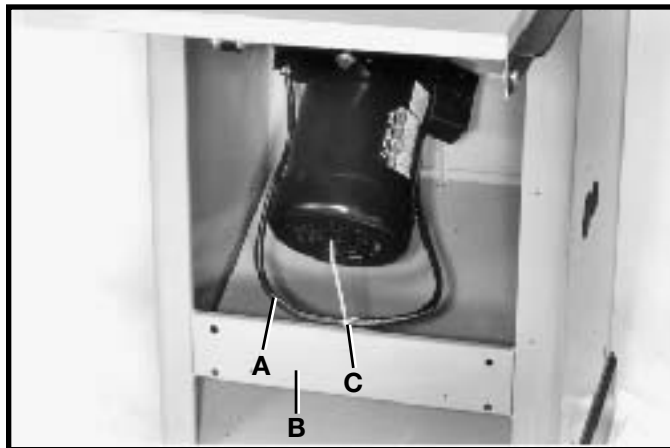

Fig. 39

ASSEMBLING MOTOR COVER

1. Remove the protective paper from the adhesive gasket material supplied with the machine and apply gasket (A) Fig. 40, to three sides of the back of the motor cover (B), as shown. **NOTE:** Do not apply gasket to the hinged side (C) of the motor cover (B).

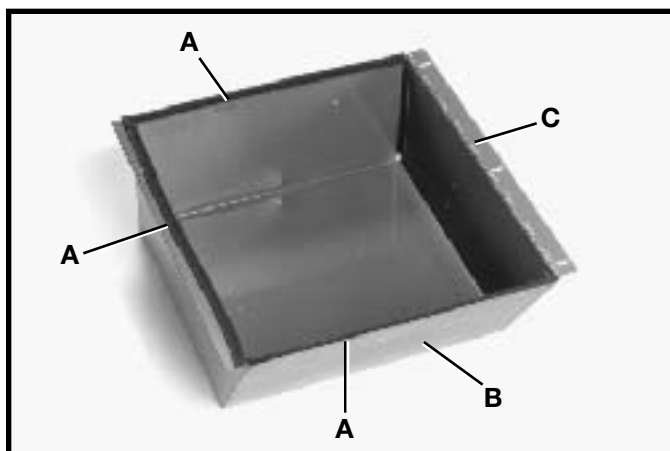

Fig. 40

2. Assemble hinged side (C) Fig. 41, of motor cover (B) to right side of saw cabinet using four 1/2 long self-tapping screws (D), as shown.

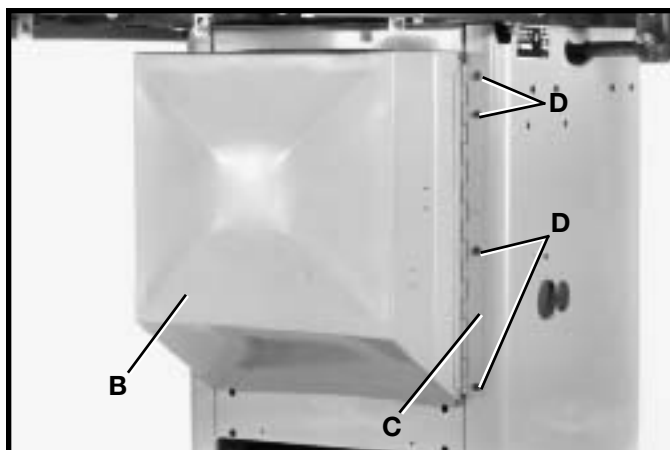

Fig. 41

3. Insert locking lever (E) Fig. 42, through the hole in left edge of motor cover (B). Assemble spacer (F) over threads of lever (E), and fasten lever to motor cover with lock nut (G).

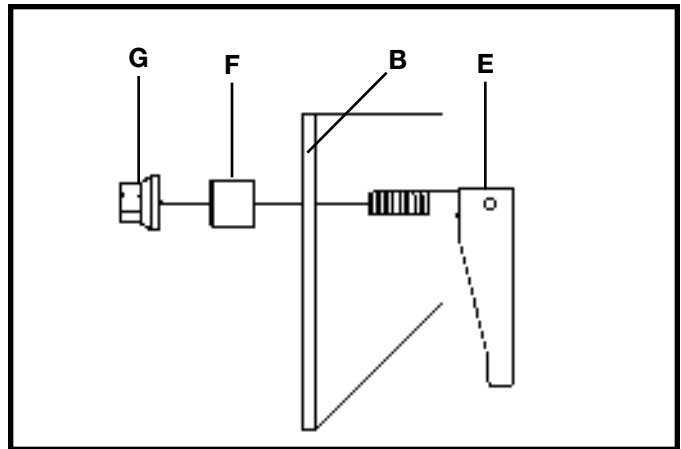

Fig. 42

4. With locking lever (E) Fig. 43, in the raised position, swing the free end of motor cover (B) toward the front of the cabinet until end (H) of locking lever enters and engages with the pre-drilled hole (J) in the cabinet.

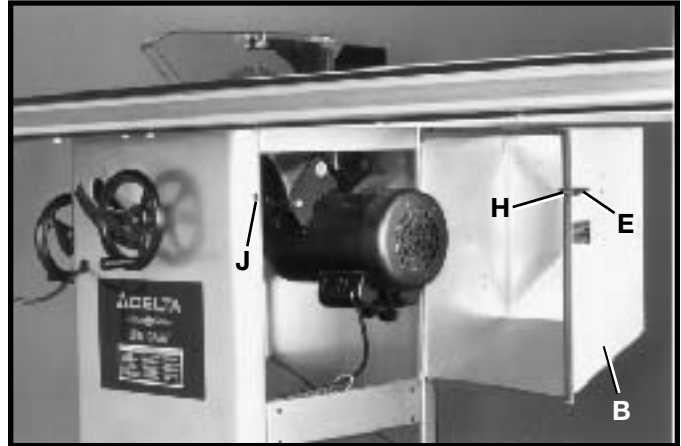

Fig. 43

5. Push down on lever (E) Fig. 44, to lock motor cover (B) in position on the saw cabinet.

6. To open motor cover (B) Fig. 44, pull up on lever (E) and swing motor cover outward.

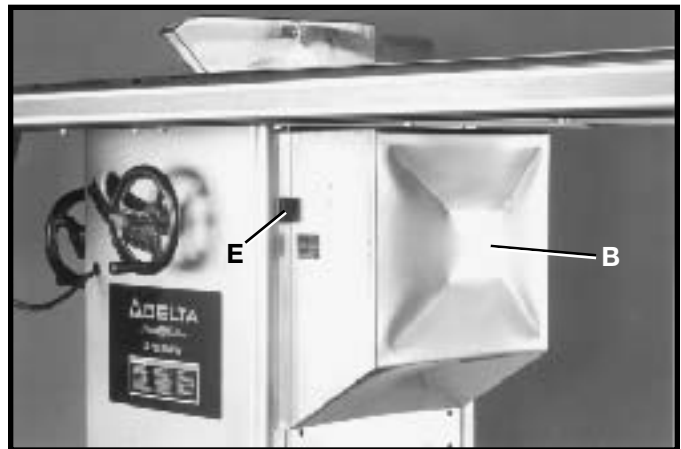

Fig. 44

ASSEMBLING MITER GAGE AND WRENCH HOLDER BRACKETS

1. Assemble the miter gage holder bracket (A) Fig. 45, and wrench holder bracket (B) to the four thru-holes on the front of the motor cover using the four 1/2 self-tapping screws supplied, two of which are shown at (C).

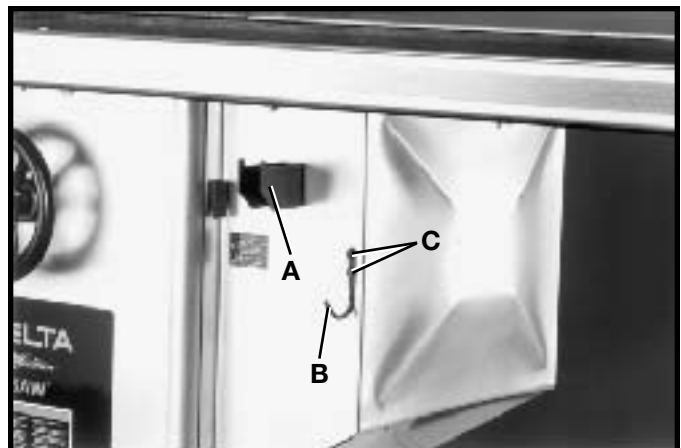

Fig. 45

2. Fig. 46, illustrates the miter gage and wrenches stored on the two holder brackets.



Fig. 46

ASSEMBLING RIP FENCE HOLDER BRACKETS

1. Assemble the rip fence holder brackets (A) and (B) Fig. 47, to the four holes located in the left hand side of the saw cabinet using four 1/2" long self-tapping screws supplied.

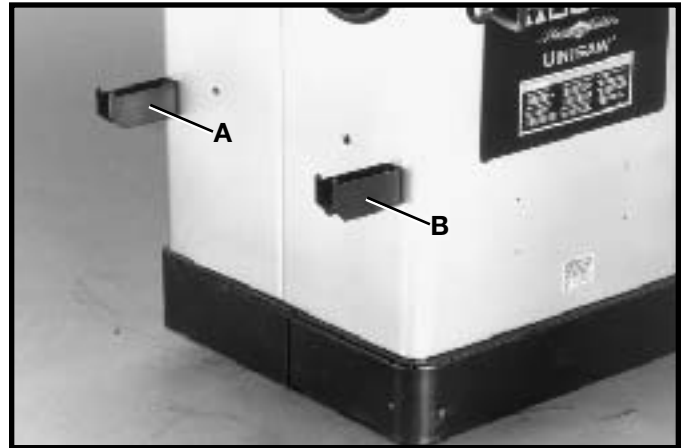

Fig. 47

2. Figure 48 illustrates the Biesemeyer® fence (C), (when not in use) positioned on the two holder brackets.

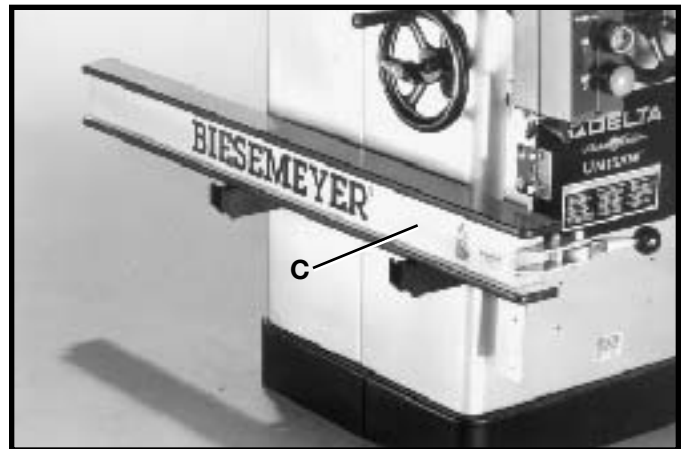

Fig. 48

ATTACHING LITERATURE HOLDER TO SAW CABINET

A literature holder (A) Fig. 49, is supplied with your saw to provide storage and protection for the machine's instruction manual, parts list, etc., so they may be readily available for reference. Two push rivets (B) are supplied to attach the literature holder to the left side of the saw cabinet, as shown.

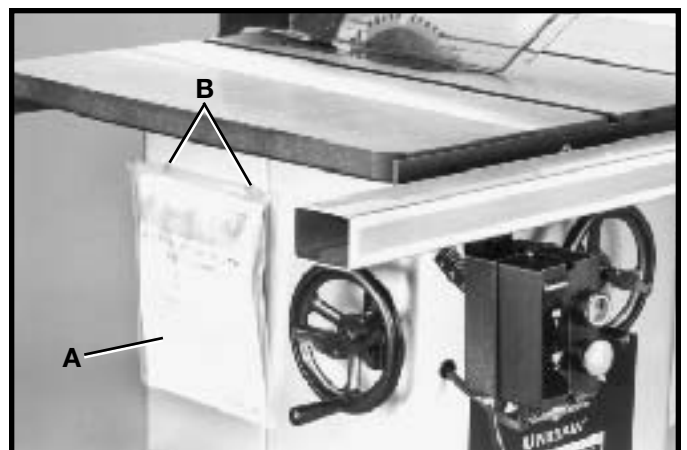

Fig. 49

CONNECTING SAW TO POWER SOURCE

GROUNDING INSTRUCTIONS

CAUTION: THIS TOOL MUST BE GROUNDED WHILE IN USE TO PROTECT THE OPERATOR FROM ELECTRIC SHOCK.

In the event of a malfunction or breakdown, grounding provides a path of least resistance for electric current to reduce the risk of electric shock. The motor is equipped with an electric cord having an equipment-grounding conductor and a grounding plug. The plug must be plugged into a matching outlet that is properly installed and grounded in accordance with all local codes and ordinances.

Do not modify the plug provided - if it will not fit the outlet, have the proper outlet installed by a qualified electrician.

Improper connection of the equipment-grounding conductor can result in risk of electric shock. The conductor with insulation having an outer surface that is green with or without yellow stripes is the equipment-grounding conductor. If repair or replacement of the electric cord or plug is necessary, do not connect the equipment grounding conductor to a live terminal.

Check with a qualified electrician or service personnel if the grounding instructions are not completely understood, or if in doubt as to whether the tool is properly grounded.

Repair or replace damaged or worn cord immediately.

SINGLE PHASE OPERATION

THREE HORSEPOWER MOTORS

The motors supplied with single phase, 3 horsepower Unisaws are designed to be operated from a 220-240 volt power system.

The single phase Unisaws are intended to be used on a circuit that has an electrical outlet that looks like the one illustrated in Fig. 50. The tool has a plug similar to the plug illustrated in Fig. 50. Make certain the tool is connected to an outlet having the same configuration as the plug (NEMA L-15R). No adapter is available, or should be used with the tool. **CAUTION: IN ALL CASES, MAKE CERTAIN THE RECEPTACLE IN QUESTION IS PROPERLY GROUNDED. IF YOU ARE NOT SURE, HAVE A CERTIFIED ELECTRICIAN CHECK THE RECEPTACLE.**

The single phase, three horsepower Unisaw motors are single voltage motors and cannot be connected to operate at a voltage other than 220-240 volts.

If you desire to operate the single phase 3 horsepower Unisaw with an extension cord, use a proper extension cord and make certain it is in good condition. When using an extension cord, be sure to use one heavy enough to carry the current your product will draw. An undersized cord will cause a drop in line voltage resulting in loss of power and overheating. Fig. 51, shows the correct size to use depending on cord length and nameplate ampere rating. If in doubt, use the next heavier gage. The smaller the gage number, the heavier the cord.

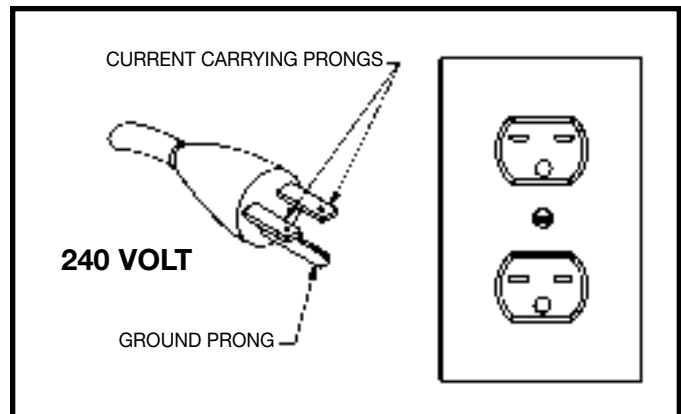

Fig. 50

TOTAL LENGTH OF CORD IN FEET	GAGE OF EXTENSION CORD TO USE
50	14 AWG
100	12 AWG
Over 100	Not recommended

Fig. 51

OPERATING CONTROLS AND ADJUSTMENTS

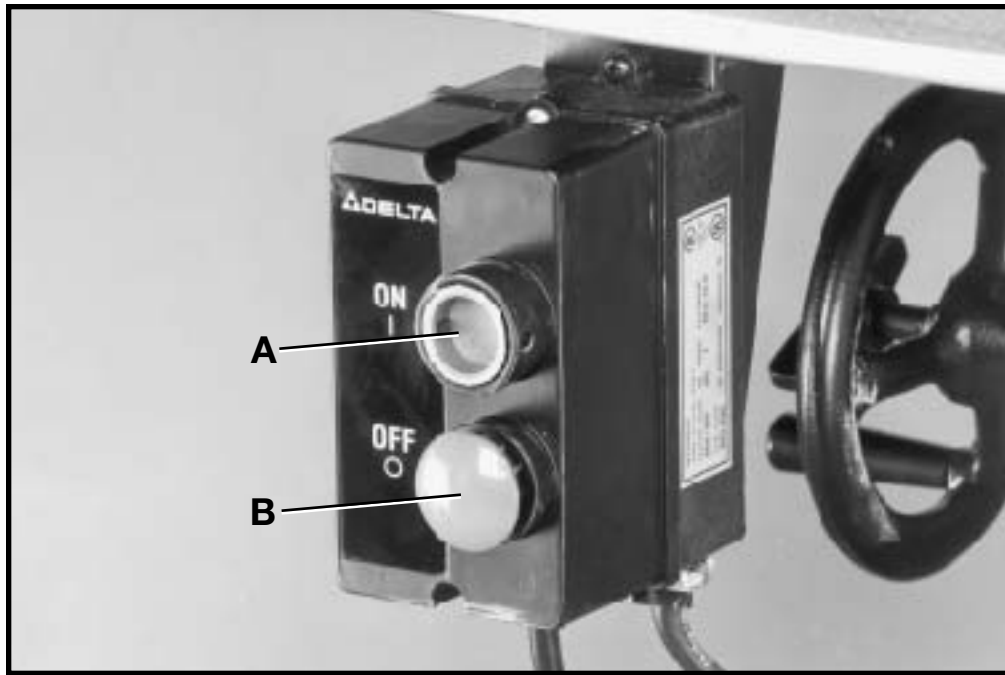

Fig. 52

STARTING AND STOPPING THE SAW

To apply power to the machine, push “ON” button (A) Fig. 52. To stop the machine, push “OFF” button (B).

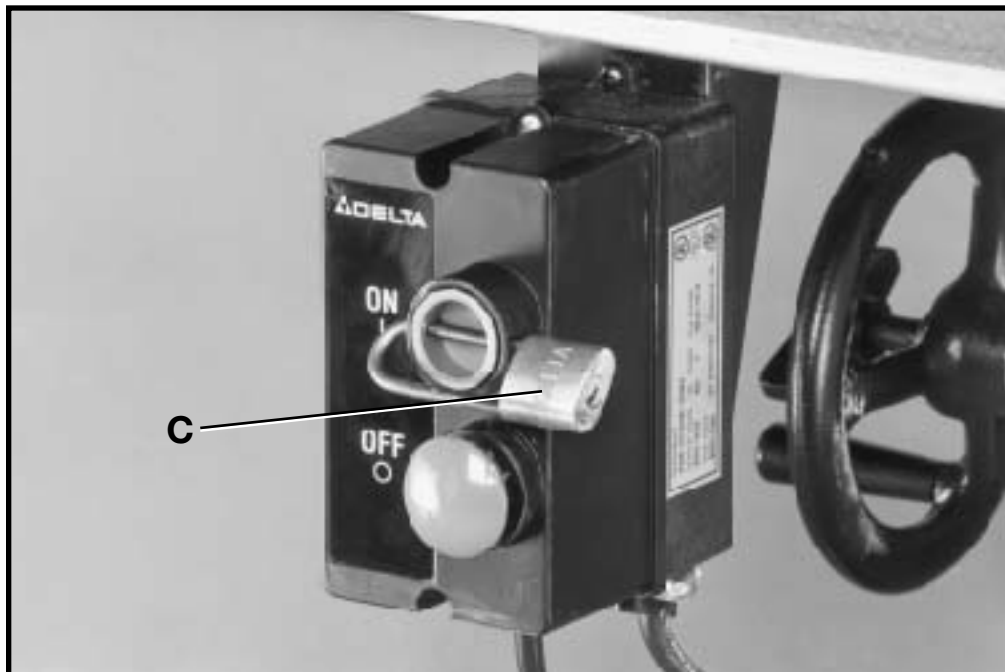

Fig. 53

LOCKING SWITCH IN THE “OFF” POSITION

IMPORTANT: We suggest that when the saw is not in use, the switch be locked in the “OFF” position using a padlock (C) Fig. 53 , through the switch plate and start button as shown.

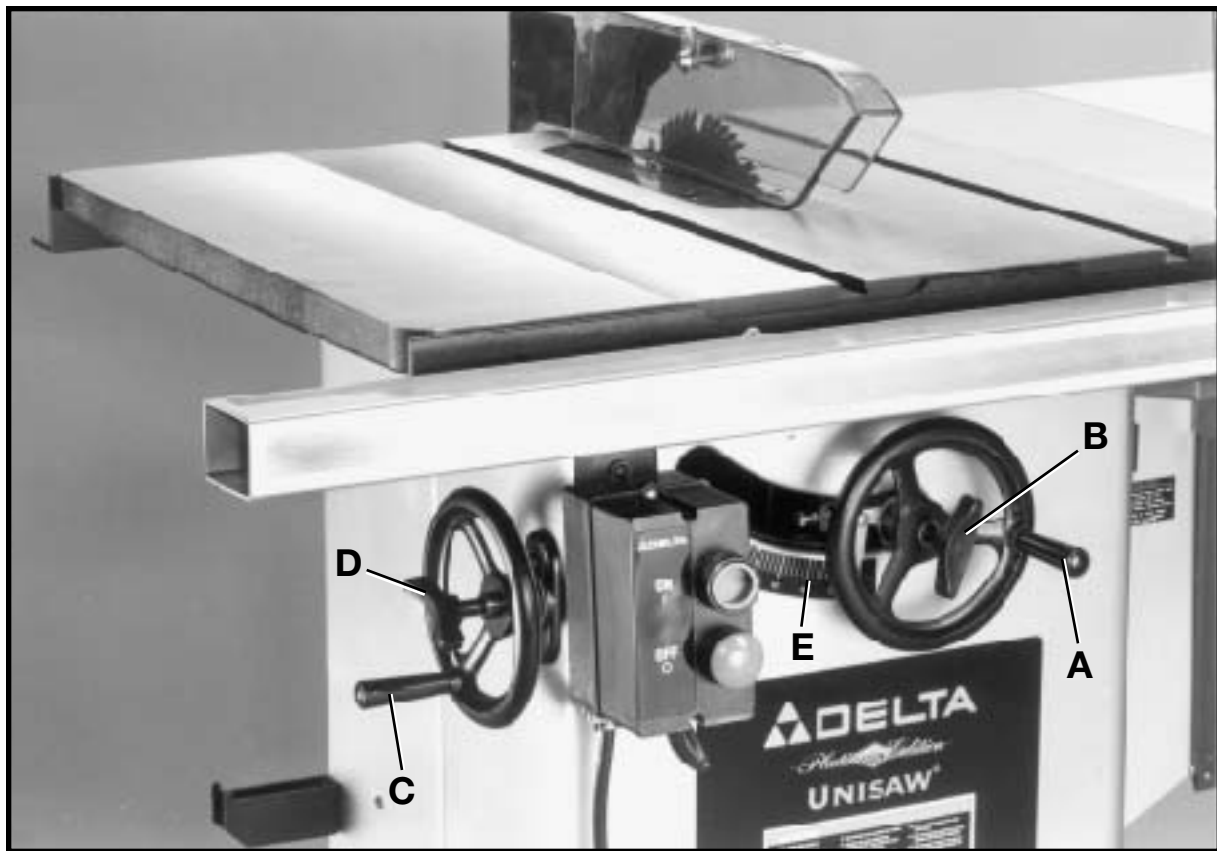

Fig. 54

BLADE RAISING MECHANISM

The saw blade is raised and lowered with the front handwheel (A) Fig. 54. With the exception of hollow ground blades, the blade should be raised 1/8 to 1/4 above the top surface of the material being cut. With hollow ground blades, the blade should be raised the maximum to provide greater clearance. To raise the saw blade, loosen lock knob (B) Fig. 54, and turn the handwheel (A), clockwise. To lower the saw blade, turn handwheel (A) counterclockwise.

The saw blade is locked at any height by turning the lock knob (B) Fig. 54, clockwise. Due to the wedge action of this locking device, only a small amount of force is required to lock the blade raising mechanism securely. Any added force merely puts unnecessary strain on the locking device. Limit stops for raising or lowering are permanently built into the mechanism and need no further adjustment.

BLADE TILTING MECHANISM

The blade tilting mechanism allows the blade to be tilted up to 45 degrees to the right.

To tilt the saw blade to the desired angle, loosen lock knob (D) Fig. 54, and turn handwheel (C). A pointer indicates the angle of tilt on scale (E), which is marked in one-degree increments. To lock the saw blade in the desired angle of tilt, tighten lock knob (D).

IMPORTANT: ALWAYS LOCK THE BLADE IN POSITION BEFORE APPLYING POWER TO THE SAW.

ADJUSTING 90 AND 45 DEGREE POSITIVE STOPS

Positive stops are provided to quickly and accurately position the blade at 90 and 45 degrees to the table. To check and adjust the positive stops, proceed as follows:

DISCONNECT SAW FROM POWER SOURCE.

1. Raise the saw blade all the way to the top and turn the blade tilting handwheel clockwise as far as it will go.
2. Using a square, check to see if the blade is 90 degrees to the table. If an adjustment is necessary, turn the blade tilting handwheel counterclockwise. Loosen locknut (A) Fig. 55, and tighten or loosen adjusting screw (B) until head of screw (B) contacts casting on front trunnion when the blade is at 90 degrees to the table. Then tighten locknut (A).
3. Check to see if the tilt indicator pointer points to the zero mark on the scale. Adjust if necessary.
4. Turn the blade tilting handwheel counterclockwise as far as it will go. Using a square, check to see if the blade is at 45 degrees to the table. If an adjustment is necessary, turn the blade tilting handwheel clockwise until the adjusting screw (D) Fig. 55, and locknut (C) are in view, in the opening in the front of the saw cabinet, as shown. Loosen locknut (C) and tighten or loosen adjusting screw (D) until head of screw (D) contacts casting on front trunnion when the blade is at 45 degrees to the table.

ADJUSTING TABLE

The saw table has been aligned at the factory so the miter gage slots are parallel to the saw blade; however, it is recommended to check the alignment before initial operation as follows:

1. **DISCONNECT THE MACHINE FROM THE POWER SOURCE.**
2. Place a combination square (A) Fig. 57, on the table with one edge of the square in the miter gage slot, as shown, and adjust the square so the rule just touches one of the teeth on the saw blade at the forward position, as shown in Fig. 57. Lock the square in this position.
3. Rotate the saw blade so that the same tooth you used in **STEP 2** is in the rear position, as shown in Fig. 58, and check this distance. Both the front and rear measurements should be identical.
4. If an adjustment is necessary, loosen the four screws that hold the table to the saw cabinet.
5. Shift the table until a position is found which brings the saw blade in the center of the table insert slot, and parallel to the miter gage slot.
6. Tighten the four screws that were loosened in

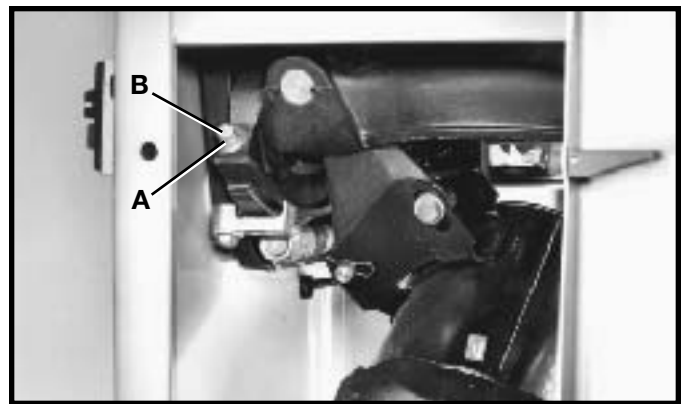

Fig. 55

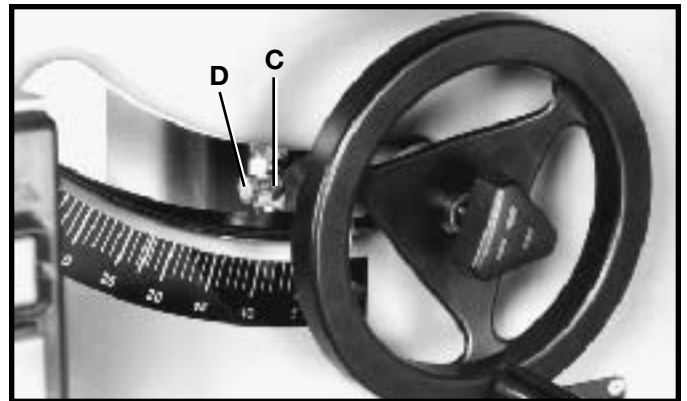

Fig. 56

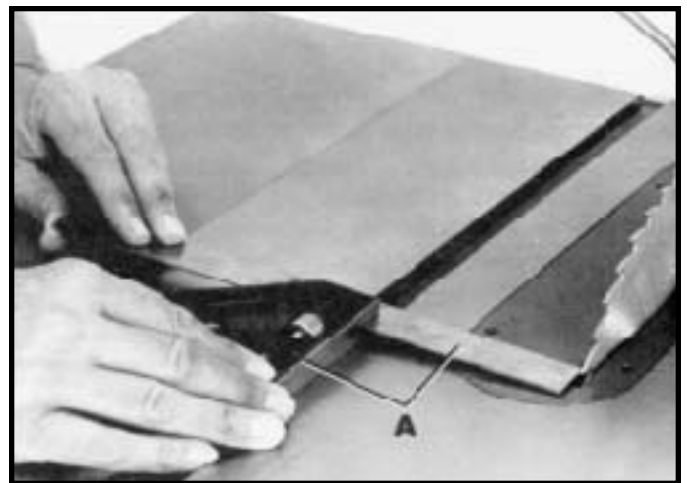

Fig. 57

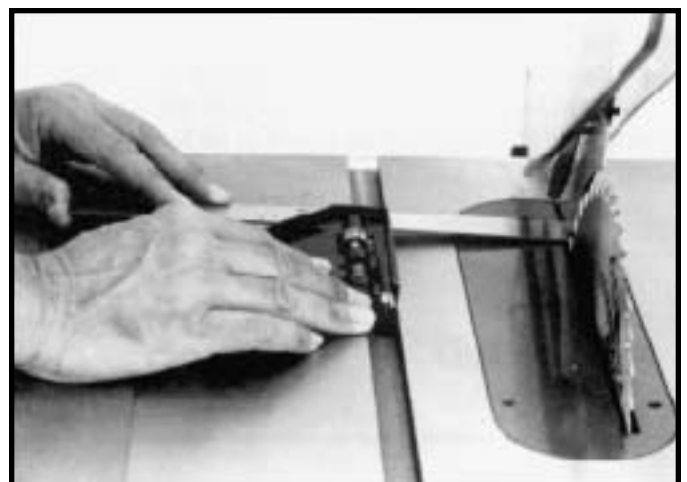

Fig. 58

FENCE OPERATION

IMPORTANT: Before operating fence, make sure the fence is adjusted parallel to the miter gage slot, as explained later on in this manual.

1. To move the fence along the guide rail, simply lift up clamp lever (A) as shown in Fig. 59, slide fence to desired position on rail, and push down on clamp lever (A) as shown in Fig. 60, to lock fence in position. **NOTE:** A magnet (E) Fig. 60, is provided to hold clamp handle (A) in the up position when moving the fence.

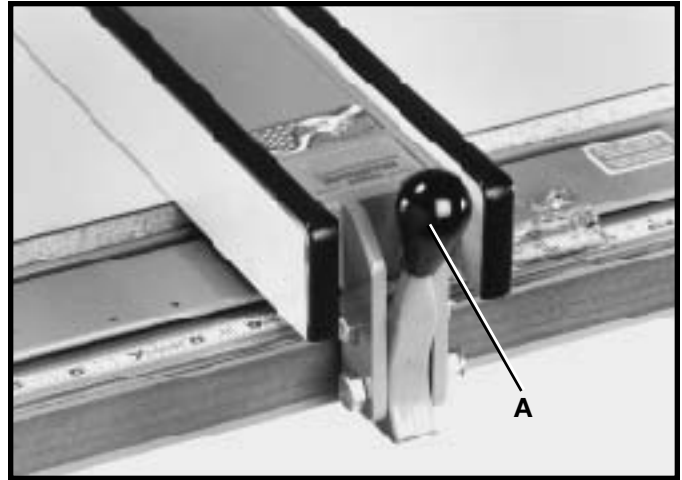

Fig. 59

2. The distance the fence is positioned away from the blade is indicated by the witness line (C) Fig. 61, located on the cursor (D). If it is necessary to adjust the cursor (D), make a test cut with the fence locked in position. Measure the width of the finished cut and adjust the cursor (D) by loosening the two screws (E), adjusting the cursor (D) until the witness line (C) is aligned with the same marking on the scale as the finished cut. Then tighten the two screws (E).

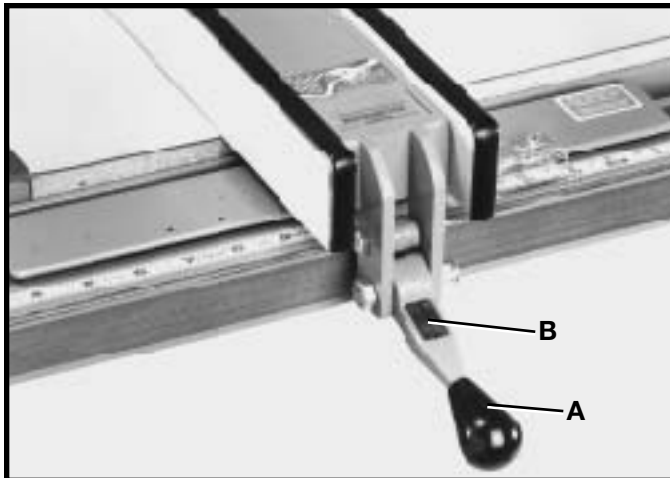

Fig. 60

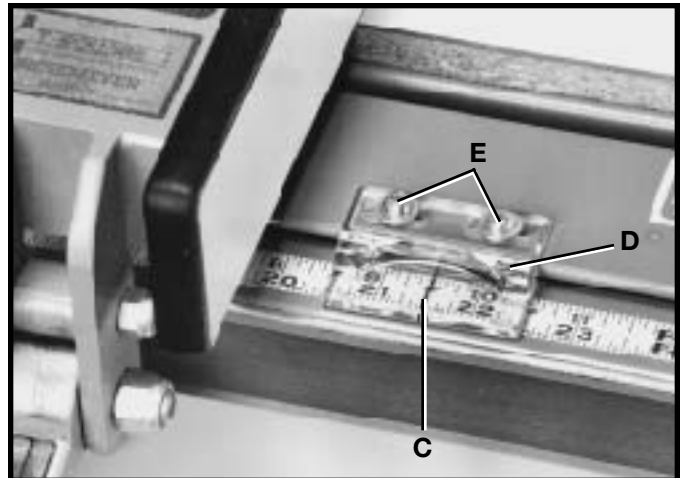

Fig. 61

FENCE LUBRICATION

1. Apply paste wax to fence and guide tube sliding surfaces weekly. Also, saw table and extension table surface should be waxed often.

2. Apply grease to cam lock (A) Fig. 62, and cam foot (B) occasionally to prevent wear.

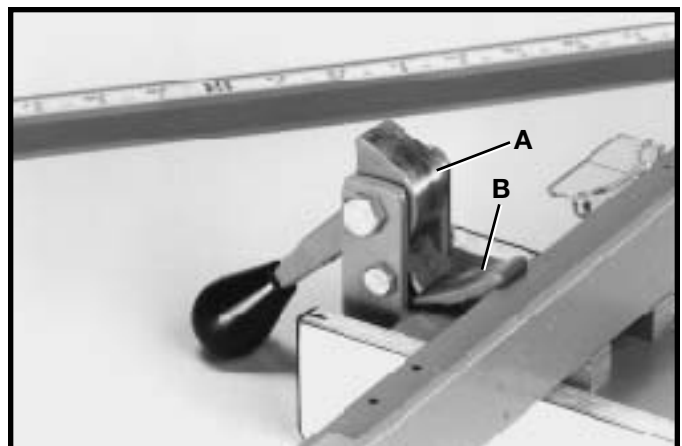

Fig. 62

ADJUSTING FENCE PARALLEL TO MITER GAGE SLOTS

NOTE: Delta table saws have been aligned at the factory so that the miter gage slots in the table are parallel with the saw blade. It is recommended, however, to check and make certain this alignment is correct before adjusting the fence parallel to the miter gage slot as follows:

The fence (A) Fig. 63, must be adjusted so it is parallel to the miter gage slots (B). To check and adjust, move fence (A) until the bottom edge of the fence is in line with the edge of one of the miter gage slots as shown, and push down on the fence clamping lever (C). Check to see if the fence (A) is parallel to the miter gage slot the entire length of the table. If an adjustment must be made, lift up fence locking lever (C) and raise fence up off the guide tube, as shown in Fig. 64. Slightly tighten or loosen one of the two adjusting screws (D) or (E) Fig. 28, using a 3/16 allen wrench (F), not supplied. Replace the fence on the guide tube and check again to see if the edge of the fence is parallel with the miter gage slot the entire length of the slot. Repeat this adjustment until you are sure the fence is parallel with the miter gage slot. **IMPORTANT: VERY LITTLE MOVEMENT OF SCREWS (D) AND (E) IS NECESSARY TO ADJUST THE FENCE PARALLEL WITH THE MITER GAGE SLOT.**

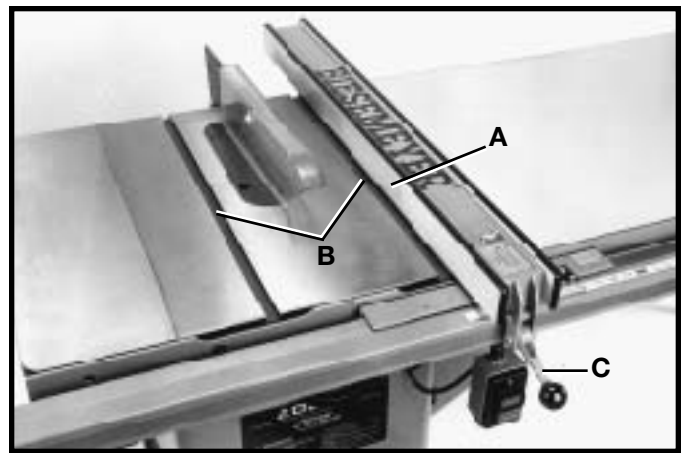

Fig. 63

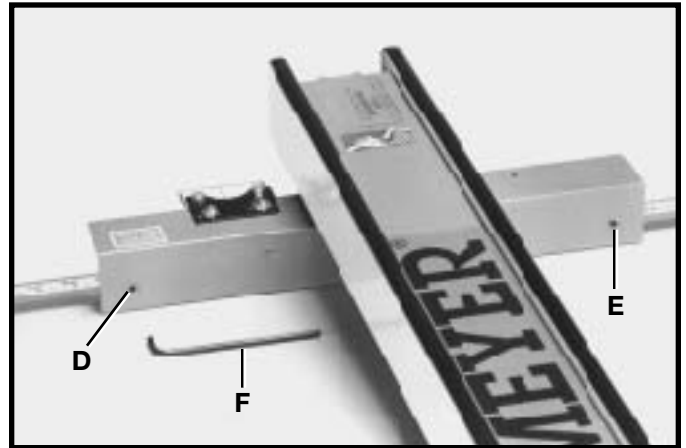

Fig. 64

ADJUSTING CLAMPING ACTION OF FENCE LOCKING HANDLE

When the fence locking handle (A) is pushed to the down position, as shown in Fig. 65, the fence assembly (B) should be completely clamped to the guide tube (C). If the fence assembly (B) is not completely clamped to the guide tube (C) when the handle (A) is pushed down, as shown in Fig. 65, lift up handle (A) and raise fence assembly (B) up off the guide tube (C). Slightly tighten the two adjusting screws (D) and (E) Fig. 66, using the 3/16 allen wrench (F) not supplied. **Adjusting screws (D) and (E) Fig. 66, should be tightened an equal amount.** Replace fence onto the guide tube and re-check to see if the fence assembly (B) Fig. 65, is completely tightened to the guide tube (C) with the locking handle (A) pushed down. Adjust further if necessary. **IMPORTANT: AFTER ADJUSTING THE CLAMPING ACTION OF THE FENCE LOCKING HANDLE, CHECK TO SEE IF THE FENCE IS PARALLEL TO THE MITER GAGE SLOT AND ADJUST IF NECESSARY.**

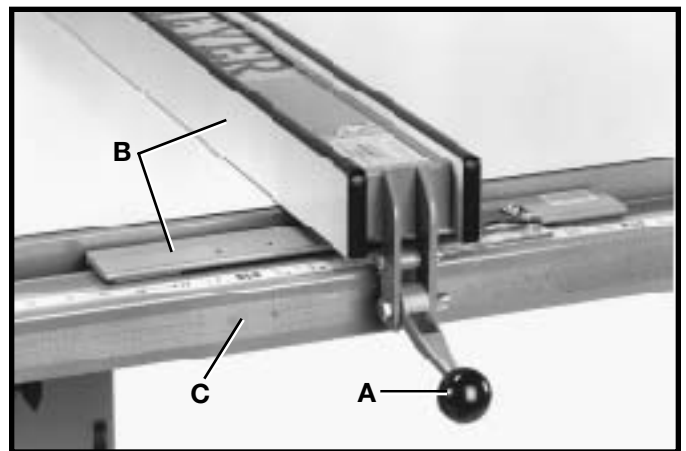

Fig. 65

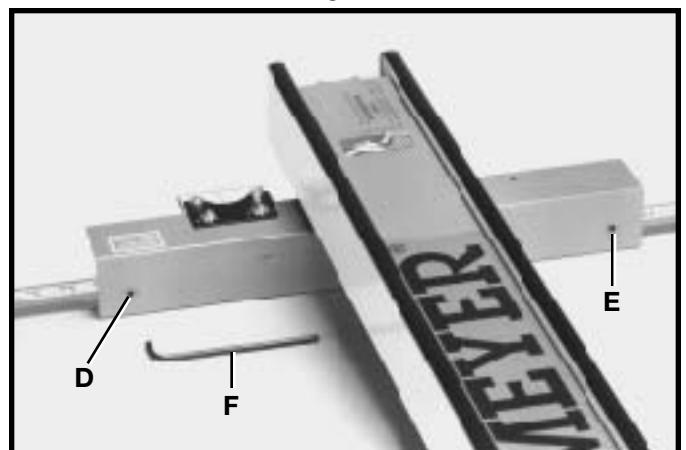

Fig. 66

ADJUSTING TABLE INSERT

Place a straight edge (B) across the table at both ends of the table insert as shown in Fig. 67. The table insert (A) should always be level with the table. If an adjustment is necessary, turn the adjusting screws (C), as needed. Four adjusting screws (C) are supplied.

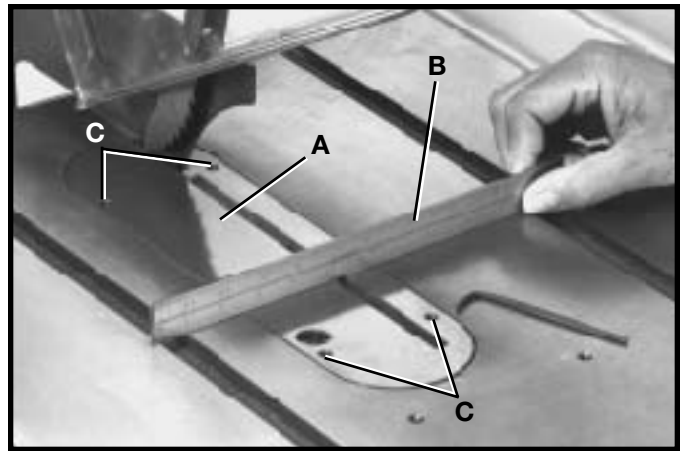

Fig. 67

MITER GAGE OPERATION AND ADJUSTMENT

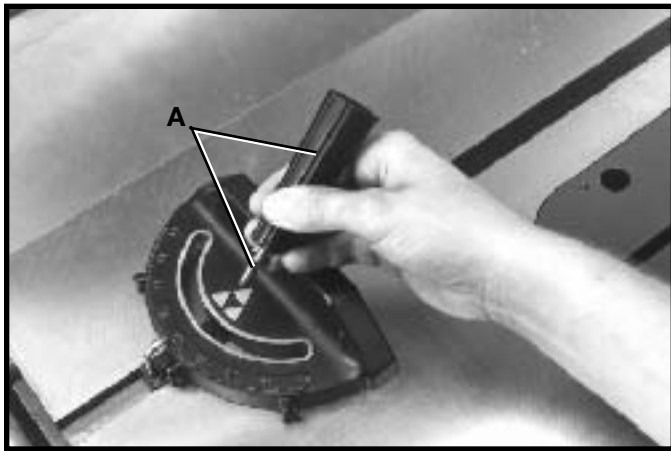

Fig. 68

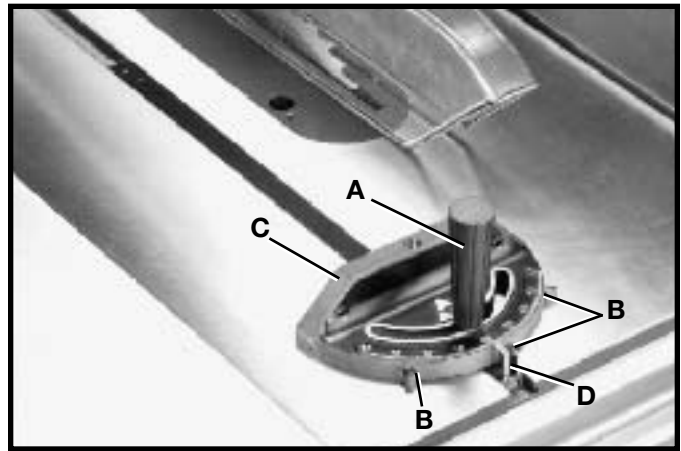

Fig. 69

Insert the miter gage bar into the miter gage slot and assemble the washer and lock handle (A) Fig. 68, to the miter gage bar as shown.

The miter gage is equipped with adjustable index stops at 90 degrees and 45 degrees right and left. Adjustment to the index stops can be made by tightening or loosening the three adjusting screws (B) Fig. 69.

To rotate the miter gage, loosen lock knob (A) Fig. 69, and move the body of the miter gage (C), to the desired angle.

The miter gage body will stop at 90 degrees and 45 degrees both right and left. To rotate the miter gage body past these points, the stop link (D) Fig. 69, must be moved up and out of the way.

The miter gage is equipped with a special washer (E) Fig. 70, and flat head screw (F), which are to be assembled to the end of the miter gage bar.

The head of the miter gage pivots on a special tapered screw (G) that fastens the head to the miter gage bar. If the miter gage head does not pivot freely, or pivots too freely, it can be adjusted by loosening set screw (H) Fig. 70, and turning the screw (G) in or out. Be certain to tighten screw (H) after adjustment is made.

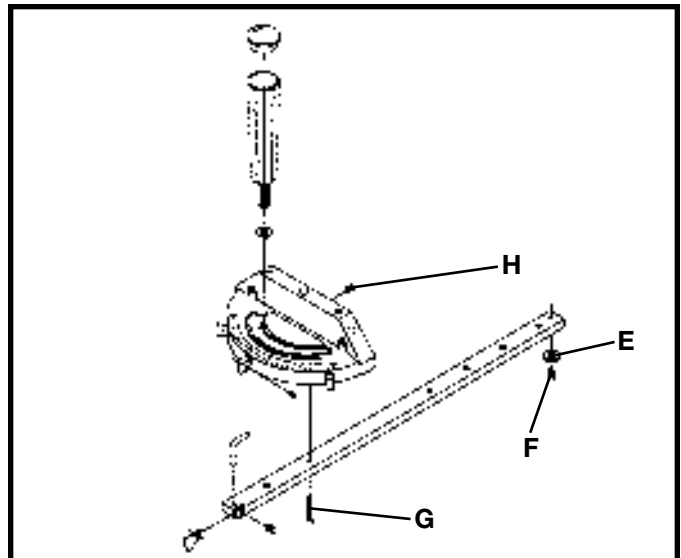

Fig. 70

MAINTENANCE

CHANGING THE SAW BLADE

1. **MAKE CERTAIN THE MACHINE IS DISCONNECTED FROM THE POWER SOURCE.**
2. **NOTE:** Two wrenches are supplied with the saw for changing the saw blade; a box end wrench and open end wrench.
3. Remove table insert and raise saw blade to its maximum height.

4. Place the open end wrench (B) Fig. 71, on the flats of the saw arbor to keep the arbor from turning, and using wrench (A), turn the arbor nut (C) toward the front of the saw. Remove arbor nut, blade flange and saw blade.

5. Assemble the new blade, making certain the teeth are pointing down at the front of the saw table and assemble outside blade flange and arbor nut. With wrench (B) Fig. 71, on the flats of the arbor to keep it from turning, tighten arbor nut by turning wrench (A) counterclockwise.

6. Replace table insert.

NOTE: Use only 10 saw blades with 5/8 arbor holes.

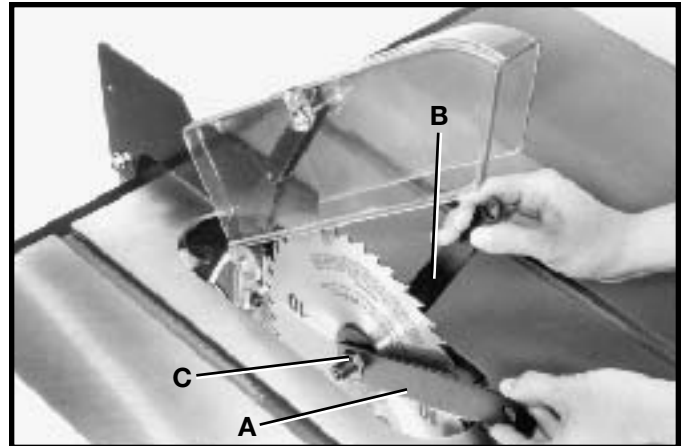

Fig. 71

REPLACING BELTS AND ADJUSTING BELT TENSION

1. **DISCONNECT THE MACHINE FROM THE POWER SOURCE.**

2. Open motor cover door to gain access to the motor.

3. Place a block of wood (C) Fig. 72, between the motor and saw cabinet as shown. **NOTE:** It may be necessary to raise the saw arbor in order to insert the wooden block. Lower the saw arbor until the motor contacts the wood.

4. Loosen bolt (D) Fig. 72, and continue to lower the saw arbor until all tension is removed from the belts (E). Tighten bolt (D).

5. Raise the saw arbor slightly and remove the block of wood (C) Fig. 72.

6. Lower the saw arbor. Remove the belts (E) Fig. 72, one at a time from the motor pulley.

7. Remove the belts (E) Fig. 73, one at a time from the arbor pulley (F).

8. Assemble the three new belts, one at a time in the grooves of the arbor pulley (F) Fig. 73, and onto the motor pulley.

9. When the new belts are assembled on the arbor pulley (F) Fig. 73 and the motor pulley, loosen screw (D) Fig. 72, and carefully let the motor rest on the belts.

10. Correct belt tension is when there is approximately 1/4 deflection in the center span of the pulleys, using light finger pressure. After tension is applied, tighten

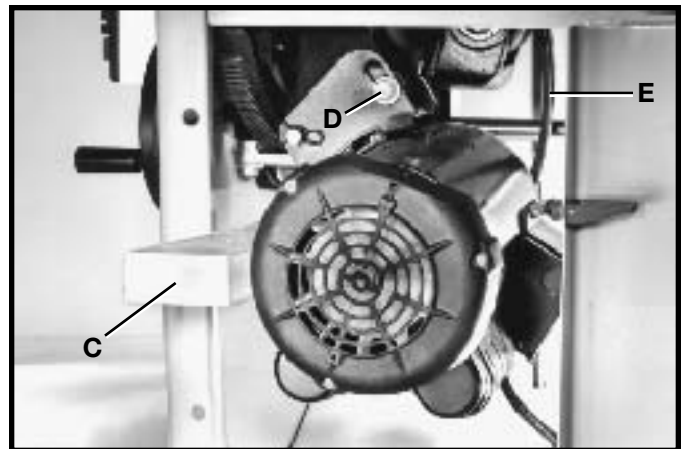

Fig. 72

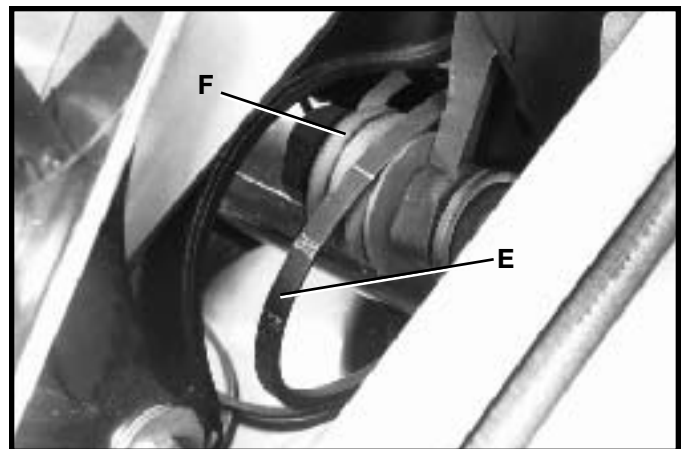

Fig. 73

OPERATION

Common sawing operations include ripping and cross-cutting plus a few other standard operations of a fundamental nature. As with all power tools, there is a certain amount of hazard involved with the operation and use of the tool. Using the tool with the respect and caution demanded as far as safety precautions are concerned, will considerably lessen the possibility of personal injury. However, if normal safety precautions are overlooked or completely ignored, personal injury to the operator can result. The following information describes the safe and proper method for performing the most common sawing operations.

NOTE: THE USE OF ATTACHMENTS AND ACCESSORIES NOT RECOMMENDED BY DELTA MAY RESULT IN THE RISK OF INJURY TO PERSONS.

CROSS-CUTTING

Cross-cutting requires the use of the miter gage to position and guide the work. Place the work against the miter gage and advance both the gage and work toward the saw blade, as shown in Fig. 74. The miter gage may be used in either table slot. When bevel cutting (blade tilted), use the left miter gage slot so that the blade tilts away from the miter gage and your hands.

Start the cut slowly and hold the work firmly against the miter gage and the table. One of the rules in running a saw is that you never hang onto or touch a free piece of work. Hold the supported piece, not the free piece that is cut off. The feed in cross-cutting continues until the work is cut in two, and the miter gage and work are pulled back to the starting point. Before pulling the work back, it is good practice to give the work a little sideways shift to move the work slightly away from the saw blade. Never pick up any short length of free work from the table while the saw is running. A smart operator never touches a cut-off piece unless it is at least a foot long.

For added safety and convenience the miter gage can be fitted with an auxiliary wood-facing (C), as shown in Fig. 75, that should be at least 1 inch higher than the maximum depth of cut, and should extend out 12 inches or more to one side or the other depending on which miter gage slot is being used. This auxiliary wood-facing (C) can be fastened to the front of the miter gage by using two wood screws (A) through the holes provided in the miter gage body and into the wood-facing.

WARNING: NEVER USE THE FENCE AS A CUT-OFF GAGE WHEN CROSS-CUTTING.

When cross-cutting a number of pieces to the same length, a block of wood (B), can be clamped to the fence and used as a cut-off gage as shown in Fig. 76. It is important that this block of wood always be positioned in front of the saw blade as shown. Once the cut-off length is determined, secure the fence and use the miter gage to feed the work into the cut.



Fig. 74

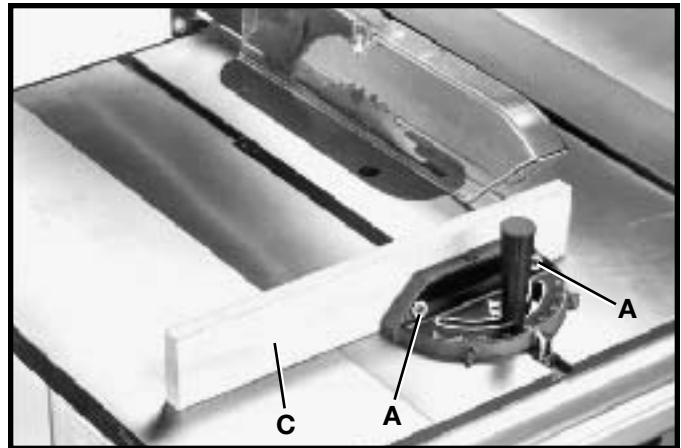

Fig. 75

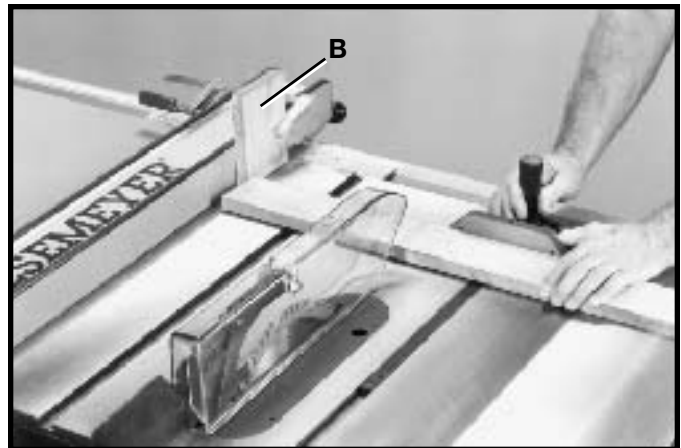

Fig. 76

This block of wood allows the cut-off piece to move freely along the table surface without binding between the fence and the saw blade, thereby lessening the possibility of kickback and injury to the operator.

RIPPING

Ripping is the operation of making a lengthwise cut through a board, as shown in Fig. 77, and the rip fence (A) is used to position and guide the work. One edge of the work rides against the rip fence while the flat side of the board rests on the table. Since the work is pushed along the fence, it must have a straight edge and make solid contact with the table. The saw guard must be used. The guard has anti-kickback fingers to prevent kickback and a splitter to prevent the saw kerf from closing behind the blade.

Start the motor and advance the work holding it down and against the fence. Never stand in the line of the saw cut when ripping. Hold the work with both hands and push it along the fence and into the saw blade as shown in Fig. 77. The work can then be fed through the saw blade with one or two hands. After the work is beyond the saw blade and anti-kickback fingers, the hand is removed from the work. When this is done the work will either stay on the table, tilt up slightly and be caught by the rear end of the guard or slide off the table to the floor. Alternately, the feed can continue to the end of the table, after which the work is lifted and brought back along the outside edge of the fence. The cut-off stock remains on the table and is not touched with the hands until the saw blade is stopped, unless it is a large piece allowing safe removal. When ripping boards longer than three feet, it is recommended that a work support be used at the rear of the saw to keep the workpiece from falling off the saw table.

If the ripped work is less than 4 inches wide, a push stick should always be used to complete the feed, as shown in Fig. 78. The push stick can easily be made from scrap material as explained in the section **“CONSTRUCTING A PUSH STICK.”** When ripping stock 2 inches or narrower, assemble an auxiliary wood facing to the fence, as explained in the section **“USING AUXILIARY WOOD FACING ON RIP FENCE”** and use a push stick.



Fig. 77

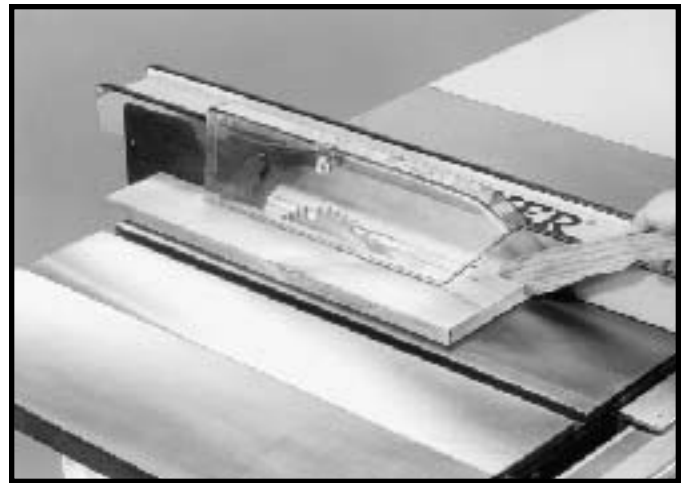

Fig. 78

USING ACCESSORY MOULDING CUTTERHEAD

Moulding is cutting a shape on the edge or face of the work. Cutting mouldings with a moulding cutterhead in the circular saw is a fast, safe and clean operation. The many different knife shapes available make it possible for the operator to produce almost any kind of mouldings, such as various styles of corner moulds, picture frames, table edges, etc.

The moulding head consists of a cutterhead in which can be mounted various shapes of steel knives, as shown in Fig. 79. Each of the three knives in a set is fitted into a groove in the cutterhead and securely clamped with a screw. The knife grooves should be kept free of sawdust which would prevent the cutter from

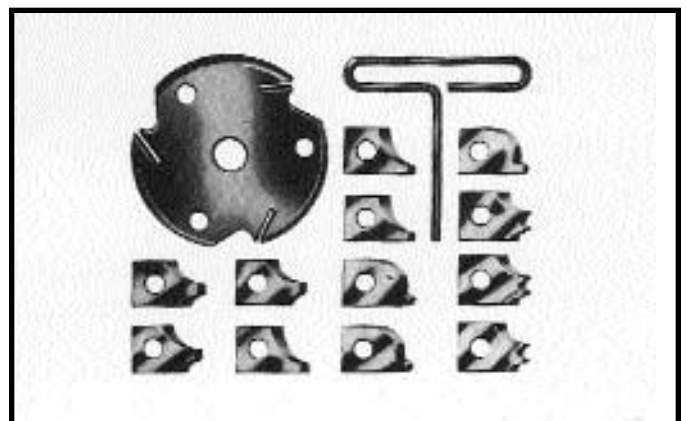

Fig. 79

IMPORTANT: For certain cutting operations such as dadoing and moulding where you are not cutting completely through the workpiece, the blade guard and splitter assembly cannot be used. Simply loosen screws (G) and (H) Fig. 80. Lift up and swing blade guard and splitter assembly (W) Fig. 81, to the rear of the saw as shown in Fig. 81. **CAUTION:** Always return and fasten the blade guard and splitter assembly to its proper operating position for normal thru-sawing operations.

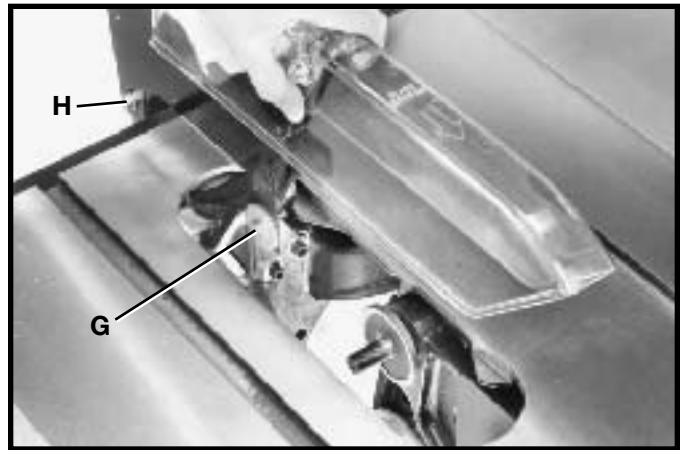

Fig. 80

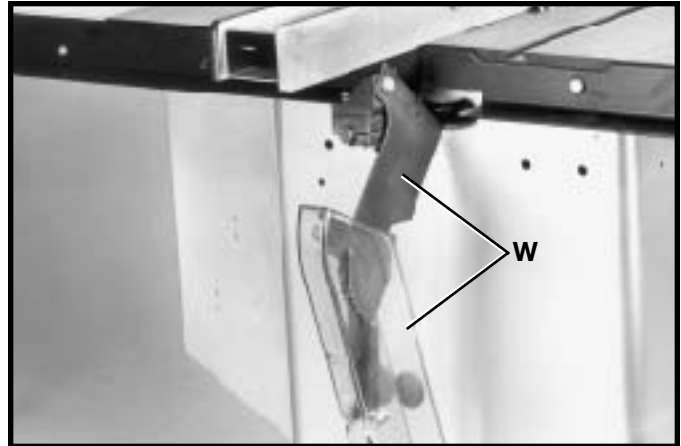

Fig. 81

The moulding cutterhead (A) Fig. 82, is assembled to the saw arbor as shown. Also, the accessory moulding cutterhead table insert (B), must be used in place of the standard table insert.

It is necessary when using the moulding cutterhead to add wood-facing (C) to the face of the rip fence, as shown in Fig. 83. The wood-facing is attached to the fence with two clamps, as shown. 3/4 inch stock is suitable for most work although an occasional job may require 1 inch facing.

Position the wood-facing over the cutterhead with the cutterhead below the surface of the table. Turn the saw on and raise the cutterhead. The cutterhead will cut its own groove in the wood-facing. Fig. 83, shows a typical moulding operation. **NEVER USE MOULDING CUTTER-HEAD IN A BEVEL POSITION.**



Fig. 82

IMPORTANT: NEVER RUN THE STOCK BETWEEN THE FENCE AND THE MOULDING CUTTERHEAD AS IRREGULAR SHAPED WOOD WILL CAUSE KICKBACK.

When moulding end grain, the miter gage is used. The feed should be slowed up at the end of the cut to prevent splintering.

In all cuts, attention should be given the grain, making the cut in the same direction as the grain whenever possible.

ALWAYS INSTALL BLADE GUARD AFTER OPERA-



Fig. 83

USING ACCESSORY DADO HEAD

IMPORTANT: THE BLADE GUARD AND SPLITTER ASSEMBLY CANNOT BE USED WHEN DADOING OR MOULDING AND MUST BE REMOVED OR SWUNG TO THE REAR OF THE SAW AS DESCRIBED ON PAGE 28 OF THIS MANUAL.

Dadoing is cutting a rabbet or wide groove into the work. Most dado head sets are made up of two outside saws and four or five inside cutters, as shown in Fig. 84. Various combinations of saws and cutters are used to cut grooves from 1/8" to 13/16" for use in shelving, making joints, tenoning, grooving, etc. The cutters are heavily swaged and must be arranged so that this heavy portion falls in the gullets of the outside saws, as shown in Fig. 85. The saw and cutter overlap is shown in Fig. 86, (A) being the outside saw, (B) an inside cutter, and (C) a paper washer or washers which can be used as needed to control the exact width of groove. A 1/4" groove is cut by using the two outside saws. The teeth of the saws should be positioned so that the raker on one saw is beside the cutting teeth on the other saw.

The dado head set (D) Fig. 87, is assembled to the saw arbor as shown. **IMPORTANT:** The blade guard and splitter assembly cannot be used when dadoing and must be removed or swung to the rear of the saw as explained previously in this manual. Auxiliary jigs, fixtures, push sticks and feather boards should also be used. Also, the accessory dado head table insert (E) Fig. 87, must be used in place of the standard table insert.

Fig. 88, shows a typical dado operation using the miter gage as a guide.

WARNING: NEVER USE THE DADO HEAD IN A BEVEL POSITION.

IMPORTANT: ALWAYS INSTALL BLADE GUARD AFTER OPERATION IS COMPLETED.

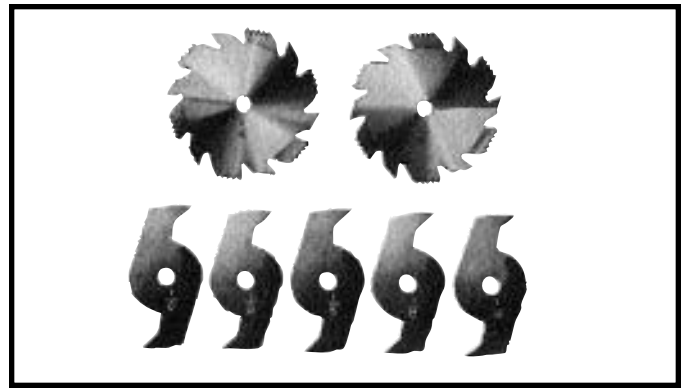

Fig. 84

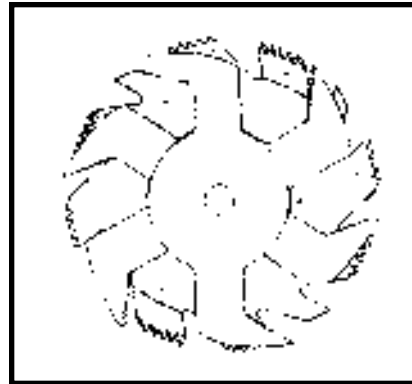

Fig. 85

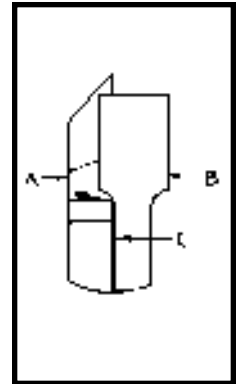

Fig. 86

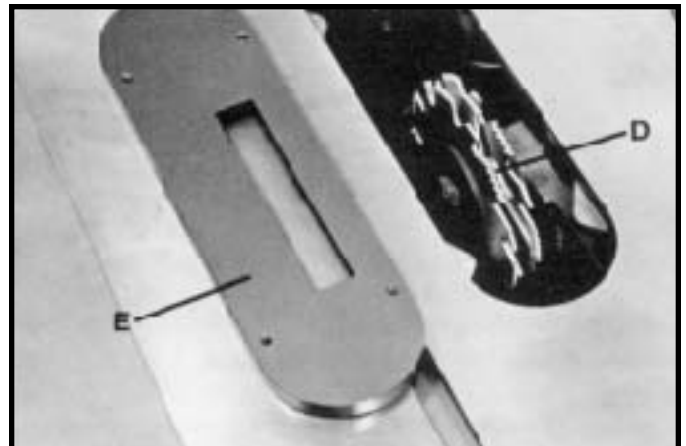

Fig. 87



Fig. 88

USING AUXILIARY WOOD FACING ON RIP FENCE

It is necessary when performing special operations such as moulding to add wood facing (A) Fig. 89, to one or both sides of the rip fence, as shown. The wood facing is attached to the fence with two clamps (B). 3/4 inch stock is suitable for most work although an occasional job may require 1 inch facing.

A wood facing should be used when ripping thin material such as paneling to prevent the material from catching between the bottom of the rip fence and the saw table surface.

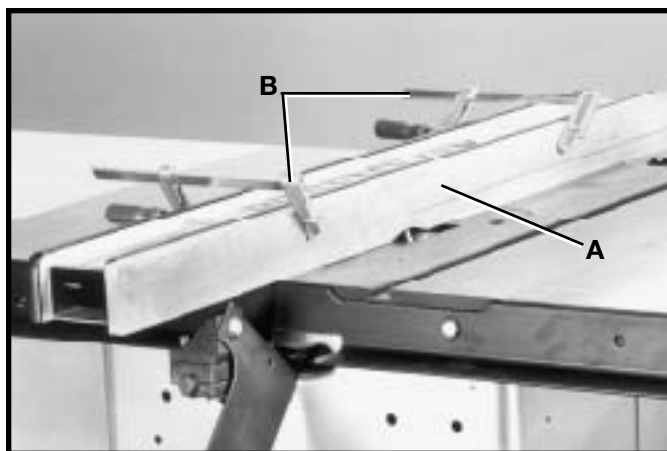

Fig. 89

ATTACHING ENGRAVED NAMEPLATE

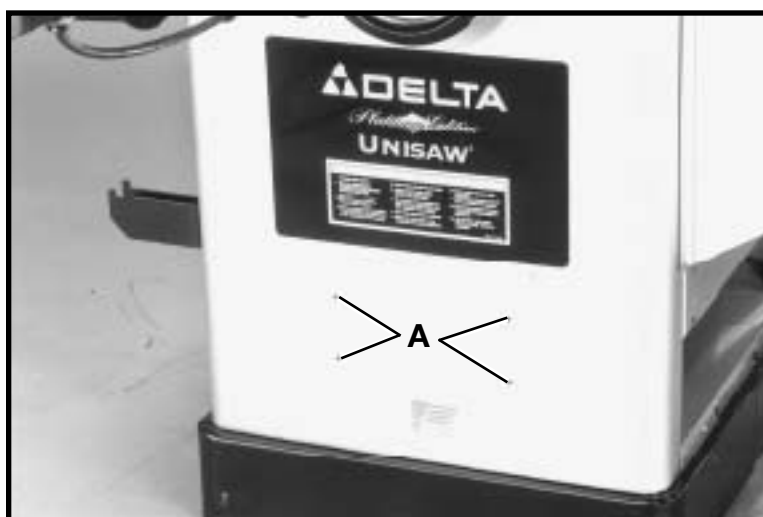

Fig. 90

1. The saw has four pre-drilled holes (A) Fig. 90, located in the front of the cabinet to attach the engraved nameplate.

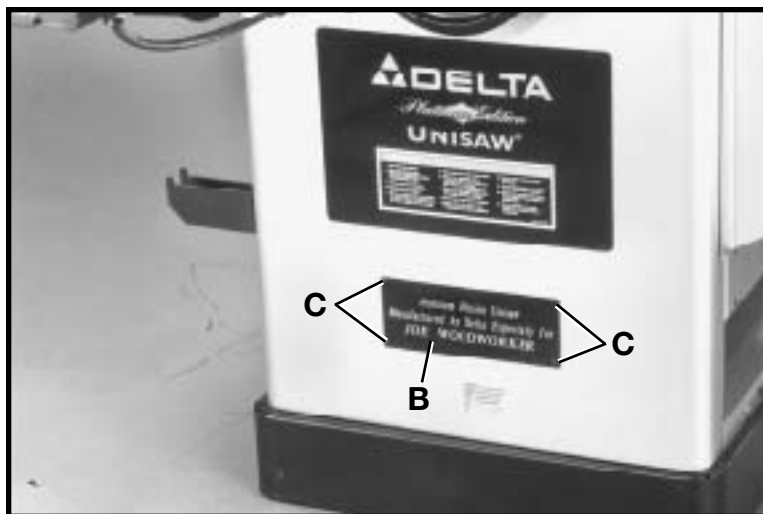

Fig. 91

2. Attach nameplate (B) Fig. 91, to the front of the cabinet using four #6 self-tapping screws (C) supplied.

CONSTRUCTING A PUSH STICK

When ripping work less than 4 inches wide, a push stick should be used to complete the feed and could easily be made from scrap material by following the pattern shown in Fig. 92.

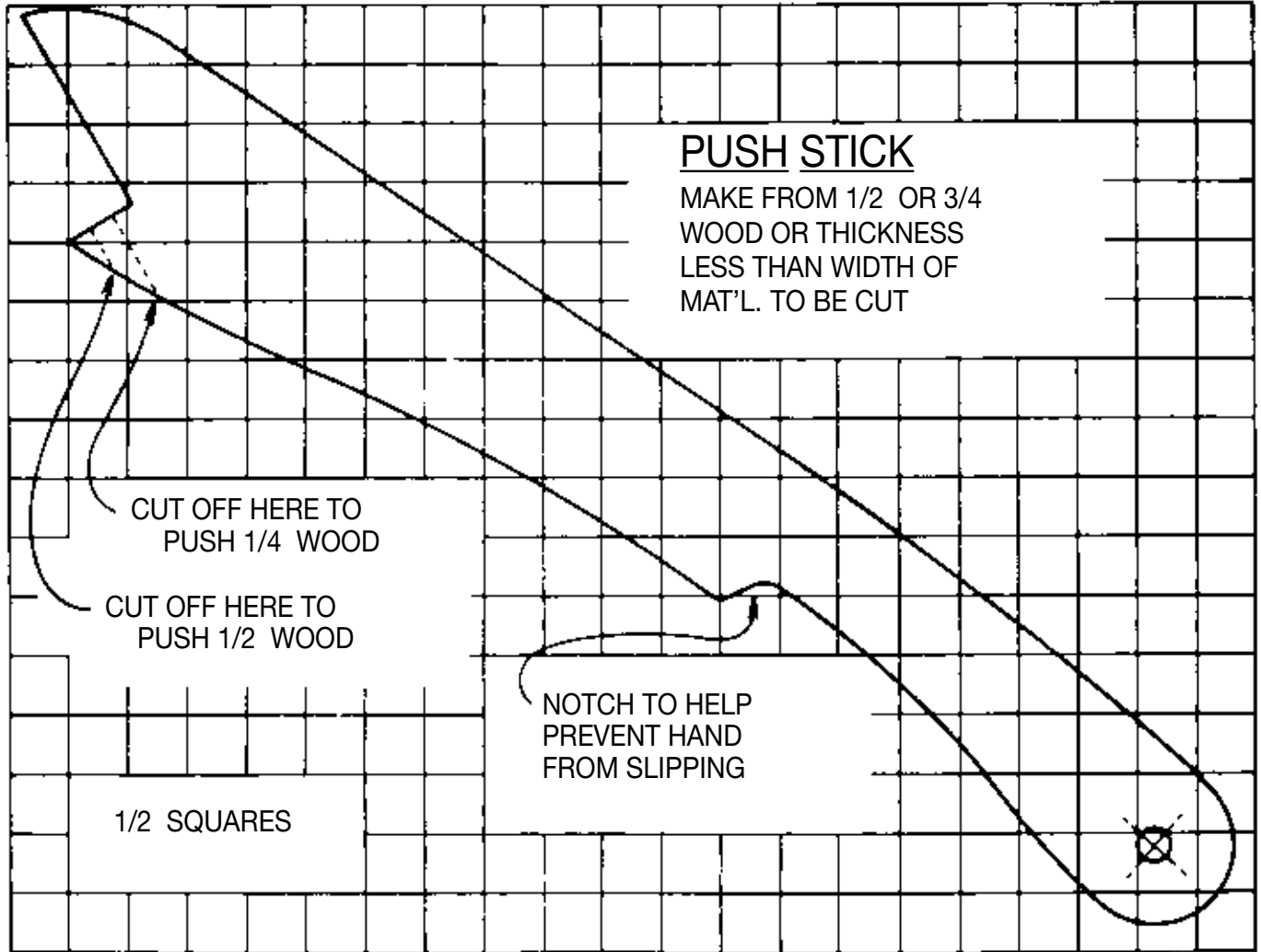

Fig. 92

PARTS, SERVICE OR WARRANTY ASSISTANCE

To obtain additional information regarding the fence or to obtain parts, service or warranty assistance, please call or fax the following toll free "Hotline" number. Highly qualified and experienced Customer Service Representatives are standing by to assist you on weekdays from 7:00 AM to 5:00 PM Mountain Standard Time.

Biesemeyer®

a subsidiary of Delta Woodworking Machinery

216 South Alma School Rd., Suite 3

Mesa, AZ 85210

Phone:
(480) 835-9300

Hotline:
(800) 782-1831

Fax:
(480) 834-8515



PARTS, SERVICE OR WARRANTY ASSISTANCE

All Delta Machines and accessories are manufactured to high quality standards and are serviced by a network of factory service centers and authorized service stations listed in your owner's manual. To obtain additional infor-

mation regarding your Delta quality product or to obtain parts, service or warranty assistance, please call or fax Delta's toll-free 'hotline' number.

Delta maintains a modern, efficient Parts Distribution Center, maintaining an inventory of over 15,000 parts located in Memphis, Tennessee.

Highly qualified and experienced Customer Service Representatives are standing by to assist you on weekdays from 7:00 A.M. to 6:00 P.M. Memphis time.

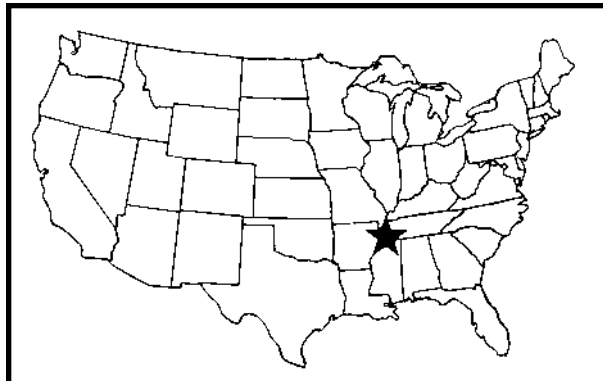

Memphis, TN 38118
4290 Raines Road
Phone: (901) 363-8800

HOTLINE

800-223-PART
FAX: 800-535-6488



Two Year Limited Warranty Delta Machinery

Delta will repair or replace, at its expense and at its option, any Delta machine, machine part, or machine accessory which in normal use has proven to be defective in workmanship or material, provided that the customer notifies his supplying distributor of the alleged defect within two years from the date of delivery to him, of the product and provides Delta Machinery with reasonable opportunity to verify the defect by inspection. Delta Machinery may require that electric motors be returned prepaid to the supplying distributor or authorized service center for inspection and repair or replacement. Delta Machinery will not be responsible for any asserted defect which has resulted from misuse, abuse or repair or alteration made or specifically authorized by anyone other than an authorized Delta service facility or representative. Under no circumstances will Delta Machinery be liable for incidental or consequential damages resulting from defective products. This warranty is Delta Machinery's sole warranty and sets forth the customer's exclusive remedy, with respect to defective products; all other warranties, express or implied, whether of merchantability, fitness for purpose, or otherwise, are expressly disclaimed by Delta.