

EZ-ZONE[®] PM

User's Guide



Integrated Controller Models



WATLOW[®]
Powered by Possibility



1241 Bundy Boulevard., Winona, Minnesota USA 55987
Phone: +1 (507) 454-5300, Fax: +1 (507) 452-4507
<http://www.watlow.com>

0600-0059-0000 Rev. P



Made in the U.S.A.











August 2016

Safety Information

We use note, caution and warning symbols throughout this book to draw your attention to important operational and safety information.

- A “NOTE” marks a short message to alert you to an important detail.
- A “CAUTION” safety alert appears with information that is important for protecting your equipment and performance. Be especially careful to read and follow all cautions that apply to your application.
- A “WARNING” safety alert appears with information that is important for protecting you, others and equipment from damage. Pay very close attention to all warnings that apply to your application.
- The safety alert symbol,  (an exclamation point in a triangle) precedes a general CAUTION or WARNING statement.
- The electrical hazard symbol,  (a lightning bolt in a triangle) precedes an electric shock hazard CAUTION or WARNING safety statement. Further explanations follow:

Symbol	Explanation
	CAUTION - Warning or Hazard that needs further explanation than label on unit can provide. Consult User's Guide for further information.
	ESD Sensitive product, use proper grounding and handling techniques when installing or servicing product.
	Unit protected by double/reinforced insulation for shock hazard prevention.
	Do not throw in trash, use proper recycling techniques or consult manufacturer for proper disposal.
	Enclosure made of Polycarbonate material. Use proper recycling techniques or consult manufacturer for proper disposal.
	Unit can be powered with either alternating current (ac) voltage or direct current (dc) voltage.
	Unit is a Listed device per Underwriters Laboratories®. It has been evaluated to United States and Canadian requirements for Process Control Equipment. UL 61010 and CSA C22.2 No. 61010. File E185611 QUYX, QUYX7. See: www.ul.com
	Unit is a Listed device per Underwriters Laboratories®. It has been evaluated to United States and Canadian requirements for Hazardous Locations Class 1 Division II Groups A, B, C and D. ANSI/ISA 12.12.01-2007. File E184390 QUZW, QUZW7. See: www.ul.com

	Unit is compliant with European Union directives. See Declaration of Conformity for further details on Directives and Standards used for Compliance.
	Unit has been reviewed and approved by Factory Mutual as a Temperature Limit Device per FM Class 3545 standard. See: www.fmglobal.com
	Unit has been reviewed and approved by CSA International for use as Temperature Indicating-Regulating Equipment per CSA C22.2 No. 24. See: www.csa-international.org
	Unit has been reviewed and approved by ODVA for compliance with DeviceNet communications protocol. See: www.odva.org
	Unit has been reviewed and approved by ODVA for compliance with Ethernet/IP communications protocol. See: www.odva.org

Warranty

The EZ-ZONE® PM is manufactured by ISO 9001-registered processes and is backed by a three-year warranty to the first purchaser for use, providing that the units have not been misapplied. Since Watlow has no control over their use, and sometimes misuse, we cannot guarantee against failure. Watlow's obligations hereunder, at Watlow's option, are limited to replacement, repair or refund of purchase price, and parts which upon examination prove to be defective within the warranty period specified. This warranty does not apply to damage resulting from transportation, alteration, misuse or abuse. The purchaser must use Watlow parts to maintain all listed ratings.

Technical Assistance

If you encounter a problem with your Watlow controller, review your configuration information to verify that your selections are consistent with your application: inputs, outputs, alarms, limits, etc. If the problem persists, you can get technical assistance from your local Watlow representative (see back cover), by e-mailing your questions to wintechsupport@watlow.com or by dialing +1 (507) 494-5656 between 7 a.m. and 5 p.m., Central Standard Time (CST). Ask for for an Applications Engineer. Please have the following information available when calling:

- Complete model number
- All configuration information
- User's Guide
- Factory Page

Return Material Authorization (RMA)

1. Call Watlow Customer Service, (507) 454-5300, for a Return Material Authorization (RMA) number before returning any item for repair. If you do not know why the product failed, contact an Application Engineer or Product Manager. All RMA's require:
 - Ship-to address
 - Bill-to address
 - Contact name

- Phone number
 - Method of return shipment
 - Your P.O. number
 - Detailed description of the problem
 - Any special instructions
 - Name and phone number of person returning the product.
2. Prior approval and an Return Merchandise Authorization number from the Customer Service Department is required when returning any product for credit, repair or evaluation. Make sure the Return Merchandise Authorization number is on the outside of the carton and on all paperwork returned. Ship on a Freight Prepaid basis.
 3. After we receive your return, we will examine it and try to verify the reason for returning it.
 4. In cases of manufacturing defect, we will enter a repair order, replacement order or issue credit for material returned. In cases of customer misuse, we will provide repair costs and request a purchase order to proceed with the repair work.
 5. To return products that are not defective, goods must be in new condition, in the original boxes and they must be returned within 120 days of receipt. A 20 percent restocking charge is applied for all returned stock controls and accessories.
 6. If the unit cannot be repaired, you will receive a letter of explanation and be given the option to have the unit returned to you at your expense or to have us scrap the unit.
 7. Watlow reserves the right to charge for no trouble found (NTF) returns.

This EZ-ZONE® PM User's Guide is copyrighted by Watlow Electric, Inc., © August 2016 with all rights reserved.

EZ-ZONE PM is covered by U.S. Patent Numbers: 6005577; D553095; D553096; D553097; D560175; D55766; and OTHER PATENTS PENDING



Table of Contents

Table of Contents	1
Chapter 1: Overview	6
Available EZ-ZONE PM Literature and Resources	6
Introduction	7
Getting Started Quickly	9
A Conceptual View of the PM	10
Inputs	10
Internal Functions	11
Outputs	11
Input Events and Output Events	11
What is a Profile	11
Chapter 2: Install and Wire	20
Dimensions	20
1/16 DIN (PM6) Dimensions	20
1/16 DIN (PM6) Recommended Panel Spacing	20
1/8 DIN (PM8) Vertical Dimensions	21
1/8 DIN (PM8) Vertical Recommended Panel Spacing	21
1/8 DIN (PM9) Horizontal Recommended Panel Spacing	22
1/4 DIN (PM4) Dimensions	23
1/4 DIN (PM4) Recommended Panel Spacing	23
Installation	24
Wiring	26
PM Integrated Isolation Block	30
Chapter 3: Keys and Displays	55
Responding to a Displayed Message	56
Default Home Page Parameters	57
Chapter 4: Home Page	57
Changing the Set Point	59
Starting a Profile from the Home Page	59
Ending a Profile from the Home Page	59
Modifying the Home Page	59
Conventions Used in the Menu Pages	63
Display	64
Communication Protocols	64
Modbus Introduction to the Modbus Protocol	64
J1939 CAN	65
Profibus DP	66
Chapter 5: Operations Page	67
Analog Input Menu	70
Digital Bus Menu (J1939 CAN)	71
Linearization Menu	72



Table of Contents (cont.)

Process Value Menu	73
Digital Input/Output Menu	74
Limit Menu	75
Monitor Menu	76
Control Loop Menu	77
Alarm Menu	81
Current Menu	83
Timer Menu	84
Math Menu	87
Special Output Function Menu	87
Profile Status Menu	89
Chapter 6: Setup Page	92
Analog Input Menu	96
Digital Bus Menu (J1939 CAN)	99
Linearization Menu	103
Process Value Menu	107
Digital Input/Output Menu	108
Limit Menu	114
Control Loop Menu	116
Output Menu	125
Alarm Menu	128
Current Menu	133
Timer Menu	134
Math Menu	137
Special Output Function Menu	138
Function Key	140
Global Menu	142
Communications Menu	145
Standard Bus	146
Modbus RTU	146
DeviceNet	148
J1939 CAN bus (Digital Input Bus)	149
Profibus DP	150
Modbus TCP or EtherNet/IP	151
Real Time Clock Menu	155
Chapter 7: Profiling Page	156
Profile Setup	156
Starting a Profile	157
Profiling Menu	161
Chapter 8: Factory Page	168
Custom	170

TC

Table of Contents (cont.)

Lock Menu	171
Unlock Menu	173
Diagnostics Menu	174
Calibration Menu	176
Chapter 9: Features	179
Changing PM Integrated Model Number to PM Express	181
Saving and Restoring Settings	182
Tuning the PID Parameters	183
Autotune	183
Manual Tuning	184
Autotuning with TRU-TUNE+ [®]	184
Inputs	185
Calibration Offset	185
Calibration	186
Filter Time Constant	188
Sensor Selection	188
Sensor Backup	188
Set Point Minimum and Maximum	188
Scale High and Scale Low	188
Range High and Range Low	189
Receiving a Remote Set Point	189
Ten Point Linearization	190
Outputs	190
Duplex	190
NO-ARC Relay	190
Retransmitting a Process Value or Set Point	191
Cool Output Curve	192
Resetting a Tripped Limit	192
Control Methods	193
Output Configuration	193
Auto (closed loop) and Manual (open loop) Control	193
On-Off Control	194
Proportional and (P) Control	195
Proportional and Integral (PI) Control	195
Proportional, Integral and Derivative (PID) Control	196
Dead Band	196
Variable Time Base	197

TC

Table of Contents (cont.)

Single Set Point Ramping	198
Cascade Control	198
Compressor Control	198
Differential Control	199
Ratio Control	199
Duplex Control	199
Motorized Valve Control	199
Timer Function	200
Setting up the timer function	200
Alarms	202
Process and Deviation Alarms	203
Set Points	203
Hysteresis	203
Latching	203
Silencing	204
Blocking	204
Current Sensing	204
Open and Shorted Load Circuit Detection	204
Open Loop Detection	205
Programming the EZ Key/s	205
Using Lockout and Password Security	206
Using Lockout Method 1 (Read and Set Lock)	206
Using Lockout Method 2 (Password Enable)	208
Modbus - Using Programmable Memory Blocks	210
CIP - Communications Capabilities	210
CIP Implicit Assemblies	211
PCCC - (Programmable Controller Communications Commands)	212
Profibus DP - (Decentralized Peripherals)	213
Software Configuration	213
Using EZ-ZONE Configurator Software	213
Chapter 10: Applications	217
Example 1: Single Loop Control	217
Example 2: Sensor Backup	217
Example 3: Square Root	218
Example 4: Ratio	218
Example 5: Differential	219
Example 6: Cascade	219
Example 7: Wet Bulb / Dry Bulb	221

TC

Table of Contents (cont.)

Example 8: Vaisala	222
Example 9: Motorized Valve Control	223
Chapter 11: Appendix	225
Troubleshooting Alarms, Errors and Control Issues	225
Modbus - Programmable Memory Blocks	232
CIP Implicit Assembly Structures	235
CIP Implicit Assembly	235
Originator (Master) to Target (PM)	235
CIP Implicit Assembly	236
Target (PM) to Originator (Master)	236
Compact Class Assembly Structure	237
PM Specifications	244
Ordering Information for PM Integrated Controller Models	250
How to Reach Us	252

1

Chapter 1: Overview

Available EZ-ZONE PM Literature and Resources

Document Title and Part Number	Description
EZ-ZONE PM PID Controller User's Guide, part number: 0600-0058-0000	Describes how to connect and use an advanced PID loop controller. This particular model is limited to one control loop and 2 outputs. Like all PM controllers, it comes with Standard Bus communications. As an additional option, it can also be ordered with Modbus® RTU communications.
EZ-ZONE PM Limit (PML) User's Guide, part number: 0600-0057-0000	This document describes how to protect against unwanted thermal runaway and over temperature conditions through proper configuration, programming. Like all PM controllers, it comes with Standard Bus communications. As an additional option, it can also be ordered with various fieldbus communications protocols.
EZ-ZONE Remote User Interface (RUI) User's Guide, part number: 0600-0060-0000	The RUI provides a visual remote LED display for the PM/RM configuration and setup menus. This document illustrates and describes connections and also describes the Home Page for each EZ-ZONE device as viewed from the RUI.
EZ-ZONE PM Specification Sheet, part number: wine-zpm0516	Describes the PM family hardware options, features, benefits and technical specifications.
Watlow Support Tools DVD, part number: 0601-0001-0000	Contains all related user documents, tutorial videos, application notes, utility tools, etc...

The DVD described above ships with the product and as stated contains all of the literature above as well as much more. If the DVD is not available one can be acquired by contacting Watlow Customer Service at 1-507-454-5300.

As an alternative to the DVD, all of the user documentation described above can also be found on the Watlow website. Click on the following link to find your document of choice: <http://www.watlow.com/en/resources-and-support/Technical-Library/User-Manuals>. Once there, simply type in the desired part number (or name) into the search box and download free copies. Printed versions of all user documents can also be purchased here as well.

Your Comments are Appreciated

In an effort to continually improve our technical literature and ensure that we are providing information that is useful to you, we would very much appreciate your comments and suggestions. Please send any comments you may have to the following e-mail address:

TechlitComments@watlow.com

Introduction

The EZ-ZONE® PM takes the pain out of solving your thermal loop requirements. Watlow's EZ-ZONE PM controllers offer options to reduce system complexity and the cost of control loop ownership. You can order the EZ-ZONE PM as a PID controller or an over-under limit controller, or you can combine both functions in the PM Integrated Controller. You now have the option to integrate a high-amperage power controller output, an over-under limit controller and a high-performance PID controller all in space saving, panel-mount packages. You can also select from a number of industrial serial communications options to help you manage system performance.

Standard Features and Benefits

Advanced PID Control Algorithm

- TRU-TUNE+® Adaptive tune provides tighter control for demanding applications.
- Auto Tune for fast, efficient start ups

EZ-ZONE configuration communications and software

- Saves time and improves the reliability of controller set up

FM Approved Over-under Limit with Auxiliary Outputs

- Increases user and equipment safety for over-under temperature conditions
- To meet agency requirements, output 4 is the fixed limit output. Other outputs can be configured to mirror the limit output (4).

Parameter Save & Restore Memory

- Reduces service calls and down time

Agency approvals: UL® Listed, CSA, CE, RoHS, W.E.E.E. FM, SEMI F47-0200, Class 1, Div 2 rating on selected models

- Assures prompt product acceptance
- Reduces end product documentation costs

EZ-Key/s

- Programmable EZ-Key enables simple one-touch operation of repetitive user activities

Programmable Menu System

- Reduces set up time and increases operator efficiency

Three-year warranty

- Demonstrates Watlow's reliability and product support

Touch-safe Package

- IP2X increased safety for installers and operators

P3T Armor Sealing System

- NEMA 4X and IP65 offers water and dust resistance, can be cleaned and washed down (indoor use only)
- Backed up by UL 50 independent certification to NEMA 4X specification

Removable cage clamp wiring connectors

- Reliable wiring, reduced service calls
- Simplified installation

Heat-Cool Operation

- Provides application flexibility with accurate temperature and process control
-

Optional Features and Benefits

High-amperage Power Control Output

- Drives 15 amp resistive loads directly
- Reduces component count
- Saves panel space and simplifies wiring
- Reduces the cost of ownership

Integrated PID and Limit Controller

- Reduces wiring time and termination complexity compared to connecting discrete products
- Decreases required panel space
- Lowers installation costs
- Increases user and equipment safety for over/under temperature conditions

Current Monitoring

- Detects heater current flow and provides alarm indication of a failed output device or heater load

Communications Capabilities

- Provides a wide range of protocol choices including Modbus® RTU, EtherNet/IP™, PCCC (Programmable Controller Communications Commands), DeviceNet™, Modbus® TCP, and Profibus DP
- Supports network connectivity to a PC or PLC

Dual Channel Controller

- For selected models provides two PID controllers in one space saving package

Enhanced Control Capabilities

- Easily handle complex process problems such as cascade, ratio, differential, square-root, motorized valve control without slidewire feedback, wet-bulb/dry-bulb and compressor control

Full-featured Alarms

- Improves operator recognition of system faults
- Control of auxiliary devices

Ten Point Linearization Curve

- Improves sensor accuracy

Remote Set Point Operation

- Supports efficient set point manipulation via a master control or PLC

Retransmit Output

- Supports industry needs for product process recording

Profile Capability

- Pre-programmed process control
- Ramp and soak programming with four files and 40 total steps

Getting Started Quickly

The PM control has a page and menu structure that is listed below along with a brief description of its purpose.

<p>Setup Page Push and hold the up and down keys (▲ ▼) for 6 seconds to enter. (See the Setup Page for further information)</p>	<p>Once received, a user would want to setup their control prior to operation. As an example, define the input type and set the output cycle time.</p>
<p>Operations Page Press and hold the up and down keys (▲ ▼) for 3 seconds to enter. (See the Operations Page for further information)</p>	<p>After setting up the control to reflect your equipment, the Operations Page would be used to monitor or change runtime settings. As an example, the user may want to see how much time is left in a profile step or perhaps change the high set point of the limit.</p>
<p>Factory Page Press and hold the Infinity and the green Advance Keys (∞ ⏻) for 6 seconds to enter. (See the Factory Page for further information)</p>	<p>For the most part the Factory Page has no bearing on the control when running. A user may want to enable password protection, view the control part number or perhaps create a custom Home Page.</p>
<p>Home Page The control is at the Home Page when initially powered up.</p>	<p>Pushing the green Advance Key ⏻ will allow the user to see and change such parameters as the control mode, enable autotune and idle set point to name a few.</p>
<p>Profile Page Press and hold the green Advance Key ⏻ for 6 seconds to enter. (See the Profile Page for further information)</p>	<p>If equipped with this feature a user would want to go here to configure a profile.</p>

The default PM loop configuration out of the box is shown below:

- Analog Input functions set to thermocouple, type J
- Heat algorithm set for PID, Cool set to off
- Output 1 set to Heat
- Control mode set to Auto
- Set point set to 75 °F

If you are using the input type shown above, simply connect your input and output devices to the control. Power up the control and push the up arrow ▲ on the face of the control to change the set point from the default value of 75°F to the desired value. As the Set Point increases above the Process Value, output 1 will come on and it will now begin driving your output device. The PV function as shown in the graphic below is only available with PM4/8/9 models.

Note:

The output cycle time will have a bearing on the life of mechanical relay outputs and can be different based on the type of output ordered. The output cycle time can be changed in the Setup Page under the Output Menu.

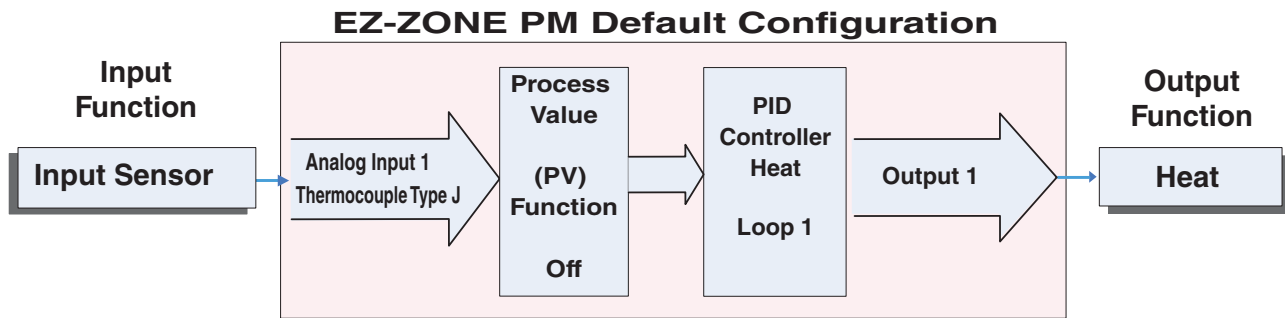

A Conceptual View of the PM

The flexibility of the PM software and hardware allows for a large range of configurations. Acquiring a better understanding of the controller’s overall functionality and capabilities while at the same time planning out how the controller can be used will deliver maximum effectiveness in your application.

It is useful to think of the controller in terms of functions; there are internal and external functions. An input and an output would be considered external functions where the limit, PID or alarm function would be an internal function. Information flows from an input function to an internal function to an output function when the controller is properly configured. A single PM controller can carry out several functions at the same time, for instance (but not limited to), PID control, checking for a limit condition, monitoring for several different alarm situations, etc... To ensure that the application requirements are being met, it is important to first give thought to each external process and then configuring the controller’s internal functions to properly accommodate the application requirements.

Inputs

The inputs provide the information that any given programmed procedure can act upon. In a simple form, this information may come from an operator pushing a button or from a sensor monitoring the temperature of a part being heated or cooled.

Each analog input typically uses a thermocouple or RTD to read the process temperature. It can also read volts, current or resistance, allowing it to use various devices to read a wide array of values.

A PM with digital input/output (DIO) hardware includes two sets of terminals where each of which can be used as either an input or an output. Each pair of terminals must be configured to function as either an input or output with the direction parameter in the Digital Input/ Output Menu (Setup Page). Each digital input reads whether a device is active or inactive.

The Function or EZ Key/s (PM4/6/8/9 only) on the front panel of the PM also operates as a digital input by toggling the function assigned to it in the Digital Input Function parameter in the Function Key Menu (Setup Page).

Internal Functions

The controller will use input signals to calculate a value and then perform an operation. A sample of some functions may be as simple as:

- Compare an input value to the set point and calculate the optimal power for a heater
- Detect a failure of the primary sensing device and trip a contactor to remove power from the heating element
- Reading a digital input to set a state to true or false
- Evaluate an incoming temperature to determine an alarm state (on or off)

To set up a function, it's important to define the source, or instance, to use. For example, if the control is equipped with DIO they can be configured to respond to an alarm. If configured as such, the digital output must be tied to the desired alarm instance (1 to 4). Using this as an example, the Function for the digital output would be defined as an Alarm where the Instance would be selected as 1, 2, 3, or 4 corresponding to the alarm instance that will drive the output.

Keep in mind that a function is a user-programmed internal process that does not execute any action outside of the controller. To have any effect outside of the controller, an output must be configured to respond to a function.

Outputs

Outputs can perform various functions or actions in response to information provided by a function such as, removal of the control voltage to a contactor; operating a heater, turning a light on or off, unlocking a door, etc...

Assign a Function to any available output on the Setup Page within the Output Menu or Digital Input/Output Menu. Then select which instance of that function will drive the selected output. For example, you might assign an output to respond to alarm 4 (instance 4).

You can assign more than one output to respond to a single instance of a function. For example, alarm 2 could be used to trigger a light connected to output 1 and a siren connected to digital output 5.

Input Events and Output Events

Input and output events are internal states that are used exclusively by profiles. The source of an event input can come from a real-world digital input or an output from another function. Likewise, event outputs may control a physical output such as an output function block or be used as an input to another function.

What is a Profile

A profile is a set of instructions consisting of a sequence of steps. When a profile runs, the controller automatically executes its steps in sequence. The step type determines what action the controller performs. Steps can change temperatures and other process values gradually over time, maintain the temperatures and process values for specific periods, or repeat a sequence of steps numerous times. At each step the profile can activate or deactivate outputs that control other equipment. Also a step can have the controller wait for specific conditions before proceeding such as, waiting for a switch closure and/or a specific process value to be detected by a sensor.

EZ-ZONE® PM Integrated Model 1/16 DIN System Diagram With a Current Transformer, Without Communications Card (Slot B)

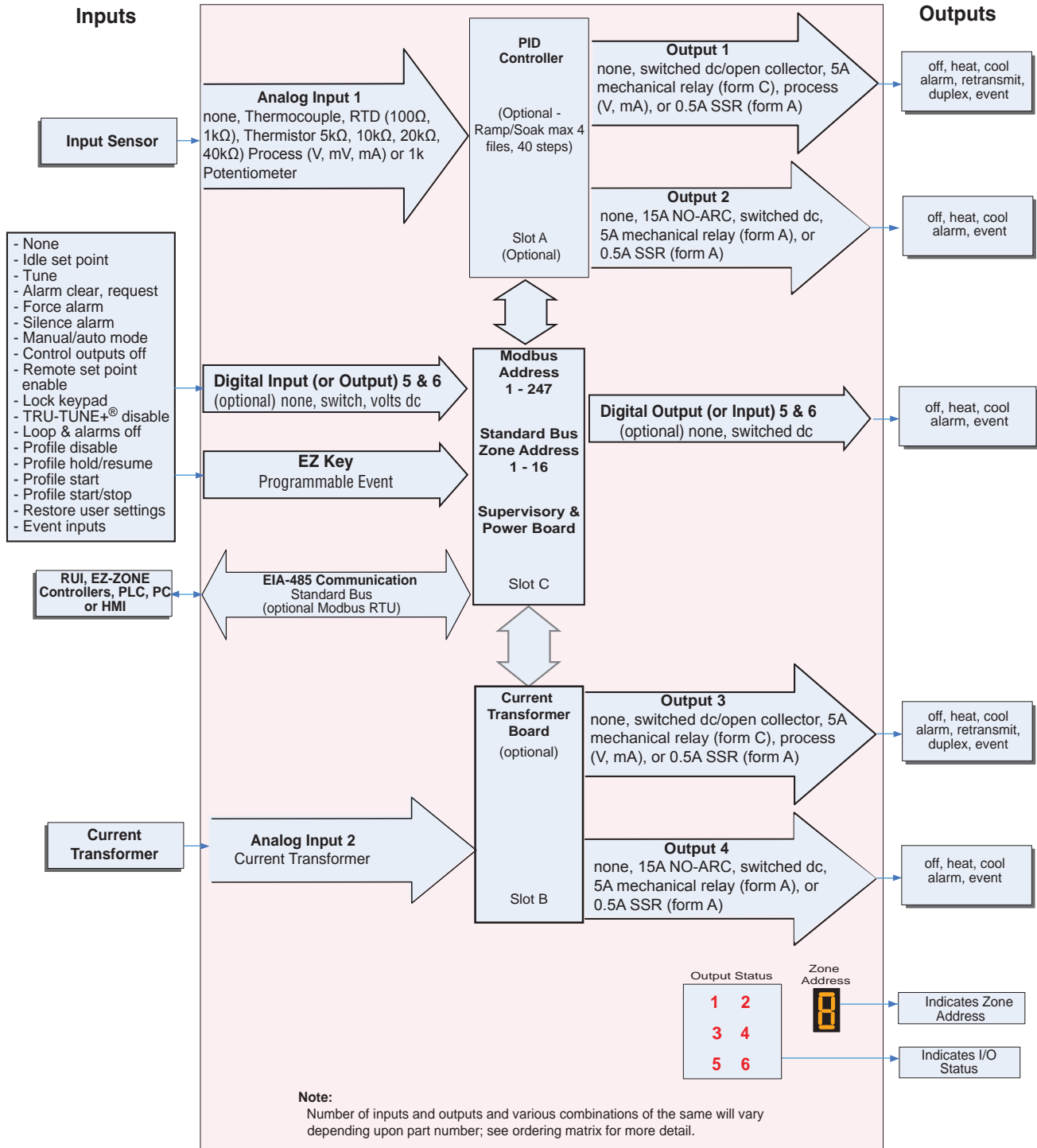

Current Monitoring

- Detects heater current flow
- Provides an alarm indication of a failed-load issue.

EZ-ZONE® PM Integrated Model 1/16 DIN System Diagram With Auxillary Input, Without Communications Card (Slot B)

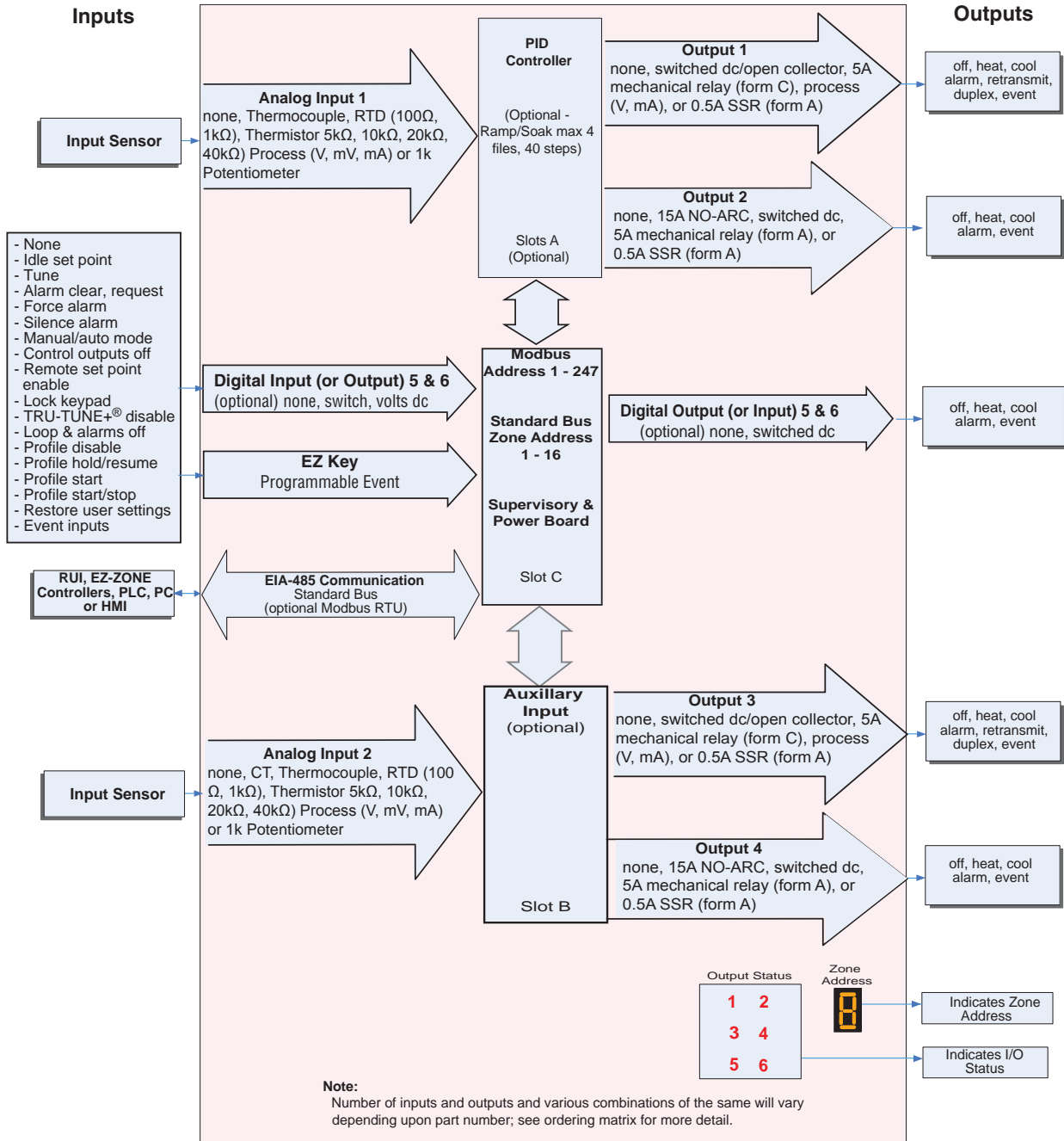

Remote Set Point Operation

- Supports efficient set point manipulation from a remote device, such as a master control or PLC.

EZ-ZONE® PM Integrated Model 1/16 DIN With Limit, System Diagram Without Communications Card (Slot B)

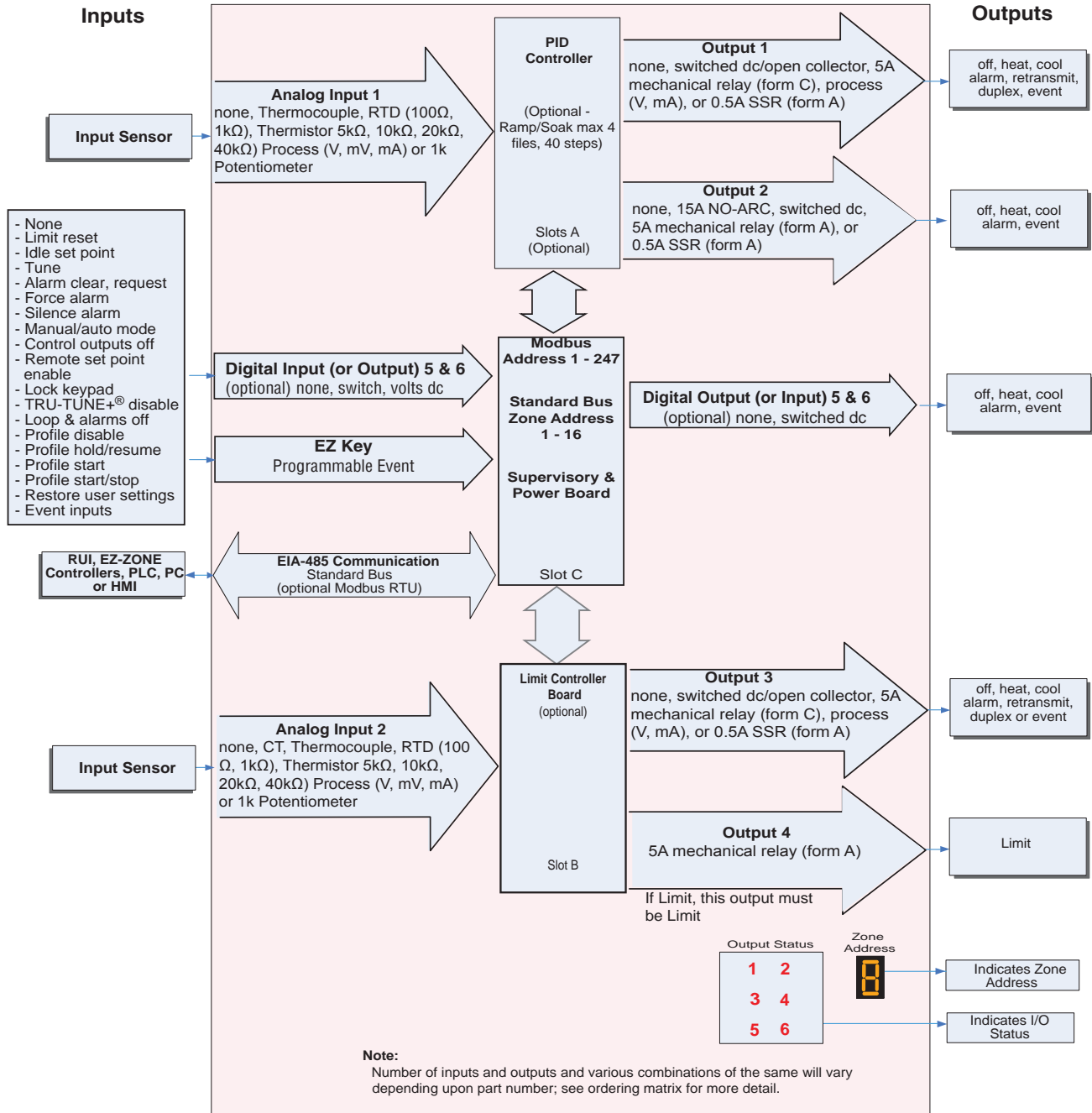

Integrated PID and Limit Controller

- Reduces wiring time and termination complexity compared to connecting separate products
- Reduces panel space
- Reduces installation costs
- Increases dependability with backup control sensor operation
- Increases user and equipment safety for over-under temperature conditions

EZ-ZONE® PM Integrated Model 1/16 DIN System Diagram with Expanded Communications (Slot B)

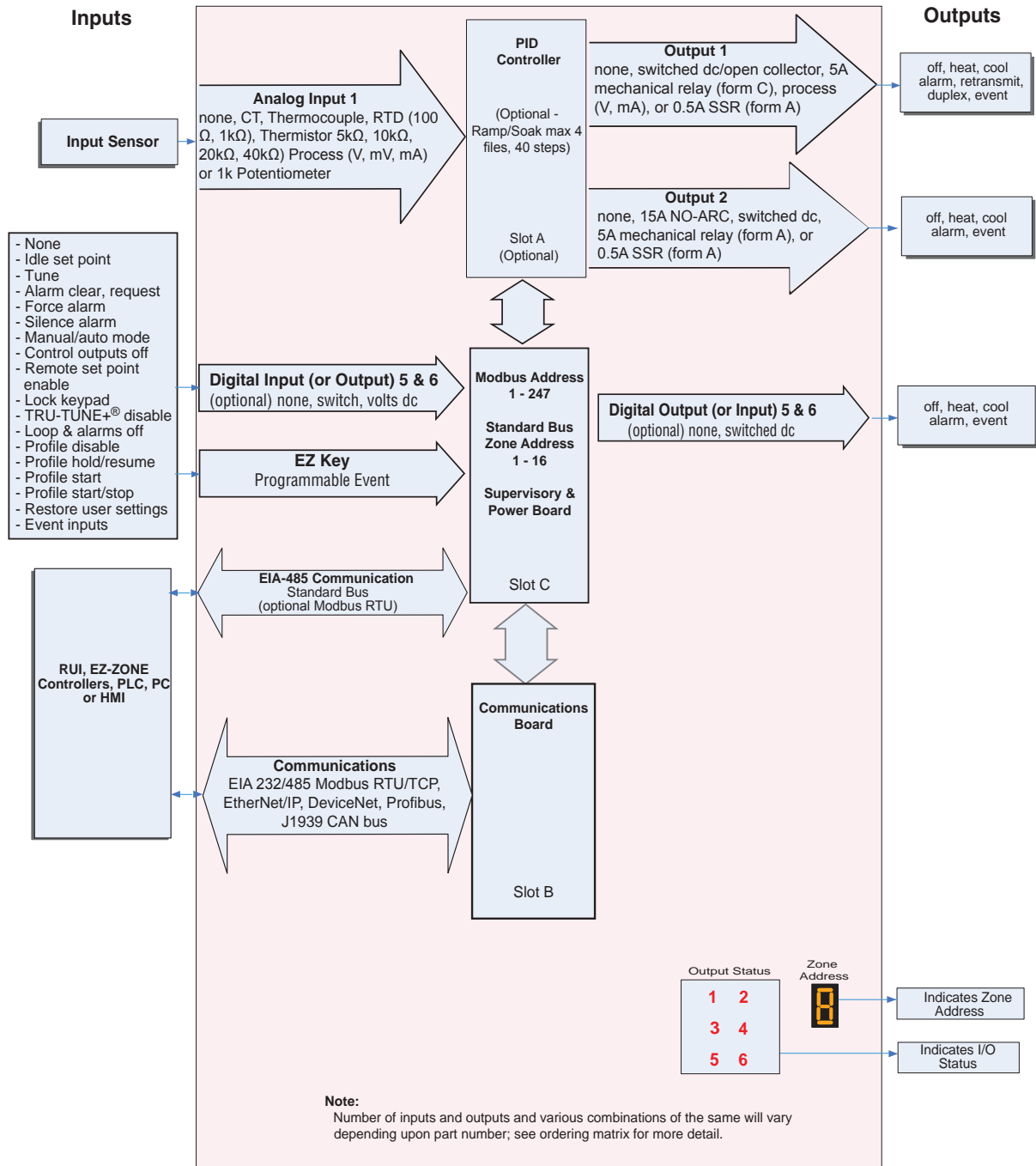

Serial Communication Capabilities

- Supports network connectivity to a PC or PLC
- Available in a wide range of protocol choices, including Modbus RTU, EtherNet/IP™, Modbus TCP

EZ-ZONE® PM Integrated Model 1/8 and 1/4 DIN System Diagram Without 6 Digital I/O (slot D), Without Communications (slot E)

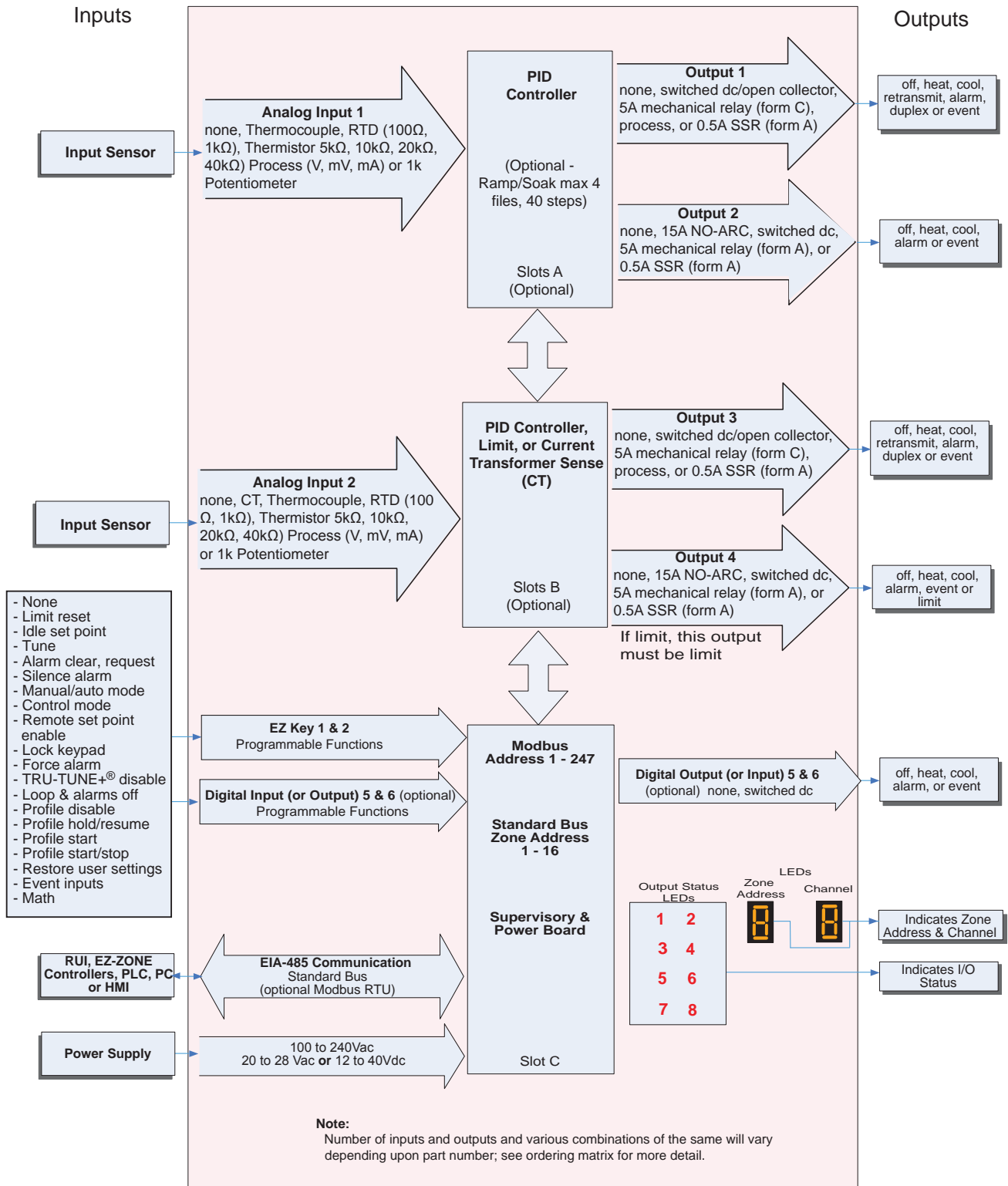

EZ-ZONE® PM Integrated Model 1/8 and 1/4 DIN System Diagram With 6 Digital I/O (slot D), Without Communications (slot E)

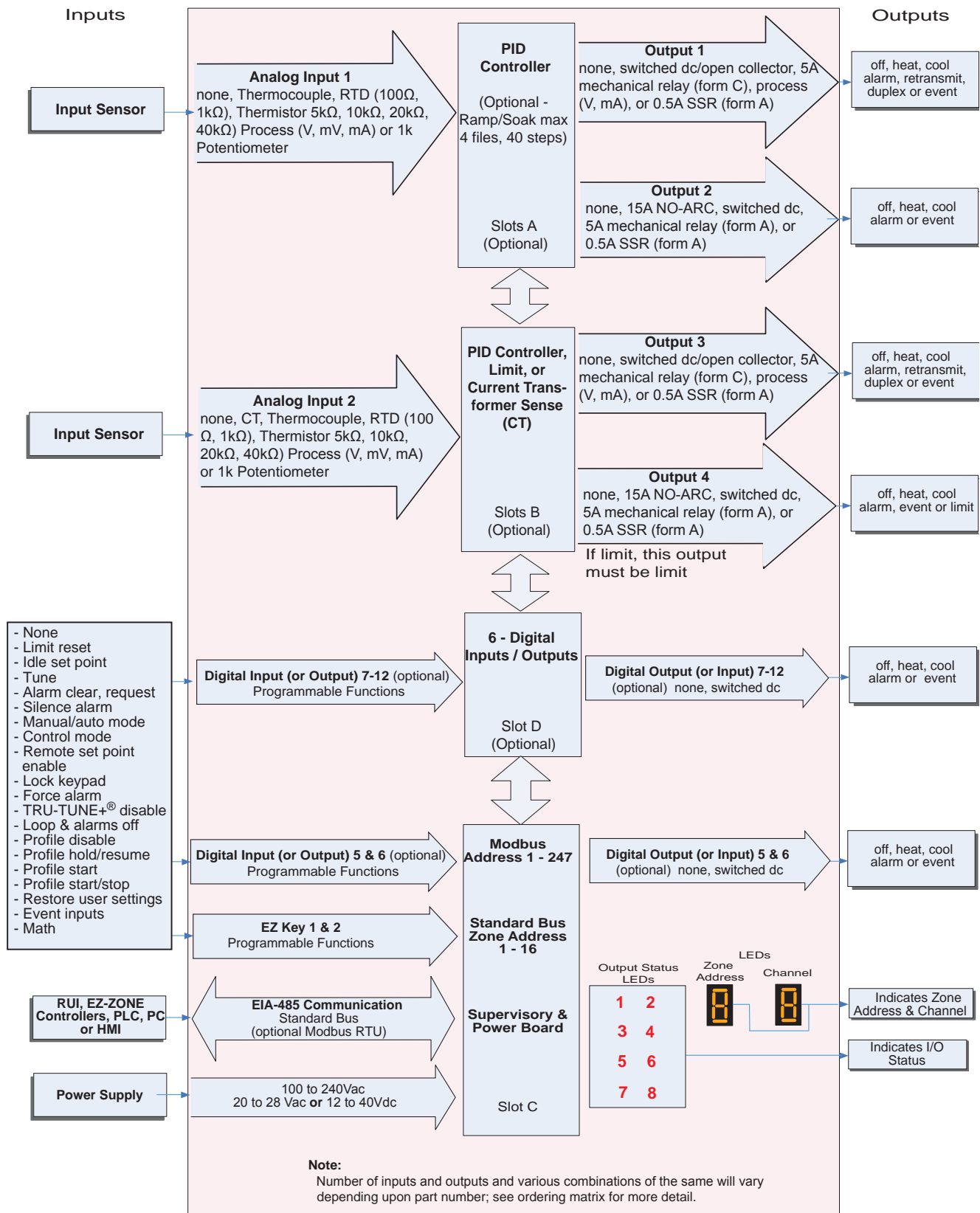

EZ-ZONE® PM Integrated Model 1/8 and 1/4 DIN with CT System Diagram Without 6 Digital I/O (slot D), Without Communications (slot E)

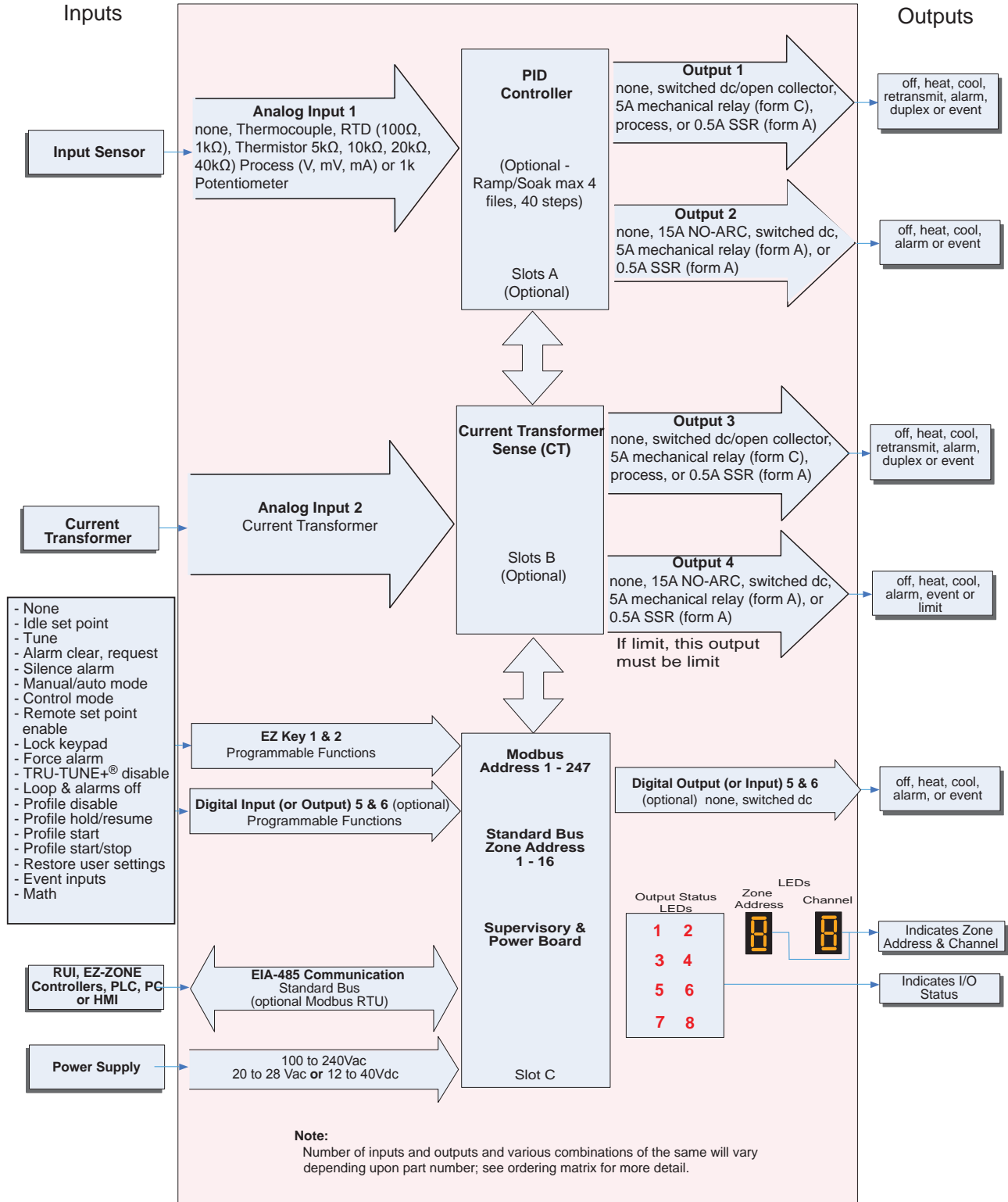

EZ-ZONE® PM Integrated Model 1/8 and 1/4 DIN System Diagram Without 6 Digital I/O (slot D), With Communications (slot E)

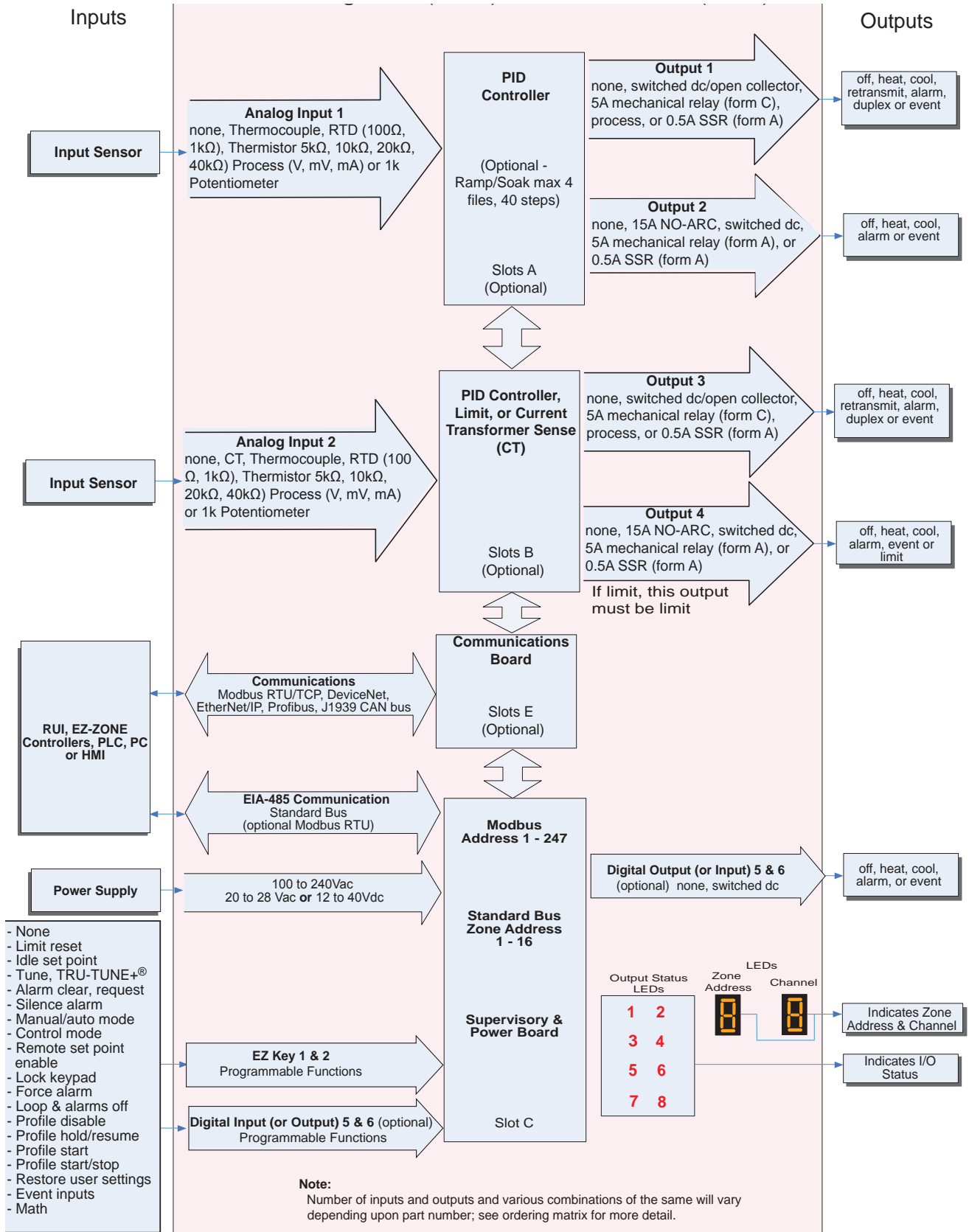

2

Chapter 2: Install and Wire

Dimensions

1/16 DIN (PM6) Dimensions

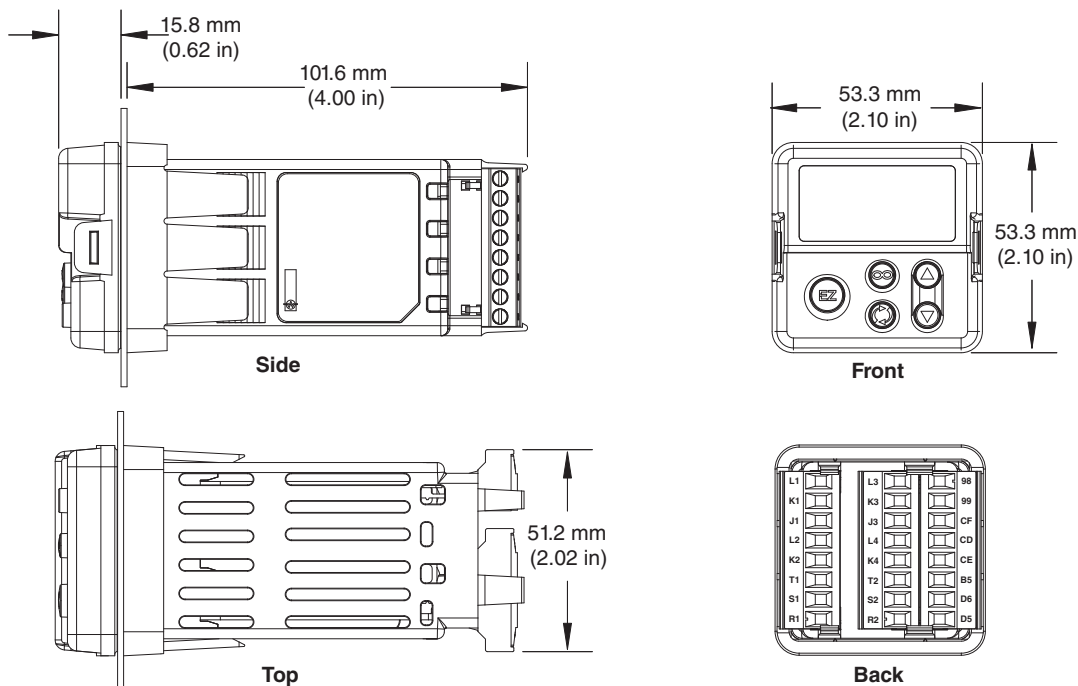

1/16 DIN (PM6) Recommended Panel Spacing

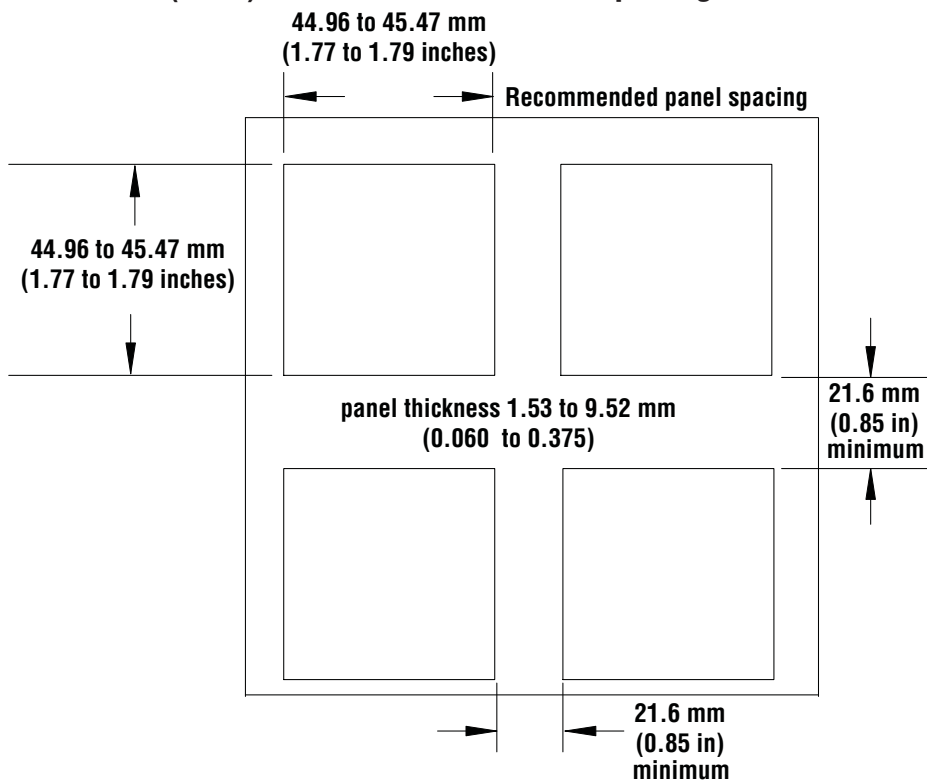

1/8 DIN (PM8) Vertical Dimensions

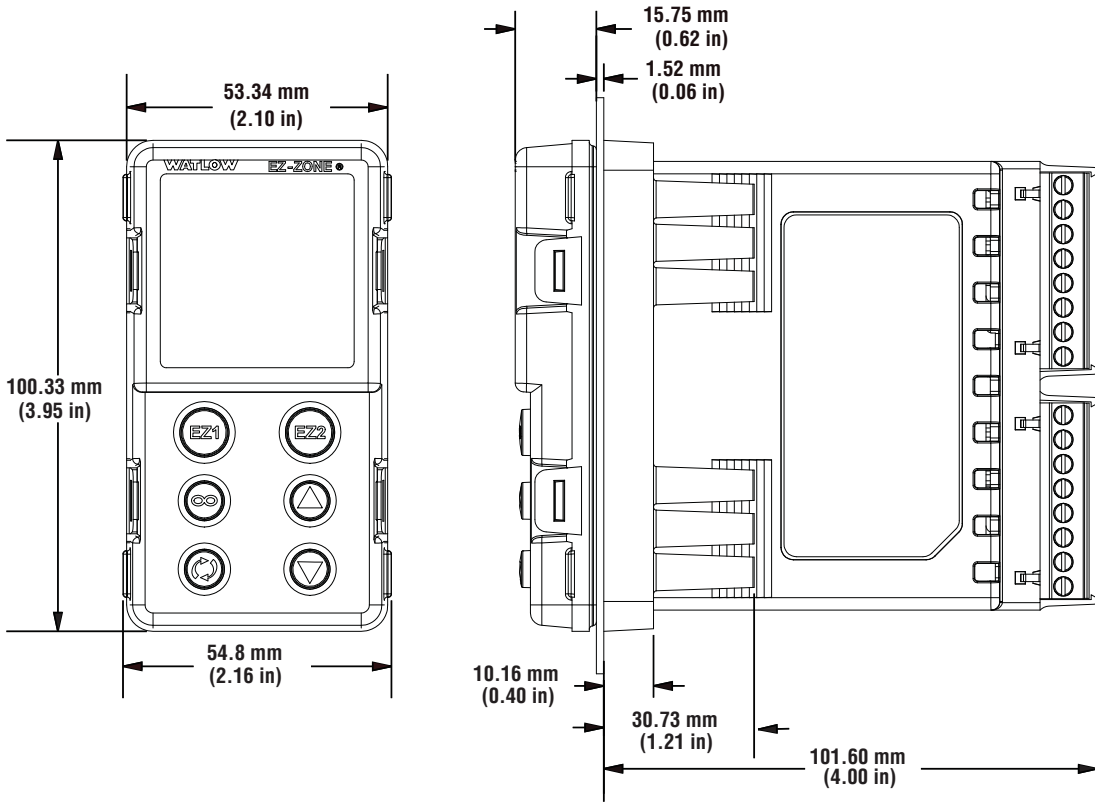

1/8 DIN (PM8) Vertical Recommended Panel Spacing

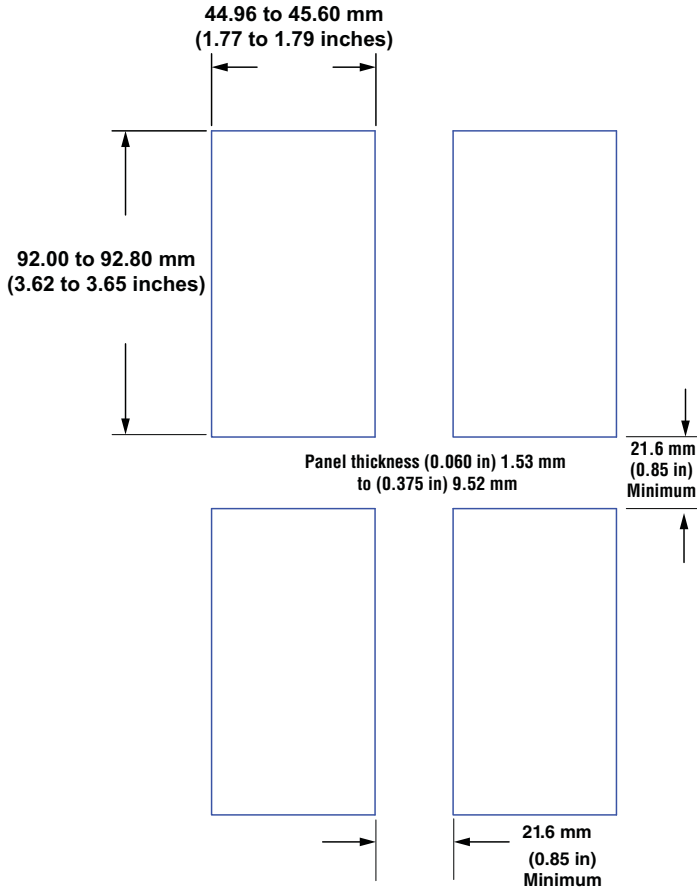

1/8 DIN (PM9) Horizontal Dimensions

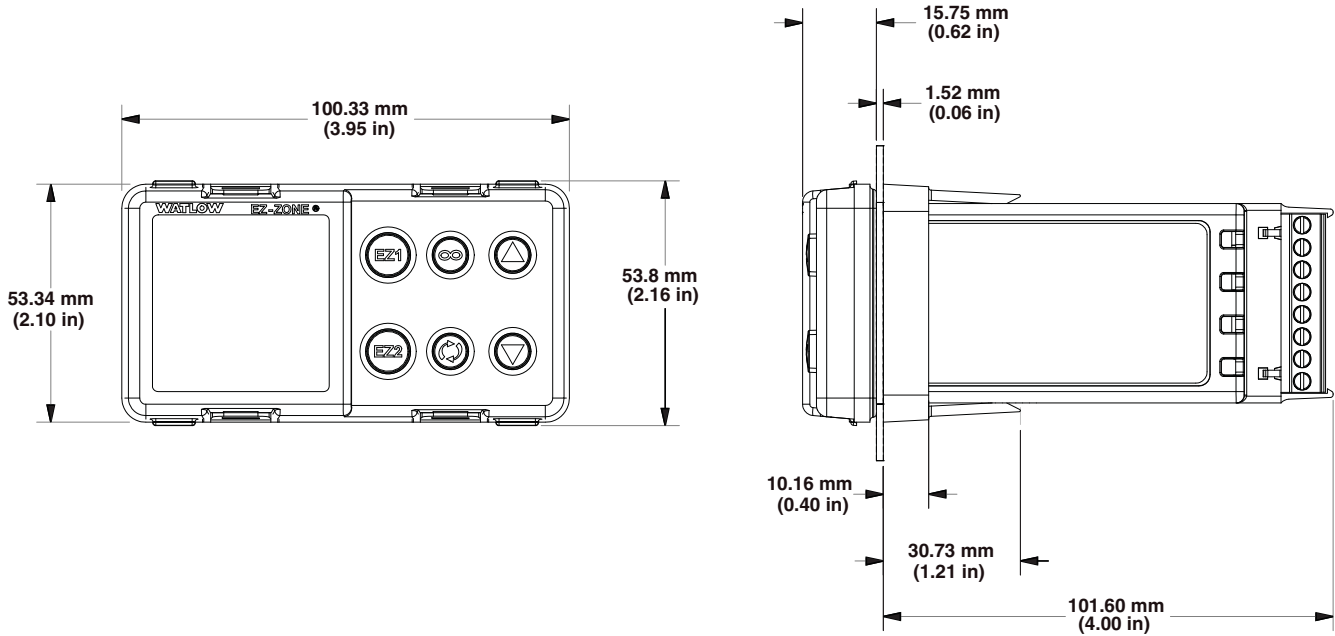

1/8 DIN (PM9) Horizontal Recommended Panel Spacing

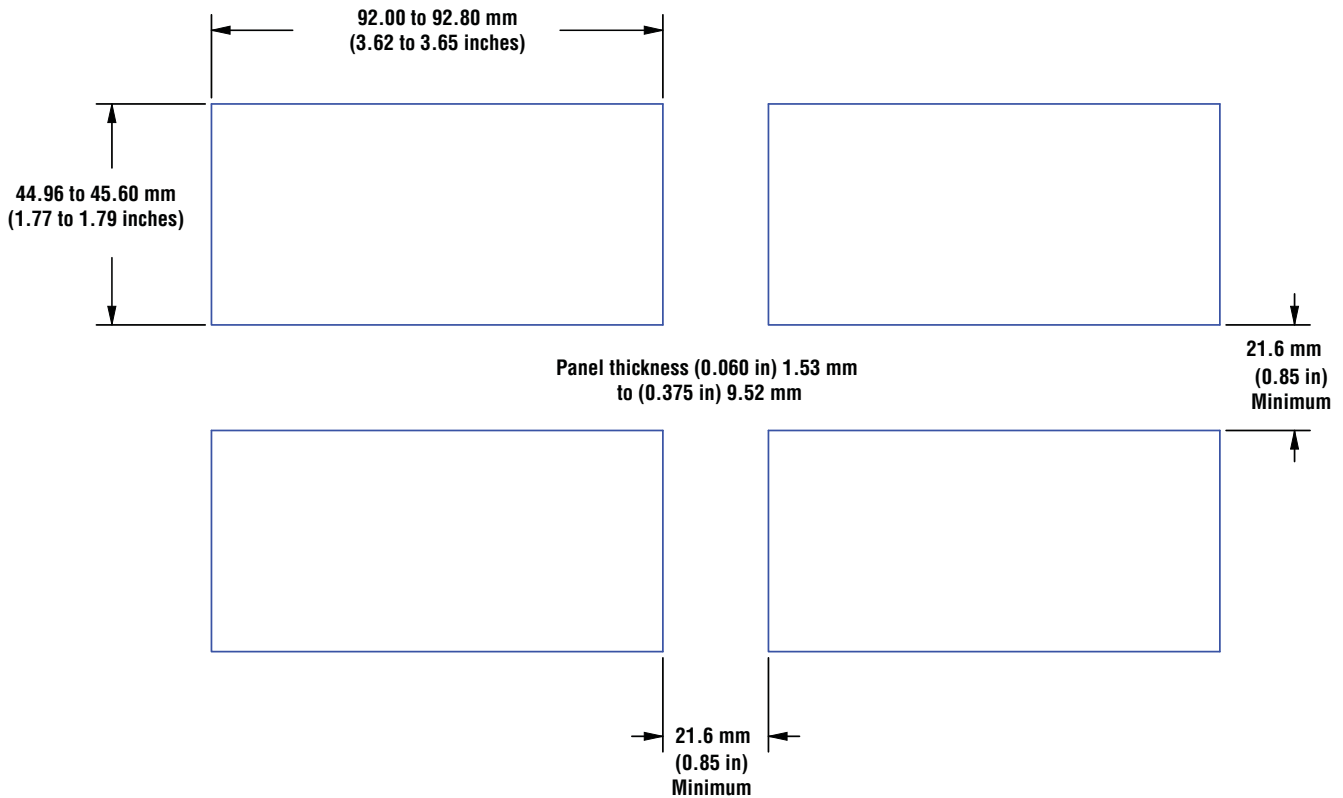

1/4 DIN (PM4) Dimensions

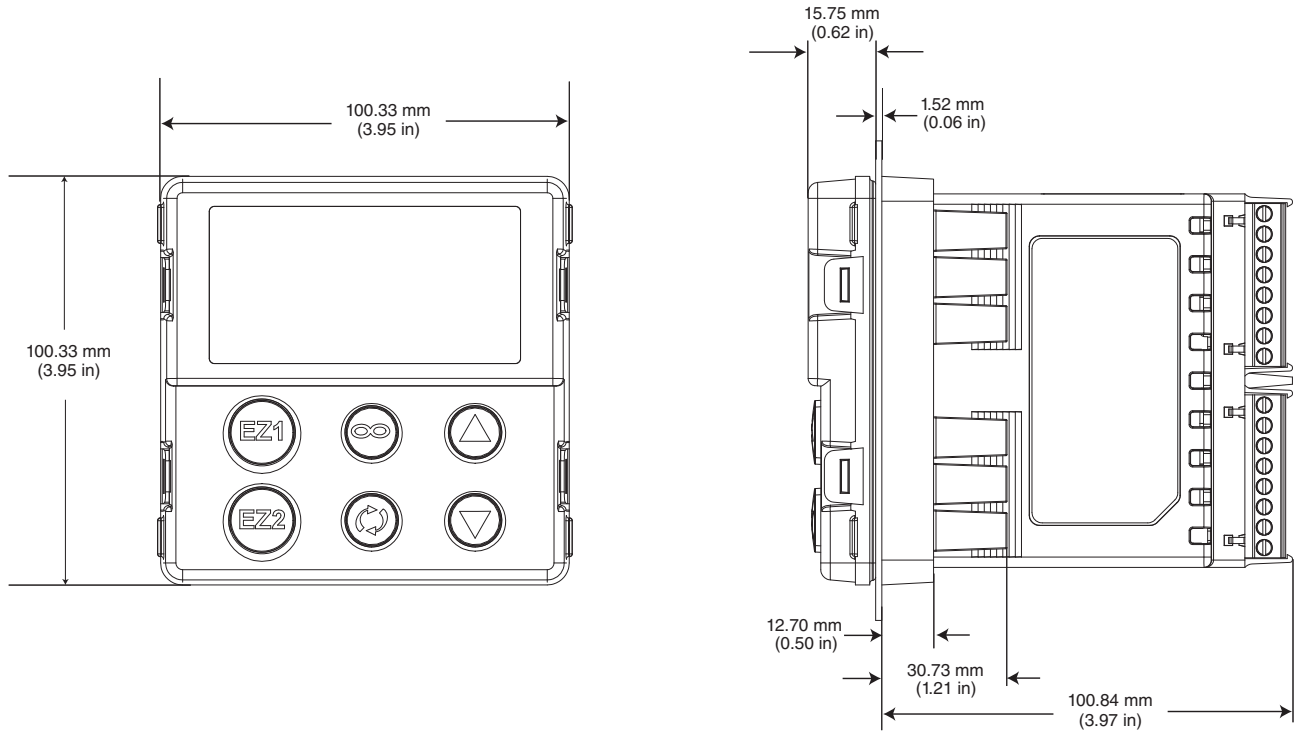

1/4 DIN (PM4) Recommended Panel Spacing

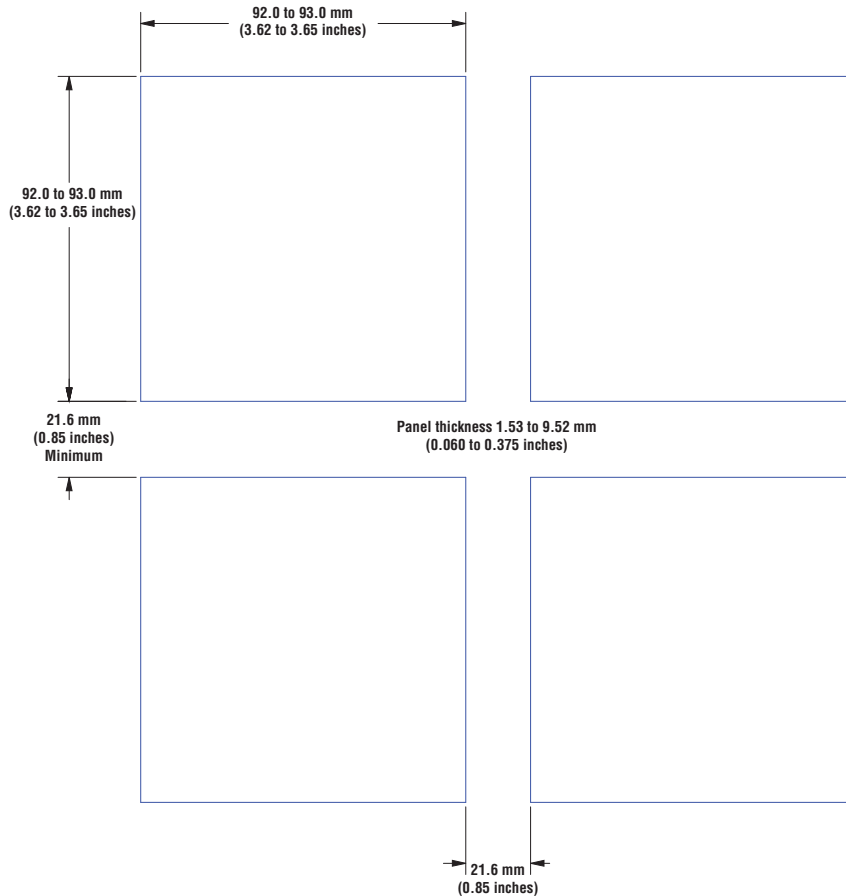

Installation

1. Make the panel cutout using the mounting template dimensions in this chapter. Insert the case assembly into the panel cutout.
2. While pressing the case assembly firmly against the panel, slide the mounting collar over the back of the controller. If the installation does not require a NEMA 4X seal, simply slide together until the gasket is compressed.
3. For a NEMA 4X (UL50, IP65) seal, alternately place and push the blade of a screwdriver against each of the the four corners of the mounting collar assembly. Apply pressure to the face of the controller while pushing with the screwdriver. Don't be afraid to apply enough pressure to properly install the controller. The seal system is compressed more by mating the mounting collar tighter to the front panel (see pictures above). If you can move the case assembly back and forth in the cutout, you do not have a proper seal. The tabs on each side of the mounting collar have teeth that latch into the ridges on the sides of the controller. Each tooth is staggered at a different depth from the front so that only one of the tabs, on each side, is locked onto the ridges at a time.

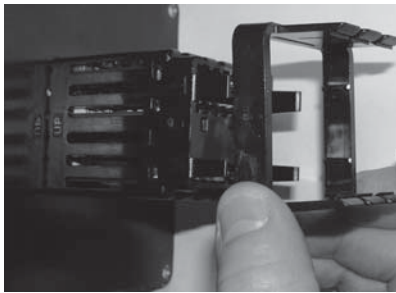
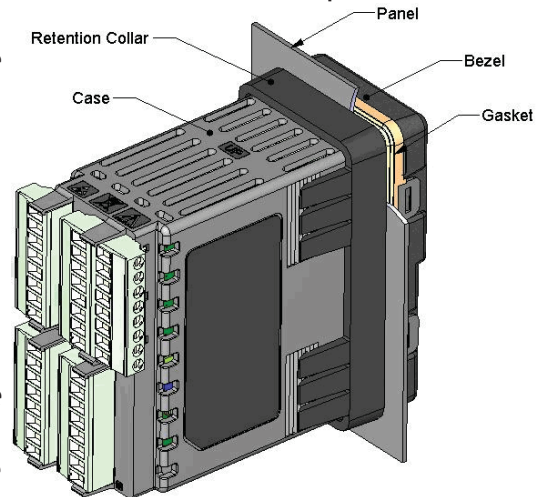

Slide the mounting collar over the back of the controller.

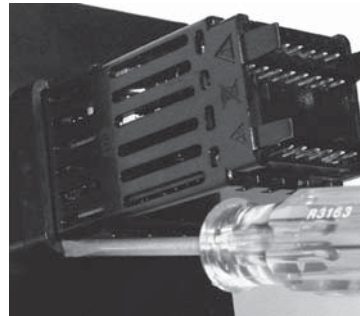

Place the blade of a screwdriver in any of the corner of the mounting collar assembly.

Note:

There is a graduated measurement difference between the upper and lower half of the display to the panel. In order to meet the seal requirements mentioned above, ensure that the distance from the front of the top half of the display to the panel is 16 mm (0.630 in.) or less, and the distance from the front of the bottom half and the panel is 13.3 mm (0.525 in.) or less.

Removing the Mounted Controller from Its Case

1. From the controller's face, pull out the tabs on each side until you hear it click.



Pull out the tab on each side until you hear it click.

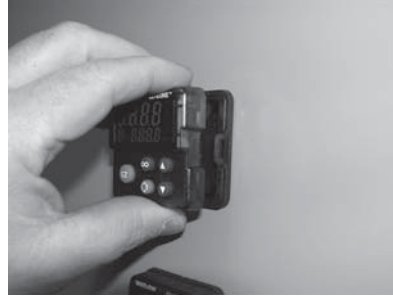

Grab the unit above and below the face and pull forward.

2. Grab the unit above and below the face with two hands and pull the unit out. On the PM4/8/9 controls slide a screwdriver under the pry tabs and turn.

WARNING!

- This equipment is suitable for use in class 1, div. 2, Groups A, B, C and D or Non-Hazardous locations only. Temperature Code T4A.
- WARNING - EXPLOSION HAZARD. Substitution of component may impair suitability for class 1, div. 2.
- WARNING - EXPLOSION HAZARD. Do not disconnect equipment unless power has been switched off or the area is known to be nonhazardous.

Returning the Controller to its Case

1. Ensure that the orientation of the controller is correct and slide it back into the housing.

Note:

The controller is keyed so if it feels that it will not slide back in do not force it. Check the orientation again and reinsert after correcting.

2. Using your thumbs push on either side of the controller until both latches click.

Chemical Compatibility

This product is compatible with acids, weak alkalis, alcohols, gamma radiation and ultra-violet radiation. This product is not compatible with strong alkalis, organic solvents, fuels, aromatic hydrocarbons, chlorinated hydrocarbons, esters and ketones.

WARNING!

All electrical power to the controller and controlled circuits must be disconnected before removing the controller from the front panel or disconnecting other wiring. Failure to follow these instructions may cause an electrical shock and/or sparks that could cause an explosion in class 1, div. 2 hazardous locations.

Wiring

Slot A		Slot B		Slot D		Slot E		Terminal Function	Configuration	
Inputs								Universal, RTD and Thermistor Inputs		
1	2	7 - 12								
T1	T2					S2 (RTD) or current +		Input 1: all configurations Input 2: PM _____ - [R,L] _____		
S1	S2					S3 (RTD), thermocouple -, current -, potentiometer wiper, thermistor or volts -				
R1	R2					S1 (RTD), thermocouple +, volts +, potentiometer or thermistor				
Current Transformer Input 2										
	T2 S2					mA ac mA ac		Input 2: PM _____ - [T] _____		
Digital Inputs 7 - 12										
		B7 D7 D8 D9 D10 D11 D12 Z7					Common dc +input dc +input dc +input dc +input dc +input dc +input Internal Supply		Inputs 7 to 12: PM[4,8,9] _____ - [C,D] _____	
Outputs								Switched dc/open collector		
1	2	3	4	7 - 12						
X1		X3				common (Any switched dc output can use this common.) dc- (open collector) dc+		Output 1: PM ____ [C] _ - _____ Output 3: PM _____ - [C] _____		
W1 Y1		W3 Y3								
Switched dc										
	W2 Y2		W4 Y4			dc- dc+		Output 2: PM _____ [C] - _____ Output 4: PM _____ - [C] _____		
Universal Process										
F1 G1 H1		F3 G3 H3				voltage or current - voltage + current +		Output 1: PM ____ [F] _ - _____ Output 3: PM _____ - [F] _____		
Mechanical Relay 5 A, Form C										
L1 K1 J1		L3 K3 J3				normally open common normally closed		Output 1: PM ____ [E] _ - _____ Output 3: PM _____ - [E] _____		
NO-ARC 15 A, Form A										
	L2 K2		L4 K4			normally open common		Output 2: PM ____ [H] - ____ [H*] _____		
Output 4, PM4, PM8 and PM9 only										
Mechanical Relay 5 A, Form A										
	L2 K2		L4 K4			normally open common		Output 2: PM ____ [J] - _____ Output 4: PM _____ - [J] _____		

Wiring (cont.)

Slot A		Slot B		Slot D	Slot E	Terminal Function	Configuration
Outputs (cont.)					Solid-State Relay 0.5 A, Form A		
1	2	3	4	7 - 12			
L1 K1	L2 K2	L3 K3	L4 K4			normally open common	Output 1: PM ___ [K] _ - _____ Output 2: PM ___ [K] - _____ Output 3: PM _____ - [K] _____ Output 4: PM _____ - [K] _____
Digital Outputs							
				B7 D7		Common switched dc/open collector	PM[4,8,9] _____ - [C, D] _____
				D8		switched dc/open collector	
				D9		switched dc/open collector	
				D10		switched dc/open collector	
				D11		switched dc/open collector	
				D12		switched dc/open collector	
				Z7		Internal Supply	
Communications					Modbus RTU 232/485 Communications		
	CB			CB		Modbus RTU EIA-485 T+/R+	Slot B: PM6 _____ - [2] A A A _____ Slot E: PM[4,8,9] _____ - [2,D] _____
	CA CC			CA CC		Modbus RTU EIA-485 T-/R- Modbus RTU EIA-485 common	
	CB			CB		Modbus RTU EIA-485 T+/R+	
	CA C5			CA C5		Modbus RTU EIA-485 T-/R- Modbus RTU EIA-232 common	
	C3			C3		Modbus RTU EIA-232 to DB9 pin 2	
	C2			C2		Modbus RTU EIA-232 to DB9 pin 3	
DeviceNet™ Communications							
	V+ CH			V+ CH		DeviceNet power Positive side of DeviceNet bus	Slot B: PM6 _____ - [5] A A A _____ Slot E: PM[4,8,9] _____ - [5] _____
	SH CL			SH CL		Shield interconnect Negative side of DeviceNet bus	
	V-			V-		DeviceNet power return	

Wiring (cont.)

Slot A	Slot B	Slot D	Slot E	Terminal Function	Configuration
Communications (cont.)				EtherNet/IP™ and Modbus® TCP	
	E8		E8	unused	Slot B: PM6 _ _ _ _ - [3] A A A _ _ _
	E7		E7	unused	Slot E: PM[4,8,9] _ _ _ _ - [3] _ _ _ _ _
	E6		E6	EtherNet/IP and Modbus TCP receive -	
	E5		E5	unused	
	E4		E4	unused	
	E3		E3	EtherNet/IP and Modbus TCP receive +	
	E2		E2	EtherNet/IP and Modbus TCP transmit -	
	E1		E1	EtherNet/IP and Modbus TCP transmit +	
Profibus DP Communications					
	VP		VP	Voltage Potential	Slot B: PM6 _ _ _ _ - [6] AAA _ _ _
	B		B	EIA-485 T+/R+	Slot E: PM [4, 8, 9] _ _ _ _ - [6] AAAAAA
	A		A	EIA-485 T-/R-	
	DG		DG	Digital ground (common)	
	trB		trB	Termination resistor B	
	B		B	EIA-485 T+/R+	
	A		A	EIA-485 T-/R-	
	trA		trA	Termination resistor A	
J1939 CAN bus Communications					
	CL		CL	Negative side of CAN bus	Slot B: PM6 _ _ _ _ - [7] A A A _ _ _
	CH		CH	Positive side of CAN bus	Slot E: PM[4,8,9] _ _ _ _ - [7] _ _ _ _ _
	SH		SH	Shield interconnect	
	V+		V+	CAN bus power	
	V-		V-	CAN bus power return	

Terminal Definitions for Slot C

Slot C	Terminal Function	Configuration
Power		
98	Power input: ac or dc+	all
99	Power input: ac or dc-	
Standard Bus or Modbus EIA-485		
CC	Standard Bus or Modbus RTU EIA-485 common	PM _ _ _ _ _ - [1] _ _ _ _ _
CA	Standard Bus or Modbus RTU EIA-485 T-/R-	
CB	Standard Bus or Modbus RTU EIA-485 T+/R+	
Standard Bus or Modbus EIA-232/485		
CF	Standard Bus EIA-485 common	PM _ _ _ _ _ - [A,D,2,3,5] _ _ _ _
CD	Standard Bus EIA-485 T-/R-	
CE	Standard Bus EIA-485 T+/R+	
2 - Digital I/O Points		
B5	Digital input-output common	PM _ _ [2] _ _ - _ _ _ _ _
D6	Digital input or output 6	
D5	Digital input or output 5	

Slot Orientation - Back View

1/8 DIN Vertical PM8

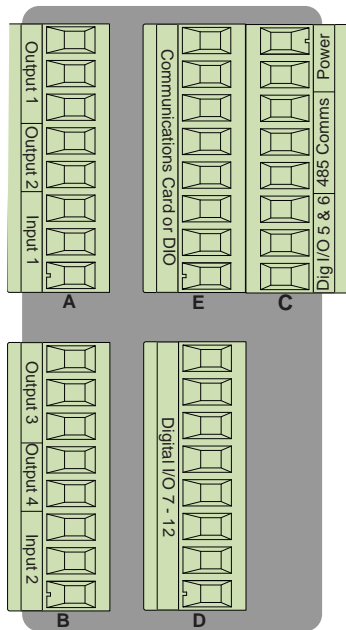

1/8 DIN Horizontal PM9

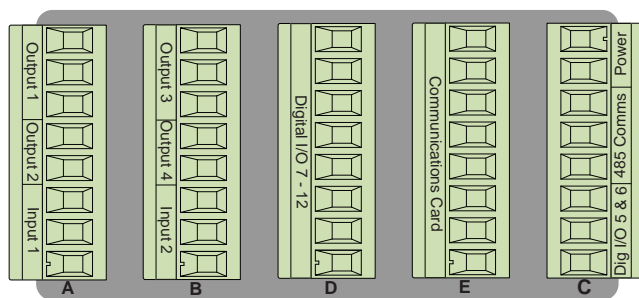

1/4 DIN PM4



1/16 DIN PM6

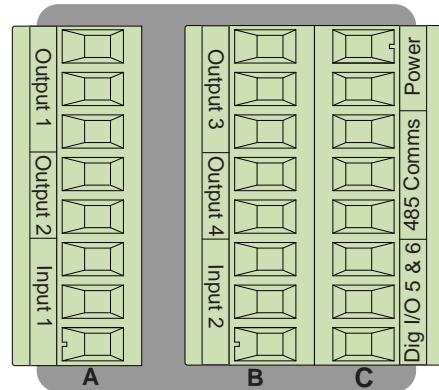

Note:

Slot B above can also be configured with a communications card.

PM Integrated Isolation Block

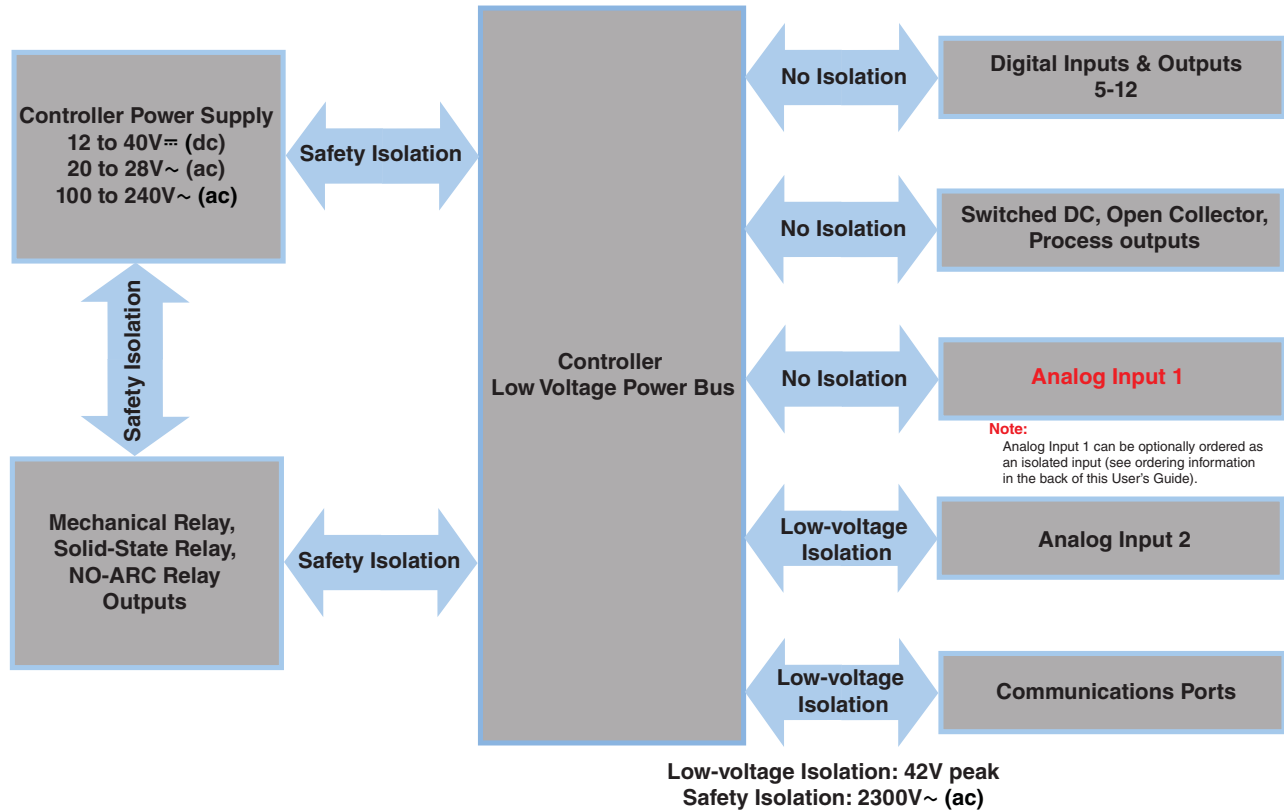

Warning: ⚠

Use National Electric (NEC) or other country-specific standard wiring and safety practices when wiring and connecting this controller to a power source and to electrical sensors or peripheral devices. Failure to do so may result in damage to equipment and property, and/or injury or loss of life.

Note:

Maximum wire size termination and torque rating:

- 0.0507 to 3.30 mm² (30 to 12 AWG) single-wire termination or two 1.31 mm² (16 AWG)
- 0.56 Nm (5.0 in-lb.) torque

Note:

Adjacent terminals may be labeled differently, depending on the model number.

Note:

To prevent damage to the controller, do not connect wires to unused terminals.

Note:

Maintain electrical isolation between analog input 1, digital input-outputs, switched dc/open collector outputs and process outputs to prevent ground loops.

Note:

This equipment is suitable for use in CLASS I, DIVISION 2, Groups A, B, C and D or Non-Hazardous locations only. Temperature Code T4A

Warning: ⚠

Explosion Hazard - Dry contact closure Digital Inputs shall not be used in Class I Division 2 Hazardous Locations unless switch used is approved for this application.

Warning: ⚠

Explosion Hazard – Substitution of component may impair suitability for CLASS I, DIVISION 2.

Warning: ⚠

Explosion Hazard - Do not disconnect while the circuit is live or unless the area is known to be free of ignitable concentrations of flammable substances.

Low Power

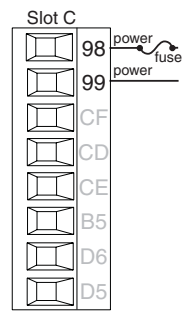

PM__ [3,4] _ _ - _ _ _ _ _

- Minimum/Maximum Ratings
- 12 to 40V $\overline{\text{dc}}$ (dc)
- 20 to 28V \sim (ac) Semi Sig F47
- 47 to 63 Hz
- 14VA maximum power consumption (PM4, 8 and 9)
- 10VA maximum power consumption (PM6)

High Power

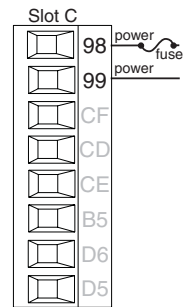

PM__ [1,2] _ _ - _ _ _ _ _

- Minimum/Maximum Ratings
- 85 to 264V \sim (ac)
- 100 to 240V \sim (ac) Semi Sig F47
- 47 to 63 Hz
- 14VA maximum power consumption (PM4, 8 and 9)
- 10VA maximum power consumption (PM6)

Digital Input 5 - 6

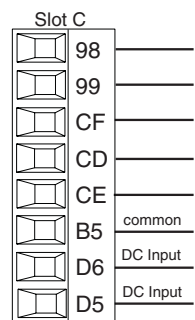

PM __ [2,4] _ _ - _ _ _ _ _

Digital Input

- Update rate 10 Hz
 - Dry contact or dc voltage
- DC Voltage**
- Input not to exceed 36V $\overline{\text{dc}}$ (dc) at 3mA
 - Input active when > 3V $\overline{\text{dc}}$ (dc) @ 0.25mA
 - Input inactive when < 2V

Voltage Input

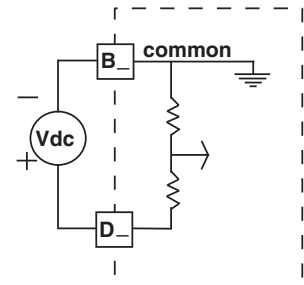

Dry Contact

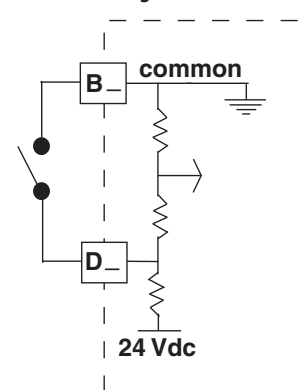

Dry Contact

- Input inactive when > 500 Ω
- Input active when < 100 Ω
- Maximum short circuit 13mA

Warning: ⚠

Use National Electric (NEC) or other country-specific standard wiring and safety practices when wiring and connecting this controller to a power source and to electrical sensors or peripheral devices. Failure to do so may result in damage to equipment and property, and/or injury or loss of life.

Note:

- Maximum wire size termination and torque rating:
- 0.0507 to 3.30 mm² (30 to 12 AWG) single-wire termination or two 1.31 mm² (16 AWG)
 - 0.56 Nm (5.0 in-lb.) torque

Note:

Adjacent terminals may be labeled differently, depending on the model number.

Note:

To prevent damage to the controller, do not connect wires to unused terminals.

Note:

Maintain electrical isolation between analog input 1, digital input-outputs, switched dc/open collector outputs and process outputs to prevent ground loops.

Note:

This equipment is suitable for use in CLASS I, DIVISION 2, Groups A, B, C and D or Non-Hazardous locations only. Temperature Code T4A

Warning: ⚠

Explosion Hazard - Dry contact closure Digital Inputs shall not be used in Class I Division 2 Hazardous Locations unless switch used is approved for this application.

Warning: ⚠

Explosion Hazard – Substitution of component may impair suitability for CLASS I, DIVISION 2.

Warning: ⚠

Explosion Hazard - Do not disconnect while the circuit is live or unless the area is known to be free of ignitable concentrations of flammable substances.

Digital Input 7 - 12

PM [4,8,9] _ _ _ _ [C,D] _ _ _ _

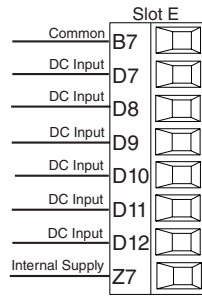

Digital Input Event Conditions

- **Dry Contact**
 - Input inactive when > 100kΩ
 - Input active when < 50Ω
- **Voltage**
 - Input inactive when < 2V
 - Input active when > 3V
- Six user configurable digital inputs/outputs per slot
- Slot E DIO 7-12

Voltage Input

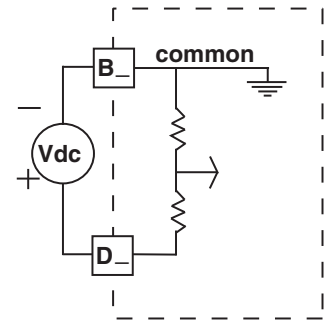

Dry Contact

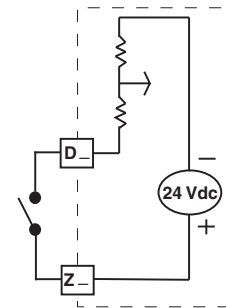

Connecting a Digital Output from Zone 2 to a Digital Input of Zone 1

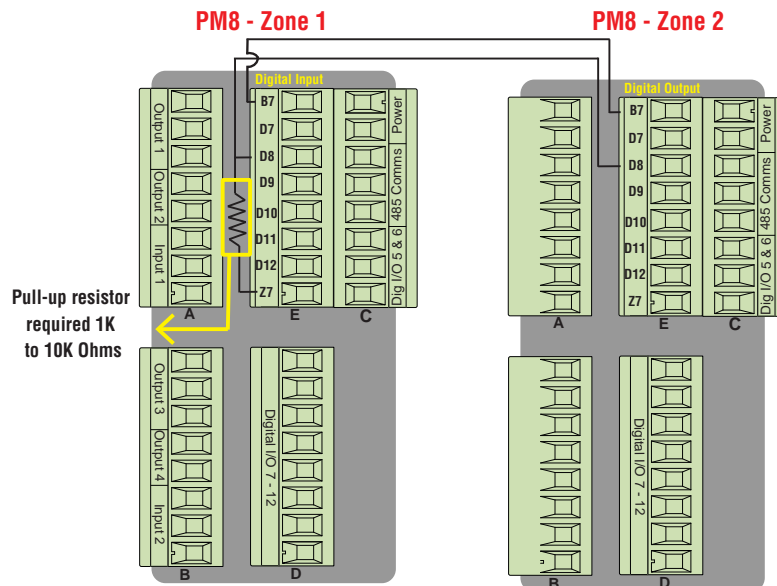

Pull-up resistor required 1K to 10K Ohms

In the example above, digital output D8 from Zone 2 is connected to digital input D8 of Zone 1, configured as a Voltage Input.

Note:

As shown in the graphic above, for this configuration, a pull-up resistor is required.

Warning: ⚠

Use National Electric (NEC) or other country-specific standard wiring and safety practices when wiring and connecting this controller to a power source and to electrical sensors or peripheral devices. Failure to do so may result in damage to equipment and property, and/or injury or loss of life.

Note:

Maximum wire size termination and torque rating:

- 0.0507 to 3.30 mm² (30 to 12 AWG) single-wire termination or two 1.31 mm² (16 AWG)
- 0.56 Nm (5.0 in-lb.) torque

Note:

Adjacent terminals may be labeled differently, depending on the model number.

Note:

To prevent damage to the controller, do not connect wires to unused terminals.

Note:

Maintain electrical isolation between analog input 1, digital input-outputs, switched dc/open collector outputs and process outputs to prevent ground loops.

Note:

This equipment is suitable for use in CLASS I, DIVISION 2, Groups A, B, C and D or Non-Hazardous locations only. Temperature Code T4A

Warning: ⚠

Explosion Hazard - Dry contact closure Digital Inputs shall not be used in Class I Division 2 Hazardous Locations unless switch used is approved for this application.

Warning: ⚠

Explosion Hazard – Substitution of component may impair suitability for CLASS I, DIVISION 2.

Warning: ⚠

Explosion Hazard - Do not disconnect while the circuit is live or unless the area is known to be free of ignitable concentrations of flammable substances.

Input 1, 2 Thermocouple

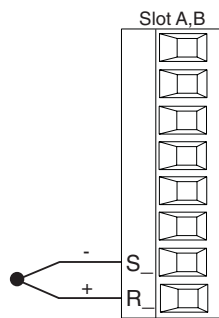

- 2kΩ maximum source resistance
- >20MΩ input impedance
- 3μA open-sensor detection
- Thermocouples are polarity sensitive. The negative lead (usually red) must be connected to S1 and/or S2.
- To reduce errors, the extension wire for thermocouples must be of the same alloy as the thermocouple.

Input 1: PM _ [C,R,B*] _ _ _ - _ _ _ _ _ (S1/R1)

Input 2: PM _ _ _ _ _ - _ [C,R,L] _ _ _ _ _ (S2/R2)

*PM(4, 8 and 9) only

Input 1, 2 RTD

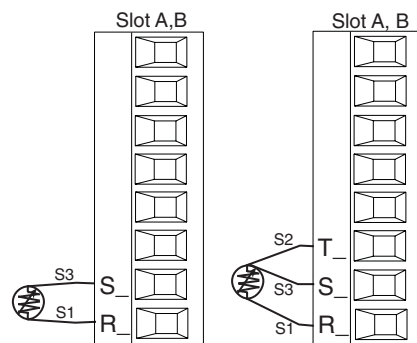

- Platinum, 100 and 1kΩ @ 0°C
- Calibration to DIN curve (0.00385 Ω/Ω/°C)
- 20Ω total lead resistance
- RTD excitation current of 0.09mA typical. Each ohm of lead resistance may affect the reading by 0.03°C.
- For 3-wire RTDs, the S1 lead (usually white) must be connected to R1 and/or R2
- For best accuracy use a 3-wire RTD to compensate for lead-length resistance. All three lead wires must have the same resistance

Input 1: PM _ [C,R,B*] _ _ _ - _ _ _ _ _ (S1/R1), (T1/S1/R1)

Input 2: PM _ _ _ _ _ - _ [C,R,L] _ _ _ _ _ (S2/R2), (T2/S2/R2)

*PM(4, 8 and 9) only

Warning: ⚠

Use National Electric (NEC) or other country-specific standard wiring and safety practices when wiring and connecting this controller to a power source and to electrical sensors or peripheral devices. Failure to do so may result in damage to equipment and property, and/or injury or loss of life.

Note:

Maximum wire size termination and torque rating:

- 0.0507 to 3.30 mm² (30 to 12 AWG) single-wire termination or two 1.31 mm² (16 AWG)
- 0.56 Nm (5.0 in.-lb.) torque

Note:

Adjacent terminals may be labeled differently, depending on the model number.

Note:

To prevent damage to the controller, do not connect wires to unused terminals.

Note:

Maintain electrical isolation between analog input 1, digital input-outputs, switched dc/open collector outputs and process outputs to prevent ground loops.

Note:

This equipment is suitable for use in CLASS I, DIVISION 2, Groups A, B, C and D or Non-Hazardous locations only. Temperature Code T4A

Warning: ⚠

Explosion Hazard - Dry contact closure Digital Inputs shall not be used in Class I Division 2 Hazardous Locations unless switch used is approved for this application.

Warning: ⚠

Explosion Hazard – Substitution of component may impair suitability for CLASS I, DIVISION 2.

Warning: ⚠

Explosion Hazard - Do not disconnect while the circuit is live or unless the area is known to be free of ignitable concentrations of flammable substances.

Input 1, 2 Process

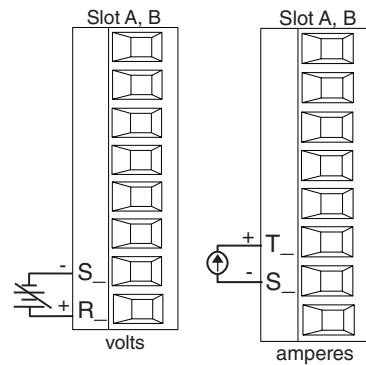

- 0 to 20mA @ 100Ω input impedance
- 0 to 10V_{DC} (dc) @ 20kΩ input impedance
- 0 to 50mV_{DC} (dc) @ 20kΩ input impedance
- Scalable

Input 1: PM _ [C,R,B*] _ _ _ - _ _ _ _ _ (-S1/+R1),(+T1/-S1)

Input 2: PM _ _ _ _ _ - _ [C,R,L] _ _ _ _ _ (-S2/+R2),(+T2/-S2)

*PM(4, 8 and 9) only

Input 1,2 Potentiometer

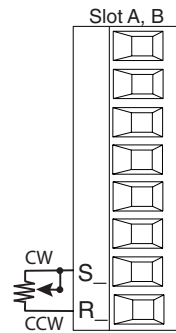

- Use a 1kΩ potentiometer.

Input 1: PM _ [C,R,B*] _ _ _ - _ _ _ _ _ (S1/R1)

Input 2: PM _ _ _ _ _ - _ [C,R,L] _ _ _ _ _ (S2/R2)

* PM(4, 8 and 9) only

Input 1, 2 Thermistor

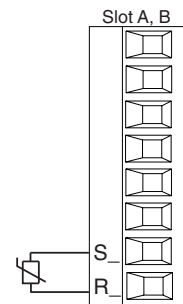

- >20MΩ input impedance
- 3μA open-sensor detection

Input 1: PM _ [J,N,E*] _ _ _ - _ _ _ _ _ (S1/R1)

Input 2: PM _ _ _ _ _ - _ [J,P,M] _ _ _ _ _ (S2/R2)

* For input 1, option E is available with PM4, 8 and 9 models only.

Input 2 Current Transformer

PM _ _ _ _ _ - _ [T] _ _ _ _ _

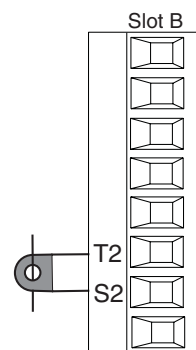

- Input range is 0 to 50mA
- Current transformer part number: 16-0246
- 100Ω input impedance
- Response time: 1 second maximum
- Accuracy +/-1 mA typical

Warning: ⚠

Use National Electric (NEC) or other country-specific standard wiring and safety practices when wiring and connecting this controller to a power source and to electrical sensors or peripheral devices. Failure to do so may result in damage to equipment and property, and/or injury or loss of life.

Note:

Maximum wire size termination and torque rating:

- 0.0507 to 3.30 mm² (30 to 12 AWG) single-wire termination or two 1.31 mm² (16 AWG)
- 0.56 Nm (5.0 in-lb.) torque

Note:

Adjacent terminals may be labeled differently, depending on the model number.

Note:

To prevent damage to the controller, do not connect wires to unused terminals.

Note:

Maintain electrical isolation between digital input-outputs, switched dc/open collector outputs and process outputs to prevent ground loops.

Note:

This equipment is suitable for use in CLASS I, DIVISION 2, Groups A, B, C and D or Non-Hazardous locations only. Temperature Code T4

Warning: ⚠

Explosion Hazard – Substitution of component may impair suitability for CLASS I, DIVISION 2.

Warning: ⚠

Explosion Hazard - Do not disconnect while the circuit is live or unless the area is known to be free of ignitable concentrations of flammable substances.

Quencharc Note:

Switching pilot duty inductive loads (relay coils, solenoids, etc.) with the mechanical relay, solid state relay or open collector output options requires use of an R.C. suppressor.

Example: Using a Current Transformer

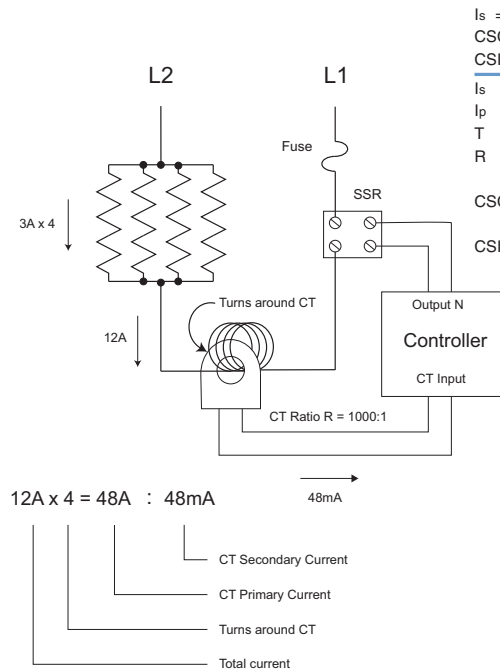

$I_s = I_p T / R = 50\text{mA}$
 $CSC = I_p(\text{full scale}) = 50\text{mA}(R)/T$
 CSI = Output N
 I_s = Current in secondary of current transformer
 I_p = Current in primary of current transformer
 T = Number of turns through the primary of the transformer
 R = Number of turns in the secondary of the current transformer (Turns ratio, assuming one primary turn)
 CSC = Current Scaling (parameter found in Current Menu of Setup Page)
 CSI = Current Source Instance (parameter found in Current Menu of Setup Page)

Digital Output 5 - 6

PM _ _ [2,4] _ _ - - - -

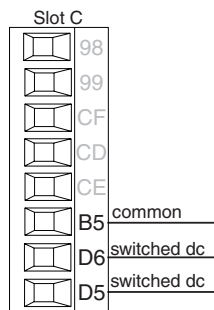

Digital Output

- SSR drive signal
- Update rate 10 Hz
- Maximum open circuit voltage is 22 to 25V_{rms} (dc)
- PNP transistor source
- Typical drive; 21mA @ 4.5V_{rms} (dc) for D05, and 11mA @ 4.5V for D06
- Current limit 24mA for Output 5 and 12mA Output 6
- Output 5 capable of driving one 3-pole DIN-A-MITE
- Output 6 capable of driving one 1-pole DIN-A-MITE

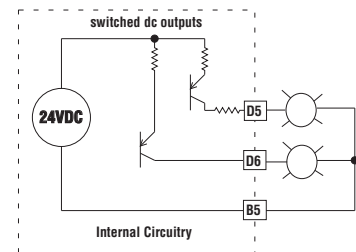

Note:

See output curves below.

Warning: ⚠

Use National Electric (NEC) or other country-specific standard wiring and safety practices when wiring and connecting this controller to a power source and to electrical sensors or peripheral devices. Failure to do so may result in damage to equipment and property, and/or injury or loss of life.

Note:

- Maximum wire size termination and torque rating:
- 0.0507 to 3.30 mm² (30 to 12 AWG) single-wire termination or two 1.31 mm² (16 AWG)
 - 0.56 Nm (5.0 in-lb.) torque

Note:

Adjacent terminals may be labeled differently, depending on the model number.

Note:

To prevent damage to the controller, do not connect wires to unused terminals.

Note:

Maintain electrical isolation between digital input-outputs, switched dc/open collector outputs and process outputs to prevent ground loops.

Note:

This equipment is suitable for use in CLASS I, DIVISION 2, Groups A, B, C and D or Non-Hazardous locations only. Temperature Code T4

Warning: ⚠

Explosion Hazard – Substitution of component may impair suitability for CLASS I, DIVISION 2.

Warning: ⚠

Explosion Hazard - Do not disconnect while the circuit is live or unless the area is known to be free of ignitable concentrations of flammable substances.

Quencharc Note:

Switching pilot duty inductive loads (relay coils, solenoids, etc.) with the mechanical relay, solid state relay or open collector output options requires use of an R.C. suppressor.

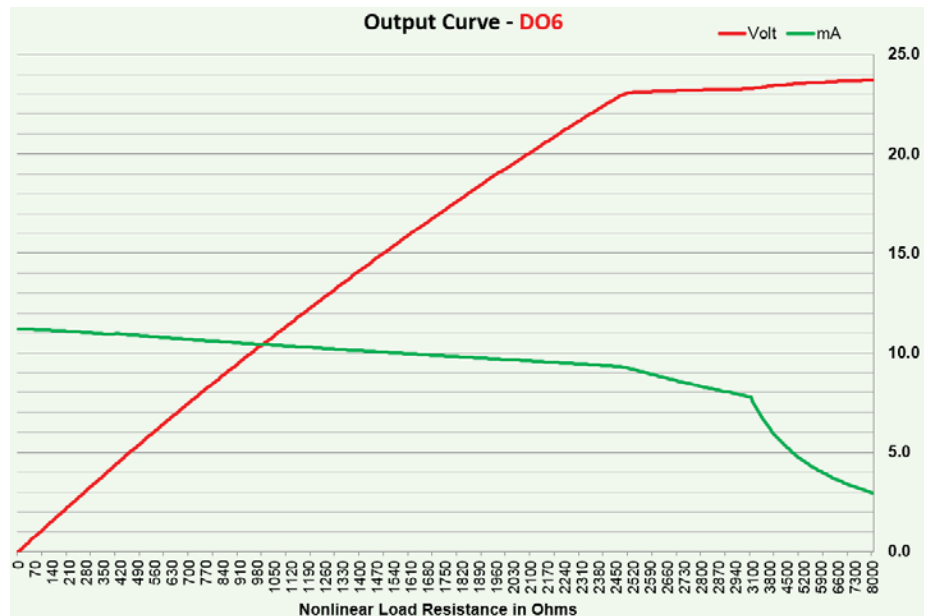
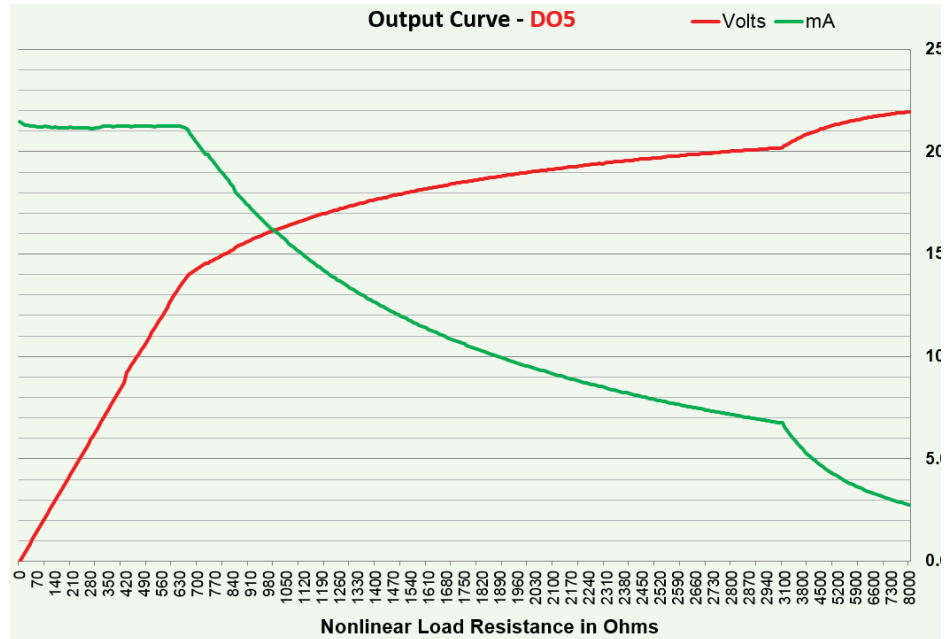

Warning: ⚠

Use National Electric (NEC) or other country-specific standard wiring and safety practices when wiring and connecting this controller to a power source and to electrical sensors or peripheral devices. Failure to do so may result in damage to equipment and property, and/or injury or loss of life.

Note:

- Maximum wire size termination and torque rating:
- 0.0507 to 3.30 mm² (30 to 12 AWG) single-wire termination or two 1.31 mm² (16 AWG)
 - 0.56 Nm (5.0 in.-lb.) torque

Note:

Adjacent terminals may be labeled differently, depending on the model number.

Note:

To prevent damage to the controller, do not connect wires to unused terminals.

Note:

Maintain electrical isolation between digital input-outputs, switched dc/open collector outputs and process outputs to prevent ground loops.

Note:

This equipment is suitable for use in CLASS I, DIVISION 2, Groups A, B, C and D or Non-Hazardous locations only. Temperature Code T4

Warning: ⚠

Explosion Hazard – Substitution of component may impair suitability for CLASS I, DIVISION 2.

Warning: ⚠

Explosion Hazard - Do not disconnect while the circuit is live or unless the area is known to be free of ignitable concentrations of flammable substances.

Quencharc Note:

Switching pilot duty inductive loads (relay coils, solenoids, etc.) with the mechanical relay, solid state relay or open collector output options requires use of an R.C. suppressor.

Switched DC Wiring Example Using DO 5-6

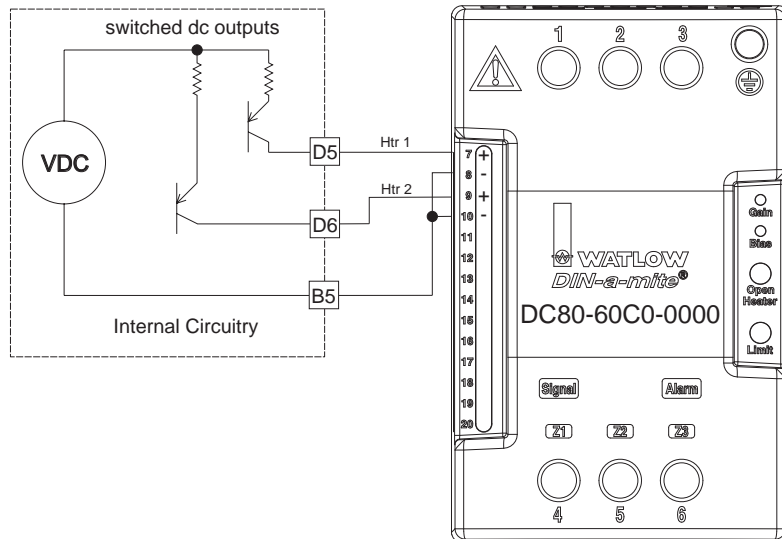

Digital Output 7 - 12

PM [4,6,8] _ _ _ - [C,D] _ _ _ _

Slot D	
B7	Common
D7	Collector out
D8	Collector out
D9	Collector out
D10	Collector out
D11	Collector out
D12	Collector out
Z7	Internal Supply

- Internal supply limited to 400mA, maximum open circuit voltage of 25V_{DC} (dc), typical 8V_{DC} (dc) at 80mA.
- Maximum output sink current per output is 1.5A (external class 2 or *SELV supply required)
- Total sink current for all outputs not to exceed 8A
- Do not connect outputs in parallel
- * Safety Extra Low Voltage

Open Collector Outputs

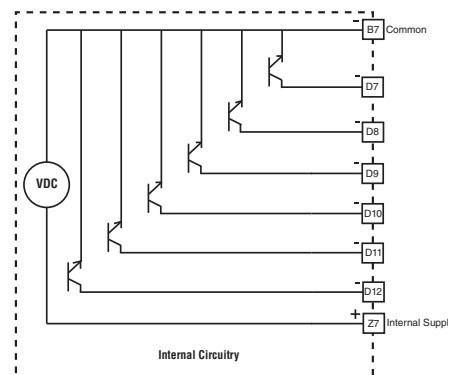

Warning: ⚠

Use National Electric (NEC) or other country-specific standard wiring and safety practices when wiring and connecting this controller to a power source and to electrical sensors or peripheral devices. Failure to do so may result in damage to equipment and property, and/or injury or loss of life.

Note:

- Maximum wire size termination and torque rating:
- 0.0507 to 3.30 mm² (30 to 12 AWG) single-wire termination or two 1.31 mm² (16 AWG)
 - 0.56 Nm (5.0 in-lb.) torque

Note:

Adjacent terminals may be labeled differently, depending on the model number.

Note:

To prevent damage to the controller, do not connect wires to unused terminals.

Note:

Maintain electrical isolation between digital input-outputs, switched dc/open collector outputs and process outputs to prevent ground loops.

Note:

This equipment is suitable for use in CLASS I, DIVISION 2, Groups A, B, C and D or Non-Hazardous locations only. Temperature Code T4

Warning: ⚠

Explosion Hazard – Substitution of component may impair suitability for CLASS I, DIVISION 2.

Warning: ⚠

Explosion Hazard - Do not disconnect while the circuit is live or unless the area is known to be free of ignitable concentrations of flammable substances.

Quencharc Note:

Switching pilot duty inductive loads (relay coils, solenoids, etc.) with the mechanical relay, solid state relay or open collector output options requires use of an R.C. suppressor.

Switched DC Wiring Example Using DO 7-12

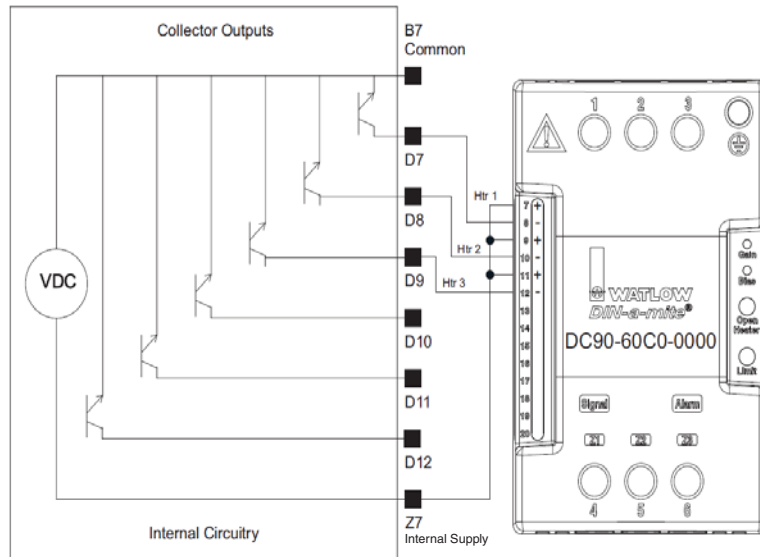

Note:

As a switched DC output; this output is a constant current output delivering 750mW, current limited to 400mA. The internal supply does have a maximum open circuit voltage of 22V_{DC} and minimum open circuit voltage of 19V_{DC}. Pin Z7 is shared to all digital outputs. This type of output is meant to drive solid state relays, not mechanical relays.

As an open collector output, use an external power supply with the negative wired to B7, the positive to the coil of a pilot mechanical relay and the other side of the coil wired to D_. Each open collector output can sink 1.5A with the total for all open collector outputs not exceeding 8A. Ensure that a kickback diode is reversed wired across the relay coil to prevent damage to the internal transistor.

Open Collector Wiring Example Using DO 7-12

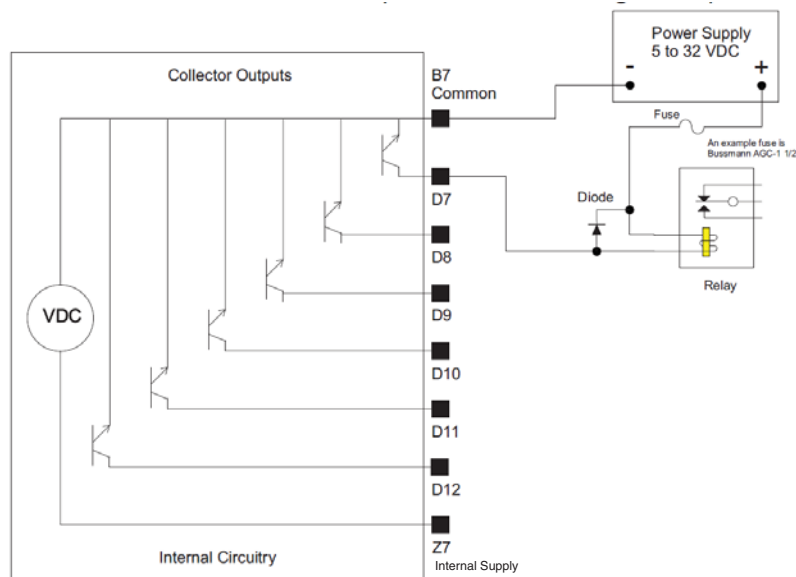

Warning: ⚠

Use National Electric (NEC) or other country-specific standard wiring and safety practices when wiring and connecting this controller to a power source and to electrical sensors or peripheral devices. Failure to do so may result in damage to equipment and property, and/or injury or loss of life.

Note:

Maximum wire size termination and torque rating:

- 0.0507 to 3.30 mm² (30 to 12 AWG) single-wire termination or two 1.31 mm² (16 AWG)
- 0.56 Nm (5.0 in-lb.) torque

Note:

Adjacent terminals may be labeled differently, depending on the model number.

Note:

To prevent damage to the controller, do not connect wires to unused terminals.

Note:

Maintain electrical isolation between digital input-outputs, switched dc/open collector outputs and process outputs to prevent ground loops.

Note:

This equipment is suitable for use in CLASS I, DIVISION 2, Groups A, B, C and D or Non-Hazardous locations only. Temperature Code T4

Warning: ⚠

Explosion Hazard – Substitution of component may impair suitability for CLASS I, DIVISION 2.

Warning: ⚠

Explosion Hazard - Do not disconnect while the circuit is live or unless the area is known to be free of ignitable concentrations of flammable substances.

Quencharc Note:

Switching pilot duty inductive loads (relay coils, solenoids, etc.) with the mechanical relay, solid state relay or open collector output options requires use of an R.C. suppressor.

Output 1, 3 Switched DC/Open Collector

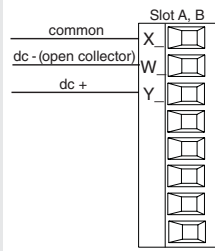

Switched DC

- Maximum open circuit voltage is 22 to 25V $\overline{\text{dc}}$
- 30mA max. per single output / 40mA max. total per paired outputs (1 & 2, 3 & 4)
- Typical drive; 4.5V $\overline{\text{dc}}$ @ 30mA
- Short circuit limited to <50mA
- NPN transistor sink
- Use dc- and dc+ to drive external solid-state relay
- 1-pole DIN-A-MITE: up to 4 in parallel or 4 in series
- 2-pole DIN-A-MITE: up to 2 in parallel or 2 in series
- 3-pole DIN-A-MITE: up to 2 in series

Open Collector

- 100mA maximum output current sink
- 30V $\overline{\text{dc}}$ max. supply voltage
- Any switched dc output can use the common terminal.
- Use an external power supply to control a dc load, with the load positive to the positive of the power supply, the load negative to the open collector and common to the power supply negative.

See Quencharc note.

Switched DC

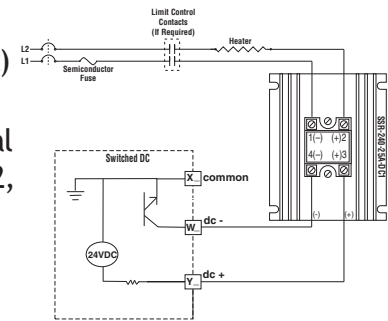

Open Collector

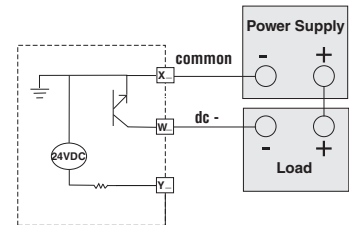

Output 1: (X1, -W1, +Y1)
PM _____ [C] _ - - - - -

Output 3: (X3, -W3, +Y3)
PM _____ - _ _ [C] _ - -

Warning: 

Use National Electric (NEC) or other country-specific standard wiring and safety practices when wiring and connecting this controller to a power source and to electrical sensors or peripheral devices. Failure to do so may result in damage to equipment and property, and/or injury or loss of life.

Note:

Maximum wire size termination and torque rating:

- 0.0507 to 3.30 mm² (30 to 12 AWG) single-wire termination or two 1.31 mm² (16 AWG)
- 0.56 Nm (5.0 in-lb.) torque

Note:

Adjacent terminals may be labeled differently, depending on the model number.

Note:

To prevent damage to the controller, do not connect wires to unused terminals.

Note:

Maintain electrical isolation between digital input-outputs, switched dc/open collector outputs and process outputs to prevent ground loops.

Note:

This equipment is suitable for use in CLASS I, DIVISION 2, Groups A, B, C and D or Non-Hazardous locations only. Temperature Code T4

Warning: 

Explosion Hazard – Substitution of component may impair suitability for CLASS I, DIVISION 2.

Warning: 

Explosion Hazard - Do not disconnect while the circuit is live or unless the area is known to be free of ignitable concentrations of flammable substances.

Quencharc Note:

Switching pilot duty inductive loads (relay coils, solenoids, etc.) with the mechanical relay, solid state relay or open collector output options requires use of an R.C. suppressor.

Output 1, 3 Mechanical Relay, Form C

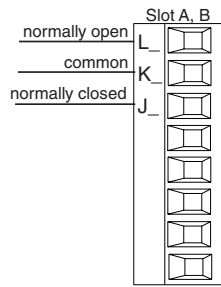

- 5A at 240V~ (ac) or 30V $\overline{=}$ (dc) maximum resistive load
- 20mA at 24V minimum load
- 125VA pilot duty at 120/240V~ (ac), 25VA at 24V~ (ac)
- 100,000 cycles at rated load
- Output does not supply power.
- For use with ac or dc

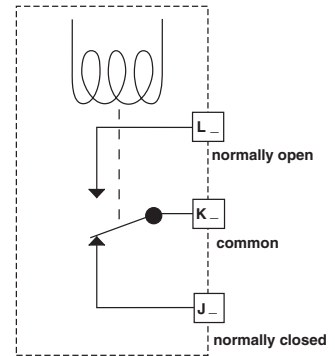

Output 1: (L1,K1,J1)

PM _ _ _ [E] _ - _ _ _ _

_ _ _

Output 3: (L3,K3,J3)

PM _ _ _ _ _ - _ _ [E] _

_ _ _

Output 1, 3 Universal Process

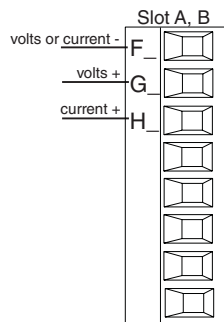

- 0 to 20mA into 800 Ω maximum load
- 0 to 10V $\overline{=}$ (dc) into 1 k Ω minimum load
- Scalable
- Output supplies power
- Cannot use voltage and current outputs at same time
- Output may be used as retransmit or control.

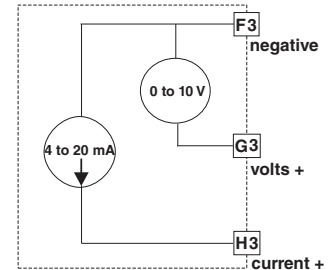

Output 1: (F1,G1,H1)

PM _ _ _ [F] _ - _ _ _ _

_ _ _

Output 3: (F3,G3,H3)

PM _ _ _ _ _ - _ _ [F] _

_ _ _

Warning: ⚠

Use National Electric (NEC) or other country-specific standard wiring and safety practices when wiring and connecting this controller to a power source and to electrical sensors or peripheral devices. Failure to do so may result in damage to equipment and property, and/or injury or loss of life.

Note:

Maximum wire size termination and torque rating:

- 0.0507 to 3.30 mm² (30 to 12 AWG) single-wire termination or two 1.31 mm² (16 AWG)
- 0.56 Nm (5.0 in-lb.) torque

Note:

Adjacent terminals may be labeled differently, depending on the model number.

Note:

To prevent damage to the controller, do not connect wires to unused terminals.

Note:

Maintain electrical isolation between digital input-outputs, switched dc/open collector outputs and process outputs to prevent ground loops.

Note:

This equipment is suitable for use in CLASS I, DIVISION 2, Groups A, B, C and D or Non-Hazardous locations only. Temperature Code T4

Warning: ⚠

Explosion Hazard – Substitution of component may impair suitability for CLASS I, DIVISION 2.

Warning: ⚠

Explosion Hazard - Do not disconnect while the circuit is live or unless the area is known to be free of ignitable concentrations of flammable substances.

Quencharc Note:

Switching pilot duty inductive loads (relay coils, solenoids, etc.) with the mechanical relay, solid state relay or open collector output options requires use of an R.C. suppressor.

Output 1, 3 Solid-State Relay, Form A

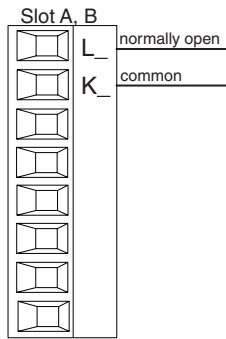

- 0.5A at 20 to 264V~ (ac) maximum resistive load
- 20VA 120/240V~ (ac) pilot duty
- Opto-isolated, without contact suppression
- Maximum off state leakage of 105µA
- Output does not supply power
- Minimum holding current of 10mA
- Do not use on dc loads.
- See Quencharc note

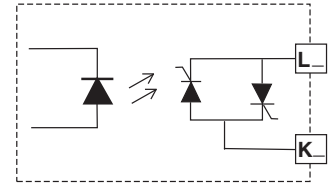

Output 1: (L1, K1)
 PM ___ [K] - - - - -
 - -
 Output 3: (L3, K3)
 PM - - - - - [K] - -
 - -

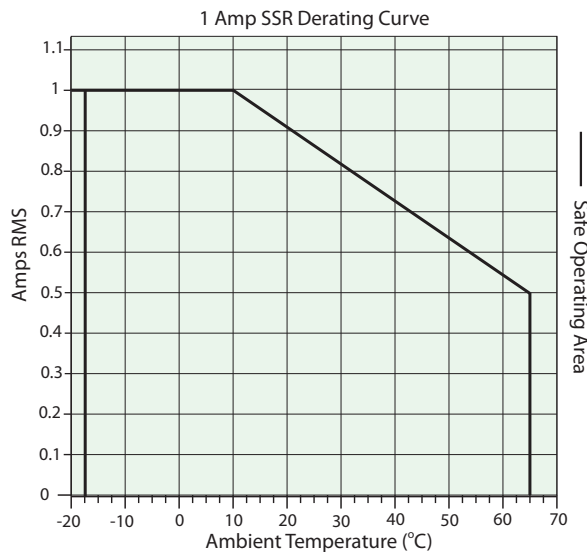

Warning: ⚠

Use National Electric (NEC) or other country-specific standard wiring and safety practices when wiring and connecting this controller to a power source and to electrical sensors or peripheral devices. Failure to do so may result in damage to equipment and property, and/or injury or loss of life.

Note:

Maximum wire size termination and torque rating:

- 0.0507 to 3.30 mm² (30 to 12 AWG) single-wire termination or two 1.31 mm² (16 AWG)
- 0.56 Nm (5.0 in-lb.) torque

Note:

Adjacent terminals may be labeled differently, depending on the model number.

Note:

To prevent damage to the controller, do not connect wires to unused terminals.

Note:

Maintain electrical isolation between digital input-outputs, switched dc/open collector outputs and process outputs to prevent ground loops.

Note:

This equipment is suitable for use in CLASS I, DIVISION 2, Groups A, B, C and D or Non-Hazardous locations only. Temperature Code T4

Warning: ⚠

Explosion Hazard – Substitution of component may impair suitability for CLASS I, DIVISION 2.

Warning: ⚠

Explosion Hazard - Do not disconnect while the circuit is live or unless the area is known to be free of ignitable concentrations of flammable substances.

Quencharc Note:

Switching pilot duty inductive loads (relay coils, solenoids, etc.) with the mechanical relay, solid state relay or open collector output options requires use of an R.C. suppressor.

Output 2, 4 Switched DC

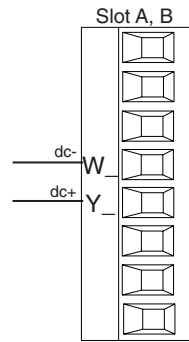

- Maximum open circuit voltage is 22 to 25V_{DC} (dc)
- 30mA max. per single output / 40mA max. total per paired outputs (1 & 2, 3 & 4)
- Typical drive; 4.5V_{DC} (dc) @ 30mA
- Short circuit limited to <50mA
- NPN transistor sink
- Use dc- and dc+ to drive external solid-state relay
- 1-pole DIN-A-MITE: up to 4 in parallel or 4 in series
- 2-pole DIN-A-MITE: up to 2 in parallel or 2 in series
- 3-pole DIN-A-MITE: up to 2 in series

Output 2: (-W2, +Y2)
PM _____ [C] - _____

Output 4: (-W4, +Y4)
PM _____ - _____
[C] _____

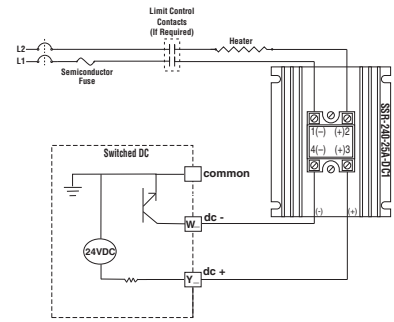

Warning: ⚠

Use National Electric (NEC) or other country-specific standard wiring and safety practices when wiring and connecting this controller to a power source and to electrical sensors or peripheral devices. Failure to do so may result in damage to equipment and property, and/or injury or loss of life.

Note:

Maximum wire size termination and torque rating:

- 0.0507 to 3.30 mm² (30 to 12 AWG) single-wire termination or two 1.31 mm² (16 AWG)
- 0.56 Nm (5.0 in-lb.) torque

Note:

Adjacent terminals may be labeled differently, depending on the model number.

Note:

To prevent damage to the controller, do not connect wires to unused terminals.

Note:

Maintain electrical isolation between digital input-outputs, switched dc/open collector outputs and process outputs to prevent ground loops.

Note:

This equipment is suitable for use in CLASS I, DIVISION 2, Groups A, B, C and D or Non-Hazardous locations only. Temperature Code T4

Warning: ⚠

Explosion Hazard – Substitution of component may impair suitability for CLASS I, DIVISION 2.

Warning: ⚠

Explosion Hazard - Do not disconnect while the circuit is live or unless the area is known to be free of ignitable concentrations of flammable substances.

Quencharc Note:

Switching pilot duty inductive loads (relay coils, solenoids, etc.) with the mechanical relay, solid state relay or open collector output options requires use of an R.C. suppressor.

Output 2, 4 NO-ARC Relay, Form A

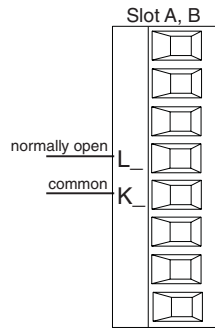

- 15A at 85 to 264V~ (ac) resistive load only
- 2,000,000 cycle rating for NO-ARC circuit
- 100mA minimum load
- 2mA maximum off state leakage
- Do not use on dc loads
- Output does not supply power

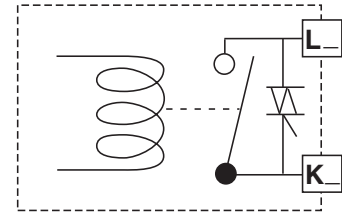

Output 2: (L2, K2)

PM _ _ _ _ [H] - _ _ _ _
_ _ _ _

Output 4: (L4, K4)

PM [4, 8, 9] _ _ _ _ - _ _ _
_ [H] _ _ _ _

Output 2, 4 Mechanical Relay, Form A

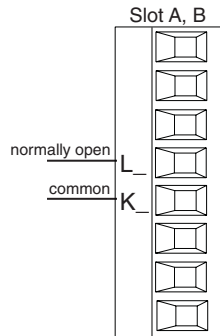

- 5A at 240V~ (ac) or 30V= (dc) maximum resistive load
- 20mA at 24V minimum load
- 125VA pilot duty @ 120/240V~ (ac), 25VA at 24V~ (ac)
- 100,000 cycles at rated load
- Output does not supply power
- For use with ac or dc

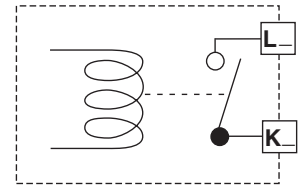

See Quencharc note

Output 2: (L2, K2)

PM _ _ _ _ [J] - _ _ _ _
_ _ _ _

Output 4: (L4, K4)

PM _ _ _ _ - _ _ _ [J] _
_ _ _ _

Warning: ⚠

Use National Electric (NEC) or other country-specific standard wiring and safety practices when wiring and connecting this controller to a power source and to electrical sensors or peripheral devices. Failure to do so may result in damage to equipment and property, and/or injury or loss of life.

Note:

Maximum wire size termination and torque rating:

- 0.0507 to 3.30 mm² (30 to 12 AWG) single-wire termination or two 1.31 mm² (16 AWG)
- 0.56 Nm (5.0 in-lb.) torque

Note:

Adjacent terminals may be labeled differently, depending on the model number.

Note:

To prevent damage to the controller, do not connect wires to unused terminals.

Note:

Maintain electrical isolation between digital input-outputs, switched dc/open collector outputs and process outputs to prevent ground loops.

Note:

This equipment is suitable for use in CLASS I, DIVISION 2, Groups A, B, C and D or Non-Hazardous locations only. Temperature Code T4

Warning: ⚠

Explosion Hazard – Substitution of component may impair suitability for CLASS I, DIVISION 2.

Warning: ⚠

Explosion Hazard - Do not disconnect while the circuit is live or unless the area is known to be free of ignitable concentrations of flammable substances.

Quencharc Note:

Switching pilot duty inductive loads (relay coils, solenoids, etc.) with the mechanical relay, solid state relay or open collector output options requires use of an R.C. suppressor.

Output 2, 4 Solid-State Relay, Form A

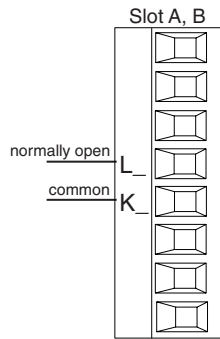

- 0.5A at 20 to 264V~ (ac) maximum resistive load
- 20VA 120/240V~ (ac) pilot duty
- Opto-isolated, without contact suppression
- Maximum off state leakage of 105µA
- Minimum holding current of 10mA
- Output does not supply power
- Do not use on dc loads.

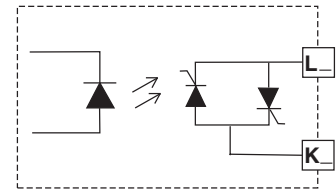

See Quencharc note

Output 2: (L2, K2)
PM _ _ _ _ [K] - _ _ _ _

Output 4: (L4, K4)
PM _ _ _ _ - _ _ _ [K] _

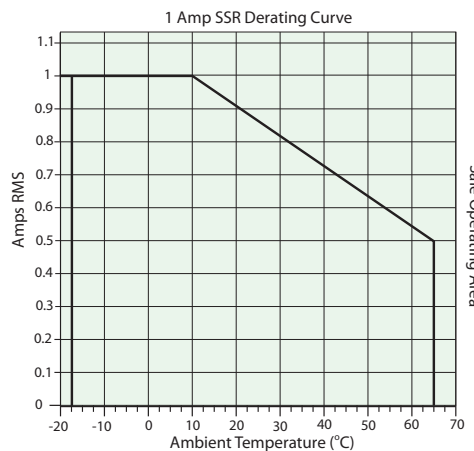

Quencharc Wiring Example

In this example the Quencharc circuit (Watlow part# 0804-0147-0000) is used to protect PM internal circuitry from the counter electromagnetic force from the inductive user load when de-energized. It is recommended that this or an equivalent Quencharc be used when connecting inductive loads to PM outputs.

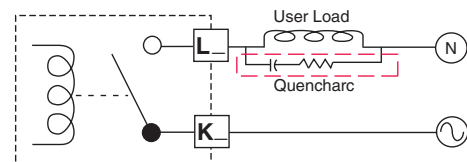

Standard Bus EIA-485 Communications

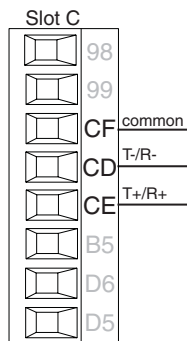

- Wire T-/R- to the A terminal of the EIA-485 port.
- Wire T+/R+ to the B terminal of the EIA-485 port.
- Wire common to the common terminal of the EIA-485 port.
- Do not route network wires with power wires. Connect network wires in daisy-chain fashion when connecting multiple devices in a network.
- Do not connect more than 16 EZ-ZONE PM controllers on a network.
- Maximum network length: 1,200 meters (4,000 feet)
- 1/8th unit load on EIA-485 bus

PM [4,6,8,9] _ _ _ _ - [*] _ _ _ _ _

* All models include Standard Bus communications (instance 1)

Note:

Do not leave a USB to EIA-485 converter connected to Standard Bus without power (i.e., disconnecting the USB end from the computer while leaving the converter connected on Standard Bus). Disturbance on the Standard Bus may occur.

Modbus RTU or Standard Bus EIA-485 Communications

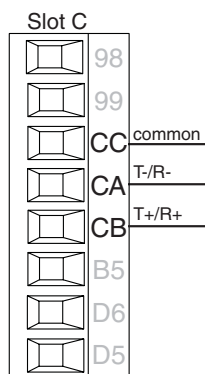

- Wire T-/R- to the A terminal of the EIA-485 port.
- Wire T+/R+ to the B terminal of the EIA-485 port.
- Wire common to the common terminal of the EIA-485 port.
- Do not route network wires with power wires. Connect network wires in daisy-chain fashion when connecting multiple devices in a network.
- A termination resistor may be required. Place a 120 Ω resistor across T+/R+ and T-/R- of last controller on network.
- Only one protocol per port is available at a time: either Modbus RTU or Standard Bus.
- Do not connect more than 16 EZ-ZONE controllers on a Standard Bus network.
- Maximum number of EZ-ZONE controllers on a Modbus network is 247.
- Maximum network length: 1,200 meters (4,000 feet)
- 1/8th unit load on EIA-485 bus.
- Communications instance 1

PM [4,6,8,9] _ _ _ _ - [1] _ _ _ _ _

Note:

Do not leave a USB to EIA-485 converter connected to Standard Bus without power (i.e., disconnecting the USB end from the computer while leaving the converter connected on Standard Bus). Disturbance on the Standard Bus may occur.

EIA-232/485 Modbus RTU Communications

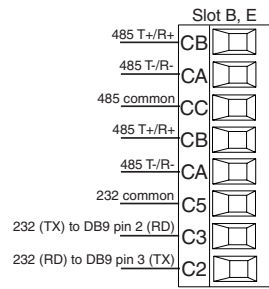

- Wire T-/R- to the A terminal of the EIA-485 port.
- Wire T+/R+ to the B terminal of the EIA-485 port.
- Wire common to the common terminal of the EIA-485 port.
- Do not route network wires with power wires. Connect network wires in daisy-chain fashion when connecting multiple devices in a network.
- A termination resistor may be required. Place a 120 Ω resistor across T+/R+ and T-/R- of last controller on network.
- Do not wire to both the EIA-485 and the EIA-232 pins at the same time.
- Two EIA-485 terminals of T/R are provided to assist in daisy-chain wiring.
- Do not connect more than one EZ-ZONE PM controller on an EIA-232 network.
- Maximum number of EZ-ZONE controllers on a Modbus network is 247.
- Maximum EIA-232 network length: 15 meters (50 feet)
- Maximum EIA-485 network length: 1,200 meters (4,000 feet)
- 1/8th unit load on EIA-485 bus.
- Communications instance 2

Slot B

PM [6] _ _ _ _ - [2] _ _ _ _ _

Slot E

PM [4,8,9] _ _ _ _ - [2,D] _ _ _ _ _

Modbus-IDA Terminal	EIA/TIA-485 Name	Watlow Terminal Label	Function
DO	A	CA or CD	T-/R-
D1	B	CB or CE	T+/R+
common	common	CC or CF	common

EtherNet/IP™, PCCC and Modbus® TCP Communications

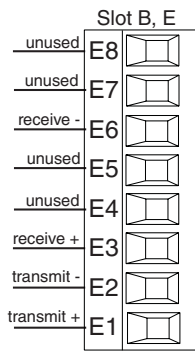

RJ-45 pin	T568B wire color	Signal	Slot B, E
8	brown	unused	E8
7	brown & white	unused	E7
6	green	receive -	E6
5	white & blue	unused	E5
4	blue	unused	E4
3	white & green	receive +	E3
2	orange	transmit -	E2
1	white & orange	transmit +	E1

- Do not route network wires with power wires.
- Connect one Ethernet cable per controller to a 10/100 Mbps Ethernet switch. Both Modbus TCP and EtherNet/IP™ are available on the network.
- Communications instance 2

Slot B

PM [6] _ _ _ _ - [3] _ _ _ _ _

Slot E

PM[4,8,9] _ _ _ _ - [3] _ _ _ _ _

Note:

When changing the fixed IP address cycle module power for new address to take effect.

Ethernet LED Indicators

Viewing the control from the front and then looking on top four LEDs can be seen aligned vertically front to back. The LEDs are identified accordingly: closest to the front reflects the Network (Net) Status, Module (Mod) Status is next, Activity status follows and lastly, the LED closest to the rear of the control reflects the Link status.

Note:

When using Modbus TCP, the Network Status and Module Status LEDs are not used.

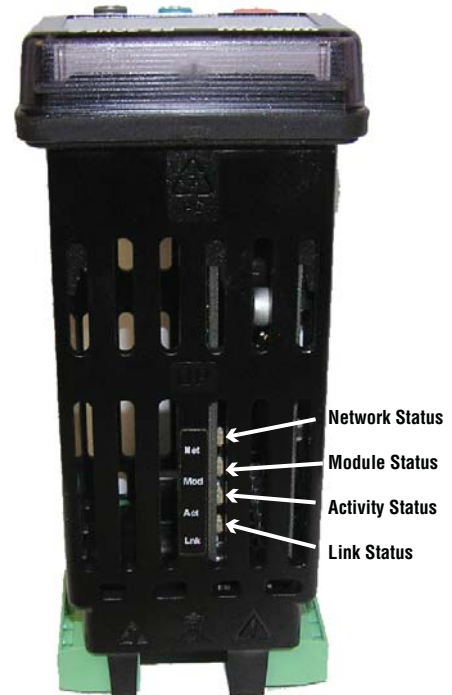

Network Status

Indicator State	Summary	Requirement
Steady Off	Not powered, no IP address	If the device does not have an IP address (or is powered off), the network status indicator shall be steady off.
Flashing Green	No connections	If the device has no established connections, but has obtained an IP address, the network status indicator shall be flashing green.
Steady Green	Connected	If the device has at least one established connection (even to the Message Router), the network status indicator shall be steady green.
Flashing Red	Connection timeout	If one or more of the connections in which this device is the target has timed out, the network status indicator shall be flashing red. This shall be left only if all timed out connections are reestablished or if the device is reset.
Steady Red	Duplicate IP	If the device has detected that its IP address is already in use, the network status indicator shall be steady red.
Flashing Green / Red	Self-test	While the device is performing its power up testing, the network status indicator shall be flashing green / red.

Module Status

Indicator State	Summary	Requirement
Steady Off	No power	If no power is supplied to the device, the module status indicator shall be steady off.
Steady Green	Device operational	If the device is operating correctly, the module status indicator shall be steady green.
Flashing Green	Standby	If the device has not been configured, the module status indicator shall be flashing green.
Flashing Red	Minor fault	If the device has detected a recoverable minor fault, the module status indicator shall be flashing red. NOTE: An incorrect or inconsistent configuration would be considered a minor fault.
Steady Red	Major fault	If the device has detected a non-recoverable major fault, the module status indicator shall be steady red.
Flashing Green / Red	Self-test	While the device is performing its power up testing, the module status indicator shall be flashing green / red.

Activity Status

Indicator State	Summary	Requirement
Flashing Green	Detects activity	If the MAC detects activity, the LED will be flashing green.
Red	- - - -	If the MAC detects a collision, the LED will be red.

Link Status

Indicator State	Summary	Requirement
Steady Off	Not powered, unknown link speed	If the device cannot determine link speed or power is off, the network status indicator shall be steady off.
Green	- - - -	If cable is wired and connected correctly, the LED will be Green.

DeviceNet™ Communications

Slot B, E	Terminal	Signal	Function
V+	V+	V+	DeviceNet™ power
CAN_H	CH	CAN_H	positive side of DeviceNet™ bus
shield	SH	shield	shield interconnect
CAN_L	CL	CAN_L	negative side of DeviceNet™ bus
V-	V-	V-	DeviceNet™ power return

• Communications instance 2
 Slot B (PM [6] _ _ _ _ _ - [5] _ _ _ _ _)
 Slot E (PM [4,8,9] _ _ _ _ _ - [5] _ _ _ _ _)

DeviceNet LED Indicators

Viewing the control from the front and then looking on top two LEDs can be seen aligned vertically front to back. The LED closest to the front is identified as the network (Net) LED where the one next to it would be identified as the module (Mod) LED.

Network Status

Indicator LED	Description
Off	The device is not online and has not completed the duplicate MAC ID test yet. The device may not be powered.
Green	The device is online and has connections in the established state (allcated to a Master).
Red	Failed communication device. The device has detected an error that has rendered it incapable of communicating on the network (duplicate MAC ID or Bus-off).
Flashing Green	The device is online, but no connection has been allocated or an explicit connection has timed out.
Flashing Red	A poll connection has timed out.

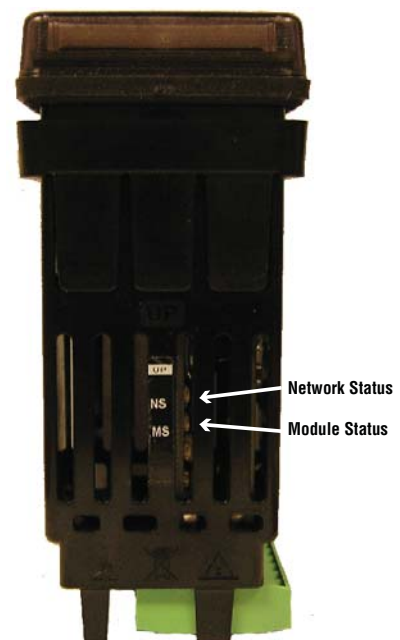

Module Status

Indicator LED	Description
Off	No power is applied to the device.
Flashing Green-Red	The device is performing a self-test.
Flashing Red	Major Recoverable Fault.
Red	Major Unrecoverable Fault.
Green	The device is operating normally.

J1939 CAN bus Communications

Terminal	Signal	Function
CL	CAN_L	negative side of CAN bus
CH	CAN_H	positive side of CAN bus
SH	shield	shield interconnect
V+	V+	CAN bus power
V-	V-	CAN bus power return

Slot B, E	Terminal	Signal	Function
CAN_L	CL	CAN_L	negative side of CAN bus
CAN_H	CH	CAN_H	positive side of CAN bus
Shield	SH	shield	shield interconnect
Volts +	V+	V+	CAN bus power
Volts -	V-	V-	CAN bus power return

- Communications instance 2

Slot B (PM [6] _____ - [7] _____)
 Slot E (PM [4,8,9] _____ - [7] _____)

J1939 LED Indicators

Viewing the control from the rear and then looking on top, two LEDs can be seen aligned vertically front to back. The LED closest to the front is identified as CAN 2 (channel 2, currently not used) where the one closet to the connector is identified as CAN 1 (channel 1).

CAN 1

Indicator LED	Description
Off	CAN communications with J1939 Card inactive.
Flashing Red	New CAN frame transmission occurred.
Flashing Green	CAN communications active with J1939 Card.



Profibus DP Communications

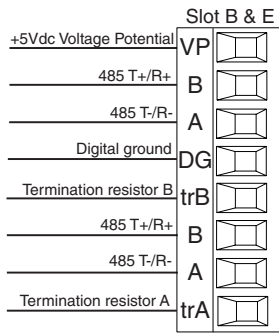

- Wire T-/R- to the A terminal of the EIA-485 port.
- Wire T+/R+ to the B terminal of the EIA-485 port.
- Wire Digital Ground to the common terminal of the EIA-485 port.
- Do not route network wires with power wires. Connect network wires in daisy-chain fashion when connecting multiple devices in a network.
- A termination resistor should be used if this control is the last one on the network.
- If using a 150 Ω cable Watlow provides internal termination. Place a jumper across pins trB and B and trA and A.
- If external termination is to be used with a 150 Ω cable place a 390 Ω resistor across pins VP and B, a 220 Ω resistor across pins B and A, and lastly, place a 390 Ω resistor across pins DG and A.
- Do not connect more than 32 EZ-ZONE PM controllers on any given segment.
- Maximum EIA-485 network length: 1,200 meters (4,000 feet)
- 1/8th unit load on EIA-485 bus
- When termination jumpers are in place, there is 392 ohm pull up resistor to 5V and 392 ohm pull down resistor to DP. There is also a 221 ohm resistor between A and B.
- Communications instance 2

Slot B: PM [6] _ _ _ _-[6] _ _ _ _ _ _

Slot E: PM [4, 8, 9] _ _ _ _-[6] _ _ _ _ _ _

Profibus Terminal	EIA/TIA-485 Name	Watlow Terminal Label	Function
VP (Voltage Potential)	- - - -	VP	+5Vdc
B-Line	B	B	T+/R+
A-Line	A	A	T-/R-
DP-GND	common	DG	common

Profibus DP LED Indicators

Viewing the unit from the front and then looking on top of the controller two bi-color LEDs can be seen where only the front one is used. Definition follows:

Closest to the Front

Indicator LED	Description
Red	Profibus network not detected
Red Flashing	Indicates that the Profibus card is waiting for data exchange.
Green	Data exchange mode

Wiring a Serial EIA-485 Network

Do not route network wires with power wires. Connect network wires in daisy-chain fashion when connecting multiple devices in a network. A termination resistor may be required. Place a 120 Ω resistor across T+/R+ and T-/R- of the last controller on a network.

Only one protocol per port is available at a time: either Modbus RTU or Standard Bus.

A Network using Watlow's Standard Bus and an RUI/Gateway.

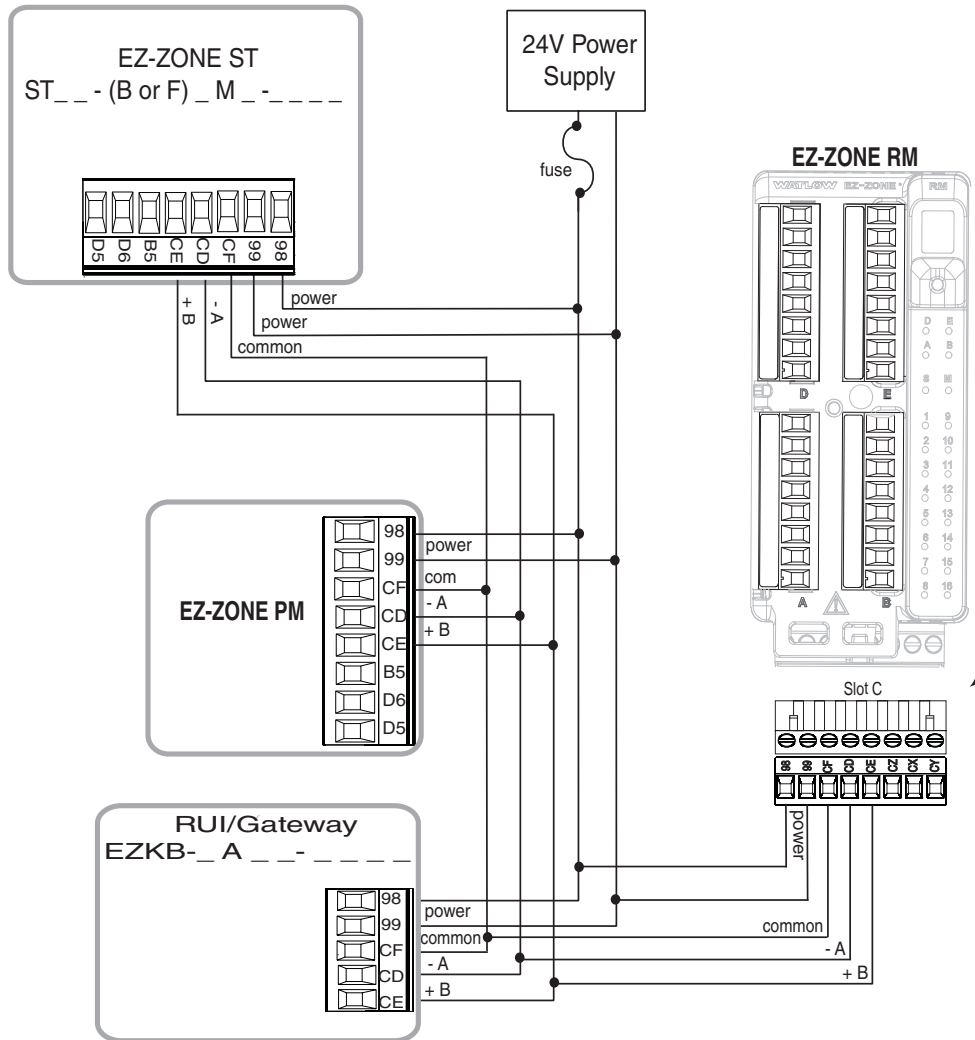

A Network with all Devices Configured using Modbus RTU.

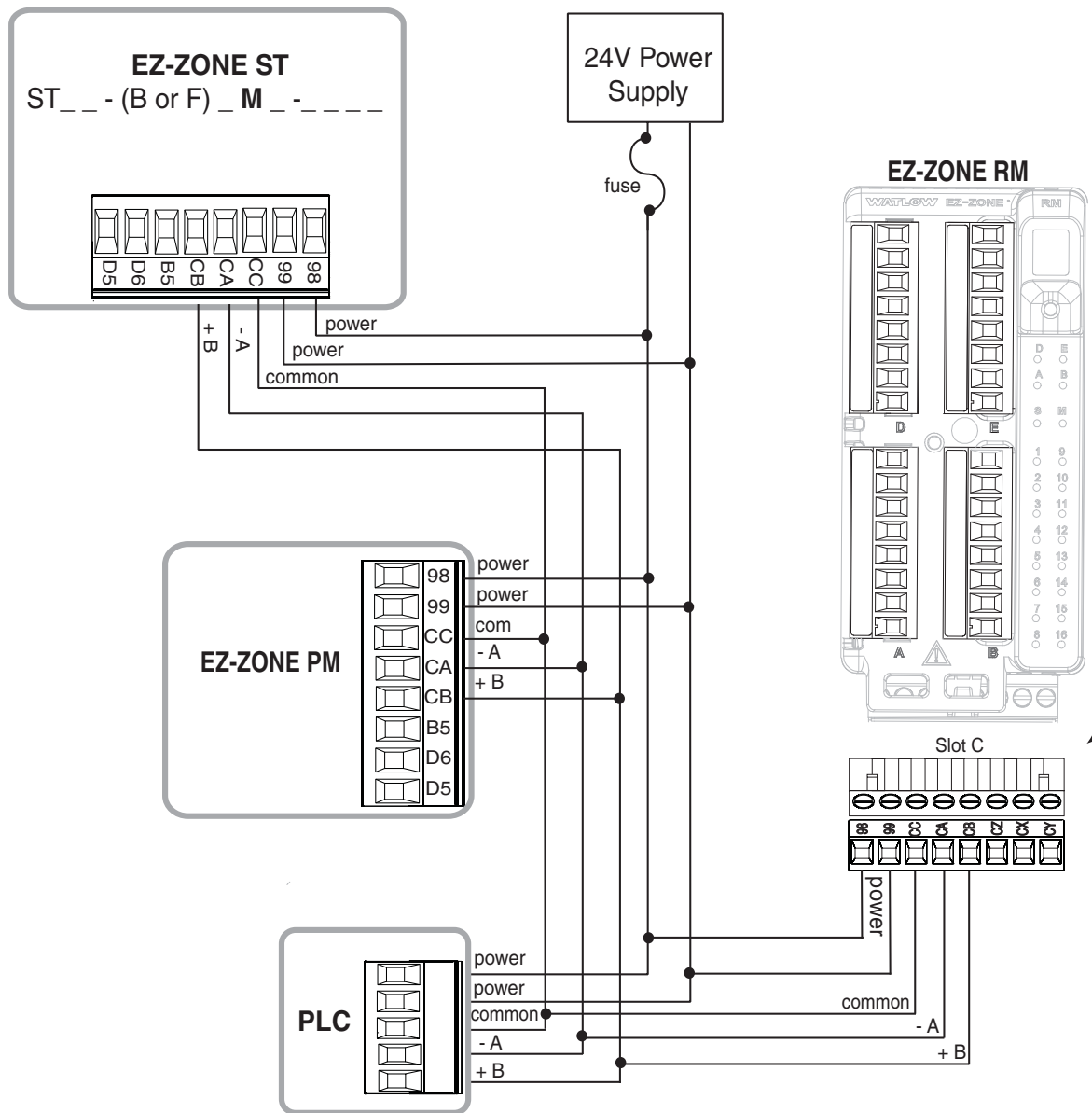

Connecting a Computer to PM Controls Using B&B 485 to USB Converter

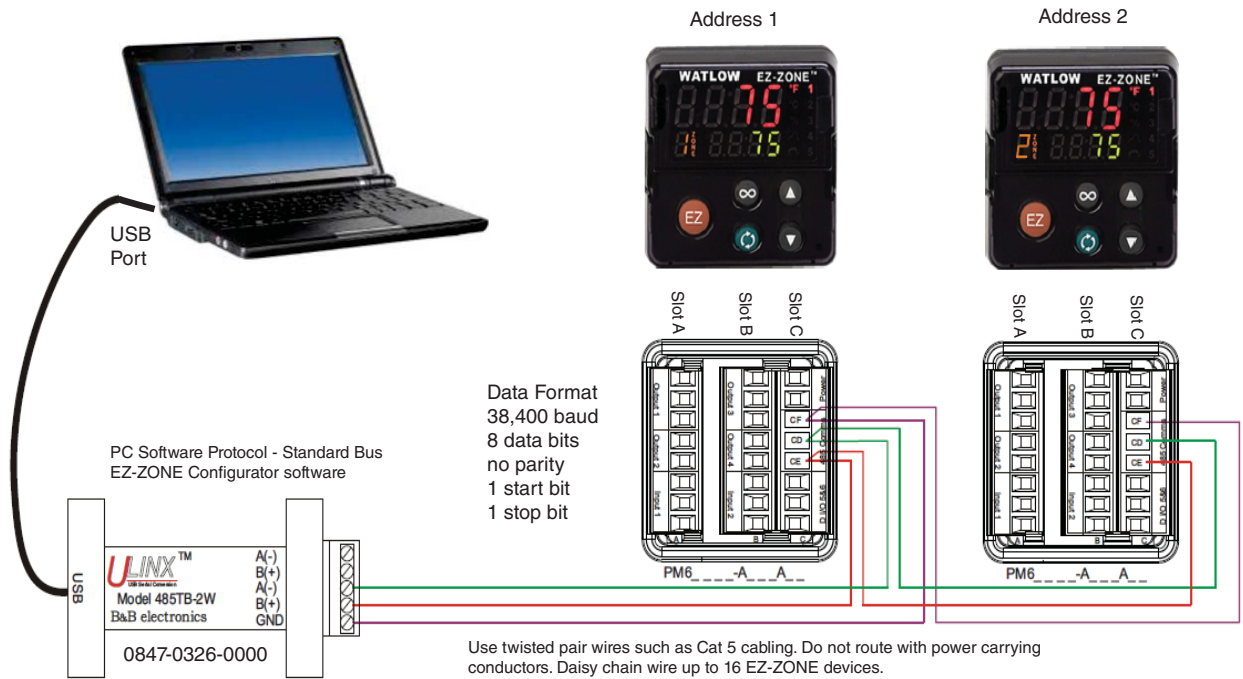

Note:

Do not leave a USB to EIA-485 converter connected to Standard Bus without power (i.e., disconnecting the USB end from the computer while leaving the converter connected on Standard Bus). Disturbance on the Standard Bus may occur.

Note:

When connecting the USB converter to the PC it is suggested that the Latency Timer be changed from the default of 16 msec to 1 msec. Failure to make this change may cause communication loss between the PC running EZ-ZONE Configurator software and the control.

To modify Latency Timer settings follow the steps below:

1. Navigate to Device Manager.
2. Double click on Ports.
3. Right click on the USB serial port in use and select Properties.
4. Click the tab labeled Port settings and then click the Advance button.

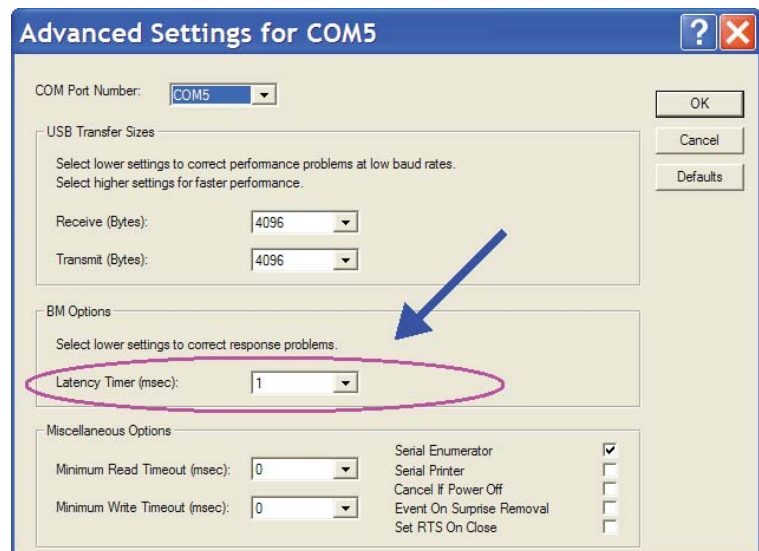

3

Chapter 3: Keys and Displays

Upper Display:

In the Home Page, displays the process value, otherwise displays the value of the parameter in the lower display.

Zone Display:

Indicates the controller zone.

i to *q* = zones 1 to 9

A = zone 10 *E* = zone 14

b = zone 11 *F* = zone 15

C = zone 12 *h* = zone 16

d = zone 13

Lower Display:

Indicates the set point or Manual Power value during operation, or the parameter whose value appears in the upper display.

EZ Key/s:

This key can be programmed to do various tasks, such as starting a profile.

Channel Display:

Indicates the channel for any given EZ-ZONE module.

- Available with the PM4, 8 and 9 only.

Advance Key

Advances through parameter prompts.

Note:

Upon power up, the upper or left display will briefly indicate the firmware revision and the lower or right display will show PM representing the model.

1/8 DIN (PM9) Horizontal

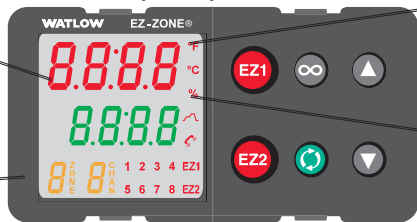

1/16 (PM6) DIN

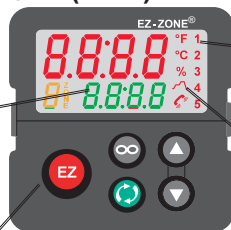

1/8 DIN (PM8) Vertical



1/4 DIN (PM4)

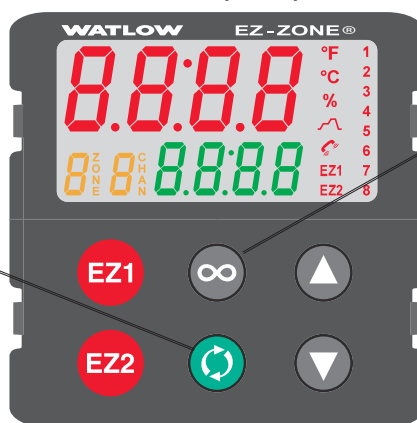

Temperature Units:

Indicates whether the temperature is displayed in Fahrenheit or Celsius.

Percent Units:

Lights when the controller is displaying values as a percentage or when the Manual Power is displayed.



Output Activity:

Number LEDs indicate activity of outputs. A flashing light indicates output activity.

Profile Activity:

Lights when a profile is running. Flashes when a profile is paused.

Communications Activity
Flashes when another device is communicating with this controller.

Up and Down Keys  
In the Home Page, adjusts the set point in the lower display. In other pages, changes the upper display to a higher or lower value, or changes a parameter selection.

Infinity Key



Press to back up one level, or press and hold for two seconds to return to the Home Page. From the Home Page clears alarms and errors if clearable.





Note:







If integrated limit, the Infinity Key is labeled Reset 

Responding to a Displayed Message

Attention Codes

An active message (see Home Page for listing) will cause the display to toggle between the normal settings and the active message in the upper display and Attention *ALLn* in the lower display. Your response will depend on the message and the controller settings. Some messages, such as Ramping and Tuning, indicate that a process is underway. If the message was generated by a latched alarm or limit condition, the message can be cleared when the condition no longer exists by simply pushing the Infinity  or the Reset  key or alternatively by following the steps below. If an alarm has silencing enabled, it can also be silenced.



Push the Advance Key  to display Ignore *.Ignr* in the upper display and the message source (such as Limit High *ALh 1* in the lower display. Use the Up  and Down  keys to scroll through possible responses, such as Clear *CLr* or Silence *SIL*, then push the Advance  or Infinity  key to execute the action. See the Home Page for further information on the Attention Codes.

Display	Parameter Name Description	Range	Appears If
<i>ALLn</i>	<p><i>Attention</i></p> <p>An active message will cause the display to toggle between the normal settings and the active message in the upper display and <i>ALLn</i> in the lower display. Your response will depend on the message and the controller settings. Some messages, such as Ramping and Tuning, indicate that a process is underway. If the message was generated by a latched alarm or limit condition, the message can be cleared when the condition no longer exists. If an alarm has silencing enabled, it can be silenced.</p> <ol style="list-style-type: none"> 1. Push the Advance Key  to display <i>.Ignr</i> in the upper display and the message source (such as <i>ALh 1</i>) in the lower display. <p>Note: If the limit is tripped and the trip condition is no longer present the limit can be reset by pressing the Reset Key  (Infinity Key is labeled Reset).</p> <ol style="list-style-type: none"> 2. Use the Up  and Down  keys to scroll through possible responses, such as Clear <i>CLr</i> or Silence <i>SIL</i>. 3. Press the Advance Key  or Infinity  key to execute the action. <p>Alternatively, rather than scrolling through all messages simply push the Infinity  button to generate a clear.</p>	<p><i>ALL 1 ALL 2 ALL 3 ALL 4</i> Alarm Low 1 to 4</p> <p><i>ALh 1 ALh 2 ALh 3 ALh 4</i> Alarm High 1 to 4</p> <p><i>ALe 1 ALe 2 ALe 3 ALe 4</i> Alarm Error 1 to 4</p> <p><i>Er. 1 Er. 2</i> Error Input 1 or 2</p> <p><i>L.L 1</i> Limit Low 1</p> <p><i>L.H 1</i> Limit High 1</p> <p><i>L.E 1</i> Limit Error 1</p> <p><i>tUn 1 tUn 2</i> Tuning 1 or 2</p> <p><i>rP 1 rP 2</i> Ramping 1 or 2</p> <p><i>LP.o 1 LP.o 2</i> Loop Open Error 1 or 2</p> <p><i>LP.r 1 LP.r 2</i> Loop Reversed Error 1 or 2</p> <p><i>CEr 1</i> Current Error</p> <p><i>HEr 1</i> Heater Error</p> <p><i>uALh</i> Value to high to be displayed in 4 digit LED display >9999</p> <p><i>uALL</i> Value to low to be displayed in 4 digit LED display <-1999</p>	An alarm or error message is active.

4

Chapter 4: Home Page

Default Home Page Parameters

Watlow's patented user-defined menu system improves operational efficiency. The user-defined Home Page provides you with a shortcut to monitor or change the parameter values that you use most often. The default Home Page is shown on the following page. When a parameter normally located in the Setup Page or Operations Page is placed in the Home Page, it is accessible through both. If you change a parameter in the Home Page, it is automatically changed in its original page. If you change a parameter in its original page it is automatically changed in the Home Page. Use the Advance Key  to step through the other parameters. When not in pairs, the parameter prompt will appear in the lower display, and the parameter value will appear in the upper display. You can use the Up  and Down  keys to change the value of writable parameters, just as you would in any other menu.

Note:

If a writable value is placed on the upper display and is paired with another read only parameter on the lower display, the arrow keys affect the setting of the upper display. If two writable parameters are paired, the arrow keys affect the lower display.

- The Attention *ALLn* parameter appears only if there is an active message. An example of an active message could be a Current Error *CEr 1*, or it could be for information only like Autotune *tUn 1* taking place.
- If Control Mode is set to Auto, the Process Value is in the upper display and the Set Point (read-write) is in the lower display.
- If a profile is running, the process value is in the upper display and the Target Set Point (read only) is in the lower display. If Control Mode is set to Manual, the Process Value is in the upper display and the output power level (read-write) is in the lower display.
- If Control Mode is set to Off, the Process Value is in the upper display and *oFF* (read only) is in the lower display.
- If a sensor failure has occurred, dashes *----* will be displayed in the upper display and the Manual Power (read-write) is in the lower display.

Navigating the EZ-ZONE PM Integrated Controller

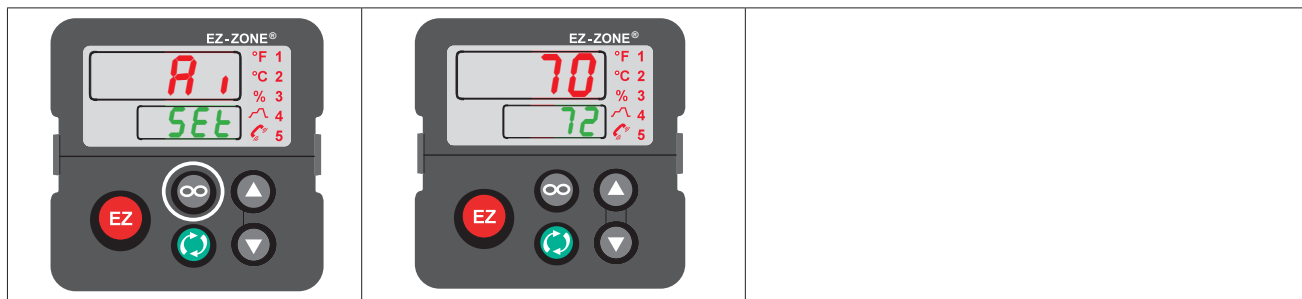

Home Page from anywhere: Press the Infinity Key ∞ for two seconds to return to the Home Page.

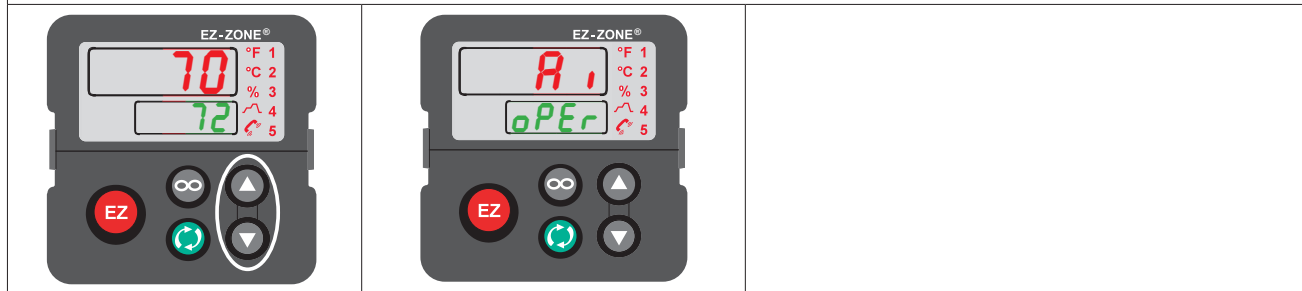

Operations Page from Home Page: Press both the Up \blacktriangle and Down \blacktriangledown keys for three seconds.

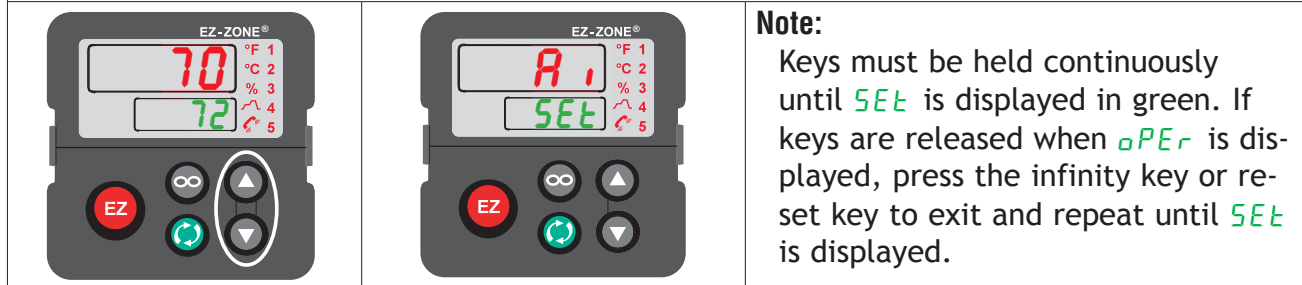

Note:
Keys must be held continuously until *SEt* is displayed in green. If keys are released when *oPEr* is displayed, press the infinity key or reset key to exit and repeat until *SEt* is displayed.

Setup Page from Home Page: Press both the Up \blacktriangle and Down \blacktriangledown keys for six seconds.

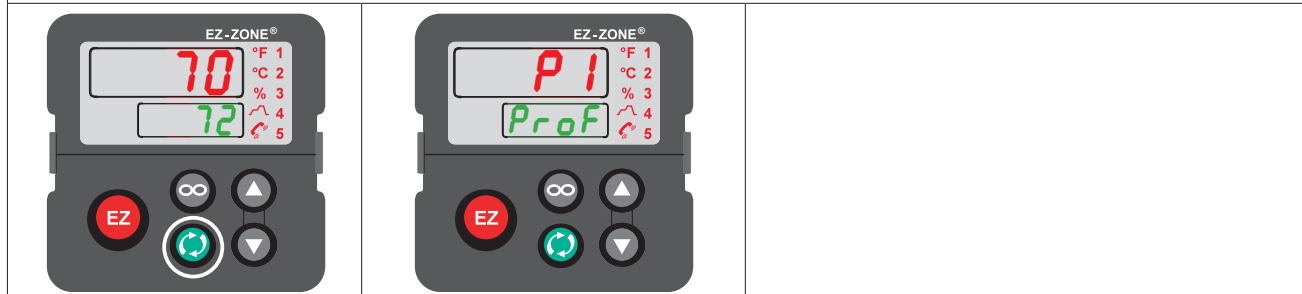

Profiling Page from Home Page: Press the Advance Key \odot for three seconds

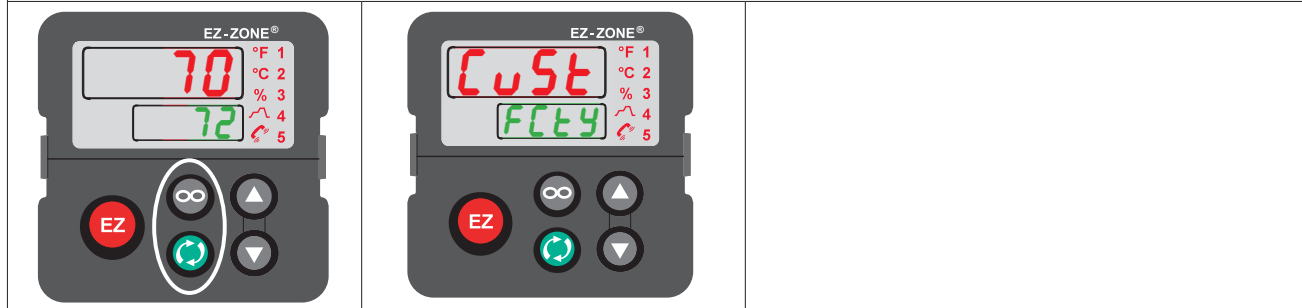

Factory Page from Home Page: Press both the Advance \odot and Infinity ∞ keys for six seconds.

Changing the Set Point

You can change the set point by using the Up ▲ or Down ▼ keys when a profile is not running.

Starting a Profile from the Home Page

1. When at the Home Page, press the Advance Key ⏩ to locate Profile Start and select the file or step number to start. The upper display will show *I* and the lower display will show *PSt I*.
2. Press the Up ▲ or Down ▼ key to choose the file or step number.
3. Press the Advance Key ⏩ to select the Profile Action Request. The upper display will show *nonE* and the lower display will show *PAC I*.
4. Press the Up ▲ or Down ▼ keys to select the Profile Start. The upper display will show *PrOF* and the lower display will show *PAC I*.
5. Press the Infinity ∞ Key to return Home. The Profile will Start

Ending a Profile from the Home Page

1. Press the Advance Key ⏩ to select the Profile Action Request. The upper display will show *nonE* and the lower display will show *PAC I*.
2. Press the Up ▲ or Down ▼ keys to select the End. The upper display will show *End* and the lower display will show *PAC I*.
3. Press the Infinity ∞ Key to return Home. The Profile will End.

Modifying the Home Page

1. Push and hold the Advance ⏩ key and the Infinity ∞ key for approximately six seconds. Upon entering the Factory Page the first menu will be the Custom Menu *CUSr*.
2. Push the Advance ⏩ key where the lower display will show *CUSr* and the upper display will show *I*.
3. Push the Advance ⏩ button where the prompt for the Process Value *ACPU* will be displayed on top and Parameter *PAR* in the bottom. There are twenty positions available that can be customized.
4. Pushing the Up ▲ or Down ▼ arrow keys will allow for a customized selection to be made (see list of available parameters below).

Custom Menu Parameter Options	
Description	Prompt *
All Models	
None	Blank
Analog Input Value	<i>Ain1 Ain2</i>
Cal In Offset	<i>CA1 CA2</i>
Display Units	<i>C_F I</i>
Load Parameter Set	<i>USr.1 USr.2</i>
Alarm Low Set Point	<i>ALo1 ALo2 ALo3 ALo4</i>
Alarm High Set Point	<i>Ah.1 Ah.2 Ah.3 Ah.4</i>
Alarm Hysteresis	<i>AhY1 AhY2 AhY3 AhY4</i>

Custom Menu Parameter Options	
Description	Prompt *
If 4th digit of part number is T	
Time Remaining	<i>t.r</i>
Ready Band State	<i>r.b5</i>
Ready Band	<i>r.d4</i>
Closed Loop Timer Set Point	<i>CLSP</i>
Hours	<i>hoUr</i>
Minutes	<i>mIn</i>
Seconds	<i>SEC</i>
If 4th or 9th digit of part number is L or M	
Limit Set Point Low	<i>LLS1</i>
Limit Set Point High	<i>LHS1</i>
Limit Hysteresis	<i>LHY1</i>
Limit Status	<i>LSt1</i>
If 4th digit of part number is B, E, C, R, J, or N	
Set Point	<i>CSP1 CSP2</i>
Active Process Value	<i>ACP1 ACP2</i>
Active Set Point	<i>ACS1 ACS2</i>
Manual Power	<i>aSP1 aSP2</i>
Autotune	<i>AUt1 AUt2</i>
Control Mode	<i>CP11 CP12</i>
Heat Power	<i>hPr1 hPr2</i>
Cool Power	<i>cPr1 cPr2</i>
Time Integral	<i>t.i1 t.i2</i>
Time Derivative	<i>t.d1 t.d2</i>
Dead Band	<i>db1 db2</i>
Heat Prop Band	<i>hPb1 hPb2</i>
On/Off Heat Hysteresis	<i>hHy1 hHy2</i>
Cool Prop Band	<i>cPb1 cPb2</i>
On/Off Cool Hysteresis	<i>cHy1 cHy2</i>
Ramp Rate	<i>r.r1 r.r2</i>
TRU-TUNE+ Enable	<i>t.tU1 t.tU2</i>
Idle Set Point	<i>idS1 idS2</i>
If 4th digit of part number is B, E, R or N	
Profile Start	<i>PSt.r</i>
Profile Action Request	<i>PAC.r</i>
Current Step	<i>StP</i>
Step Type	<i>StYP</i>

Custom Menu Parameter Options	
Description	Prompt *
Target Set Point	<i>ESP 1, ESP 2</i>
Hour	<i>Hour</i>
Minute	<i>Min</i>
Second	<i>SEC</i>
Guaranteed Soak Deviation 1	<i>95d 1</i>
If 9th digit of part number is T	
Load Current RMS	<i>Cur 1</i>

* The numerical digit shown in the prompts above (last digit), represents the parameter instance and can be greater than one.

Modifying the Display Pairs

The Home Page, being a customized list of as many as 20 parameters, can be configured in pairs of up to 10 via the Display Pairs *dPr 5* prompt found in the Global Menu *9LbL* (Setup Page). The listing in the table that follows is what one may typically find in the Home Page as defaults based on controller part numbers. It is important to note that some of the prompts shown may not appear simply because the feature is not being used or is turned off. As an example, the prompt shown in position 7 (loop 1) and position 12 (loop 2) *CP r* will not appear unless the Cool algorithm *CR 9* is turned on in the Setup Page under the Loop menu. If the ninth digit of the part number is C, J, L or M (PM _ _ _ _ _ - _ [C, J, L, M] _ _ _ _ _) the Display Pairs *dPr 5* prompt will default to 2; otherwise, it will be equal to one.

As stated above, the user can define pairs of prompts to appear on the display every time the Advance % key is pushed. The first pair will always be as defined in the Custom Menu and as stated, will default (factory settings) to the Active Process Value loop 1 *ACP u*, and the Active Set Point loop 1 *ACSP*. If two channels are present the first 2 pairs will be the same in that the first pair will represent channel 1 Active Process Value and Active Set Point and the second being the same for channel 2. If another pair is created where the Display Pairs *dPr 5* prompt is equal to 3 using the default prompts, when the Advance Key  is pushed two times from the Home Page the upper display will reflect the current control mode and the bottom display would show the output power. When configuring the Custom Menu to your liking it should be noted that if a writable value is placed on the upper display and is paired with another read only parameter on the lower display, the arrow keys will affect the setting of the upper display. Also, if 2 changeable (writable) prompts are displayed in a Pair, i.e., Control Mode on top and Idle Set Point on the bottom, only the lower display (Idle Set Point) can be changed.

The display can be configured to scroll customized pairs by going to the Setup Page under the Global Menu and changing the Display Time *dt i*, prompt to something greater than 0 and by changing the Display Pairs *dPr 5* to something greater than 1. If the Display Time *dt i* is set to 2, the display will toggle every 2 seconds from the first display pair to the second and then the third, etc... If the control has more than one channel and one of the configured pairs is set as instance 2, the channel indicator (LED) will change from 1 to 2 reflecting the channel of the pair being displayed. The display will continue to toggle through all of the custom pairs at the specified time interval.

	Possible Home Page Defaults (Dependent on Part Number)	Home Page Display	Parameter Page and Menu
All Models			
1	Active Process Value (1)	Numerical value	Operations Page, Monitor Menu
If 4 th digit of part number is equal to: PM _ [T] _ _ _ - _ _ _ _ _			
2	Time Remaining (2)	Numerical value	Operations Page, Timer Menu
If 4 th digit of part number is equal to: PM _ [C, R, B, J, N, E, S] _ _ _ - _ _ _ _ _			
2	Active Set Point (1)	Numerical value	Operations Page, Monitor Menu
If 4 th digit of part number is equal to: PM _ [T] _ _ _ - _ _ _ _ _			
3	Active Set Point (1)	Numerical value	Operations Page, Monitor Menu
If 9 th digit of part number is equal to: PM _ _ _ _ _ - _ [L, M] _ _ _ _ _			
3	Process Value (2)	Numerical value	Operations Page, Monitor Menu
4	Limit Status	SAFE or FRIL	Home Page
If 4 th digit of part number is equal to: PM _ [T] _ _ _ - _ _ _ _ _			
4	Set Point (1)	Numerical value	Operations Page, Monitor Menu
If 9 th digit of part number is equal to: PM _ _ _ _ _ - _ [A, C, J, R, P, T] _ _ _ _ _			
3	Active Process Value (2)	PuR2	Operations Page, Monitor Menu
4	Closed Loop Set Point (2)	CSP2	Operations Page, Monitor Menu
5	Control Mode (1)	CT71	Operations Page, Monitor Menu
If 4 th digit of part number is equal to: PM _ [T] _ _ _ - _ _ _ _ _			
5	Ready State Band (1)	r.b5	Operations Page, Timer Menu
6	Ready Band (1)	r.d4	Operations Page, Timer Menu
7	Closed Loop Timer Set Point (1)	CLSP	Operations Page, Timer Menu
8	Hours (1)	hour	Operations Page, Timer Menu
9	Minutes (1)	min	Operations Page, Timer Menu
10	Seconds (2)	SEC	Operations Page, Timer Menu
If 9 th digit of part number is equal to: PM _ _ _ _ _ - _ [A, C, J, R, P, T] _ _ _ _ _			
6	Heat Power (1)	hPr1	Operations Page, Monitor Menu
7	Cool Power (1)	cPr1	Operations Page, Monitor Menu
8	Autotune (1)	AUT1	Operations Page, Loop Menu
9	Idle Set Point(1)	idS1	Operations Page, Loop Menu
10	Control Mode (2)	CT72	Operations Page, Monitor Menu
11	Heat Power (2)	hPr2	Operations Page, Monitor Menu
12	Cool Power (2)	cPr2	Operations Page, Monitor Menu

	Possible Home Page Defaults (Dependent on Part Number)	Home Page Display	Parameter Page and Menu
13	Autotune (2)	<i>AUT2</i>	Operations Page, Loop Menu
14	Idle Set Point (2)	<i>ID52</i>	Operations Page, Loop Menu
15	Low Set Point	<i>LL51</i>	Operations Page, Limit Menu
17	Profile Start	<i>P5E1</i>	Operations Page, Profile Status
18	Action Request	<i>PAC1</i>	Operations Page, Profile Status
19	None		
20	None		

Note:

The numerical digit shown in the prompts (last digit) and within the parentheses above, represents the parameter instance and can be greater than one.

Conventions Used in the Menu Pages

To better understand the menu pages that follow review the naming conventions used. When encountered throughout this document, the word "default" implies as shipped from the factory. Each page (Operations, Setup, Profile and Factory) and their associated menus have identical headers defined below:

Header Name	Definition
Display	Visually displayed information from the control.
Parameter Name	Describes the function of the given parameter.
Range	Defines options available for this prompt, i.e., min/max values (numerical), yes/no, etc... (further explanation below).
Default	Values as delivered from the factory.
Modbus Relative Address	Identifies unique parameters using either the Modbus RTU or Modbus TCP protocols (further explanation below).
CIP (Common Industrial Protocol)	Identifies unique parameters using either the DeviceNet or EtherNet/IP protocol (further explanation below).
Profibus Index	Identifies unique parameters using Profibus DP protocol (further explanation below).
Parameter ID	Identifies unique parameters used with other software such as, LabVIEW.
Data Type R/W	uint = Unsigned 16 bit integer dint = Signed 32-bit, long string = ASCII (8 bits per character) float = IEEE 754 32-bit RWES = Readable Writable EEPROM (saved) User Set (saved)

Display

Visual information from the control is displayed to the observer using a fairly standard 7 segment display. Due to the use of this technology, several characters displayed need some interpretation, see the list below:

1 = 1	7 = 7	c, C = c	i = i	o = o	u, U = u
2 = 2	8 = 8	d = d	J = J	P = P	v, V = v
3 = 3	9 = 9	E = E	H = K	q = q	W = W
4 = 4	0 = 0	F = F	L = L	r = r	y = y
5 = 5	A = A	g = g	M = M	S = S	Z = Z
6 = 6	b = b	h = h	n = n	t = t	

Range

Within this column notice that on occasion there will be numbers found within parenthesis. This number represents the enumerated value for that particular selection. Range selections can be made simply by writing the enumerated value of choice using any of the available communications protocols. As an example, turn to the Setup Page and look at the Analog Input **A** menu and then the Sensor Type **5En** prompt. To turn the sensor off using Modbus simply write the value of 62 (off) to register 368 and send that value to the control.

Communication Protocols

When using a communications protocol in conjunction with the EZ-ZONE PM there are two possible ports (instances) used. Port 1 or instance 1 is always dedicated to Standard Bus communications. This same instance can also be used for Modbus RTU if ordered. Depending on the controller part number, port 2 (instance 2) can be used with Modbus, CIP, J1939 CAN and Profibus. For further information read through the remainder of this section.

Modbus Introduction to the Modbus Protocol

Gould Modicon, now called AEG Schneider, first created the protocol referred to as "Modbus RTU" used in process control systems. Modbus provides the advantage of being extremely reliable in exchanging information, a highly desirable feature for industrial data communications. This protocol works on the principle of packet exchanges. The packet contains the address of the controller to receive the information, a command field that says what is to be done with the information, and several fields of data. Each PM parameter has a unique Modbus address and they can be found in the following Operations, Setup, Profiling, and Factory Pages.

All Modbus registers are 16-bits and as displayed in this User's Guide are relative addresses (actual). Some legacy software packages limit available Modbus registers to 40000 to 49999 (5 digits). Many applications today require access to all available Modbus registers which range from 400000 to 465535 (6 digits). For parameters listed as float, notice that only one (low order) of the two registers is listed; this is true throughout this document. By default, the low order word contains the two low bytes of the 32-bit parameter. As an example, look in the Operations Page for the Analog Input Value. Find the column identified in the header as Modbus and notice that it lists register 360. Because this parameter is a float it is actually represented by registers 360 (low order bytes) and 361 (high order bytes). The Modbus specification does not dictate which register should be high or low order therefore, Watlow provides the user the ability to swap this order (Setup Page, **CoPn** Menu) from the default low/high **LoHi** to high/low **HiLo**.

Note:

With the release of firmware revision 7.00 and above new functions were introduced into this product line. With the introduction of these new functions there was a reorganization of Modbus registers. Notice in the column identified as Modbus the reference to Map 1 and Map 2 registers for each of the various parameters. If the new functions, namely; Math, Linearization, Process Value, Real Time Clock and the Special Output Function are to be used then use Map 2 Modbus registers. If the new functions of this product line are not to be used, Map 1 (legacy PM controls) Modbus registers will be sufficient. The Modbus register mapping [map] can be changed in the Setup Page under the **CONF** Menu. This setting will apply across the control. We recommend to use Map 2 for all new applications. Use Map 1 only if desired to maintain backwards compatibility.

It should also be noted that some of the cells in the Modbus column contain wording pertaining to an offset. Several parameters in the control contain more than one instance; such as, profiles (4), alarms (4), analog inputs (2), etc... The Modbus register shown always represents instance one. Take for an example the Silence Alarm parameter found in the Setup Page under the Alarm Menu. Instance one of Map 1 is shown as address 1490 and +50 is identified as the offset to the next instance. If there was a desire to read or write to instance 3 simply add 100 to 1490 to find its address, in this case, the instance 3 address for Silence Alarm is 1590.

The Modbus communications instance can be either 1 or 2 depending on the part number.

Instance 1:

PM _____ - [1] _____

Instance 2:

PM _____ - [2] _____

To learn more about the Modbus protocol point your browser to <http://www.modbus.org>.

Common Industrial Protocol (CIP) Introduction to CIP

Both DeviceNet and EtherNet/IP use open object based programming tools and use the same addressing scheme. In the following menu pages notice the column header identified as CIP. There you will find the Class, Instance and Attribute in hexadecimal, (decimal in parenthesis) which makes up the addressing for both protocols.

The CIP communications instance will always be instance 2.

Data Types Used with CIP

int	= Signed 16-bit integer
uint	= Signed 16-bit integer
dint	= Signed 32-bits, long
real	= Float, IEEE 754 32-bit
string	= ASCII, 8 bits per character
sint	= Signed 8 bits , byte

To learn more about the DeviceNet and EtherNet/IP protocol point your browser to <http://www.odva.org>.

J1939 CAN

This protocol was originally introduced back in the 80s by Robert Bosch and was quickly adopted and incorporated into many new cars. Because of its reliability and wide acceptance, this protocol is also used heavily within heavy-duty vehicles, e.g., trucks, buses, etc... The J1939 communications will always be instance 2 as implemented in the EZ-ZONE PM.

To learn more about the Controller Area Network protocol, click on the link that follows:
<http://www.can-cia.org/>

Profibus DP

To accommodate for Profibus DP addressing the following menus contain a column identified as Profibus Index. Data types used in conjunction with Profibus DP can be found in the table below.

The Profibus communications instance will always be instance 2.

real	= Float, IEEE 754 32-bit
int	= Signed 16-bit integer
byte	= 8-bits

To learn more about the Profibus DP protocol point your browser to <http://www.profibus.org>

5

Chapter 5: Operations Page

PM Operation Page Parameters

To navigate to the Operations Page, follow the steps below:

1. From the Home Page, press both the Up ▲ and Down ▼ keys for three seconds. *A i* will appear in the upper display and *oPEr* will appear in the lower display.
2. Press the Up ▲ or Down ▼ key to view available menus.
3. Press the Advance Key ⏩ to enter the menu of choice.
4. If a submenu exists (more than one instance), press the Up ▲ or Down ▼ key to select and then press the Advance Key ⏩ to enter.
5. Press the Up ▲ or Down ▼ key to move through available menu prompts.
6. Press the Infinity Key ∞ to move backwards through the levels: parameter to submenu, submenu to menu, menu to Home Page.
7. Press and hold the Infinity Key ∞ for two seconds to return to the Home Page.

On the following pages, top level menus are identified with a yellow background color.

Note:

Some of these menus and parameters may not appear, depending on the controller's options. See model number information in the Appendix for more information. If there is only one instance of a menu, no submenus will appear.

Note:

Some of the listed parameters may not be visible. Parameter visibility is dependent upon controller part number.

A i

oPEr Analog Input Menu

i

A i Analog Input (1 to 2)

A in Analog Input Value

iEr Input Error

iCR Calibration Offset

db i

oPEr Digital Bus Menu

i

db i J1939 Instance (1 to 6)

uALU Input Value

iEr Input Error

ou Output Value

Err Output Error

Lnr

oPEr Linearization Menu

i

Lnr Linearization (1 to 2)

SuA Source Value A

oFSt Offset

ou Output Value

Pu

oPEr Process Value Menu

i

Pu Process Value (1 to 2)

SuA Source Value A

SuB Source Value B

oFSt Offset

ou Output Value

d i o

oPEr Digital Input/Output Menu

I

d i o Digital Input/Output (5 to 12)

d o S Output State

d i S Input State

E i S Event Status

L i M

oPEr Limit Menu

I

L i M Limit

L L S Low Limit Set Point

L h S High Limit Set Point

L C r Clear Limit

L S t Limit Status

M o n

oPEr Monitor Menu

I

M o n Monitor (1 to 2)

C M A Control Mode Active

h P r Heat Power

C P r Cool Power

C S P Closed-Loop Set Point

P u A Process Value Active

L o o P

oPEr Loop Menu

I

L o o P Loop (1 to 2)

r E n Remote Set Point

C M Control Mode

A t S P Autotune Set Point

A U t Autotune

C S P Closed Loop Set Point

i d S Idle Set Point

h P b Heat Proportional Band

h h y On/Off Heat Hysteresis

C P b Cool Proportional Band

C h y On/Off Cool Hysteresis

t i Time Integral

t d Time Derivative

d b Dead Band

o S P Manual Power

A L A R M

oPEr Alarm Menu

I

A L A R M Alarm (1 to 4)

A L o Low Set Point

A h i High Set Point

A C L r Clear Alarm

A S i r Silence Alarm

A S t Alarm State

C U R R

oPEr Current Menu

C h i High Set Point

C L o Low Set Point

L d C u Load Current RMS

C E r Error

h E r Heater Error

T I M E R

oPEr Timer Menu

S u A Source Value A

S u C Source Value C

S u D Source Value D

P P S 1 Produced Set Point 1

t E o 1 Timer Event Output 1

t E o 2 Timer Event Output 2

t E o 3 Timer Event Output 3

t r Time Remaining

r b S Ready Band State

h o U r Hours

M i n Minutes

S E C Seconds

C L S P Closed Loop Timer Set Point

M A T H

oPEr Math Menu

S u A Source Value A

S u B Source Value B

S u E Source Value E

o F S t Offset

o u Output Value

S o F

oPEr Special Output Function Menu

S u A Source Value A

S u B Source Value B

o u 1 Output Value 1

o u 2 Output Value 2

P.SEA

oPEr Profile Status Menu

- P.SEr* Profile Start
- P.ACr* Profile Action Request
- StP* Current Step
- StYP* Step Type
- t.SP 1* Target Set Point Loop 1
- t.SP 2* Target Set Point Loop 2
- Pr.SP* Produced Set Point 1
- P.SP 2* Produced Set Point 2
- hOUr* Hours Remaining
- Min* Minutes Remaining
- SEC* Seconds Remaining
- Ent 1* Active Event Output 1
- Ent 2* Active Event Output 2
- JC* Jump Count Remaining

Operations Page

Display	Parameter Name Description	Range	Default	Modbus Relative Address	CIP Class Instance Attribute hex (dec)	Pro-fibus Index	Pa-ram-eter ID	Data Type and Access **
<p>A i oPEr Analog Input Menu</p>								
A in Ain	<p>Analog Input (1 to 2) Analog Input Value View the process value.</p> <p>Note: Ensure that the Input Error (below) indicates no error (61) when reading this value using a field bus protocol. If an error exists, the last known value prior to the error occurring will be returned.</p>	-1,999.000 to 9,999.000 °F or units -1,128.000 to 5,537.000 °C	- - - -	<p><i>Instance 1</i> Map 1 Map 2 360 360</p> <p><i>Instance 2</i> Map 1 Map 2 440 450</p>	0x68 (104) 1 to 2 1	0	4001	float R
iEr iEr	<p>Analog Input (1 to 2) Input Error View the cause of the most recent error. If the ALtErn message is Er.i1 or Er.i2, this parameter will display the cause of the input error.</p>	<p>nonE None (61) oPEr Open (65) Shrt Shorted (127) ErM Measurement Error (140) ECAL Bad Calibration Data (139) Er.Ab Ambient Error (9) Er.td RTD Error (141) FR.iL Fail (32) NSrc Not Sourced (246)</p>	- - - -	<p><i>Instance 1</i> Map 1 Map 2 362 362</p> <p><i>Instance 2</i> Map 1 Map 2 442 452</p>	0x68 (104) 1 to 2 2	1	4002	uint R
iCA i.CA	<p>Analog Input (1 to 2) Calibration Offset Offset the input reading to compensate for lead wire resistance or other factors that cause the input reading to vary from the actual process value.</p>	-1,999.000 to 9,999.000 °F or units -1,110.555 to 5,555.000 °C	0.0	<p><i>Instance 1</i> Map 1 Map 2 382 382</p> <p><i>Instance 2</i> Map 1 Map 2 462 472</p>	0x68 (104) 1 to 2 0xC (12)	2	4012	float RWES
<p>** R: Read, W: Write, E: EEPROM, S: User Set</p>								

Operations Page

Display	Parameter Name Description	Range	Default	Modbus Relative Address	CIP Class Instance Attribute hex (dec)	Pro-fibus Index	Parameter ID	Data Type and Access **
<i>db ,</i> <i>oPEr</i> Digital Bus Menu (J1939 CAN)								
<i>db ,</i> d.bi	Digital Bus (1 to 6) J1939 Instance Select the desired instance.	1 to 6	----	----	----	----	----	float RW
<i>uALU</i> vaLU	Digital Bus (1 to 6) Input Value View the input value.	-1,999.000 to 9,999.000	----	----	----	----	95001	float RW
<i>iEr</i> i.Er	Digital Bus (1 to 6) Input Error Selected sensor instance is in error state.	<i>nonE</i> None (61) <i>OPEn</i> Open (65) <i>Shrt</i> Shorted (127) <i>ErPn</i> Measurement Error (140) <i>ECAL</i> Bad Calibration Data (139) <i>ErAb</i> Ambient Error (9) <i>Ertd</i> RTD Error (141) <i>FAiL</i> Fail (32) <i>ErPn</i> Math Error (1423) <i>nSrc</i> Not Sourced (246) <i>StAL</i> Stale (883)	Stale	----	----	----	95002	float RW
<i>o.u</i> o.u	Digital Bus (1 to 6) Output Value View the output value.	-1,999.000 to 9,999.000	----	----	----	----	95003	float R
** R: Read, W: Write, E: EEPROM, S: User Set								

Operations Page

Display	Parameter Name Description	Range	Default	Modbus Relative Address	CIP Class Instance Attribute hex (dec)	Pro-fibus Index	Pa-ram-eter ID	Data Type and Access **
Err Err	Digital Bus (1 to 6) Output Error	nonE None (61) OPEn Open (65) Shrt Shorted (127) Err Measurement Error (140) ECAL Bad Calibration Data (139) ErAb Ambient Error (9) ErEd RTD Error (141) FRiL Fail (32) ErPn Math Error (1423) nSrc Not Sourced (246) StAL Stale (883)	Stale	----	----	----	95004	float R
<p>Lnr oPEr Linearization Menu</p>								
SuA Su.A	Linearization (1 to 2) Source Value A View the value of Source A. Source A of Linearization 1 is connected to Analog Input 1, Source A of Linearization 2 is connected to Analog Input 2	-1,999.000 to 9,999.000 °F or units -1,128.000 to 5,537.000 °C	----	<i>Instance 1</i> Map 1 Map 2 ---- 3566 <i>Instance 2</i> Map 1 Map 2 ---- 3636	0x86 (134) 1 to 2 4	----	34004	float R
oFSt oFSt	Linearization (1 to 2) Offset Set an offset to be applied to this function's output.	-1,999.000 to 9,999.000 °F or units -1,128.000 to 5,537.000 °C	0	<i>Instance 1</i> Map 1 Map 2 ---- 3570 <i>Instance 2</i> Map 1 Map 2 ---- 3640	0x86 (134) 1 to 2 6	----	34006	float RWES
** R: Read, W: Write, E: EEPROM, S: User Set								

Operations Page

Display	Parameter Name Description	Range	Default	Modbus Relative Address	CIP Class Instance Attribute hex (dec)	Pro-fibus Index	Parameter ID	Data Type and Access **
o.v o.v	<i>Linearization (1 to 2)</i> Output Value View the value of this function's output.	-1,999.000 to 9,999.000 °F or units -1,128.000 to 5,537.000 °C	- - - -	<i>Instance 1</i> Map 1 Map 2 - - - - 3572 <i>Instance 2</i> Map 1 Map 2 - - - - 3642	0x86 (134) 1 to 2 7	- - - -	34007	float R
No Display	<i>Linearization (1 to 2)</i> Error View reported cause for Linearization output malfunction.	None (61) Open (65) Shorted (127) Measurement error (140) Bad calibration data (139) Ambient error (9) RTD error (14) Fail (32) Math error (1423) Not sourced (246) Stale (1617) Can't process (1659)	- - - -	<i>Instance 1</i> Map 1 Map 2 - - - - 3614 <i>Instance 2</i> Map 1 Map 2 - - - - 3684	0x86 (134) 1 to 2 0x1C (28)	- - - -	34028	uint R

P_u

oPEr

Process Value Menu

Su.A Su.A	<i>Process Value (1 to 2)</i> Source Value A View the value of Source A. Linearization 1 is connected to Source A of Process Value 1 Linearization 2 is connected to Source A of Process Value 2	-1,999.000 to 9,999.000 °F or units -1,128.000 to 5,537.000 °C	- - - -	<i>Instance 1</i> Map 1 Map 2 - - - - 3310 <i>Instance 2</i> Map 1 Map 2 - - - - 3380	0x7E (126) 1 to 2 0x10 (16)	- - - -	26016	float R
Su.b Su.b	<i>Process Value (1 to 2)</i> Source Value B View the value of Source B. Linearization 2 is connected to Source B of Process Value 1 Linearization 1 is connected to Source B of Process Value 2	-1,999.000 to 9,999.000 °F or units -1,128.000 to 5,537.000 °C	- - - -	<i>Instance 1</i> Map 1 Map 2 - - - - 3312 <i>Instance 2</i> Map 1 Map 2 - - - - 3382	0x7E (126) 1 to 2 0x11 (17)	- - - -	26017	float R

** R: Read, W: Write, E: EEPROM, S: User Set

Operations Page

Display	Parameter Name Description	Range	Default	Modbus Relative Address	CIP Class Instance Attribute hex (dec)	Pro-fibus Index	Pa-ram-eter ID	Data Type and Access **
oFSt oFSt	Process Value (1 to 2) Offset Set an offset to be applied to this function's output.	-1,999.000 to 9,999.000 °F or units -1,128.000 to 5,537.000 °C	0	<i>Instance 1</i> Map 1 Map 2 - - - - 3324 <i>Instance 2</i> Map 1 Map 2 - - - - 3394	0x7E (126) 1 to 2 0x17 (23)	- - - -	26023	float RWES
o.u o.u	Process Value (1 to 2) Output Value View the value of this function block's output.	-1,999.000 to 9,999.000 °F or units -1,128.000 to 5,537.000 °C	- - - -	<i>Instance 1</i> Map 1 Map 2 - - - - 3322 <i>Instance 2</i> Map 1 Map 2 - - - - 3392	0x7E (126) 1 to 2 0x16 (22)	- - - -	26022	float R
No Display	Process Value (1 to 2) Output Error View reported cause for Process output malfunction.	None (61) Open (65) Shorted (127) Measurement error (140) Bad calibration data (139) Ambient error (9) RTD error (14) Fail (32) Math error (1423) Not sourced (246) Stale (1617) Can't process (1659)	- - - -	<i>Instance 1</i> Map 1 Map 2 - - - - 3332 <i>Instance 2</i> Map 1 Map 2 - - - - 3402	0x7E (126) (134) 1 to 2 0x1B (27)	- - - -	26027	uint R
d i o oPEr Digital Input/Output Menu								
do.S do.S	Digital Output (5 to 12) Output State View the state of this output.	oFF Off (62) oN On (63)	- - - -	<i>Instance 5</i> Map 1 Map 2 1012 1132 Offset to next instance equals +30	0x6A (106) 5 to 12 7	46	6007	uint R
di.S di.S	Digital Input (5 to 12) Input State View this event input state.	oFF Off (62) oN On (63)	- - - -	<i>Instance 5</i> Map 1 Map 2 1020 1140 Offset to next instance equals +30	0x6A (106) 5 to 12 0x0B (11)	- - - -	6011	uint R
** R: Read, W: Write, E: EEPROM, S: User Set								

Operations Page

Display	Parameter Name Description	Range	Default	Modbus Relative Address	CIP Class Instance Attribute hex (dec)	Pro-fibus Index	Pa-ram-eter ID	Data Type and Access **
Ei.S Ei.S	Digital Input (5 to 6) Event Status View this event input state.	, Act Inactive (41) Act Active (5)	- - - -	<i>Instance 5</i> Map 1 Map 2 1408 1648 Offset to next instance equals +20	0x6E (110) 5 to 6 5	140	10005	uint R
Ei.S Ei.S	Digital Input (7 to 12) Event Status View this event input state.	, Act Inactive (41) Act Active (5)	- - - -	<i>Instance 7</i> Map 1 Map 2 1448 1688 Offset to next instance equals +20	0x6E (110) 7 to C (12) 5	140	10005	uint R
No Display	EZ-Key/s (1 to 2) Event Status View this event input state.	, Act Inactive (41) Act Active (5)	- - - -	<i>Instance 1</i> Map 1 Map 2 1328 1568 <i>Instance 2</i> Map 1 Map 2 1348 1588	0x6E (110) 3 to 4 5	140	10005	uint R
<p style="color: red;">L 177</p> <p style="color: green;">oPEr</p> <p>Limit Menu</p>								
LL.S LL.S	Limit (1) Low Limit Set Point Set the low process value that will trigger the limit.	-1,999.000 to 9,999.000° F or units -1,128.000 to 5,537.000° C	0.0° F or units -18.0° C	<i>Instance 1</i> Map 1 Map 2 684 724	0x70 (112) 1 3	38	12003	float RWES
Lh.S Lh.S	Limit (1) High Limit Set Point Set the high process value that will trigger the limit.	-1,999.000 to 9,999.000° F or units -1,128.000 to 5,537.000° C	0.0° F or units -18.0° C	<i>Instance 1</i> Map 1 Map 2 686 726	0x70 (112) 1 4	39	12004	float RWES
No Display	Limit (1) Limit State Clear limit once limit condition is cleared.	Off (62) None (61) Limit High (51) Limit Low (52) Error (225)	- - - -	<i>Instance 1</i> Map 1 Map 2 690 730	0x70 (112) 1 6	- - - -	12006	uint R
LCr LCr	Limit (1) Clear Limit * Clear limit once limit condition is cleared.	Clear (0) No Change (255)	- - - -	<i>Instance 1</i> Map 1 Map 2 680 720	0x70 (112) 1 1	- - - -	12014	uint W

** R: Read, W: Write, E: EEPROM, S: User Set

Operations Page

Display	Parameter Name Description	Range	Default	Modbus Relative Address	CIP Class Instance Attribute hex (dec)	Pro-fibus Index	Parameter ID	Data Type and Access **
LSt L.St	Limit (1) Limit Status * Reflects whether or not the limit is in a safe or failed mode..	FAIL Fail (32) SAFE Safe (1667)	----	Instance 1 Map 1 Map 2 ---- 744	0x70 (112) 1 0x0D (13)	----	12013	uint R
<p>Monitor Menu</p>								
CMA C.MA	Monitor (1 to 2) Control Mode Active View the current control mode.	OFF Off (62) AUTO Auto (10) MAN Manual (54)	----	Instance 1 Map 1 Map 2 1882 2362 Instance 2 Map 1 Map 2 1952 2432	0x97 (151) 1 to 2 2	----	8002	uint R
hPr h.Pr	Monitor (1 to 2) Heat Power View the current heat output level.	0.0 to 100.0%	----	Instance 1 Map 1 Map 2 1904 2384 Instance 2 Map 1 Map 2 1974 2454	0x97 (151) 1 to 2 0xD (13)	----	8011	float R
CPr C.Pr	Monitor (1 to 2) Cool Power View the current cool output level.	-100.0 to 0.0%	----	Instance 1 Map 1 Map 2 1906 2386 Instance 2 Map 1 Map 2 1976 2456	0x97 (151) 1 to 2 0xE (14)	----	8014	float R
CSP C.SP	Monitor (1 to 2) Closed-Loop Set Point View the working set point currently in effect.	-1,999.000 to 9,999.000 °F or units -1,128.000 to 5,537.000 °C	----	----	----	----	8029	float R
PvA Pv.A	Monitor (1 to 2) Process Value Active View the current filtered process value using the control input.	-1,999.000 to 9,999.000 °F or units -1,128.000 to 5,537.000 °C	----	Instance 1 Map 1 Map 2 402 402 Instance 2 Map 1 Map 2 482 492	0x68 (104) 1 to 2 0x16 (22)	----	8031	float R
** R: Read, W: Write, E: EEPROM, S: User Set								

Operations Page

Display	Parameter Name Description	Range	Default	Modbus Relative Address	CIP Class Instance Attribute hex (dec)	Pro-fibus Index	Pa-ram-eter ID	Data Type and Access **
No Display	<i>Monitor (1 to 2)</i> Set Point Active Read the current active set point.	-1,999.000 to 9,999.000 °F or -1,128.000 to 5,537.000 °C	- - - -	<i>Instance 1</i> Map 1 Map 2 2172 2652 <i>Instance 2</i> Map 1 Map 2 2252 2732	0x6B (107) 1 to 2 7	- - - -	8031	float R
No Display	<i>Monitor (1 to 2)</i> Autotune Status Read the present status of Autotune.	Off (62) Waiting for cross 1 positive (119) Waiting for cross 1 negative (120) Waiting for cross 2 positive (121) Waiting for cross 2 negative (122) Waiting for cross 3 positive (123) Waiting for cross 3 negative (150) Measuring maximum peak (151) Measuring minimum peak (152) Calculating (153) Complete (18) Timeout (118)	- - - -	<i>Instance 1</i> Map 1 Map 2 1932 2412 <i>Instance 2</i> Map 1 Map 2 2002 2482	0x97 (151) 1 to 2 0x1B (27)	- - - -	8027	uint R
<p><i>Loop</i> <i>OPER</i> Control Loop Menu</p>								
<i>r.En</i> r.En	<i>Control Loop (1 to 2)</i> Remote Set Point Enable this loop to switch control to the remote set point.	<i>no</i> No (59) <i>YES</i> Yes (106)	No	<i>Instance 1</i> Map 1 Map 2 2200 2680 <i>Instance 2</i> Map 1 Map 2 2280 2760	0x6B (107) 1 to 2 0x15 (21)	48	7021	uint RWES
<i>C.M</i> C.M	<i>Control Loop (1 to 2)</i> Control Mode Select the method that this loop will use to control.	<i>OFF</i> Off (62) <i>AUTO</i> Auto (10) <i>MAN</i> Manual (54)	Auto	<i>Instance 1</i> Map 1 Map 2 1880 2360 <i>Instance 2</i> Map 1 Map 2 1950 2430	0x97 (151) 1 to 2 1	63	8001	uint RWES
** R: Read, W: Write, E: EEPROM, S: User Set								

Operations Page

Display	Parameter Name Description	Range	Default	Modbus Relative Address	CIP Class Instance Attribute hex (dec)	Pro-fibus Index	Parameter ID	Data Type and Access **
A.tSP A.tSP	<i>Control Loop (1 to 2)</i> Autotune Set Point Set the set point that the autotune will use, as a percentage of the current set point.	50.0 to 200.0%	90.0	<i>Instance 1</i> Map 1 1918 Map 2 2398 <i>Instance 2</i> Map 1 1988 Map 2 2468	0x97 (151) 1 to 2 0x14 (20)	- - - -	8025	float RWES
AUt AUt	<i>Control Loop (1 to 2)</i> Autotune Start an autotune. While the autotune is active, the Home Page will display Autn . When the autotune is complete, the message will clear automatically.	no No (59) YES Yes (106)	No	<i>Instance 1</i> Map 1 1920 Map 2 2400 <i>Instance 2</i> Map 1 1990 Map 2 2470	0x97 (151) 1 to 2 0x15 (21)	64	8026	uint RW
C.SP C.SP	<i>Control Loop (1 to 2)</i> Set Point Set the closed loop set point that the controller will automatically control to.	Low Set Point to Maximum Set Point (Setup Page)	75.0°F or units 24.0°C	<i>Instance 1</i> Map 1 2160 Map 2 2640 <i>Instance 2</i> Map 1 2240 Map 2 2720	0x6B (107) 1 to 2 1	49	7001	float RWES
id.S id.S	<i>Control Loop (1 to 2)</i> Idle Set Point Define a set point that can be triggered by an event state.	Low Set Point to High Set Point (Setup Page)	75.0°F or units 24.0°C	<i>Instance 1</i> Map 1 2176 Map 2 2656 <i>Instance 2</i> Map 1 2197 Map 2 2736	0x6B (107) 1 to 2 9	50	7009	float RWES
h.Pb h.Pb	<i>Control Loop (1 to 2)</i> Heat Proportional Band Set the PID proportional band for the heat outputs.	0.001 to 9,999.000°F or units 0.001 to 5,555.000°C	25.0°F or units 14.0°C	<i>Instance 1</i> Map 1 1890 Map 2 2370 <i>Instance 2</i> Map 1 1960 Map 2 2440	0x97 (151) 1 to 2 6	65	8009	float RWES

** R: Read, W: Write, E: EEPROM, S: User Set

Operations Page

Display	Parameter Name Description	Range	Default	Modbus Relative Address	CIP Class Instance Attribute hex (dec)	Pro-fibus Index	Pa-ram-eter ID	Data Type and Access **
h.hy h.hy	<i>Control Loop (1 to 2)</i> On/Off Heat Hysteresis Set the control switching hysteresis for on-off control. This determines how far into the "on" region the process value needs to move before the output turns on.	0.001 to 9,999.000°F or units 0.001 to 5,555.000°C	3.0°F or units 2.0°C	<i>Instance 1</i> Map 1 Map 2 1900 2380 <i>Instance 2</i> Map 1 Map 2 1970 2450	0x97 (151) 1 to 2 0xB (11)	66	8010	float RWES
C.Pb C.Pb	<i>Control Loop (1 to 2)</i> Cool Proportional Band Set the PID proportional band for the cool outputs.	0.001 to 9,999.000°F or units 0.001 to 5,555.000°C	25.0°F or units 14.0°C	<i>Instance 1</i> Map 1 Map 2 1892 2372 <i>Instance 2</i> Map 1 Map 2 1962 2442	0x97 (151) 1 to 2 7	67	8012	float RWES
C.hy C.hy	<i>Control Loop (1 to 2)</i> On/Off Cool Hysteresis Set the control switching hysteresis for on-off control. This determines how far into the "on" region the process value needs to move before the output turns on.	0.001 to 9,999.000°F or units 0.001 to 5,555.000°C	3.0°F or units 2.0°C	<i>Instance 1</i> Map 1 Map 2 1902 2382 <i>Instance 2</i> Map 1 Map 2 1972 2522	0x97 (151) 1 to 2 0xC (12)	68	8013	float RWES
ti ti	<i>Control Loop (1 to 2)</i> Time Integral Set the PID integral for the outputs.	0 to 9,999 seconds per repeat	180 seconds per repeat	<i>Instance 1</i> Map 1 Map 2 1894 2374 <i>Instance 2</i> Map 1 Map 2 1964 2444	0x97 (151) 1 to 2 8	69	8006	float RWES
** R: Read, W: Write, E: EEPROM, S: User Set								

Operations Page

Display	Parameter Name Description	Range	Default	Modbus Relative Address	CIP Class Instance Attribute hex (dec)	Pro-fibus Index	Parameter ID	Data Type and Access **
<i>td</i>	<i>Control Loop (1 to 2)</i> Time Derivative Set the PID derivative time for the outputs.	0 to 9,999 seconds	0 seconds	<i>Instance 1</i> Map 1 Map 2 1896 2376 <i>Instance 2</i> Map 1 Map 2 1966 2446	0x97 (151) 1 to 2 9	70	8007	float RWES
<i>db</i>	<i>Control Loop (1 to 2)</i> Dead Band Set the offset to the proportional band. With a negative value, both heating and cooling outputs are active when the process value is near the set point. A positive value keeps heating and cooling outputs from fighting each other.	-1,000.0 to 1,000.0°F or units -556 to 556°C	0.0	<i>Instance 1</i> Map 1 Map 2 1898 2378 <i>Instance 2</i> Map 1 Map 2 1968 2448	0x97 (151) 1 to 2 0xA (10)	71	8008	float RWES
<i>o.SP</i>	<i>Control Loop (1 to 2)</i> Manual Power Set a fixed level of output power when in manual (open-loop) mode.	-100 to 100% (heat and cool) 0 to 100% (heat only) -100 to 0% (cool only)	0.0	<i>Instance 1</i> Map 1 Map 2 2162 2642 <i>Instance 2</i> Map 1 Map 2 2242 2722	0x6B (107) 1 to 2 2	51	7002	float RWES
No Display	<i>Control Loop (1 to 2)</i> Loop Error Open Loop detect deviation has been exceeded.	<i>none</i> None (61) <i>LP.o</i> Open Loop (1274) <i>LP.r</i> Reversed Sensor (1275)	- - - -	<i>Instance 1</i> Map 1 Map 2 1928 2408 <i>Instance 2</i> Map 1 Map 2 1998 2478	0x6C (108) 1 0x30 (48)	- - - -	8048	uint R
No Display	Control Loop (1 to 2) Clear Loop Error Current state of limit output.	<i>CLR</i> Clear (129) <i>IGNR</i> Ignore (204)	- - - -	<i>Instance 1</i> Map 1 Map 2 1930 2410 <i>Instance 2</i> Map 1 Map 2 2000 2480	0x6C (108) 1 0x31 (49)	- - - -	8049	uint W

** R: Read, W: Write, E: EEPROM, S: User Set

Operations Page

Display	Parameter Name Description	Range	Default	Modbus Relative Address	CIP Class Instance Attribute hex (dec)	Pro-fibus Index	Parameter ID	Data Type and Access **
No Display	Control Loop (1 to 2) Loop Output Power View the loop output power.	-100.0 to 100.0	----	<i>Instance 1</i> Map 1 Map 2 1908 2388 <i>Instance 2</i> Map 1 Map 2 1978 2458	0x97 (151) 1 to 2 0x0F (15)	----	8033	float R
<p>AL?? oPEr Alarm Menu</p>								
ALo A.Lo	<i>Alarm (1 to 4)</i> Low Set Point If Type (Setup Page, Alarm Menu) is set to: Process - set the process value that will trigger a low alarm. Deviation - set the span of units from the set point that will trigger a low alarm. A negative set point represents a value below closed loop set point. A positive set point represents a value above closed loop set point.	-1,999.000 to 9,999.000 °F or units -1,128.000 to 5,537.000 °C	32.0 °F or units 0.0 °C	<i>Instance 1</i> Map 1 Map 2 1482 1882 Offset to next instance (Map 1) equals +50 Offset to next instance (Map 2) equals +60	0x6D (109) 1 to 24 2	18	9002	float RWES
<p>** R: Read, W: Write, E: EEPROM, S: User Set</p>								

Operations Page

Display	Parameter Name Description	Range	Default	Modbus Relative Address	CIP Class Instance Attribute hex (dec)	Pro-fibus Index	Parameter ID	Data Type and Access **
A.h A.hi	<i>Alarm (1 to 4)</i> High Set Point If Type (Setup Page, Alarm Menu) is set to: Process - set the process value that will trigger a high alarm. Deviation - set the span of units from the set point that will trigger a low alarm. A negative set point represents a value below closed loop set point. A positive set point represents a value above closed loop set point.	-1,999.000 to 9,999.000 °F or units -1,128.000 to 5,537.000 °C	300.0 °F or units 150.0 °C	<i>Instance 1</i> Map 1 Map 2 1480 1880 Offset to next instance (Map 1) equals +50 Offset to next instance (Map 2) equals +60	0x6D (109) 1 to 4 1	19	9001	float RWES
A.CLR A.CLR	<i>Alarm (1 to 4)</i> Clear Alarm Write to this register to clear an alarm	CLR Clear (1003) IGNR Ignore (204)	----	<i>Instance 1</i> Map 1 Map 2 1504 1904 Offset to next instance (Map1 1 equals +50, Map 2 equals +60)	0x6D (109) 1 to 4 0x0D (13)	----	9026	uint W
A.Sil A.Sil	<i>Alarm (1 to 4)</i> Silence Alarm Write to this register to silence an alarm	SIL Silence (1010)		<i>Instance 1</i> Map 1 Map 2 1506 1906 Offset to next instance (Map1 1 equals +50, Map 2 equals +60)	0x6D (109) 1 to 4 0x0E (14)	----	9027	uint W

** R: Read, W: Write, E: EEPROM, S: User Set

Operations Page

Display	Parameter Name Description	Range	Default	Modbus Relative Address	CIP Class Instance Attribute hex (dec)	Pro-fibus Index	Parameter ID	Data Type and Access **
ALSt A.St	<i>Alarm (1 to 4)</i> State Current state of alarm	Startup (88) None (61) Blocked (12) Alarm low (8) Alarm high (7) Error (28)	----	<i>Instance 1</i> Map 1 Map 2 1496 1896 Offset to next instance (Map1 1 equals +50, Map 2 equals +60)	0x6D (109) 1 to 2 9	----	9009	uint R
No Display	<i>Alarm (1 to 4)</i> Alarm Clearable Indicates if alarm can be cleared.	No (59) Yes (106)		<i>Instance 1</i> Map 1 Map 2 1502 1902 Offset to next instance (Map1 1 equals +50, Map 2 equals +60)	0x6D (109) 1 to 4 0xC (12)	----	9012	uint R
No Display	<i>Alarm (1 to 4)</i> Alarm Silenced Indicates if alarm is silenced.	No (59) Yes (106)	----	<i>Instance 1</i> Map 1 Map 2 1500 1900 Offset to next instance (Map1 1 equals +50, Map 2 equals +60)	0x6D (109) 1 to 4 0x0B (11)	----	9011	uint R
No Display	<i>Alarm (1 to 4)</i> Alarm Latched Indicates if alarm is latched.	No (59) Yes (106)	----	<i>Instance 1</i> Map 1 Map 2 1498 1898 Offset to next instance (Map1 1 equals +50, Map 2 equals +60)	0x6D (109) 1 to 4 0x0A (10)	----	9010	uint R
<p>CUrr oPEr Current Menu</p>								
Ch C.hi	<i>Current (1)</i> High Set Point Set the current value that will trigger a high heater error state.	-1,999.000 to 9,999.000	50.0	<i>Instance 1</i> Map 1 Map 2 1134 1374	0x73 (115) 1 8	----	15008	float RWES
** R: Read, W: Write, E: EEPROM, S: User Set								

Operations Page

Display	Parameter Name Description	Range	Default	Modbus Relative Address	CIP Class Instance Attribute hex (dec)	Pro-fibus Index	Parameter ID	Data Type and Access **
C.Lo C.Lo	<i>Current (1)</i> Low Set Point Set the current value that will trigger a low heater error state.	-1,999.000 to 9,999.000	0.0	<i>Instance 1</i> Map 1 Map 2 1136 1376	0x73 (115) 1 9	- - - -	15009	float RWES
LdCu CU.r	<i>Current (1)</i> Load Current RMS View the RMS value of the measured current.	0 to 9,999.00	- - - -	<i>Instance 1</i> Map 1 Map 2 1132 1372	0x73 (115) 1 7	- - - -	15007	float R
C.Er C.Er	<i>Current (1)</i> Error View the most recent load fault.	nonE None (61) Shrt Shorted (127) oPEr Open (65)	- - - -	<i>Instance 1</i> Map 1 Map 2 1160 1400	0x73 (115) 1 2	- - - -	15002	uint R
h.Er h.Er	<i>Current (1)</i> Heater Error Determine if load current flow is within the High and Low Set Points.	nonE None (61) h,gh High (37) LowD Low (53)	- - - -	<i>Instance 1</i> Map 1 Map 2 1124 1364	0x73 (115) 1 3	- - - -	15003	uint R
No Display	<i>Current (1)</i> Error Status View the most recent load fault	None (61) Fail (32)	- - - -	<i>Instance 1</i> Map 1 Map 2 1160 1400	0x73 (115) 1 21	- - - -	15021	uint R
Er oPEr Timer Menu								
Su.A Su.A	<i>Timer (1)</i> Source Value A View the state of Source Function A.	on On (63) oFF Off (62)	- - - -	<i>Instance 1</i> Map 1 Map 2 4582 8012	0x83 (109) 1 0x07 (7)	- - - -	31007	uint R
Su.C Su.C	<i>Timer (1)</i> Source Value C View the value of Source Function C.	-1999.000 to 999.000°F or units -1110.555 to 5555.000	- - - -	<i>Instance 1</i> Map 1 Map 2 4642 8572	0x83 (109) 1 0x25 (37)	- - - -	31037	float R
Su.d Su.d	<i>Timer (1)</i> Source Value D View the state of Source Function D.	on On (63) oFF Off (62)	- - - -	<i>Instance 1</i> Map 1 Map 2 4644 8574	0x83 (109) 1 0x26 (38)	- - - -	31038	uint R
P.SP1 P.SP1	<i>Timer (1)</i> Produced Set Point 1 View the value of Set Point 1.	-1999.000 to 999.000°F or units -1110.555 to 5555.000	- - - -	<i>Instance 1</i> Map 1 Map 2 4646 8576	0x83 (109) 1 0x27 (39)	- - - -	31039	float R
** R: Read, W: Write, E: EEPROM, S: User Set								

Operations Page

Display	Parameter Name Description	Range	Default	Modbus Relative Address	CIP Class Instance Attribute hex (dec)	Pro-fibus Index	Pa-ram-eter ID	Data Type and Access **
tE.o1 tE.o1	Timer (1) Timer Event Output 1 View the state of Event Output 1.	On (63) Off (62)	----	Instance 1 Map 1 4648 Map 2 8578	0x83 (109) 1 0x28 (40)	----	31040	uint R
tE.o2 tE.o2	Timer (1) Timer Event Output 2 View the state of Event Output 2.	On (63) Off (62)	----	Instance 1 Map 1 4650 Map 2 8580	0x83 (109) 1 0x29 (41)	----	31041	uint R
tE.o3 tE.o3	Timer (1) Timer Event Output 3 View the state of Event Output 3.	On (63) Off (62)	----	Instance 1 Map 1 4662 Map 2 8590	0x83 (109) 1 0x2E (46)	----	31046	uint R
t.r t.r	Timer (1) Time Remaining Display the time remaining on the timer.	00:00 to 99:59	7	Instance 1 Map 1 Map 2 -----	0x83 (131) 1 0x15 (21)	----	31021	string R
r.bS r.bS	Timer (1) Ready Band State Display whether the process value is in the ready band.	YES Yes (106) no No (59)	----	Instance 1 Map 1 4612 Map 2 8542	0x83 (131) 1 0x16 (22)	----	31022	uint R
hoUr hoUr	Timer (1) Hours Set the timer period hours.	0 to 99	0	Instance 1 Map 1 4618 Map 2 8548	0x83 (131) 1 0x19 (25)	----	31025	uint RWES
Min Min	Timer (1) Minutes Set the timer period minutes.	0 to 59	0	Instance 1 Map 1 4620 Map 2 8550	0x83 (131) 1 0x1A (26)	----	31026	uint RWES
SEC SEC	Timer (1) Seconds Set the timer period seconds.	0 to 59	10	Instance 1 Map 1 4622 Map 2 8552	0x83 (131) 1 0x1B (27)	----	31027	uint RWES
Ct.SP Ct.SP	Timer (1) Closed Loop Timer Set Point Set the set point that will be in effect during the timer period.	-1999.000 to 9999.000° F or units -1110.555 to 5555.000° C	75	Instance 1 Map 1 4624 Map 2 8554	0x83 (131) 1 0x1C (28)	----	31028	float RWES

** R: Read, W: Write, E: EEPROM, S: User Set

Operations Page

Display	Parameter Name Description	Range	Default	Modbus Relative Address	CIP Class Instance Attribute hex (dec)	Pro-fibus Index	Pa-ram-eter ID	Data Type and Access **
No Display	<i>Timer (1)</i> Timer Timing Indicates whether the timer is running.	On (63) Off (62)	- - - -	<i>Instance 1</i> Map 1 Map 2 4598 8528	0x83 (131) 1 0x0F (15)	- - - -	31015	uint R
No Display	<i>Timer (1)</i> Output Error Indicates errors that may have interfered with the timer operation.	None (61) Open (65) Shorted (127) Measurement Error (140) Bad Calibration Data (139) Ambient Error (9) RTD Error (141) Fail (32) Math Error (1423) Not Sourced (246) Stale (1617)	- - - -	<i>Instance 1</i> Map 1 Map 2 4604 8534	0x83 (131) 1 0x12 (18)	- - - -	31018	uint R
No Display	<i>Timer (1)</i> Indicator Request View the status of the timer illuminated indicators.	Off (62) Ready (1662) Ready Ack (1950) Running (149)	- - - -	<i>Instance 1</i> Map 1 Map 2 4652 8582	0x83 (131) 1 0x2A (42)	- - - -	31042	uint R
No Display	<i>Timer (1)</i> Countdown State View the state of the countdown cycle.	Inactive (41) Wait Process (209) Wait Event (144) Running (149) Pause (146) Complete (18) End (27)	- - - -	<i>Instance 1</i> Map 1 Map 2 4654 8584	0x83 (131) 1 0x2B (43)	- - - -	31043	uint R
No Display	<i>Timer (1)</i> Elapsed Signal Time Counts from 0 to Signal Time while signal time is active.	0 to 4,294,967,295 mS	- - - -	<i>Instance 1</i> Map 1 Map 2 4662 8592	0x83 (131) 1 0x2F (47)	- - - -	31047	udint R
No Display	<i>Timer (1)</i> Elapsed Time Counts from 0 to Countdown Time while time cycle is active.	0 to 4,294,967,295 mS	- - - -	<i>Instance 1</i> Map 1 Map 2 4664 8594	0x83 (131) 1 0x30 (48)	- - - -	31048	udint R

** R: Read, W: Write, E: EEPROM, S: User Set

Operations Page

Display	Parameter Name Description	Range	Default	Modbus Relative Address	CIP Class Instance Attribute hex (dec)	Pro-fibus Index	Parameter ID	Data Type and Access **
<p>PAR OPER Math Menu</p>								
Su.A Su.A	<i>Math (1)</i> Source Value A View the value of Source A.	-1,999.000 to 9,999.000 °F or units -1,128.000 to 5,537.000 °C	----	<i>Instance 1</i> Map 1 Map 2 ---- 3030	0x7D (125) 1 0x10 (16)	----	25016	float R
Su.b Su.b	<i>Math (1)</i> Source Value B View the value of Source B.	-1,999.000 to 9,999.000 °F or units -1,128.000 to 5,537.000 °C	----	<i>Instance 1</i> Map 1 Map 2 ---- 3032	0x7D (125) 1 0x11 (17)	----	25017	float R
Su.E Su.E	<i>Math (1)</i> Source Value E View the value of Source E.	OFF Off (62) ON On (63)	----	<i>Instance 1</i> Map 1 Map 2 ---- 3038	0x7D (125) 1 0x14 (20)	----	25020	uint R
oFSt oFSt	<i>Math (1)</i> Offset Set an offset to be applied to this function's output.	-1,999.000 to 9,999.000 °F or units -1,128.000 to 5,537.000 °C	0	<i>Instance 1</i> Map 1 Map 2 ---- 3044	0x7D (125) 1 0x17 (23)	----	25023	float RWES
o.v o.v	<i>Math (1)</i> Output Value View the value of this function's output.	-1,999.000 to 9,999.000 °F or units -1,128.000 to 5,537.000 °C	----	<i>Instance 1</i> Map 1 Map 2 ---- 3042	0x7D (125) 1 0x16 (22)	----	25022	float R
No Display	<i>Math (1)</i> Error Read reported cause for math error	None (61) Open (65) Shorted (127) Measurement Error (140) Bad Cal Data (139) Ambient Error (9) RTD Error (141) Fail (32) Math Error (1423) Not Sourced (246) Stale (1617)	----	<i>Instance 1</i> Map 1 Map 2 ---- 3056	0x7D (125) 1 0x1D (29)	----	25029	uint R
<p>SoF OPER Special Output Function Menu</p>								
Su.A Su.A	<i>Special Output Function (1)</i> Source Value A View the value of Source A.	-1,999.000 to 9,999.000 °F or units -1,128.000 to 5,537.000 °C	----	<i>Instance 1</i> Map 1 Map 2 ---- 3852	0x87 (135) 1 7	----	35007	float R
<p>** R: Read, W: Write, E: EEPROM, S: User Set</p>								

Operations Page

Display	Parameter Name Description	Range	Default	Modbus Relative Address	CIP Class Instance Attribute hex (dec)	Pro-fibus Index	Pa-ram-eter ID	Data Type and Access **
5.u.b Su.b	<i>Special Output Function (1)</i> Source Value B View the value of Source B.	-1,999.000 to 9,999.000°F or units -1,128.000 to 5,537.000°C	- - - -	<i>Instance 1</i> Map 1 Map 2 - - - - 3854	0x87 (135) 1 8	- - - -	35008	float R
o.u.1 o.v1	<i>Special Output Function (1)</i> Output Value 1 View the value of this function's Output 1.	-1,999.000 to 9,999.000°F or units -1,128.000 to 5,537.000°C	- - - -	<i>Instance 1</i> Map 1 Map 2 - - - - 3858	0x87 (135) 1 0xA (10)	- - - -	35010	float R
o.u.2 o.v2	<i>Special Output Function (1)</i> Output Value 2 View the value of this function's Output 2.	-1,999.000 to 9,999.000°F or units -1,128.000 to 5,537.000°C	- - - -	<i>Instance 1</i> Map 1 Map 2 - - - - 3862	0x87 (135) 1 0xC (12)	- - - -	35012	float R
No Display	<i>Special Output Function (1)</i> Error 1 View reported output malfunction.	None (61) Open (65) Shorted (127) Measurement error (140) Bad calibration data (139) Ambient error (9) RTD error (14) Fail (32) Math error (1423) Not sourced (246) Stale (1617) Can't process (1659)	- - - -	<i>Instance 1</i> Map 1 Map 2 - - - - 3860	0x87 (135) 1 0x0B (11)	- - - -	35011	uint R
No Display	<i>Special Output Function (1 to 4)</i> Error 2 View reported cause for output malfunction.	None (61) Open (65) Shorted (127) Measurement error (140) Bad calibration data (139) Ambient error (9) RTD error (14) Fail (32) Math error (1423) Not sourced (246) Stale (1617) Can't process (1659)	- - - -	<i>Instance 1</i> Map 1 Map 2 - - - - 3940	0x87 (135) 1 to 4 0x0D (13)	- - - -	35013	uint R

** R: Read, W: Write, E: EEPROM, S: User Set

Operations Page

Display	Parameter Name Description	Range	Default	Modbus Relative Address	CIP Class Instance Attribute hex (dec)	Pro-fibus Index	Pa-ram-eter ID	Data Type and Access **
P.S.tA oPEr Profile Status Menu		* Available with PM8/9 only. * Some parameters in the Profile Status Menu can be changed for the currently running profile, but should only be changed by knowledgeable personnel and with caution. Changing parameters via the Profile Status Menu will not change the stored profile but will have an immediate impact on the profile that is running. Changes made to profile parameters in the Profiling Pages will be saved and will also have an immediate impact on the running profile.						
P.S.tP P.Str	Profile Status Profile Start	1 to 40	1	Instance 1 Map 1 2520 Map 2 4340	0x7A (122) 1 1	204	22001	uint W
P.A.Cr PACr	Profile Status Action Request	nonE None (61) S.tEP Step (89) End Terminate (148) r.ESU Resume (147) PAUS Pause (146) Pr.oF Profile (77)	None	Instance 1 Map 1 2540 Map 2 4360	0x7A (122) 1 0xB (11)	205	22011	uint W
S.tP StP	Profile Status Current Step View the currently running step.	1 to 40 0 (none)	- - - -	Instance 1 Map 1 2526 Map 2 4346	0x7A (122) 1 4	- - - -	22004	uint R
S.tYP S.typ	Profile Status Step Type View the currently running step type.	US.tP Unused Step (50) SoAKH Soak (87) W.tE Wait For Event (144) W.tPr Wait For Process (209) W.tbo Wait For Process or Event (210) JL Jump (116) End End (27) CL.oC Wait For Time (1543) t. i Time (143) r.A.tE Ramp Rate (81)	- - - -	Instance 1 Map 1 2544 Map 2 4364	0x7A (122) 1 0xD (13)	- - - -	22013	uint R
t.SP1 t.SP1	Profile Status *Target Set Point Loop 1 View or change the target set point of the current step.	-1,999.000 to 9,999.000 °F or units -1,128.000 to 5,537.000 °C	0.0°F or units -18.0°C	Instance 1 Map 1 2542 Map 2 4362	0x7A (122) 1 0xC (12)	- - - -	22012	float RW
** R: Read, W: Write, E: EEPROM, S: User Set								

Operations Page

Display	Parameter Name Description	Range	Default	Modbus Relative Address	CIP Class Instance Attribute hex (dec)	Pro-fibus Index	Parameter ID	Data Type and Access **
t.SP2 t.SP2	<i>Profile Status</i> *Target Set Point Loop 2 View or change the target set point of the current step.	-1,999.000 to 9,999.000° F or units -1,128.000 to 5,537.000° C	0.0° F or units -18.0° C	<i>Instance 1</i> Map 1 Map 2 - - - - 4434	0x7A (122) 1 0x30 (48)	- - - -	22048	float RW
AC.SP AC.SP	<i>Profile Status</i> Produced Set Point 1 Display the current set point, even if the profile is ramping.	-1,999.000 to 9,999.000° F or units -1,128.000 to 5,537.000° C	- - - -	<i>Instance 1</i> Map 1 Map 2 2528 4348	- - - -	- - - -	22005	float R
P.SP2 P.SP2	<i>Profile Status</i> Produced Set Point 2 Display the current set point, even if the profile is ramping.	-1,999.000 to 9,999.000° F or units -1,128.000 to 5,537.000° C	- - - -	<i>Instance 1</i> Map 1 Map 2 - - - - 4440	- - - -	- - - -	22051	float R
hoUr hoUr	<i>Profile Status</i> Hours Step time remaining in hours.	0 to 9999	0	<i>Instance 1</i> Map 1 Map 2 - - - - 4494	0x7A (122) 1 0x4E (78)	- - - -	22078	uint RW
Min Min	<i>Profile Status</i> Minutes Step time remaining in minutes.	0 to 59	0	<i>Instance 1</i> Map 1 Map 2 - - - - 4492	0x7A (122) 1 0x4D (77)	- - - -	22077	uint RW
SEC SEC	<i>Profile Status</i> Seconds Step time remaining in seconds.	0 to 59	0	<i>Instance 1</i> Map 1 Map 2 - - - - 4490	0x7A (122) 1 0x4C (76)	- - - -	22076	uint RW
Ent 1 Ent1	<i>Profile Status</i> *Event 1 View or change the event output states.	OFF Off (62) ON On (63)	Off	<i>Instance 1</i> Map 1 Map 2 2546 4366	0x7A (122) 1 0xE (14)	- - - -	22014	uint RW
Ent 2 Ent2	<i>Profile Status</i> *Event 2 View or change the event output states.	OFF Off (62) ON On (63)	Off	<i>Instance 1</i> Map 1 Map 2 2548 4368	0x7A (122) 1 0xF (15)	- - - -	22015	uint RW

** R: Read, W: Write, E: EEPROM, S: User Set

Operations Page

Display	Parameter Name Description	Range	Default	Modbus Relative Address	CIP Class Instance Attribute hex (dec)	Pro-fibus Index	Parameter ID	Data Type and Access **
 JC	<i>Profile Status</i> Jump Count Remaining View the jump counts remaining for the current loop. In a profile with nested loops, this may not indicate the actual jump counts remaining.	0 to 9,999	- - - -	<i>Instance 1</i> Map 1 Map 2 2538 4358	0x7A (122) 1 0xA (10)	- - - -	22010	uint R
No Display	<i>Profile Status</i> Profile State Read current Profile state.	Off (62) Running (149) Pause (146)	- - - -	<i>Instance 1</i> Map 1 Map 2 2524 4344	0x7A (122) 1 2	- - - -	22002	uint R
No Display	<i>Profile Status</i> Current File Indicates current file being executed.	1 to 25 0 (none)	- - - -	<i>Instance 1</i> Map 1 Map 2 2522 4342	0x7A (122) 1 3	- - - -	22003	uint R
** R: Read, W: Write, E: EEPROM, S: User Set								

6 Chapter 6: Setup Page

Navigating the Setup Page

To navigate to the Setup Page follow the steps below:

1. From the Home Page, press and hold both the Up ▲ and Down ▼ keys for six seconds. *A i* will appear in the upper display and *SEt* will appear in the lower display. If the up and down arrow keys are released where *oPEr* is displayed, simply press and hold those same keys for an additional 3 seconds.

Note: (for firmware release 13 and below)

If keys are released when *oPEr* is displayed, press the Infinity Key ∞ or reset key to exit and repeat until *SEt* is displayed.

2. Press the Up ▲ or Down ▼ key to view available menus.
3. Press the Advance Key ↻ to enter the menu of choice.
4. If a submenu exists (more than one instance), press the Up ▲ or Down ▼ key to select and then press the Advance Key ↻ to enter.
5. Press the Up ▲ or Down ▼ key to move through available menu prompts.
6. Press the Infinity Key ∞ to move backwards through the levels: parameter to submenu, submenu to menu, menu to Home Page.
7. Press and hold the Infinity Key ∞ for two seconds to return to the Home Page.

On the following pages, top level menus are identified with a yellow background color.

Note:

Some of these menus and parameters may not appear, depending on the controller's options. See model number information in the Appendix for more information. If there is only one instance of a menu, no submenus will appear.

Note:

Some of the listed parameters may not be visible. Parameter visibility is dependent upon controller part number.

<i>A i</i>	<i>rLo</i> Range Low	<i>iCR</i> Calibration Offset *
<i>SEt</i> Analog Input Menu	<i>rHi</i> Range High	<i>A in</i> Analog Input Value *
<i>i</i>	<i>PEE</i> Process Error Enable	<i>iEr</i> Input Error *
<i>A i</i> Analog Input (1 to 2)	<i>PEL</i> Process Error Low Value	<i>db i</i>
<i>SEn</i> Sensor Type	<i>tC</i> Thermistor Curve	<i>SEt</i> Digital Bus Menu
<i>L in</i> TC Linearization	<i>rR</i> Resistance Range	<i>i</i>
<i>rTL</i> RTD Leads	<i>F iL</i> Filter	<i>db i</i> J1939 Instance (1 to 6)
<i>Un iE</i> Units	<i>iEr</i> Input Error Latching	<i>Un iE</i> Unit
<i>SLo</i> Scale Low	<i>dEE</i> Display Precision	<i>Ei dh</i> CAN ID High Word
<i>SH i</i> Scale High		<i>Ei dL</i> CAN ID Low Word

* These parameters/prompts are available with firmware revisions 11.0 and above.

<i>EEP</i>	Encoding Type	<i>PU</i>		<i>SIA</i>	Source Instance A*
<i>byte</i>	Start Byte	<i>SEt</i>	Process Value	<i>LCr</i>	Clear Limit *
<i>bit</i>	Start Bit	<i>1</i>		<i>LSL</i>	Limit Status *
<i>LEN</i>	Length	<i>PU</i>	Process Value (1 to 2)	<i>LiT</i>	Integrate with System
<i>SNPn</i>	Scaling Numerator	<i>Fn</i>	Function	<i>LoOP</i>	
<i>SDEN</i>	Scaling Denominator	<i>PUnT</i>	Pressure Units	<i>SEt</i>	Control Loop Menu
<i>OFSt</i>	Offset	<i>AlUnT</i>	Altitude Units	<i>1</i>	
<i>FiL</i>	Filter	<i>bPr</i>	Barometric Pressure	<i>LoOP</i>	Control Loop (1 to 2)
<i>CRnU</i>	CAN Units	<i>FiL</i>	Filter	<i>hAg</i>	Heat Algorithm
<i>LnR</i>		<i>dIo</i>		<i>CRg</i>	Cool Algorithm
<i>SEt</i>	Linearization Menu	<i>SEt</i>	Digital Input/Output Menu	<i>CCr</i>	Cool Output Curve
<i>1</i>		<i>5</i>		<i>hPb</i>	Heat Proportional Band *
<i>LnR</i>	Linearization (1 to 2)	<i>dIo</i>	Digital Input/Output (5 to 12)	<i>hhY</i>	On/Off Heat Hysteresis *
<i>Fn</i>	Function	<i>dir</i>	Direction	<i>CPb</i>	Cool Proportional Band *
<i>SFnA</i>	Source Function A	<i>Fn</i>	Function	<i>ChY</i>	On/Off Cool Hysteresis *
<i>SIA</i>	Source Instance A	<i>Fi</i>	Output Function Instance	<i>tI</i>	Time Integral *
<i>SZA</i>	Source Zone A	<i>aCb</i>	Time Base Type	<i>tD</i>	Time Derivative *
<i>UnIt</i>	Units	<i>aLs</i>	Low Power Scale	<i>db</i>	Dead Band *
<i>iP.1</i>	Input Point 1	<i>ahI</i>	High Power Scale	<i>tTUn</i>	TRU-TUNE+® Enable
<i>oP.1</i>	Output Point 1	<i>LEu</i>	Active Level	<i>tbnD</i>	TRU-TUNE+ Band
<i>iP.2</i>	Input Point 2	<i>Fn</i>	Action Function	<i>tgn</i>	TRU-TUNE+ Gain
<i>oP.2</i>	Output Point 2	<i>Fi</i>	Function Instance	<i>AtSP</i>	Autotune Set Point *
<i>iP.3</i>	Input Point 3	<i>LIPn</i>		<i>tAgR</i>	Autotune Aggressiveness
<i>oP.3</i>	Output Point 3	<i>SEt</i>	Limit Menu	<i>PdL</i>	Peltier Delay
<i>iP.4</i>	Input Point 4	<i>LIPn</i>	Limit	<i>rEn</i>	Remote Set Point
<i>oP.4</i>	Output Point 4	<i>LSd</i>	Sides	<i>rty</i>	Remote Set Point Type
<i>iP.5</i>	Input Point 5	<i>LhY</i>	Hysteresis	<i>SFnB</i>	Source Function B
<i>oP.5</i>	Output Point 5	<i>SPLh</i>	Maximum Set Point	<i>SIB</i>	Source Instance B
<i>iP.6</i>	Input Point 6	<i>SPLL</i>	Minimum Set Point	<i>UFR</i>	Auto-to-Manual Power
<i>oP.6</i>	Output Point 6	<i>LhS</i>	High Limit Set Point *	<i>FRiL</i>	Input Error Power
<i>iP.7</i>	Input Point 7	<i>LLS</i>	Low Limit Set Point *	<i>PnAn</i>	Fixed Power
<i>oP.7</i>	Output Point 7	<i>SFnA</i>	Source Function A*	<i>LdE</i>	Open Loop Detect Enable
<i>iP.8</i>	Input Point 8			<i>Ldt</i>	Open Loop Detect Time
<i>oP.8</i>	Output Point 8				
<i>iP.9</i>	Input Point 9				
<i>oP.9</i>	Output Point 9				
<i>iP.10</i>	Input Point 10				
<i>oP.10</i>	Output Point 10				

* These parameters/prompts are available with firmware revisions 11.0 and above.

<i>Ldd</i>	Open Loop Detect Deviation	<i>SrA</i>	Alarm Source	<i>SEC</i>	Seconds
<i>rP</i>	Ramp Action	<i>ISA</i>	Alarm Source Instance	<i>CLSP</i>	Closed Loop Timer Set Point
<i>rSC</i>	Ramp Scale	<i>Loop</i>	Control Loop	<i>St</i>	Signal Time
<i>rRt</i>	Ramp Rate	<i>RhY</i>	Hysteresis	P7A1	
<i>LSP</i>	Minimum Set Point	<i>AL9</i>	Logic	SEt Math Menu	
<i>hSP</i>	Maximum Set Point	<i>ASd</i>	Sides	<i>Fn</i>	Function
<i>ESP</i>	Set Point*	<i>ALo</i>	Low Set Point *	<i>SFnE</i>	Source Function E
<i>idS</i>	Idle Set Point *	<i>Rh i</i>	High Set Point *	<i>SiE</i>	Source Instance E
<i>SPLo</i>	Minimum Manual Power	<i>ALR</i>	Latching	<i>SLo</i>	Scale Low
<i>SPh i</i>	Maximum Manual Power	<i>AbL</i>	Blocking	<i>Sh i</i>	Scale High
<i>oSP</i>	Manual Power *	<i>AS i</i>	Silencing	<i>rLo</i>	Range Low
<i>CP7</i>	Control Mode *	<i>AdSP</i>	Display	<i>rhi</i>	Range High
		<i>ACLr</i>	Clear Alarm *	<i>FiL</i>	Filter
		<i>ASir</i>	Silence Alarm *	SoF	
		<i>ASt</i>	Alarm State *	SEt Special Output Function Menu	
oEPt		CUrr		<i>SoF</i> Special Output Function	
SEt Output Menu		SEt Current Menu		<i>Fn</i> Function	
<i>i</i>		<i>CUrr</i>	Current	<i>Fn</i>	Function
<i>oEPt</i>	Output (1 to 4)	<i>CSd</i>	Sides	<i>SFnA</i>	Source Function A
<i>Fn</i>	Function	<i>CUr</i>	Indicate Reading	<i>SiA</i>	Source Instance A
<i>Fi</i>	Output Function Instance	<i>dt</i>	Detection Threshold	<i>SFnB</i>	Source Function B
<i>oEt</i>	Time Base Type	<i>ESC</i>	Input Scaling	<i>SiB</i>	Source Instance B
<i>oEb</i>	Fixed Time Base	<i>CoFS</i>	Heater Offset	<i>POnA</i>	Input A Turn On
<i>oLo</i>	Low Power Scale	<i>Si i</i>	Monitored Output	<i>PoFA</i>	Input A Turn Off
<i>oHi</i>	High Power Scale	CP7r		<i>POnB</i>	Input B Turn On
<i>oEPt</i>	Output Process 1, 3	SEt Timer Menu		<i>PoFB</i>	Input B Turn Off
<i>oEY</i>	Type	<i>tiEn</i>	Timer Enable	<i>oOn</i>	Minimum On Time
<i>Fn</i>	Function	<i>tiSt</i>	Timer Start Method	<i>oFt</i>	Minimum Off Time
<i>rSr</i>	Retransmit Source	<i>SFnA</i>	Source Function A	<i>tt</i>	Valve Travel Time
<i>Fi</i>	Output Function Instance	<i>SiA</i>	Source Instance A	<i>db</i>	Dead Band
<i>SLo</i>	Scale Low	<i>SFnC</i>	Source Function C	<i>tdL</i>	Time Delay
<i>Sh i</i>	Scale High	<i>SiC</i>	Source Instance C	FUn	
<i>rLo</i>	Range Low	<i>SFnD</i>	Source Function D	SEt Variable Menu	
<i>rhi</i>	Range High	<i>SiD</i>	Source Instance D	<i>i</i>	
<i>oEA</i>	Calibration Offset	<i>tr</i>	Time Remaining	<i>FUn</i> Function Key (1 to 2)	
ALP7		<i>rB5</i>	Ready Band State	<i>LEu</i>	Active Level
SEt Alarm Menu		<i>rDY</i>	Ready Band	<i>Fn</i>	Action Function
<i>i</i>		<i>tFor</i>	Time Format	<i>Fi</i>	Function Instance
<i>ALP7</i>	Alarm (1 to 4)	<i>hour</i>	Hours		
<i>AEY</i>	Type	<i>P7in</i>	Minutes		

* These parameters/prompts are available with firmware revisions 11.0 and above.

9LbL	1	FCE DeviceNet™ Quick Connect Enable
SEt Global Menu	.PF2 IP Fixed Address Part 2	PAdd Profibus Address
9LbL Global		ALoC Profibus Address Lock
C_F Display Units	.PF3 IP Fixed Address Part 3	StAt Profibus Status
ACLF AC Line Frequency	.PF4 IP Fixed Address Part 4	JAd J1939 Device Address
r.tYP Ramping Type	.PF5 IP Fixed Address Part 5	JbAU J1939 Baud Rate
P.tYP Profile Type	.PF6 IP Fixed Address Part 6	dEn J1939 Device Enable
gSE Guaranteed Soak Enable	.PS1 IP Fixed Subnet Part 1	tEdS Read Enable
gSd1 Guaranteed Soak Deviation 1	.PS2 IP Fixed Subnet Part 2	C_F Display Units
gSd2 Guaranteed Soak Deviation 2	.PS3 IP Fixed Subnet Part 3	P7AP Data Map
S.iA Source Instance A	.PS4 IP Fixed Subnet Part 4	nUS Non-volatile Save
S.ib Source Instance B	.PS5 IP Fixed Subnet Part 5	
SFnE Source Function E	.PS6 IP Fixed Subnet Part 6	r.tC
S.iE Source Instance E	.P91 IP Fixed Gateway Part 1	SEt Real Time Clock
SFnF Source Function F	.P92 IP Fixed Gateway Part 2	hour Hours
S.iF Source Instance F	.P93 IP Fixed Gateway Part 3	P7.in Minutes
POt.t Power Off Time	.P94 IP Fixed Gateway Part 4	dobW Day of Week
Sut.b Synchronized Variable Time Base	.P95 IP Fixed Gateway Part 5	
CLEd Communications LED Action	.P96 IP Fixed Gateway Part 6	
Zone	P7bE Modbus TCP Enable	
Chan	E.iPE EtherNet/IP Enable	
dPr.S Display Pairs	Aqnb CIP Implicit Assembly Output Member Quantity	
dt.t Display Time	A.inb CIP Implicit Assembly Input Member Quantity	
USr.S Save Settings As	Add DeviceNet™ Node Address	
USr.r Restore Settings From	BAUD Baud Rate DeviceNet™	
COPT		
SEt Communications Menu		
1		
COPT Communications (1 to 2)		
PEoL Protocol		
AdS Standard Bus Address		
AdPT Modbus Address		
bAUD Baud Rate		
PAR Parity		
P7hL Modbus Word Order		
.PPT IP Address Mode		
.PF1 IP Fixed Address Part		

Setup Page

Display	Parameter Name Description	Range	Default	Modbus Relative Address	CIP - Class Instance Attribute hex (dec)	Pro-fibus Index	Parameter ID	Data Type and Access **
<p>A, SEt Analog Input Menu</p>								
SEn SEn	Analog Input (1 to 2) Sensor Type Set the analog sensor type to match the device wired to this input. Note: There is no open sensor protection for process inputs.	OFF Off (62) TC Thermocouple (95) mv Millivolts (56) vdc Volts dc (104) mA Milliamps dc (112) RTD 100 RTD 100 Ω (113) RTD 1000 RTD 1,000 Ω (114) Pot Potentiometer 1 kΩ (155) Therm Thermistor (229)	Thermocouple or Thermistor	<i>Instance 1</i> Map 1 Map 2 368 368 <i>Instance 2</i> Map 1 Map 2 448 458	0x68 (104) 1 to 2 5	3	4005	uint RWES
Lin Lin	Analog Input (1 to 2) TC Linearization Set the linearization to match the thermocouple wired to this input.	B B (11) H K (48) C C (15) N N (58) D D (23) R R (80) E E (26) S S (84) F F (30) T T (93) J J (46)	J	<i>Instance 1</i> Map 1 Map 2 370 370 <i>Instance 2</i> Map 1 Map 2 450 460	0x68 (104) 1 to 2 6	4	4006	uint RWES
rt.L rt.L	Analog Input (1 to 2) RTD Leads Set to match the number of leads on the RTD wired to this input.	2 2 (1) 3 3 (2)	2	<i>Instance 1</i> Map 1 Map 2 372 372 <i>Instance 2</i> Map 1 Map 2 452 462	0x68 (104) 1 to 2 7	- - - -	4007	uint RWES
Unit Unit	Analog Input (1 to 2) Units Set the type of units the sensor will measure.	Temp Absolute Temperature (1540) Hum Relative Humidity (1538) Proc Process (75) Power Power (73)	Process	<i>Instance 1</i> Map 1 Map 2 - - - - 442 <i>Instance 2</i> Map 1 Map 2 - - - - 532	0x68 (104) 1 to 2 0x2A (42)	5	4042	uint RWES
<p>* These parameters/prompts are available in these menus with firmware revisions 11.0 and above. ** R: Read, W: Write, E: EEPROM, S: User Set</p>								

Setup Page								
Display	Parameter Name Description	Range	Default	Modbus Relative Address	CIP - Class Instance Attribute hex (dec)	Pro-fibus Index	Parameter ID	Data Type and Access **
S.Lo S.Lo	<i>Analog Input (1 to 2)</i> Scale Low Set the low scale for process inputs. This value, in millivolts, volts or milliamps, will correspond to the Range Low output of this function block.	-100.00 to 1,000.00	0.0	<i>Instance 1</i> Map 1 Map 2 388 388 <i>Instance 2</i> Map 1 Map 2 468 478	0x68 (104) 1 to 2 0xF (15)	6	4015	float RWES
S.hi S.hi	<i>Analog Input (1 to 2)</i> Scale High Set the high scale for process inputs. This value, in millivolts, volts or milliamperes, will correspond to the Range High output of this function block.	-100.00 to 1,000.00	20.0	<i>Instance 1</i> Map 1 Map 2 390 390 <i>Instance 2</i> Map 1 Map 2 470 480	0x68 (104) 1 to 2 0x10 (16)	7	4016	float RWES
r.Lo r.Lo	<i>Analog Input (1 to 2)</i> Range Low Set the low range for this function block's output.	-1,999.000 to 9,999.000	0.0	<i>Instance 1</i> Map 1 Map 2 392 392 <i>Instance 2</i> Map 1 Map 2 472 482	0x68 (104) 1 to 2 0x11 (17)	8	4017	float RWES
r.hi r.hi	<i>Analog Input (1 to 2)</i> Range High Set the high range for this function block's output.	-1,999.000 to 9,999.000	9,999	<i>Instance 1</i> Map 1 Map 2 394 394 <i>Instance 2</i> Map 1 Map 2 474 484	0x68 (104) 1 to 2 0x12 (18)	9	4018	float RWES
P.EE P.EE	<i>Analog Input (1 to 2)</i> Process Error Enable Turn the Process Error Low feature on or off.	OFF Off (62) LOLD Low (53)	Off	<i>Instance 1</i> Map 1 Map 2 418 418 <i>Instance 2</i> Map 1 Map 2 498 508	0x68 (104) 1 to 2 0x1E (30)	10	4030	uint RWES
P.EL P.EL	<i>Analog Input (1 to 2)</i> Process Error Low Value If the process value drops below this value, it will trigger an input error.	-100.00 to 1,000.00	0.0	<i>Instance 1</i> Map 1 Map 2 420 420 <i>Instance 2</i> Map 1 Map 2 500 510	0x68 (104) 1 to 2 0x1F (31)	11	4031	float RWES
* These parameters/prompts are available in these menus with firmware revisions 11.0 and above. ** R: Read, W: Write, E: EEPROM, S: User Set								

Setup Page

Display	Parameter Name Description	Range	Default	Modbus Relative Address	CIP - Class Instance Attribute hex (dec)	Pro-fibus Index	Parameter ID	Data Type and Access **
t.C t.C	Analog Input (1 to 2) Thermistor Curve Select a curve to apply to the thermistor input.	A Curve A (1451) B Curve B (1452) C Curve C (1453) CUSE Custom (180)	Curve A	<i>Instance 1</i> Map 1 Map 2 434 434 <i>Instance 2</i> Map 1 Map 2 514 524	0x68 (104) 1 to 2 0x26 (38)	- - - -	4038	uint RWES
r.r r.r	Analog Input (1 to 2) Resistance Range Set the maximum resistance of the thermistor input.	5 5K (1448) 10 10K (1360) 20 20K (1361) 40 40K (1449)	40K	<i>Instance 1</i> Map 1 Map 2 432 432 <i>Instance 2</i> Map 1 Map 2 512 522	0x68 (104) 1 to 2 0x25 (37)	- - - -	4037	uint RWES
F iL FiL	Analog Input (1 to 2) Filter Filtering smooths out the process signal to both the display and the input. Increase the time to increase filtering. Note: Filter does not apply to the Limit sensor but does apply to all other functions.	0.0 to 60.0 seconds	0.5	<i>Instance 1</i> Map 1 Map 2 386 386 <i>Instance 2</i> Map 1 Map 2 466 476	0x68 (104) 1 to 2 0xE (14)	12	4014	float RWES
i.Er i.Er	Analog Input (1 to 2) Input Error Latching Turn input error latching on or off. If latching is on, errors must be manually cleared.	oFF Off (62) oN On (63)	Off	<i>Instance 1</i> Map 1 Map 2 414 414 <i>Instance 2</i> Map 1 Map 2 494 504	0x68 (104) 1 to 2 0x1C (28)	- - - -	4028	uint RWES
dEC dEC	Analog Input (1 to 2) Display Precision Set the precision of the displayed value.	0 Whole (105) 00 Tenths (94) 000 Hundredths (40) 0000 Thousandths (96)	Whole	<i>Instance 1</i> Map 1 Map 2 398 398 <i>Instance 2</i> Map 1 Map 2 478 488	0x68 (104) 1 to 2 0x14 (20)	- - - -	4020	uint RWES

* These parameters/prompts are available in these menus with firmware revisions 11.0 and above.

** R: Read, W: Write, E: EEPROM, S: User Set

Setup Page

Display	Parameter Name Description	Range	Default	Modbus Relative Address	CIP - Class Instance Attribute hex (dec)	Pro-fibus Index	Parameter ID	Data Type and Access **
i.CA	<i>Analog Input (1 to 2)</i> Calibration Offset * Offset the input reading to compensate for lead wire resistance or other factors that cause the input reading to vary from the actual process value.	-1,999.000 to 9,999.000 °F or units -1,110.555 to 5,555.000 °C	0.0	<i>Instance 1</i> Map 1 Map 2 382 382 <i>Instance 2</i> Map 1 Map 2 462 472	0x68 (104) 1 to 2 0xC (12)	2	4012	float RWES
Ain	<i>Analog Input (1 to 2)</i> Analog Input Value * View the process value. Note: Ensure that the Error Status (below) indicates no error (61) when reading this value using a field bus protocol. If an error exists, the last known value prior to the error occurring will be returned.	-1,999.000 to 9,999.000 °F or units -1,128.000 to 5,537.000 °C	- - - -	<i>Instance 1</i> Map 1 Map 2 360 360 <i>Instance 2</i> Map 1 Map 2 440 450	0x68 (104) 1 to 2 1	0	4001	float R
i.Er	<i>Analog Input (1 to 2)</i> Input Error * View the cause of the most recent error.	nonE None (61) OPEn Open (65) Shrt Shorted (127) EPn Measurement Error (140) E.CAL Bad Calibration Data (139) Er.Ab Ambient Error (9) Er.td RTD Error (141) FR.L Fail (32)	- - - -	<i>Instance 1</i> Map 1 Map 2 362 442 <i>Instance 2</i> Map 1 Map 2 362 452	0x68 (104) 1 to 2 2	1	4002	uint R
<p>db i SET Digital Bus Menu (J1939 CAN)</p>								
d.bi	<i>Digital Bus (1 to 6)</i> J1939 Instance Select the desired instance.	1 to 6	- - - -	- - - -	- - - -	- - - -	- - - -	float RW
<p>* These parameters/prompts are available in these menus with firmware revisions 11.0 and above. ** R: Read, W: Write, E: EEPROM, S: User Set</p>								

Setup Page								
Display	Parameter Name Description	Range	Default	Modbus Relative Address	CIP - Class Instance Attribute hex (dec)	Pro-fibus Index	Parameter ID	Data Type and Access **
<i>Unit</i> Unit	<i>Digital Bus (1 to 6)</i> Units Set the type of units the sensor will measure.	<i>AE P</i> Absolute Temperature (1540) <i>r.e P</i> Relative Temperature (1541) <i>P L U r</i> Power (73) <i>P r o</i> Process (75) <i>r h</i> Relative Humidity (1538) <i>n o n E</i> None (61)	Absolute Temperature	----	----	----	95005	uint RWE
<i>C I d h</i> C.Idh	<i>Digital Bus (1 to 4)</i> CAN ID High Word	0 to 65,535	0	----	----	----	94023	uint RW
<i>C I d L</i> C.IdL	<i>Digital Bus (1 to 4)</i> CAN ID Low Word	0 to 65,535	0	----	----	----	94022	uint RW
<i>E E P</i> E.tp	<i>Digital Bus (1 to 6)</i> Encoding Type	<i>S L E</i> State (2008) <i>S L E</i> Slots (2009)	Slots	----	----	----	94005	uint RWE
<i>b y t E</i> bytE	<i>Digital Bus (1 to 4)</i> Start Byte	1 to 8	1.0	----	----	----	94006	unsigned byte RWE
<i>b i t</i> bit	<i>Digital Bus (1 to 4)</i> Start Bit	1 to 8	1.0	----	----	----	94007	unsigned byte RWE
<i>L E n</i> LEn	<i>Digital Bus (1 to 4)</i> Signal Length in Bits	1 to 63	1.0	----	----	----	94008	unsigned byte RWE
<i>S n M</i> S.nM	<i>Digital Bus (1 to 4)</i> Scaling Numerator	1 to 65,535	For instance (1 to 3 and 6) = 128, Instance (4 and 5) = 1	----	----	----	----	uint RWE
* These parameters/prompts are available in these menus with firmware revisions 11.0 and above. ** R: Read, W: Write, E: EEPROM, S: User Set								

Setup Page

Display	Parameter Name Description	Range	Default	Modbus Relative Address	CIP - Class Instance Attribute hex (dec)	Pro-fibus Index	Parameter ID	Data Type and Access **
S.dEn S.dEn	Digital Bus (1 to 4) Scaling Denominator	1 to 65,535	For instance (1 to 3 and 6) = 4096, Instance (4 and 5) = 1	----	----	----	----	uint RWE
OFSt OFSt	Digital Bus (1 to 4) Offset	-1,999.000 to 9,999.000	1.0	----	----	----	93010	float RWES
FiL FiL	Digital Bus (1 to 4) Filter	-1,999.000 to 9,999.000	1.0	----	----	----	93011	float RWE
CAn.u CAn.u	Digital Bus (1 to 6) CAN Units	F °F (30) C °C (15) nonE None (61)	For instance 5 = None, instance 1 to 4 and 6 = C	----	----	----	93021	float RWES

* These parameters/prompts are available in these menus with firmware revisions 11.0 and above.

** R: Read, W: Write, E: EEPROM, S: User Set

Setup Page

Display	Parameter Name Description	Range	Default	Modbus Relative Address	CIP - Class Instance Attribute hex (dec)	Pro-fibus Index	Parameter ID	Data Type and Access **
Fn Fn	Digital Bus (5) Action Function Program the digital device to trigger an action. Functions respond to a level state change or an edge level change.	none None (61) usr User Set Restore, edge triggered (227) PLoK Keypad Lock-out, level triggered (217) ALr Alarm Reset, edge triggered (6) Sil Silence Alarms, edge triggered (108) RoF Control Loops Off and Alarms to Non-alarm State, level triggered (220) FAL Force Alarm to occur, level triggered (218) idLE Idle Set Point, level triggered (107) tUNE Tune, edge triggered (98) MAN Manual, level triggered (54) oFF Switch Control Loop Off, level triggered (90) t.dR TRU-TUNE+® Disable, level triggered (219) P.d iS Profile Disable, level triggered (206) P.hoL Profile Hold/Resume, level triggered (207) Pr oF Start Profile, edge triggered (196) P.S tS Profile Start/Stop, level triggered (208) S.S tP Start Step (1077) r.En Remote Set Point (216)	None	----	----	----	10003	uint RWES

* These parameters/prompts are available in these menus with firmware revisions 11.0 and above.

** R: Read, W: Write, E: EEPROM, S: User Set

Setup Page

Display	Parameter Name Description	Range	Default	Modbus Relative Address	CIP - Class Instance Attribute hex (dec)	Pro-fibus Index	Parameter ID	Data Type and Access **
<p><i>Lnr</i> <i>SET</i> Linearization Menu</p>								
<i>F_n</i> Fn	<p>Linearization (1 to 2) Function Set how this function will linearize Source A.</p>	<p><i>oFF</i> Off (62) <i>intE</i> Interpolated (1482)</p>	Off	<p><i>Instance 1</i> Map 1 Map 2 - - - - 3568 <i>Instance 2</i> Map 1 Map 2 - - - - 3638</p>	0x86 (134) 1 to 2 5	155	34005	uint RWES
<i>SFnA</i> SFn.A	<p>Linearization (1 to 2) Source Function A Set the source for the Linearization function. Note: Instance 2 applies if the 8th digit of the part number = 7 and digit 9 is C, J, R or P.</p>	<p><i>A</i> , Analog Input (142) <i>db</i> , Digital Bus Input (1993)</p>		<p><i>Instance 1</i> Map 1 Map 2 - - - - 3560 <i>Instance 2</i> Map 1 Map 2 - - - - 3630</p>	0x86 (134) 1 to 2 1	- - - -	34001	uint RWES
<i>SiA</i> Si.A	<p>Linearization (1 to 2) Source Instance A Set the instance of the function selected above. Note: Instance 2 applies if the 8th digit of the part number = 7 and digit 9 is C, J, R or P.</p>	1 to 8		<p><i>Instance 1</i> Map 1 Map 2 - - - - 3562 <i>Instance 2</i> Map 1 Map 2 - - - - 3632</p>	0x86 (134) 1 to 2 2	- - - -	34002	un- signed 8-bits RWES
<i>Unit</i> Unit	<p>Linearization (1 to 2) Units Set the units of the output value.</p>	<p><i>Src</i> Source (1539) <i>nonE</i> None (61) <i>A_{TP}</i> Absolute Temperature (1540) <i>r_{TP}</i> Relative Temperature (1541) <i>Pwr</i> Power (73) <i>Pro</i> Process (75) <i>rh</i> Relative Humidity (1538)</p>	Source	<p><i>Instance 1</i> Map 1 Map 2 - - - - 3616 <i>Instance 2</i> Map 1 Map 2 - - - - 3686</p>	0x86 (134) 1 to 2 0x1D (29)	156	34029	uint RWES
<p>* These parameters/prompts are available in these menus with firmware revisions 11.0 and above. ** R: Read, W: Write, E: EEPROM, S: User Set</p>								

Setup Page								
Display	Parameter Name Description	Range	Default	Modbus Relative Address	CIP - Class Instance Attribute hex (dec)	Pro-fibus Index	Parameter ID	Data Type and Access **
IP.1 ip.1	<i>Linearization (1 to 2)</i> Input Point 1 Set the value that will be mapped to output 1.	-1,999.000 to 9,999.000	0.0	<i>Instance 1</i> Map 1 Map 2 - - - - 3574 <i>Instance 2</i> Map 1 Map 2 - - - - 3644	0x86 (134) 1 to 2 8	157	34008	float RWES
OP.1 op.1	<i>Linearization (1 to 2)</i> Output Point 1 Set the value that will be mapped to input 1.	-1,999.000 to 9,999.000	0.0	<i>Instance 1</i> Map 1 Map 2 - - - - 3594 <i>Instance 2</i> Map 1 Map 2 - - - - 3664	0x86 (134) 1 to 2 0x12 (18)	158	34018	float RWES
IP.2 ip.2	<i>Linearization (1 to 2)</i> Input Point 2 Set the value that will be mapped to output 2.	-1,999.000 to 9,999.000	1.0	<i>Instance 1</i> Map 1 Map 2 - - - - 3576 <i>Instance 2</i> Map 1 Map 2 - - - - 3646	0x86 (134) 1 to 2 9	159	34009	float RWES
OP.2 op.2	<i>Linearization (1 to 2)</i> Output Point 2 Set the value that will be mapped to input 2.	-1,999.000 to 9,999.000	1.0	<i>Instance 1</i> Map 1 Map 2 - - - - 3596 <i>Instance 2</i> Map 1 Map 2 - - - - 3666	0x86 (134) 1 to 2 0x13 (19)	160	34019	float RWES
IP.3 ip.3	<i>Linearization (1 to 2)</i> Input Point 3 Set the value that will be mapped to output 3.	-1,999.000 to 9,999.000	2.0	<i>Instance 1</i> Map 1 Map 2 - - - - 3578 <i>Instance 2</i> Map 1 Map 2 - - - - 3648	0x86 (134) 1 to 2 0xA (10)	161	34010	float RWES
OP.3 op.3	<i>Linearization (1 to 2)</i> Output Point 3 Set the value that will be mapped to input 3.	-1,999.000 to 9,999.000	2.0	<i>Instance 1</i> Map 1 Map 2 - - - - 3598 <i>Instance 2</i> Map 1 Map 2 - - - - 3668	0x86 (134) 1 to 2 0x14 (20)	162	34020	float RWES
IP.4 ip.4	<i>Linearization (1 to 2)</i> Input Point 4 Set the value that will be mapped to output 4.	-1,999.000 to 9,999.000	3.0	<i>Instance 1</i> Map 1 Map 2 - - - - 3580 <i>Instance 2</i> Map 1 Map 2 - - - - 3651	0x86 (134) 1 to 2 0xB (11)	163	34011	float RWES

* These parameters/prompts are available in these menus with firmware revisions 11.0 and above.

** R: Read, W: Write, E: EEPROM, S: User Set

Setup Page

Display	Parameter Name Description	Range	Default	Modbus Relative Address	CIP - Class Instance Attribute hex (dec)	Pro-fibus Index	Parameter ID	Data Type and Access **
oP.4 op.4	Linearization (1 to 2) Output Point 4 Set the value that will be mapped to input 4.	-1,999.000 to 9,999.000	3.0	Instance 1 Map 1 Map 2 - - - - 3600 Instance 2 Map 1 Map 2 - - - - 3670	0x86 (134) 1 to 2 0x15 (21)	164	34021	float RWES
iP.5 ip.5	Linearization (1 to 2) Input Point 5 Set the value that will be mapped to output 5.	-1,999.000 to 9,999.000	4.0	Instance 1 Map 1 Map 2 - - - - 3582 Instance 2 Map 1 Map 2 - - - - 3652	0x86 (134) 1 to 2 0xC (12)	165	34012	float RWES
oP.5 op.5	Linearization (1 to 2) Output Point 5 Set the value that will be mapped to input 5.	-1,999.000 to 9,999.000	4.0	Instance 1 Map 1 Map 2 - - - - 3602 Instance 2 Map 1 Map 2 - - - - 3672	0x86 (134) 1 to 2 0x16 (22)	166	34022	float RWES
iP.6 ip.6	Linearization (1 to 2) Input Point 6 Set the value that will be mapped to output 6.	-1,999.000 to 9,999.000	5.0	Instance 1 Map 1 Map 2 - - - - 3584 Instance 2 Map 1 Map 2 - - - - 3654	0x86 (134) 1 to 2 0xD (13)	167	34013	float RWES
oP.6 op.6	Linearization (1 to 2) Output Point 6 Set the value that will be mapped to input 6.	-1,999.000 to 9,999.000	5.0	Instance 1 Map 1 Map 2 - - - - 3604 Instance 2 Map 1 Map 2 - - - - 3674	0x86 (134) 1 to 2 0x17 (23)	168	34023	float RWES
iP.7 ip.7	Linearization (1 to 2) Input Point 7 Set the value that will be mapped to output 7.	-1,999.000 to 9,999.000	6.0	Instance 1 Map 1 Map 2 - - - - 3586 Instance 2 Map 1 Map 2 - - - - 3656	0x86 (134) 1 to 2 E (14)	169	34014	float RWES
oP.7 op.7	Linearization (1 to 2) Output Point 7 Set the value that will be mapped to input 7.	-1,999.000 to 9,999.000	6.0	Instance 1 Map 1 Map 2 - - - - 3606 Instance 2 Map 1 Map 2 - - - - 3676	0x86 (134) 1 to 2 0x18 (24)	170	34024	float RWES

* These parameters/prompts are available in these menus with firmware revisions 11.0 and above.

** R: Read, W: Write, E: EEPROM, S: User Set

** These prompts are only available in this menu with firmware revision 11.0 and above.

Setup Page								
Display	Parameter Name Description	Range	Default	Modbus Relative Address	CIP - Class Instance Attribute hex (dec)	Pro-fibus Index	Parameter ID	Data Type and Access **
.P.8 ip.8	<i>Linearization (1 to 2)</i> Input Point 8 Set the value that will be mapped to output 8.	-1,999.000 to 9,999.000	7.0	<i>Instance 1</i> Map 1 Map 2 - - - - 3588 <i>Instance 2</i> Map 1 Map 2 - - - - 3658	0x86 (134) 1 to 2 0xF (15)	171	34015	float RWES
o.P.8 op.8	<i>Linearization (1 to 2)</i> Output Point 8 Set the value that will be mapped to input 8.	-1,999.000 to 9,999.000	7.0	<i>Instance 1</i> Map 1 Map 2 - - - - 3608 <i>Instance 2</i> Map 1 Map 2 - - - - 3678	0x86 (134) 1 to 2 0x19 (25)	172	34025	float RWES
.P.9 ip.9	<i>Linearization (1 to 2)</i> Input Point 9 Set the value that will be mapped to output 9.	-1,999.000 to 9,999.000	8.0	<i>Instance 1</i> Map 1 Map 2 - - - - 3590 <i>Instance 2</i> Map 1 Map 2 - - - - 3660	0x86 (134) 1 to 2 0x10 (16)	173	34016	float RWES
o.P.9 op.9	<i>Linearization (1 to 2)</i> Output Point 9 Set the value that will be mapped to input 9.	-1,999.000 to 9,999.000	8.0	<i>Instance 1</i> Map 1 Map 2 - - - - 3610 <i>Instance 2</i> Map 1 Map 2 - - - - 3680	0x86 (134) 1 to 2 0x1A (26)	174	34026	float RWES
.P.10 ip.10	<i>Linearization (1 to 2)</i> Input Point 10 Set the value that will be mapped to output 10.	-1,999.000 to 9,999.000	9.0	<i>Instance 1</i> Map 1 Map 2 - - - - 3592 <i>Instance 2</i> Map 1 Map 2 - - - - 3662	0x86 (134) 1 to 2 0x11 (17)	175	34017	float RWES
o.P.10 op.10	<i>Linearization (1 to 2)</i> Output Point 10 Set the value that will be mapped to input 10.	-1,999.000 to 9,999.000	9.0	<i>Instance 1</i> Map 1 Map 2 - - - - 3612 <i>Instance 2</i> Map 1 Map 2 - - - - 3682	0x86 (134) 1 to 2 0x1B (27)	176	34027	float RWES

* These parameters/prompts are available in these menus with firmware revisions 11.0 and above.

** R: Read, W: Write, E: EEPROM, S: User Set

Setup Page

Display	Parameter Name Description	Range	Default	Modbus Relative Address	CIP - Class Instance Attribute hex (dec)	Pro-fibus Index	Parameter ID	Data Type and Access **
<p>Process Value Menu</p>								
Fn Fn	<p>Process Value (1 to 2) Function Set the function that will be applied to the source or sources.</p> <p>Note: Differential and Ratio not available using instance 2.</p>	<p>OFF Off (62) ALT Pressure to Altitude (1649)*** ROOT Square Root (1380) DIFF Differential (1373) RATIO Ratio (1374) WBD Wet Bulb Dry Bulb (1369) VSLA Vaisala (1648) SBR Sensor Backup (1201)</p>	Off	<p>Instance 1 Map 1 Map 2 - - - - 3320</p> <p>Instance 2 Map 1 Map 2 - - - - 3390</p>	0x7E (126) 1 to 2 0x15 (21)	123	26021	uint RWES
P.unt P.unt	<p>Process Value (1 to 2) Pressure Units*** If Process Value function is set for Pressure to Altitude units, define units of measure for conversion.</p>	<p>PSI Pounds per Square Inch (1671) PASC Pascal (1674) ATM Atmosphere (1675) MILL Millibar (1672) TORR Torr (1673)</p>	PSI	<p>Instance 1 Map 1 Map 2 - - - - 3334</p> <p>Instance 2 Map 1 Map 2 - - - - 3404</p>	0x7E (126) 1 to 2 0x1C (28)	- - - -	26028	uint RWES
A.unt A.unt	<p>Process Value (1 to 2) Altitude Units*** If Process Value function is set for Pressure to Altitude units, define units of measure for conversion.</p>	<p>KFT Kilofeet (1677) FEET Feet (1676)</p>	Hft	<p>Instance 1 Map 1 Map 2 - - - - 3336</p> <p>Instance 2 Map 1 Map 2 - - - - 3406</p>	0x7E (126) 1 to 2 0x1D (29)	- - - -	26029	uint RWES
<p>*** Pressure Altitude calculation is based on the International Standard Atmosphere 1976</p>								
<p>* These parameters/prompts are available in these menus with firmware revisions 11.0 and above. ** R: Read, W: Write, E: EEPROM, S: User Set</p>								

Setup Page

Display	Parameter Name Description	Range	Default	Modbus Relative Address	CIP - Class Instance Attribute hex (dec)	Pro-fibus Index	Parameter ID	Data Type and Access **
b.Pr b.Pr	Process Value (1 to 2) Barometric Pressure*** If Process Value function is set for Wet Bulb / Dry Bulb, define pressure value used for humidity calculation.	10.0 to 16.0	14.7	Instance 1 Map 1 Map 2 - - - - 3338 Instance 2 Map 1 Map 2 - - - - 3408	0x7E (126) 1 to 2 0x1E (30)	- - - -	26030	float RWES
F iL FiL	Process Value (1 to 2) Filter Filtering smooths out the output signal of this function block. Increase the time to increase filtering.	0.0 to 60.0 seconds	0.0	Instance 1 Map 1 Map 2 - - - - 3330 Instance 2 Map 1 Map 2 - - - - 3400	0x7E (126) 1 to 2 0x1A (26)	- - - -	26026	float RWES

*** Pressure Altitude calculation is based on the International Standard Atmosphere 1976

d io
SEt

Digital Input/Output Menu

d ir dir	Digital Input/Output (5 to 12) Direction Set this function to operate as an input or output. Note: Modbus Map 1 has instances 5 through 8 only	oE Pt Output (68) in Input Voltage (193) iE on Input Dry Contact (44)	Output	Instance 5 Map 1 Map 2 1000 1120 Offset to next instance (Map 1 & Map 2) equals +30	0x6A (106) 5 to 12 1	82	6001	uint RWES
-------------	---	---	--------	--	-------------------------------	----	------	--------------

* These parameters/prompts are available in these menus with firmware revisions 11.0 and above.

** R: Read, W: Write, E: EEPROM, S: User Set

Setup Page								
Display	Parameter Name Description	Range	Default	Modbus Relative Address	CIP - Class Instance Attribute hex (dec)	Pro-fibus Index	Parameter ID	Data Type and Access **
Fn Fn	<i>Digital Output (5 to 12)</i> Function Select what function will drive this output. Note: Modbus Map 1 has instances 5 through 8 only	oFF Off (62) ALPn Alarm (6) HEAT Heat (36) COOL Cool (20) Sof.1 Special Function Output 1 (1532) Sof.2 Special Function Output 2 (1533) TEo1 Timer Event Output 1 (1951) TEo2 Timer Event Output 2 (1952) TEo3 Timer Event Output 3 (1953) Ent.A Profile Event Out A (233) Ent.B Profile Event Out B (234) HEr Heater Error (184)	Off	<i>Instance 5</i> Map 1 Map 2 1008 1128 Offset to next instance (Map 1 & Map 2) equals +30	0x 6A (106) 5 to 12 5	83	6005	uint RWES
Fi Fi	<i>Digital Output (5 to 12)</i> Output Function Instance Set the instance of the function selected above. Note: Modbus Map 1 has instances 5 through 8 only	1 to 4	1	<i>Instance 5</i> Map 1 Map 2 1010 1130 Offset to next instance (Map 1 & Map 2) equals +30	0x6A (106) 5 to 12 6	84	6006	uint RWES
o.Ct o.Ct	<i>Digital Output (5 to 12)</i> Time Base Type Set the time base type. This parameter is only used with PID control, but can be set any-time. Note: Modbus Map 1 has instances 5 through 8 only	FTb Fixed Time Base (34) VTb Variable Time Base (103)	Fixed Time Base	<i>Instance 5</i> Map 1 Map 2 1002 1122 Offset to next instance (Map 1 & Map 2) equals +30	0x6A (106) 5 to 12 2	85	6002	uint RWES
<p>* These parameters/prompts are available in these menus with firmware revisions 11.0 and above. ** R: Read, W: Write, E: EEPROM, S: User Set</p>								

Setup Page

Display	Parameter Name Description	Range	Default	Modbus Relative Address	CIP - Class Instance Attribute hex (dec)	Pro-fibus Index	Parameter ID	Data Type and Access **
o.tb o.tb	<i>Digital Output (5 to 12)</i> Fixed Time Base Set the time base for fixed-time-base control. Note: Modbus Map 1 has instances 5 through 8 only	0.1 to 60.0 seconds	1.0	<i>Instance 5</i> Map 1 Map 2 1004 1124 Offset to next instance (Map 1 & Map 2) equals +30	0x6A (106) 5 to 12 3	86	6003	float RWES
o.Lo o.Lo	<i>Digital Output (5 to 12)</i> Low Power Scale The power output will never be less than the value specified and will represent the value at which output scaling begins.	0.0 to 100.0%	0.0	<i>Instance 5</i> Map 1 Map 2 1016 1136 Offset to next instance (Map 1 & Map 2) equals +30	0x6A (106) 5 to 12 9	87	6009	float RWES
o.hi o.hi	<i>Digital Output (5 to 12)</i> High Power Scale The power output will never be greater than the value specified and will represent the value at which output scaling stops.	0.0 to 100.0%	100.0	<i>Instance 5</i> Map 1 Map 2 1018 1138 Offset to next instance (Map 1 & Map 2) equals +30	0x6A (106) 5 to 12 A (10)	88	6010	float RWES
LEv LEv	<i>Digital Input (5 to 6)</i> Active Level Select which action will be interpreted as a true state.	High (37) Low (53)	High	<i>Instance 5</i> Map 1 Map 2 1320 1560 Offset to next instance (Map 1 & Map 2) equals +20	0x6E (110) 5 to 6 1	137	10001	uint RW

* These parameters/prompts are available in these menus with firmware revisions 11.0 and above.

** R: Read, W: Write, E: EEPROM, S: User Set

Setup Page

Display	Parameter Name Description	Range	Default	Modbus Relative Address	CIP - Class Instance Attribute hex (dec)	Pro-fibus Index	Parameter ID	Data Type and Access **
LEU LEv	Digital Input (7 to 12) Active Level Select which action will be interpreted as a true state. Note: Modbus Map 1 has instances 7 and 8 only	h.9h High (37) L.0LJ Low (53)	High	Instance 7 Map 1 Map 2 1400 1640 Offset to next instance Map 2 equals +20	0x6E (110) 7 to C (12) 1	137	10001	uint RW
<p>* These parameters/prompts are available in these menus with firmware revisions 11.0 and above. ** R: Read, W: Write, E: EEPROM, S: User Set</p>								

Setup Page

Display	Parameter Name Description	Range	Default	Modbus Relative Address	CIP - Class Instance Attribute hex (dec)	Pro-fibus Index	Parameter ID	Data Type and Access **
<i>Fn</i> Fn	<i>Digital Input (5 to 6)</i> Action Function Select the function that will be triggered by a true state for Digital Inputs 5 to 6.	<i>nONE</i> None (61) <i>START</i> Start Step (1077) <i>START</i> Profile Start/ Stop, level triggered (208) <i>PROF</i> Start Profile, edge triggered (196) <i>PHOLD</i> Profile Hold/ Resume, level triggered (207) <i>PROF DIS</i> Profile Disable, level triggered (206) <i>TRU-TUNE+®</i> Disable, level triggered (219) <i>SWITCH</i> Control Loop Off, level triggered (90) <i>MANUAL</i> Manual, level triggered (54) <i>TUNE</i> Tune, edge triggered (98) <i>IDLE</i> Idle Set Point, level triggered (107) <i>FORCE</i> Force Alarm to occur, level triggered (218) <i>CONTROL</i> Control Loops Off and Alarms to Non-alarm State, level triggered (220) <i>SILENCE</i> Silence Alarms, edge triggered (108) <i>ALARM</i> Alarm Reset, edge triggered (6) <i>KEYPAD</i> Keypad Lock-out, level triggered (217) <i>USER</i> User Set Restore, edge triggered (227) <i>REMOTE</i> Remote Set Point (216)	None	<i>Instance 5</i> Map 1 Map 2 1324 1564 Offset to next instance (Map 1 & Map 2) equals +20	0x6E (110) 5 to 6 3	138	10003	uint RWES

* These parameters/prompts are available in these menus with firmware revisions 11.0 and above.

** R: Read, W: Write, E: EEPROM, S: User Set

Setup Page

Display	Parameter Name Description	Range	Default	Modbus Relative Address	CIP - Class Instance Attribute hex (dec)	Pro-fibus Index	Parameter ID	Data Type and Access **
<i>Fn</i> Fn	<p><i>Digital Input (7 to 12)</i> Action Function Select the function that will be triggered by a true state for Digital Inputs 7 through 12.</p> <p>Note: Modbus Map 1 has instances 7 through 10 only</p>	<p><i>none</i> None (61) <i>Start Step</i> (1077) <i>Profile Start/ Stop</i>, level triggered (208) <i>Start Profile</i>, edge triggered (196) <i>Profile Hold/ Resume</i>, level triggered (207) <i>Profile Disable</i>, level triggered (206) <i>TRU-TUNE+® Disable</i>, level triggered (219) <i>Switch Control Loop Off</i>, level triggered (90) <i>Manual</i>, level triggered (54) <i>Tune</i>, edge triggered (98) <i>Idle Set Point</i>, level triggered (107) <i>Force Alarm to occur</i>, level triggered (218) <i>Control Loops Off and Alarms to Non-alarm State</i>, level triggered (220) <i>Silence Alarms</i>, edge triggered (108) <i>Alarm Reset</i>, edge triggered (6) <i>Keypad Lock-out</i>, level triggered (217) <i>User Set Restore</i>, edge triggered (227) <i>Remote Set Point</i> (216)</p>	None	<p><i>Instance 7</i> Map 1 Map 2 1404 1644</p> <p>Offset to next instance (Map 1 & Map 2) equals +20</p>	0x6E (110) 7 to C (12) 3	138	10003	uint RWES

* These parameters/prompts are available in these menus with firmware revisions 11.0 and above.

** R: Read, W: Write, E: EEPROM, S: User Set

Setup Page								
Display	Parameter Name Description	Range	Default	Modbus Relative Address	CIP - Class Instance Attribute hex (dec)	Pro-fibus Index	Parameter ID	Data Type and Access **
F , Fi	<i>Digital Input (5 to 6)</i> Function Instance Select which Digital Input will be triggered by a true state.	0 to 40	0	<i>Instance 5</i> Map 1 Map 2 1326 1566 Offset to next instance (Map 1 & Map 2) equals +20	0x6E (110) 5 to 6 4	139	10004	uint RWES
F , Fi	<i>Digital Input (7 to 12)</i> Function Instance Select which Digital Input will be triggered by a true state. Note: Modbus Map 1 has instances 7 through 10 only	0 to 40	0	<i>Instance 7</i> Map 1 Map 2 1406 1646 Offset to next instance (Map 1 & Map 2) equals +20	0x6E (110) 7 to C (12) 4	139	10004	uint RWES

L ,P7
SET

Limit Menu

L.Sd L.Sd	<i>Limit (1)</i> Sides Select which side or sides of the process value will be monitored.	both Both (13) h ,9h High (37) Low Low (53)	Both	<i>Instance 1</i> Map 1 Map 2 688 728	0x70 (112) 1 5	40	12005	uint RWES
L.hy L.hy	<i>Limit (1)</i> Hysteresis Set the hysteresis for the limit function. This determines how far into the safe range the process value must move before the limit can be cleared.	0.001 to 9,999.000 °F or units 0.001 to 5,555.000 °C	3.0 °F or units 2.0 °C	<i>Instance 1</i> Map 1 Map 2 682 722	0x70 (112) 1 2	41	12002	float RWES
SPLh SP.Lh	<i>Limit (1)</i> Maximum Set Point Set the high end of the limit set point range.	-1,999.000 to 9,999.000	9,999.000	<i>Instance 1</i> Map 1 Map 2 696 736	0x70 (112) 1 9	42	12009	float RWES

* These parameters/prompts are available in these menus with firmware revisions 11.0 and above.

** R: Read, W: Write, E: EEPROM, S: User Set

Setup Page

Display	Parameter Name Description	Range	Default	Modbus Relative Address	CIP - Class Instance Attribute hex (dec)	Pro-fibus Index	Parameter ID	Data Type and Access **
SPLL SP.LL	<i>Limit (1)</i> Minimum Set Point Set the low end of the limit set point range.	-1,999.000 to 9,999.000	-1,999.000	<i>Instance 1</i> Map 1 Map 2 698 738	0x70 (112) 1 0xA (10)	43	12010	float RWES
LhS Lh.S	<i>Limit (1)</i> High Limit Set Point * Set the high process value that will trigger the limit.	-1,999.000 to 9,999.000°F or units -1,128.000 to 5,537.000°C	0.0°F or units -18.0°C	<i>Instance 1</i> Map 1 Map 2 686 726	0x70 (112) 1 4	39	12004	float RWES
LLS LL.S	<i>Limit (1)</i> Low Limit Set Point * Set the low process value that will trigger the limit.	-1,999.000 to 9,999.000°F or units -1,128.000 to 5,537.000°C	0.0°F or units -18.0°C	<i>Instance 1</i> Map 1 Map 2 684 724	0x70 (112) 1 3	38	12003	float RWES
SFnA SFn.A	<i>Limit (1)</i> Source Function A * Set the source for the limit reset function.	<i>nonE</i> None (61) <i>diO</i> Digital I/O (1142) <i>FUn</i> Function Key (1001)	None	<i>Instance 1</i> Map 1 Map 2 - - - - 748	0x70 (112) 1 0x0F (15)	- - - -	12015	uint RWES
SiA Si.A	<i>Limit (1)</i> Source Instance A * Set the instance of the function selected above.	1 to 12	1	- - - -	0x70 (112) 1 0x10 (16)	- - - -	12016	uint RWES
LCr LCr	<i>Limit (1)</i> Clear Limit * Clear limit once limit condition is safe.	<i>CLr</i> Clear (0) <i>Ignr</i> Ignore (204)	- - - -	<i>Instance 1</i> Map 1 Map 2 680 720	0x70 (112) 1 1	- - - -	12014	uint W
LSt L.St	<i>Limit (1)</i> Limit Status * Reflects whether or not the limit is in a safe or failed mode.	<i>FAiL</i> Fail (32) <i>SAFE</i> Safe (1667)	- - - -	<i>Instance 1</i> Map 1 Map 2 - - - - 744	0x70 (112) 1 0x0D (13)	- - - -	12013	uint R

* These parameters/prompts are available in these menus with firmware revisions 11.0 and above.

** R: Read, W: Write, E: EEPROM, S: User Set

Setup Page								
Display	Parameter Name Description	Range	Default	Modbus Relative Address	CIP - Class Instance Attribute hex (dec)	Pro-fibus Index	Parameter ID	Data Type and Access **
L.it L.it	<i>Limit (1)</i> Integrate with System In a limit state the controller will turn off the outputs, terminate an active profile and freeze PID and TRU-TUNE+® calculations.	no No (59) YES Yes (106)	No	<i>Instance 1</i> Map 1 Map 2 694 734	0x70 (112) 1 8	- - - -	12008	uint RWES
No Display	<i>Limit (1)</i> Limit State Clear limit once limit condition is cleared.	oFF Off (62) nonE None (61) L.h Limit High (51) L.l Limit Low (52) Err Error (28)	- - - -	<i>Instance 1</i> Map 1 Map 2 690 730	0x70 (112) 1 6	- - - -	12006	uint R
Loop Set Control Loop Menu								
h.Ag h.Ag	<i>Control Loop (1 to 2)</i> Heat Algorithm Set the heat control method.	oFF Off (62) P.id PID (71) o.n.o.F On-Off (64)	PID	<i>Instance 1</i> Map 1 Map 2 1884 2364 <i>Instance 2</i> Map 1 Map 2 1954 2434	0x97 (151) 1 to 2 3	72	8003	uint RWES
C.Ag C.Ag	<i>Control Loop (1 to 2)</i> Cool Algorithm Set the cool control method.	oFF Off (62) P.id PID (71) o.n.o.F On-Off (64)	Off	<i>Instance 1</i> Map 1 Map 2 1886 2366 <i>Instance 2</i> Map 1 Map 2 1956 2436	0x97 (151) 1 to 2 4	73	8004	uint RWES
C.Cr C.Cr	<i>Control Loop (1 to 2)</i> Cool Output Curve Select a cool output curve to change the responsiveness of the system.	oFF Off (62) C.r.A Non-linear Curve 1 (214) C.r.b Non-linear Curve 2 (215)	Off	<i>Instance 1</i> Map 1 Map 2 1888 2368 <i>Instance 2</i> Map 1 Map 2 1958 2438	0x97 (151) 1 to 2 5	- - - -	8038	uint RWES
* These parameters/prompts are available in these menus with firmware revisions 11.0 and above. ** R: Read, W: Write, E: EEPROM, S: User Set								

Setup Page								
Display	Parameter Name Description	Range	Default	Modbus Relative Address	CIP - Class Instance Attribute hex (dec)	Pro-fibus Index	Parameter ID	Data Type and Access **
h.Pb h.Pb	<i>Control Loop (1 to 2)</i> Heat Proportional Band * Set the PID proportional band for the heat outputs.	0.001 to 9,999.000 °F or units 0.001 to 5,555.000 °C	25.0 °F or units 14.0 °C	<i>Instance 1</i> Map 1 Map 2 1890 2370 <i>Instance 2</i> Map 1 Map 2 1960 2440	0x97 (151) 1 to 2 6	65	8009	float RWES
h.hy h.hy	<i>Control Loop (1 to 2)</i> On / Off Heat Hysteresis * Set the control switching hysteresis for on-off control. This determines how far into the "on" region the process value needs to move before the output turns on.	0.001 to 9,999.000 °F or units 0.001 to 5,555.000 °C	3.0 °F or units 2.0 °C	<i>Instance 1</i> Map 1 Map 2 1900 2380 <i>Instance 2</i> Map 1 Map 2 1970 2450	0x97 (151) 1 to 2 0xB (11)	66	8010	float RWES
C.Pb C.Pb	<i>Control Loop (1 to 2)</i> Cool Proportional Band * Set the PID proportional band for the cool outputs.	0.001 to 9,999.000 °F or units 0.001 to 5,555.000 °C	25.0 °F or units 14.0 °C	<i>Instance 1</i> Map 1 Map 2 1892 2372 <i>Instance 2</i> Map 1 Map 2 1962 2442	0x97 (151) 1 to 2 7	67	8012	float RWES
C.hy C.hy	<i>Control Loop (1 to 2)</i> On/Off Cool Hysteresis * Set the control switching hysteresis for on-off control. This determines how far into the "on" region the process value needs to move before the output turns on.	0.001 to 9,999.000 °F or units 0.001 to 5,555.000 °C	3.0 °F or units 2.0 °C	<i>Instance 1</i> Map 1 Map 2 1902 2382 <i>Instance 2</i> Map 1 Map 2 1972 2522	0x97 (151) 1 to 2 0xC (12)	68	8013	float RWES
* These parameters/prompts are available in these menus with firmware revisions 11.0 and above. ** R: Read, W: Write, E: EEPROM, S: User Set								

Setup Page

Display	Parameter Name Description	Range	Default	Modbus Relative Address	CIP - Class Instance Attribute hex (dec)	Pro-fibus Index	Parameter ID	Data Type and Access **
ti	<i>Control Loop (1 to 2)</i> Time Integral * Set the PID integral for the outputs.	0 to 9,999 seconds per repeat	180 seconds per repeat	<i>Instance 1</i> Map 1 Map 2 1894 2374 <i>Instance 2</i> Map 1 Map 2 1964 2444	0x97 (151) 1 to 2 8	69	8006	float RWES
td	<i>Control Loop (1 to 2)</i> Time Derivative * Set the PID derivative time for the outputs.	0 to 9,999 seconds	0 seconds	<i>Instance 1</i> Map 1 Map 2 1896 2376 <i>Instance 2</i> Map 1 Map 2 1966 2446	0x97 (151) 1 to 2 9	70	8007	float RWES
db	<i>Control Loop (1 to 2)</i> Dead Band * Set the offset to the proportional band. With a negative value, both heating and cooling outputs are active when the process value is near the set point. A positive value keeps heating and cooling outputs from fighting each other.	-1,000.0 to 1,000.0°F or units -556 to 556°C	0.0	<i>Instance 1</i> Map 1 Map 2 1898 2378 <i>Instance 2</i> Map 1 Map 2 1968 2448	0x97 (151) 1 to 2 0xA (10)	71	8008	float RWES
t.tUn	<i>Control Loop (1 to 2)</i> TRU-TUNE+® Enable Enable or disable the TRU-TUNE+ adaptive tuning feature.	no No (59) YES Yes (106)	No	<i>Instance 1</i> Map 1 Map 2 1910 2390 <i>Instance 2</i> Map 1 Map 2 1980 2460	0x97 (151) 1 to 2 10 (16)	- - - -	8022	uint RWES

* These parameters/prompts are available in these menus with firmware revisions 11.0 and above.

** R: Read, W: Write, E: EEPROM, S: User Set

Setup Page								
Display	Parameter Name Description	Range	Default	Modbus Relative Address	CIP - Class Instance Attribute hex (dec)	Pro-fibus Index	Parameter ID	Data Type and Access **
t.bnd t.bnd	Control Loop (1 to 2) TRU-TUNE+ Band Set the range, centered on the set point, within which TRU-TUNE+ will be in effect. Use this function only if the controller is unable to adaptive tune automatically.	0 to 100	0	Instance 1 Map 1 Map 2 1912 2392 Instance 2 Map 1 Map 2 1982 2462	0x97 (151) 1 to 2 0x11 (17)	- - - -	8034	uint RWES
t.gn t.gn	Control Loop (1 to 2) TRU-TUNE+ Gain Select the responsiveness of the TRU-TUNE+ adaptive tuning calculations. More responsiveness may increase overshoot.	1 to 6	3	Instance 1 Map 1 Map 2 1914 2394 Instance 2 Map 1 Map 2 1984 2464	0x97 (151) 1 to 2 0x12 (18)	- - - -	8035	uint RWES
AutSP A.tSP	Control Loop (1 to 2) Autotune Set Point * Set the set point that the autotune will use, as a percentage of the current set point.	50 to 200%	90.0	Instance 1 Map 1 Map 2 1918 2398 Instance 2 Map 1 Map 2 1988 2468	0x97 (151) 1 to 2 0x14 (20)	- - - -	8025	float RWES
t.Agr t.Agr	Control Loop (1 to 2) Autotune Aggressiveness Select the aggressiveness of the autotuning calculations.	Undr Under damped (99) Crit Critical damped (21) Over Over damped (69)	Critical	Instance 1 Map 1 Map 2 1916 2396 Instance 2 Map 1 Map 2 1986 2466	0x97 (151) 1 to 2 0x13 (19)	- - - -	8024	uint RWES
P.dL P.dL	Control Loop (1 to 2) Peltier Delay Set a value that will cause a delay when switching from heat PID mode to cool PID mode.	0.0 to 5.0 seconds	0.0	Instance 1 Map 1 Map 2 1934 2414 Instance 2 Map 1 Map 2 2004 2484	0x97 (151) 1 to 2 0x1C (28)	- - - -	8051	float RWES

* These parameters/prompts are available in these menus with firmware revisions 11.0 and above.

** R: Read, W: Write, E: EEPROM, S: User Set

Setup Page								
Display	Parameter Name Description	Range	Default	Modbus Relative Address	CIP - Class Instance Attribute hex (dec)	Pro-fibus Index	Parameter ID	Data Type and Access **
r.En r.En	<i>Control Loop (1)</i> Remote Set Point Set whether this loop will use a remote set point.	nO No (59) yE5 Yes (106)	No	<i>Instance 1</i> Map 1 Map 2 2200 2680	0x6B (107) 1 to 2 0x15 (21)	48	7021	uint RWES
r.ty r.ty	<i>Control Loop (1)</i> Remote Set Point Type Set what type of set point will be used.	AUto Auto (10) MAnual Manual (54)	Auto	<i>Instance 1</i> Map 1 Map 2 2202 2682	0x6B (107) 1 to 2 0x16 (22)	- - - -	7022	uint RWES
SFn.b SFn.b	<i>Control Loop (1)</i> Source Function B Set the source for the Remote Set Point. Note: Applies to models with the 8th digit of the part number = 7	nOnE None (61) db i Digital Bus Input (1993)		<i>Instance 1</i> Map 1 Map 2 2204 2684 <i>Instance 2</i> Map 1 Map 2 2284 2764	0x6B (107) 1 to 2 0x17 (23)	- - - -	7023	uint RWES
Si.b Si.b	<i>Control Loop (1)</i> Source Instance B Set the instance of the function selected above. Note: Applies to models with the 8th digit of the part number = 7	1 to 6		<i>Instance 1</i> Map 1 Map 2 2206 3562 <i>Instance 2</i> Map 1 Map 2 2286 3632	0x6B (107) 1 to 2 0x18 (24)	- - - -	7024	unsigned 8-bits RWES
* These parameters/prompts are available in these menus with firmware revisions 11.0 and above. ** R: Read, W: Write, E: EEPROM, S: User Set								

Setup Page

Display	Parameter Name Description	Range	Default	Modbus Relative Address	CIP - Class Instance Attribute hex (dec)	Pro-fibus Index	Parameter ID	Data Type and Access **
UFA UFA	Control Loop (1 to 2) Auto-to-Manual Power Select what the controller outputs will do when the user switches control to manual mode.	OFF Off, sets output power to 0% (62) BPLS Bumpless transfer, maintains same output power, if it was less than 75% and stable, otherwise 0% (14) FPA Fixed Power, sets output power to Fixed Power setting (54) USER User, sets output power to last open-loop set point the user entered (100)	User	Instance 1 Map 1 Map 2 2182 2662 Instance 2 Map 1 Map 2 2262 2742	0x6B (107) 1 to 2 0xC (12)	- - - -	7012	uint RWES
FAiL FAiL	Control Loop (1 to 2) Input Error Power Select what the controller outputs will do when an input error switches control to manual mode.	OFF Off, sets output power to 0% (62) BPLS Bumpless transfer, maintains same output power, if it was less than 75% and stable, otherwise 0% (14) FPA Fixed Power, sets output power to Fixed Power setting (54) USER User, sets output power to last open-loop set point the user entered (100)	User	Instance 1 Map 1 Map 2 2184 2664 Instance 2 Map 1 Map 2 2264 2744	0x6B (107) 1 to 2 0xD (13)	- - - -	7013	uint RWES
FPA MAn	Control Loop (1 to 2) Fixed Power Set the manual output power level that will take effect if an input error failure occurs while User Failure Action is set to Fixed Power.	Set Point Open Loop Limit Low to Set Point Open Loop Limit High (Setup Page)	0.0	Instance 1 Map 1 Map 2 2180 2660 Instance 2 Map 1 Map 2 2260 2740	0x6B (107) 1 to 2 0xB (11)	- - - -	7011	float RWES

* These parameters/prompts are available in these menus with firmware revisions 11.0 and above.
** R: Read, W: Write, E: EEPROM, S: User Set

Setup Page								
Display	Parameter Name Description	Range	Default	Modbus Relative Address	CIP - Class Instance Attribute hex (dec)	Pro-fibus Index	Parameter ID	Data Type and Access **
L.dE L.dE	<i>Control Loop (1 to 2)</i> Open Loop Detect Enable Select Yes to detect conditions that prevent the process from changing in specified time frame by a specified amount when PID power is at 100%. An open loop detect error will disable the control loop.	no No (59) YES Yes (106)	No	<i>Instance 1</i> Map 1 Map 2 1922 2402 <i>Instance 2</i> Map 1 Map 2 1992 2472	0x97 (151) 1 to 2 0x16 (22)	74	8039	uint RWES
No Display	<i>Control Loop (1 to 2)</i> Open Loop Error Status View the cause of the most recent error.	none (61) Open Loop (1274) Reversed Sensor (1275)	- - - -	<i>Instance 1</i> Map 1 Map 2 1928 2408 <i>Instance 2</i> Map 1 Map 2 1998 2478	0x97 (151) 1 to 2 0x19 (25)	- - - -	8048	uint R
L.dt L.dt	<i>Control Loop (1 to 2)</i> Open Loop Detect Time Process must deviate by the Open Loop Detect Deviation value in the specified time, while at 100% PID power, otherwise an Open Loop Detect event is triggered.	0 to 3,600 seconds	240	<i>Instance 1</i> Map 1 Map 2 1924 2404 <i>Instance 2</i> Map 1 Map 2 1994 2474	0x97 (151) 1 to 2 0x17 (23)	75	8040	uint RWES
L.dd L.dd	<i>Control Loop (1 to 2)</i> Open Loop Detect Deviation Process must deviate by this value in the Open Loop Detect Time while at 100% PID power to prevent an open loop error.	-1,999.000 to 9,999.000 °F or units -1,110.555 to 5,555.000 °C	10.0 °F or units 6.0 °C	<i>Instance 1</i> Map 1 Map 2 1926 2406 <i>Instance 2</i> Map 1 Map 2 1996 2476	0x97 (151) 1 to 2 0x18 (24)	76	8041	float RWES
* These parameters/prompts are available in these menus with firmware revisions 11.0 and above. ** R: Read, W: Write, E: EEPROM, S: User Set								

Setup Page

Display	Parameter Name Description	Range	Default	Modbus Relative Address	CIP - Class Instance Attribute hex (dec)	Pro-fibus Index	Parameter ID	Data Type and Access **
r.P rP	Control Loop (1 to 2) Ramp Action Select when the controller's set point will ramp to the defined end set point.	oFF Off (62) StAr Startup (88) StPt Set Point Change (85) boTh Both (13)	Off	Instance 1 Map 1 Map 2 2186 2666 Instance 2 Map 1 Map 2 2266 2746	0x6B (107) 1 to 2 0xE (14)	56	7014	uint RWES
r.SC r.SC	Control Loop (1 to 2) Ramp Scale Select the scale of the ramp rate.	hoUr Hours (39) mIn Minutes (57)	Minutes	Instance 1 Map 1 Map 2 2188 2668 Instance 2 Map 1 Map 2 2268 2748	0x6B (107) 1 to 2 0xF (15)	57	7015	uint RWES
r.r.t r.rt	Control Loop (1 to 2) Ramp Rate Set the rate for the set point ramp. Set the time units for the rate with the Ramp Scale parameter.	0.0 to 9,999.000 °F or units 0.0 to 5,555.000 °C	1.0 °F or units 1.0 °C	Instance 1 Map 1 Map 2 2192 2672 Instance 2 Map 1 Map 2 2272 2752	0x6B (107) 1 to 2 0x11 (17)	58	7017	float RWES
L.SP L.SP	Control Loop (1 to 2) Minimum Set Point Set the minimum value of the closed loop set point range.	-1,999.000 to 9,999.000 °F or units -1,128.000 to 5,537.000 °C	-1,999 °F or units -1,128 °C	Instance 1 Map 1 Map 2 2164 2644 Instance 2 Map 1 Map 2 2244 2724	0x6B (107) 1 to 2 3	52	7003	float RWES
h.SP h.SP	Control Loop (1 to 2) Maximum Set Point Set the maximum value of the closed loop set point range.	-1,999.000 to 9,999.000 °F or units -1,128.000 to 5,537.000 °C	9,999 °F or units 5,537 °C	Instance 1 Map 1 Map 2 2166 2646 Instance 2 Map 1 Map 2 2246 2726	0x6B (107) 1 to 2 4	53	7004	float RWES
C.SP C.SP	Control Loop (1 to 2) Set Point * Set the set point that the controller will automatically control to.	-1,999.000 to 9,999.000 °F or units -1,128.000 to 5,537.000 °C	75.0 °F or units 24.0 °C	Instance 1 Map 1 Map 2 2160 2640 Instance 2 Map 1 Map 2 2240 2720	0x6B (107) 1 to 2 1	49	7001	float RWES

* These parameters/prompts are available in these menus with firmware revisions 11.0 and above.

** R: Read, W: Write, E: EEPROM, S: User Set

Setup Page								
Display	Parameter Name Description	Range	Default	Modbus Relative Address	CIP - Class Instance Attribute hex (dec)	Pro-fibus Index	Parameter ID	Data Type and Access **
id.S id.S	<i>Control Loop (1 to 2)</i> Idle Set Point * Set a closed loop set point that can be triggered by an event state.	-1,999.000 to 9,999.000°F or units -1,128.000 to 5,537.000°C	75.0°F or units 24.0°C	<i>Instance 1</i> Map 1 Map 2 2176 2656 <i>Instance 2</i> Map 1 Map 2 2197 2736	0x6B (107) 1 to 2 9	50	7009	float RWES
SPLo SP.Lo	<i>Control Loop (1 to 2)</i> Minimum Manual Power Set the minimum value of the open-loop set point range.	-100.0 to 100.0%	-100	<i>Instance 1</i> Map 1 Map 2 2168 2648 <i>Instance 2</i> Map 1 Map 2 2248 2728	0x6B (107) 1 to 2 5	54	7005	float RWES
SP.hi SP.hi	<i>Control Loop (1 to 2)</i> Maximum Manual Power Set the maximum value of the open-loop set point range.	-100.0 to 100.0%	100	<i>Instance 1</i> Map 1 Map 2 2170 2650 <i>Instance 2</i> Map 1 Map 2 2250 2730	0x6B (107) 1 to 2 6	55	7006	float RWES
o.SP o.SP	<i>Control Loop (1 to 2)</i> Manual Power * Set a fixed level of output power when in manual (open-loop) mode.	-100.0 to 100.0% (heat and cool) 0 to 100.0% (heat only) -100.0 to 0% (cool only)	0.0	<i>Instance 1</i> Map 1 Map 2 2162 2642 <i>Instance 2</i> Map 1 Map 2 2242 2722	0x6B (107) 1 to 2 2	51	7002	float RWES
C.M C.M	<i>Control Loop (1 to 2)</i> Control Mode * Select the method that this loop will use to control.	OFF Off (62) AUTO Auto (10) MAN Manual (54)	Auto	<i>Instance 1</i> Map 1 Map 2 1880 2360 <i>Instance 2</i> Map 1 Map 2 1950 2430	0x97 (151) 1 to 2 1	63	8001	uint RWES
* These parameters/prompts are available in these menus with firmware revisions 11.0 and above. ** R: Read, W: Write, E: EEPROM, S: User Set								

Setup Page

Display	Parameter Name Description	Range	Default	Modbus Relative Address	CIP - Class Instance Attribute hex (dec)	Pro-fibus Index	Parameter ID	Data Type and Access **
<p>o t P t S E t Output Menu</p>								
F n Fn	<p>Output Digital (1 to 4) Function Select what function will drive this output. Note: When digit 9 in the part number = L, output 4 is always fixed as a limit function. In addition, only output 3 can be programmed as a limit function.</p>	<p>o F F Off (62) A L P t Alarm (6) h E A t Heat (36) C o o l Cool (20) S o F . 1 Special Function Output 1 (1532) S o F . 2 Special Function Output 2 (1533) t E o 1 Timer Event 1 (1951) t E o 2 Timer Event 2 (1952) t E o 3 Timer Event 3 (1953) E n t . A Profile Event Out A (233) E n t . B Profile Event Out B (234) L i m i t Limit (126)</p>	<p>Output 1 - Heat Output 2 - Alarm Output 3 - Off Output 4 - Off</p>	<p>Instance 1 Map 1 Map 2 888 1008</p> <p>Offset to next instance (Map 1 & Map 2) equals +30</p>	<p>0x6A (106) 1 to 4 5</p>	83	6005	uint RWES
F i Fi	<p>Output Digital (1 to 4) Output Function Instance Set the instance of the function selected above.</p>	1 to 4	1	<p>Instance 1 Map 1 Map 2 890 1010</p> <p>Offset to next instance (Map 1 & Map 2) equals +30</p>	<p>0x6A (106) 1 to 4 6</p>	84	6006	uint RWES
o C t o.Ct	<p>Output Digital (1 to 4) Time Base Type Set the time base type. This parameter is only used with PID control, but can be set anytime.</p>	<p>F t b Fixed Time Base (34) v a r i a b l e Variable Time Base (103)</p>	Fixed Time Base	<p>Instance 1 Map 1 Map 2 882 1002</p> <p>Offset to next instance (Map 1 & Map 2) equals +30</p>	<p>0x6A (106) 1 to 4 2</p>	85	6002	uint RWES
<p>* These parameters/prompts are available in these menus with firmware revisions 11.0 and above. ** R: Read, W: Write, E: EEPROM, S: User Set</p>								

Setup Page								
Display	Parameter Name Description	Range	Default	Modbus Relative Address	CIP - Class Instance Attribute hex (dec)	Pro-fibus Index	Parameter ID	Data Type and Access **
o.tb o.tb	<i>Output Digital (1 to 4)</i> Fixed Time Base Set the time base for fixed-time-base control.	0.1 to 60.0 seconds (solid-state relay or switched dc) 5.0 to 60.0 seconds (mechanical relay or NO-ARC power control)	1.0 sec. for SSR or swdc 5.0 for relay	<i>Instance 1</i> Map 1 884 Map 2 1004 Offset to next instance (Map 1 & Map 2) equals +30	0x6A (106) 1 to 4 3	86	6003	float RWES
o.Lo o.Lo	<i>Output Digital (1 to 4)</i> Low Power Scale The power output will never be less than the value specified and will represent the value at which output scaling begins.	0.0 to 100.0%	0.0%	<i>Instance 1</i> Map 1 896 Map 2 1016 Offset to next instance (Map 1 & Map 2) equals +30	0x6A (106) 1 to 4 9	87	6009	float RWES
o.hi o.hi	<i>Output Digital (1 to 4)</i> High Power Scale The power output will never be greater than the value specified and will represent the value at which output scaling stops.	0.0 to 100.0%	100.0%	<i>Instance 1</i> Map 1 898 Map 2 1018 Offset to next instance (Map 1 & Map 2) equals +30	0x6A (106) 1 to 4 0x0A (10)	88	6010	float RWES
o.ty o.ty	<i>Output Process (1 or 3)</i> Type Select whether the process output will operate in volts or milliamps.	vOLt Volts (104) mIa Milliamps (112)	Volts	<i>Instance 1</i> Map 1 720 Map 2 840 <i>Instance 3</i> Map 1 800 Map 2 920	0x76 (118) 1 or 3 1	95	18001	uint RWES
Fn Fn	<i>Output Process (1 or 3)</i> Function Set the type of function that will drive this output.	oFF Off (62) hEAt Heat (36) Cool Cool (20) dUPL Duplex (212) ALaRm Alarm (6) Ent.A Profile Event Out A (233) Ent.b Profile Event Out B (234) rPmT Retransmit (213)	Off	<i>Instance 1</i> Map 1 722 Map 2 842 <i>Instance 3</i> Map 1 802 Map 2 922	0x76 (118) 1 or 3 2	96	18002	uint RWES

* These parameters/prompts are available in these menus with firmware revisions 11.0 and above.

** R: Read, W: Write, E: EEPROM, S: User Set

Setup Page

Display	Parameter Name Description	Range	Default	Modbus Relative Address	CIP - Class Instance Attribute hex (dec)	Pro-fibus Index	Parameter ID	Data Type and Access **
r.Sr r.Sr	<i>Output Process (1 or 3)</i> Retransmit Source Select the value that will be retransmitted.	R , Analog Input (142) SEt Pnt Set Point (85) Curren Current Sample and hold (22) P Process Value (241)	Analog Input	<i>Instance 1</i> Map 1 Map 2 724 844 <i>Instance 3</i> Map 1 Map 2 804 924	0x76 (118) 1 or 3 3	97	18003	uint RWES
F , Fi	<i>Output Process (1 or 3)</i> Function Instance Set the instance of the function selected above.	1 to 4	1	<i>Instance 1</i> Map 1 Map 2 726 846 <i>Instance 3</i> Map 1 Map 2 806 926	0x76 (118) 1 or 3 4	98	18004	uint RWES
SLo S.Lo	<i>Output Process (1 or 3)</i> Scale Low Set the scale low for process output in electrical units. This value; in volts or milliamps, will correspond to 0% PID power output or range low retransmit output.	-100.0 to 100.0	0.00	<i>Instance 1</i> Map 1 Map 2 736 856 <i>Instance 3</i> Map 1 Map 2 816 936	0x76 (118) 1 or 3 9	99	18009	float RWES
S.h , S.hi	<i>Output Process (1 or 3)</i> Scale High Set the scale high for process output in electrical units. This value; in volts or milliamps, will correspond to 100% PID power output or range high retransmit output.	-100.0 to 100.0	10.00	<i>Instance 1</i> Map 1 Map 2 738 858 <i>Instance 3</i> Map 1 Map 2 818 938	0x76 (118) 1 or 3 0x0A (10)	100	18010	float RWES

* These parameters/prompts are available in these menus with firmware revisions 11.0 and above.

** R: Read, W: Write, E: EEPROM, S: User Set

Setup Page

Display	Parameter Name Description	Range	Default	Modbus Relative Address	CIP - Class Instance Attribute hex (dec)	Pro-fibus Index	Parameter ID	Data Type and Access **
r.Lo r.Lo	<i>Output Process (1 or 3)</i> Range Low Set the minimum value of the re-transmit value range in process units. When the retransmit source is at this value, the retransmit output will be at its Scale Low value.	-1,999.000 to 9,999.000 °F or units -1,128.000 to 5,537.000 °C	0.0 °F or units -18 °C	<i>Instance 1</i> Map 1 Map 2 740 860 <i>Instance 3</i> Map 1 Map 2 820 940	0x76 (118) 1 or 3 0x0B (11)	101	18011	float RWES
r.h.i r.h.i	<i>Output Process (1 or 3)</i> Range High Set the maximum value of the re-transmit value range in process units. When the retransmit source is at this value, the retransmit output will be at its Scale High value.	-1,999.000 to 9,999.000 °F or units -1,128.000 to 5,537.000 °C	100.0 °F or units 38.0 °C	<i>Instance 1</i> Map 1 Map 2 742 862 <i>Instance 3</i> Map 1 Map 2 822 942	0x76 (118) 1 or 3 0x0C (12)	102	18012	float RWES
a.CA o.CA	<i>Output Process (1 or 3)</i> Calibration Offset Set an offset value for a process output.	-1,999.000 to 9,999.000 °F or units -1,110.555 to 5,555.000 °C	0.0 °F or units 0.0 °C	<i>Instance 1</i> Map 1 Map 2 732 852 <i>Instance 3</i> Map 1 Map 2 812 932	0x76 (118) 1 or 3 7	105	18007	float RWES

ALP7

SEE

Alarm Menu

ALY A.ty	Alarm (1 to 4) Type Select whether the alarm trigger is a fixed value or will track the set point.	<i>aFF</i> Off (62) <i>P.r.AL</i> Process Alarm (76) <i>dE.AL</i> Deviation Alarm (24)	Off	<i>Instance 1</i> Map 1 Map 2 1508 1908 Offset to next instance (Map 1 +50, Map 2 +60)	0x6D (109) 1 to 4 0xF (15)	20	9015	uint RWES
-------------	---	--	-----	---	----------------------------------	----	------	-----------

* These parameters/prompts are available in these menus with firmware revisions 11.0 and above.

** R: Read, W: Write, E: EEPROM, S: User Set

Setup Page

Display	Parameter Name Description	Range	Default	Modbus Relative Address	CIP - Class Instance Attribute hex (dec)	Pro-fibus Index	Parameter ID	Data Type and Access **
Sr.A Sr.A	<i>Alarm (1 to 4)</i> Alarm Source Select what will trigger this alarm. Note: When using Deviation Alarms with Differential control, the Alarm Source must be set to Process Value.	<i>nonE</i> None (61) <i>Ai</i> Analog Input (142) <i>Lnr</i> Linearization (238) <i>Pv</i> Process Value (241) <i>Pwr</i> Power (73) <i>dbi</i> Digital Bus Input (1993) <i>LdCu</i> Load Current RMS (179) <i>Cur</i> Current Read is Sample and Hold (22)		<i>Instance 1</i> Map 1 1512 Map 2 1912 Offset to next instance (Map 1 +50, Map 2 +60)	0x6D (109) 1 to 4 0x11 (17)	21	9017	uint RWES
iS.A iS.A	<i>Alarm (1 to 4)</i> Alarm Source Instance Set the instance of the function selected above.	1 or 2	1	<i>Instance 1</i> Map 1 1514 Map 2 1914 Offset to next instance (Map 1 +50, Map 2 +60)	0x6D (109) 1 to 2 0x12 (18)	22	9018	uint RWES
Loop Loop	<i>Alarm (1 to 4)</i> Control Loop Set the instance of the Set Point Closed, Control Loop, that will be referenced by the deviation alarm. Note: Not available on single loop models.	1 to 2	1	<i>Instance 1</i> Map 1 1524 Map 2 1924 Offset to next instance (Map 1 +50, Map 2 +60)	0x6D (109) 1 to 2 0x17 (23)	23	9023	uint RWES
A.hy A.hy	<i>Alarm (1 to 4)</i> Hysteresis Set the hysteresis for an alarm. This determines how far into the safe region the process value needs to move before the alarm can be cleared.	0.001 to 9,999.000 °F or units 0.001 to 5,555.000 °C	1.0 °F or units 1.0 °C	<i>Instance 1</i> Map 1 1484 Map 2 1884 Offset to next instance (Map 1 equals +50, Map 2 +60)	0x6D (109) 1 to 4 3	24	9003	float RWES

* These parameters/prompts are available in these menus with firmware revisions 11.0 and above.

** R: Read, W: Write, E: EEPROM, S: User Set

Setup Page								
Display	Parameter Name Description	Range	Default	Modbus Relative Address	CIP - Class Instance Attribute hex (dec)	Pro-fibus Index	Parameter ID	Data Type and Access **
AL9 A.Lg	<i>Alarm (1 to 4) Logic</i> Select what the output condition will be during the alarm state.	ALC Energize on alarm (17) ALo De-energize on alarm (66)	Close On Alarm	<i>Instance 1</i> Map 1 1488 Map 2 1888 Offset to next instance (Map 1 +50, Map 2 +60)	0x6D (109) 1 to 4 5	25	9005	uint RWES
ASd A.Sd	<i>Alarm (1 to 4) Sides</i> Select which side or sides will trigger this alarm.	both Both (13) high High (37) low Low (53)	Both	<i>Instance 1</i> Map 1 1486 Map 2 1886 Offset to next instance (Map 1 +50, Map 2 +60)	0x6D (109) 1 to 4 4	26	9004	uint RWES
ALo A.Lo	<i>Alarm (1 to 4) Low Set Point</i> If Type (Setup Page, Alarm Menu) is set to: Process - set the process value that will trigger a low alarm. Deviation - set the span of units from the closed loop set point that will trigger a low alarm. A negative set point represents a value below closed loop set point. A positive set point represents a value above closed loop set point.	-1,999.000 to 9,999.000° F or units -1,128.000 to 5,537.000° C	32.0° F or units 0.0° C	<i>Instance 1</i> Map 1 1482 Map 2 1882 Offset to next instance (Map 1 +50, Map 2 +60)	0x6D (109) 1 to 4 2	18	9002	float RWES
* These parameters/prompts are available in these menus with firmware revisions 11.0 and above. ** R: Read, W: Write, E: EEPROM, S: User Set								

Setup Page								
Display	Parameter Name Description	Range	Default	Modbus Relative Address	CIP - Class Instance Attribute hex (dec)	Pro-fibus Index	Parameter ID	Data Type and Access **
A.h A.hi	<i>Alarm (1 to 4)</i> High Set Point If Type (Setup Page, Alarm Menu) is set to: Process - set the process value that will trigger a high alarm. Deviation - set the span of units from the closed loop set point that will trigger a high alarm.	-1,999.000 to 9,999.000° F or units -1,128.000 to 5,537.000° C	300.0° F or units 150.0° C	<i>Instance 1</i> Map 1 Map 2 1480 1880 Offset to next instance (Map 1) equals +50 Offset to next instance (Map 2) equals +60	0x6D (109) 1 to 4 1	19	9001	float RWES
A.LA A.LA	<i>Alarm (1 to 4)</i> Latching Turn latching on or off. A latched alarm has to be turned off by the user.	nLAt Non-Latching (60) LAt Latching (49)	Non-Latching	<i>Instance 1</i> Map 1 Map 2 1492 1892 Offset to next instance (Map 1) equals +50, for Map 2 equals +60)	0x6D (109) 1 to 4 7	27	9007	uint RWES
A.bL A.bL	<i>Alarm (1 to 4)</i> Blocking Select when an alarm will be blocked. After start-up and/or after the set point changes, the alarm will be blocked until the process value enters the normal range.	oFF Off (62) StAr Startup (88) StPt Set Point (85) boTh Both (13)	Off	<i>Instance 1</i> Map 1 Map 2 1494 1894 Offset to next instance (Map 1) equals +50, for Map 2 equals +60)	0x6D (109) 1 to 4 8	28	9008	uint RWES
* These parameters/prompts are available in these menus with firmware revisions 11.0 and above. ** R: Read, W: Write, E: EEPROM, S: User Set								

Setup Page								
Display	Parameter Name Description	Range	Default	Modbus Relative Address	CIP - Class Instance Attribute hex (dec)	Pro-fibus Index	Parameter ID	Data Type and Access **
<i>RS</i> , A.Si	<i>Alarm (1 to 4) Silencing</i> Turn silencing on to allow the user to disable this alarm.	<i>oFF</i> Off (62) <i>oN</i> On (63)	Off	<i>Instance 1</i> Map 1 Map 2 1490 1890 Offset to next instance (Map 1 equals +50, for Map 2 equals +60)	0x6D (109) 1 to 4 6	29	9006	uint RWES
<i>RdSP</i> A.dSP	<i>Alarm (1 to 4) Display</i> Display an alarm message when an alarm is active.	<i>oFF</i> Off (62) <i>oN</i> On (63)	On	<i>Instance 1</i> Map 1 Map 2 1510 1910 Offset to next instance (Map 1 equals +50, for Map 2 equals +60)	0x6D (109) 1 to 4 0x10 (16)	30	9016	uint RWES
<i>RdL</i> A.dL	<i>Alarm (1 to 4) Delay Time</i> Set the span of time that the alarm will be delayed after the process value exceeds the alarm set point.	0 to 9,999 seconds	0	<i>Instance 1</i> Map 1 Map 2 1520 1920 Offset to next instance (Map 1 equals +50, for Map 2 equals +60)	0x6D (109) 1 to 4 0x15 (21)	31	9021	uint RWES
<i>RCLR</i> A.Clr	<i>Alarm (1 to 4) Clear Alarm</i> Write to this register to clear an alarm Note: If an alarm is set-up to latch when active <i>RCLR</i> will appear on the display.	<i>CLR</i> Clear (0) <i>Ignr</i> Ignore (204)	----	<i>Instance 1</i> Map 1 Map 2 1504 1904 Offset to next instance (Map1 1 equals +50, Map 2 equals +60)	0x6D (109) 1 to 4 0xD (13)	----	9013	uint W
* These parameters/prompts are available in these menus with firmware revisions 11.0 and above. ** R: Read, W: Write, E: EEPROM, S: User Set								

Setup Page								
Display	Parameter Name Description	Range	Default	Modbus Relative Address	CIP - Class Instance Attribute hex (dec)	Pro-fibus Index	Parameter ID	Data Type and Access **
RS ir A.Sir	<i>Alarm (1 to 4)</i> Silence Alarm Write to this register to silence an alarm Note: If an alarm is setup to silence alarm when active RS ir will appear on the display.	S il Silence (1010)	----	<i>Instance 1</i> Map 1 Map 2 1506 1906 Offset to next instance (Map1 1 equals +50, Map 2 equals +60)	0x6D (109) 1 to 4 0xE (14)	----	9014	uint W
RS t A.St	<i>Alarm (1 to 4)</i> Alarm State Current state of alarm	S t r Startup (88) non E None (61) bl o Blocked (12) AL L Alarm low (8) AL h Alarm high (7) AL E Error (28)	----	<i>Instance 1</i> Map 1 Map 2 1496 1896 Offset to next instance (Map1 1 equals +50, Map 2 equals +60)	0x6D (109) 1 to 4 9	----	9009	uint R
CUrr SEt Current Menu			Note: For further description and usage tips see the CT Application Note in this User's Guide.					
CS d C.Sd	<i>Current (1)</i> Sides Select which side or sides will be monitored.	oFF Off (62) h i gh High (37) l o w Low (53) bo th Both (13)	off	<i>Instance 1</i> Map 1 Map 2 1128 1368	0x73 (115) 1 5	145	15005	uint RWES
CUr CU.r	<i>Current (1)</i> Indicate Reading Use Indicate Reading to display solid-state relay (SSR) failure and heater failure messages.	no No (59) YES Yes (106)	no	<i>Instance 1</i> Map 1 Map 2 1126 1366	0x73 (115) 1 4	146	15004	uint RWES
CDt C.dt	<i>Current (1)</i> Input Detection Threshold For factory adjustment only.	3 to 59	9	<i>Instance 1</i> Map 1 Map 2 1142 1382	0x73 (115) 1 0xC (12)	147	15012	uint RWES
* These parameters/prompts are available in these menus with firmware revisions 11.0 and above. ** R: Read, W: Write, E: EEPROM, S: User Set								

Setup Page								
Display	Parameter Name Description	Range	Default	Modbus Relative Address	CIP - Class Instance Attribute hex (dec)	Pro-fibus Index	Parameter ID	Data Type and Access **
C.SC C.SC	<i>Current (1)</i> Input Scaling Adjust scaling to match the transformer's high range.	0 to 9,999.000	50.0	<i>Instance 1</i> Map 1 1162 Map 2 1402	0x73 (115) 1 0x16 (22)	148	15022	float RWES
C.oFS C.oFS	<i>Current (1)</i> Heater Offset Calibrate the current reading with an offset value.	-9,999.000 to 9,999.000	0.0	<i>Instance 1</i> Map 1 1140 Map 2 1380	0x73 (115) 1 0xB (11)	149	15011	float RWES
C.Si C.Si	<i>Current (1)</i> Monitored Output Select which output instance the current transformer will monitor.	1 to 12	1	<i>Instance 1</i> Map 1 1156 Map 2 1396	0x73 (115) 1 0x13 (19)	150	15019	uint RWES
Timer Menu								
ti.En ti.En	<i>Timer (1)</i> Timer Enable Enable the timer function.	YES Yes (106) no No (59)	Yes	<i>Instance 1</i> Map 1 4626 Map 2 8556	0x83 (131) 1 0x1D (29)	- - - -	31029	uint RWES
ti.St ti.St	<i>Timer (1)</i> Timer Start Method Select what will start the timer.	immed Immediate (1049) rdy Ready Band (1942) rdyA Ready Ack (1950) PLU Power (73)	Immediate	<i>Instance 1</i> Map 1 4628 Map 2 8558	0x83 (131) 1 0x1E (30)	- - - -	31030	uint RWES
SFn.A SFn.A	<i>Timer (1)</i> Source Function A Select which input will start or terminate the timer.	FUn Function Key (1001) none None (61) diO Digital I/O (1142)	Function Key	<i>Instance 1</i> Map 1 4570 Map 2 8500	0x83 (131) 1 0x01 (1)	- - - -	31001	uint RWES
Si.A Si.A	<i>Timer (1)</i> Source Instance A Select an instance of Function A.	1 to 24	8	<i>Instance 1</i> Map 1 4574 Map 2 8504	0x83 (131) 1 0x03 (3)	- - - -	31003	uint RWES
* These parameters/prompts are available in these menus with firmware revisions 11.0 and above. ** R: Read, W: Write, E: EEPROM, S: User Set								

Setup Page								
Display	Parameter Name Description	Range	Default	Modbus Relative Address	CIP - Class Instance Attribute hex (dec)	Pro-fibus Index	Parameter ID	Data Type and Access **
SFn.C SFn.C	Timer (1) Source Function C Select the analog source for the ready band.	P _v Process Value (241) nonE None (61) R _i Analog Input (142) L _{nr} Linearization (238)	Process Value	Instance 1 Map 1 Map 2 4630 8560	0x83 (131) 1 0x1F (31)	----	31031	uint RWES
Si.C Si.C	Timer (1) Source Instance C Select an instance of Function C.	1 to 24	1	Instance 1 Map 1 Map 2 4634 8564	0x83 (131) 1 0x21 (33)	----	31033	uint RWES
SFn.D SFn.D	Timer (1) Source Function D Select which input will acknowledge the ready band.	F _{Un} Function Key (1001) nonE None (61) d _{io} Digital I/O (1142)	Function Key	Instance 1 Map 1 Map 2 4632 8562	0x83 (131) 1 0x20 (32)	----	31032	uint RWES
Si.d Si.d	Timer (1) Source Instance D Select an instance of Function D.	1 to 24	7	Instance 1 Map 1 Map 2 4636 8566	0x83 (131) 1 0x22 (34)	----	31034	uint RWES
t.r t.r	Timer (1) Time Remaining Display the time remaining on the timer.	00:00 to 99:59	7	----	0x83 (131) 1 0x15 (21)	----	31021	string R
r.bS r.bS	Timer (1) Ready Band State Display whether the process value is in the ready band.	YES Yes (106) no No (59)	----	Instance 1 Map 1 Map 2 4612 8542	0x83 (131) 1 0x16 (22)	----	31022	uint R
rdY rdY	Timer (1) Ready Band Set the how close the process value must be to the closed loop timer set point to be in the ready band.	0.000 to 9999.000 °F or units 0.000 to 5555.000 °C	5.000	Instance 1 Map 1 Map 2 4614 8544	0x83 (131) 1 0x17 (23)	----	31023	float RWES

* These parameters/prompts are available in these menus with firmware revisions 11.0 and above.

** R: Read, W: Write, E: EEPROM, S: User Set

Setup Page								
Display	Parameter Name Description	Range	Default	Modbus Relative Address	CIP - Class Instance Attribute hex (dec)	Pro-fibus Index	Parameter ID	Data Type and Access **
t.For	Timer (1) Time Format Select the time format.	Time Minutes:Seconds (1943) Time Hours:Minutes (1944)	Time Minutes: Seconds	Instance 1 Map 1 Map 2 4616 8546	0x83 (131) 1 0x18 (24)	- - - -	31024	uint RWES
hoUr	Timer (1) Hours Set the timer period hours.	0 to 99	0	Instance 1 Map 1 Map 2 4618 8548	0x83 (131) 1 0x19 (25)	- - - -	31025	uint RWES
nn in Min	Timer (1) Minutes Set the timer period minutes.	0 to 59	0	Instance 1 Map 1 Map 2 4620 8550	0x83 (131) 1 0x1A (26)	- - - -	31026	uint RWES
SEC SEC	Timer (1) Seconds Set the timer period seconds.	0 to 59	10	Instance 1 Map 1 Map 2 4622 8552	0x83 (131) 1 0x1B (27)	- - - -	31027	uint RWES
Ct.SP Ct.SP	Timer (1) Closed Loop Timer Set Point Set the set point that will be in effect during the timer period.	-1999.000 to 9999.000°F or units -1110.555 to 5555.000°C	75	Instance 1 Map 1 Map 2 4624 8554	0x83 (131) 1 0x1C (28)	- - - -	31028	float RWES
St St	Timer (1) Signal Time Set the period of time that a signal output to be activated after the timer period is complete. Assign a digital output for this function in Timer Event Output 3.	1 to 3600 Seconds	1	Instance 1 Map 1 Map 2 4658 8588	0x83 (131) 1 0x2D (45)	- - - -	31045	uint RWES
* These parameters/prompts are available in these menus with firmware revisions 11.0 and above. ** R: Read, W: Write, E: EEPROM, S: User Set								

Setup Page

Display	Parameter Name Description	Range	Default	Modbus Relative Address	CIP - Class Instance Attribute hex (dec)	Pro-fibus Index	Parameter ID	Data Type and Access **
<p>Math Menu</p>								
Fn Fn	<i>Math (1)</i> Function Set the operator that will be applied to the sources.	OFF Off (62) P.S.C Process Scale (1371) d.S.C Deviation Scale (1372)	Off	<i>Instance 1</i> Map 1 Map 2 - - - - 3040	0x7D (125) 1 0x15 (21)	128	25021	uint RWES
SFn.E SFn.E	<i>Math (1)</i> Source Function E Set the type of function that will be used for this source.	nonE None (61) FUn Function Key (1001) d i o Digital I/O (1142)	None	<i>Instance 1</i> Map 1 Map 2 - - - - 3008	0x7D (125) 1 5	- - - -	25005	uint RWES
Si.E Si.E	<i>Math (1)</i> Source Instance E Set the instance of the function selected above.	1 to 12	1	<i>Instance 1</i> Map 1 Map 2 - - - - 3018	0x7D (125) 1 0xA (10)		25010	float RWES
S.Lo S.Lo	<i>Math (1)</i> Scale Low This value will correspond to Output Range Low.	-1,999.000 to 9,999.000	0.0	<i>Instance 1</i> Map 1 Map 2 - - - - 3046	0x7D (125) 1 0x18 (24)	129	25024	float RWES
S.hi S.hi	<i>Math (1)</i> Scale High This value will correspond to Output Range High.	-1,999.000 to 9,999.000	1.0	<i>Instance 1</i> Map 1 Map 2 - - - - 3048	0x7D (125) 1 0x19 (25)	130	25025	float RWES
r.Lo r.Lo	<i>Math (1)</i> Range Low This value will correspond to Input Scale Low.	-1,999.000 to 9,999.000	0.0	<i>Instance 1</i> Map 1 Map 2 - - - - 3050	0x7D (125) 1 0x1A (26)	131	25026	float RWES
r.hi r.hi	<i>Math (1)</i> Range High This value will correspond to Input Scale High.	-1,999.000 to 9,999.000	1.0	<i>Instance 1</i> Map 1 Map 2 - - - - 3052	0x7D (125) 1 0x1B (27)	132	25027	float RWES

* These parameters/prompts are available in these menus with firmware revisions 11.0 and above.
 ** R: Read, W: Write, E: EEPROM, S: User Set

Setup Page								
Display	Parameter Name Description	Range	Default	Modbus Relative Address	CIP - Class Instance Attribute hex (dec)	Pro-fibus Index	Parameter ID	Data Type and Access **
FiL FiL	<i>Math (1)</i> Filter Filtering smooths out the output signal of this function block. Increase the time to increase filtering.	0.0 to 60.0 seconds	0.0	<i>Instance 1</i> Map 1 Map 2 - - - - 3054	0x7D (125) 1 0x1C (28)	- - - -	25028	float RWES
SoF SEt Special Output Function Menu								
Fn Fn	<i>Special Output (1)</i> Function Set the function to match the device it will operate.	oFF Off (62) uRE Motorized Valve (1508) CoE Compressor Control (1506)	Off	<i>Instance 1</i> Map 1 Map 2 - - - - 3856	0x87 (135) 1 9	181	35009	uint RWES
SFn.A SFn.A	<i>Special Output (1)</i> Source Function A Set the type of function that will be used for this source.	nonE None (61) PUJr Power (73) hPr Heat Power (160) CPr Cool Power (161)	None	<i>Instance 1</i> Map 1 Map 2 - - - - 3840	0x87 (135) 1 1	182	35001	uint RWES
Si.A Si.A	<i>Special Output (1)</i> Source Instance A Set the instance of the function selected above.	1 to 2	1	<i>Instance 1</i> Map 1 Map 2 - - - - 3844	0x87 (135) 1 3	183	35003	uint RWES
SFn.b SFn.b	<i>Special Output (1)</i> Source Function B Set the type of function that will be used for this source.	nonE None (61) PUJr Power (73) hPr Heat Power (160) CPr Cool Power (161)	None	<i>Instance 1</i> Map 1 Map 2 - - - - 3842	0x87 (135) 1 2	184	35002	uint RWES
Si.b Si.b	<i>Special Output (1)</i> Source Instance B Set the instance of the function selected above.	1 to 2	1	<i>Instance 1</i> Map 1 Map 2 - - - - 3846	0x87 (135) 1 4	185	35004	uint RWES
Pon.A Pon.A	<i>Special Output (1)</i> Input A Turn On Compressor 1 power on level.	-100.00 to 100.00%	0	<i>Instance 1</i> Map 1 Map 2 - - - - 3874	0x87 (135) 1 0x12 (18)	186	35018	float RWES
* These parameters/prompts are available in these menus with firmware revisions 11.0 and above. ** R: Read, W: Write, E: EEPROM, S: User Set								

Setup Page								
Display	Parameter Name Description	Range	Default	Modbus Relative Address	CIP - Class Instance Attribute hex (dec)	Pro-fibus Index	Parameter ID	Data Type and Access **
PoF.A PoF.A	Special Output (1) Input A Turn Off Compressor 1 power off level.	-100.00 to 100.00%	5	Instance 1 Map 1 Map 2 - - - - 3876	0x87 (135) 1 0x13 (19)	187	35019	float RWES
Pon.b Pon.b	Special Output (1) Input B Turn On Compressor 2 power on level.	-100.00 to 100.00%	0	Instance 1 Map 1 Map 2 - - - - 3878	0x87 (135) 1 0x14 (20)	188	35020	float RWES
PoF.b PoF.b	Special Output (1) Input B Turn Off Compressor 1 power off level.	-100.00 to 100.00%	5	Instance 1 Map 1 Map 2 - - - - 3880	0x87 (135) 1 0x15 (21)	189	35021	float RWES
on.t on.t	Special Output (1) Minimum On Time At a minimum stay on specified amount of time.	0 to 9,999 seconds	20	Instance 1 Map 1 Map 2 - - - - 3882	0x87 (135) 1 0x16 (22)	190	35022	uint RWES
oF.t oF.t	Special Output (1) Minimum Off Time At a minimum stay off specified amount of time.	0 to 9,999 seconds	20	Instance 1 Map 1 Map 2 - - - - 3884	0x87 (135) 1 0x17 (23)	191	35023	uint RWES
t.t t.t	Special Output (1) Valve Travel Time The amount of time it takes the valve to fully open and then fully close.	10 to 9,999 seconds	120	Instance 1 Map 1 Map 2 - - - - 3886	0x87 (135) 1 0x18 (24)	192	35024	uint RWES
db db	Special Output (1) Dead Band Output power needs to change by specified level prior to turning on.	1.0 to 100.0%	2	Instance 1 Map 1 Map 2 - - - - 3888	0x87 (135) 1 0x19 (25)	193	35025	float RWES

* These parameters/prompts are available in these menus with firmware revisions 11.0 and above.

** R: Read, W: Write, E: EEPROM, S: User Set

Setup Page								
Display	Parameter Name Description	Range	Default	Modbus Relative Address	CIP - Class Instance Attribute hex (dec)	Pro-fibus Index	Parameter ID	Data Type and Access **
t.dL t.dL	<i>Special Output (1)</i> Time Delay If requested power is 0.0% for longer than the specified Time Delay, the compressor will shut off.	0 to 9,999 seconds	0	<i>Instance 1</i> Map 1 Map 2 - - - - 3890	0x87 (135) 1 0x1A (26)	- - - -	35026	uint RWES
<p><i>Fun</i> <i>SEt</i> Function Key</p>								
LEv LEv	<i>Function Key (1 to 2)</i> Active Level The Function Key will always power up in the low state. Pressing the Function Key will toggle the selected action.	<i>h,9h</i> High (37) <i>LoLd</i> Low (53)	High	<i>Instance 1</i> Map 1 Map 2 1360 1600 <i>Instance 2</i> Map 1 Map 2 1380 1620	0x6E (110) 1 to 2 1	137	10001	uint RWES
<p>* These parameters/prompts are available in these menus with firmware revisions 11.0 and above. ** R: Read, W: Write, E: EEPROM, S: User Set</p>								

Setup Page

Display	Parameter Name Description	Range	Default	Modbus Relative Address	CIP - Class Instance Attribute hex (dec)	Pro-fibus Index	Parameter ID	Data Type and Access **
<i>Fn</i> Fn	<p><i>Function Key (1 to 2)</i> Action Function Program the EZ Key to trigger an action. Functions respond to a level state change or an edge level change.</p> <p>Note: The Limit Reset function is not available in firmware revision 11.0 and above.</p>	<p><i>nonE</i> None (61) <i>r.En</i> Remote Set Point (216) <i>L.P.R</i> Limit Reset, edge triggered (82) <i>u.S.r.r</i> User Set Restore, edge triggered (227) <i>P.L.o.C</i> Keypad Lock-out, level triggered (217) <i>AL.P.P</i> Alarm Reset, edge triggered (6) <i>S.i.L</i> Silence Alarms, edge triggered (108) <i>A.o.F</i> Control Loops Off and Alarms to Non-alarm State, level triggered (220) <i>F.AL</i> Force Alarm to occur, level triggered (218) <i>i.d.L.E</i> Idle Set Point, level triggered (107) <i>t.U.n.E</i> Tune, edge triggered (98) <i>P.P.A.n</i> Manual, level triggered (54) <i>o.F.F</i> Switch Control Loop Off, level triggered (90) <i>t.d.A</i> TRU-TUNE+® Disable, level triggered (219) <i>P.d.i.S</i> Profile Disable, level triggered (206) <i>P.h.o.L</i> Profile Hold/Resume, level triggered (207) <i>P.r.o.F</i> Start Profile, edge triggered (196) <i>P.S.t.S</i> Profile Start/Stop, level triggered (208) <i>S.S.t.P</i> Start Step (1077)</p>	None	<p><i>Instance 1</i> Map 1 Map 2 1364 1604</p> <p><i>Instance 2</i> Map 1 Map 2 1384 1624</p>	0x6E (110) 3 to 4 3	138	10003	uint RWES

* These parameters/prompts are available in these menus with firmware revisions 11.0 and above.
** R: Read, W: Write, E: EEPROM, S: User Set

Setup Page								
Display	Parameter Name Description	Range	Default	Modbus Relative Address	CIP - Class Instance Attribute hex (dec)	Pro-fibus Index	Parameter ID	Data Type and Access **
F , Fi	<i>Function Key (1 to 2)</i> Function Instance Select which instance the EZ Key will affect. If only one instance is available, any selection will affect it.	0 to 40	0	<i>Instance 1</i> Map 1 Map 2 1366 1606 <i>Instance 2</i> Map 1 Map 2 1386 1626	0x96 (110) 3 to 4 4	139	10004	- - - -
9LbL 5Ee Global Menu								
C_F C_F	<i>Global</i> Display Units Select which scale to use for temperature.	F °F (30) C °C (15)	°F	<i>Instance 1</i> Map 1 Map 2 1838 2308	0x67 (103) 1 5	110	3005	uint RWES
AC.LF AC.LF	<i>Global</i> AC Line Frequency Set the frequency to the applied ac line power source.	50 50 Hz (3) 60 60 Hz (4)	60 Hz	<i>Instance 1</i> Map 1 Map 2 886 1006	0x6A (106) 1 4	89	1034	uint RWES
r.tyP r.tyP	<i>Global</i> Ramping Type	rAEE Rate (81) E , Time (143)	Time	<i>Instance 1</i> Map 1 Map 2 - - - - 4414	0x7A (122) 1 26 (38)	- - - -	22038	uint RWE
P.tyP P.tyP	<i>Global</i> Profile Type Set the profile startup to be based on a set point or a process value.	SEPe Set Point (85) Pro Process (75)	Set Point	<i>Instance 1</i> Map 1 Map 2 2534 4354	0x7A (122) 1 8	- - - -	22008	uint RWE
gSE gSE	<i>Global</i> Guaranteed Soak Enable Enables the guaranteed soak deviation function in profiles.	oFF Off (62) oN On (63)	Off	<i>Instance 1</i> Map 1 Map 2 2530 4350	0x7A (122) 1 6	- - - -	22006	uint RWE
* These parameters/prompts are available in these menus with firmware revisions 11.0 and above. ** R: Read, W: Write, E: EEPROM, S: User Set								

Setup Page								
Display	Parameter Name Description	Range	Default	Modbus Relative Address	CIP - Class Instance Attribute hex (dec)	Pro-fibus Index	Parameter ID	Data Type and Access **
95d1 gSd1	<i>Global</i> Guaranteed Soak Deviation 1 Set the value of the deviation band that will be used in all profile step types. The process value must enter the deviation band before the step can proceed.	0.0 to 9,999.000 °F or units 0.0 to 5,555.000 °C	10.0 °F or units 6.0 °C	<i>Instance 1</i> Map 1 Map 2 2532 4352	0x7A (122) 1 7	- - - -	22007	float RWE
95d2 gSd2	<i>Global</i> Guaranteed Soak Deviation 2 Set the value of the deviation band that will be used in all profile step types. The process value must enter the deviation band before the step can proceed.	0.0 to 9,999.000 °F or units 0.0 to 5,555.000 °C	10.0 °F or units 6.0 °C	<i>Instance 1</i> Map 1 Map 2 - - - - 4420	0x7A (122) 1 0x29 (41)	- - - -	22041	float RWE
5 .A Si.a	<i>Global</i> Source Instance A Set the digital source for Wait for Event 1 in profile.	5 to 12	5	<i>Instance 1</i> Map 1 Map 2 - - - - 4390	0x7A (122) 1 0x1A (26)	- - - -	22060	uint RWES
5 .B Si.b	<i>Global</i> Source Instance B Set the digital source for Wait for Event 2 in profile.	5 to 12	5	<i>Instance 1</i> Map 1 Map 2 - - - - 4392	0x7A (122) 1 0x1B (27)	- - - -	22061	uint RWES
Pot Poti	<i>Global</i> Power Off Time If profile is running and power is lost, profile will resume where it left off provided time set has not expired prior to power restoration.	0 to 9999 seconds	0	<i>Instance 1</i> Map 1 Map 2 - - - - 4484	0x7A (122) 1 0x49 (73)	- - - -	22073	uint RWE
* These parameters/prompts are available in these menus with firmware revisions 11.0 and above. ** R: Read, W: Write, E: EEPROM, S: User Set								

Setup Page								
Display	Parameter Name Description	Range	Default	Modbus Relative Address	CIP - Class Instance Attribute hex (dec)	Pro-fibus Index	Parameter ID	Data Type and Access **
SFn.E SFn.E	Global Source Function E Set the source for profile wait.	<i>R</i> , Analog Input (142) <i>db</i> , Digital Bus Input (1993)	Analog Input	<i>Instance 1</i> Map 1 Map 2 - - - - 4450	0x7A (122) 1 0x38 (56)	- - - -	22056	uint RWES
Si.E Si.E	Global Source Instance E Set the instance of the function selected above.	1 to 6	1	<i>Instance 1</i> Map 1 Map 2 - - - - 4458	0x7A (122) 1 0x3C (60)	- - - -	22060	unsigned 8-bits RWES
SFn.F SFn.F	Global Source Function F Set the source for profile wait.	<i>R</i> , Analog Input (142) <i>db</i> , Digital Bus Input (1993)	Analog Input	<i>Instance 1</i> Map 1 Map 2 - - - - 4452	0x7A (122) 1 0x39 (57)	- - - -	22057	uint RWES
Si.F Si.F	Global Source Instance F Set the instance of the function selected above.	1 to 6	1	<i>Instance 1</i> Map 1 Map 2 - - - - 4460	0x7A (122) 1 0x3D (61)	- - - -	22061	unsigned 8-bits RWES
Svtb Svtb	Global Synchronized Variable Time Base Used to acquire tighter accuracy when running a profile. A setting of +0.01 would equate to approximately +9 seconds/day (faster) where a setting of -0.01 would equate to approximately -9 seconds/day (slower).	-2 to 2 %	0.00	- - - -	- - - -	- - - -	- - - -	float RWE
C.LEd C.LEd	Global Communications LED Action Turns comms LED on or off for selected comms ports.	<i>Con1</i> Comm port 1 (1189) <i>Con2</i> Comm port 2 (1190) <i>both</i> Comm port 1 and 2 (13) <i>OFF</i> Off (62)	both	<i>Instance 1</i> Map 1 Map 2 1856 2326	0x6A (103) 1 0x0E (14)	- - - -	3014	uint RWES

* These parameters/prompts are available in these menus with firmware revisions 11.0 and above.

** R: Read, W: Write, E: EEPROM, S: User Set

Setup Page

Display	Parameter Name Description	Range	Default	Modbus Relative Address	CIP - Class Instance Attribute hex (dec)	Pro-fibus Index	Parameter ID	Data Type and Access **
ZonE Zone	<i>Global</i> Zone Turns Zone LED on or off based on selection.	oFF Off (62) oN On (63)	On	<i>Instance 1</i> Map 1 Map 2 - - - - 2350	0x6A (103) 1 0x1A (26)	- - - -	3026	uint RWES
Chan Chan	<i>Global</i> Channel Turns Channel LED on or off based on selection.	oFF Off (62) oN On (63)	On	<i>Instance 1</i> Map 1 Map 2 - - - - 2352	0x6A (103) 1 0x1B (27)	- - - -	3027	uint RWES
dPrS d.PrS	<i>Global</i> Display Pairs Defines the number of Display Pairs.	1 to 10	2	<i>Instance 1</i> Map 1 Map 2 - - - - 2354	0x6A (103) 1 0x1C (28)	- - - -	3028	uint RWES
d.ti d.ti	<i>Global</i> Display Time Time delay in toggling between Display Pairs.	0 to 60	0	<i>Instance 1</i> Map 1 Map 2 - - - - 2356	0x6A (103) 1 0x1D (29)	- - - -	3029	uint RWES
USr.S USr.S	<i>Global</i> Save Settings As Save all of this controller's settings to the selected set.	SEt 1 User Set 1 (101) SEt 2 User Set 2 (102) nonE None (61)	None	<i>Instance 1</i> Map 1 Map 2 26 26	0x(101) 1 0xE (14)	118	1014	uint RWE
USr.r USr.r	<i>Global</i> Restore Settings From Replace all of this controller's settings with another set.	FACT Factory (31) nonE None (61) SEt 1 User Set 1 (101) SEt 2 User Set 2 (102)	None	<i>Instance 1</i> Map 1 Map 2 24 24	0x65 (101) 1 0xD (13)	117	1013	uint RWE
CoM SEt Communications Menu								
PCoL PCoL	<i>Communications 1</i> Protocol Set the protocol of this controller to the protocol that this network is using.	Std Standard Bus (1286) Mod Modbus RTU (1057)	Modbus	<i>Instance 1</i> Map 1 Map 2 2492 2972	0x96 (150) 1 7	- - - -	17009	uint RWE
* These parameters/prompts are available in these menus with firmware revisions 11.0 and above. ** R: Read, W: Write, E: EEPROM, S: User Set								

Setup Page								
Display	Parameter Name Description	Range	Default	Modbus Relative Address	CIP - Class Instance Attribute hex (dec)	Pro-fibus Index	Parameter ID	Data Type and Access **
Standard Bus								
Ad.S Ad.S	<i>Communications 1</i> Standard Bus Address Set the network address of this controller. Each device on the network must have a unique address. The Zone Display on the front panel will display this number.	1 to 16	1	<i>Instance 1</i> Map 1 2480 Map 2 2960	0x96 (150) 1 1	- - - -	17001	uint RWE
Modbus RTU								
Ad.M Ad.M	<i>Communications (1 or 2)</i> Modbus Address Set the network address of this controller. Each device on the network must have a unique address.	1 to 247	1	<i>Instance 1</i> Map 1 2482 Map 2 2962 <i>Instance 2</i> Map 1 2500 Map 2 2980	0x96 (150) 1 to 2 2	- - - -	17007	uint RWE
bAUd bAUd	<i>Communications (1 or 2)</i> Baud Rate Set the speed of this controller's communications to match the speed of the Modbus serial network.	9600 9,600 (188) 192 19,200 (189) 384 38,400 (190)	9,600	<i>Instance 1</i> Map 1 2484 Map 2 2964 <i>Instance 2</i> Map 1 2504 Map 2 2984	0x96 (150) 1 to 2 3	- - - -	17002	uint RWE
PAR PAR	<i>Communications (1 or 2)</i> Parity Set the parity of this controller to match the parity of the Modbus serial network.	none None (61) Even Even (191) odd Odd (192)	None	<i>Instance 1</i> Map 1 2486 Map 2 2966 <i>Instance 2</i> Map 1 2506 Map 2 2986	0x96 (150) 1 to 2 4	- - - -	17003	uint RWE
* These parameters/prompts are available in these menus with firmware revisions 11.0 and above. ** R: Read, W: Write, E: EEPROM, S: User Set								

Setup Page

Display	Parameter Name Description	Range	Default	Modbus Relative Address	CIP - Class Instance Attribute hex (dec)	Pro-fibus Index	Parameter ID	Data Type and Access **
C_F C_F	<p><i>Communications (1 or 2)</i> Display Units Select whether this communications channel will display in Celsius or Fahrenheit.</p> <p>Note: Applies to Modbus only.</p>	<p>F Fahrenheit (30) C Celsius (15)</p>	F	<p><i>Instance 1</i> Map 1 2490 Map 2 2970</p>	<p>0x96 (150) 1 6</p>	----	17050	uint RWE
M.hL M.hL	<p><i>Communications (1 or 2)</i> Modbus Word Order Select the word order of the two 16-bit words in the floating-point values.</p>	<p>L o h , Low-High (1331) h , L o High-Low (1330)</p>	Low-High	<p><i>Instance 1</i> Map 1 2488 Map 2 2968 <i>Instance 2</i> Map 1 2508 Map 2 2988</p>	<p>0x96 (150) 1 to 2 5</p>	----	17043	uint RWE
M a p M a p	<p><i>Communications (1 or 2)</i> Data Map If set to 1 the control will use PM legacy mapping. If set to 2 the control will use new mapping to accommodate new functions.</p>	1 to 2	1 if 9th digit of part number is a D or 1 otherwise, 2.	----	----	----	17059	uint RWE
n V S n V S	<p><i>Communications (1 or 2)</i> Non-Volatile Save If set to Yes all values written to the control will be saved in EEPROM. The EEPROM allows for approximately one million writes.</p>	<p>Y E S Yes (106) n o No (59)</p>	Yes	<p><i>Instance 1</i> Map 1 2494 Map 2 2974</p>	<p>0x96 (150) 1 8</p>	198	17051	uint RWE
no display	<p><i>Communications (1 or 2)</i> Tick Value increases at 1mS rate.</p>	0 to 4,294,967,295	----	<p><i>Instance 1</i> Map 1 5020 Map 2 8950</p>	----	----	16006	unsigned 32-bit RWE

* These parameters/prompts are available in these menus with firmware revisions 11.0 and above.

** R: Read, W: Write, E: EEPROM, S: User Set

Setup Page

Display	Parameter Name Description	Range	Default	Modbus Relative Address	CIP - Class Instance Attribute hex (dec)	Pro-fibus Index	Parameter ID	Data Type and Access **
DeviceNet								
<i>Ad.d</i> Ad.d	<i>Communications (2)</i> DeviceNet™ Node Address Set the DeviceNet™ address for this gateway.	0 to 63	63	----	----	----	17052	----
<i>bAUd</i> bAUd	<i>Communications (2)</i> DeviceNet™ Baud Rate Set the DeviceNet speed for this gateway's communications to match the speed of the serial network.	<i>125</i> 125 kb (1351) <i>250</i> 250 kb (1352) <i>500</i> 500 kb (1353)	125	----	----	----	17053	----
<i>FC.E</i> FC.E	<i>Communications (2)</i> DeviceNet™ Quick Connect Enable Allows for immediate communication with the scanner upon power up.	<i>no</i> No (59) <i>YES</i> Yes (106)	No	----	----	----	17054	----
<i>Ao.nb</i> Ao.nb	Communications (2) CIP Implicit Assembly Output Member Quantity	1 to 20	20	----	----	----	24009	----
<i>Ai.nb</i> Ai.nb	Communications (2) CIP Implicit Assembly Input Member Quantity	1 to 20	20	----	----	----	24010	----
<i>C_F</i> C_F	Communications (2) Display Units Select which scale to use for temperature passed over communications port 2.	<i>F</i> °F (30) <i>C</i> °C (15)	°F	<i>Instance 2</i> Map 1 Map 2 ---- 2990	0x96 (150) 2 6	199	17050	uint RWE
<i>nU.S</i> nU.S	Communications (2) Non-volatile Save If set to Yes all values written to the control will be saved in EEPROM. The EEPROM allows for approximately one million writes.	<i>YES</i> Yes (106) <i>no</i> No (59)	No	<i>Instance 2</i> Map 1 Map 2 2514 2994	96 (150) 2 8	198	17051	uint RWE

* These parameters/prompts are available in these menus with firmware revisions 11.0 and above.

** R: Read, W: Write, E: EEPROM, S: User Set

Setup Page								
Display	Parameter Name Description	Range	Default	Modbus Relative Address	CIP - Class Instance Attribute hex (dec)	Pro-fibus Index	Parameter ID	Data Type and Access **
J1939 CAN bus (Digital Input Bus)								
JAd J.Ad	<i>Communications (2)</i> J1939 Device Address Set the Device address.	0 to 255	249	- - - -	- - - -	- - - -	94001	unsigned 8-bits RWE
JbAu J.bAu	<i>Communications (2)</i> J1939 Baud Rate Set the Digital Input Bus communications speed.	125 125 kb (1351) 250 250 kb (1352) 500 500 kb (1353) 1000 1000 kb (1364)	250	- - - -	- - - -	- - - -	94002	uint RWE
dEn d.En	<i>Communications (2)</i> J1939 Device Enable Enables the device for communication.	no No (59) YES Yes (106)	Yes	- - - -	- - - -	- - - -	94003	uint RWE
tEds tEds	<i>Communications (2)</i> Transducer Electronic Data Sheet Contains sensor technical characteristics when manufactured.	no No (59) YES Yes (106)	Yes	- - - -	- - - -	- - - -	94004	float R
C_F C_F	<i>Communications (2)</i> J1939 Display Units Select which scale to use for temperature passed over communications port 2.	C °C (15) F °F (30) none None (61)	°C	- - - -	- - - -	- - - -	17050	uint RWE
Map Map	<i>Communications (2)</i> Data Map If set to 1 the control will use legacy Modbus mapping. If set to 2, the control will use new Modbus mapping to accommodate new functions. Not used with J1939.	1 to 2	1	- - - -	- - - -	- - - -	17059	uint RWE
* These parameters/prompts are available in these menus with firmware revisions 11.0 and above. ** R: Read, W: Write, E: EEPROM, S: User Set								

Setup Page								
Display	Parameter Name Description	Range	Default	Modbus Relative Address	CIP - Class Instance Attribute hex (dec)	Pro-fibus Index	Parameter ID	Data Type and Access **
<i>nUS</i> nU.S	Communications (2) Non-volatile Save If set to Yes all values written to the control will be saved in EEPROM. The EEPROM allows for approximately one million writes.	<i>YES</i> Yes (106) <i>no</i> No (59)	No	----	----	----	----	uint RWE
Profibus DP								
<i>PAdd</i> P.Add	Communications (2) Profibus Node Address Set the Profibus address for this control.	0 to 126	126	----	----	----	17060	----
<i>ALoc</i> A.Loc	Communications (2) Profibus Address Lock When set to yes will not allow address to be changed using software. Can be changed from front panel.	<i>no</i> No (59) <i>YES</i> Yes (106)	No	----	----	----	17061	----
<i>Stat</i> Stat	Communications Profibus DP Status Current Profibus status.	<i>Ready</i> Ready (1662) <i>Run</i> Running (149)	----	----	----	----	17062	uint R
<i>C_F</i> C_F	Communications (2) Display Units Select which scale to use for temperature passed over communications port 2.	<i>F</i> °F (30) <i>C</i> °C (15)	°F	<i>Instance 2</i> Map 1 Map 2 ---- 2990	0x96 (150) 2 6	199	17050	uint RWE
<i>nUS</i> nU.S	Communications (2) Non-volatile Save If set to Yes all values written to the control will be saved in EEPROM. The EEPROM allows for approximately one million writes.	<i>YES</i> Yes (106) <i>no</i> No (59)	No	<i>Instance 2</i> Map 1 Map 2 2514 2994	96 (150) 2 8	198	17051	uint RWE
* These parameters/prompts are available in these menus with firmware revisions 11.0 and above. ** R: Read, W: Write, E: EEPROM, S: User Set								

Setup Page								
Display	Parameter Name Description	Range	Default	Modbus Relative Address	CIP - Class Instance Attribute hex (dec)	Pro-fibus Index	Parameter ID	Data Type and Access **
Modbus TCP or EtherNet/IP								
M.hL	<i>Communications (2)</i> Modbus Word Order Select the word order of the two 16-bit words in the floating-point values.	L o h , Low-High (1331) h i L o High-Low (1330)	Low-High	<i>Instance 1</i> Map 1 2488 Map 2 2968 <i>Instance 2</i> Map 1 2508 Map 2 2988	0x96 (150) 1 to 2 5	- - - -	17043	uint RWE
iP.M	<i>Communications (2)</i> IP Address Mode Select DHCP to let a DHCP server assign an address to this module.	d h C P DHCP (1281) F . A d d Fixed Address (1284)	DHCP	- - - -	- - - -	- - - -	17012	uint RWE
Note: When changing IP address, the control power must be cycled for the new address to take effect.								
ip.F1	<i>Communications (2)</i> IP Fixed Address Part 1 Set the IP address of this module. Each device on the network must have a unique address.	0 to 255	169	- - - -	- - - -	- - - -	17014	uint RWE
ip.F2	<i>Communications (2)</i> IP Fixed Address Part 2 Set the IP address of this module. Each device on the network must have a unique address.	0 to 255	254	- - - -	- - - -	- - - -	17015	uint RWE
ip.F3	<i>Communications (2)</i> IP Fixed Address Part 3 Set the IP address of this module. Each device on the network must have a unique address.	0 to 255	1	- - - -	- - - -	- - - -	17016	uint RWE
* These parameters/prompts are available in these menus with firmware revisions 11.0 and above. ** R: Read, W: Write, E: EEPROM, S: User Set								

Setup Page								
Display	Parameter Name Description	Range	Default	Modbus Relative Address	CIP - Class Instance Attribute hex (dec)	Pro-fibus Index	Parameter ID	Data Type and Access **
.P.F4 ip.F4	<i>Communications (2)</i> IP Fixed Address Part 4 Set the IP address of this module. Each device on the network must have a unique address.	0 to 255	1	----	----	----	17017	uint RWE
.P.S1 ip.S1	<i>Communications (2)</i> IP Fixed Subnet Part 1 Set the IP subnet mask for this module.	0 to 255	255	----	----	----	17020	uint RWE
.P.S2 ip.S2	<i>Communications (2)</i> IP Fixed Subnet Part 2 Set the IP subnet mask for this module.	0 to 255	255	----	----	----	17021	uint RWE
.P.S3 ip.S3	<i>Communications (2)</i> IP Fixed Subnet Part 3 Set the IP subnet mask for this module.	0 to 255	0	----	----	----	17022	uint RWE
.P.S4 ip.S4	<i>Communications (2)</i> IP Fixed Subnet Part 4 Set the IP subnet mask for this module.	0 to 255	0	----	----	----	17023	uint RWE
.P.S5 ip.S5	<i>Communications (2)</i> IP Fixed Subnet Part 5 Set the IP subnet mask for this module	0 to 255	0	----	----	----	17024	uint RWE
.P.S6 ip.S6	<i>Communications (2)</i> IP Fixed Subnet Part 6 Set the IP subnet mask for this module.	0 to 255	0	----	----	----	17025	uint RWE
* These parameters/prompts are available in these menus with firmware revisions 11.0 and above. ** R: Read, W: Write, E: EEPROM, S: User Set								

Setup Page

Display	Parameter Name Description	Range	Default	Modbus Relative Ad- dress	CIP - Class Instance Attribute hex (dec)	Pro- fibus Index	Param- eter ID	Data Type and Access **
.P.91 ip.g1	<i>Communications (2)</i> Fixed IP Gateway Part 1 Used for the pur- pose of sending and receiving messages from another net- work.	0 to 255	0	----	----	----	17026	uint RWE
.P.92 ip.g2	<i>Communications (2)</i> Fixed IP Gateway Part 2 Used for the pur- pose of sending and receiving messages from another net- work.	0 to 255	0	----	----	----	17027	uint RWE
.P.93 ip.g3	<i>Communications (2)</i> Fixed IP Gateway Part 3 Used for the pur- pose of sending and receiving messages from another net- work.	0 to 255	0	----	----	----	17028	uint RWE
.P.94 ip.g4	<i>Communications (2)</i> Fixed IP Gateway Part 4 Used for the pur- pose of sending and receiving messages from another net- work.	0 to 255	0	----	----	----	17029	uint RWE
.P.95 ip.g5	<i>Communications (2)</i> Fixed IP Gateway Part 5 Used for the pur- pose of sending and receiving messages from another net- work.	0 to 255	0	----	----	----	17030	uint RWE
.P.96 ip.g6	<i>Communications (2)</i> Fixed IP Gateway Part 6 Used for the pur- pose of sending and receiving messages from another net- work.	0 to 255	0	----	----	----	17031	uint RWE

* These parameters/prompts are available in these menus with firmware revisions 11.0 and above.

** R: Read, W: Write, E: EEPROM, S: User Set

Setup Page								
Display	Parameter Name Description	Range	Default	Modbus Relative Address	CIP - Class Instance Attribute hex (dec)	Pro-fibus Index	Parameter ID	Data Type and Access **
<i>Mo.E</i> Mb.E	Communications (2) Modbus TCP Enable Activate Modbus TCP.	<i>YES</i> Yes (106) <i>no</i> No (59)	Yes	----	----	----	17041	uint RWE
<i>Ei.P.E</i> EiP.E	Communications (2) EtherNet/IP™ Enable Activate Ethernet/ IP™.	<i>YES</i> Yes (106) <i>no</i> No (59)	Yes	----	----	----	17042	uint RWE
<i>Ao.nb</i> Ao.nb	Communications (2) EtherNet/IP™ Output Assembly When using Ethernet/IP set the CIP Implicit Assembly Output Member Quantity	1 to 20	20	----	----	----	24009	uint RWE
<i>Ai.nb</i> Ai.nb	Communications (2) EtherNet/IP™ Input Assembly When using Ethernet/IP set the CIP Implicit Assembly Input Member Quantity	1 to 20	20	----	----	----	24010	uint RWE
<i>C_F</i> C_F	Communications (2) Display Units Select which scale to use for temperature passed over communications port 2.	<i>F</i> °F (30) <i>C</i> °C (15)	°F	<i>Instance 2</i> Map 1 Map 2 ---- 2990	0x96 (150) 2 6	199	17050	uint RWE
<i>nV.S</i> nV.S	Communications (2) Non-volatile Save If set to Yes all values written to the control will be saved in EEPROM. The EEPROM allows for approximately one million writes.	<i>YES</i> Yes (106) <i>no</i> No (59)	No	<i>Instance 2</i> Map 1 Map 2 2514 2994	96 (150) 2 8	198	17051	uint RWE
Note: When changing IP address, the control power must be cycled for the new address to take effect.								
* These parameters/prompts are available in these menus with firmware revisions 11.0 and above. ** R: Read, W: Write, E: EEPROM, S: User Set								

Setup Page								
Display	Parameter Name Description	Range	Default	Modbus Relative Address	CIP - Class Instance Attribute hex (dec)	Pro-fibus Index	Parameter ID	Data Type and Access **
r t C S E t Real Time Clock Menu								
h o U r hoUr	Real Time Clock Hours Set the current time.	0 to 23	0	Instance 1 Map 1 Map 2 - - - - 4004	88 (136) 1 3	- - - -	36003	uint RW
m i n Min	Real Time Clock Minutes Set the current time.	0 to 59	0	Instance 1 Map 1 Map 2 - - - - 4006	88 (136) 1 4	- - - -	36004	uint RW
d o W doW	Real Time Clock Day of Week Set the current day of the week.	S u n Sunday (1565) M o n Monday (1559) T u e Tuesday (1560) W e d Wednesday (1561) T h u Thursday (1562) F r i Friday (1563) S a t Saturday (1564)	Sun	Instance 1 Map 1 Map 2 - - - - 4002	88 (136) 1 2	- - - -	36002	uint RW
* These parameters/prompts are available in these menus with firmware revisions 11.0 and above. ** R: Read, W: Write, E: EEPROM, S: User Set								

7

Chapter 7: Profiling Page

Navigating the Profiling Page

Note:

Some of these menus and parameters may not appear, depending on the controller's options. See model number information in the Appendix for more information. If there is only one instance of a menu, no submenus will appear.

Profile Setup

First, consider some foundational profile *setup* features that once configured, will apply to all configured profiles. The screen shot below (EZ-ZONE Configurator software) graphically shows the settings (shaded green) that will apply to all profiles; e.g., if Guaranteed Soak is not enabled here this feature will not be available in any individual profile configuration.

Some of those features that apply to all profiles are listed below with a brief description of their function.

- Ramping Type (Time or Rate) which changes the profile set point based on a set interval of time or set rate.
- Profile Type (Set Point or Process) determines whether a step (any step changing the set point) of a profile will begin by using the process value (Process) or the last closed-loop set point (Set Point).
- Guaranteed Soak Enable, when set to on makes this feature available in all profiles. If Guaranteed Soak Enable is on, use Guaranteed

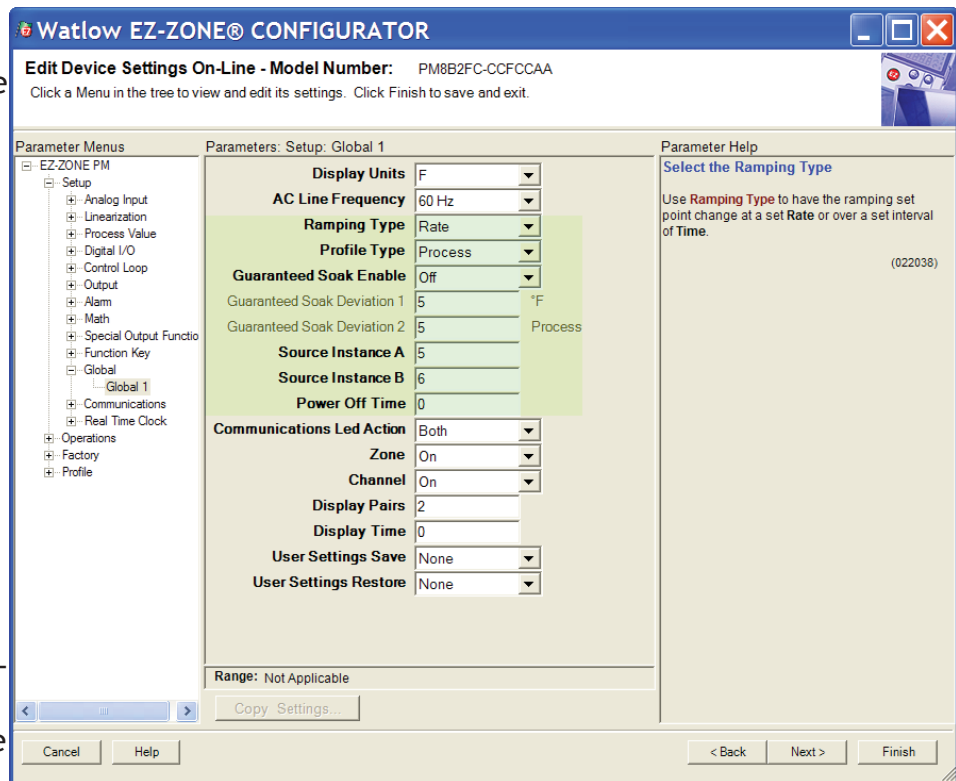













Soak Deviation 1 to 2 to set the value for the corresponding loop. Set the deviation or band above or below the working set point where this condition must be met before the profile can proceed.

Note:

Changes made to profile parameters in the Profiling Pages will be saved and take effect on the next pass through the step. Changes made in the Profile Status page effect the current step being executed and do not update the step setting in the profiling page. Changing profiles should only be changed by knowledgeable personnel and with caution.

Once these global profile features are configured, the next step will require navigation to the Profiling Page. Here, each desired ramp and soak profile will be configured.

To navigate to the Profile Page from the front panel, follow the steps below:

1. From the Home Page, press and hold the Advance Key  for approximately five seconds. The profile prompt *Pr o F* will appear in the lower display and the profile number (e.g. *P 1*) appears in the upper display.
2. Press the Up  or Down  key to change to another profile (1 to 4).
3. Press the Advance Key  to move to the selected profiles first step.
4. Press the Up  or Down  keys to move through and select the step type.
5. Press the Advance Key  to move through the selected step settings.
6. Press the Up  or Down  keys to change the steps settings.
7. Press the Infinity Key  at any time to return to the step number prompt.
8. Press the Infinity Key  again to return to the profile number prompt.
9. From any point press and hold the Infinity Key  for two seconds to return to the Home Page.

If using EZ-ZONE Configurator software, simply click on the plus sign next to Profiles in the left hand column, as shown in the screen shot below.

Notice in the screen shot to the right some fields or parameters are not selectable (grayed out) based on the Step Type that is selected.

Starting a Profile

There are several ways to start a profile. Some of the examples that follow requires that certain optional hardware be available on the control. If you are uncertain as to how your control is equipped, compare the part number of your control to the "Ordering Information" page found in the Appendix of this Users Guide.

Three ways to start a profile:

- Function Key, Digital Input or Profile Request

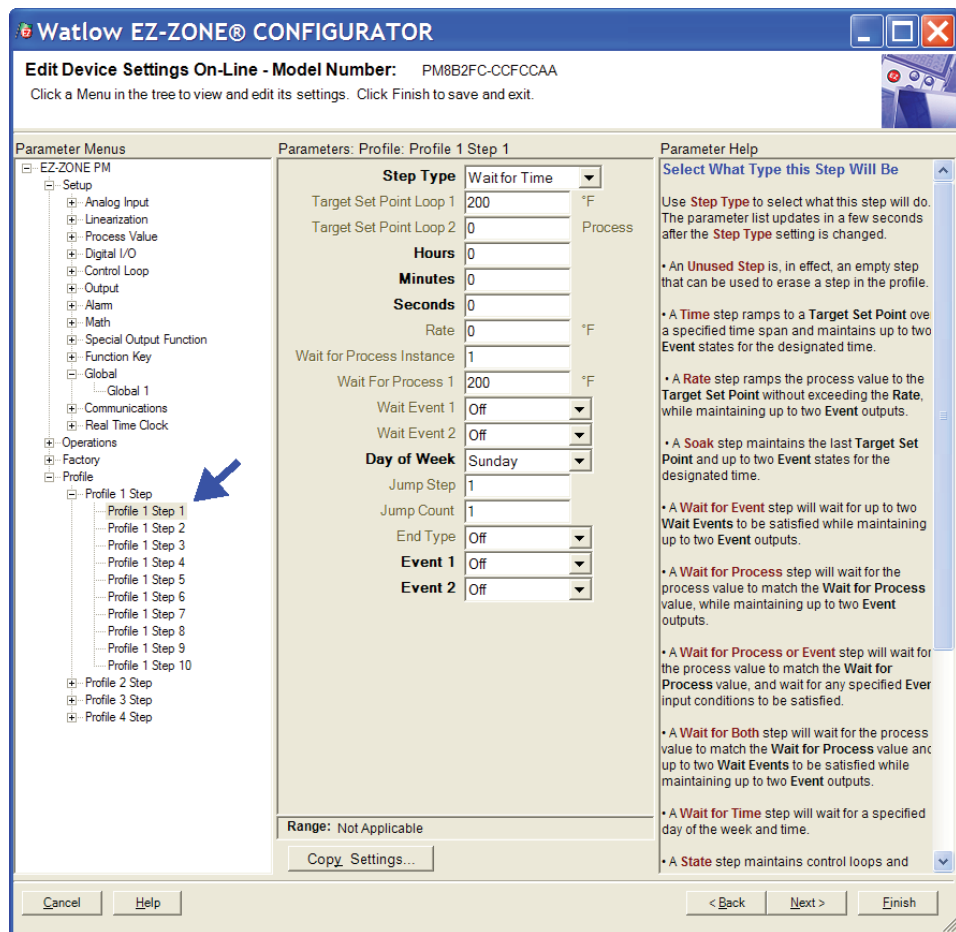

Configuring the Function Key to Start and Stop a Profile

1. Navigate to the Setup Page and then the Function menu. From the Home Page, press and hold the **▲** or Down **▼** key for approximately six seconds where the upper display will show **R**, and the lower display will show **SEt**.
2. Press the Up **▲** or Down **▼** key to navigate to the Function **FUn** menu.
3. Press the Advance Key **⊗** to enter this menu. The upper display will show **f** and the lower display will show **FUn**.
4. Press the Advance Key **⊗** to select the level. The upper display will show **h** and the lower display will show **LEv**.
5. Press the Up **▲** or Down **▼** keys to select the level that will start the profile (high or low).
6. Press the Advance Key **⊗** to select the function. In this example, select Profile Start / Stop **PStS**.
7. Press the Advance Key **⊗** to select the function instance (Profile to start).
8. Return to the Home Page by pressing and holding the Infinity Key **∞** for approximately three seconds.

Note:







The state of the EZ-Function Key (high or low) is maintained with each successive push of the key.

Configuring a Digital Input to Start and Stop a Profile

1. Navigate to the Setup Page and then the Digital I/O menu. From the Home Page, press and hold the **▲** or Down **▼** key for approximately six seconds where the upper display will show **R**, and the lower display will show **SEt**.
2. Press the Up **▲** or Down **▼** key to navigate to the Digital I/O menu. Upper display will show **d** and the lower display will show **SEt**.
3. Press the Advance Key **⊗** where the first available digital instance will be displayed in the upper display.
4. Press the Up **▲** or Down **▼** key to select the input of choice.
5. Press the Advance Key **⊗** to select the direction (input or output). In this example, select Dry Contact **ICOn**.
6. Select the level (high or low) that will activate the function by pressing the Advance Key **⊗** where the upper display will show **h** and the lower display will show **LEv**.
7. Press the Up **▲** or Down **▼** keys to select the level that will start the profile (high = closed or low = open).
8. Press the Advance Key **⊗** to select the function **Fn**. In this example, select Profile Start / Stop **PStS**.
9. Press the Advance Key **⊗** to select the function instance (Profile to start).
10. Return to the Home Page by pressing and holding the Infinity Key **∞** for approximately three seconds.

Starting a Profile from the Operations Page

1. Navigate to the Operations Page and then the Profile Status menu. From the Home Page, press and hold the **▲** or Down **▼** key for approximately three seconds where the upper display will show **R**, and the lower display will show **oPEr**.
2. Press the Up **▲** or Down **▼** key to navigate to the Profile Status **PStR** menu.

3. Press the Advance Key  to enter this menu. The upper display will show *!* and the lower display will show *P5Er*.
4. Press the Up  or Down  keys to select the Profile or Step to start. In this example select 1.
5. Press the Advance Key  to select the Profile Action Request. The upper display will show *nonE* and the lower display will show *PACr*.
6. Press the Up  or Down  keys to select the Profile start. The upper display will show *PrOF* and the lower display will show *PACr*.





Note:

As soon as the Green Advance Key  is pressed (step 7 below) the designated Profile or Step (as determined in step 4 above) will start.

7. Press the Advance Key  to select whether Event 1 will be on or off. The upper display will show *oFF* and the lower display will show *Ent 1*.



Note:

This setting will temporarily override the profile configuration.











8. Press the Up  or Down  keys to select whether Event 1 will be on or off. This will immediately drive the Event to the specified state regardless of the Profile configuration.
9. Press the Advance Key  to select whether Event 2 will be on or off. The upper display will show *oFF* and the lower display will show *Ent 2*.
10. Press the Up  or Down  keys to select whether Event 2 will be on or off. This will immediately drive the Event to the specified state regardless of the Profile configuration.

Note:







The event state will be as left when the profile ended and may be toggled at the profile status menu.

11. Press the Advance Key  to see the current Jump Count. The upper display will show *!* and the lower display will show *JC*.
12. Return to the Home Page by pressing and holding the Infinity Key  for approximately three seconds.



Ending a Profile from the Operations Page

1. Navigate to the Operations Page and then the Profile Status menu. From the Home Page, press and hold the Up  or Down  key for approximately three seconds where the upper display will show *!* and the lower display will show *oPEr*.
2. Press the Up  or Down  key to navigate to the Profile Status *P5Er* menu.
3. Press the Advance Key  to enter this menu. The upper display will show *!* and the lower display will show *P5Er*.
4. Press the Advance Key  to select the Profile Action Request. The upper display will show *nonE* and the lower display will show *PACr*.
6. Press the Up  or Down  keys to select the End. The upper display will show *End* and the lower display will show *PACr*.
7. Press the Advance Key  to end the Profile.
8. Return to the Home Page by pressing and holding the Infinity Key  for approximately three seconds.

Starting a Profile from the Home Page

1. When at the Home Page, press the Advance Key  to locate Profile Start and select the file or step number to start. The upper display will show *I* and the lower display will show *PSE I*.
2. Press the Up  or Down  key to choose the file or step number.
3. Press the Advance Key  to select the Profile Action Request. The upper display will show *nonE* and the lower display will show *PAC I*.
4. Press the Up  or Down  keys to select the Profile Start. The upper display will show *PrOF* and the lower display will show *PAC I*.
5. Press the Infinity Key to return Home. The Profile will Start

Ending a Profile from the Home Page

1. Press the Advance Key  to select the Profile Action Request. The upper display will show *nonE* and the lower display will show *PAC I*.
2. Press the Up  or Down  keys to select the End. The upper display will show *End* and the lower display will show *PAC I*.
3. Press the Infinity Key to return Home. The Profile will End.

Profiling Parameters

P I

PrOF Profile (1 to 4)

I

P I Profile [1 to 4] Step (1 to 40)

STYP Step Type

ESP1 Target Set Point Loop 1

ESP2 Target Set Point Loop 2

hOUr Hours

Min Minutes

SEC Seconds

rATE Rate

WDP I Wait For Process Instance

WDP 1 Wait For Process 1

WDE 1 Wait For Event 1

WDE 2 Wait for Event 2

doWd Day of Week

JS Jump Step

JC Jump Count

End End Type

Ent 1 Event 1

Ent 2 Event 2

Profiling Page							
Display	Parameter Name Description	Range	Default	Modbus Relative Address	CIP Class Instance Attribute hex (dec)	Pa- ram- eter ID	Data Type and Access **
<i>P I</i> <i>Pr o F</i> Profiling Menu							
<i>P I</i> to <i>P 4</i>	Profile [1 to 4] Step Select a step to edit or view.	1 to 10 [profile 1] 11 to 20 [profile 2] 21 to 30 [profile 3] 31 to 40 [profile 4]		----	----	----	----
<i>S t Y P</i> S.typ	Step Type Select a step type. Note: Prior to selecting the Step Type consider whether or not profiles will be based on time or rate of change. By default, profiles are configured for Time <i>t .</i> . Therefore, Rate will not be available here. If it is desired to base profiles on rate of change, navigate to the Setup Page and then the Global Menu where Ramping Type can be changed from Time to Rate.	<i>U S t P</i> Unused Step (50) <i>S o a k</i> Soak (87) <i>W a i t</i> Wait For Event (144) <i>W a i t</i> Wait For Process (209) <i>W a i t</i> Wait For Both (210) <i>J u m p</i> Jump (116) <i>E n d</i> End (27) <i>W a i t</i> Wait For Time (1543) <i>t .</i> Time (143) <i>r a t e</i> Rate (81)	Unused	<i>I n s t a n c e 1</i> Map 1 Map 2 2570 4500 Offset to next in-stance (Map 1 equals +50, Map 2 equals +100)	0x79 (121) 1 to 40 1	21001	uint RWE
<i>t . S P 1</i> t.SP1	<i>S t e p T y p e P a r a m e t e r s</i> Target Set Point Loop 1 When Step Type is Time or Rate, enter the closed loop set point for loop 1 to ramp to for this step.	-1,999.000 to 9,999.000°F or units -1,128 to 5,537.000°C	0.0°F or units -18°C	<i>I n s t a n c e 1</i> Map 1 Map 2 2572 4502 Offset to next in-stance (Map 1 equals +50, Map 2 equals +100)	0x79 (121) 1 to 40 2	21002	float RWE
Note: Some values will be rounded off to fit in the four-character display. Full values can be read with other interfaces. ** R: Read, W: Write, E: EEPROM, S: User Set							

Profiling Page							
Display	Parameter Name Description	Range	Default	Modbus Relative Address	CIP Class Instance Attribute hex (dec)	Pa- ram- eter ID	Data Type and Access **
t.SP2 t.SP2	<i>Step Type Parameters</i> Target Set Point Loop 2 When Step Type is Time enter the closed loop set point for loop 2 to ramp to for this step.	-1,999.000 to 9,999.000°F or units -1,128 to 5,537.000°C	0.0°F or units -18°C	<i>Instance 1</i> Map 1 Map 2 - - - - 4554 Offset to next instance Map 2 equals +100	0x79 (121) 1 to 40 0x1C (28)	21028	float RWE
hoUr hoUr	<i>Step Type Parameters</i> Hours Select the hours (plus Minutes and Seconds) for a timed step.	0 to 9999	0	<i>Instance 1</i> Map 1 Map 2 2574 4504 Offset to next instance (Map 1 equals +50, Map 2 equals +100)	0x79 (121) 1 to 40 3	21003	uint RWE
Min Min	<i>Step Type Parameters</i> Minutes When Step Type is Time, Soak, or Wait For Time enter Minutes (plus Hours and Seconds) for this step.	0 to 59	0	<i>Instance 1</i> Map 1 Map 2 2576 4506 Offset to next instance (Map 1 equals +50, Map 2 equals +100)	0x79 (121) 1 to 40 4	21004	uint RWE
SEC SEC	<i>Step Type Parameters</i> Seconds When Step Type is Time, Soak, or Wait For Time enter Seconds (plus Hours and Minutes) for this step.	0 to 59	0	<i>Instance 1</i> Map 1 Map 2 2578 4508 Offset to next instance (Map 1 equals +50, Map 2 equals +100)	0x79 (121) 1 to 40 5	21005	uint RWE
<p>Note: Some values will be rounded off to fit in the four-character display. Full values can be read with other interfaces. ** R: Read, W: Write, E: EEPROM, S: User Set</p>							

Profiling Page

Display	Parameter Name Description	Range	Default	Modbus Relative Address	CIP Class Instance Attribute hex (dec)	Pa- ram- eter ID	Data Type and Access **
rAtE rAtE	<i>Step Type Parameters</i> Rate When Step Type is Rate, enter the rate for ramping in degrees or units per minute.	0 to 9,999.000° F or units per minute 0 to 5,555.000° C per minute	0.0	<i>Instance 1</i> Map 1 Map 2 2580 4510 Offset to next in- stance (Map 1 equals +50, Map 2 equals +100)	0x79 (121) 1 to 40 6	21006	float RWE
W.Pi W.Pi	<i>Step Type Parameters</i> Wait For Process Instance When Step Type is Wait for Process or Wait For Both, enter which analog input specified by Wait For Process 1 must be met before proceeding in profile.	1 or 2	1	<i>Instance 1</i> Map 1 Map 2 2598 4528 Offset to next in- stance (Map 1 equals +50, Map 2 equals +100)	0x79 (121) 1 to 40 0x0F (15)	21015	uint RWE
W.P1 W.P1	<i>Step Type Parameters</i> Wait For Process 1 When Step Type is Wait for Process or Wait For Both, enter wait for process value on analog input specified by Wait For Process Instance before proceeding in profile.	-1,999.000 to 9,999.000° F or units -1,128.000 to 5,537.000° C	0.0° F or units -18.0° C	<i>Instance 1</i> Map 1 Map 2 2590 4520 Offset to next in- stance (Map 1 equals +50, Map 2 equals +100)	0x79 (121) 1 to 40 0x0B (11)	21011	float RWE
Note: Some values will be rounded off to fit in the four-character display. Full values can be read with other interfaces. ** R: Read, W: Write, E: EEPROM, S: User Set							

Profiling Page							
Display	Parameter Name Description	Range	Default	Modbus Relative Address	CIP Class Instance Attribute hex (dec)	Pa- ram- eter ID	Data Type and Access **
<i>UUE.1</i> WE.1	<p>Step Type Parameters Wait Event 1 When Step Type is Wait for Event or Wait For Both, select the event state that must be satisfied during this step.</p> <p>Note: Wait Event 1 can be mapped to any available digital input (5 - 12). Navigate to the Setup Page under the Global Menu to find and modify Source Instance A <i>S.1A</i> (Event 1) and Source Instance B <i>S.1B</i> (Event 2).</p>	<p><i>oFF</i> Off (62) <i>oN</i> On (63) <i>nonE</i> None (61)</p>	Off	<p><i>Instance 1</i> Map 1 Map 2 2586 4516</p> <p>Offset to next in-stance (Map 1 equals +50, Map 2 equals +100)</p>	0x79 (121) 1 to 10 9	21009	uint RWE
<i>UUE.2</i> WE.2	<p>Step Type Parameters Wait Event 2 When Step Type is Wait for Event or Wait For Both, select the event state that must be satisfied during this step.</p> <p>Note: Wait Event 2 can be mapped to any available digital input (5 - 12). Navigate to the Setup Page under the Global Menu to find and modify Source Instance A <i>S.1A</i> (Event 1) and Source Instance B <i>S.1B</i> (Event 2).</p>	<p><i>oFF</i> Off (62) <i>oN</i> On (63) <i>nonE</i> None (61)</p>	Off	<p><i>Instance 1</i> Map 1 Map 2 2588 4518</p> <p>Offset to next in-stance (Map 1 equals +50, Map 2 equals +100)</p>	0x79 (121) 1 to 40 0xA (10)	21010	uint RWE
<i>doUd</i> doW	<p>Step Type Parameters Day of Week When Step Type is Wait for Time, the profile waits until this Day of Week along with Hours, Minutes and Seconds time of day is met.</p>	<p><i>Ed</i> Every Day (1567) <i>Ud</i> Week days (1566) <i>Sun</i> Sunday (1565) <i>MoN</i> Monday (1559) <i>TuE</i> Tuesday (1560) <i>WEd</i> Wednesday (1561) <i>ThUr</i> Thursday (1562) <i>Fr ,</i> Friday (1563) <i>SAT</i> Saturday (1564)</p>	Sunday	<p><i>Instance 1</i> Map 1 Map 2 - - - - 4580</p> <p>Offset to next in-stance Map 2 equals +100)</p>	0x79 (121) 1 to 40 0x29 (41)	21041	uint RWE
<p>Note: Some values will be rounded off to fit in the four-character display. Full values can be read with other interfaces. ** R: Read, W: Write, E: EEPROM, S: User Set</p>							

Profiling Page							
Display	Parameter Name Description	Range	Default	Modbus Relative Address	CIP Class Instance Attribute hex (dec)	Pa- ram- eter ID	Data Type and Access **
JS JS	<i>Step Type Parameters</i> Jump Step When Step Type is Jump, this specifies which step to jump back to. Jump Step must be a lower step number than the current step number.	1 to 40	0	<i>Instance 1</i> Map 1 Map 2 2592 4522 Offset to next in-stance (Map 1 equals +50, Map 2 equals +100)	0x79 (121) 1 to 40 0xC (12)	21012	uint RWE
JC JC	<i>Step Type Parameters</i> Jump Count When Step Type is Jump, this specifies the number of jumps to repeat. A value of 0 creates an infinite loop. Loops can be nested four deep.	0 to 9,999	0	<i>Instance 1</i> Map 1 Map 2 2594 4524 Offset to next in-stance (Map 1 equals +50, Map 2 equals +100)	0x79 (121) 1 to 40 0xD (13)	21013	uint RWE
End End	<i>Step Type Parameters</i> End Type When Step Type is End, this specifies what the controller will do when this profile ends.	OFF Control Mode set to Off (62) Hold Hold last closed-loop set point in the profile (47) USER User, reverts to previous set point (100)	Off	<i>Instance 1</i> Map 1 Map 2 2596 4526 Offset to next in-stance (Map 1 equals +50, Map 2 equals +100)	0x79 (121) 1 to 40 0xE (14)	21014	uint RWE
Ent 1 Ent1	<i>Step Type Parameters</i> Event 1 When Step Type is not Unused Step, select whether Event Output 1 or 2 is on or off during this step.	OFF Off (62) ON On (63)	Off	<i>Instance 1</i> Map 1 Map 2 2582 4512 Offset to next in-stance (Map 1 equals +50, Map 2 equals +100)	0x79 (121) 1 to 40 7	21007	uint RWE
Note: Some values will be rounded off to fit in the four-character display. Full values can be read with other interfaces. ** R: Read, W: Write, E: EEPROM, S: User Set							

Profiling Page							
Display	Parameter Name Description	Range	Default	Modbus Relative Address	CIP Class Instance Attribute hex (dec)	Pa- ram- eter ID	Data Type and Access **
Ent2 Ent2	<i>Step Type Parameters</i> Event 2 When Step Type is not Un- used Step, select whether Event Output 1 or 2 is on or off during this step.	oFF Off (62) oN On (63)	Off	<i>Instance 1</i> Map 1 Map 2 2584 4514 Offset to next in- stance (Map 1 equals +50, Map 2 equals +100)	0x79 (121) 1 to 40 8	21008	uint RWE
<p>Note: Some values will be rounded off to fit in the four-character display. Full values can be read with other inter- faces. ** R: Read, W: Write, E: EEPROM, S: User Set</p>							

Display	Step Type Description	Parameters in Step Type
USStP USStP	<i>Step Types</i> Unused Step This is an empty step that can be used to plan for future steps to be inserted or temporarily deactivate a step in a profile. Change step type back when the step should be active again.	- - - -
ti ti	<i>Step Types</i> Time If Ramping Type found in the Global Menu of the Setup Page is set for Time, the control loop will follow set point over the specified time. If two loops of control are present then they will both follow independent set points over the specified time. The state of up to 2 event outputs may be set or maintained.	t951 Target Set Point Loop 1 t952 Target Set Point Loop 2 hoUr Hours mIn Minutes SEC Seconds Ent1 Event 1 Ent2 Event 2
rAtE rAtE	<i>Step Types</i> Rate If Ramping Type found in the Global Menu of the Setup Page is set for Rate, specify the rate of change in degrees or units per minute. The state of up to 2 event outputs may be set or main- tained.	t951 Target Set Point Loop 1 t952 Target Set Point Loop 2 rAtE Rate Ent1 Event 1 Ent2 Event 2
SoAh SoAh	<i>Step Types</i> Soak A Soak Step maintains the last Target Set Points for the desig- nated time. The state of up to 2 event outputs may be set or maintained.	hoUr Hours mIn Minutes SEC Seconds Ent1 Event 1 Ent2 Event 2
CLoC CLoC	<i>Step Types</i> Wait For Time A Wait for Time Step is available with the real-time calendar clock feature. This allows the program to wait for a specified day and time before proceeding to the next step. Used to have the profile execute steps everyday or only weekdays. The state of up to 2 event outputs may be set or maintained.	hoUr Hours mIn Minutes SEC Seconds doWd Day of Week Ent1 Event 1 Ent2 Event 2













Display	Step Type Description	Parameters in Step Type
WJE W.E	<i>Step Types</i> Wait For Event A Wait for Event Step will wait for the two Wait for Event states (1 to 2) to match the specified state. The state of up to 2 event outputs may be set or maintained.	WJE.1 Wait Event 1 WJE.2 Wait Event 2 Ent.1 Event 1 Ent.2 Event 2
WJPr W.Pr	<i>Step Types</i> Wait For Process A Wait for Process Step will wait for Process Value 1 or 2 to match the Wait for Process Value. The state of up to 2 event outputs may be set or maintained.	WJP.1 Wait for Process 1 WJP.2 Wait for Process 2 Ent.1 Event 1 Ent.2 Event 2
WJbo W.bo	<i>Step Types</i> Wait For Both A Wait For Process and Event Step will wait for Process Value 1 or 2 to match the Wait for Process 1 value, and/or the two Wait Event states to match the specified state. The state of up to 2 event outputs may be set or maintained.	WJP.1 Wait for Process 1 WJP.2 Wait for Process 2 WJE.1 Wait Event 1 WJE.2 Wait Event 2 Ent.1 Event 1 Ent.2 Event 2
JL JL	<i>Step Types</i> Jump A Jump step will repeat previous steps a number of times designated in Jump Count. Jumps can be nested up to four deep. The state of up to 2 event outputs may be set or maintained.	JS Jump Step JC Jump Count Ent.1 Event 1 Ent.2 Event 2
End End	<i>Step Types</i> End An End Step will end the profile and set the control modes and set points to match the End Type. The state of up to 2 event outputs may be set or maintained. The event outputs will not be set off unless specifically stated in this step. If a profile does not have an End Step, the profile continues until step 40, then stops and maintains the last set points and control modes.	End End Type Ent.1 Event 1 Ent.2 Event 2

8

Chapter 8: Factory Page

Navigating the Factory Page

To navigate to the Factory Page follow the steps below:

1. From the Home Page, press and hold both the Advance  and Infinity  keys for six seconds.
2. Press the Up  or Down  key to view available menus.
3. Press the Advance Key  to enter the menu of choice.
4. If a submenu exists (more than one instance), press the Up  or Down  key to select and then press the Advance Key  to enter.
5. Press the Up  or Down  key to move through available menu prompts.
6. Press the Infinity Key  to move backwards through the levels: parameter to submenu, submenu to menu, menu to Home Page.
7. Press and hold the Infinity Key  for two seconds to return to the Home Page.

On the following pages, top level menus are identified with a yellow background color.

Note:

Some of these menus and parameters may not appear, depending on the controller's options. See model number information in the Appendix for more information. If there is only one instance of a menu, no submenus will appear.

Note:

Some of the listed parameters may not be visible. Parameter visibility is dependent upon controller part number.

CUSE

FCTY Custom Setup Menu

I

CUSE Custom Setup (1 to 20)

PAR Parameter

ID Instance ID

LoC

FCTY Security Setting Menu

LoCo Operations Page

LoCP Profiling Page

PASE Password Enabled

rLoC Read Lock

SLoC Write Security

LoCL Locked Access Level

roLL Rolling Password

PA5u User Password

PA5A Administrator Password

ULoC

FCTY Security Setting Menu

Code Public Key

PA55 Password

dIAG

FCTY Diagnostics Menu

Pn Part Number

rEu Software Revision

SbLd Software Build Number

Sn Serial Number

dATE Date of Manufacture

iPAC IP Actual Address Mode

iPA1 IP Actual Address Part 1

iPA2 IP Actual Address Part 2

.PA3 IP Actual Address Part 3

.PA4 IP Actual Address Part 4

.PA5 IP Actual Address Part 5

.PA6 IP Actual Address Part 6

CAL

FCTY Calibration Menu

!

CAL Calibration (1 to 2)

PMU Electrical Measurement

EL .0 Electrical Input Offset

EL .5 Electrical Input Slope

EL 0.0 Electrical Output Offset

EL 0.5 Electrical Output Slope

Pn Part Number

Code Code

Factory Page

Display	Parameter Name Description	Range	Default	Modbus Relative Address	CIP Class Instance Attribute hex (dec)	Pro-fibus Index	Parameter ID	Data Type and Access **
<p>CuSt FcTy Custom</p>								
PAR Par	<p><i>Custom</i> Parameter 1 to 20</p> <p>Select the parameters that will appear in the Home Page.</p> <p>The Parameter 1 value will appear in the upper display of the Home Page. It cannot be changed with the Up and Down Keys in the Home Page.</p> <p>The Parameter 2 value will appear in the lower display in the Home Page. It can be changed with the Up and Down Keys, if the parameter is a writable one.</p> <p>Scroll through the other Home Page parameters with the Advance Key .</p> <p>Note: Display Pairs affect the pairing of custom parameters on the Home page. For more information on Display Pairs see the section in this guide entitled "Modifying the Display Pairs".</p>	<p><i>none</i> None <i>LhY</i> Limit Hysteresis <i>LhS</i> High Limit Set Point <i>LlS</i> Low Limit Set Point <i>CUr</i> Load Current RMS <i>Pro</i> Process <i>oCR</i> Calibration Offset <i>E_F</i> Display Units <i>USrr</i> Replace Settings From <i>ALo</i> Low Set Point <i>Rh i</i> High Set Point <i>RhY</i> Hysteresis <i>CuSt</i> Custom Menu <i>StPt</i> Set Point <i>ACPu</i> Active Process Value <i>ACSP</i> Active Set Point <i>oP</i> Manual Power <i>Aut</i> Autotune <i>CPM</i> Control Mode <i>hPr</i> Heat Power <i>CPr</i> Cool Power <i>t i</i> Time Integral <i>td</i> Time Derivative <i>db</i> Dead Band <i>hPb</i> Heat Proportional Band <i>hhY</i> On/Off Heat Hysteresis <i>CPb</i> Cool Proportional Band <i>ChY</i> On/Off Cool Hysteresis <i>r.r.t</i> Ramp Rate <i>t.tUn</i> TRU-TUNE+® Enable <i>idle</i> Idle Set Point <i>PSt</i> Profile Start <i>PACr</i> Profile Action Request <i>StP</i> Current Step <i>StYP</i> Step Type <i>tSP1</i> Target Set Point Loop 1 <i>tSP2</i> Target Set Point Loop 2 <i>hoUr</i> Hours <i>Pm in</i> Minutes <i>SEC</i> Seconds <i>gSd1</i> Guaranteed Soak Deviation 1 <i>gSd2</i> Guaranteed Soak Deviation 2 <i>Ent1</i> Event 1 <i>Ent2</i> Event 2 <i>JC</i> Jump Count Remaining <i>CuSt</i> Custom Menu</p>	See: Home Page	- - - -	- - - -	- - - -	14005	uint RWES
<p>** R: Read, W: Write, E: EEPROM, S: User Set</p>								

Factory Page

Display	Parameter Name Description	Range	Default	Modbus Relative Address	CIP Class Instance Attribute hex (dec)	Pro-fibus Index	Parameter ID	Data Type and Access **
iid	<i>Custom (1 to 20)</i> Instance ID Select which instance of the parameter will be selected.	1 to 4		- - - -	- - - -	- - - -	14003	uint RWES
LoC FCTY Lock Menu								
LoC.o	<i>Security Setting</i> Operations Page Change the security level of the Operations Page.	1 to 3	2	<i>Instance 1</i> Map 1 Map 2 1832 2302	0x67 (103) 1 2	- - - -	3002	uint RWE
LoC.P	<i>Security Setting</i> Profiling Page Change the security level of the Profiling Page.	1 to 3	3	<i>Instance 1</i> Map 1 Map 2 1844 2314	0x67 (103) 1 8	- - - -	3008	uint RWE
LoC.P	<i>Security Setting</i> Password Enable Set to On to require a password for menu changes.	oFF Off oN On	Off	- - - -	- - - -	- - - -	3009	uint RWE
rLoC	<i>Security Setting</i> Read Lock Set the read security clearance level. The user can access the selected level and all lower levels. If the Set Lockout Security level is higher than the Read Lockout Security, the Read Lockout Security level takes priority.	1 to 5	5	<i>Instance 1</i> Map 1 Map 2 1848 2318	0x67 (103) 1 0x0A (10)	- - - -	3010	uint RWE
** R: Read, W: Write, E: EEPROM, S: User Set								

Factory Page

Display	Parameter Name Description	Range	Default	Modbus Relative Ad- dress	CIP Class Instance Attribute hex (dec)	Pro- fibus Index	Param- eter ID	Data Type and Access **
SLoC SLoC	<i>Security Setting</i> Write Security Set the write security clearance level. The user can access the selected level and all lower levels. If the Set Lockout Security level is higher than the Read Lockout Security, the Read Lockout Security level takes priority.	0 to 5	5	<i>Instance 1</i> Map 1 Map 2 1844 2314	0x67 (103) 1 0x0B (11)	- - - -	3011	uint RWE
LoCL LoC.L	<i>Security Setting</i> Locked Access Level Determines user level menu visibility when Password Enable is set to on. See Features section under Password Security.	1 to 5	5	- - - -	- - - -	- - - -	3016	uint RWE
roLL roLL	<i>Security Setting</i> Rolling Password When power is cycled a new Public Key will be displayed and User Password changes.	oFF Off oN On	Off	- - - -	- - - -	- - - -	3019	uint RWE
PAS.u PAS.u	<i>Security Setting</i> User Password Used to acquire access to menus made available through the Locked Access Level setting.	10 to 999	63	- - - -	- - - -	- - - -	3017	uint RWE

** R: Read, W: Write, E: EEPROM, S: User Set

Factory Page

Display	Parameter Name Description	Range	Default	Modbus Relative Address	CIP Class Instance Attribute hex (dec)	Pro-fibus Index	Parameter ID	Data Type and Access **
<i>PAS.A</i> PAS.A	<i>Security Setting</i> Administrator Password Used to acquire full access to all menus including disabling or changing passwords.	10 to 999	156	- - - -	- - - -	- - - -	3018	uint RWE
<i>ULoC</i> <i>FctY</i> Unlock Menu								
<i>Code</i> Code	<i>Security Setting</i> Public Key If Rolling Password turned on, generates a random number when power is cycled. If Rolling Password is off fixed number will be displayed. The key can be used to gain access when password is not known.	Customer Specific	0	- - - -	- - - -	- - - -	3020	uint R
<i>PASS</i> PASS	<i>Security Setting</i> Password Enter the User or Administrator password to gain access. After valid password is supplied exit this menu and re-enter the Security Menu via the Factory Page.	-1999 to 9999	0	- - - -	- - - -	- - - -	3022	int RW
** R: Read, W: Write, E: EEPROM, S: User Set								

Factory Page

Display	Parameter Name Description	Range	Default	Modbus Relative Address	CIP Class Instance Attribute hex (dec)	Pro-fibus Index	Parameter ID	Data Type and Access **
<p>d .A9 FCT4 Diagnostics Menu</p>								
Pn Pn	<i>Diagnostics</i> Part Number Display this controller's part number.	15 characters	- - - -	- - - -	0x65 (101) 1 9	115	1009	string R
rEu rEu	<i>Diagnostics</i> Software Revision Display this controller's firmware revision number.	1 to 10	- - - -	<i>Instance 1</i> Map 1 Map 2 4 4	0x65 (101) 1 3	116	1003	string R
S.bLd S.bLd	<i>Diagnostics</i> Software Build Number Display the firmware build number.	0 to 2,147,483,647	- - - -	<i>Instance 1</i> Map 1 Map 2 8 8	0x65 (101) 1 5	- - - -	1005	dint R
Sn Sn	<i>Diagnostics</i> Serial Number Display the serial number.	0 to 2,147,483,647	- - - -	<i>Instance 1</i> Map 1 Map 2 12 12	0x65 (101) 1 0x20 (32)	- - - -	1032	string R
dAtE dAtE	<i>Diagnostics</i> Date of Manufacture Display the date code (YYWW). Where YY = year and WW= week.	0 to 2,147,483,647	- - - -	<i>Instance 1</i> Map 1 Map 2 14 14	0x65 (101) 1 8	- - - -	1008	dint R
No Display	<i>Diagnostics</i> Hardware ID Display the Hardware ID.	0 to 2,147,483,647	- - - -	<i>Instance 1</i> Map 1 Map 2 0 0	0x65 (101) 1 1	- - - -	1001	dint R
No Display	<i>Diagnostics</i> Firmware ID Display the Firmware ID.	0 to 2,147,483,647	- - - -	<i>Instance 1</i> Map 1 Map 2 2 2	0x65 (101) 1 2	- - - -	1002	dint R
** R: Read, W: Write, E: EEPROM, S: User Set								

Factory Page

Display	Parameter Name Description	Range	Default	Modbus Relative Address	CIP Class Instance Attribute hex (dec)	Pro-fibus Index	Parameter ID	Data Type and Access **
<i>i.P.AC</i> ip.AC	<i>Diagnostics</i> IP Address Mode Actual address mode (DHCP or Fixed).	<i>dhCP</i> DHCP (1281) <i>F.Add</i> Fixed Address (1284)	DHCP	- - - -	- - - -	- - - -	17038	R
<i>i.P.A1</i> ip.A1	<i>Diagnostics</i> IP Actual Address Part 1 Actual IP address of this module. Note: Although it appears as if this can be changed here this is a read only parameter. Go to Setup Page and then the Com Menu to change.	0 to 255	169	- - - -	- - - -	- - - -	17044	R
<i>i.P.A2</i> ip.A2	<i>Diagnostics</i> IP Actual Address Part 2 Actual IP address of this module. Note: Although it appears as if this can be changed here this is a read only parameter. Go to Setup Page and then the Com Menu to change.	0 to 255	254	- - - -	- - - -	- - - -	17045	R

** R: Read, W: Write, E: EEPROM, S: User Set

Factory Page

Display	Parameter Name Description	Range	Default	Modbus Relative Address	CIP Class Instance Attribute hex (dec)	Pro-fibus Index	Parameter ID	Data Type and Access **
IP.A3 ip.A3	<i>Diagnostics</i> IP Actual Address Part 3 Actual IP address of this module. Note: Although it appears as if this can be changed here this is a read only parameter. Go to Setup Page and then the Com Menu to change.	0 to 255	1	- - - -	- - - -	- - - -	17046	R
IP.A4 ip.A4	<i>Diagnostics</i> IP Actual Address Part 4 Actual IP address of this module. Note: Although it appears as if this can be changed here this is a read only parameter. Go to Setup Page and then the Com Menu to change.	0 to 255	1	- - - -	- - - -	- - - -	17047	R
<p>CAL FC.EY Calibration Menu</p>								
FC.EY Mv	<i>Calibration (1 to 2)</i> Electrical Measurement Read the raw electrical value for this input in the units corresponding to the Sensor Type (Setup Page, Analog Input Menu) setting.	-3.4e38 to 3.4e38		<i>Instance 1</i> Map 1 Map 2 400 400 <i>Instance 2</i> Map 1 Map 2 480 490	0x68 (104) 1 to 2 0x15 (21)	- - - -	4021	float R
<p>** R: Read, W: Write, E: EEPROM, S: User Set</p>								

Factory Page

Display	Parameter Name Description	Range	Default	Modbus Relative Address	CIP Class Instance Attribute hex (dec)	Pro-fibus Index	Parameter ID	Data Type and Access **
<i>EL₁₀</i> ELi.o	<i>Calibration (1 to 2)</i> Electrical Input Offset Change this value to calibrate the low end of the input range.	-1,999.000 to 9,999.000	0.0	<i>Instance 1</i> Map 1 Map 2 378 378 <i>Instance 2</i> Map 1 Map 2 458 468	0x68 (104) 1 to 2 0x0A (10)	-- --	4010	float RWES
<i>EL₁₅</i> ELi.S	<i>Calibration (1 to 2)</i> Electrical Input Slope Adjust this value to calibrate the slope of the input value.	-1,999.000 to 9,999.000	1.0	<i>Instance 1</i> Map 1 Map 2 380 380 <i>Instance 2</i> Map 1 Map 2 460 470	0x68 (104) 1 to 2 0xB (11)	-- --	4011	float RWES
<i>EL₀₀</i> ELo.o	<i>Calibration (1 or 3)</i> Electrical Output Offset Change this value to calibrate the low end of the output range.	-1,999.000 to 9,999.000	0.0	<i>Instance 1</i> Map 1 Map 2 728 848 <i>Instance 3</i> Map 1 Map 2 808 928	0x76 (118) 1 or 3 5	-- --	18005	float RWES
<i>EL₀₅</i> ELo.S	<i>Calibration (1 or 3)</i> Electrical Output Slope Adjust this value to calibrate the slope of the output value.	-1,999.000 to 9,999.000	1.0	<i>Instance 1</i> Map 1 Map 2 730 850 <i>Instance 3</i> Map 1 Map 2 810 930	0x76 (118) 1 or 3 6	-- --	18006	float RWES
<i>P_n</i> Pn	<i>Calibration (1 to 3)</i> Part Number Displays current setting for control model number.	<i>FcEtY</i> Factory <i>USEr</i> User	Factory	----	----	-- --	----	uint R

** R: Read, W: Write, E: EEPROM, S: User Set

Factory Page

Display	Parameter Name Description	Range	Default	Modbus Relative Ad- dress	CIP Class Instance Attri- bute hex (dec)	Pro- fibus Index	Param- eter ID	Data Type and Access **
<i>Code</i> CodE	<i>Calibration (1 to 3)</i> Public Key Changes the control to User or back to origi- nal model num- ber as shown on the side of the control.	<i>250</i> User Settings <i>606</i> Factory model num- ber	4999	- - - -	- - - -	- - - -	- - - -	uint RWES
** R: Read, W: Write, E: EEPROM, S: User Set								

9

Chapter 9: Features

Changing PM Integrated Model Number to PM Express	181
Saving and Restoring Settings	182
Tuning the PID Parameters	183
Autotune	183
Manual Tuning	184
Autotuning with TRU-TUNE+®	184
Inputs	185
Calibration Offset	185
Calibration	186
Filter Time Constant	188
Sensor Selection	188
Sensor Backup	188
Set Point Minimum and Maximum	188
Scale High and Scale Low	188
Range High and Range Low	189
Receiving a Remote Set Point	189
Ten Point Linearization	190
Outputs	190
Duplex	190
NO-ARC Relay	190
Retransmitting a Process Value or Set Point	191
Cool Output Curve	192
Resetting a Tripped Limit	192
Control Methods	193
Output Configuration	193
Auto (closed loop) and Manual (open loop) Control	193
On-Off Control	194
Proportional and (P) Control	195
Proportional and Integral (PI) Control	195
Proportional, Integral and Derivative (PID) Control	196
Dead Band	196
Variable Time Base	197
Single Set Point Ramping	198
Cascade Control	198
Compressor Control	198
Differential Control	199
Ratio Control	199
Duplex Control	199
Motorized Valve Control	199

9

Chapter 9: Features (cont.)

Timer Function	200
Setting up the timer function	200
Alarms	202
Process and Deviation Alarms	203
Set Points	203
Hysteresis	203
Latching	203
Silencing	204
Blocking	204
Current Sensing	204
Open and Shorted Load Circuit Detection	204
Open Loop Detection	205
Programming the EZ Key/s	205
Using Lockout and Password Security	206
Using Lockout Method 1 (Read and Set Lock)	206
Using Lockout Method 2 (Password Enable)	208
Modbus - Using Programmable Memory Blocks	210
CIP - Communications Capabilities	210
CIP Implicit Assemblies	211
PCCC - (Programmable Controller Communications Commands)	212
Profibus DP - (Decentralized Peripherals)	213
Software Configuration	213
Using EZ-ZONE Configurator Software	213

Changing PM Integrated Model Number to PM Express

EZ-ZONE PM firmware revisions of 13 and above allow the user to switch between a PM Integrated control to a PM Express. Switching to a PM Express eliminates the complexity of the advanced PM Integrated control by allowing the user to operate with a simplified menu structure.

Note:

When switching from an integrated control to an Express version, optional PM hardware (even though installed) and firmware features not available in a PM Express will no longer work. To see exactly what is impacted by this change, compare the chart below to the ordering information page in this document.

Controller			PM	-	A	A	A	B	A	A
EZ-ZONE® Integrated Controller	Changes to PM Express									
Red-green 7-segment displays										
Package Size										
No Change										
Primary Function										
C	PID Controller with Universal Input									
R	Changes to C									
B										
T										
J	PID Controller with Universal Input									
N	Changes to J									
E										
S	Custom Firmware									
Power Supply										
1	100 to 240V~ (ac)									
2	Changes to 1									
3	15 to 36V= (dc) and 24V~ (ac)									
4	Changes to 3									
Output 1 and 2 Hardware Options										
	Output 1	Output 2								
CA	Switched dc/open collector	None								
CH	Switched dc/open collector	NO-ARC 15 A power control								
CC	Switched dc/open collector	Switched dc								
CJ	Switched dc/open collector	Mechanical relay 5 A, form A								
CK	Switched dc/open collector	Solid-state relay 0.5 A, form A								
EA	Mechanical relay 5 A, form C	None								
EH	Mechanical relay 5 A, form C	NO-ARC 15 A power control								
EC	Mechanical relay 5 A, form C	Switched dc								
EJ	Mechanical relay 5 A, form C	Mechanical relay 5 A, form A								
EK	Mechanical relay 5 A, form C	Solid-state relay 0.5 A, form A								
FA	Universal process	None								
FC	Universal process	Switched dc (cannot use variable time base)								
FJ	Universal process	Mechanical relay 5 A, form A (cannot use variable time base)								
FK	Universal process	Solid-state relay 0.5 A, form A (cannot use variable time base)								
AK	None	Solid-state relay 0.5 A, form A								
KH	Solid-state relay 0.5 A, form A	NO-ARC 15 A power control								
KK	Solid-state relay 0.5 A, form A	Solid-state relay 0.5 A, form A								
Communications Options or Additional Digital I/O										
None										
<i>- Standard Bus EIA-485 always included - all models</i>										
Auxiliary Control Functions										
None										
Output 3 and 4 Hardware Options										
None										
Additional Options										
B	Changes to Express									
Custom Options										
AA	Standard EZ-ZONE face plate									
AB	EZ-ZONE logo and no Watlow name									
AC	No logo and no Watlow name									
AG	Conformal Coating									
12	Class 1, Div. 2 (Not available with Integrated Limit Controller or mechanical relay outputs)									

How to Change the Controller Model Number

1. Enter Factory Page **FCLY**, Calibration Menu **CAL** via front panel by pressing the Infinity **∞** or Reset Key and the Advance Key **➤** together or using EZ-ZONE Configurator software.
2. Once there, use the Advance Key **➤** to navigate to the Part Number **Pn** prompt. The top display will show factory **FCLY** indicating the factory model number as shown on the decal located on the side of the control is currently in effect.
3. Push the Advance Key **➤**, Public Key **CODE** prompt will be displayed and the number **4999** in the top display.
4. Using the up or down Arrow Keys enter **2501** and push the Advance Key **➤** to execute the change. The controller will reboot and the new controller model number is in effect. All previous settings are lost and the controller must be reprogrammed for the application. Be sure to label the controller with the new model number for future reference.

Note:

As noted above, when switching from a PM Standard to a PM Express version, optional hardware (even though installed) may no longer work. Also, all settings will be defaulted to the selected model when switched.

Note:

After switching the model number to a PM Express this document will no longer apply to the control. Click on the link that follows to acquire the latest version of the PM PID Express User's Guide. <http://www.watlow.com/en/Resources-And-Support/Technical-Library/User-Manuals>

Once there, simply enter express in the "Keyword" field to find the appropriate document.

How to Restore Original PM Factory Settings and Model Number

1. Enter Factory Page **FCLY**, Calibration Menu **CAL** via front panel by pressing the Infinity **∞** or Reset Key and the Advance Key **➤** together or using EZ-ZONE Configurator software.
2. Once there, use the Advance Key **➤** to navigate to the Part Number **Pn** prompt. The upper display will show user **USER** indicating the user's selected model number is currently in effect.
3. Push the Advance Key **➤** where the Public Key **CODE** prompt will appear in the lower display and the number **4999** in the upper display.
4. Using the up or down arrow keys enter **606** and push the Advance Key **➤** to execute the change. The controller will reboot and the new controller model number is in effect. All previous settings are lost and the controller must be reprogrammed for the application. Be sure to label the controller with the new model number for future reference.

Note:

When switching from a PM Express back to the original model number all original optional hardware will again be enabled for use (assuming all original hardware is still installed). Also, when executing this step the control will be factory defaulted back to the original model number (as shown on the side of the control) at zone address 1. This User's Guide would once again apply to this control.

Saving and Restoring Settings

Recording setup and operations parameter settings for future reference is very important. If you unintentionally change these, you will need to program the correct settings back into the controller to return the equipment to operational condition.

After you program the controller and verify proper operation, select Save Settings As **U5r.5** (Setup Page, Global Menu) to save the settings into either of two files (**SEt 1** or **SEt 2**) in the control memory.

Note:

Saving the settings overwrites any previously saved collection of settings. Be sure to document all the controller settings.

If the settings in the controller are altered a user can return the controller to one of three settings. If previously saved, **SEt 1** or **SEt 2** can be restored as well as the factory **Fcty** settings. Navigate to the Setup Page, Global Menu to find the Restore **U5r.r** prompt. A digital input or the Function Key can also be configured to restore parameters.

Note:

When restoring factory defaults, I/O assemblies for Modbus, DeviceNet, Profibus and Ethernet along with the zone address will be overwritten when restoring factory defaults.

Tuning the PID Parameters

Autotune

When an autotune is performed on the EZ-ZONE® PM, the set point is used to calculate the tuning set point.

For example, if the active set point is 200° and Autotune Set Point **ALSP** (Operations Page, Loop Menu) is set to 90 percent, the autotune function utilizes 180° for tuning. This is also how autotuning works in previous Watlow controllers. In addition, changing the active set point in previous controllers causes the autotune function to restart; where with the EZ-ZONE PM changing the set point after an autotune has been started has no affect.

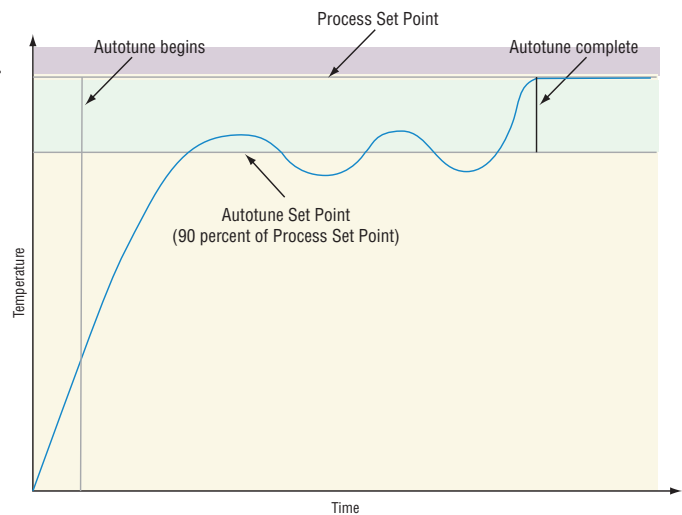

A new feature in EZ-ZONE PM products will allow set point changes while the control is autotuning, this includes while running a profile or ramping. When the auto tune is initially started it will use the current set point and will disregard all set point changes until the tuning process is complete. Once complete, the controller will then use the new set point. This is why it is a good idea to enter the active set point before initiating an autotune.

Autotuning calculates the optimum heating and/or cooling PID parameter settings based on the system's response. Autotuning can be enabled whether or not TUNE-TUNE+® is enabled. The PID settings generated by the autotune will be used until the autotune feature is rerun, the PID values are manually adjusted or TRU-TUNE+ is enabled.

To initiate an autotune, set Autotune Request **Aut** (Operations Page, Loop Menu) to **YES**. You should not autotune while a profile is running. If the autotune cannot be completed in 60 minutes, the autotune will time-out and the original settings will take effect.

Depending on which loops are being tuned the lower display may flash **tUn 1** or **tUn 2** and the set point while the autotuning is underway. The temperature must cross the Autotune Set Point five times to complete the autotuning process. Once complete, the controller controls

at the normal set point, using the new parameters.

Select a set point for the tune with Autotune Set Point. The Autotune Set Point is expressed as a percent of the Set Point.

If you need to adjust the tuning procedure's aggressiveness, use Autotune Aggressiveness tAggr (Setup Page, Loop Menu). Select Under Damped Undr to bring the process value to the set point quickly. Select over damped ouEr to bring the process value to the set point with minimal overshoot. Select critical damped Cr t to balance a rapid response with minimal overshoot.

Manual Tuning

In some applications, the autotune process may not provide PID parameters for the process characteristics you desire. If that is the case, you may want to tune the controller manually.

1. Apply power to the controller and establish a set point typically used in your process.
2. Go to the Operations Page, Loop Menu, and set Heat Proportional Band hPb and/or Cool Proportional Band cPb to 5. Set Time Integral tI to 0. Set Time Derivative tD to 0.
3. When the system stabilizes, watch the process value. If it fluctuates, increase the Heat Proportional Band or Cool Proportional Band value in 3 to 5° increments until it stabilizes, allowing time for the system to settle between adjustments.
4. When the process has stabilized, watch Heat Power hPr or Cool Power cPr (Operations Page, Monitor Menu). It should be stable $\pm 2\%$. At this point, the process temperature should also be stable, but it will have stabilized before reaching the set point. The difference between the set point and actual process value can be eliminated with Integral.
5. Start with an Integral value of 6,000 and allow 10 minutes for the process temperature to reach the set point. If it has not, reduce the setting by half and wait another 10 minutes. Continue reducing the setting by half every 10 minutes until the process value equals the set point. If the process becomes unstable, the Integral value is too small. Increase the value until the process stabilizes.
6. Increase Derivative to 0.1. Then increase the set point by 11° to 17°C. Monitor the system's approach to the set point. If the process value overshoots the set point, increase Derivative to 0.2. Increase the set point by 11° to 17°C and watch the approach to the new set point. If you increase Derivative too much, the approach to the set point will be very sluggish. Repeat as necessary until the system rises to the new set point without overshoot or sluggishness.

For additional information about autotune and PID control, see related features in this chapter.

Autotuning with TRU-TUNE+®

The TRU-TUNE+ adaptive algorithm will optimize the controller's PID values to improve control of dynamic processes. TRU-TUNE+ monitors the Process Value and adjusts the control parameters automatically to keep your process at set point during set point and load changes. When the controller is in the adaptive control mode, it determines the appropriate output signal and, over time, adjusts control parameters to optimize responsiveness and stability. The TRU-TUNE+ feature does not function for on-off control.

The preferred and quickest method for tuning a loop is to establish initial control settings and continue with the adaptive mode to fine tune the settings. Setting a controller's control mode to tune starts this two-step tuning process. (See Autotuning in this chapter.) This predictive tune determines initial, rough settings for the PID parameters. Then the loop automatically switches to the adaptive mode which fine tunes the PID parameters.

Once the Process Value has been at set point for a suitable period (about 30 minutes for a fast process to roughly two hours for a slower process) and if no further tuning of the PID parameters is desired or needed, TRU-TUNE+™ may be turned off. However, keeping the controller in the adaptive mode allows it to automatically adjust to load changes and compensate for differing control characteristics at various set points for processes that are not entirely linear.

Once the PID parameters have been set by the TRU-TUNE+ adaptive algorithm, the process, if shut down for any reason, can be restarted in the adaptive control mode. Turn TRU-TUNE+ on or off with TRU-TUNE+ Enable **EEUn** (Setup Page, Loop Menu).

Use TRU-TUNE+ Band **EBnd** (Setup Page, Loop Menu) to set the range above and below the set point in which adaptive tuning will be active. Adjust this parameter only in the unlikely event that the controller is unable to stabilize at the set point with TRU-TUNE+ Band set to auto (0). This may occur with very fast processes. In that case, set TRU-TUNE+ Band to a large value, such as 100.

Use TRU-TUNE+ Gain **EGn** (Setup Page, Loop Menu) to adjust the responsiveness of the adaptive tuning calculations. Six settings range from 1, with the most aggressive response and most potential overshoot (highest gain), to 6, with the least aggressive response and least potential for overshoot (lowest gain). The default setting, 3, is recommended for loops with thermocouple feedback and moderate response and overshoot potential.

Before Tuning

Before autotuning, the controller hardware must be installed correctly, and these basic configuration parameters must be set:

- Sensor Type **SEn** (Setup Page, Analog Input Menu), and scaling, if required;
- Function **Fn** (Setup Page, Output Menu) and scaling, if required.

How to Autotune a Loop

1. Enter the desired set point or one that is in the middle of the expected range of set points that you want to tune for.
2. Initiate an autotune. (See Autotuning in this chapter.)

Note:

Enable TRU-TUNE+ only after autotune is complete. It should be disabled before autotune is initiated.

When autotuning is complete, the PID parameters should provide good control. As long as the loop is in the adaptive control mode, TRU-TUNE+ continuously tunes to provide the best possible PID control for the process.

WARNING!

During autotuning, the controller sets the output to 100 percent and attempts to drive the Process Value toward the set point. Enter a set point and heat and cool power limits that are within the safe operating limits of your system.

Inputs

Calibration Offset

Calibration offset allows a device to compensate for an inaccurate sensor, lead resistance or other factors that affect the input value. A positive offset increases the input value, and a negative offset decreases the input value. The input offset value can be viewed or changed with Calibration Offset **ICR** (Operations Page, Analog Input Menu).

Calibration

Before performing any calibration procedure, verify that the displayed readings are not within published specifications by inputting a known value from a precision source to the analog input. Next, subtract the displayed value with the known value and compare this difference to the published accuracy range specification for that type of input.

Use of the Calibration Offset `.CR` parameter found in the Operations Page `OPER`, Analog Input Menu `R`, shifts the readings across the entire displayed range by the offset value. Use this parameter to compensate for sensor error or sensor placement error. Typically this value is set to zero.

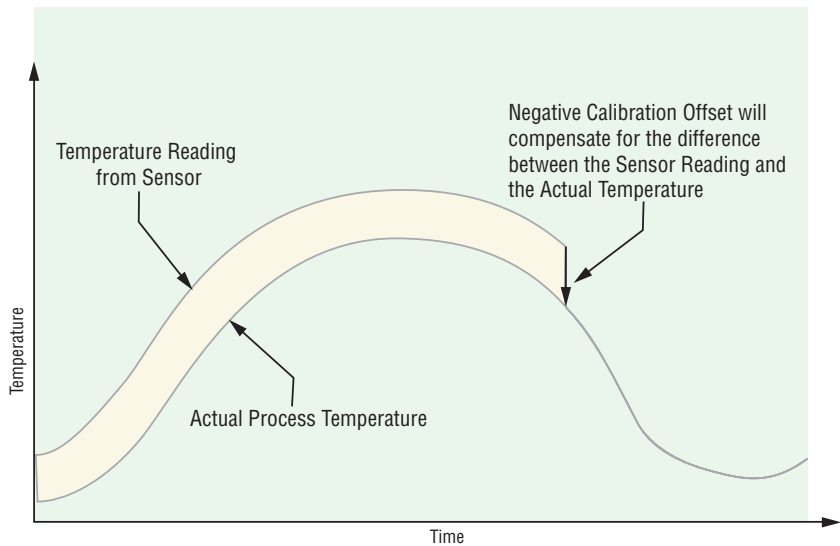

Equipment required while performing calibration:

Obtain a precision source for millivolts, volts, milliamperes or resistance depending on the sensor type to be calibrated. Use copper wire only to connect the precision source to the controller's input. Keep leads between the precision source and controller as short as possible to minimize error. In addition, a precision volt/ohm meter capable of reading values to 4 decimal places or better is recommended. Prior to calibration, connect this volt/ohm meter to the precision source to verify accuracy. Actual input values do NOT have to be exactly the recommended values, but it IS critical that the actual value of the signal connected to the controller be accurately known to at least four digits.

Calibration of Analog Inputs:

To calibrate an analog input, you will need to provide a source of two electrical signals or resistance values near the extremes of the range that the application is likely to utilize. See recommended values below:

Sensor Type	Precision Source Low	Precision Source High
thermocouple	0.000 mV	50.000 mV
millivolts	0.000 mV	50.000 mV
volts	0.000V	10.000V
milliamps	0.000 mA	20.000 mA
100 Ω RTD	50.00 Ω	350.0 Ω
1,000 Ω RTD	500.0 Ω	3,500 Ω
thermistor 5 kΩ	50.00	5,000
thermistor 10 kΩ	150.0	10,000
thermistor 20 kΩ	1,800	20,000
thermistor 40 kΩ	1,700	40,000
potentiometer	0.000	1,200

Note:

The user may only calibrate one sensor type. If the calibrator interferes with open thermocouple detection, set Sensor Type SE_n in Setup Page SEt , Analog Input Menu A_i to millivolt $P7_u$ instead of Thermocouple tC to avoid interference between the calibrator and open thermocouple detect circuit for the duration of the calibration process. Be sure to set sensor type back to the thermocouple type utilized.

1. Disconnect the sensor from the controller.
 2. Record the Calibration Offset iCR parameter value in the Operations Page $oPEr$, Analog Input Menu A_i , then set value to zero.
 3. Wire the precision source to the appropriate controller input terminals to be calibrated. Do not have any other wires connected to the input terminals. Please refer to the Install and Wiring section of this manual for the appropriate connections.
 4. Ensure the controller sensor type is programmed to the appropriate Sensor Type SE_n to be utilized in the Setup Page SEt , Analog Input Menu A_i .
 5. Enter Factory Page $FCEY$, Calibration Menu CAL via front panel or EZ-ZONE Configurator Software.
 6. Select the Calibration CAL input instance to be calibrated. This corresponds to the analog input to be calibrated.
 7. Set Electrical Input Slope EL_{iS} to 1.000 and Electrical Input Offset EL_{iO} to 0.000 (this will cancel any prior user calibration values)
 8. Input a Precision Source Low value. Read Electrical Measurement value $P7_u$ of controller via EZ-Configurator or RUI. This will be referred to as Electrical Measured Low. Record low value _____
 9. Input a Precision Source High value.
 10. Read Electrical Measurement value $P7_u$ of controller via EZ-Configurator or RUI. This will be referred to as Electrical Measured High. Record high value _____
 11. Calculated Electrical Input Slope = (Precision High - Precision Low) / (Electrical Measured High - Electrical Measured Low) Calculated Slope value _____
 12. Calculated Electrical Input Offset = Precision Low - (Electrical Input Slope * Measured Low) Calculated Offset value _____
 13. Enter the calculated Electrical Input Slope EL_{iS} and Electrical Input Offset EL_{iO} into the controller.
 14. Exit calibration menu.
 15. Validate calibration process by utilizing a calibrator to the analog input.
 16. Enter calibration offset as recorded in step 2 if required to compensate for sensor error.
- Setting Electrical Input Slope EL_{iS} to 1.000 and Electrical Input Offset EL_{iO} to 0.000, restores factory calibration as shipped from factory.

Filter Time Constant

Filtering smooths an input signal by applying a first-order filter time constant to the signal. Filtering the displayed value makes it easier to monitor. Filtering the signal may improve the performance of PID control in a noisy or very dynamic system.

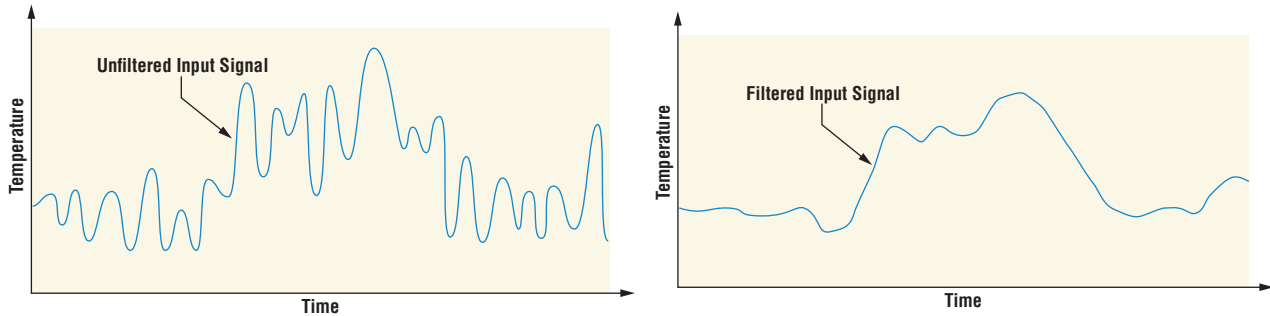

Adjust the filter time interval with Filter Time F_{iL} (Setup Page, Analog Input Menu). Example: With a filter value of 0.5 seconds, if the process input value instantly changes from 0 to 100 and remained at 100, the display will indicate 100 after five time constants of the filter value or 2.5 seconds.

Sensor Selection

You need to configure the controller to match the input device, which is normally a thermocouple, RTD or process transmitter.

Select the sensor type with Sensor Type SE_n (Setup Page, Analog Input Menu).

Sensor Backup

Sensor backup maintains closed-loop control after an input failure by switching control to input 2. The sensor backup feature is only available in an EZ-ZONE PM Integrated Limit or Remote Set Point controller. Turn sensor backup on or off with Sensor Backup Enable SB_A (Setup Page, Analog Input 1).

Note:

When Sensor Backup is enabled the Process Value function will automatically set itself to Sensor Backup.

Set Point Minimum and Maximum

The controller has the ability to restrict the Set Points for the following modes of operation:

- For *closed loop control* use Minimum Set Point and Maximum Set Point found in the Setup Page, Loop Menu.
- For *Manual Power (open loop control)* use Minimum Power and Maximum Power found in the Setup Page, Loop Menu.
- If a *Limit* is in use as part of an integrated control, set the Low Limit Set Point and High Limit Set point between the settings Minimum Set Point and Maximum Set Point in the Setup Page, Limit Menu.

Scale High and Scale Low

When an analog input is selected as process voltage or process current input, you must choose the value of voltage or current to be the low and high ends. For example, when using a 4 to 20 mA input, the scale low value would be 4.00 mA and the scale high value would be 20.00 mA. Commonly used scale ranges are: 0 to 20 mA, 4 to 20 mA, 0 to 5V, 1 to 5V and 0 to 10V.

You can create a scale range representing other units for special applications. You can reverse scales from high values to low values for analog input signals that have a reversed action. For example, if 50 psi causes a 4 mA signal and 10 psi causes a 20 mA signal.

Scale low and high low values do not have to match the bounds of the measurement range. These along with range low and high provide for process scaling and can include values not measurable by the controller. Regardless of scaling values, the measured value will be constrained by the electrical measurements of the hardware. Select the low and high values with Scale Low `S.L o` and Scale High `S.h i`. Select the displayed range with Range Low `r.L o` and Range High `r.h i` (Setup Page, Analog Input Menu).

Range High and Range Low

With a process input, you must choose a value to represent the low and high ends of the current or voltage range. Choosing these values allows the controller's display to be scaled into the actual working units of measurement. For example, the analog input from a humidity transmitter could represent 0 to 100 percent relative humidity as a process signal of 4 to 20 mA. Low scale would be set to 0 to represent 4 mA and high scale set to 100 to represent 20 mA. The indication on the display would then represent percent humidity and range from 0 to 100 percent with an input of 4 to 20 mA. Select the low and high values with Range Low `r.L o` and Range High `r.h i` (Setup Page, Analog Input Menu).

Receiving a Remote Set Point

The remote set point feature allows the controller to use a thermocouple, RTD, 1 k potentiometer or process signal at input 2 to establish the set point, which allows its set point to be manipulated by an external source. A common application would use one ramping controller with a set-point retransmit output to ramp multiple controllers using the remote set point. Or you could use an analog output from a PLC to send set point values to an EZ-ZONE PM. The controller must have two process inputs to use the remote set point feature. You may select between local and remote set points at the front panel, with an event input, from a remote computer using the communications feature or from an external switch using an event input. Make sure all input and output impedances are compatible.

1. Switch to the Remote Set Point with Remote Enable `r.En` (Operations Page, Loop Menu).
Select whether the remote set point controls Manual Power or Set Point with Remote Set Point Type `r.t y`.
2. Assign the function of switching to a remote set point to a digital input with Digital Input Function `F n` (Setup Page, Digital Input Menu).
3. Assign the function of switching to a remote set point to the EZ Key with Digital Input Function `F n` (Setup Page, Function Key Menu).

Ten Point Linearization

The linearization function allows a user to re-linearize a value read from an analog input. There are 10 data points used to compensate for differences between the sensor value read (input point) and the desired value (output point). Multiple data points enable compensation for non-linear differences between the sensor readings and target process values over the thermal or process system operating range. Sensor reading differences can be caused by sensor placement, tolerances, an inaccurate sensor or lead resistance.

The user specifies the unit of measurement and then each data point by entering an input point value and a corresponding output point value. Each data point must be incrementally higher than the previous point. The linearization function will interpolate data points linearly in between specified data points.

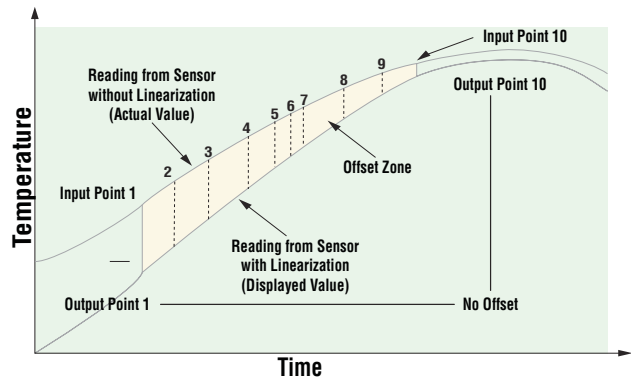

Note:

Output Point 1 will be the minimum value that can be displayed, and Output Point 10 will be the maximum value that can be displayed. Consider setting Output Point 1 to the minimum operating range, and Output Point 10 to the maximum operating range; for that sensor type.

Outputs

Duplex

Certain systems require that a single process output, control both heating and cooling outputs. An EZ-ZONE® PM controller with a process output can function as two separate outputs. With a 4 to 20mA output the heating output will operate from 12 to 20mA (0 to +100 percent) and the cooling output will operate from 12 to 4mA (0 to -100 percent).

In some cases this type of output is required by the device that the EZ-ZONE PM controls, such as a three-way valve that opens one way with a 12 to 20mA signal and opens the other way with a 4 to 12mA signal. This feature reduces the overall system cost by using a single output to act as two outputs.

Outputs 1 and 3 can be ordered as process outputs. Select duplex *DUPL* as the Output Function *F_n* (Setup Page, Output Menu). Set the output to volts *volt* or milliamps *mA* with Type *act*. Set the range of the process output with Scale Low *SLo* and Scale High *Shi*.

NO-ARC Relay

A NO-ARC relay provides a significant improvement in the life of the output relay over conventional relays. Conventional mechanical relays have an expected life of 100,000 cycles at the rated full-load current. The shorter life for conventional relays is due to the fact that when contacts open while current is flowing metal degradation occurs. This action produces unavoidable electrical arcing causing metal to transfer from one contact to the other. The arcing conditions continue on each subsequent contact opening until over time the resistance through the contacts increases causing the contacts to increase in temperature. Eventually, the contacts will weld together and the relay remains in the on state.

The Watlow NO-ARC relay is a hybrid relay. It uses a mechanical relay for the current load and a triac (solid-state switch) to carry the turn-on and turn-off currents. NO-ARC relays extend the life of the relay more than two million cycles at the rated full-load current. Although a NO-ARC relay has significant life advantages, a few precautions must be followed for acceptable usage:

Do not use:

- Hybrid relays for limit contactors. A limit or safety device must provide a positive mechanical break on all hot legs simultaneously
- DC loads with hybrid relays. The triacs used for arc suppression will turn off only with ac line voltage
- Hybrid switches to drive any inductive loads, such as relay coils, transformers or solenoids
- Cycle times less than five seconds on hybrid switches
- On loads that exceed 264V ac through relay
- On loads that exceed 15 amperes load
- On loads less than 100mA
- NO-ARC relays in series with other NO-ARC relays

Retransmitting a Process Value or Set Point

The retransmit feature allows a process output to provide an analog signal that represents the set point or process value. The signal may serve as a remote set point for another controller or as an input for a chart recorder documenting system performance over time.

In choosing the type of retransmit signal the operator must take into account the input impedance of the device to be retransmitted to and the required signal type, either voltage or milliamps. Typically applications might use the retransmit option to record one of the variables with a chart recorder or to generate a set point for other controls in a multi-zone application.

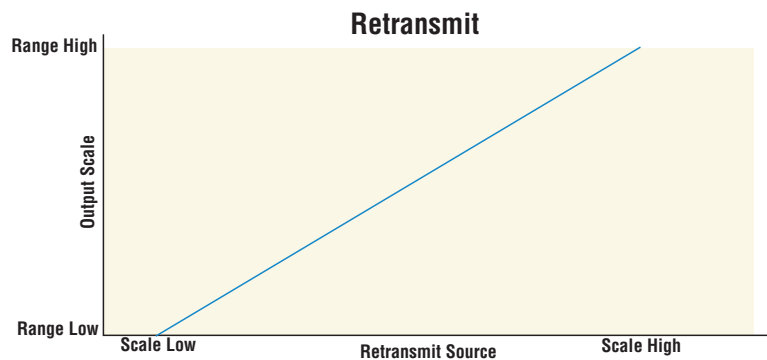

Outputs 1 and 3 can be ordered as process outputs. Select retransmit **r.r.t** as the Function **Fn** (Setup Page, Output Menu). Set the output to volts **v.o.l.t** or milliamps **r.m.a** with Type **a.t.y**. Select the signal to retransmit with Retransmit Source **r.s.r**. Set the range of the process output with Scale Low **s.l.o** and Scale High **s.h.i**. Scale the retransmit source to the process output with Range Low **r.l.o** and Range High **r.h.i**.

When the retransmit source is at the Range Low value, the retransmit output will be at its Scale Low value. When the retransmit source is at the Range High value, the retransmit output will be at its Scale High value.

Cool Output Curve

A nonlinear output curve may improve performance when the response of the output device is nonlinear. If a cool output uses one of the nonlinear curves a PID calculation yields a lower actual output level than a linear output would provide.

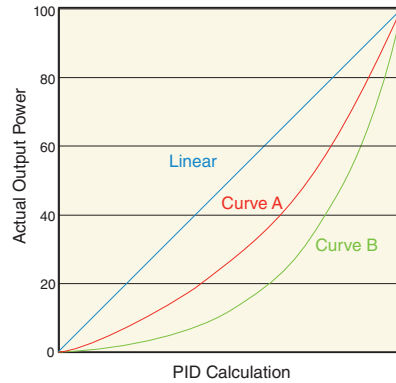

These output curves are used in plastics extruder applications: curve A for oil-cooled extruders and curve B for water-cooled extruders. Select a nonlinear cool output curve with Cool Output Curve `EEr` (Setup Menu, Loop Menu).



Resetting a Tripped Limit

When a limit controller is ordered (PM _____ - _ [L,M] _____) output 4 will always be a Form A (normally open) Mechanical Relay and it will always be internally tied to the limit function. When the limit is in a safe state the internal coil for this relay will be energized, therefore the relay will be closed. When a condition occurs that causes the limit to trip, the internal coil will de-energize causing the relay to latch open. When the condition that caused the limit to trip has been resolved, the relay will remain latched open until manually reset. The process to reset a latched limit can be different from control to control and is dependent upon the controller firmware version.

To check the firmware revision of your control do one of the following:

1. Cycle power to the control while observing the number in the top display (this momentary numerical display reflects the current installed firmware version).
2. Navigate to the Factory Page by simultaneously pushing and holding the Advance Key  and the Reset Key  for approximately 8 seconds and then use the up or down arrow key to navigate to the Diagnostic Menu. Once there, push the Advance Key  twice where the revision `rEu` will be shown in the lower display and the upper display will indicate the current firmware revision.

Execute One of the Following Steps to Reset a Tripped Limit Prior to Firmware Release 11.0:

1. Push the Reset Key .
2. Configure a digital input with the Action Function set to Limit Reset (navigate to the Setup Page under the Digital I/O Menu).
3. Use a field bus protocol, i.e., Modbus, EtherNet/IP, etc...where a value of zero would be written to the associated address (navigate to the Operations Page and look for Clear Limit under the Limit Menu to find appropriate address).
4. Cycle the power to the controller.

Execute One of the Following Steps to Reset a Tripped Limit with Firmware Release 11.0 and above:

1. Push the Reset Key 
2. Follow the steps below:
 - 2a. Navigate to the Setup Page and then the Limit Menu
 - 2b. Set Source Function A to the desired device that will reset the limit (Digital I/O or Function Key)
 - 2c. Define the Source Instance
3. Use a field bus protocol, i.e., Modbus, EtherNet/IP, etc...where a value of zero would be written to the associated address (navigate to the Operations Page and look for Clear Limit under the Limit Menu to find appropriate address).
4. Cycle the power to the controller.

Control Methods

Output Configuration

Each controller output can be configured as a heat output, a cool output, an alarm output or deactivated. No dependency limitations have been placed on the available combinations. The outputs can be configured in any combination. For instance, all three could be set to cool.

Heat and cool outputs use the set point and Operations parameters to determine the output value. All heat and cool outputs use the same set point value. Heat and cool each have their own set of control parameters. All heat outputs use the same set of heat control parameters and all cool outputs use the same set of cool output parameters.

Each alarm output has its own set of configuration parameters and set points, allowing independent operation.

Auto (closed loop) and Manual (open loop) Control

The controller has two basic modes of operation, auto mode and manual mode. Auto mode allows the controller to decide whether to perform closed-loop control or to follow the settings of Input Error Failure *FRIL* (Setup Page, Loop Menu). The manual mode only allows open-loop control. The EZ-ZONE® PM controller is normally used in the auto mode. The manual mode is usually only used for specialty applications or for troubleshooting.

Manual mode is open-loop control that allows the user to directly set the power level to the controller's output load. No adjustments of the output power level occur based on temperature or set point in this mode.

In auto mode, the controller monitors the input to determine if closed-loop control is possible. The controller checks to make certain a functioning sensor is providing a valid input signal. If a valid input signal is present, the controller will perform closed-loop control. Closed-loop control uses a process sensor to determine the difference between the process value and the set point. Then the controller applies power to a control output load to reduce that difference. If a valid input signal is not present, the controller will indicate an input error message in the upper display and *ALLEN* in the lower display and respond to the failure according to the setting of Input Error Failure *FRIL*. You can configure the controller to perform a bumpless transfer *bPLS*, switch power to output a preset fixed level *FRAN*, or turn the output power off.

Bumpless transfer will allow the controller to transfer to the manual mode using the last power value calculated in the auto mode if the process had stabilized at a ± 5 percent output power level for the time interval or 10 seconds, (whichever is longer) prior to sensor failure, and that power level is less than 75 percent.

Reverse Bumpless functionality will take effect when the control is changed from Manual to Auto mode. The control will preload the Manual Power value into the Integral and Proportional Terms, which will allow for a bumpless transition. The normal PID action will then take over to control the output to the Set Point value.

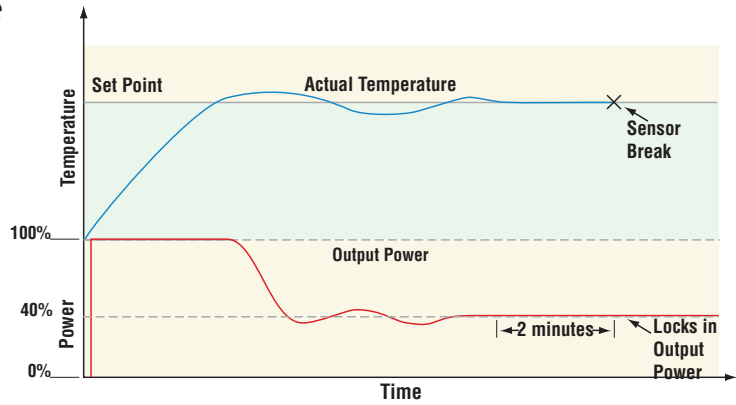

Note:

Reverse bumpless ignores the transition from Off to Auto.

Input Error Latching IER (Setup Page, Analog Input Menu) determines the controller’s response once a valid input signal returns to the controller. If latching is on, then the controller will continue to indicate an input error until the error is cleared. To clear a latched alarm, press the Advance Key ⏏ then the Up Key ▲ . If latching is off, the controller will automatically clear the input error and return to reading the temperature. If the controller was in the auto mode when the input error occurred, it will resume closed-loop control. If the controller was in manual mode when the error occurred, the controller will remain in open-loop control. The Manual Control Indicator Light % is on when the controller is operating in manual mode.

You can easily switch between modes if the Control Mode CM parameter is selected to appear in the Home Page.

To transfer to manual mode from auto mode:

1. Press the Advance Key ⏏ until CM appears in the lower display. The upper display will display AUTO for auto mode.
2. Use the Up ▲ or Down ▼ keys to select MAN . The manual set point value will be recalled from the last manual operation.

To transfer to auto mode from manual mode:

1. Press the Advance Key ⏏ until CM appears in the lower display. The upper display will display MAN for manual mode.
2. Use the Up ▲ or Down ▼ keys to select AUTO . The automatic set point value will be recalled from the last automatic operation.

Changes take effect after three seconds or immediately upon pressing either the Advance Key ⏏ or the Infinity Key ∞ .

On-Off Control

On-off control switches the output either full on or full off, depending on the input, set point and hysteresis values. The hysteresis value indicates the amount the process value must deviate from the set point to turn on the output. Increasing the value decreases the number of times the output will cycle. Decreasing hysteresis improves controllability. With hysteresis set to 0, the process value would stay closer to the set point, but the output would switch on and off more frequently, and may result in the output “chattering.” On-off

control can be selected with Heat Algorithm **hA9** or Cool Algorithm **C.A9** (Setup Page, Loop Menu). On-off hysteresis can be set with On/Off Heat Hysteresis **h.hY** or On/Off Cool Hysteresis **C.hY** (Operations Page, Loop Menu).

Note:

Input Error Failure Mode **FRIL** does not function in on-off control mode. The output goes off.

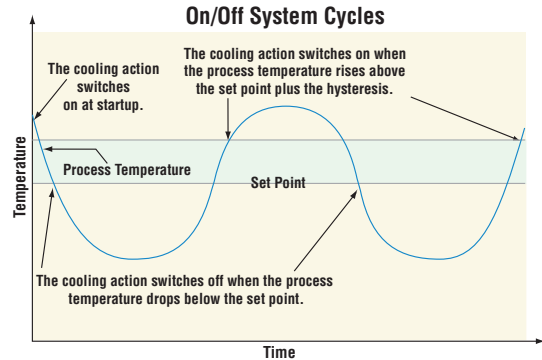
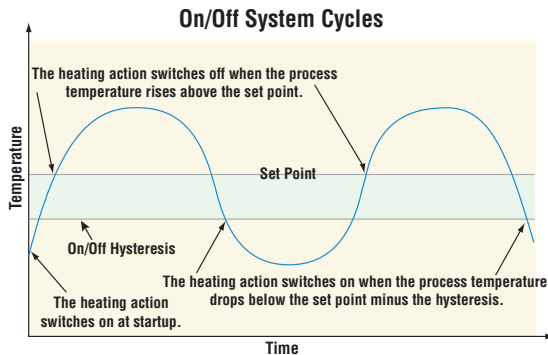

Proportional and (P) Control

Some processes need to maintain a temperature or process value closer to the set point than on-off control can provide. Proportional control provides closer control by adjusting the output when the temperature or process value is within a proportional band. When the value is in the band, the controller adjusts the output based on how close the process value is to the set point. The closer the process value is to the set point, the lower the output power.

This is similar to backing off on the gas pedal of a car as you approach a stop sign. It keeps the temperature or process value from swinging as widely as it would with simple on-off control. However, when the system settles down, the temperature or process value tends to “droop” short of the set point.

With proportional (P) control, the output power level equals the set point minus the process value divided by proportional band times 100.

In an application with one output assigned to heating and another assigned to cooling,

each will have a separate proportional parameter. The heating parameter takes effect when the process temperature is lower than the set point, and the cooling parameter takes effect when the process temperature is higher than the set point.

Adjust the proportional band with Heat Proportional Band **h.Pb** or Cool Proportional Band **C.Pb** (Operations Page, Loop Menu).

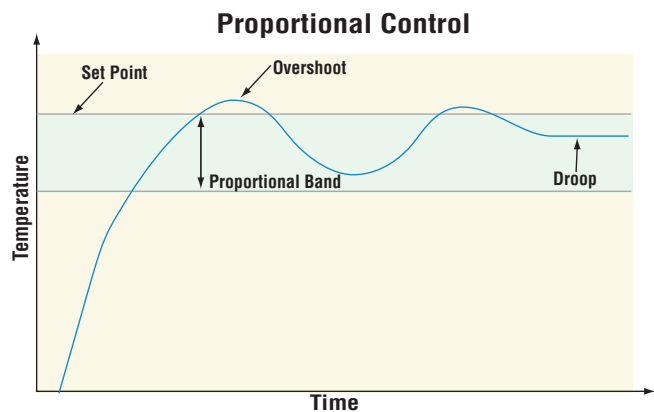

Proportional and Integral (PI) Control

The droop caused by proportional control can be corrected by adding integral (reset) control. When the system settles down, the integral value is tuned to bring the temperature or process value closer to the set point. Integral determines the speed of the correction, but this may increase the overshoot at startup or when the set point is changed. Too much integral action will make the system unstable. Adjust the integral with Time Integral **t.i** (Operations Page, Loop Menu).

Proportional, Integral and Derivative (PID) Control

Use derivative (rate) control to minimize the overshoot in a PI-controlled system. Derivative (rate) adjusts the output based on the rate of change in the temperature or process value. Too much derivative (rate) will make the system sluggish. Adjust the derivative with Time Derivative t_d (Operations Page, Loop Menu).

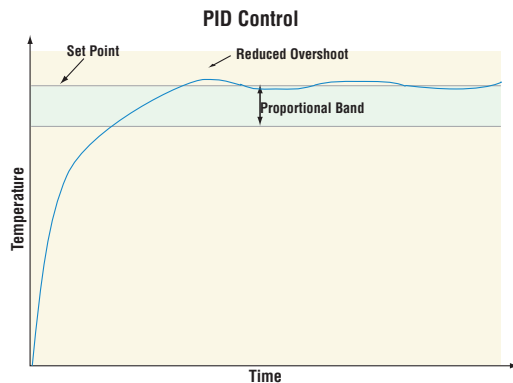

Dead Band

In a PID application the dead bands above and below the set point can save an application's energy and wear by maintaining process temperature within acceptable ranges.

Proportional action ceases when the process value is within the dead band. Integral action continues to bring the process temperature to the set point. Using a positive dead band value keeps the two systems from fighting each other.

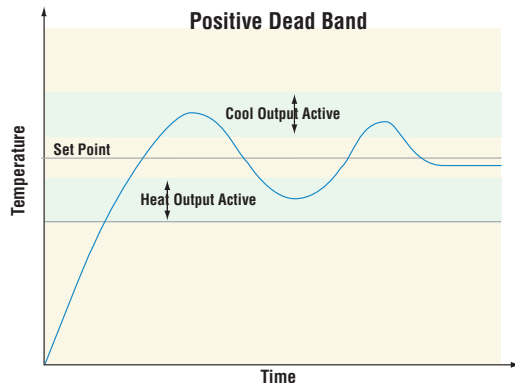

When the dead band value is zero, the heating output activates when the temperature drops below the set point, and the cooling output switches on when the temperature exceeds the set point.

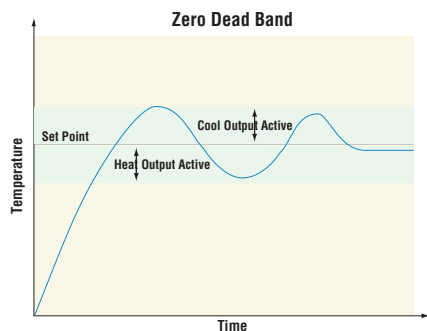

Dead Band (cont.)

When the dead band value is a negative value, both heating and cooling outputs are active when the temperature is near the set point. Adjust the dead band with Dead Band **db** (Operations Page, Loop Menu).

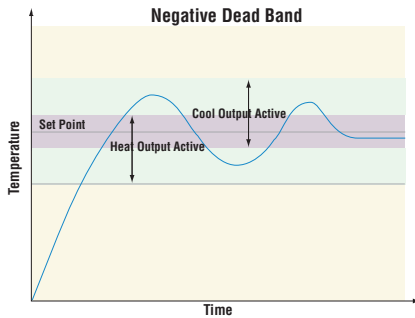

Variable Time Base

Variable time base is the preferred method for controlling a resistive load, providing a very short time base for longer heater life. Unlike phase-angle firing, variable-time-base switching does not limit the current and voltage applied to the heater. With variable time base outputs, the PID algorithm calculates an output between 0 and 100%, but the output is distributed in groupings of three ac line cycles. For each group of three ac line cycles, the controller decides whether the power should be on or off. There is no fixed cycle time since the decision is made for each group of cycles. When used in conjunction with a zero cross (burst fire) device, such as a solid-state power controller, switching is done only at the zero cross of the ac line, which helps reduce electrical noise (RFI). Variable time base should be used with solid-state power controllers, such as a solid-state relay (SSR) or silicon controlled rectifier (SCR) power controller. Do not use a variable time base output for controlling electromechanical relays, mercury displacement relays, inductive loads or heaters with unusual resistance characteristics.

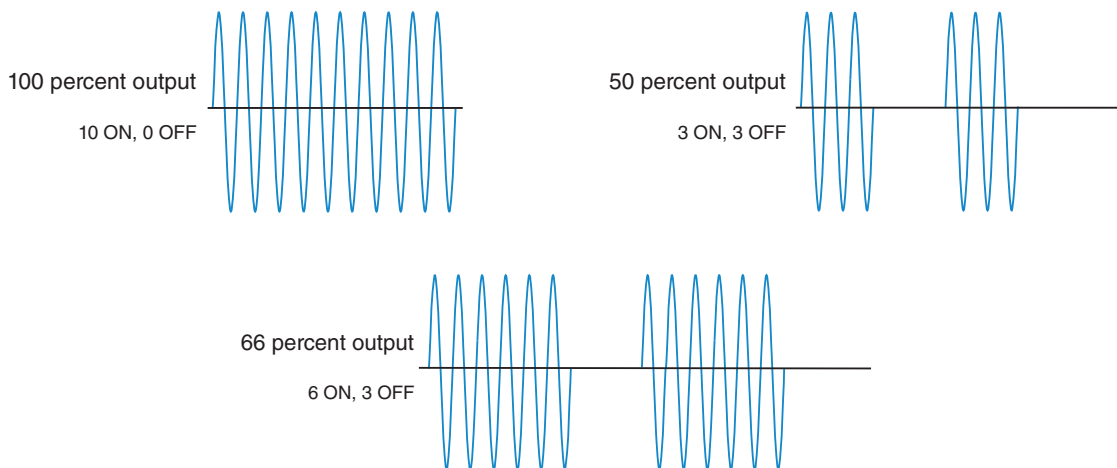

The combination of variable time base output and a solid-state relay can inexpensively approach the effect of analog, phase-angle fired control. Select the AC Line Frequency **ACLF** (Setup Page, Global Menu), 50 or 60 Hz.

Single Set Point Ramping

Ramping protects materials and systems that cannot tolerate rapid temperature changes. The value of the ramp rate is the maximum degrees per minute or hour that the system temperature can change.

Select Ramp Action *rP* (Setup Page, Loop Menu):

- oFF* ramping not active.
- St* ramp at startup.
- StPt* ramp at a set point change.
- both* ramp at startup or when the set point changes.

Select whether the rate is in degrees per minute or degrees per hour with Ramp Scale *rSC*. Set the ramping rate with Ramp Rate *r.rE* (Setup Page, Loop Menu).

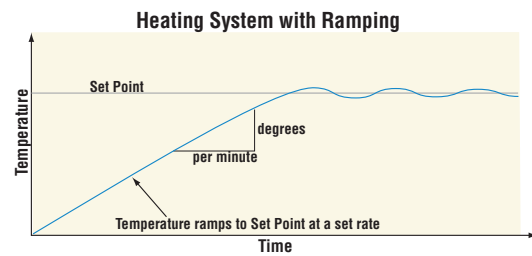
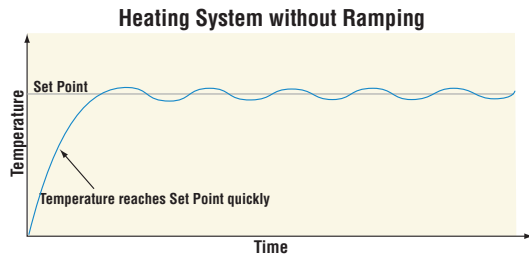

Cascade Control

The PM (PM4/8/9) can be configured for Cascade control with enhanced firmware. Cascade is used to optimize the performance of thermal systems with long lag times. It utilizes a control strategy in which one control loop provides the set point for another loop. See Chapter 10 for application examples.

Compressor Control

The PM control can be configured for Compressor control with two loops of control and enhanced firmware. A typical use scenario for compressor control is for cooling and/or dehumidification. The application may have one or two loops of control which utilize the compressor to accomplish the cooling and/or dehumidification (negative power levels). Because the compressor is a mechanical device, it is desirable to minimize unwanted starts and stops. Either loop can attempt to start or stop the compressor, but this algorithm will make the determination when it should or should not run. Because you may not turn the compressor off until the loop is in the heat or humidify region, the input values (Source Function A and B) to the compressor algorithm must be loop power (+/- 100%).

The compressor will turn on and off under the following conditions:

Loop 1

Off - When Source A Value \geq Input A
Turn Off

On - When Source A Value \leq Input A
Turn On

Loop 2

Off - When Source B Value \geq Input B
Turn Off

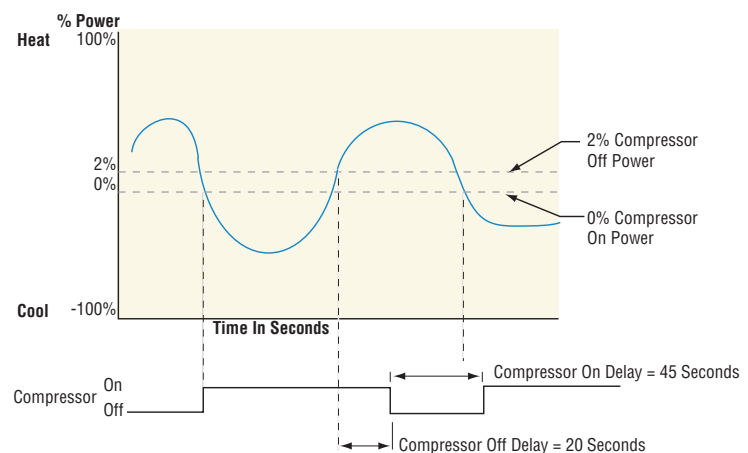

On - When Source B Value \leq Input B Turn On

To prevent unwanted on/off cycling and compressor wear, there are two settings (On and Off Time) that allow the user to define how fast a compressor may be turned off and back on again. The rules for these settings follow:

- Minimum On Time specifies minimum compressor On time.
- Minimum Off Time specifies minimum compressor Off time.

Lastly, the Time Delay setting is used to avoid having the compressor remain on indefinitely in the event the loop control modes are set to off, such as when a profile ends. The rule for the Time Delay setting follows:

Off - Source A Value and Source B Value = 0.0% for a period longer than Time Delay

Differential Control

The PM can be configured for Differential Control with two inputs and enhanced firmware. After configuring the appropriate inputs and their associated internal functions Differential Control allows the PM to drive an output based on the difference between those analog inputs. See [Chapter 10](#) for application examples.

Ratio Control

The PM control can be configured for Ratio control with two inputs and enhanced firmware, especially useful in applications that mix materials. Ratio control is commonly used to ensure that two or more flows are kept at the same ratio even if the flows are changing. See [Chapter 10](#) for application examples.

Duplex Control

Certain systems require that a single process output, control both heating and cooling outputs. A PM control with a process output can function as two separate outputs.

With a 4 to 20mA output the heating output, for instance, will operate from 12 to 20mA (0 to +100%) and the cooling outputs will operate from 12 to 4mA (0 to -100%). In some cases this type of output is

required by the device, such as a three-way valve that opens one way with a 12 to 20mA signal and opens the other way with a 4 to 12mA signal. This feature reduces the overall system cost by using a single output to act as two outputs.

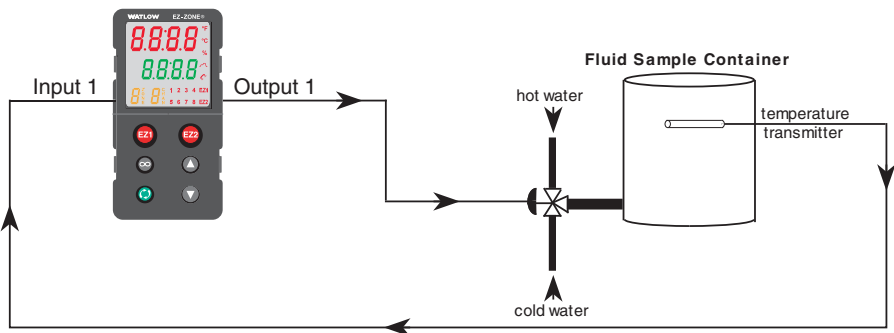

Motorized Valve Control

A motorized valve is used to regulate the flow of fluid which in turn impacts the loop process value. A valve is opened or closed by closing contacts to drive the valve in the intended direction. See [Chapter 10](#) for application examples.



Timer Function

1. When Timer Enable E_{EN} is set to yes YES and the timer is started (you define which key combination this is), the controller will switch from Set Point C_{SP1} to Closed Loop Timer Set Point C_{LST1} . If the timer is interrupted, the timer is terminated and the time remaining is reset to its initial value.
2. When Timer Start Method E_{ST} is set to:
 - a. *Immediate* IMD , the timer starts as soon as the counter is initiated. When Time Remaining E_{R1} equals zero, the set point changes from Closed Loop Timer Set Point C_{LST1} back to Set Point C_{SP1} . A flashing colon $00:00$ indicates that a countdown is in progress.
 - b. *Ready Band* RDY , the set point changes and when the temperature is within ready band, the ready band indicator  lights up and the countdown timer starts and continues as long as the temperature is within the ready band. When Time Remaining E_{R1} equals zero, the set point changes from Closed Loop Timer Set Point C_{LST1} back to Set Point C_{SP1} . A flashing colon $00:00$ indicates that a countdown is in progress.
 - c. *Ready Acknowledge* RDYA , the set point changes, and when the temperature is within the ready band, the ready band indicator  lights up. The user must then acknowledge (you define which key combination for this) that the countdown timer should start and continue as long as the temperature is within the ready band. When Time Remaining E_{R1} equals zero, the set point changes from Closed Loop Timer Set Point C_{LST1} back to Set Point C_{SP1} . A flashing colon $00:00$ indicates that a countdown is in progress.
 - d. *Power* PLWR , the timer starts when the controller is turned on. When Time Remaining E_{R1} equals zero, the set point changes from Closed Loop Timer Set Point C_{LST1} back to Set Point C_{SP1} . A flashing colon $00:00$ indicates that a countdown is in progress.
3. In Setup Page, Output Menu, Output Function F_n can be assigned as Timer Event Output 1 E_{O1} , Timer Event Output 2 E_{O2} or Timer Event Output 3 E_{O3} . Timer Event Output 1 is active during timing, Timer Event Output 2 is deactivated during timing and Timer Event Output 3 produces a pulse at the end of the timing sequence. These signals may be used to monitor timer activity. Process outputs may not be assigned to Timer Event Outputs.
4. The home display is customized in the Factory Page, Custom Menu. You may program the display to alternate between display pairs. See display pairs in the Setup Page, Global Menu. As an example, we could show the process temperature in the upper display and have the lower display alternate between the countdown time remaining and the active set point.

Note:

The timer feature is only available for control loop 1 of two-loop controllers. Time is entered in hours, minutes and seconds. Countdown time will use the entered time but display the time remaining in either hh:mm or mm:ss format, based on your settings. The colon pulses in one-second intervals during a countdown, to indicate that timing is underway. Parameters that appear in the Home page have the number 1 at the end of the displayed parameter. As an example, hoU1 in the Setup Page, Timer Menu will be displayed as hoU1 in the Home Page.

Setting up the timer function

1. Press and hold up  and down  arrow keys for 6 seconds to enter into the Setup Page SEt .

2. Up arrow \blacktriangle to Timer Menu $tPPr$.

3. Advance \odot to Timer Enable tEn to make selection using the up \blacktriangle and down \blacktriangledown arrow keys to select from the options below:

yEs Yes
 nO No

4. Advance \odot to Timer Start Method tSt to select the method that will start the timer.

5. Use the up arrow \blacktriangle to select from the options below:

$iPId$ Immediate
 rDY Ready Band
 $rDYA$ Ready Ack
 $PbDr$ Power

6. Advance \odot to Source Function A $SFnA$ to select which input will start/terminate the timer. Use the up arrow \blacktriangle to select from the options below:

$nOnE$ None
 dIo Digital I/O
 FUn Function Key

7. Advance \odot to Source Instance A and use the up arrow \blacktriangle to make a selection below:

If Source Function A of previous step is set to None $nOnE$:

1 Does not matter which number is here
 $5 iA$ Source Instance A

If Source Function A of previous step is set to Digital I/O dIo :

5 Select 5 to 12
 $5 iA$ Source Instance A

If Source Function A of previous step is set to Function Key FUn :

1 EZ1 Key
 2 EZ2 Key
 6 Hold infinity key for 2 seconds
 7 Infinity ∞ and Down arrow \blacktriangledown
 8 Infinity ∞ and Up arrow \blacktriangle
 $5 iA$ Source Instance A

8. Advance \odot to Source Function C $SFnC$ to select the analog source for the ready band. Use the up arrow \blacktriangle to select from the options below:



Pv Process Value
 $nOnE$ None
 RA Analog Input
 Lnr Linearization

9. Advance \odot and use the up arrow \blacktriangle to make a selection below:

1 1 or (2, if second instance of Source Function C)

10. Advance \odot to Source Function D $SFnD$ to select which input will acknowledge the ready band. Use the up arrow \blacktriangle to select from the options below:

$nOnE$ None
 dIo Digital I/O
 FUn Function Key

11. Advance  to Source Instance D and use the up arrow  to make a selection below:

If Source Function A of previous step is set to None *none*:

1 Does not matter which number is here

5 id Source Instance D

If Source Function A of previous step is set to Digital I/O *dio*:

5 Select 5 to 12



5 id Source Instance D

If Source Function A of previous step is set to Function Key *Fun*:

1 EZ1 Key

2 EZ2 Key

6 Hold infinity key for 2 seconds



7 Infinity  and Down arrow 



8 Infinity  and Up arrow 

5 id Source Instance D

12. Advance  to Time Remaining *tr*, read only, display in hh:mm or mm:ss.



13. Advance  to Ready Band State *rbs*, read only, displayed as yes *yes* or no *no*.

14. Advance  to Ready Band *rdy* to enter the value for Ready Band using Up  or Down arrow .

15. Advance  to Time Format *tf* to select the time format. Use the up arrow  to make selection below:

hhmm Time Hours:Minutes



mmss Time Minutes:Seconds

16. Advance  to Countdown Time to enter hours, minutes and seconds using the Up  or Down arrow .

hour Hours, then Advance 

mm Minutes, then Advance 

sec Seconds

17. Advance  to Closed Loop Timer Set Point *clsp* to enter the temperature during counting using the Up  or Down arrow .

18. Advance  to Signal Time *st* to enter time in seconds for Timer Event Output 3 *te3* to be active at end of countdown time.

19. Press and hold the Infinity  or Reset key for more than 2 seconds to go to Home Page.

20. See programming custom home page in factory page, custom menu to change the display parameters such as active process value, closed loop set point time, closed loop timer set point and time remaining as appropriate for the application.

Alarms

Alarms are activated when the output level, process value or temperature leaves a defined range. A user can configure how and when an alarm is triggered, what action it takes and whether it turns off automatically when the alarm condition is over. Configure alarm outputs in the Setup Page before setting alarm set points. Alarms do not have to be assigned to an output. Alarms can be monitored and controlled through the front panel or by using software.

Process and Deviation Alarms

A process alarm uses one or two absolute set points to define an alarm condition. A deviation alarm uses one or two set points that are defined relative to the set point used by the control loop. High and low alarm set points are calculated by adding or subtracting offset values from the set point used by the control loop. If the set point changes, the window defined by the alarm set points automatically moves with it. Select the type with Type **ALY** (Setup Page, Alarm Menu).

Set Points

The high set point defines the process value or temperature that will trigger a high side alarm. The low set point defines the temperature that will trigger a low side alarm. For deviation alarms, a negative set point represents a value below set point used by the control loop. A positive set point represents a value above the set point used by the control loop. View or change alarm set points with Low Set Point **ALo** and High Set Point **AHi** (Operations Page, Alarm Menu).

Hysteresis

An alarm state is triggered when the process value reaches the high or low set point. Hysteresis defines how far the process must return into the normal operating range before the alarm can be cleared.

Hysteresis is a zone inside each alarm set point. This zone is defined by adding the hysteresis value to the low set point or subtracting the hysteresis value from the high set point. View or change hysteresis with Hysteresis **AhY** (Setup Page, Alarm Menu).

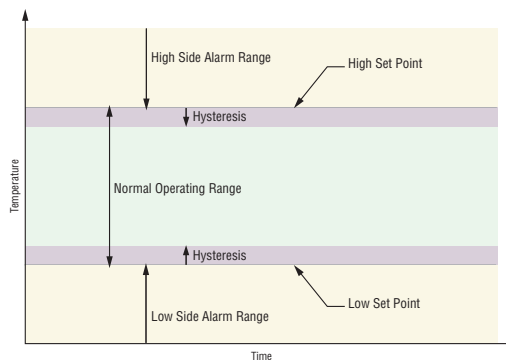

Alarm Set Points and Hysteresis

Latching

A latched alarm will remain active after the alarm condition has passed. It can only be deactivated by the user. An active message, such as an alarm message, will cause the display to toggle between the normal settings and the active message in the upper display and **ALEn** in the lower display. Push the Advance Key **⏩** to display **ALn** in the upper display and the message source in the lower display. Use the Up **▲** or Down **▼** keys to scroll through possible responses, such as Clear **CLR** or Silence **SIL**. Then push the Advance **⏩** or Infinity **∞** key to execute the action.

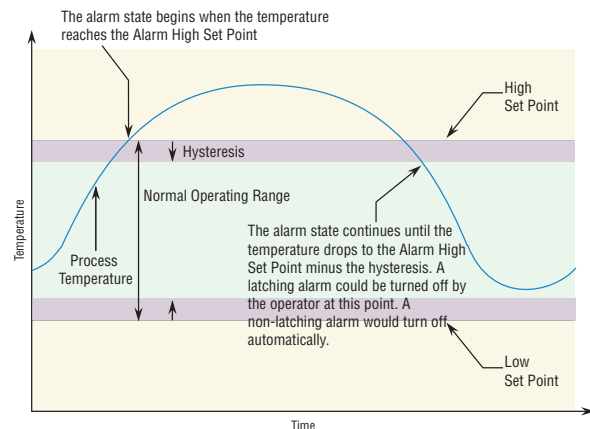

Alarm Response with Hysteresis

See the Keys and Displays chapter and the Home Page chapter for more details. An alarm that is not latched (self-clearing) will deactivate automatically when the alarm condition has passed. Turn latching on or off with Latching **ALR** (Setup Page, Alarm Menu).

Silencing

If silencing is on the operator can disable the alarm output while the controller is in an alarm state. The process value or temperature has to enter the normal operating range beyond the hysteresis zone to activate the alarm output function again. An active message, such as an alarm message, will cause the display to toggle between the normal settings and the active message in the upper display and **ALRN** in the lower display.

1. Push the Advance Key **➤** to display **ALRN** in the upper display and the message source in the lower display.
2. Use the Up **▲** and Down **▼** keys to scroll through possible responses, such as Clear **CLR** or Silence **SIL**. Then push the Advance **➤** or Infinity **∞** key to execute the action.

See the Keys and Displays chapter and the Home Page chapter for more details. Turn silencing on or off with Silencing **ASL** (Setup Page, Alarm Menu).

Blocking

Blocking allows a system to warm up after it has been started up. With blocking on, an alarm is not triggered when the process temperature is initially lower than the low set point or higher than the high set point. The process temperature has to enter the normal operating range beyond the hysteresis zone to activate the alarm function. If the EZ-ZONE PM has an output that is functioning as a deviation alarm, the alarm is blocked when the set point is changed, until the process value re-enters the normal operating range. Turn blocking on or off with Blocking **ABL** (Setup Page, Alarm Menu).

Current Sensing

When utilizing the Current Sensing capabilities of this control it is important to know that the measurements taken utilize the AC Line Frequency **ACLF** setting found in the Global Menu of the Setup Page. If this setting does not represent the incoming line frequency of this controller the readings will be in error and may appear to be frozen.

Note:

If an alarm is configured to monitor current as its source, the low alarm will be effective only when the current level is equal to or greater than 2mA. If there is no current present, the low alarm will not be activated.

Open and Shorted Load Circuit Detection

A Current Error **CEr** (Operations Page, Current Menu) can detect either an open or shorted load condition. A shorted condition would be present if the control is calling for 0% power while current is detected as flowing through the current transformer. Conversely, an open condition would be present when the control is calling for power with no current flow detected through the transformer.

A Heater Error **HEr** (Operations Page, Current Menu) is used to determine if the load current flow is within the specified limits as set by the user through the Current Set Points (High Set Point **ChL** and Low Set Point **CLo**); navigate to the Operations Page and then the Current Menu to modify.

Read and monitor the real-time current level through the Load Current RMS $LdCu$ prompt while the most recent faults can be read via the Current Error CEr and Heater Error hEr prompts. All of these prompts can be found in the Operations Page under the Current Menu.

CT Application Note:

Alarms have to point to the correct source for the current measurement. We have one measurement that is sampled and held CUr . Since this is a zero cross device, in zero cross the current is going to 0 each time the output is turned off. We also calculate an Current RMS value that takes into account on time versus off time. Be sure alarms are pointed to the current that is sampled and held or anytime the PID power gets low like less than 2%, the alarm will activate or if the outputs are off such as control mode set to OFF.

Open Loop Detection

When Open Loop Detection is enabled LdE , the controller will look for the power output to be at 100%. Once there, the control will then begin to monitor the Open Loop Detect Deviation Ldd as it relates to the value entered for the Open Loop Detect Time Ldt . If the specified time period expires and the deviation does not occur, an Open Loop Error will be triggered. Once the Open Loop Error condition exists the control mode will go off and an Open Loop message will be display. If the process value goes in the opposite direction, a Reversed Loop message is display. The sensor is likely wired in reverse polarity.

Note:

All prompts identified in this section can be found in the Loop Menu of the Setup Page.

Programming the EZ Key/s

You can program the EZ Key either in the Setup Menu or with configuration software, such as EZ-ZONE Configurator, using a personal computer.

The following examples show how to program the EZ Key to start and stop a profile.

1. To go to the Setup Page from the Home Page, press both the Up \blacktriangle and Down \blacktriangledown keys for six seconds. R will appear in the upper display and SEt will appear in the lower display.
2. Press the Up Key \blacktriangle until FUn appears in the upper display and SEt will appear in the lower display.
3. Press the Advance Key \odot until Digital Input Level LEu appears in the lower display. Use an arrow key to specify the state of the key (high or low) when the controller is powered up. Functions will toggle with each press of the EZ Key, such as Profile Start/Stop.

Note:

If the level is set to low, the profile will execute automatically on power up.

4. Press the Advance Key \odot . The lower display will show Digital Function F_n . Press the Up \blacktriangle or Down \blacktriangledown key to scroll through the functions that can be assigned to the EZ Key When Profile Start/Stop $PStS$ appears in the upper display and F_n appears in the lower display, press the Advance Key \odot once to select that function and move to the Function Instance F_i parameter.
5. Press the Up \blacktriangle or Down \blacktriangledown key to scroll to the profile that you want the EZ Key to control.
6. The instance tells the controller which of the numbered functions should be acted upon. For profiles, there are 4 instances. Press the Infinity Key ∞ once to return to the sub-menu, twice to return to the main menu or three times to return to the Home Page.

Using Lockout and Password Security

If unintentional changes to parameter settings might raise safety concerns or lead to down-time, you can use the lockout feature to make them more secure. There are two methods of lockout that can be deployed, both of which are accessible from the Factory Page.

Method 1- Change the value of the Read Lock *rLoC* (1 to 5) and Set Lock *SLoC* (0 to 5) prompts where the higher the value or setting for each translates to a higher security clearance (greater access).

Method 2- Enable Password Security *PA5E* and then modify the Lock Level *LoCL* value which ranges from 1 to 5. See the section entitled [Using Lockout Method 2](#) for more detail.

Using Lockout Method 1 (Read and Set Lock)

All Pages have security levels assigned where two of those cannot be changed (Home and Setup). Defaults (factory settings) for each are shown below:

- Home Page = 1
- Operations Page = 2 (changeable to 1, 2 or 3)
- Setup Page = 4
- Profiling Page = 3 (changeable to 1, 2 or 3)
- Factory Page = 5*



* The Factory Page is always visible where all menus within it may or may not be visible/writable. For further detail see table "[Factory Page Menus](#)".









The table below represents the various levels of lockout for the Set Lockout Security prompt *SLoC* and the Read Lockout Security prompt *rLoC*. Looking at the table, "Y" equates to yes (can write/read) where "N" equates to no (cannot write/read). The colored cells simply differentiate one level from the next while also showing the level where read/write is enabled. As stated previously, the Set Lockout has 6 levels (0 to 5) of security where the Read Lockout has 5 (1 to 5). Therefore, level "0" applies to Set Lockout only.

Lockout Security <i>SLoC</i> and <i>rLoC</i>						
Pages	Security Level					
	0	1	2	3	4	5
Home Page (cannot be changed)	N	Y	Y	Y	Y	Y
Operations Page	N	N	Y	Y	Y	Y
Setup Page (cannot be changed)	N	N	N	N	Y	Y
Profile Page	N	N	N	Y	Y	Y
Factory Page	Y	Y	Y	Y	Y	Y

Being able to change the page security level for the Operations and Profile pages allows a user to give access to the Profile Page while locking out the Operations Page. The following example shows how the Lockout feature may be used to accomplish this:





Changing Security Levels:

1. From the Home Page, press and hold the Infinity Key  and the Advance Key  for approximately six seconds. *CU5E* will appear in the upper display and *FCEY* will appear in the lower display.
2. Press the Up Key  until *LoC* appears in the upper display and *FCEY* will appear in the lower display.

3. Press the Advance Key  until Lock Operations prompt **L o E** appears in the bottom display.
4. Press the Up Key  to change the default value from **2** to **3**.
5. Press the Advance Key  again and change the Lock Profiling prompt **L o E P** appears in the bottom display.
6. Press the Down Key  to change the default value from **3** to **2**.
7. Press the Advance Key  until Read Lock **r L o E** appears in the bottom display.
8. Press the Down Key  to change the default value from **5** to **2**.
9. Press the Advance Key  until Set Lock **S L o E** appears in the bottom display.
10. Press the Down Key  to change the default value from **5** to **4**.

With the above settings, the Home Page and the Profiling Page can be accessed, and all writable parameters can be written to. Due to the Read lock setting of 2, all pages with security levels greater than 2 will be locked out (inaccessible).

Another example of Method 1 lockout usage could be that an operator wants read access to all pages while allowing read/write access to the Home Page and the Lockout Menu only. To setup this scenario follow the steps below:

1. From the Home Page, press and hold the Infinity Key  and the Advance Key  for approximately six seconds. **C U S E** will appear in the upper display and **F C E Y** will appear in the lower display.
2. Press the Up Key  until **L o E** appears in the upper display and **F C E Y** will appear in the lower display.
3. Press the Advance Key  until Read Lock **r L o E** appears in the bottom display and change it to **5**.
4. Press the Advance Key  until Set Lock **S L o E** appears in the bottom display and change it to **1**.

Although the Factory Page is always visible, some menus within it can be restricted.

Lockout Security S L o E and r L o E						
Factory Page Menus						
Menus	Security Level					
	0	1	2	3	4	5
Custom Menu	N	N	N	N	N	Y
Lockout Menu*	Y	Y	Y	Y	Y	Y
Diagnostic Menu**	N	Y	Y	Y	Y	Y
Calibration Menu	N	N	N	N	N	Y

* Using lockout Method 1 with **S L o E** set to 0, all writable parameters within the control will be inhibited (not writable) with two exceptions, **S L o E** and **r L o E**. As shown below, both of these parameters can always be seen and modified.

** Diagnostic Menu and all associated prompts are always visible and never writable

Lockout Security <i>SLoC</i> and <i>rLoC</i>						
Factory Page Menu Parameters						
Parameters	Security Level					
	0	1	2	3	4	5
<i>LoCo</i>	N	Y	Y	Y	Y	Y
<i>LoCP</i>	N	Y	Y	Y	Y	Y
<i>PA5E</i>	N	Y	Y	Y	Y	Y
<i>rLoC</i>	Y	Y	Y	Y	Y	Y
<i>SLoC</i>	Y	Y	Y	Y	Y	Y

Note:





Using Method 1 Lockout all settings can be modified by anyone who knows how to find their way to the *SLoC* and *rLoC* parameters.

Using Lockout Method 2 (Password Enable)

It is sometimes desirable to apply a higher level of security to the control where a password would be required to access the control. If Password Enabled *PA5E* in the Factory Page under the *LoC* Menu is set to on, an overriding Password Security will be in effect. Without the appropriate password, specified menus will remain inaccessible. Page and Menu access is defined in the Locked Access Level *LoCL* prompt. On the other hand, a User with a password would have visibility restricted by the Read Lockout Security *rLoC*. As an example, with Password Enabled and the Locked Access Level *LoCL* set to 1 and *rLoC* is set to 3, the available Pages for a User without a password would be limited to the Home and Factory Pages (locked level 1). If the User password is entered all pages would be accessible with the exception of the Setup Page as defined by level 3 access.

How to Enable Password Security

Follow the steps below:

1. From the Home Page, press and hold the Infinity Key  and the Advance Key  for approximately six seconds. *CU5E* will appear in the upper display and *FC5Y* will appear in the lower display.
2. Press the Up Key  until *LoC* appears in the upper display and *FC5Y* will appear in the lower display.
3. Press the Advance Key  until Password Enable *PA5E* appears in the bottom display and change it to *5*.
4. Press the Up Key  to turn it *on*. Once on, four new prompts will appear:
 - a. *Locked Access Level LoCL*, (1 to 5) corresponding to the lockout table above.
 - b. *Rolling Password rOLL*, will change the Customer Code every time power is cycled.
 - c. *User Password PA5u*, which is needed for a User to acquire access to the control.
 - d. *Administrator Password PA5A*, which is needed to acquire administrative access to the control.

The Administrator can either change the User and or the Administrator password or leave them in the default state. Once Password Security is enabled they will no longer be visible to anyone other than the Administrator. In other words the Lock Menu *LoC* is not available to a User. As can be seen in the formula that follows either the User or Administrator will need to

know what those passwords are to acquire a higher level of access to the control. Back out of this menu by pushing the Infinity Key . Once out of the menu, the Password Security will be enabled.

How to Acquire Access to the Control









To acquire access to any inaccessible Pages or Menus, go to the Factory Page and enter the **ULoE** menu. Once there follow the steps below:

Note:

If Password Security (Password Enabled **PA5.E** is On) is enabled the two prompts mentioned below in the first step will not be visible. If the password is unknown, call the individual or company that originally setup the control.

1. Acquire either the User Password **PA5.u** or the Administrator Password **PA5.A**.
2. Press the Advance  key one time where the Code **CoDE** prompt will be visible.

Note:

- a. If the Rolling Password is off, press the Advance Key  one more time where the Password **PA55** prompt will be displayed. Proceed to either step 7a or 8a. Pushing the Up  or Down  arrow keys enter either the User or Administrator Password. Once entered, press and hold the Infinity Key  key for two seconds to return to the Home Page.
 - b. If the Rolling Password **roLL** was turned on proceed on through steps 3 - 9.
3. Assuming the Code **CoDE** prompt (Public Key) is still visible on the face of the control simply push the Advance Key  to proceed to the Password **PA55** prompt. If not, find your way back to the Factory Page as described above.
 4. Execute the calculation defined below (7b or 8b) for either the User or Administrator.
 5. Enter the result of the calculation in the upper display play by using the Up  and Down  arrow keys or use EZ-ZONE Configurator Software.
 6. Exit the Factory Page by pressing and holding the Infinity Key  for two seconds.

Formulas used by the User and the Administrator to calculate the Password follows:

Passwords equal:

7. User

- a. If Rolling Password **roLL** is Off, Password **PA55** equals User Password **PA5.u**.
- b. If Rolling Password **roLL** is On, Password **PA55** equals: $(PA5.u \times \text{code}) \text{ Mod } 929 + 70$

8. Administrator

- a. If Rolling Password **roLL** is Off, Password **PA55** equals User Password **PA5.A**.
- b. If Rolling Password **roLL** is On, Password **PA55** equals: $(PA5.A \times \text{code}) \text{ Mod } 997 + 1000$

Differences Between a User Without Password, User With Password and Administrator

- User without a password is restricted by the Locked Access Level **LoEL**.
- A User with a password is restricted by the Read Lockout Security **rLoE** never having access to the Lock Menu **LoE**.
- An Administrator is restricted according to the Read Lockout Security **rLoE** however, the Administrator has access to the Lock Menu where the Read Lockout can be changed.

Modbus - Using Programmable Memory Blocks

When using the Modbus RTU or Modbus TCP protocols, the PM control features a block of addresses that can be configured by the user to provide direct access to a list of 40 user configured parameters. This allows the user easy access to this customized list by reading from or writing to a contiguous block of registers.

To acquire a better understanding of the tables found in the back of this manual (See Appendix: [Modbus Programmable Memory Blocks](#)) please read through the text below which defines the column headers used.

Assembly Definition Addresses

- Fixed addresses used to define the parameter that will be stored in the "Working Addresses", which may also be referred to as a pointer. The value stored in these addresses will reflect (point to) the Modbus address of a parameter within the PM control.

Assembly Working Addresses

- Fixed addresses directly related to their associated "Assembly Definition Addresses" (i.e., Assembly Working Addresses 200 & 201 will assume the parameter pointed to by Assembly Definition Addresses 40 & 41).

When the Modbus address of a target parameter is stored in an "Assembly Definition Address" its corresponding working address will return that parameter's actual value. If it's a writable parameter, writing to its working register will change the parameter's actual value. As an example, Modbus register 360 represents the Analog Input 1 Process Value (See Operations Page, Analog Input Menu). If the value 360 is loaded into Assembly Definition Address 90 and value 361 is loaded into Assembly Definition Address 91, the process value sensed by analog input 1 will also be stored in Modbus registers 250 and 251. Notice that by default this parameter is also stored in working registers 240 and 241 as well.

Note:

When modifying the Modbus Assembly registers, single register writes (function 06) are not allowed. Multiple register writes (function 16) must be used to modify the assembly.

The table identified as "Assembly Definition Addresses and Assembly Working Addresses" (see Appendix: Modbus Programmable Memory Blocks) reflects the assemblies and their associated addresses.

CIP - Communications Capabilities

With the introduction of the Common Industrial Protocol (CIP) a user can now collect data, configure a device and control industrial devices. CIP is an open protocol at the application layer fully managed by the Open DeviceNet Vendors Association (ODVA, <http://www.odva.org>). Being that this is an open protocol there are many independent vendors offering a wide array of devices to the end user. CIP provides the ability to communicate utilizing both implicit messaging (real-time I/O messaging), and explicit messaging (information/configuration messaging). For implicit communications using a PLC, simply configure the PM assembly size into the I/O structure of the PLC (See: [CIP Implicit Assembly Structures](#)). The assembly structures can also be changed by the user. Explicit communications requires the use of specific addressing information. DeviceNet requires that the node address be specified where Ethernet/IP requires just the Class, Instance and Attribute.

- Node address or MAC ID (0 - 63, DeviceNet only)
- Class ID (1 to 255)
- Instance ID (0 to 255)

- Attribute ID (1 to 255)

EtherNet/IP and DeviceNet are both based on CIP and use the same addressing scheme. In the following menu pages notice the column header identified as CIP. There you will find the Class, Instance and Attribute in hexadecimal, (decimal in parenthesis) which makes up the addressing for both protocols. The Watlow implementation of CIP does not support connected explicit messages but fully supports unconnected explicit messaging.

Rockwell Automation (RA) developed the DF1 serial protocol within the framework of the PCCC application protocol. With the introduction of CIP, the PCCC protocol was encapsulated within it to enable continued communication over Ethernet to the legacy RA programmable controllers, e.g., SLC, Micrologic and PLC-5 controllers equipped with Ethernet capabilities. The Watlow implementation of CIP also supports the PCCC protocol.

EtherNet/IP (Industrial Protocol) is a network communication standard capable of handling large amounts of data at speeds of 10 Mbps or 100 Mbps, and at up to 1,500 bytes per packet. It makes use of standard off-the-shelf Ethernet chip sets and the currently installed physical media (hardware connections). DeviceNet was the first field bus offering of the ODVA group and has been around for many years. DeviceNet can communicate at 125, 250 and 500 kilobytes per second with a maximum limitation of 64 nodes (0 to 63) on the network.

Note:

If the control is brought back to the factory defaults (See Appendix: [CIP Implicit Assembly Structures](#)) the user configured assemblies will be overwritten.

Note:

The maximum number of implicit input/output members using *DeviceNet* is 200. When using EtherNet/IP the maximum is 100.

CIP Implicit Assemblies

Communications using CIP (EtherNet/IP and DeviceNet) can be accomplished with any PM Integrated control equipped with either DeviceNet or EtherNet/IP communications cards. As was already mentioned, reading or writing when using CIP can be accomplished via explicit and or implicit communications. Explicit communications are usually executed via a message instruction within the PLC but there are other ways to do this as well outside of the focus of this document.

Implicit communications is also commonly referred to as polled communications. When using implicit communications there is an I/O assembly that would be read or written to. The default assemblies and the assembly size is embedded into the firmware of the PM control. Watlow refers to these assemblies as the T to O (Target to Originator) and the O to T (Originator to Target) assemblies where the Target is always the EZ-ZONE PM controller and the Originator is the PLC or master on the network. The size of the O to T assembly is initially set to 40 (32-bit) members where the T to O assembly consists of 40 (32-bit) members. All assembly members are user configurable with the exception of the first T to O member. The first member of the T to O assembly is called the Device Status, it is unique and cannot be changed. If the module has been properly configured when viewing this 32-bit member in binary format bits 12 and 16 should always be set to 1 where all of the other bits should be 0. All other members that follow Device Status are user configurable. The Appendix of this User's Guide contains the PM implicit assemblies (See Appendix: [CIP Implicit Assembly Structures](#)).

Compact Assembly Class

Along with the standard implicit assembly where each module parameter (member) occupies one 32-bit assembly location, there is also a Compact Class assembly. The need for the Compact Class assembly members became apparent as the number of member instances grew with the EZ-ZONE family of controls. Because there is a limited number of implicit assembly members (40 input, 40 output), the Compact Class enables the user to modify the standard assembly offering to their liking while also achieving much better utilization of each bit within the 32-bit member. As an example, if a standard Implicit Assembly member were configured to monitor Alarm State 1, the entire 32-bit member would be consumed where just 7 bits out of the 32 represent: Startup (88), None (61), Blocked (12), Alarm Low (8), Alarm High (7) or Error (28). With Compact Class assembly member 12 (identified in this document as "[12 A, Alarm Read](#)") in use, the alarm states of all 4 alarms can be placed in one 32-bit assembly member using just 2 bits for each state. Bits 0 and 1 would represent Alarm State 1, bits 2 and 3 Alarm State 2, etc... Each pair of 2 bits can represent the following states: 00 = None, 01 = Alarm Low, 10 = Alarm High and 11 = Other. There is a variety of predefined Compact Class members that can be used (See Appendix: [Compact Class Assembly Structure](#)) to modify the default implicit assemblies.

Note:

As is the case with any available parameter within the PM control, the Compact Class members can also be read or written to individually via an explicit message as well.

Modifying Implicit Assembly Members

To change any given member of either assembly (T to O or O to T) simply write the new class, instance and attribute (CIA) to the member location of choice. As an example, if it were desired to change the 14th member of the T to O assembly from the default parameter (Cool Power) to the Compact Class 12th member (See Appendix: [Compact Class Assembly Structure](#)) write the value of 0x71, 0x01 and 0x0C (Class, Instance and Attribute respectively) to 0x77, 0x02 and 0x0D. Once the change is executed, reading this member location (as was discussed above) will return the Alarm States (1-4) to paired bits 0 through 7 where 00 = None, 01 = Alarm Low, 10 = Alarm High and 11 = Other. The CIP communications instance will always be instance 2.

PCCC - (Programmable Controller Communications Commands)

This protocol is typically used with older Allen Bradley programmable controllers capable of PLC-5 compatibility. EZ-ZONE PM controllers support this protocol. As described above, the PM has 2 assemblies; one for input (O to T), and the other for output (T to O). Within the PM controller and as viewed and accessed using Rockwell software, these assemblies can be identified as N11:0 (O to T) and N10:0 (T to O). Looking at the appendix in the back of this User's Guide both assemblies are listed and identified. If for instance an ML1100 was being used to write a new Set Point to the PM controller, a message instruction would need to be setup within the PLC to send a floating point value to N11:2. Likewise, if it were desired to read the Analog Input Value from the PM (within the PLC), a message instruction would need to be setup to read (from the target device) register N10:1 and then handled appropriately within the PLC because this is a floating point value in the PM controller.

Most, if not all of these older PLCs now support CIP generic messaging. It would be worth your while to check and see if the PLC in use supports CIP for the programming effort will then be minimized. Using CIP allows for reads and writes to/from the PLC directly to the desired CIP address within the PM controller. All available PM CIP addresses are documented within this PM User's Guide for each of the PM menus.

Profibus DP - (Decentralized Peripherals)

This protocol is typically used to operate sensors and actuators via a centralized controller within industrialized production topologies. Data rates up to 12 Mbit/s on twisted pair cables and/or fiber optics are possible. This protocol is available in three functionally graded version; DP-V0, DP-V1 and DP-V2. It should be noted that Watlow products utilizing this protocol support DP-V0 and DP-V1 only.

DP-V0 - provides the basic functionality of DP, including cyclic data exchange, station, module and channel specific diagnostics and four different interrupt types for diagnostics and process interrupts.

Cyclic Data refers to input/output data that is pre-configured to pass from the Profibus-DP Class 1 Master and the Slave at a known rate. Cyclic data is expected on both the sender and the receiver end of the message.

Note:

To use DP-V0 (cyclic data transfer) first configure and then register the General Station Description (GSD) file. Watlow provides a software tool allowing for total customization of the data to be read and or written to. Acquire this software tool (Profibus GSD Editor) via the CD that shipped with the product or, as an alternative, point your browser to: <http://www.watlow.com/en/resources-and-support/Technical-Library/Software-and-Demos> and type "gsd" into the search field.

Using the GSD Editor a user can configure up to a maximum of 244 I/O bytes that can be read or written to from Zone 1 through 16. DP-V1 - contains enhancements geared towards process automation, in particular acyclic data communication for parameter assignment, operation, visualization and interrupt control of intelligent field devices, in conjunction with cyclic user data communication.

Acyclic Data is a message that can be sent and or received at any time where they typically have a lower priority then cyclic messages. This type of messaging is typically used for the purpose of configuration or performing some sort of a diagnostic function.

Software Configuration

Using EZ-ZONE Configurator Software

To enable a user to configure the PM control using a personal computer (PC), Watlow has provided free software for your use. If you have not yet obtained a copy of this software insert the CD (Controller Support Tools) into your CD drive and install the software. Alternatively, if you are viewing this document electronically and have a connection to the Internet simply click on the link below and type "configurator" into the search field. Download the software from the Watlow web site free of charge.

<http://www.watlow.com/en/resources-and-support/Technical-Library/Software-and-Demos>

Once the software is installed double click on the EZ-ZONE Configurator icon placed on your desktop during the installation process. If you cannot find the icon follow the steps below to run the software:

1. Move your mouse to the "Start" button
2. Place the mouse over "All Programs"

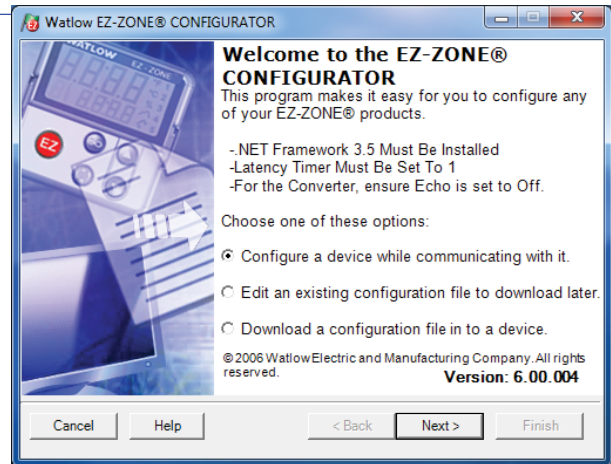

3. Navigate to the "Watlow" folder and then the sub-folder "EZ-ZONE Configurator"
4. Click on EZ-ZONE Configurator to run.

The first screen that will appear is shown above.

If the PC is already physically connected to the EZ-ZONE PM control click the next button to go on-line.

Note:

When establishing communications from PC to the EZ-ZONE PM controller, an interface converter will be required. The Standard Bus network uses EIA-485 as the interface. Most PCs today would require a USB to EIA-485 converter. However, some PCs may still be equipped with EIA-232 ports, therefore an EIA-232 to EIA-485 converter would be required.

As can be seen in the above screen shot the software provides the user with the option of downloading a previously saved configuration as well as the ability to create a configuration off-line to download later. The screen shots that follow will take the user on-line.

After clicking the next button above it is necessary to define the communications port that will be used on the PC as shown to the right. Clicking on the drop down will allow the user to select the appropriate communications port. This will be the port assigned to the EIA-485 to USB converter when it was connected to the PC. The "Advanced" button allows the user to determine how many devices to look for on the network (1 to 17).

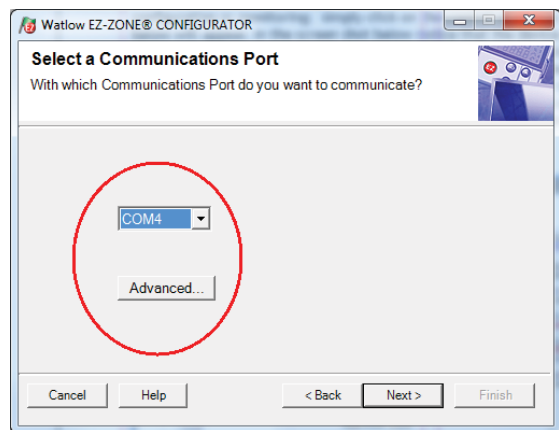

After clicking on the "Next" button, the software will scan the network for the zone addresses specified while showing the progress made (as shown in the graphic below). When complete the software will display all of the available devices found on the network as shown below.

Searching Network for Devices

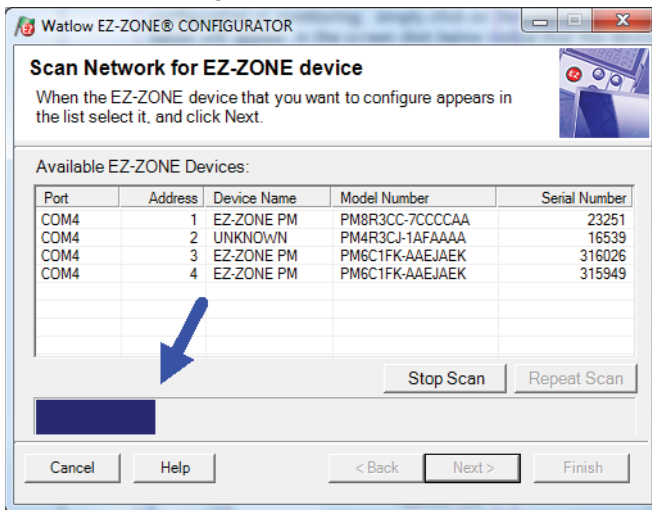

Available Network Devices Displayed

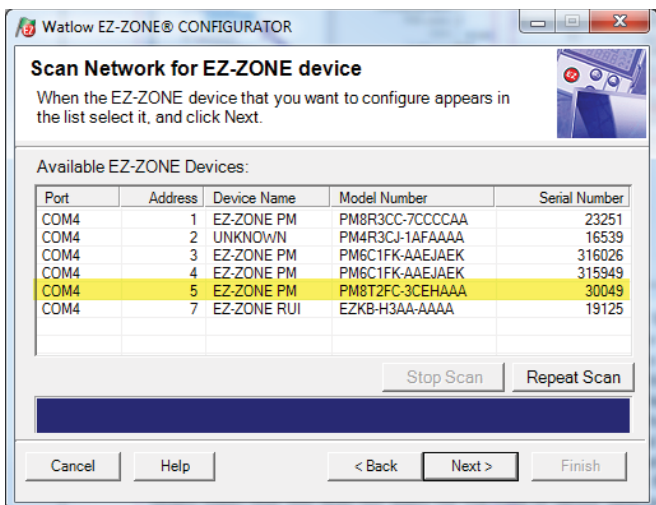

The PM8 is shown highlighted to bring greater clarity to the control in focus. Any EZ-ZONE device on the network will appear in this window and would be available for the purpose of configuration or monitoring; simply click on the control of choice. After doing so, the screen below will appear. In the screen shot below notice that the device part number is clearly dis-

played at the top of the page (yellow highlight added for emphasis). When multiple EZ-ZONE devices are on the network it is important that the part number be noted prior to configuring so as to avoid making unwanted configuration changes to another control. Looking closely at the left hand column (Parameter Menus) notice that it displays all of the available menus and associated parameters within the control. The menu structure as laid out within this software follows:

- Setup - Operations - Factory - Profile

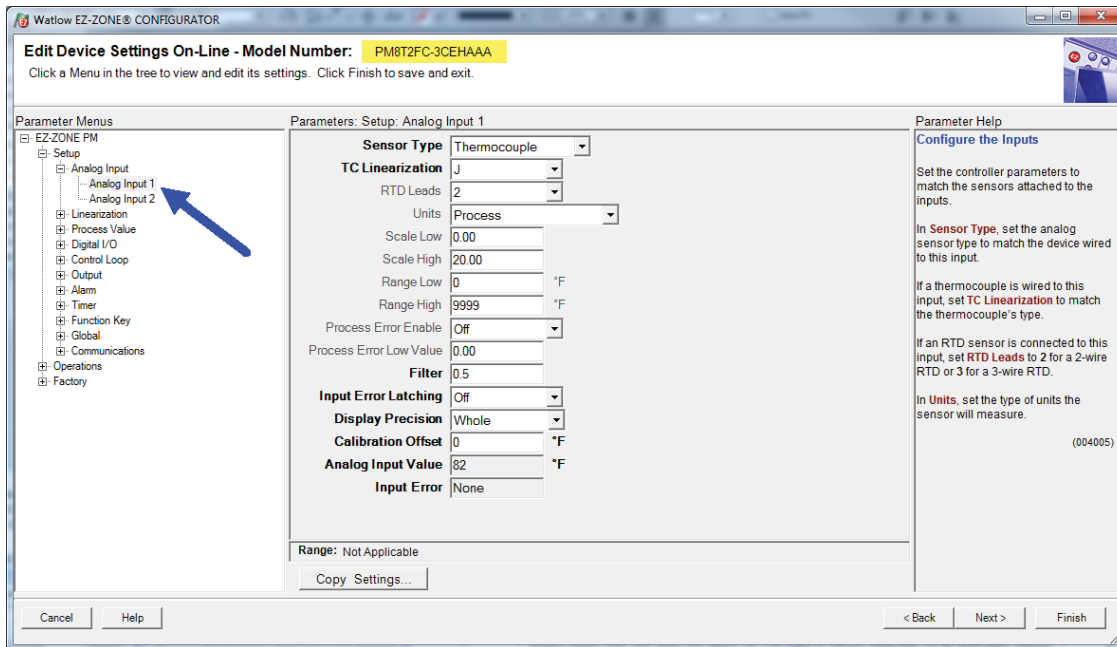

Navigating from one menu to the next is easy and clearly visible. Simply slide the scroll bar up or down to display the menu and parameter of choice. If there is a need to bring greater focus and clarity to the parameters of interest simply click on the negative symbol next to any of the Menu items. As an example if it is desired to work within the Operations page click the negative sign next to Setup where the Setup Page will then collapse. Now click the plus sign next to Operations to find the menu items of choice without viewing unwanted menus and parameters. Once the focus is brought to an individual parameter (single click of mouse) as is the case for Analog Input 1 in the left column; all that can be setup related to that parameter will appear in the center column. The grayed out fields in the center column simply mean that this does not apply for the type of sensor selected. As an example, notice that when a thermocouple is selected, RTD Leads does not apply and is therefore grayed out.

To speed up the process of configuration notice that at the bottom of the center column there is an option to copy settings. If Analog Input 1 and 2 are the same type of sensor click on "Copy Settings" where a copy dialog box will appear allowing for quick duplication of all settings. Notice too, that by clicking on any of those items in the center column that context sensitive help will appear for that particular item in the right hand column.

Lastly, when the configuration is complete click the "Finish" button at the bottom right of the previous screen shot. The screen to the right follows this action.

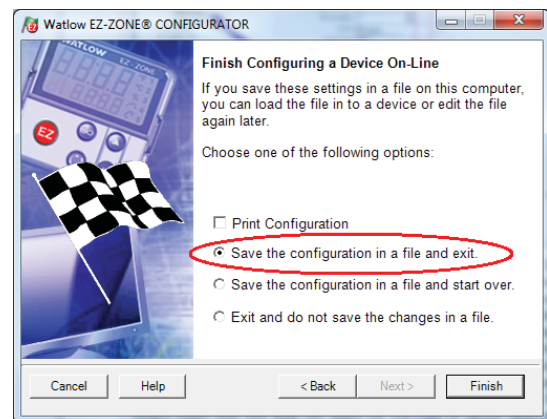

Although the PM control now contains the configuration (because the previous discussion focused on doing the configuration on-line) it is suggested that after the configuration process is completed that the user save this file on the PC for future use. If for some reason someone inadvertently changed a setting without understanding the impact, it would be easy and perhaps faster to download a saved configuration back to the control versus trying to figure out what was changed. Of course, there is an option to exit without saving a copy to the local hard drive. After selecting Save above, click the "Finish" button once again. The screen below will then appear. When saving the configuration, note the location where the file will be placed (saved in) and enter the file name (File name) as well. The default path for saved files follows:

Users\“Username”\My Documents\Watlow\EZ-Zone Configurator\Saved Configurations

The user can save the file to any folder of choice.

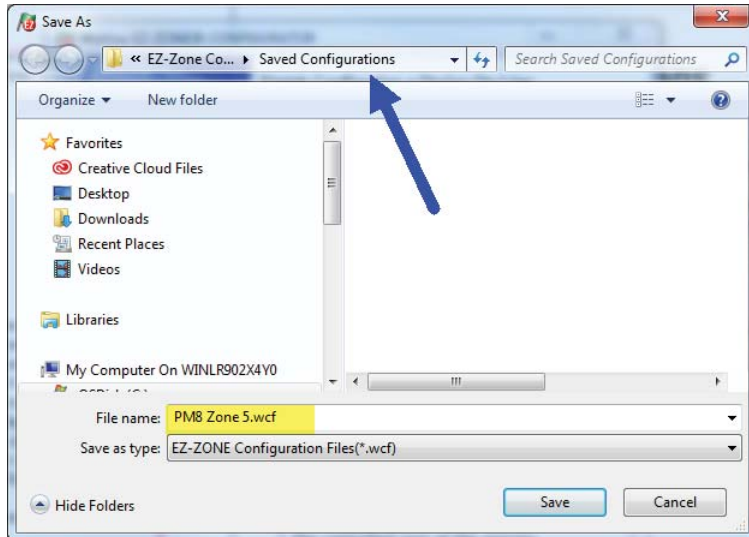

Chapter 10: Applications

Example 1: Single Loop Control

Requirements:

One input is required and at least one output adjusts the controlled part of the process.

Overview:

Controls one process value to a user entered Set Point based on a control algorithm.

Control loop 1 will control Analog Input 1 to Set Point 1.

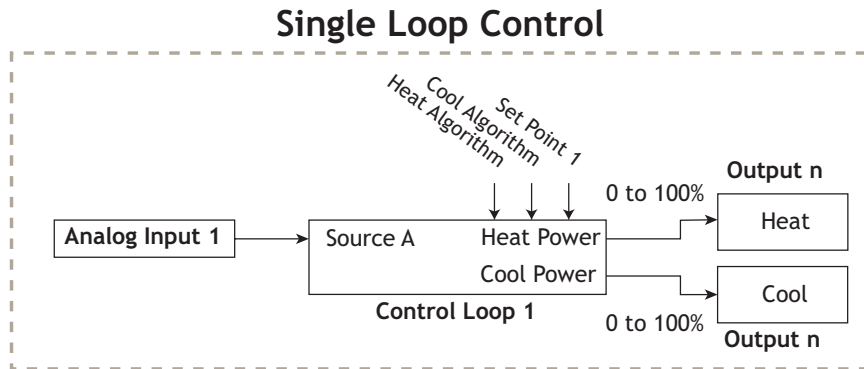

Example 2: Sensor Backup

Requirements:

Two analog inputs and the enhanced software option are required and at least one output adjusts the controlled part of the process.

Overview:

The Sensor Backup feature controls a process based on a primary sensor on Analog Input 1. If this sensor fails, then the process is controlled based on the secondary sensor on Analog Input 2.

When function is set for Sensor Backup, the PV Function output equals Source A if sensor of Analog Input 1 reading is valid or Source B if sensor reading is invalid. Control loop 1 will control the valid Analog Input sensor to Set Point 1.

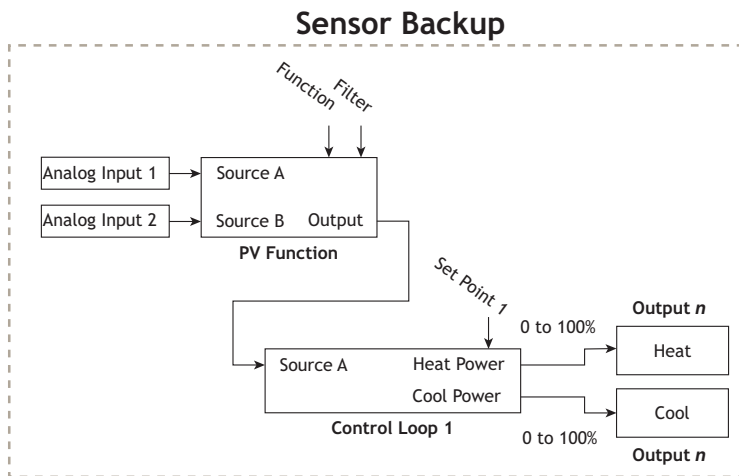

Example 3: Square Root

Requirements:

One analog input and the enhanced software option are required and at least one output adjusts the controlled part of the process.

Overview:

Calculates the square root value of the sensor connected to Analog Input 1.

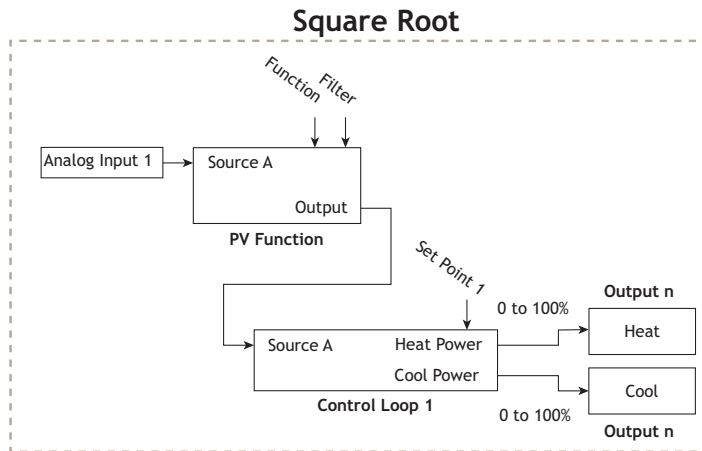

When function is set for Square Root, the PV Function output equals square root value of Source A. Control loop 1 will control Analog Input 1 to Set Point 1.

Example 4: Ratio

Requirements:

Two analog inputs and the enhanced software option are required and at least one output adjusts the controlled part of the process.

Overview:

The Ratio feature allows control of one process as a ratio of another process. This is especially useful in applications that mix two materials, whether steam, paint or food ingredients. Analog Input 1 monitors the controlled part of the process. Analog Input 2 of the controller measures the part of the process that is either uncontrolled or controlled by another device. The part of the process controlled will be maintained at a level equal to the quantity measured at input 2 multiplied by the ratio term set by the user as Set Point 1. When function is set for Ratio, the PV Function output equals Source A as a ratio to Source B. Control loop 1 will control Analog Input 1 to Set Point 1.

Applications of ratio control:

- Blending two or more flows to produce a mixture with specified composition.
- Blending two or more flows to produce a mixture with specified physical properties.
- Maintaining correct air and fuel mixture to combustion.

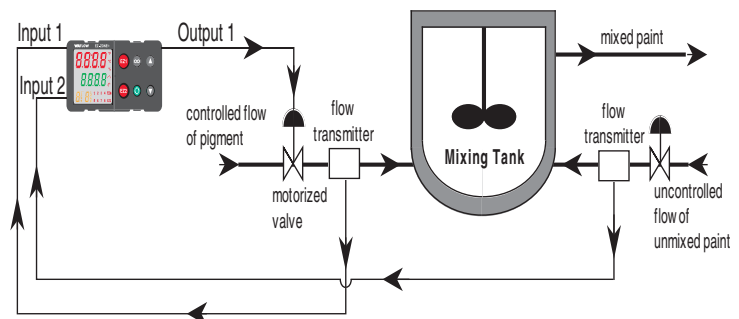

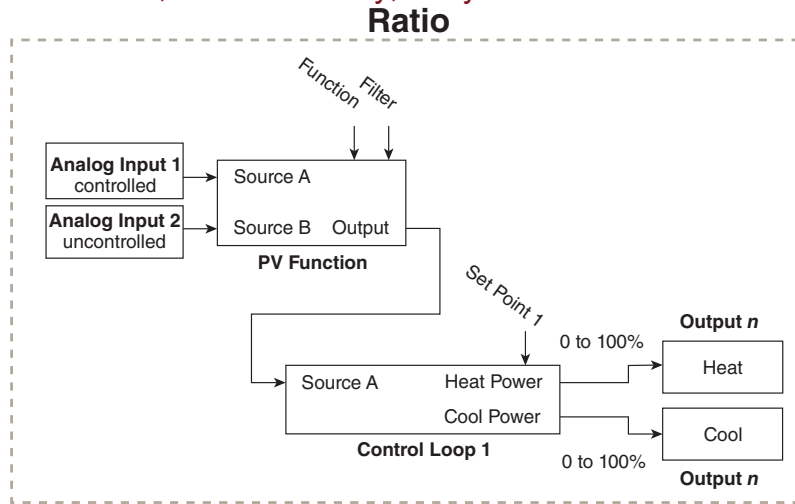

Example 5: Differential

Requirements:

Two analog inputs and the enhanced software option are required and at least one output adjusts the controlled part of the process.

Overview:

Differential control maintains one process at a difference to another process. When function is set for Differential, the PV Function output equals Source A minus Source B. Control loop 1 will control Analog Input 1 difference to Analog Input 2 based on Set Point 1.

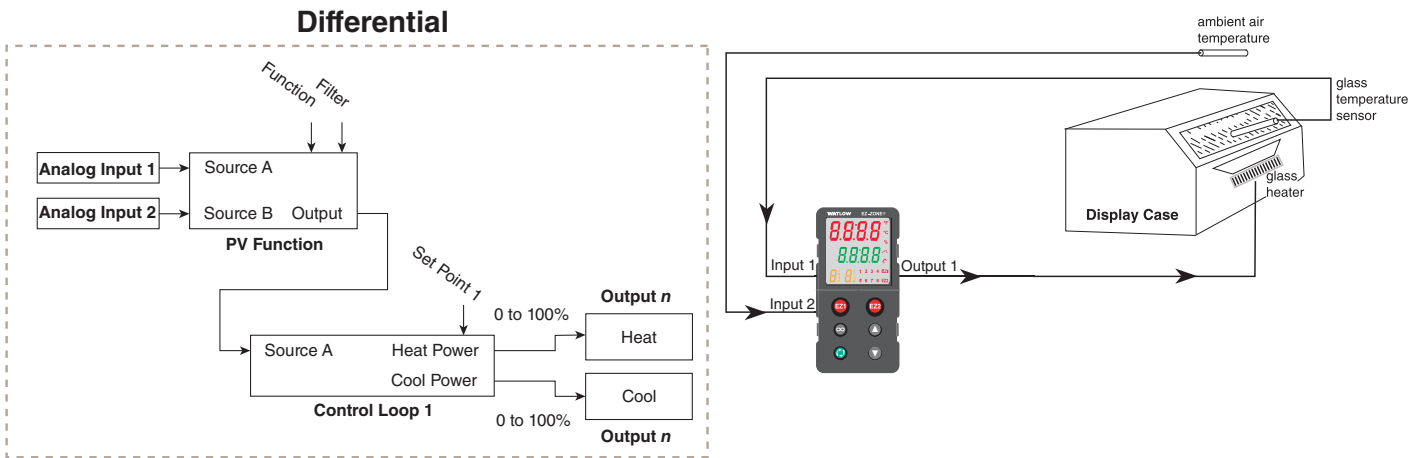

Example 6: Cascade

Requirements:

Two loops of control, two inputs and at least 1 output and the enhanced software option.

Overview: Cascade control can handle a difficult process with minimal overshoot, while reaching the set point quickly. This minimizes damage to system components and allows for over sizing heaters for optimal heat-up rates. Heater life is also extended by reducing thermal cycling of the heater. Systems with long lag times between the energy source (heater, steam, etc.) and the measured process value cannot be controlled accurately or efficiently with a single control loop, because a lot of energy can build up before a response is detected. This can cause the system to overshoot the set point, which could damage the heater, product or heat transfer medium, such as a heat transfer fluid.

The majority of the user configuration is done via the Math function. There are two user selectable settings that will enable Cascade control, Deviation Scale or process Scale. When Process Scale is selected the remote set point will be within the defined Range low/high and Scale low/high settings. As an example, the graph below shows a heat/cool application where the temperature range is between 32° to 1200°. With the scaling set as shown 100% cool will equate to 32°, likewise when the control is calling for 100% heat the temperature equates to 1200°.

When Deviation Scale is selected the Closed Loop Set Point (SP) will not deviate beyond the specified settings. With the settings as shown in the graph below the SP (500°) will not deviate beyond $\pm 25^\circ$.

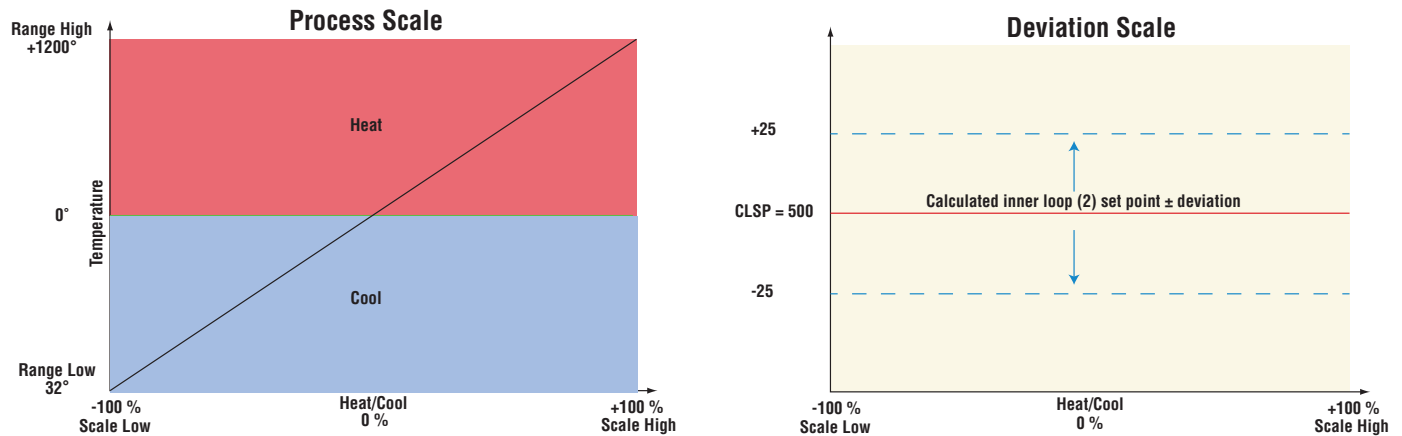

The graph below illustrates a system with a long lag time and the advantages in using cascade control. Curve A represents a single-control system with PID parameters that allow a maximum heat-up rate. Too much energy is introduced and the set point is overshoot. In most long-lag-time systems the process value may never settle out to an acceptable error. Curve C represents a single-control system tuned to minimize overshoot. This results in unacceptable heat-up rates, with the final value taking hours to reach. Curve B shows a cascade system that limits the energy introduced into the system allowing an optimal heat-up rate with minimal overshoot.

Note:

When using cascade control, two loops of control are required. Changing the control mode in either loop will affect both loops of control. In other words, if loop one is changed to manual mode, loop two will also be changed to manual mode automatically.

When the Math function is set for Process or Deviation Scale and Source E is not connected or false, cascade control is enabled.

Note:

When the Math function is set for Process or Deviation Scale the PM automatically makes the connections for each Control Loop as shown in the graphic below. Each loop, 1 (process) and 2 (energy) outer and inner respectively, cannot be changed. If it is desired to display the inner loop process variable and set point, the home page must be changed via the Factory Page, Custom Menu.

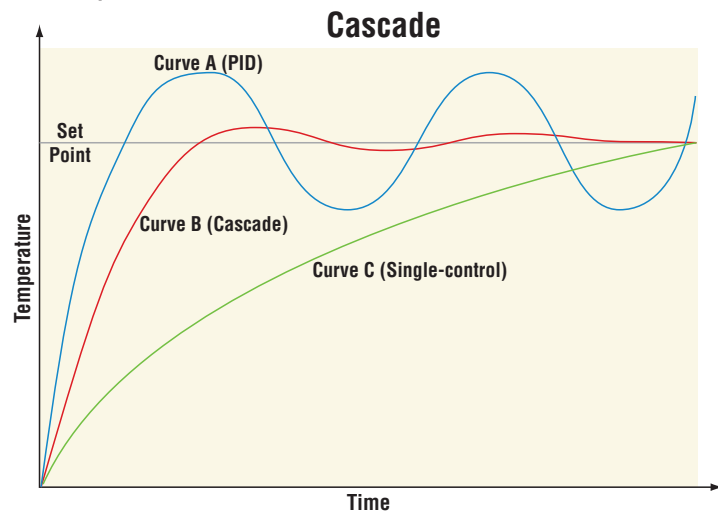

Cascade control uses two control loops (outer - loop 1 and inner - loop 2) to control the process. The outer loop (Analog Input 1) monitors the process or part temperature, which is then compared to the Set Point. The result of the comparison, the error signal, is acted on by the PID settings and the Range and Scale high/low settings. Ultimately, the outer loop produces a remote set point for the inner loop. The inner loop input (Analog input 2) monitors the energy source (heating and cooling), which is compared to the remote set point generated by the outer loop. The result of the comparison, the error signal, is acted on by the PID settings in the cascade inner loop (2), which generates an output power level between -100% to +100%. If the power level is positive the heat will be on; if the power level is negative the cool will come on. Power from the energy sources are supplied by the outputs of choice always referenced to Control loop 2.

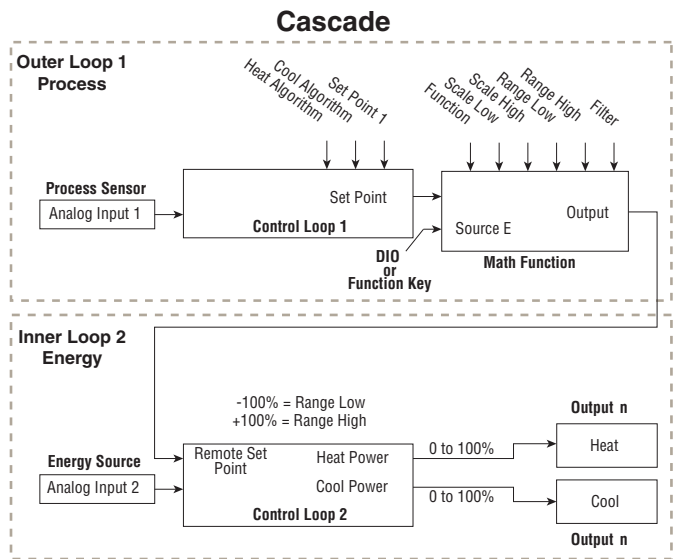

When cascade control is disabled (Source E is true), the Math function output will equal Control Loop 1, Set Point.

Note:

If an input sensor on the outer loop fails when using deviation cascade the inner loop will continue to drive the output.

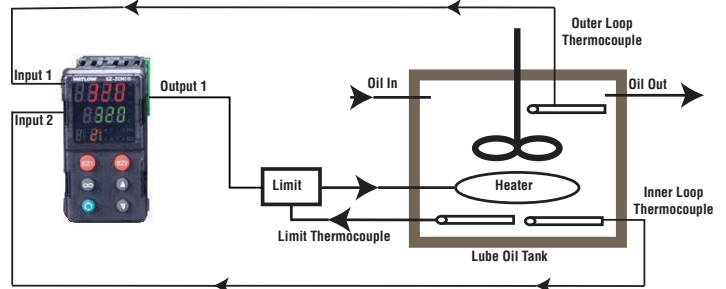

Example 7: Wet Bulb / Dry Bulb

Requirements:

Two analog inputs and at least one output are required to adjust the controlled part of the processes.

Overview:

Wet Bulb/Dry Bulb is a configuration where a dry bulb connected to Analog Input 1 measures temperature on Analog Input 1. A wet bulb sensor that is maintained with moisture has air moved over the sensor. As moisture evaporates from the wet bulb, the temperature drops. A wet bulb input on Analog Input 2, in combination with the dry bulb temperature, senses relative humidity. The controller calculates the temperature difference between the two sensors to determine percent relative humidity. The humidify and dehumidify outputs are disabled when Analog Input 1 temperature falls below 32 F/0 C, or goes above 212 F/100 C. When function is set for Wet Bulb/Dry Bulb, the PV Function output equals calculated humidity. Control loop 1 will control Analog Input 1 to Set Point 1. Control loop 2 will control Analog Input 2 to Set Point 2.

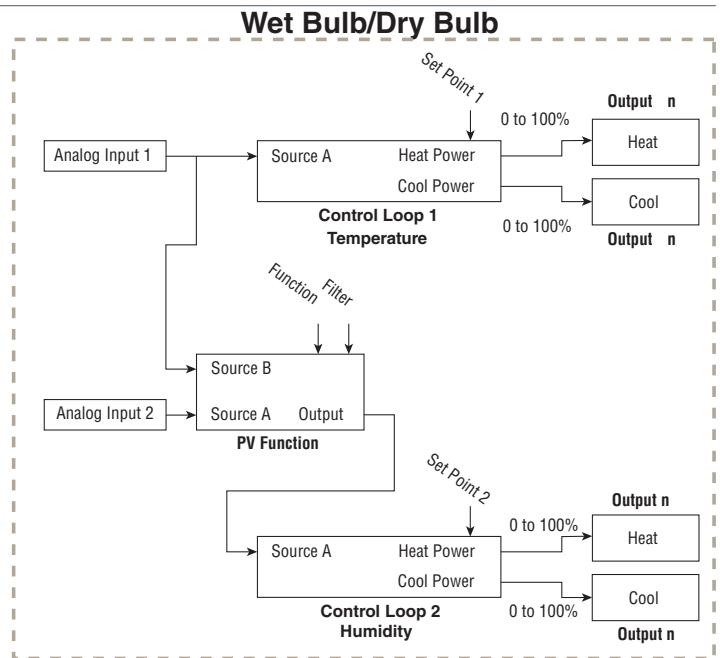

Example 8: Vaisala

Requirements: Two analog inputs and the enhanced software option are required and at least two outputs adjusts the controlled temperature and humidity processes.

Overview:

Vaisala Model HMM-30C Solid-state Relative Humidity Sensor is supported with the Vaisala configuration. Analog Input 1 is used to measure temperature and Analog Input 2 must be a process input connected to a Vaisala sensor. The controller provides temperature compensation for the Vaisala sensor. The humidify and dehumidify outputs are disabled when Analog Input 1 temperature falls below -40 F/- 40 C, or goes above 320 F/160 C. When function is set for Vaisala, the PV Function output equals the calculated relative humidity compensated by the sensor on Analog Input 1.

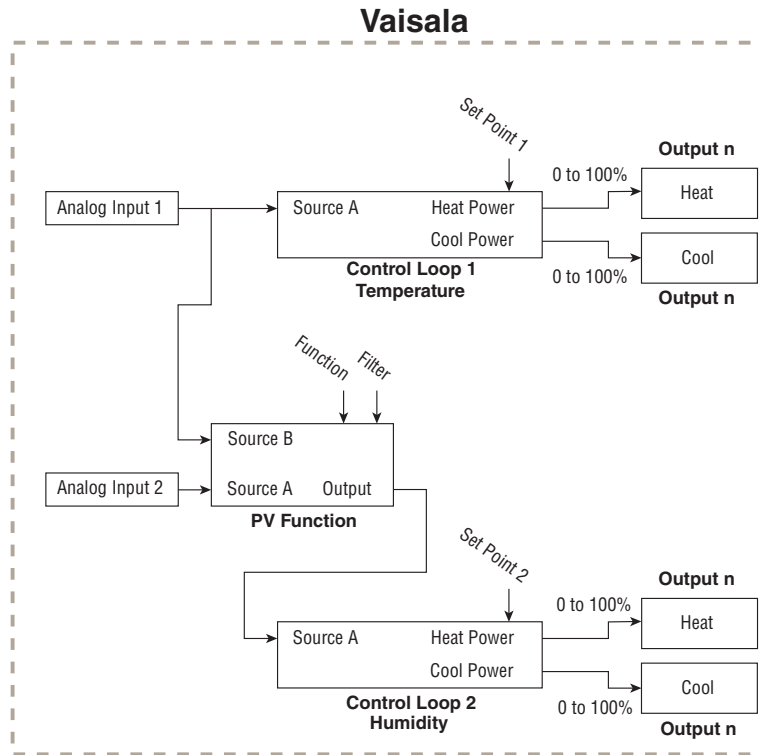

Example 9: Motorized Valve Control

A typical scenario where a motorized valve is used is to regulate the flow of fluid which in turn impacts the loop process value. A valve is opened or closed by closing contacts to drive the value in the intended direction. Motorized Valves come in a number of configurations. Some valves have a position feedback mechanism that allows the control to measure the valve's position via an internal potentiometer called slide-wire. The controller can measure the potentiometer resistance to determine the initial valve position on power up.

This method may not be desirable for three reasons:

- 1) It requires a second input on the controller to measure valve position.
- 2) The controller and the valve are more expensive.
- 3) Additional wiring is required for the slide-wire feedback.

Other valves take an analog signal

and have a localized control mechanism that regulates the valve position. These are typically more expensive valves because of the control mechanism built-in plus it requires an analog signal which is not always available. The actual valve position is not critical because it is a part of a closed loop control.

The Motorized Valve control algorithm is also designed to work with a type of valve that provides two discrete signals: one to open the valve and another to close the valve. The algorithm turns on/off the appropriate signal for an appropriate amount of time to approximate the valve position. This works when the valve is inside a closed control loop because when the valve is not in the correct position, the PID algorithm will adjust the valve further open or close as needed. These valves have travel limit switches which deactivates the motor once the valve is fully open or fully closed so the controller can not cause the valve to over travel and burn out the motor, or the motor is built so it can not overheat at max locked rotor amperes.

To use the motorized feature, the user programs the Special Output Function to Motorized Valve.

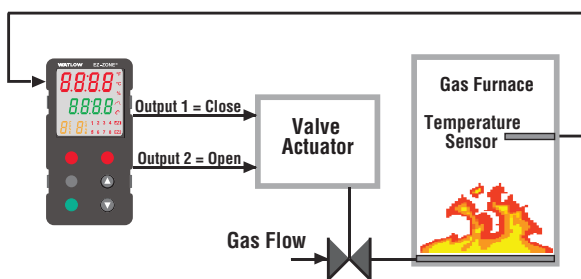

Then the Source Function A is selected to either Heat or Cool Power and Source Instance A is set to match the control loop, typically 1.

Next the user enters the amount of time in seconds that the valve requires power to go from a closed state to an open state. The user enters the dead band in percent PID power to prevent the valve from excessive cycling. Larger numbers reduce activity on the valve and smaller numbers improve controllability. Select a value that compromises on

these two competing goals.

Lastly, assign an output to Special Output Function 1 that is wired to close the valve. Assign an output to Special Output Function 2 that is wired to open the valve. Typically, these two outputs are normally open mechanical relays but solid state relays or switch DC outputs may be programmed in the same manner.

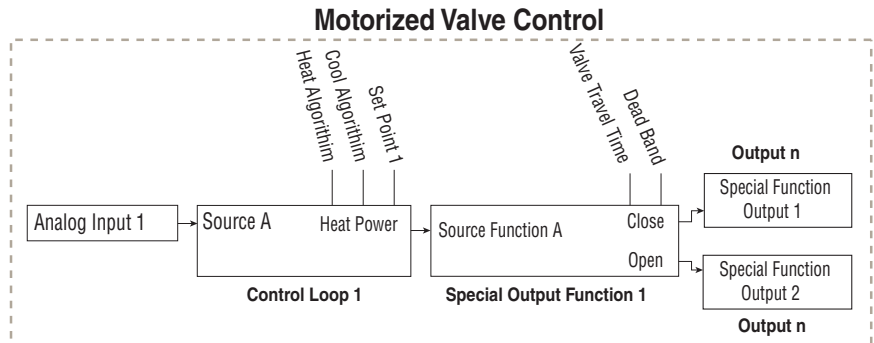

Definitions:

- Current Position is an approximation of the valve's position as it relates to a power level (0 - 100%) where 0% is fully closed and 100% is fully open.
- Dead Time is the minimum on time that the valve will travel once it is turned on in either the closed or open direction. $Dead\ Time = Valve\ Dead\ Band / 100 * Valve\ Travel\ Time.$
- Valve Travel Time is the amount of time the valve needs to be turned on (either open or close) to eliminate the error between the estimated valve position and the desired power level. A positive On Time value indicates the need to open the valve while a negative value indicates the need to close the valve. $On\ Time = (Input\ 1\ Value - Current\ Position) / 100 * Valve\ Travel\ Time$
When power is applied to the controller, the valve is closed and time is set to 0.
- Special Output Function 1 is the close signal to the valve.
- Special Output Function 2 is the open signal to the valve

Chapter 11: Appendix

Troubleshooting Alarms, Errors and Control Issues

Indication	Description	Possible Cause(s)	Corrective Action
Alarm won't clear or reset	Alarm will not clear or reset with keypad or digital input	<ul style="list-style-type: none"> • Latching is active • Alarm set to incorrect output • Alarm is set to incorrect source • Sensor input is out of alarm set point range • Alarm set point is incorrect • Alarm is set to incorrect type • Digital input function is incorrect 	<ul style="list-style-type: none"> • Reset alarm when process is within range or disable latching • Set output to correct alarm source instance • Set alarm source to correct input instance • Correct cause of sensor input out of alarm range • Set alarm set point to correct trip point • Set alarm to correct type: process, deviation or power • Set digital input function and source instance
Alarm won't occur	Alarm will not activate output	<ul style="list-style-type: none"> • Silencing is active • Blocking is active • Alarm is set to incorrect output • Alarm is set to incorrect source • Alarm set point is incorrect • Alarm is set to incorrect type 	<ul style="list-style-type: none"> • Disable silencing, if required • Disable blocking, if required • Set output to correct alarm source instance • Set alarm source to correct input instance • Set alarm set point to correct trip point • Set alarm to correct type: process, deviation or power
Alarm Error <i>ALE 1</i> <i>ALE 2</i> <i>ALE 3</i> <i>ALE 4</i>	Alarm state cannot be determined due to lack of sensor input	<ul style="list-style-type: none"> • Sensor improperly wired or open • Incorrect setting of sensor type • Calibration corrupt 	<ul style="list-style-type: none"> • Correct wiring or replace sensor • Match setting to sensor used • Check calibration of controller

Indication	Description	Possible Cause(s)	Corrective Action
Alarm Low <i>ALL 1</i> <i>ALL 2</i> <i>ALL 3</i> <i>ALL 4</i>	Sensor input below low alarm set point	<ul style="list-style-type: none"> • Temperature is less than alarm set point • Alarm is set to latching and an alarm occurred in the past • Incorrect alarm set point • Incorrect alarm source 	<ul style="list-style-type: none"> • Check cause of under temperature • Clear latched alarm • Establish correct alarm set point • Set alarm source to proper setting
Alarm High <i>ALh 1</i> <i>ALh 2</i> <i>ALh 3</i> <i>ALh 4</i>	Sensor input above high alarm set point	<ul style="list-style-type: none"> • Temperature is greater than alarm set point • Alarm is set to latching and an alarm occurred in the past • Incorrect alarm set point • Incorrect alarm source 	<ul style="list-style-type: none"> • Check cause of over temperature • Clear latched alarm • Establish correct alarm set point • Set alarm source to proper setting
Error Input <i>Er. 11</i> <i>Er. 12</i>	Sensor does not provide a valid signal to controller	<ul style="list-style-type: none"> • Sensor improperly wired or open • Incorrect setting of sensor type • Calibration corrupt 	<ul style="list-style-type: none"> • Correct wiring or replace sensor • Match setting to sensor used • Check calibration of controller
Ambient Error <i>Er.AB</i>	Sensor does not provide a valid signal to controller	<ul style="list-style-type: none"> • Ambient error - cold junction circuitry not working 	<ul style="list-style-type: none"> • Return to factory for repair
Limit won't clear or reset	Limit will not clear or reset with keypad or digital input	<ul style="list-style-type: none"> • Sensor input is out of limit set point range • Limit set point is incorrect • Digital input function is incorrect 	<ul style="list-style-type: none"> • Correct cause of sensor input out of limit range • Set limit set point to correct trip point • Set digital input function and source instance
Limit Error <i>LE 1</i>	Limit state cannot be determined due to lack of sensor input, limit will trip	<ul style="list-style-type: none"> • Sensor improperly wired or open • Incorrect setting of sensor type • Calibration corrupt 	<ul style="list-style-type: none"> • Correct wiring or replace sensor • Match setting to sensor used • Check calibration of controller

Indication	Description	Possible Cause(s)	Corrective Action
Limit Low <i>L.L.1</i>	Sensor input below low limit set point	<ul style="list-style-type: none"> • Temperature is less than limit set point • Limit outputs latch and require reset • Incorrect alarm set point 	<ul style="list-style-type: none"> • Check cause of under temperature • Clear limit • Establish correct limit set point
Limit High <i>L.H.1</i>	Sensor input above high limit set point	<ul style="list-style-type: none"> • Temperature is greater than limit set point • Limit outputs latch and require reset • Incorrect alarm set point 	<ul style="list-style-type: none"> • Check cause of over temperature • Clear limit • Establish correct limit set point
Loop Open Error <i>L.P.O.1</i> <i>L.P.O.2</i>	Open Loop Detect is active and the process value did not deviate by a user-selected value in a user specified period with PID power at 100%.	<ul style="list-style-type: none"> • Setting of Open Loop Detect Time incorrect • Setting of Open Loop Detect Deviation incorrect • Thermal loop is open • Open Loop Detect function not required but activated 	<ul style="list-style-type: none"> • Set correct Open Loop Detect Time for application • Set correct Open Loop Deviation value for application • Determine cause of open thermal loop: misplaced sensors, load failure, loss of power to load, etc. • Deactivate Open Loop Detect feature
Loop Reversed Error <i>L.P.R.1</i> <i>L.P.R.2</i>	Open Loop Detect is active and the process value is headed in the wrong direction when the output is activated based on deviation value and user-selected value.	<ul style="list-style-type: none"> • Setting of Open Loop Detect Time incorrect • Setting of Open Loop Detect Deviation incorrect • Output programmed for incorrect function • Thermocouple sensor wired in reverse polarity 	<ul style="list-style-type: none"> • Set correct Open Loop Detect Time for application • Set correct Open Loop Deviation value for application • Set output function correctly • Wire thermocouple correctly, (red wire is negative)
Ramping <i>r.P.1</i> <i>r.P.2</i>	Controller is ramping to new set point	<ul style="list-style-type: none"> • Ramping feature is activated 	<ul style="list-style-type: none"> • Disable ramping feature if not required

Indication	Description	Possible Cause(s)	Corrective Action
Autotuning <i>tUn1</i> <i>tUn2</i>	Controller is autotuning the control loop	<ul style="list-style-type: none"> User started the autotune function Digital input is set to start autotune 	<ul style="list-style-type: none"> Wait until autotune completes or disable autotune feature Set digital input to function other than autotune, if desired
No heat/cool action	Output does not activate load	<ul style="list-style-type: none"> Output function is incorrectly set Control mode is incorrectly set Output is incorrectly wired Load, power or fuse is open Control set point is incorrect Incorrect controller model for application 	<ul style="list-style-type: none"> Set output function correctly Set control mode appropriately (Open vs Closed Loop) Correct output wiring Correct fault in system Set control set point in appropriate control mode and check source of set point: remote, idle, profile, closed loop, open loop Obtain correct controller model for application
No Display	No display indication or LED illumination	<ul style="list-style-type: none"> Power to controller is off Fuse open Breaker tripped Safety interlock switch open Separate system limit control activated Wiring error Incorrect voltage to controller 	<ul style="list-style-type: none"> Turn on power Replace fuse Reset breaker Close interlock switch Reset limit Correct wiring issue Apply correct voltage, check part number

Indication	Description	Possible Cause(s)	Corrective Action
No Serial Communication	Cannot establish serial communications with the controller	<ul style="list-style-type: none"> • Address parameter incorrect • Incorrect protocol selected • Baud rate incorrect • Parity incorrect • Wiring error • EIA-485 converter issue • Incorrect computer or PLC communications port • Incorrect software setup • Wires routed with power cables • Termination resistor may be required 	<ul style="list-style-type: none"> • Set unique addresses on network • Match protocol between devices • Match baud rate between devices • Match parity between devices • Correct wiring issue • Check settings or replace converter • Set correct communication port • Correct software setup to match controller • Route communications wires away from power wires • Place 120 Ω resistor across EIA-485 on last controller
Process doesn't control to set point	Process is unstable or never reaches set point	<ul style="list-style-type: none"> • Controller not tuned correctly • Control mode is incorrectly set • Control set point is incorrect 	<ul style="list-style-type: none"> • Perform autotune or manually tune system • Set control mode appropriately (Open vs Closed Loop) • Set control set point in appropriate control mode and check source of set point: remote, idle, profile, closed loop, open loop
Temperature runaway	Process value continues to increase or decrease past set point.	<ul style="list-style-type: none"> • Controller output incorrectly programmed • Thermocouple reverse wired • Controller output wired incorrectly • Short in heater • Power controller connection to controller defective • Controller output defective 	<ul style="list-style-type: none"> • Verify output function is correct (heat or cool) • Correct sensor wiring (red wire negative) • Verify and correct wiring • Replace heater • Replace or repair power controller • Replace or repair controller

Indication	Description	Possible Cause(s)	Corrective Action
Device Error <i>100</i> <i>rErr</i>	Controller displays internal malfunction message at power up.	<ul style="list-style-type: none"> • Controller defective • Sensor input over driven 	<ul style="list-style-type: none"> • Replace or repair controller • Check sensors for ground loops, reverse wiring or out of range values.
Heater Error <i>hEr</i>	Heater Error	<ul style="list-style-type: none"> • Current through load is above current trip set point • Current through load is below current trip set point 	<ul style="list-style-type: none"> • Check that the load current is proper. Correct cause of over current and/or ensure current trip set point is correct. • Check that the load current is proper. Correct cause of undercurrent and/or ensure current trip set point is correct.
Current Error <i>CEr</i>	Load current incorrect.	<ul style="list-style-type: none"> • Shorted solid-state or mechanical relay • Open solid-state or mechanical relay • Current transformer load wire associated to wrong output • Defective current transformer or controller • Noisy electrical lines 	<ul style="list-style-type: none"> • Replace relay • Replace relay • Route load wire through current transformer from correct output, and go to the <i>CS</i>, Source Output Instance parameter (Setup Page, Current Menu) to select the output that is driving the load. • Replace or repair sensor or controller • Route wires appropriately, check for loose connections, add line filters
Menus inaccessible	Unable to access <i>SEt</i> , <i>oPEr</i> , <i>FcTy</i> or <i>PrOF</i> menus or particular prompts in Home Page	<ul style="list-style-type: none"> • Security set to incorrect level • Digital input set to lock-out keypad • Custom parameters incorrect 	<ul style="list-style-type: none"> • Check <i>LoC</i> settings in Factory Page and enter appropriate password in <i>ULoC</i> setting in Factory Page • Change state of digital input • Change custom parameters in Factory Page

Indication	Description	Possible Cause(s)	Corrective Action
EZ-Key/s do not work	EZ-Key/s do not activate required function	<ul style="list-style-type: none"> • EZ-Key function incorrect • EZ-Key function instance not correct • Keypad malfunction 	<ul style="list-style-type: none"> • Verify EZ-Key function in the Setup Menu • Correct and change the function instance if not correct • Replace or repair controller
Displayed value to low <i>uALL</i>	Value to low to be displayed in 4 digit LED display <-1999	<ul style="list-style-type: none"> • Incorrect setup 	<ul style="list-style-type: none"> • Check scaling of source data
Displayed value to high <i>uALh</i>	Value to high to be displayed in 4 digit LED display >9999	<ul style="list-style-type: none"> • Incorrect setup 	<ul style="list-style-type: none"> • Check scaling of source data

Detection of and Rules Around Abnormal Sensor Conditions	
Inputs	Detection of Abnormal Conditions
Thermocouple	
Shorted	No direct detection, Open loop firmware detection.
Open	Yes, Parasitic pull-up
Reversed	Yes, firmware detection
Current Source	
Shorted	Range limiting only
Open	Range limiting only
Reversed	Range limiting only
Voltage Source	
Open	Range limiting only
Shorted	Range limiting only
Reversed	Range limiting only
RTD	
S1 open	Yes, pulled up.
S2 open	Not implemented.
S3 open	Yes, pulled up.
S1 short to S2	Yes, pulled up
S1 short to S3	Yes, pulled down to under range.
S2 shorted to S3	Not implemented, Possible, monitor S2 voltage.
S1 and S2 open	Yes, pulled down to under range.
S1 and S3 open	Yes, S1 pulled up.
S2 and S3 open	Yes pulled up.
Thermistor	
S1 open	Yes, pulled up to sensor over range.
S3 open	Yes, pulled up to sensor over range.
S1 short to S3	Yes, pulled down to sensor under range.
S1 and S3 open	Yes, S1 pulled up to sensor over range.

Modbus - Programmable Memory Blocks

The Modbus assembly or programmable memory blocks consists of 40 pointers to the parameters of your choosing starting at Modbus register 40 (shown on the following page). The pointers are 32-bits long and are stored in two sequential registers. As an example, if it is desired to move an alias to the analog input of the PM (**register 360**) into pointer registers 40 and 41, a single multi-write command (0x10 function) would be used writing 360 into register 40 and 361 into register 41.

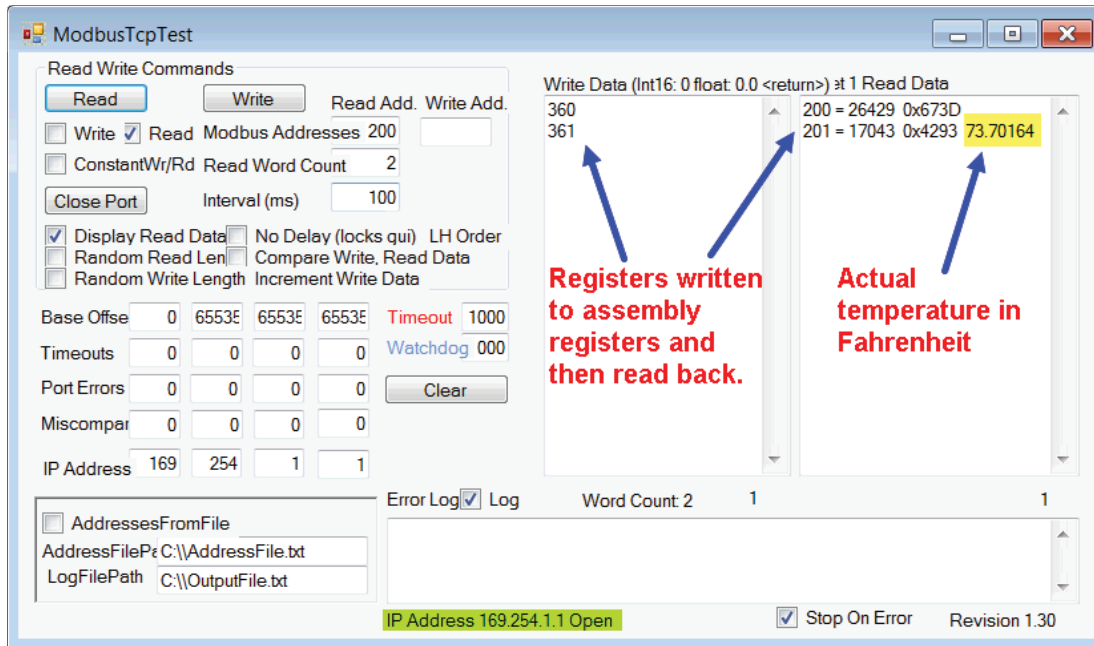

Once the parameters of choice have been defined and written to the specified pointer registers, the working registers will then represent the parameters written. In the example above, the 32-bit floating point analog input (360 and 361) was first written to registers 40 and 41 which in turn defines working registers 200 and 201 as Analog Input 1. As can be seen in the far right-hand column in the graphic above, reading back registers 200 and 201 the temperature, as detected by the first analog input is displayed.

The screen shot above was taken from a program that can be found on the Watlow Support Tools DVD (shipped with the product) as well as on the Watlow website. On the DVD, it can be found under "Utility Tools" and is identified as "Modbus TCP Diagnostic Program for EZ-ZONE PM, RM and ST". A similar program can be found here as well for Modbus RTU. If it is easier to go to the web to acquire this software, click on the link below and type "modbus" in the search field where both versions can be found and downloaded. <http://www.watlow.com/en/resources-and-support/Technical-Library/Software-and-Demos>

Assembly Definition Addresses and Assembly Working Addresses

Pointer Registers	Working Registers
40 & 41	200 & 201
42 & 43	202 & 203
44 & 45	204 & 205
46 & 47	206 & 207
48 & 49	208 & 209
50 & 51	210 & 211
52 & 53	212 & 213
54 & 55	214 & 215
56 & 57	216 & 217
58 & 59	218 & 219
60 & 61	220 & 221
62 & 63	222 & 223
64 & 65	224 & 225
66 & 67	226 & 227
68 & 69	228 & 229
70 & 71	230 & 231
72 & 73	232 & 233
74 & 75	234 & 235
76 & 77	236 & 237
78 & 79	238 & 239
80 & 81	240 & 241
82 & 83	242 & 243
84 & 85	244 & 245
86 & 87	246 & 247
88 & 89	248 & 249
90 & 91	250 & 251
92 & 93	252 & 253
94 & 95	254 & 255
96 & 97	256 & 257
98 & 99	256 & 259
100 & 101	260 & 261
102 & 103	262 & 263
104 & 105	264 & 265
106 & 107	266 & 267
108 & 109	268 & 269
110 & 111	270 & 271
112 & 113	272 & 273
114 & 115	274 & 275
116 & 117	276 & 277
118 & 119	278 & 279

Modbus Default Assembly Structure 40-119

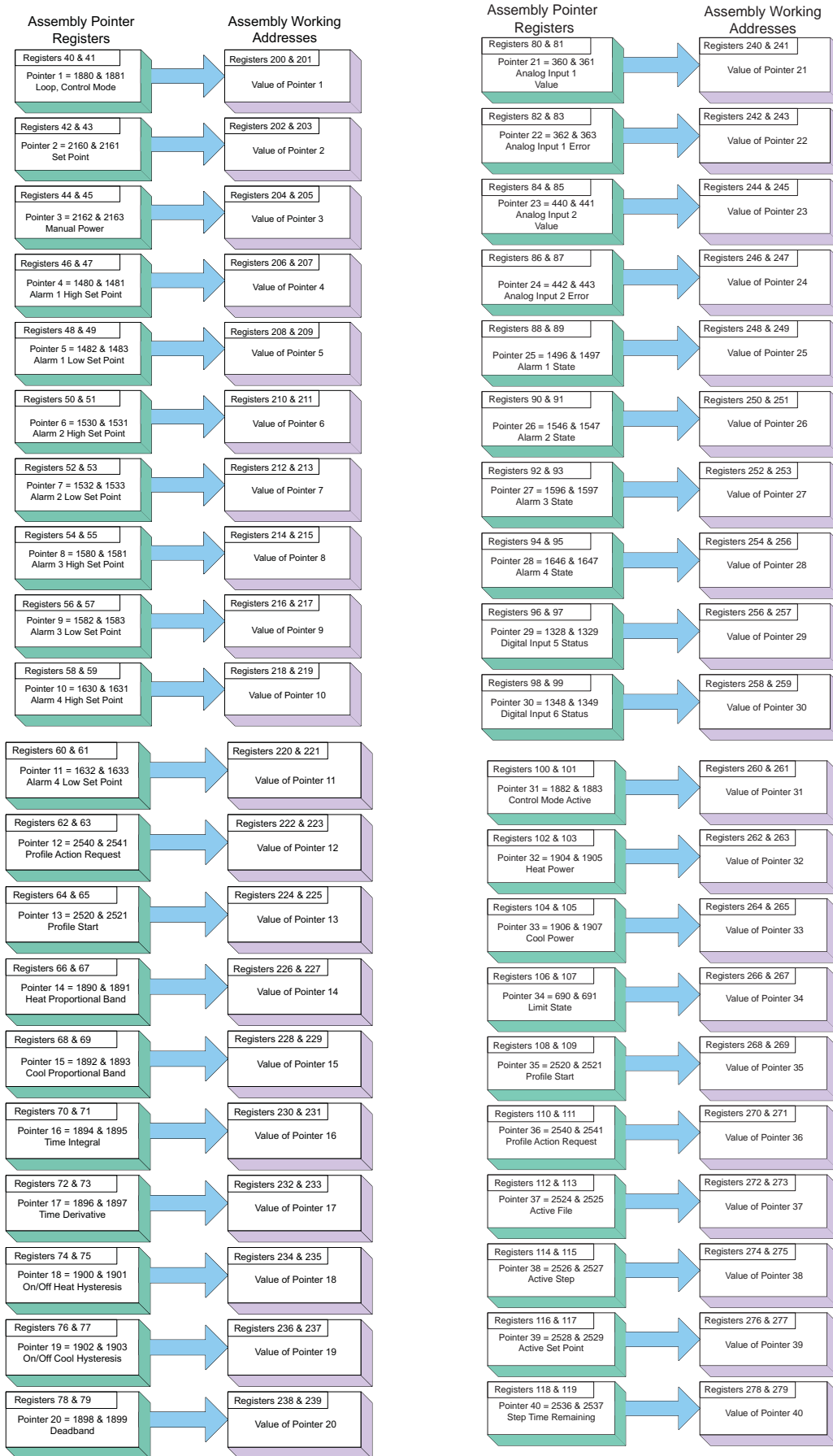

CIP Implicit Assembly Structures

CIP Implicit Assembly Originator (Master) to Target (PM)					
Assembly Members	Assembly Class, Instance, Attribute	ST Data Type	Parameter	Parameter Class, Instance, Attribute	PLC Data Type
1	0x77, 0x01, 0x01	DINT	Loop 1 - Control Mode	0x97, 0x01, 0x01	DINT
2	0x77, 0x01, 0x02	DINT	Loop 1 - Set Point	0x6B, 0x01, 0x01	REAL
3	0x77, 0x01, 0x03	DINT	Loop 1 - Manual Power	0x6B, 0x01, 0x02	REAL
4	0x77, 0x01, 0x04	DINT	Alarm 1 - High Set Point	0x6D, 0x01, 0x01	REAL
5	0x77, 0x01, 0x05	DINT	Alarm 1 - Low Set Point	0x6D, 0x01, 0x02	REAL
6	0x77, 0x01, 0x06	DINT	Alarm 2 - High Set Point	0x6D, 0x02, 0x01	REAL
7	0x77, 0x01, 0x07	DINT	Alarm 2 - Low Set Point	0x6D, 0x02, 0x02	REAL
8	0x77, 0x01, 0x08	DINT	Alarm 3 - High Set Point	0x6D, 0x03, 0x01	REAL
9	0x77, 0x01, 0x09	DINT	Alarm 3 - Low Set Point	0x6D, 0x03, 0x02	REAL
10	0x77, 0x01, 0x0A	DINT	Alarm 4 - High Set Point	0x6D, 0x04, 0x01	REAL
11	0x77, 0x01, 0x0B	DINT	Alarm 4 - Low Set Point	0x6D, 0x04, 0x02	REAL
12	0x77, 0x01, 0x0C	DINT	Profile Action Request	0x7A, 0x01, 0x0B	DINT
13	0x77, 0x01, 0x0D	DINT	Profile Start	0x7A, 0x01, 0x01	DINT
14	0x77, 0x01, 0x0E	DINT	Loop 1 - Heat Proportional Band	0x97, 0x01, 0x06	REAL
15	0x77, 0x01, 0x0F	DINT	Loop 1 - Cool Proportional Band	0x97, 0x01, 0x07	REAL
16	0x77, 0x01, 0x10	DINT	Loop 1 - Time Integral	0x97, 0x01, 0x08	REAL
17	0x77, 0x01, 0x11	DINT	Loop 1 - Time Derivative	0x97, 0x01, 0x09	REAL
18	0x77, 0x01, 0x12	DINT	Loop 1 - Heat Hysteresis	0x97, 0x01, 0x0B	REAL
19	0x77, 0x01, 0x13	DINT	Loop 1 - Cool Hysteresis	0x97, 0x01, 0x0C	REAL
20	0x77, 0x01, 0x14	DINT	Loop 1 - Dead Band	0x97, 0x01, 0x0A	REAL
21	0x77, 0x02, 0x15	DINT	None Specified	----	----
22	0x77, 0x02, 0x16	DINT	None Specified	----	----
23	0x77, 0x02, 0x17	DINT	None Specified	----	----
24	0x77, 0x02, 0x18	DINT	None Specified	----	----
25	0x77, 0x02, 0x19	DINT	None Specified	----	----
26	0x77, 0x02, 0x1A	DINT	None Specified	----	----
27	0x77, 0x02, 0x1B	DINT	None Specified	----	----
28	0x77, 0x02, 0x1C	DINT	None Specified	----	----
29	0x77, 0x02, 0x1D	DINT	None Specified	----	----
30	0x77, 0x02, 0x1E	DINT	None Specified	----	----
31	0x77, 0x02, 0x1F	DINT	None Specified	----	----
32	0x77, 0x02, 0x20	DINT	None Specified	----	----
33	0x77, 0x02, 0x21	DINT	None Specified	----	----
34	0x77, 0x02, 0x22	DINT	None Specified	----	----
35	0x77, 0x02, 0x23	DINT	None Specified	----	----
36	0x77, 0x02, 0x24	DINT	None Specified	----	----
37	0x77, 0x02, 0x25	DINT	None Specified	----	----
38	0x77, 0x02, 0x26	DINT	None Specified	----	----
39	0x77, 0x02, 0x27	DINT	None Specified	----	----
40	0x77, 0x02, 0x28	DINT	None Specified	----	----

Note:

PM revision 15 and above firmware allows for 40 implicit members. Revisions below 15 allow for a maximum of 20.

Note:

Although 40 members are built into PM/RM controllers, the RUI allows for a maximum of 20. If 40 members are needed, consider using the EZ-ZONE RMA module.

CIP Implicit Assembly Target (PM) to Originator (Master)					
Assembly Members	Assembly Class, Instance, Attribute	ST Data Type	Parameter	Parameter Class, Instance, Attribute	PLC Data Type
- - - -	Cannot be changed	Binary	Device Status	None	BIN
1	0x77, 0x02, 0x01	DINT	Analog Input 1, Analog Input Value	0x68, 0x01, 0x01	REAL
2	0x77, 0x02, 0x02	DINT	Analog Input 1, Input Error	0x68, 0x01, 0x02	REAL
3	0x77, 0x02, 0x03	DINT	Analog Input 2, Analog Input Value	0x68, 0x02, 0x01	REAL
4	0x77, 0x02, 0x04	DINT	Analog Input 2, Input Error	0x68, 0x02, 0x02	REAL
5	0x77, 0x02, 0x05	DINT	Alarm 1, Alarm State	0x6D, 0x01, 0x09	DINT
6	0x77, 0x02, 0x06	DINT	Alarm 2, Alarm State	0x6D, 0x02, 0x09	DINT
7	0x77, 0x02, 0x07	DINT	Alarm 3, Alarm State	0x6D, 0x03, 0x09	DINT
8	0x77, 0x02, 0x08	DINT	Alarm 4, Alarm State	0x6D, 0x04, 0x09	DINT
9	0x77, 0x02, 0x09	DINT	Event Status 1	0x6E, 0x01, 0x05	DINT
10	0x77, 0x02, 0x0A	DINT	Event Status 2	0x6E, 0x02, 0x05	DINT
11	0x77, 0x02, 0x0B	DINT	Loop 1 - Control Mode Active	0x97, 0x01, 0x02	DINT
12	0x77, 0x02, 0x0C	DINT	Loop 1 - Heat Power	0x97, 0x01, 0x0D	REAL
13	0x77, 0x02, 0x0D	DINT	Loop 1 - Cool Power	0x97, 0x01, 0x0E	REAL
14	0x77, 0x02, 0x0E	DINT	Limit State	0x70, 0x01, 0x06	DINT
15	0x77, 0x02, 0x0F	DINT	Profile Start	0x7A, 0x01, 0x01	DINT
16	0x77, 0x02, 0x10	DINT	Profile Action Request	0x7A, 0x01, 0x0B	DINT
17	0x77, 0x02, 0x11	DINT	Current Profile	0x7A, 0x01, 0x03	DINT
18	0x77, 0x02, 0x12	DINT	Current Step	0x7A, 0x01, 0x04	DINT
19	0x77, 0x02, 0x13	DINT	Loop 1 - Active Set Point	0x7A, 0x01, 0x05	REAL
20	0x77, 0x02, 0x14	DINT	Step Time Remaining	0x7A, 0x01, 0x09	DINT
21	0x77, 0x02, 0x15	DINT	None Specified	- - - -	- - - -
22	0x77, 0x02, 0x16	DINT	None Specified	- - - -	- - - -
23	0x77, 0x02, 0x17	DINT	None Specified	- - - -	- - - -
24	0x77, 0x02, 0x18	DINT	None Specified	- - - -	- - - -
25	0x77, 0x02, 0x19	DINT	None Specified	- - - -	- - - -
26	0x77, 0x02, 0x1A	DINT	None Specified	- - - -	- - - -
27	0x77, 0x02, 0x1B	DINT	None Specified	- - - -	- - - -
28	0x77, 0x02, 0x1C	DINT	None Specified	- - - -	- - - -
29	0x77, 0x02, 0x1D	DINT	None Specified	- - - -	- - - -
30	0x77, 0x02, 0x1E	DINT	None Specified	- - - -	- - - -
31	0x77, 0x02, 0x1F	DINT	None Specified	- - - -	- - - -
32	0x77, 0x02, 0x20	DINT	None Specified	- - - -	- - - -
33	0x77, 0x02, 0x21	DINT	None Specified	- - - -	- - - -
34	0x77, 0x02, 0x22	DINT	None Specified	- - - -	- - - -
35	0x77, 0x02, 0x23	DINT	None Specified	- - - -	- - - -
36	0x77, 0x02, 0x24	DINT	None Specified	- - - -	- - - -
37	0x77, 0x02, 0x25	DINT	None Specified	- - - -	- - - -
38	0x77, 0x02, 0x26	DINT	None Specified	- - - -	- - - -
39	0x77, 0x02, 0x27	DINT	None Specified	- - - -	- - - -
40	0x77, 0x02, 0x28	DINT	None Specified	- - - -	- - - -

Note:

The first T to O member above (Device Status) is always present but not counted when configuring the gateway size using the RUI or EZ-ZONE Configurator software. However, it most always be counted when configuring the input size of the Master. As an example, if using the DINT comm format in a PLC and the entire assembly as shown above, the input size would require 21 members.

Note:

Although 40 members are built into PM/RM controllers, the RUI allows for a maximum of 20. If 40 members are needed, consider using the EZ-ZONE RMA module.

As can be seen on the previous pages, the PM Implicit Assembly defaults (factory settings) to a populated assembly structure for the first 20 members. If it is desired to modify any of the given assembly members there are many software tools available to do so, one of which is available on the Watlow website. Click on the link below and then type "implicit" into the keyword field and click the search button.

<http://www.watlow.com/en/resources-and-support/Technical-Library/Software-and-Demos>

Click on and save the program named "EZ-ZONE Implicit Message Assembly Programming Application" to a location on your local storage device. To learn more about working with the implicit assemblies turn to the section within this user document entitled [Modifying Implicit Assembly Members](#).

Assembly	Class, Instance, Attribute
1 A Analog Input Read	C = 0x71 (113) I = 1 to 4 A = 1

Compact Class Assembly Structure

On the next six pages, the 17 available members of the Compact Class are displayed. As an orientation to the format as displayed in this document, notice that each member begins with header identified as "Assembly" and below the header you will see the member number along with parameter information contained within. While looking at these illustrations keep in mind that each member is actually 32-bits in length. To better illustrate this information in this document, the following 6 pages present these members divided in half where the letter "A" in the page header and assembly number represents the most significant 16-bits where the letter "B" in the title and assembly number represents the least significant 16-bits of each member. In the event that these pages are printed out and then mixed up, simply match up the page headers placing them side by side. As an example, Compact Class 1A through 7A should be paired with Class 1 B through 7 B, left to right.

For further explanation as to what the Compact Class assembly is, navigate to the section entitled "[Compact Assembly Class](#)"

Compact Class 1 A through 7 A

		Instance i															
Assembly	Class, Instance, Attribute	31	30	29	28	27	26	25	24	23	22	21	20	19	18	17	16
1 A Analog Input Read	C = 0x71 (113) I = 1 to 4 A = 1	Filtered, Analog Input Value															

Bits 16 to 31, Signed 16 bits with implied tenths precision (-32768.8 to 3276.7)

		Instance i															
Assembly	Class, Instance, Attribute	31	30	29	28	27	26	25	24	23	22	21	20	19	18	17	16
2 A Control Read/Write	C = 0x71 (113) I = 1 to 4 A = 2	Set Point															

Bits 16 to 31, Signed 16 bits with implied tenths precision (-32768.8 to 3276.7)

		Instance i + 1															
Assembly	Class, Instance, Attribute	31	30	29	28	27	26	25	24	23	22	21	20	19	18	17	16
3 A Control Read/Write	C = 0x71 (113) I = 1 to 4 A = 3	Set Point															

Bits 16 to 31, Signed 16 bits with implied tenths precision (-32768.8 to 3276.7)

		Instance i															
Assembly	Class, Instance, Attribute	31	30	29	28	27	26	25	24	23	22	21	20	19	18	17	16
4 A Control Read/Write	C = 0x71 (113) I = 1 to 4 A = 4	Heat Proportional Band															

Bits 16 to 31, Unsigned 16 bits with implied tenths precision (0 to 6553.5)

		Instance i															
Assembly	Class, Instance, Attribute	31	30	29	28	27	26	25	24	23	22	21	20	19	18	17	16
5 A Control Read/Write	C = 0x71 (113) I = 1 to 4 A = 5	Cool Proportional Band (instance i)															

Bits 16 to 31, Unsigned 16 bits with implied tenths precision (0 to 6553.5)

		Instance i + 1															
Assembly	Class, Instance, Attribute	31	30	29	28	27	26	25	24	23	22	21	20	19	18	17	16
6 A Limit Read	C = 0x71 (113) I = 1 to 4 A = 6	Limit State	Input Error Status	Analog Input Value													

Bits 16 to 28, Signed 16 bits whole (-4096 to 4095)
 Bit 29, Analog Input Error Status (0 = None, 1 = Error)
 Bits 30 and 31, Limit State (00 = None, 01 = Low Limit, 10 = Limit High, 11 = Other)

		Instance i + 1																
Assembly	Class, Instance, Attribute	31	30	29	28	27	26	25	24	23	22	21	20	19	18	17	16	
7 A Limit Read/Write	C = 0x71 (113) I = 1 to 4 A = 7	Spare	Limit Clear	Clear Latched Error	Analog Input Value													

Bits 16 to 28, Signed 13 bits whole (-4096 to 4095)
 Bit 29, Clear Latched Input Error (0 = Ignore, 1 = Clear)
 Bits 30, Limit Clear (0 = Ignore, 1 = Clear)

Compact Class 1 B through 7 B

		Instance i														
Assembly	15	14	13	12	11	10	9	8	7	6	5	4	3	2	1	0
1 B	Input Error Status	Loop Error Status	Actual Control Mode	Tune Status	Control Loop, Power											

Bits 0 to 10, Signed 10 bits with implied tenths precision (-100.0 to 100.0)
 Bit 11, Loop Tuning Status (0 = Off, 1 = Anything Else)
 Bits 12 and 13, Actual Control Mode (00 = Off, 01 = Manual, 10 = Auto)
 Bit 14, Loop Error Status (0 = None, 1 = Error)
 Bit 15, Analog Input Error (0 = None, 1 = Error)

		Instance i														
Assembly	15	14	13	12	11	10	9	8	7	6	5	4	3	2	1	0
2 B	Spare	Open Loop Clear	Control Mode	Initiate Tune	Manual Power											

Bits 0 to 10, Signed 10 bits with implied tenths precision (-100.0 to 100.0)
 Bit 11, Initiate Tune (0 = No, 1 = Yes)
 Bits 12 and 13, Actual Control Mode (00 = Off, 01 = Manual, 10 = Auto)
 Bit 14, Open Loop Clear (0 = Ignore, 1 = Clear)

		Instance i														
Assembly	15	14	13	12	11	10	9	8	7	6	5	4	3	2	1	0
3 B	Set Point															

Bits 0 to 15, Signed 16 bits with implied tenths precision (-3276.8 to 3276.8)

		Instance i														
Assembly	15	14	13	12	11	10	9	8	7	6	5	4	3	2	1	0
4 B	Time Integral															

Bits 0 to 15, Unsigned 16 bits whole (0 to 65535)

		Instance i														
Assembly	15	14	13	12	11	10	9	8	7	6	5	4	3	2	1	0
5 B	Time Derivative															

Bits 0 to 15, Unsigned 16 bits whole (0 to 65535)

		Instance i														
Assembly	15	14	13	12	11	10	9	8	7	6	5	4	3	2	1	0
6 B	Limit State	Input Error Status	Analog Input Value													

Bits 0 to 12, Signed 13 bits whole (-4096 to 4095)
 Bits 13, Analog Input Error Status (0 = None, 1 = Error)
 Bit 14 and 15, Limit State (00 = None, 01 = Limit low, 10 = Limit high, 11 = Other)

		Instance i														
Assembly	15	14	13	12	11	10	9	8	7	6	5	4	3	2	1	0
7 B	Spare	Limit Clear	Clear Latched Error	High Limit Set Point												

Bits 0 to 12, Signed 13 bits whole (-4096 to 4095)
 Bit 13, Clear Latched Input Error (0 = Ignore, 1 = Clear)
 Bit 14, Limit Clear (0 = Ignore, 1 = Clear)

Compact Class 8 A through 13 A

Assembly	Class, Instance, Attribute	Instance i + 15		Instance i + 14		Instance i + 13		Instance i + 12		Instance i + 11		Instance i + 10		Instance i + 9		Instance i + 8	
		31	30	29	28	27	26	25	24	23	22	21	20	19	18	17	16
8 A Limit Read	C = 0x71 (113) I = 1 to 4 A = 8	Limit State		Limit State		Limit State		Limit State		Limit State		Limit State		Limit State		Limit State	

Bits 16 to 31, Paired bits representing the state of up to 16 limits (00 = None, 01 = Limit low,, 10 = Limit High)

Assembly	Class, Instance, Attribute	Instance i + 15		Instance i + 14		Instance i + 13		Instance i + 12		Instance i + 11		Instance i + 10		Instance i + 9		Instance i + 8	
		31	30	29	28	27	26	25	24	23	22	21	20	19	18	17	16
9 A Limit Read/Write	C = 0x71 (113) I = 1 to 4 A = 9	Spare	Clear Limit	Spare	Clear Limit	Spare	Clear Limit	Spare	Clear Limit	Spare	Clear Limit	Spare	Clear Limit	Spare	Clear Limit	Spare	Clear Limit

Bits 16 to 31, Paired bits representing the state of up to 16 limits (00 = None, 01 = Limit low,, 10 = Limit High)

Assembly	Class, Instance, Attribute	Instance i														
		31	30	29	28	27	26	25	24	23	22	21	20	19	18	17
10 A Limit Read/Write	C = 0x71 (113) I = 1 to 4 A = 0x0A (10)	Spare	Clear Limit	Clear Latched Error	High Limit Set Point											

Bits 16 to 28, Signed 13 bits whole (-4096 to 4095) - Bit 29, Clear Latched Input Error (0 = Ignore, 1 = Clear)
Bits 30, Limit Clear (0 = Ignore, 1 = Clear)

Assembly	Class, Instance, Attribute	Instance i + 1														
		31	30	29	28	27	26	25	24	23	22	21	20	19	18	17
11 A CT Read	C = 0x71 (113) I = 1 to 4 A = 0x0B (11)	Spare	Heater Error		Current Error		Current RMS									

Bits 16 to 26, Unsigned 11 bits (0 to 2047)
Bits 27 and 28, Current Error (00 = None, 01 = Shorted, 10 = Open)
Bits 29 and 30, Heater Error (00 = None, 01 = Low, 10 = High)

Assembly	Class, Instance, Attribute	Instance i + 15		Instance i + 14		Instance i + 13		Instance i + 12		Instance i + 11		Instance i + 10		Instance i + 9		Instance i + 8	
		31	30	29	28	27	26	25	24	23	22	21	20	19	18	17	16
12 A Alarm Read	C = 0x71 (113) I = 1 to 4 A = 0x0C (12)	Alarm State		Alarm State		Alarm State		Alarm State		Alarm State		Alarm State		Alarm State		Alarm State	

Bits 16 to 31, Paired bits reflecting the state of up to 16 alarms (00 = None, 01 = Alarm Low, 10 = Alarm High, 11 = Other)

Assembly	Class, Instance, Attribute	Instance i + 15		Instance i + 14		Instance i + 13		Instance i + 12		Instance i + 11		Instance i + 10		Instance i + 9		Instance i + 8	
		31	30	29	28	27	26	25	24	23	22	21	20	19	18	17	16
13 A Alarm Read/Write	C = 0x71 (113) I = 1 to 4 A = 0x0D (13)	Clear Alarm		Silence Alarm		Clear Alarm		Silence Alarm		Clear Alarm		Silence Alarm		Clear Alarm		Silence Alarm	

Bits 16 to 31, Paired bits reflecting the state of up to 16 alarms (0 = Ignore, 1 = Clear)

Compact Class 8 B through 13 B

	Instance i + 7		Instance i + 6		Instance i + 5		Instance i + 4		Instance i + 3		Instance i + 2		Instance i + 1		Instance i	
Assembly	15	14	13	12	11	10	9	8	7	6	5	4	3	2	1	0
8 B	Limit State		Limit State		Limit State		Limit State		Limit State		Limit State		Limit State		Limit State	

Bits 0 to 15, Paired bits representing the state of up to 16 limits (00 = None, 01 = Limit low,, 10 = Limit High)

	Instance i + 7		Instance i + 6		Instance i + 5		Instance i + 4		Instance i + 3		Instance i + 2		Instance i + 1		Instance i	
Assembly	15	14	13	12	11	10	9	8	7	6	5	4	3	2	1	0
9 B	Spare	Clear Limit	Spare	Clear Limit	Spare	Clear Limit	Spare	Clear Limit	Spare	Clear Limit	Spare	Clear Limit	Spare	Clear Limit	Spare	Clear Limit

Bits 0, 2, 4, 6, 8, 10, 12 and 14, Limit Clear for instance i to instance i (0 = Ignore, 1 = Clear)

	Instance i															
Assembly	15	14	13	12	11	10	9	8	7	6	5	4	3	2	1	0
10 B	Spare				Low Limit Set Point											

Bits 0 to 12, Signed 13 bits whole (-4096 to 4095)

	Instance i															
Assembly	15	14	13	12	11	10	9	8	7	6	5	4	3	2	1	0
11 B	Spare	Heater Error	Current Error			Current RMS										

Bits 11 and 12, Current Error (00 = None, 01 = Shorted, 10 = Open)

Bits 13 and 14, Heater Error (00 = None, 01 = Low, 10 = High)

	Instance i + 7		Instance i + 6		Instance i + 5		Instance i + 4		Instance i + 3		Instance i + 2		Instance i + 1		Instance i	
Assembly	15	14	13	12	11	10	9	8	7	6	5	4	3	2	1	0
12 B	Alarm State		Alarm State		Alarm State		Alarm State		Alarm State		Alarm State		Alarm State		Alarm State	

Bits 0 to 15, Paired bits reflecting the state of up to 16 alarms (00 = None, 01 = Alarm Low, 10 = Alarm High, 11 = Other)

	Instance i + 7		Instance i + 6		Instance i + 5		Instance i + 4		Instance i + 3		Instance i + 2		Instance i + 1		Instance i	
Assembly	15	14	13	12	11	10	9	8	7	6	5	4	3	2	1	0
13 B	Clear Alarm		Silence Alarm		Clear Alarm		Silence Alarm		Clear Alarm		Silence Alarm		Clear Alarm		Silence Alarm	

Bits 0 to 15, Paired bits reflecting the state of up to 16 alarms (0 = Ignore, 1 = Clear)

Compact Class 14 A through 19 A

		Instance i															
Assembly	Class, Instance, Attribute	31	30	29	28	27	26	25	24	23	22	21	20	19	18	17	16
14 A Alarm Read/Write	C = 0x71 (113) I = 1 to 4 A = 0x0E (14)	Alarm Clear	Alarm, High Set Point														

Bits 16 to 30, Signed 15 bits with implied tenths precision (-1638.4 to 1638.3)
 Bit 31, Alarm Clear (0 = Ignore, 1 = Clear)

		Instance i + 1															
Assembly	Class, Instance, Attribute	31	30	29	28	27	26	25	24	23	22	21	20	19	18	17	16
15 A Analog Input Read	C = 0x71 (113) I = 1 to 4 A = 0x0F (15)	Input Error Status	Filtered, Analog Input Value														

Bits 16 to 30, Signed 15 bits with implied tenths precision (-1638.4 to 1638.3)
 Bit 31, Analog Input Error (0 = None, 1 = Error)

		Instance i + 1															
Assembly	Class, Instance, Attribute	31	30	29	28	27	26	25	24	23	22	21	20	19	18	17	16
16 A Analog Input Read	C = 0x71 (113) I = 1 to 4 A = 0x10 (16)	Filtered, Analog Input Value															

Bits 16 to 31, Signed 16 bits with implied tenths precision (-3276.8 to 3276.8)

		Instance i + 15		Instance i + 14		Instance i + 13		Instance i + 12		Instance i + 11		Instance i + 10		Instance i + 9		Instance i + 8	
Assembly	Class, Instance, Attribute	31	30	29	28	27	26	25	24	23	22	21	20	19	18	17	16
17 A Analog Input Read	C = 0x71 (113) I = 1 to 4 A = 0x11 (17)	Spare	Input Error	Spare	Input Error	Spare	Input Error	Spare	Input Error	Spare	Input Error	Spare	Input Error	Spare	Input Error	Spare	Input Error

Bits 16, 18, 20, 22, 24, 26, 28, 30, Analog Input Error Status (0 = None, 1 = Error)

Compact Class 14 B through 17 B

		Instance i															
Assembly		15	14	13	12	11	10	9	8	7	6	5	4	3	2	1	0
14 B	Alarm Silence	Alarm, Low Set Point															
		Bits 0 to 14, Signed 15 bits with implied tenths precision (-1638.4 to 1638.3) Bit 15, Alarm Silence (0 = Ignore, 1 = Silence)															

		Instance i															
Assembly		15	14	13	12	11	10	9	8	7	6	5	4	3	2	1	0
15 B	Input Error Status	Filtered Analog Input Value															
		Bits 0 to 14, Signed 15 bits with implied tenths precision (-1638.4 to 1638.3) Bit 15, Analog Input Error (0 = None, 1 = Error)															

		Instance i															
Assembly		15	14	13	12	11	10	9	8	7	6	5	4	3	2	1	0
16 B		Filtered Analog Input Value															
		Bits 0 to 15, Signed 16 bits with implied tenths precision (-3276.8 to 3276.8)															

		Instance i + 7		Instance i + 6		Instance i + 5		Instance i + 4		Instance i + 3		Instance i + 2		Instance i + 1		Instance i	
Assembly		15	14	13	12	11	10	9	8	7	6	5	4	3	2	1	0
17 B		Spare	Input Error	Spare	Input Error	Spare	Input Error	Spare	Input Error	Spare	Input Error	Spare	Input Error	Spare	Input Error	Spare	Input Error
		Bits 0, 2, 4, 6, 8, 10, 12, 14, Analog Input Error Status(0 = None, 1 = Error)															

PM Specifications

LineVoltage/Power (Minimum/Maximum Ratings)

- 85 to 264V~ (ac), 47 to 63Hz
- 20 to 28V~ (ac), 47 to 63Hz
- 12 to 40V $\overline{=}$ (dc)
- 14VA maximum power consumption (PM4, 8 & 9)
- 10VA maximum power consumption (PM6)
- Data retention upon power failure via non-volatile memory
- Compliant with SEMIF47-0200, Figure R1-1 voltage sag requirements @ 24V~ (ac) or higher

Environment

- 0 to 149°F (-18 to 65°C) operating temperature
- -40 to 185°F (-40 to 85°C) storage temperature
- 0 to 90% RH, non-condensing

Accuracy

- Calibration accuracy and sensor conformity: $\pm 0.1\%$ of span, $\pm 1^\circ\text{C}$ @ the calibrated ambient temperature and rated line voltage
- Types R, S, B; 0.2%
- Type T below -50°C ; 0.2%
- Calibration ambient temperature @ $77 \pm 5^\circ\text{F}$ ($25 \pm 3^\circ\text{C}$)
- Accuracy span :1000 °F (540°C) min.
- Temperature stability: $\pm 0.1^\circ\text{F}/^\circ\text{F}$ ($\pm 0.1^\circ\text{C}/^\circ\text{C}$) rise in ambient max.

Agency Approvals

- UL[®] Listed to UL 61010-1 File E185611
- UL Reviewed to CSA C22.2 No.61010-1-04
- UL 50 Type 4X, NEMA 4X indoor locations, IP65 front panel seal (indoor use only)
- FM Class 3545 File 3029084 temperature limit switches
- CE-See Declaration of Conformity RoHS and W.E.E.E. complaint
- ODVA-EtherNet/IP[™] and DeviceNet Compliance
- UL Listed to ANSI/ISA 12.12.01-2007 File E184390
- This equipment is suitable for use in Class 1, Div.2, Groups A, B, C and D or non-hazardous locations only. Temperature Code T4A
- UL reviewed to Standard No. CSA C22.2 No.213-M1987, Canadian Hazardous locations
- All models, CSA C22.2 No. 24 File 158031 Class 4813-02, CSA Approved

Controller

- User selectable heat/cool, on-off, P, PI, PD, PID or alarm action, not valid for limit controllers
- Auto-tune with TRU-TUNE[®]+ adaptive control algorithm
- Control sampling rates: input = 10Hz, outputs = 10Hz

Profile Ramp/Soak - Real Time Clock and Battery Back-up

- Accuracy (typical): ± 30 PPM at 77°F (25°C)
- +30/-100 PPM at -4 to 149°F (-20 to 65°C)
- Battery type: Rayovac 3V (BR1225) lithium (recycle properly). Battery is available only on models with real-time clock
- Battery typical life: three cumulative years of life without power at 77°F (25°C)

Isolated Serial Communications

- EIA232/485, Modbus® RTU
- EtherNet/IP™, DeviceNet™ (ODVA certified)
- Modbus TCP
- Profibus DP

Wiring Termination—Touch-Safe Terminals

- Input, power and controller output terminals are touch safe removable 3.30 to 0.0507 mm² (12 to 22 AWG)
- Wire strip length 7.6 mm (0.30 in.)
- Torque 0.56 Nm (5.0 in-lb)

Universal Input

- Thermocouple, grounded or ungrounded sensors
 - >20MΩ input impedance
- Max. 2kΩ source resistance
- 3μA open sensor detection
- RTD 2- or 3-wire, platinum, 100Ω and 1kΩ @ 0°C (32°F) calibration to DIN curve (0.00385 Ω/Ω/°C)
- Process, 0-20mA @100Ω, or 0-10V_{rms} (dc) @ 20kΩ input impedance; scalable, 0-50mV

Voltage Input Ranges

- Accuracy ± 10 mV ± 1 LSD at standard conditions
- Temperature stability ± 100 PPM/°C maximum

Milliamp Input Ranges

- Accuracy ± 20 μA ± 1 LSD at standard conditions
- Temperature stability ± 100 PPM/°C maximum

Resolution Input Ranges

- 0 to 10V: 200μV nominal
- 0 to 20mA: 0.5mA nominal

- Potentiometer: 0 to 1.2kΩ
- Inverse scaling
- Current: input range is 0 to 50mA, 100Ω input impedance
- Response time: 1 second max., accuracy ± 1 mA typical

Input Type	Max Error @ 25 Deg C	Accuracy Range Low	Accuracy Range High	Units
J	± 1.75	0	750	Deg C
K	± 2.45	-200	1250	Deg C
T	± 1.55	-200	350	Deg C

Input Type	Max Error @ 25 Deg C	Accuracy Range Low	Accuracy Range High	Units
N	±2.25	0	1250	Deg C
E	±2.10	-200	900	Deg C
R	±3.9	0	1450	Deg C
S	±3.9	0	1450	Deg C
B	±2.66	870	1700	Deg C
C	±3.32	0	2315	Deg C
D	±3.32	0	2315	Deg C
F (PTII)	±2.34	0	1343	Deg C
RTD, 100 ohm	±2.00	-200	800	Deg C
RTD, 1000 ohm	±2.00	-200	800	DegC
mV	±0.05	-50	50	mV
Volts	±0.01	0	10	Volts
mAdc	±0.02	0	20	mAmps DC
mAac	±5	0	50	mAmps AC

Operating Range			
Input Type	Range Low	Range High	Units
J	-210	1200	Deg C
K	-270	1371	Deg C
T	-270	400	Deg C
N	-270	1300	Deg C
E	-270	1000	Deg C
R	-50	1767	Deg C
S	-50	1767	Deg C
B	0	1816	Deg C
C	0	2315	Deg C
D	0	2315	Deg C
F (PTII)	0	1343	Deg C
RTD (100 ohm)	-200	800	Deg C
RTD (1000 ohm)	-200	800	Deg C
mV	0	50	mV
Volts	0	10	Volts
mAdc	0	20	mAmps DC
mAac	0	50	mAmps AC
Potentiometer, 1K range	0	1200	Ohms
Resistance, 5K range	0	5000	Ohms
Resistance, 10K range	0	10000	Ohms
Resistance, 20K range	0	20000	Ohms
Resistance, 40K range	0	40000	Ohms

Thermistor Input				
Input Type	Max Error @ 25 Deg C	Accuracy Range Low	Accuracy Range High	Units
Thermistor, 5K range	±5	0	5000	Ohms
Thermistor, 10K range	±10	0	10000	Ohms
Thermistor, 20K range	±20	0	20000	Ohms
Thermistor, 40K range	±40	0	40000	Ohms

- 0 to 40kΩ, 0 to 20kΩ, 0 to 10kΩ, 0 to 5kΩ
- 2.252kΩ and 10kΩ base at 25°C
- Linearization curves built in
- Third party Thermistor compatibility requirements

Base R @ 25C	Alpha Techniques	Beta THERM	YSI	Thermistor Curve
2.252K	Curve A	2.2K3A	004	A
10K	Curve A	10K3A	016	B
10K	Curve C	10K4A	006	C

Current Measurement

- Accepts 0 - 50mA signal (user programmable range)
- Displayed operating range and resolution can be scaled and are user programmable
- Requires optional current transformer

2 Digital Input/Output Option - 2 DIO

- Digital input update rate 10Hz
 - *DC voltage*
 - Max. input 36V @ 3mA
 - Min. high state 3V at 0.25mA
 - Max. low state 2V
 - *Dry contact*
 - Min. open resistance 10kΩ
 - Max. closed resistance 50Ω
 - Max. short circuit 13mA
- Digital output update rate 10Hz
 - SSR drive signal
 - Update rate 10 Hz
 - Maximum open circuit voltage is 22 to 25= (dc)
 - PNP transistor source
 - Typical drive; 21mA @ 4.5V for DO5, and 11mA @ 4.5V for DO6
 - Current limit 24mA for Output 5 and 12mA Output 6
 - Output 5 capable of driving one 3 - pole DIN-A-MITE
 - Output 6 capable of driving one 1 - pole DIN-A-MITE

6 Digital Input/Output Option - 6 DIO

- Digital input or output
- Update rate 10Hz
- Switched DC
 - Internal supply limited to 400mA, maximum open circuit voltage of 25V, typical 8V at 80mA.
- Open Collector
 - Max. switched voltage is 32V $\overline{=}$ (dc)
 - Max. switched current per output is 1.5A
 - Max. switched current for all 6 outputs is 8A

Output Hardware

- Switched DC
 - Maximum open circuit voltage is 22 to 25V $\overline{=}$ (dc)
 - 30mA max. per single output / 40mA max. total per paired outputs (1 & 2, 3 & 4)
 - Typical drive; 4.5V $\overline{=}$ (dc) @ 30mA
 - Short circuit limited to <50mA
 - Use dc- and dc+ to drive external solid-state relay
 - 1-pole DIN-A-MITE: up to 4 in parallel or 4 in series
 - 2-pole DIN-A-MITE: up to 2 in parallel or 2 in series
 - 3-pole DIN-A-MITE: up to 2 in series
 - Switched dc/open collector = 30V $\overline{=}$ (dc) max. @ 100mA max. current sink
 - Solid State Relay (SSR), FormA, 0.5A @ 24V \sim (ac) min., 240V \sim (ac) max., 1A at 50°F linear derating to 0.5A at 149°F resistive, opto-isolated, without contact suppression, 120/240V \sim (ac) 20 VA pilot duty
 - Minimum holding current of 10mA
 - Electromechanical relay, Form C, 5A, 24 to 240V \sim (ac) or 30V $\overline{=}$ (dc) max., resistive load, 100,000 cycles at rated load, 125 VA pilot duty at 120/240V \sim (ac), 25 VA at 24V \sim (ac)
 - Electromechanical relay, Form A, 5A, 24 to 240V \sim (ac) or 30V $\overline{=}$ (dc) max., resistive load, 100,000 cycles at rated load, 125 VA pilot duty at 120/240V \sim (ac), 25 VA at 24V \sim (ac)
 - NO-ARC relay, Form A, 15A, 24 to 240V \sim (ac), no V $\overline{=}$ (dc), resistive load, 2 million cycles at rated load
 - Universal process/retransmit, Output range selectable:
 - 0 to 10V $\overline{=}$ (dc) into a min. 1k Ω load
 - 0 to 20mA into max. 800 Ω load
- Resolution*
- dc ranges: 2.5mV nominal
 - mA ranges: 5 μ A nominal
- Calibration Accuracy*
- dc ranges: \pm 15mV

- mA ranges: $\pm 30\mu\text{A}$

Temperature Stability

- 100 ppm/ $^{\circ}\text{C}$

Operator Interface

- Dual 4 digit, 7 segment LED displays
- Advance, infinity, up and down keys, plus optional programmable EZ-KEY/s depending on model size
- Typical display update rate 1Hz
- RESET key substituted for infinity on all models including the limit control

Dimensions				
Size	Behind Panel (max.)	Width	Height	Display Character Height
1/4	100.8 mm (3.97 in)	100.3 mm (3.95 in)	100.3 mm (3.95 in)	Large: 20.32 mm (0.800 in) Medium: 12.70 mm (0.500 in) Small: 10.16 mm (0.400 in)
1/16	101.6 mm (4.00 in)	53.3 mm (2.10 in)	53.3 mm (2.10 in)	Large: 10.16 mm (0.400 in) Small: 5.97 mm (0.235 in)
1/8 (H)	101.6 mm (4.00 in)	100.3 mm (3.95 in)	54.8 mm (2.16 in)	Large: 11.4 mm (0.450 in) Medium: 9.53 mm (0.375 in) Small: 7.62 mm (0.300 in)
1/8 (V)	101.6 mm (4.00 in)	54.8 mm (2.16 in)	100.3 mm (3.95 in)	Large: 11.4 mm (0.450 in) Medium: 9.53 mm (0.375 in) Small: 7.62 mm (0.300 in)

Weight	
1/4 DIN (PM4) • Controller: 331 g (11.7 oz.)	1/8 DIN (PM8 and 9) • Controller: 284 g (10 oz.)
1/16 DIN (PM6) • Controller: 186 g (6.6 oz.)	User's Guide • User's Guide: 284.86 g (10.1 oz)

Modbus® is a trademark of AEG Schneider Automation Inc.

EtherNet/IP™ is a trademark of ControlNet International Ltd. used under license by Open DeviceNet Vendor Association, Inc. (ODVA).

UL® is a registered trademark of Underwriters Laboratories Inc.

DeviceNet™ is a trademark of Open DeviceNet Vendors Association.

Note:

These specifications are subject to change without prior notice.

Ordering Information for PM Integrated Controller Models

Controller

EZ-ZONE® Integrated Controller Models
 TRU-TUNE+® Adaptive Tune, red-green 7-segment displays

PM

Package Size

- 4 Panel Mount 1/4 DIN
- 6 Panel Mount 1/16 DIN
- 8 Panel Mount 1/8 DIN Vertical
- 9 Panel Mount 1/8 DIN Horizontal

Primary Function

- C PID Controller with Universal Input
- R PID Controller with Universal Input and Profiling Ramp and Soak
- B PID Controller with Universal Input and Profiling Ramp and Soak and Battery Backup with Real Time Clock
- T PID Controller with Universal Input and Countdown Timer
- J PID Controller with Thermistor Input
- N PID Controller with Thermistor Input and Profiling Ramp and Soak
- E PID Controller with Thermistor Input and Profiling Ramp and Soak and Battery Backup with Real Time Clock
- S Custom Firmware

- Options B and E are not available with PM6

Power Supply, Digital Input/Output

- 1 100 to 240V~ (ac)
- 2 100 to 240V~ (ac) plus 2 Digital I/O points
- 3 15 to 36V= (dc) and 24V~ (ac)
- 4 15 to 36V= (dc) and 24V~ (ac), plus 2 Digital I/O points

Output 1 and 2 Hardware Options

	Output 1	Output 2
CA	Switched dc/open collector	None
CH	Switched dc/open collector	NO-ARC 15 A power control
CC	Switched dc/open collector	Switched dc
CJ	Switched dc/open collector	Mechanical relay 5 A, form A
CK	Switched dc/open collector	Solid-state relay 0.5 A, form A
EA	Mechanical relay 5 A, form C	None
EH	Mechanical relay 5 A, form C	NO-ARC 15 A power control
EC	Mechanical relay 5 A, form C	Switched dc
EJ	Mechanical relay 5 A, form C	Mechanical relay 5 A, form A
EK	Mechanical relay 5 A, form C	Solid-state relay 0.5 A, form A
FA	Universal process	None
FC	Universal process	Switched dc (cannot use variable time base)
FJ	Universal process	Mechanical relay 5 A, form A (cannot use variable time base)
FK	Universal process	Solid-state relay 0.5 A, form A (cannot use variable time base)
AK	None	Solid-state relay 0.5 A, form A
KH	Solid-state relay 0.5 A, form A	NO-ARC 15 A power control
KK	Solid-state relay 0.5 A, form A	Solid-state relay 0.5 A, form A

Communications Options or Additional Digital I/O

- A None
- C 6 Digital I/O - Not available with PM6
- D 6 Digital I/O and EIA-485 Modbus RTU - Not available with PM6
- 1 EIA 485 Modbus RTU®
- 2 Modbus RTU 232/485
- 3 EtherNet/IP™, Modbus TCP
- 5 DeviceNet
- 6 Profibus DP
- 7 SAE J1939 CAN bus
- C 6 Digital I/O (not available on 1/16 DIN controllers)
- D 6 Digital I/O and EIA 485 Modbus® RTU (not available on 1/16 DIN controllers)

- Standard Bus EIA-485 always included - all models

Auxiliary Control Functions

- A None
- C 2nd PID Channel with Universal Input - Not available on PM6
- J 2nd PID Channel with Thermistor Input - Not available on PM6
- R Auxiliary 2nd input (Universal Input)
- P Auxiliary 2nd input (Thermistor Input)
- T Current Transformer Input (The following options are Not Valid for outputs 3 & 4: FA, FC, FJ and FK)
- L Integrated Limit Controller with Universal Input (Valid options for outputs 3 & 4: CJ, EJ, or AJ only)
- M Integrated Limit Controller with Thermistor Input (Valid options for outputs 3 & 4: CJ, EJ, or AJ only)

- PM6 When ordering Communications Options 2 - 6, option A must be ordered above

Auxiliary input can be configured for remote set point, back-up sensor, ratio, differential or wet-bulb/dry-bulb input

Output 3 and 4 Hardware Options

	Output 3	Output 4
AA	None	None
AJ	None	Mechanical relay 5 A, form A
AK	None	Solid-state relay 0.5 A, form A
CA	Switched dc/open collector	None
CC	Switched dc/open collector	Switched dc
CH	Switched dc/open collector	NO-ARC 15 A power control
CJ	Switched dc/open collector	Mechanical relay 5 A, form A
CK	Switched dc/open collector	Solid-state relay 0.5 A, form A
EA	Mechanical relay 5 A, form C	None
EC	Mechanical relay 5 A, form C	Switched dc
EH	Mechanical relay 5 A, form C	NO-ARC 15 A power control
EJ	Mechanical relay 5 A, form C	Mechanical relay 5 A, form A
EK	Mechanical relay 5 A, form C	Solid-state relay 0.5 A, form A
FA	Universal Process	None
FC	Universal Process	Switched dc (cannot use variable time base)
FJ	Universal Process	Mechanical relay 5 A, form A (cannot use variable time base)
FK	Universal Process	Solid-state relay 0.5 A, form A (cannot use variable time base)
KH	Solid-state relay 0.5 A, form A	NO-ARC 15 A power control
KK	Solid-state relay 0.5 A, form A	Solid-state relay 0.5 A, form A

- With Communications Options 2 - 6, option AA must be ordered with PM6 above

- Output options CH, EH and KH not available with PM6

Additional Options

- A Standard
 - C Enhanced firmware including: Compressor Control, Cascade, Ratio, Differential, Square-root, Motorized Valve Control without feedback
 - D Standard with isolated input 1, input 2 always isolated
 - F Enhanced firmware with isolated input 1, input 2 always isolated
- Note: Auxiliary Control Function C or J required for cascade control.

Custom Options

- AA Standard EZ-ZONE face plate
- AB EZ-ZONE logo and no Watlow name
- AC No logo and no Watlow name
- AG Conformal Coating
- XX Custom firmware, overlays, parameter settings

Series EZ-ZONE[®] PM



WATLOW Electric Manufacturing Company

ISO 9001 since 1996.

1241 Bundy Blvd.
Winona, MN 55987 USA

Declares that the following product:

Designation: **Series EZ-ZONE[®] PM (Panel Mount)**
Model Numbers: PM (3, 6, 8, 9 or 4)(Any Letter or number) – (1, 2, 3 or 4)(A, C, E, F or K) (A, C, H, J or K)(Any letter or number) – (Any letter or number)(A, C, E, F or K)(A, C, H, J or K) (Any three letters or numbers)
Classification: Temperature control, Installation Category II, Pollution degree 2, IP65
Rated Voltage and Frequency: 100 to 240 V~ (ac 50/60 Hz) **or** 15 to 36 V=dc/ 24 V~ac 50/60 Hz
Rated Power Consumption: 10 VA maximum PM3, PM6 Models.
14 VA maximum PM8, PM9, PM4 Models

Meets the essential requirements of the following European Union Directives by using the relevant standards show below to indicate compliance.

2004/108/EC Electromagnetic Compatibility Directive

EN 61326-1	2013	Electrical equipment for measurement, control and laboratory use – EMC requirements (Industrial Immunity, Class B Emissions).
EN 61000-4-2	2009	Electrostatic Discharge Immunity
EN 61000-4-3	2010	Radiated Field Immunity 10V/M 80–1000 MHz, 3 V/M 1.4–2.7 GHz
EN 61000-4-4	2012	Electrical Fast-Transient / Burst Immunity
EN 61000-4-5	2006	Surge Immunity (Also compliant with IEC 61000-4-5 2014)
EN 61000-4-6	2014	Conducted Immunity
EN 61000-4-11	2004	Voltage Dips, Short Interruptions and Voltage Variations Immunity
EN 61000-3-2	2009	Harmonic Current Emissions (Also compliant with IEC 61000-3-2 2014)
EN 61000-3-3 ¹	2013	Voltage Fluctuations and Flicker
SEMI F47	2000	Specification for Semiconductor Sag Immunity Figure R1-1

¹For mechanical relay loads, cycle time may need to be extended up to 160 seconds to meet flicker requirements depending on load switched and source impedance.

2006/95/EC Low-Voltage Directive

EN 61010-1	2011²	Safety Requirements of electrical equipment for measurement, control and laboratory use. Part 1: General requirements
-------------------	-------------------------	--

²Compliance with 3rd Edition requirements with use of external surge suppressor installed on 230 Vac~ power line units. Recommend minimum 1000 V peak to maximum 2000 V peak, 70 joules or better part be used.

Compliant with 2011/65/EU RoHS2 Directive

Per 2012/19/EU W.E.E Directive  Please Recycle Properly.

Joe Millanes
Name of Authorized Representative

Winona, Minnesota, USA
Place of Issue

Director of Operations
Title of Authorized Representative

September 2014
Date of Issue

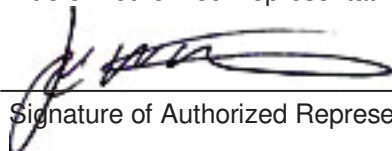
Signature of Authorized Representative

How to Reach Us

Corporate Headquarters

Watlow Electric Manufacturing Company
12001 Lackland Road
St. Louis, MO 63146
Sales: 1-800-WATLOW2
Manufacturing Support:
1-800-4WATLOW
Email: info@watlow.com
Website: www.watlow.com
From outside the USA and Canada:
Tel: +1 (314) 878-4600
Fax: +1 (314) 878-6814

Latin America

Watlow de México S.A. de C.V.
Av. Fundación No. 5
Col. Parques Industriales
Querétaro, Qro. CP-76130
Mexico
Tel: +52 442 217-6235
Fax: +52 442 217-6403

Europe

Watlow France
Tour d'Asnières.
4 Avenue Laurent Cély
92600 Asnières sur Seine
France
Tél: + 33 (0)1 41 32 79 70
Télécopie: + 33(0)1 47 33 36 57
Email: info@watlow.fr
Website: www.watlow.fr

Watlow GmbH
Postfach 11 65, Lauchwasenstr. 1
D-76709 Kronau
Germany
Tel: +49 (0) 7253 9400-0
Fax: +49 (0) 7253 9400-900
Email: info@watlow.de
Website: www.watlow.de

Watlow Italy S.r.l.
Viale Italia 52/54
20094 Corsico MI
Italy
Tel: +39 024588841
Fax: +39 0245869954
Email: italyinfo@watlow.com
Website: www.watlow.it

Watlow Ibérica, S.L.U.
C/Marte 12, Posterior, Local 9
E-28850 Torrejón de Ardoz
Madrid - Spain
T. +34 91 675 12 92
F. +34 91 648 73 80
Email: info@watlow.es
Website: www.watlow.es

Watlow UK Ltd.
Linby Industrial Estate
Linby, Nottingham, NG15 8AA
United Kingdom
Telephone: (0) 115 964 0777
Fax: (0) 115 964 0071
Email: info@watlow.co.uk
Website: www.watlow.co.uk
From outside The United Kingdom:
Tel: +44 115 964 0777
Fax: +44 115 964 0071

Asia and Pacific

Watlow Singapore Pte Ltd.
16 Ayer Rajah Crescent,
#06-03/04,
Singapore 139965
Tel: +65 6773 9488 Fax: +65 6778 0323
Email: info@watlow.com.sg Website: www.watlow.com.sg

Watlow Australia Pty., Ltd.
4/57 Sharps Road
Tullamarine, VIC 3043
Australia
Tel: +61 3 9335 6449
Fax: +61 3 9330 3566
Website: www.watlow.com

Watlow Electric Manufacturing Company (Shanghai) Co. Ltd.
Room 501, Building 10, KIC Plaza
290 Songhu Road, Yangpu District
Shanghai, China 200433
China
Phone:
Local: 4006 Watlow (4006 928569)
International: +86 21 3381 0188
Fax: +86 21 6106 1423
Email: vlee@watlow.cn
Website: www.watlow.cn

ワトロー ジャパン株式会社
〒101-0047 東京都千代田区内神田1-14-4
四国ビル別館9階
Tel: 03-3518-6630 Fax: 03-3518-6632
Email: infoj@watlow.com Website: www.watlow.co.jp

Watlow Japan Ltd.
1-14-4 Uchikanda, Chiyoda-Ku
Tokyo 101-0047
Japan
Tel: +81-3-3518-6630 Fax: +81-3-3518-6632
Email: infoj@watlow.com Website: www.watlow.co.jp

Watlow Korea Co., Ltd.
#2208, Hyundai KIC Building B, 70 Doosan-ro
Geumcheon-gu, Seoul
Republic of Korea
Tel: +82 (2) 2169-2600 Fax: +82 (2) 2169-2601
Website: www.watlow.co.kr

Watlow Malaysia Sdn Bhd
1F-17, IOI Business Park
No.1, Persiaran Puchong Jaya Selatan
Bandar Puchong Jaya
47100 Puchong, Selangor D.E.
Malaysia
Tel: +60 3 8076 8745 Fax: +60 3 8076 7186
Email: vlee@watlow.com
Website: www.watlow.com

瓦特龍電機股份有限公司
80143 高雄市前金區七賢二路189號 10樓之一
電話: 07-2885168 傳真: 07-2885568

Watlow Electric Taiwan Corporation
10F-1 No.189 Chi-Shen 2nd Road Kaohsiung 80143
Taiwan

Your Authorized Watlow Distributor

