

ARO®

PNEUMATIC CYLINDERS

COMPOSITE, ROUND LINE REPAIRABLE OR DISPOSABLE,
AND NFPA SQUARE INTERCHANGEABLE





About ARO®

ARO® is a worldwide manufacturer of fluid management products that are skillfully engineered to deliver performance and serviceability, allowing success to flow freely in our customers' businesses. That's why ARO is fluid intelligence—the smart choice in fluid management products for industrial operations.

With over an 85-year legacy of premier product performance and service excellence, ARO provides fluid management equipment for customers and industries around the globe; including chemical, manufacturing, energy, pharmaceutical, mining and more.

ARO has the right product to meet our customers' specific needs. We offer air-operated diaphragm pumps, piston pumps and packages, filters, regulators, and lubricators (FRLs), lubrication equipment, and pneumatic valves and cylinders.

ARO®

Table of Contents

Series 01 Micro-Air™ Cylinders

3/4" and 1-1/8" Bore Sizes

Application Information, Features, Capabilities.....	9
Ordering Information.....	9
Mounting Kits.....	10
Dimensional Information	11
Repair Kits	46

Series S Silverair™ Cylinders

1/2", 3/4", 1-1/16", 1-1/4", 1-1/2", 2" & 2-1/2" Bore Sizes

Application Information, Features, Capabilities.....	12
Ordering Information.....	13
Mounting Kits.....	14-15
Dimensional Information	16-22
Switches.....	23
Volume Chambers.....	24

Series 23, 24 and 28 Economair® Cylinders

1-1/8", 1-1/2", 2", 2-1/2", 3" and 4" Bore Sizes

Application Information, Features, Capabilities.....	25
Ordering Information.....	26
Mounting Kits.....	27
Dimensional Information	28
Switches.....	29
Repair Kits	46

Series AN and SN Provenair® Cylinders

1-1/2", 2", 2-1/2", 3-1/4", 4", 6", 8" & 10" Bore Sizes

Application Information, Features, Capabilities....	31-32
Series AN (aluminum) Ordering Information.....	33
Series SN (stainless steel) Ordering Information	34
Mounting Kits.....	35
Dimensional Information (Series AN, SN)	36-42
Switches (Series AN)	43
Rod End Accessories (Series AN)	42
Repair Kits	47
Tanks and Reservoirs, 1-1/2" thru 4"	43, 45
Rod Alignment Couplers.....	30

Premair™ Series Round Compact Cylinders

1-1/8", 1-1/2", 2", 2-1/2", 3", 4"

Application Information, Features, Capabilities.....	48
Ordering Information.....	49
Accessories	50
Switches.....	51
Dimensional Information	52-55
Repair Kits	62

Premair™ Series Square Metric Compact Cylinders

Application Information, Features, Capabilities.....	56
Ordering Information.....	57
Mounts, Dimensional Information.....	59-61
Switches.....	62
Dimensional Information	58
Repair Kits	62

Accessories

Air System Components	65-68
Flow Controls.....	63-64
Warnings and Cautions.....	69
Warranties.....	70

Economair® and Provenair® are registered trademarks of Aro.

Pneumatic Cylinders



Series 01 Micro-Air™ (3/4" and 1-1/8" bore)

Micro-Air Cylinders, small bore, repairable, double-acting cylinders, are designed for light duty applications. Available in 3/4, and 1-1/8 inch bore sizes. Operate on air pressure to 200 PSI, generating thrusts from 4.9 to 199 pounds. They are available in stroke lengths up to 6 inches and in several mounting styles.

➤ For more information, see pages 9 through 11.



Series S Silverair™ (1/2" thru 2-1/2" bore)

Silverair Cylinders, small and medium bore, disposable, single- and double-acting cylinders are designed for light duty applications. Available in bore sizes from 1/2 inch to 2-1/2 inches. Operate on air pressures to 200 PSI, generating thrusts up to 982 pounds.

➤ For more information, see pages 12 through 24.



Series 23, 24 & 28 Economair® (1-1/8" thru 4" bore)

Economair Cylinders, round line repairable cylinders, are designed for medium to heavy-duty use in a wide range of applications. Available in 1-1/8 to 4-inch bore sizes. Operate on air pressure to 200 PSI, generating thrusts from 25 to 2,513 pounds. Available as double-acting, with optional cushions, magnetic pistons or double rod ends. O-ring seals are standard. U-cup or low friction seals are optional. A variety of mounts are available to meet a wide range of application requirements.

➤ For more information, see pages 25 through 29.





**Series AN & SN Provenair®
(1-1/2" thru 10" bore)**

Provenair Cylinders are NFPA interchangeable square head cylinders designed for rugged use. Available in 1-1/2 to 10-inch bore sizes. They operate on air pressure up to 250 PSI, generating thrusts up to 3,141 pounds. They are available as double-acting, with optional cushions, magnetic pistons and/or with double rod ends. A broad selection of NFPA standard mounts makes them dimensionally interchangeable with other NFPA cylinders..

➤ For more information, see pages 31 through 45.



**Premair™ Series
Round Compact
(1-1/8" thru 4" bore)**

Stainless steel tie bolts and aluminum spacers lock precision machined heads tightly around a heavy walled, aluminum alloy cylinder barrel. The barrel's extremely smooth, self-lubricating interior surface insures highly reliable performance and extended seal life.

➤ For more information, see pages 48 through 55.



**Premair™ Series
Square Metric Compact
(12mm thru 160mm bore)**

Premair Square Metric Compact Cylinders are available in 13 bore sizes, from 12mm thru 160mm. All cylinders come with NPT Ports and inch threads on rod end, and magnetic piston as standard. Mounting through holes are tapped and accept a variety of mounting kits. These cylinders interchange with the leading manufacturers of Square Compact Cylinders.

➤ For more information, see pages 56 through 62.



Pneumatic Cylinders

Accessories

Mounts

- Micro-Air™
- Silverair™
- Premair™
- Economair™
- Provenair™ (1-1/2 thru 10-inch bore)
- Provenair™ Stainless Steel (1-1/2 thru 8-inch bore)



Mounts

Rod End Accessories

- Micro-Air™
- Silverair™
- Premair™
- Economair™
- Provenair™ (1-1/2 thru 10-inch bore)



Rod End Accessories

Alignment Couplers

Switches, Cylinder Mounted

Flow Control Valves

Volume Chambers

Repair Kits



Alignment Couplers



Electrical Switches



Right Angle Flow Controls

Pneumatic Cylinders

Developing Specifications

Calculating the Proper Bore Size

A cylinder's bore size determines the force it will produce at a given supply pressure. The weight of the load or the clamping force required will largely determine the force requirements of the cylinder, and hence, the bore size required. But before determining the appropriate bore size you must compensate for air pressure drop, packing friction and load variations using the following computation:

- A) Compensating for Pressure Drop** – Decrease the line pressure value by 15 p.s.i. This compensates for pressure drop in the system.

$$\text{Operating pressure (psig)} = \text{Line pressure (psig)} - 15 \text{ (psig) pressure drop}$$

Example: If the line pressure is 95 (psig), subtract 15 (psig) to obtain 80 (psig) operating pressure (for sizing purposes)

- B) Compensating for Packing Friction** – Before you begin selecting a cylinder you already know the weight of the load you must move or the clamping force you must apply. Multiply this force or load value by 1.25. This compensates for packing friction and load variations. (If speed is of concern for your application, multiply the force value by 2.0.)

$$\text{Force required (in pounds)} = 1.25 \times \text{load (or required clamping force)}$$

Example: If cylinder must move 100 pound load, multiplying 100 pounds by 1.25 = 125 pounds force required.

Now, at the top of the chart on the next page, find the column with the operating pressure calculated in "A" above (in this example, 80 psig). Go down that column until you find the force requirement calculated in "B", above (or the next higher value). Note that the force values in bold type represent the extend force while those in standard type represent retract force (retract force is lower because the rod reduces the effective piston area). Choose the appropriate value, then go to the Cylinder Bore column to find the bore requirements for your application.

Now that you know the cylinder bore size that will produce the force required for your application, go to page 7 to determine rod size requirements. Air consumption for each cylinder bore size can be found in the chart below.

Cylinder Air Consumption

To calculate the air consumption of a cylinder, multiply the total inches of stroke (extend plus retract) by the cycles per minute times the SCFM factor from the chart below. To find the SCFM factor, find your gauge pressure in the left hand column. Next, find your cylinder bore size in the chart. Where the two intersect, read down to the SCFM factor at the bottom of the chart.

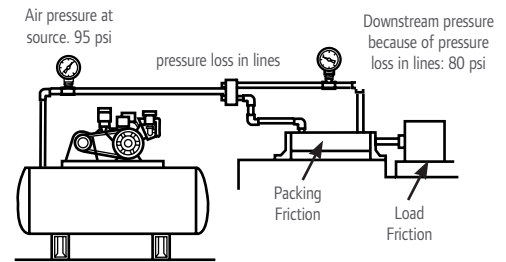
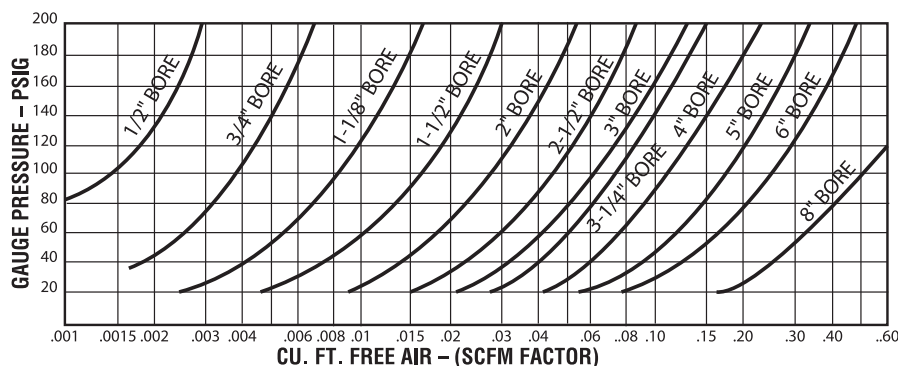

This illustration shows a pressure loss of 15 PSI through the airlines and points out friction factors, both of which must be compensated for.

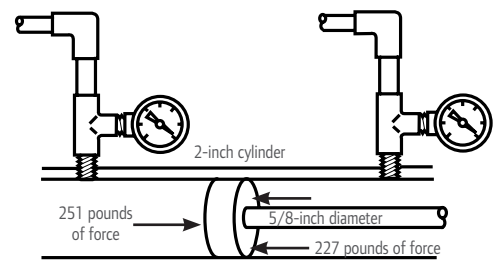

Given equal pressure on both sides of a piston, the surface area on the extend side will provide greater force.

Pneumatic Cylinders

Bore Selection Sizes EFFECTIVE PISTON AREA X OPERATING PRESSURE = FORCE

CYLINDER BORE (INCHES)	ROD DIAMETER (INCHES)	EFFECTIVE PISTON AREA (SQ. IN.)	OPERATING PRESSURE (PSI)										
			20	40	60	70	80	90	100	110	125	150	200
SELECTING BORE SIZE			FORCE OR LOAD VALUE										
7/16		.15	3	6	9	10	12	13	15	16	18	22	30
	3/16	.123	2.5	4.9	7.4	8.6	9.8	11	12.3	13.5	15.4	18.5	24.6
1/2		.196	4	8	12	14	16	18	20	22	25	29	39
	3/16	.169	3	7	10	12	14	15	17	19	21	25	34
	1/4	.147	3	6	9	10	12	13	15	16	18	22	29
9/16		.25	5	10	15	17	20	22	25	27	31	37	50
	3/16	.23	4.5	8.9	13.4	15.6	17.8	20	22	29.5	27.9	33.5	44.6
3/4		.442	9	18	27	31	35	40	44	49	55	66	88
	1/4	.393	8	16	24	28	31	35	39	43	49	59	79
7/8		.604	12	24	36	42	48	54	60	66	75	90	120
	1/4	.553	11	22	33	38	44	49	55	60	69	82	110
1-1/16		.890	18	36	53	62	71	80	89	98	111	134	178
	5/16	.810	16	32	49	57	65	73	81	89	101	122	162
1-1/8		.994	20	40	60	70	80	89	99	109	124	149	199
	5/16	.917	18	37	55	64	73	83	92	101	115	138	183
	3/8	.884	18	35	53	62	71	80	88	97	110	133	177
1-1/4		1.227	25	49	74	88	98	110	123	135	153	184	245
	7/16	1.077	22	43	65	75	86	97	108	118	135	162	215
1-1/2		1.767	35	71	106	124	141	159	177	194	221	265	353
	7/16	1.617	32	65	97	113	129	146	162	178	202	243	323
	1/2	1.571	31	63	94	110	126	141	157	173	196	236	314
	5/8	1.460	29	58	88	102	117	131	146	161	183	219	292
	1	1.325	27	53	80	93	106	119	133	146	166	199	265
1-3/4		2.405	48	96	144	168	192	216	240	265	301	361	481
	1/2	2.209	44	88	133	155	177	199	221	243	276	331	442
2		3.142	63	126	189	220	251	283	314	346	393	471	628
	5/8	2.835	57	113	170	198	227	255	284	312	354	425	567
	1	2.700	54	108	162	189	216	243	270	297	338	405	540
2-1/2		4.910	98	196	295	344	393	442	491	540	614	737	982
	5/8	4.602	92	184	276	322	368	414	460	506	575	690	920
	3/4	4.470	89	179	268	313	358	402	447	492	559	671	894
	1	4.123	82	165	247	289	330	371	412	454	515	618	825
3		7.069	141	283	424	495	566	636	707	778	884	1060	1414
	3/4	6.6268	133	265	398	464	530	596	663	729	828	994	1325
3-1/4		8.296	166	332	498	581	664	747	830	913	1037	1244	1659
	1	7.510	150	300	451	526	601	676	751	826	939	1127	1502
	1-3/8	6.810	136	272	409	477	545	613	681	749	851	1021	1362
4		12.566	251	503	754	880	1005	1131	1257	1382	1571	1885	2513
	1	11.781	236	471	707	825	942	1060	1178	1296	1473	1767	2356
	1-3/8	11.081	222	443	665	776	886	997	1108	1219	1385	1662	2216
5		19.635	393	785	1178	1374	1571	1767	1964	2160	2454	2945	3927
	1	18.850	377	754	1131	1320	1508	1697	1885	2074	2356	2828	3770
	1-3/8	18.150	363	726	1089	1271	1452	1634	1815	1996	2269	2723	3630
6		28.274	565	1131	1696	1979	2262	2545	2827	3110	3534	4241	5655
	1-3/8	16.789	536	1072	1607	1875	2143	2411	2679	2947	3349	4018	5358
	1-3/4	25.870	517	1035	1552	1811	2070	2328	2587	2846	3234	3881	5174
8		50.260	1005	2010	3016	3518	4021	4523	5026	5529	6283	7539	10052
	1-3/8	48.770	975	1951	2926	3414	3902	4489	4877	5365	6096	7316	9754
	1-3/4	47.820	956	1913	2869	3347	3826	4304	4782	5260	5978	7173	9564
10		78.54	1571	3142	4712	5497	6283	7068	7854	8639	9818	11781	15708
	1-3/4	76.14	1523	3046	4568	5330	6091	6853	7614	8375	9518	11421	15228

VALUES IN BOLD TYPE REPRESENT EXTEND FORCE. Other values represent retract force (piston area, less area of piston rod).
Check series order information for available rod diameters in each series.

Pneumatic Cylinders

Rod Diameter

- A)** Use the stroke factor table to find the proper multiplier based on the mounting configuration and rod end connection used.
- B)** Multiply your required working stroke length by the factor you found from the stroke factor table in Step A. Note: if you require a rod or thread extension in your application (Longer than standard) add the extra length(s) to your required working stroke length and then multiply by the stroke factor found in Step A, the result of this arithmetic is the "L" Value.

- C)** Use the piston rod diameter/ stop length chart to complete your cylinder specification. Find the approximate "L" value (determined in Steps A & B) on the left side of the chart. At the bottom of the chart, find the force (thrust) required for your cylinder. Reference the bore selection sizes table on the previous page to determine bore size, rod diameter or force at various PSI. Find the intersection of the "L" value (Horizontal) line with the force in pounds (Vertical) line. The intersection should be on, or to-the-left of the diagonal (rod diameter) line. The diagonal (rod diameter) line indicates the correct piston rod diameter for your application.

Note: If your "L" value-force lines intersect above, or to-the-right of a diagonal line, find a cylinder with the next larger piston rod diameter to avoid premature cylinder wear or failure.

STROKE FACTOR

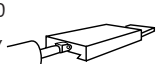
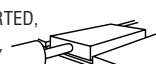
ROD END CONNECTION	CYLINDER RIGIDLY MOUNTED		CYLINDER PIVOT MOUNTED		
	L-MOUNTS, SIDE-TAPPED SIDE END LUGS	FRONT OR REAR FLANGE MOUNTING NUTS	FRONT-MOUNTED TRUNNION	CENTER-MOUNTED TRUNNION	CLEVIS EYE, OR REAR-MOUNTED TRUNNION
FIXED AND RIGIDLY GUIDED 	0.50	0.50	N/A	N/A	N/A
PIVOTED AND RIGIDLY GUIDED 	0.71	0.71	1.00	1.50	2.00
SUPPORTED, NOT RIGIDLY GUIDED 	1.00	1.00	N/A	N/A	N/A

Note: Remember, long, slim piston rods may buckle when subjected to a heavy push load.

PISTON ROD DIAMETER/ STOP LENGTH CHART

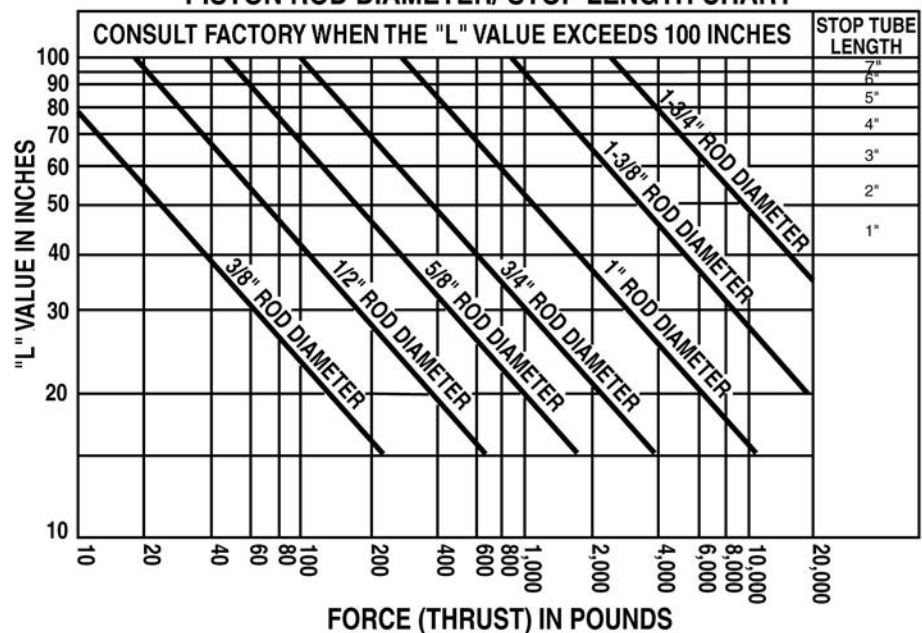

Note: When a stop tube is needed, a minimum 2" length is required on all Economair cylinders with Lip packings, and in 4", 5", 6" and 8" Provenair cylinders.

Stop Tube Requirements Available in Economair & Provenair Only

Occasionally, an application will require a stop tube. Stop tube length is determined by "L" value. If your "L" value (from Step B) is 40 or greater, find the correct stop tube length for your cylinder on the right side of the piston rod diameter/stop length chart. The recommended stop-tube length is shown above the "L" value line.

Note: If "L" value is 39, no stop tube is required. If "L" value is 40-49, a 1" stop tube is recommended. If "L" value is 50-59, a 2" stop tube is recommended, etc.

Pneumatic Cylinders

Options

Additional options required will help determine which cylinder series will be selected:

Stainless steel piston rods are beneficial in corrosive environments. Stainless steel rods are standard on Micro-Air and Silverair Series. Stainless Steel rods are options on Economair and Provenair Series.

Cylinder cushions are designed to reduce the shock experienced at the end of the stroke by reducing piston speed the last fraction of an inch of stroke. Cylinder cushions are available in Economair and Provenair Series, only.

Packing shape and material affect cylinder performance:

- O-Ring packings are good, general purpose packings, but they require more breakaway force than other packing shapes.
- O-Ring – Low Friction packings provide the effective sealing characteristics of Buna N with the low friction characteristics of PTFE. This design is effective where the cylinder must operate at low pressures.
- U-Cup packings offer low breakaway friction and better sealing characteristics at low pressure than O-Ring packings. U-cups are wear compensating seals; they offer longer wear life than O-rings.
- U-Cup – Self Lube (“Slippery Seals”) packings are ideal in applications where air line lubrication cannot be used. This packing design helps reduce cylinder “chatter” in low pressure applications and it offers the same sealing characteristics as Buna N.

Packing Characteristics

	Material	Sealing Characteristics	Friction Characteristics	Temperature Tolerance	Availability
O-RING	PTFE over Buna N O-Ring Seal	Good	Medium	0° to 180° F	Economair
O-RING	Buna N	Good	High	0° to 180° F	Premair, Micro-Air, Economair
O-RING	Viton™	Good	High	Up to 300° F	Premair, Micro-Air, Economair
U-CUP-SELF-LUBE (“Slippery Seals”)	Nitrile	Very Good	Low	0° to 180° F	Economair, Provenair
U-CUP	Buna N	Very Good	Medium	0° to 180° F	Economair, Provenair
U-CUP	Viton	Very Good	Medium	Up to 300° F	Economair, Provenair

Note: When applying rod cylinders, there must be no side load or bending stress at any point along the rod. Applications which induce side load and/or bending stress will damage packings, bushings, piston barrels, piston rods and cushion bosses. When metal parts are damaged, seal and packing replacement is an inadequate repair. The elastomers will quickly become damaged. Inspect and replace all worn or damaged parts when rebuilding cylinders.

Micro-Air

Features

Series 01

Micro-Air Cylinders are ideal for small part positioning, clamping and ejecting. Also they're the perfect choice for applications where small bore, medium duty, repairable cylinders are preferred. Prelubed, they're suitable for operations without externally applied lubrication.

- Micro-Air Cylinders are repairable. Service kits are available to extend the useable life of the cylinder.
- Micro-Air Cylinders operate on air pressure to 200 p.s.i. (14 bar). A tough little cylinder that can handle the pressures!
- Superior performance over a wide temperature range – 0° to 180° F (-18° to 82° C), even to 300° F (149° C) when Viton seals are used (consult factory).
- Micro-Air Cylinders have superior wear characteristics, thanks to the hard coated aluminum tubing I.D. In addition to an internal hardness of 60 Rockwell C, the barrel has an internal finish of 16 microinches or better.
- Micro-Air Cylinders are equipped with Series 303 stainless steel piston rods for corrosion resistance. Also, the ground and polished finish on the rods minimizes friction, providing longer packing life.
- Micro-Air Cylinders provide greater durability than disposable cylinders.
- Double end-mount cylinders can also be used as a pivot mount. Pivot pin included with each cylinder.



Performance Specs

Bore Sizes: 3/4" and 1-1/8"

Maximum Output Force: 199 pounds (1-1/8" bore)

Standard Operating Temperature Range: 0° to 180°F (-18° to 82°C)

Viton Seals Models: For high heat applications. Consult factory.

Range of mounting styles and attachable mounts/ accessories to meet nearly any application requirement.

Ordering

Position		1		2						3	
Example:	01	XX	-	X	X	X	X	-	0	X	X

Position 1 Bore Size	Position 2 Cylinder Type and Mounting Style	Position 3 Stroke Length	
76 - 3/4"	1009 - Double Acting, Double End Mount and Pivot Mount, BUNA-N Seals	Whole Inches	Fraction Inches
18 - 1-1/8"	5029 - Double Acting, Nose Mount, Rear Port, BUNA-N Seals	0 = 0"	0 = None
	1309 - Double Acting, Double End Mount and Pivot Mount, Viton Seals	1 = 1"	1 = 1/8"
	5329 - Double Acting, Nose Mount, Rear Port, Viton Seals	2 = 2"	2 = 1/4"
		3 = 3"	3 = 3/8"
		4 = 4"	4 = 1/2"
		5 = 5"	5 = 5/8"
		6 = 6"	6 = 3/4"
			7 = 7/8"

NOTE: Bold selections denote most popular models.

Maximum stroke length - 6-7/8-inches. Consult factory for the other stroke requirements.

Micro-Air

Dimensional Data

Series 01

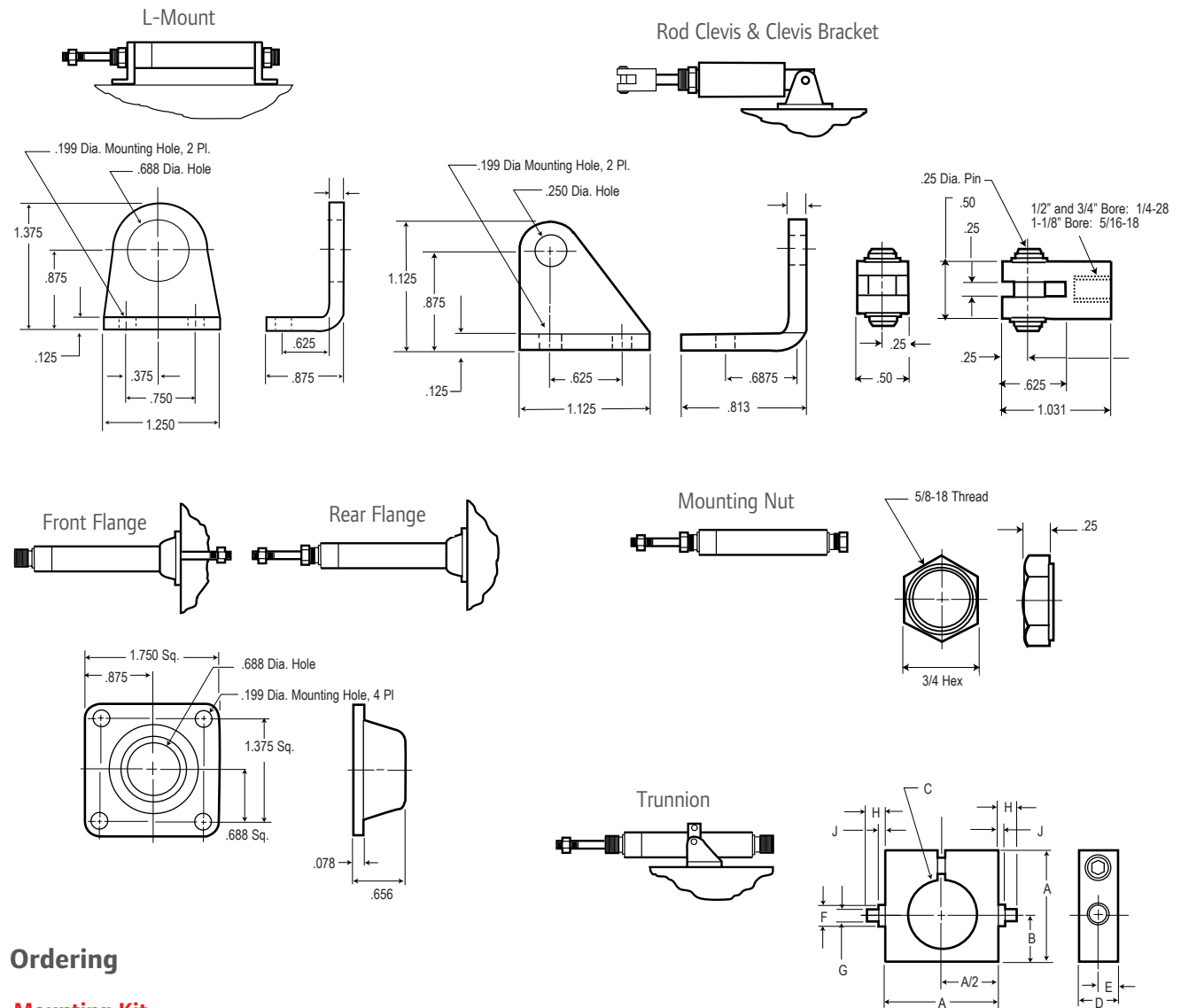

Ordering

Mounting Kit

	Cylinder Bore	
	3/4"	1-1/8"
L-MOUNTS (2 Qty) *	20515	20515
FLANGE MOUNT *	20516	20516
MOUNTING NUT (2 Qty)	20514-1	20514-1
CLEVIS BRACKET	20519	20519
TRUNNION	20523	NA
TRUNNION BRACKETS**	20561	NA
ROD CLEVIS	20517	20518-1

* NOTE: Mounting nuts included.

** 20561 Trunnion Bracket Kit (right and left brackets) is used for 20523 Trunnion. Reference Clevis bracket dimensions.

Cylinder Bore

Reference	3/4"
A	1.50
B	0.625
C Dia.	0.953
D	0.500
E	0.250
F Dia.	-
G Dia. ± .002	0.250
H ± .010	0.250
J	-

Trunnion Dimensions

A	1.50
B	0.625
C Dia.	0.953
D	0.500
E	0.250
F Dia.	-
G Dia. ± .002	0.250
H ± .010	0.250
J	-

Dimensional Data

Series 01

Reference	Cylinder Bore (Inches)	
	3/4	1-1/8
Rod Diameter	1/4	5/16
AA	2.438	2.688
BB	.625	.625
CC	.750	.750
CB	1.375	1.375
DD	.047	.047
EE	.281	.281
FF*	.719	.719
GG (± .002)	.682	.682
HH	1/4-28 .UNF	5/16-18 .UNC
JJ (UNF-2A)	5/8-18	5/8-18
KK	2	2
LL (NPTF)	1/8-27	1/8-27
MM	.912	1.350**
PP	.375	.375
QQ (SLOT) ± .002	.130	.130
RR (PIN)	.250	.250
SS	.625	.625
TT DIA.	.950	1.375

* Note: FF shows total thread, including run out.

** On rear head only of 5029 dimension is 1.291.

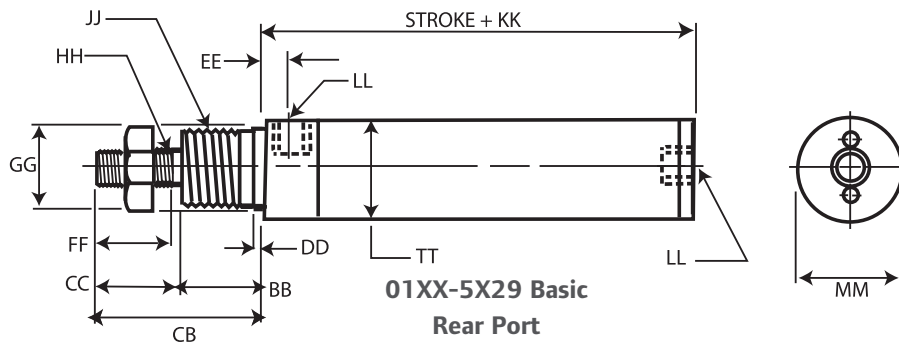
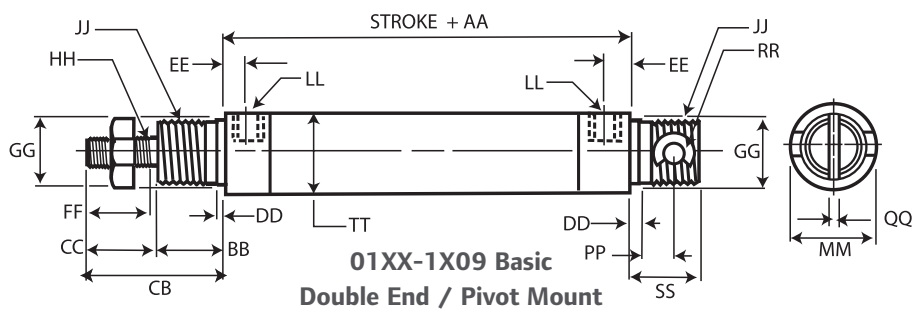

Silverair™

Features

Series S

Silverair round cylinders are designed for application in OEM and MRO applications where a disposable, light duty cylinder is preferred. Prelubed, they're suitable for operations without externally applied lubrication. Constructed of stainless steel and aluminum, they stand up to the attack of corrosive environments.

- Silverair cylinders feature stainless steel (Series 304) barrels. Drawn and polished internal diameters have superior lube-holding characteristics for a low friction surface that gives smooth performance and outstanding cycle life.
- Piston rods are centerless ground and polished Series 303 stainless steel, providing smooth rod movement.
- Lightweight aluminum heads feature full flow ports for maximum air flow and smooth response.
- Piston rod threads are roll formed to provide superior strength and durability.
- U-cup design on piston seals provides continuous cylinder barrel contact, minimizes blow-by and offers longer seal life than O-ring piston seals.
- The oil-permeated bronze rod bushing is precision ball sized for reduced friction and increased cylinder life.
- Return springs on single-acting cylinders are made from a high tensile alloy for exceptional performance and long service life.
- Silverair cylinders are prelubricated, so they're ideal in applications where external lubrication can't be supplied.

Performance Specifications

Bore Sizes:	1/2", 3/4", 1-1/16", 1-1/4", 1-1/2", 2" & 2-1/2"
Air Pressure:	to 200 p.s.i. (14 bar)
Operating Temperature Range:	-40° to 160° F (18° to 82° C)
Maximum Output Force:	982 pounds (2-1/2-inch bore cylinder)
Viton Seals Models:	For high heat applications, consult factory

Range of mounting styles and attachable mounts/accessories covers wide range of application requirements.
Magnetic pistons available for use with Hall Effect or Reed Switches.

Ordering

See following page.



Ordering Include dashes. Dashes are significant.

Position	1	2	3		4	5	6	7		8	
Example:	S	X	XX	-	X	X	X	X	-	XX	X

Position 1 Series	Position 2 Cylinder Type	Position 3 Bore Size
S - Stainless Steel	S - Single Acting, Spring Return (Not available on 25 bore size) D - Double Acting R - Single Acting, Spring Extend (Not available on 25 bore size) H - Single Acting, Hex Rod (Non-rotating rod) (Spring return only) Not available on 14, 17,20 or 25 bore sizes)	05 1/2" 07 3/4" 11 1-1/16" 14 1-1/4" (Not available on type SH) 15 1-1/2" 17 1-3/4" (Not available on type SH) 20 2" (Not available on type SH) 25 2-1/2" (Not available on type SS, SR or SH)

Position 4 Mounting Style	Position 5 Magnet/Bumpers (Note A)	Position 6 Packing	Position 7 Wearstrip (Note B)
B - Block Mount (Available on 05, 07, 11 and 15 bore size only) (Not available on type SH) D - Double Rod End (Double Acting Only) N - Nose Mount P - Universal Mount (Pivot or Double End) <small>Silverair attachable mounts must be ordered separately. See page 14</small>	4 - No Bumpers, no magnet B - Bumpers M - Magnetic Piston (Not available in 1/2" bore or for single-acting cylinders) <small>For switch information, see page 23.</small>	B - Buna N V - Viton	4 - None (standard) W - Wearstrip

Position 8 Stroke Length	
Whole Inches	Fraction Inches
00 = 0"	0 = None
01 = 1"	1 = 1/8"
02 = 2"	2 = 1/4"
03 = 3"	3 = 3/8"
04 = 4"	4 = 1/2"
05 = 5"	5 = 5/8"
06 = 6"	6 = 3/4"
10 = 10"	7 = 7/8"
etc.	

Note A: Bumpers

- Not available with magnetic piston option.
- Standard on double rod ends.
- Do not affect external dimensions.

Note B: Wearstrip is standard on double-acting nose mount, universal mount and block front mount of 5" or more of stroke. Also on single acting, spring extend cylinders with 3" or more of stroke. Not available on 1/2" bore cylinders. Not available on single acting, hex rod (non-rotating rod)

NOTE: Bold selections denote most popular models.

For recommended maximum stroke lengths, per type, see pages 16 through 21.

Ordering

Series S (Mounting Kits)

		CYLINDER BORE (INCHES)						
1/2	3/4	1-1/16	1-1/4	1-1/2	1-3/4	2	2-1/2	
L-MOUNT (Single Acting)								
Order Mounting Nut below.								
118108-5	118108-7	118108-11	118108-14	118108-14	118108-17	118108-20	118108-25	
L-MOUNT (DOUBLE ACTING)								
Order Mounting Nut below.								
118108-50	118108-11	118108-11	118108-14	118108-14	118108-17	118108-20	118108-25	
MOUNTING NUT (SINGLE ACTING*)								
118109-5	118109-7	118109-11	118109-14	118109-14	118109-17	118109-20	118109-25	
MOUNTING NUT (DOUBLE ACTING)								
118109-50	118109-11	118109-11	118109-14	118109-14	118109-17	118109-20	118109-25	
PIVOT BRACKET (PIVOT PIN INCLUDED)								
117523-5	117523-7	117523-7	117523-14	117523-15	117523-15	117523-20	117523-20	
ROD CLEVIS (PIVOT PIN INCLUDED)								
117555-5	117555-7	117555-11	117555-14	117555-14	117555-17	117555-17	117555-17	
PIVOT PINS (STANDARD EQUIPMENT)								
118119-5	118119-7	118119-7	118119-14	-	-	118119-20	-	
RETAINER								
118592-5	118592-5	118592-5	118592-5	118592-15	118592-15	118592-15	-	
OPTIONAL PRESS FIT PIN								
118121-5	118121-7	118121-7	118121-14	118121-15	118121-15	-	-	

FOR DOUBLE END MOUNTING OF SINGLE-ACTING CYLINDERS, ORDER THE FOLLOWING:

1/2-inch bore	One 118108-5 L-Mount and one 118109-5 Nut for rear mounting thread. One 118108-50 L-Mount and one 118109-50 Nut for front mounting thread.
3/4-inch bore	Two 118108-7 L-Mounts, one 118109-7 Nut for rear mounting thread and one 118109-11 Nut for front mounting thread.

NOTE: Silverair accessories are bright zinc plated steel.

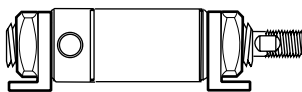

L-Mount

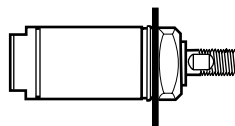

Mounting Nut

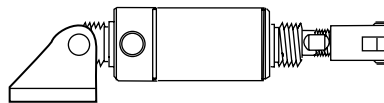

Pivot Bracket and Rod Clevis

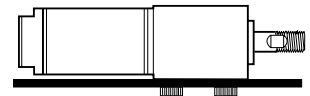

Block Front Mount

Dimensional Data

Series S (Mounting Kits)

Dim Ref	CYLINDER BORE (INCHES)									
	1/2		3/4		1-1/16	1-1/4	1-1/2	1-3/4	2	2-1/2
	Single Acting	Double Acting	Single Acting	Double Acting	All Types	All Types	All Types	All Types	All Types	All Types
L-Mount Bracket										
A	.31	.31	.44	.56	.56	.75	.75	.94	1.00	1.00
B	.19	.19	.19	.27	.27	.28	.28	.34	.34	.34
C	.62	.62	.75	1.00	1.00	1.50	1.50	1.50	1.62	1.62
D	1.00	1.00	1.25	1.50	1.50	1.89	1.89	2.25	2.25	2.88
E	.37	.37	.40	.56	.56	.75	.75	.88	1.00	1.25
F	.38	.44	.50	.63	.63	.76	.76	1.04	1.38	1.50
G	56°	56°	45°	45°	45°	49°	49°	52°	60°	63°
H	.57	.57	.69	.81	.81	1.00	1.00	1.25	1.50	1.75
J	1.38	1.38	1.63	1.88	1.88	2.50	2.50	3.00	3.00	3.75
Mounting Nut										
A	.56	.68	.75	.93	.93	1.12	1.12	1.50	1.85	2.06
B	.22	.25	.31	.37	.37	.42	.42	.56	.50	.50
C	3/8-24	7/16-20	1/2-20	5/8-18	5/8-18	3/4-16	3/4-16	1-14	1-1/4-12	1-3/8-12

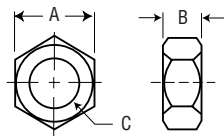
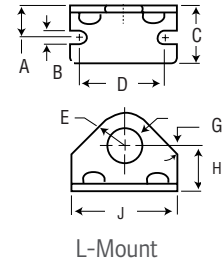

Mounting Nut

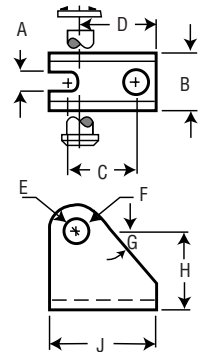

Pivot Bracket

Dim Ref	CYLINDER BORE (INCHES)								
	1/2 All Types	3/4 All Types	1-1/16 All Types	1-1/4 All Types	1-1/2 All Types	1-3/4 All Types	2 All Types	2-1/2 All Types	
Rod Clevis									
A	.38	.50	.50	.75	.75	.75	.75	.75	.75
B	.19	.25	.25	.38	.38	.38	.38	.38	.38
C	.75	.94	.94	1.30	1.30	1.30	1.30	1.30	1.30
D	.38	.50	.50	.75	.75	.75	.75	.75	.75
E	10-32	1/4-28	5/16-24	7/16-20	7/16-20	1/2-20	1/2-20	1/2-20	1/2-20
F	.19	.25	.25	.38	.38	.38	.38	.38	.38
G	.94	1.20	1.20	1.70	1.70	1.70	1.70	1.70	1.70
H	.12	.16	.16	.25	.25	.31	.31	.31	.31

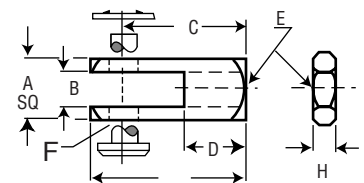

Rod Clevis

Pivot Pin

As supplied with Pivot Bracket:

A	.69	.81	.81	.94	1.13	1.13	1.44	1.44
B	.15	.25	.25	.25	.37	.37	.37	.37

For press fit into pivot hole:

A	.50	.75	.75	.87	1.12	1.12	-	-
B	.15	.24	.24	.24	.37	.37	-	-
C	.17	.26	.26	.26	.39	.39	-	-

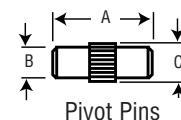
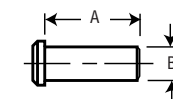

Pivot Pins

Silverair™

Performance Specifications

Series S (Spring Return, Nose Mount)

Model SSXX-N4B4-XXX - (Max. Stroke - 4 inches)	
Bore sizes:	1/2", 3/4", 1-1/16", 1-1/4", 1-1/2" 1-3/4", 2"
Hex Mounting Nut:	Standard (except on 2-inch models).
Options:	Wearstrip (except on 1/2-inch bore), bumper, Viton
Accessories:	L-mount, rod clevis
Notes:	No rod bushing on 1/2-inch models - front head is hard anodized.

Series S (Spring Return, Universal Mount)

Model SSXX-P4B4-XXX - (Max. Stroke - 4 inches)	
Bore sizes:	1/2", 3/4", 1-1/16", 1-1/4", 1-1/2" 1-3/4", 2"
Options:	Wearstrip (except on 1/2-inch bore), bumper, Viton
Accessories:	Pivot bracket, rod clevis, L-mount, mounting nut. Order mounting nuts as required.
Notes:	No rod bushing on 1/2-inch models - front head is hard anodized.

Model SHXX-N4B4-XXX - (Max. Stroke - 4 inches)	
Nonrotating	
Bore sizes:	1/2", 3/4", 1-1/16", 1-1/2"
Hex Mounting Nut:	Standard
Options:	Wearstrip (except on 1/2-inch bore),
Accessories:	L-mount, rod clevis
Notes:	No rod bushing - front head is hard anodized.

Model SHXX-P4B4-XXX - (Max. Stroke - 4 inches)	
Nonrotating	
Bore sizes:	1/2", 3/4", 1-1/16", 1-1/2"
Options:	Wearstrip (except on 1/2-inch bore), bumper, Viton
Accessories:	Pivot bracket, rod clevis, L-mount, mounting nut. Order mounting nuts as required.
Notes:	No rod bushing - front head is hard anodized.

Dimensional Data

Series S (Spring Return, Nose Mount)

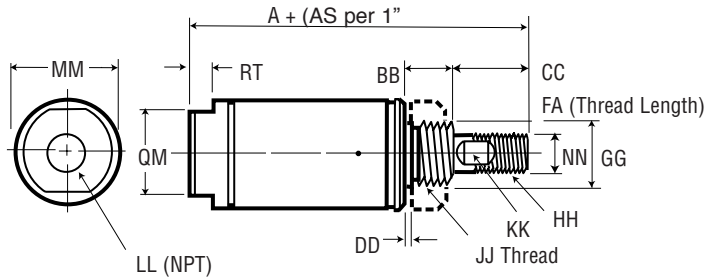

Series S (Spring Return, Universal Mount)

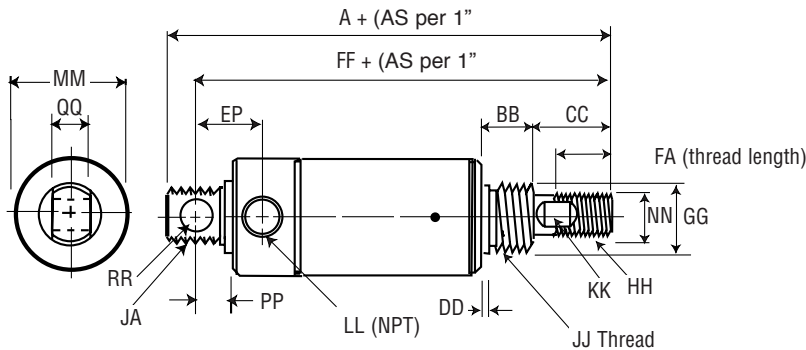

Spring Forces

Bore Size	Spring Force (lbs.)	
	Normal	Actuated
1/2"	1	2
3/4"	1.5	5
1-1/16"	4	8
1-1/4"	7	14
1-1/2"	6	12
1-3/4"	12	24
2"	15	30

Dimensional Data

Series S

Dim Code	Cylinder Description	CYLINDER BORE (INCHES)						
		1/2	3/4	1-1/16	1-1/4	1-1/2	1-3/4	2
Single Acting								
A	SSXX-N4B4-XXX	1.81	2.00	2.56	3.41	3.19	3.85	4.17
A	SHXX-N4B4-XXX	2.06	2.25	2.68	-	3.44	-	-
A	SSXX-P4B4-XXX	2.50	3.06	3.44	4.50	4.25	5.41	5.54
A	SHXX-P4B4-XXX	2.75	3.31	3.56	-	4.50	-	-
AS	SSXX-N4B4-XXX	1.88	1.69	1.56	1.81	1.69	2.00	2.00
AS	SHXX-N4B4-XXX	1.88	1.69	1.56	-	1.69	-	-
AS	SSXX-P4B4-XXX	1.88	1.69	1.56	1.81	1.69	2.00	2.00
AS	SHXX-P4B4-XXX	1.88	1.69	1.56	-	1.69	-	-
BB	SSXX-N4B4-XXX	.31	.44	.50	.62	.62	.75	.81
BB	SHXX-N4B4-XXX	.31	.44	.50	-	.62	-	-
BB	SSXX-P4B4-XXX	.31	.44	.50	.62	.62	.75	.81
BB	SHXX-P4B4-XXX	.31	.44	.50	-	.62	.75	.81
CC	SSXX-XXXX-XXX	.50	.50	.62	1.00	1.00	1.19	-
CC	SHXX-XXXX-XXX	.75	.75	.75	-	1.25	-	-
DD	All Types	.04	.07	.07	.07	.07	.09	.12
EP	All Types	.42	.66	.62	.91	.81	.98	1.00
FA	All Types	.50	.50	.50	.50	.75	.88	.88
FF	SSXX-X4B4-XXX	2.25	2.77	3.16	4.14	3.88	4.91	5.11
GG	All Types	.375	.500	.625	.750	.750	1.03	1.375
HH	All Types	10-32	1/4-28	5/16-24	7/16-20	7/16-20	1/2-20	1/2-20
JA	SSXX-N4B4-XXX	7/16-20	5/8-18	5/8-18	3/4-16	3/4-16	1-14	1-1/4-12
JA	SHXX-N4B4-XXX	3/8-24	5/8-18	5/8-18	-	3/4-16	-	-
JJ	All Types	3/8-24	1/2-20	5/8-18	3/4-16	3/4-16	1-14	1-1/4-12
KK	Wrench Flat	None	None	.25	.38	.38	.44	.50
LL	All Types	10-32	1/8	1/8	1/8	1/8	1/4	1/4
MM	All Types	.56	.81	1.12	1.31	1.55	1.81	2.07
NN	Standard Rod	.187	.250	.312	.437	.437	.500	.625
NN	Hex Flats	.187	.250	.375	-	.437	-	-
PP	All Types	.25	.34	.34	.41	.50	.50	.57
QM	All Types	.37	.62	.87	.87	.82	1.25	1.25
QQ	All Types	.31	.38	.38	.50	.62	.62	.75
RR	All Types	.16	.25	.25	.25	.38	.38	.38
RT	All Types	.12	.16	.25	.18	.25	.25	.31

Performance Specifications

Series S (Spring Extend, Nose Mount)

Model SRXX-N4B4-XXX - (Max. Stroke - 4 inches)

Bore sizes:	1/2", 3/4", 1-1/16", 1-1/4", 1-1/2" 1-3/4", 2"
Hex Mounting Nut:	Standard
Options:	Bumper, Viton
Accessories:	Rod clevis, L-mount
Wearstrip:	Not available on 1/2-inch bore. Standard with 3 inches of stroke, or more (optional on shorter strokes).
Notes:	No rod bushing on 1/2-inch models - front head

Series S (Block Front Mount - Spring Extend or Spring Return)

Model S5XX-B4B4-XXX - (Max. Stroke-4 inches) (Spring Return)

Bore sizes:	1/2", 3/4", 1-1/16"
Options:	Wearstrip (except on 1/2-inch bore), bumper, Viton
Accessories:	Rod clevis
Notes:	No rod bushing on 1/2-inch models - front head is hard anodized. Head is hard anodized.

Series S (Spring Extend, Universal Mount)

Model SRXX-P4B4-XXX - (Max. Stroke - 4 inches)

Bore sizes:	1/2", 3/4", 1-1/16", 1-1/4", 1-1/2" 1-3/4", 2"
Options:	Bumper, Viton
Accessories:	Pivot bracket, rod clevis, L-mount, mounting nut.
Wearstrip:	Not available on 1/2-inch bore. Standard with 3 inches of stroke, or more (optional on shorter strokes).
Notes:	No rod bushing on 1/2-inch models - front head

Model SRXX-B4B4-XXX (Spring Extend, Illustrated) (Max. Stroke - 4 inches)

Bore sizes:	1/2", 3/4", 1-1/16"
Options:	Bumper, Viton
Accessories:	Rod clevis
Wearstrip:	Not available on 1/2-inch bore. Standard with 3 inches of stroke, or more (optional on shorter strokes).
Notes:	No rod bushing on 1/2-inch models - front head is hard anodized.

Dimensional Data

Series S (Spring Extend, Nose Mount)

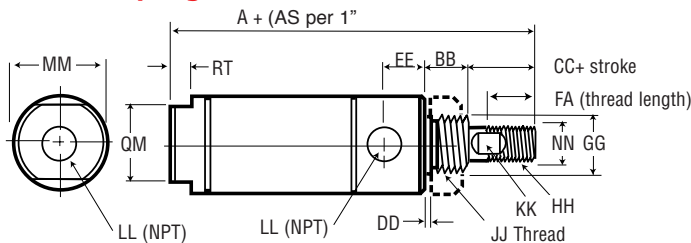

Series S (Block Front Mount - Spring Extend or Spring Return)

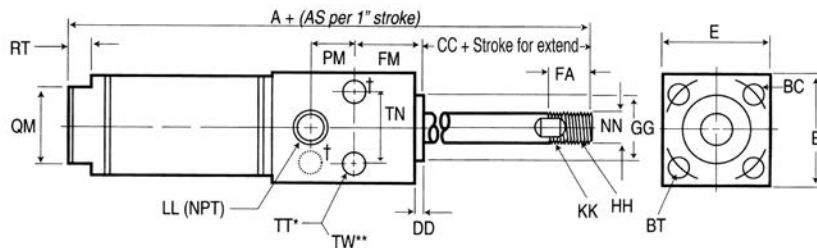

Series S (Spring Extend, Universal Mount)

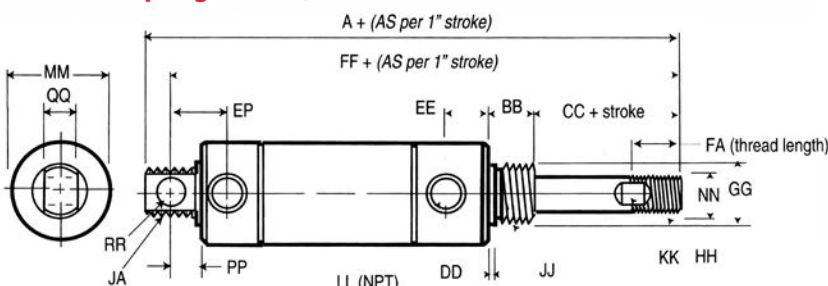

Spring Forces

Bore Size	Spring Force (lbs.) Normal	Spring Force (lbs.) Actuated
1/2"	1	2
3/4"	1.5	5
1-1/16"	4	8
1-1/4"	7	14
1-1/2"	6	12
1-3/4"	12	24
2"	15	30

*TT - Two thru holes drilled and counterbored on port side for cap screw size listed.

**TW - Above thru holes tapped on opposite side for additional mounting option.

† - Mounting hole locations for 1/2-inch models.

Dimensional Data

Series S

Dim Code	Cylinder Description	CYLINDER BORE (INCHES)						
		1/2	3/4	1-1/16	1-1/4	1-1/2	1-3/4	2
Single Acting								
A	SRXX-N4B4-XXX	2.42	2.78	3.28	4.25	4.00	5.03	5.11
A	SRXX-P4B4-XXX	3.12	3.84	4.15	5.33	5.06	6.59	6.48
A	SSXX-B4B4-XXX	2.42	3.34	4.28	-	5.00	-	-
A	SRXX-B4B4-XXX	2.42	3.34	4.28	-	5.18	-	-
AS	SRXX-N4B4-XXX	1.44	2.69	2.56	2.81	2.69	3.00	3.00
AS	SRXX-P4B4-XXX	1.44	2.69	2.56	2.81	2.69	3.00	3.00
AS	SSXX-B4B4-XXX	1.88	1.69	1.56	-	1.69	-	-
AS	SRXX-B4B4-XXX	2.88	2.69	2.56	-	2.69	-	-
BB	All Types	.41	.50	.50	.62	.62	.75	.81
BC	Bolt Circle Dia.	.75	1.00	1.25	-	1.75	-	-
BT	Threaded Hole	8-32(2)	10-32(2)	10-32(2)	-	1/4-20	-	-
CC	SRXX-N4B4-XXX	.50	.50	.62	1.00	1.00	1.19	1.25
CC	SRXX-P4B4-XXX	.50	.50	.62	1.00	1.00	1.19	1.25
CC	SRXX-B4B4-XXX	.50	1.06	1.12	-	1.50	-	-
CC	SSXX-B4B4-XXX	.50	1.06	1.12	-	1.50	-	-
DD	Block Front Mount	.06	.09	.09	-	.12	-	-
DD	All Others	.04	.07	.07	.07	.07	.09	.12
E	Block Front Mount	.75	1.00	1.25	-	1.75	-	-
EE	All Types	.37	.48	.52	.69	.62	.72	.69
EP	SRXX-P4B4-XXX	.42	.66	.62	.91	.81	.98	1.00
FA	Block Front	.50	.75	.75	-	1.25	-	-
FA	All Others	.50	.50	.50	.50	.75	.88	.88
FF	SRXX-P4B4-XXX	5.76	3.55	3.87	4.97	4.69	6.09	6.05
FM	Block Front Mount	.31	.48	.72	-	1.00	-	-
GG	Block Front Mount	.437	.625	.750	-	1.00	-	-
GG	SRXX-XXXX-XXX	.437	.625	.625	.750	.750	1.03	1.375
HH	All Types	10-32	1/4-28	5/16-24	7/16-20	7/16-20	1/2-20	1/2-20
JA	SRXX-P4B4-XXX	7/16-20	5/8-18	5/8-18	3/4-16	3/4-16	1-14	1-1/4-12
JJ	All Types	7/16-20	5/8-18	5/8-18	3/4-16	3/4-16	1-14	1-1/4-12
KK	Wrench Flat	None	None	.25	.38	.38	.44	.50
LL	Block Front Mount	10-32	1/8	1/8	1/8	1/4	-	-
LL	All Others	10-32	1/8	1/8	1/8	1/8	1/4	1/4
MM	All Types	.62	.88	1.12	1.31	1.55	1.81	2.07
NN	All Types	.187	.250	.312	.437	.437	.500	.625
PM	Block Front Mount	.44	.51	.54	-	.66	-	-
PP	SRXX-P4B4-XXX	.25	.34	.34	.41	.50	.50	.57
QM	All Types	.37	.62	.87	.87	.82	1.25	1.25
QQ	SRXX-P4B4-XXX	.31	.38	.38	.50	.62	.62	.75
RR	SRXX-P4B4-XXX	.16	.25	.25	.25	.38	.38	.38
RT	All Types	.12	.16	.25	.18	.25	.25	.31
TN	Block Front Mount	.44	.62	.81	-	1.12	-	-
TT	Block Front Mount	8-32	10-32	10-32	-	1/4-20	-	-
TW	Block Front Mount	-	1/4-20	1/4-20	-	5/16-18	-	-

Performance Specifications

Series S (Nose Mount)

Model SDXX-N4B4-XXX - (Max. Stroke - 12 inches)	
Bore sizes:	1/2", 3/4", 1-1/16", 1-1/4", 1-1/2" 1-3/4", 2", 2-1/2"
Hex Mounting Nut:	Standard (Except on 2 and 2-1/2-inch models).
Options:	Bumper, Viton, Internal Magnet
Accessories:	Rod clevis, L-mount
Wearstrip:	Not available on 1/2-inch bore. Standard with 5 inches of stroke, or more (optional on shorter strokes).
Notes:	No rod bushing on 1/2-inch models - front head is hard anodized.

Series S (Universal Mount)

Model SDXX-P4B4-XXX - (Max. Stroke - 12 inches)	
Bore sizes:	1/2", 3/4", 1-1/16", 1-1/4", 1-1/2" 1-3/4", 2", 2-1/2"
Options:	Bumper, Viton, Internal Magnet
Accessories:	Pivot bracket, rod clevis, L-mount, mounting nut.
Wearstrip:	Not available on 1/2-inch bore. Standard with 5 inches of stroke, or more (optional on shorter strokes).
Notes:	No rod bushing on 1/2-inch models - front head is hard anodized.

Dimensional Data

Series S (Nose Mount)

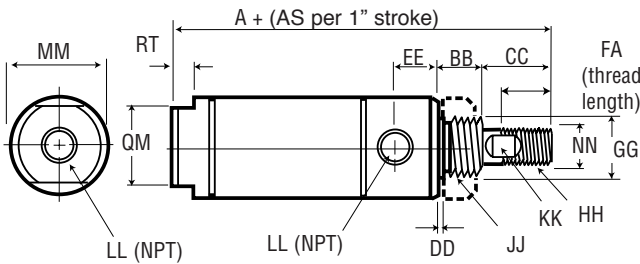

Series S (Universal Mount)

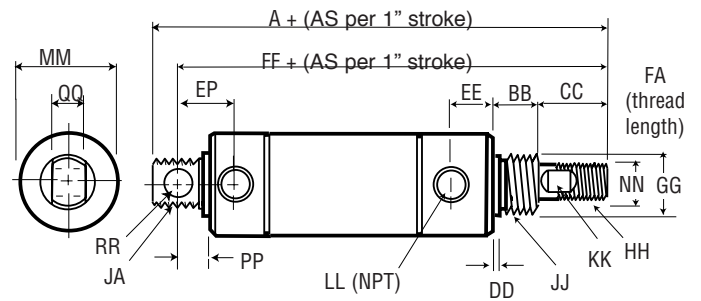

Dim Code	Cylinder Description	CYLINDER BORE (INCHES)							
		1/2	3/4	1-1/16	1-1/4	1-1/2	1-3/4	2	2-1/2
Double Acting									
A	SDXX-N4B4-XXX	2.62	3.47	3.75	4.75	4.44	5.57	5.56	5.56
A	SDXX-P4B4-XXX	3.31	4.54	4.62	5.83	5.50	7.13	6.93	6.93
AS	All Types	1.00	1.00	1.00	1.00	1.00	1.00	1.00	1.00
BB	All Types	.41	.50	.50	.62	.62	.75	.81	.81
CC	All Types	.50	.50	.62	1.00	1.00	1.19	1.25	1.25
DD	All Types	.04	.07	.07	.07	.07	.09	.12	.12
EE	All Types	.37	.48	.52	.69	.62	.72	.69	.69
EP	SDXX-P4B4-XXX	.42	.66	.62	.91	.81	.98	1.0	1.0
FA	All Types	.50	.50	.50	.75	.75	.88	.88	.88
FF	SDXX-P4B4-XXX	6.12	4.25	4.34	5.47	5.12	6.63	6.50	6.50
GG	All Types	.437	.625	.625	.750	.750	1.030	1.50	1.50
HH	All Types	10-32	1/4-28	5/16-24	7/16-20	7/16-20	1/2-20	1/2-20	1/2-20
JJ	All Types	7/16-20	5/8-18	5/8-18	3/4-16	3/4-16	1-14	1-1/4-12	1-3/8-12
KK	All Types	None	None	.25	.38	.38	.44	.50	.50
LL	All Types	10-32	1/8	1/8	1/8	1/8	1/4	1/4	1/4
MM	All Types	.62	.88	1.12	1.31	1.55	1.81	2.07	2.62
NN	All Types	.187	.250	.312	.437	.437	.500	.625	.625
PP	SDXX-P4B4-XXX	.25	.34	.34	.41	.50	.50	.57	.57
QM	SDXX-N4B4-XXX	.37	.62	.87	.87	.87	1.25	1.25	1.75
QQ	SDXX-P4B4-XXX	.31	.38	.38	.50	.62	.62	.75	.75
RR	SDXX-P4B4-XXX	.16	.25	.25	.25	.38	.38	.38	.38
RT	SDXX-N4B4-XXX	.12	.16	.25	.18	.25	.25	.31	.31

Performance Specifications

Series S (Double Rod End, Double End Mount)

Model SDXX-D4B4-XXX - (Max. Stroke - 12 inches)

Bore sizes:	1/2", 3/4", 1-1/16", 1-1/4", 1-1/2" 1-3/4", 2", 2-1/2"
Hex Mounting Nut:	Standard (Except on 2 and 2-1/2"-inch models) and bumpers.
Options:	Viton, wearstrip.
Accessories:	L-mount, rod clevis, mounting nut (2, 2-1/2"-inch models)
Notes:	No rod bushing on 1/2-inch models - heads are hard anodized.

Series S (Block Front Mount)

Model SDXX-B4B4-XXX - (Max. Stroke - 12 inches)

Bore sizes:	1/2", 3/4", 1-1/16"
Options:	Wearstrip, Bumpers, Viton, Internal Magnet
Accessories:	Rod clevis
Wearstrip:	Not available on 1/2-inch bore. Standard with 5 inches of stroke, or more (optional on shorter strokes).
Notes:	No rod bushing on 1/2-inch models - front head is hard anodized. Wearstrip not available on 1/2-inch bore. Wearstrip is standard with 5 inches of stroke, or more (optional on shorter strokes).

Dimensional Data

Series S (Double Rod End, Double End Mount)

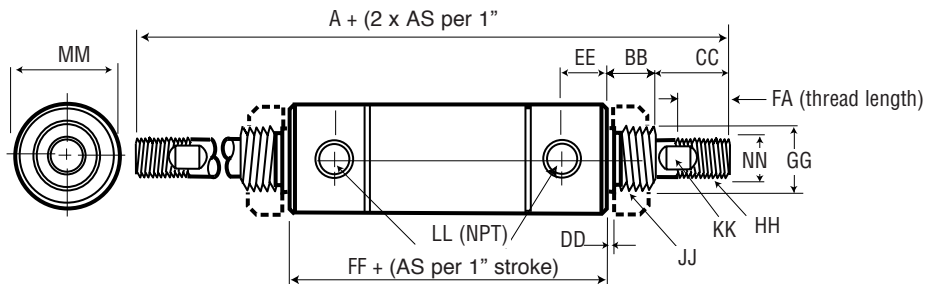

Series S (Block Front Mount)

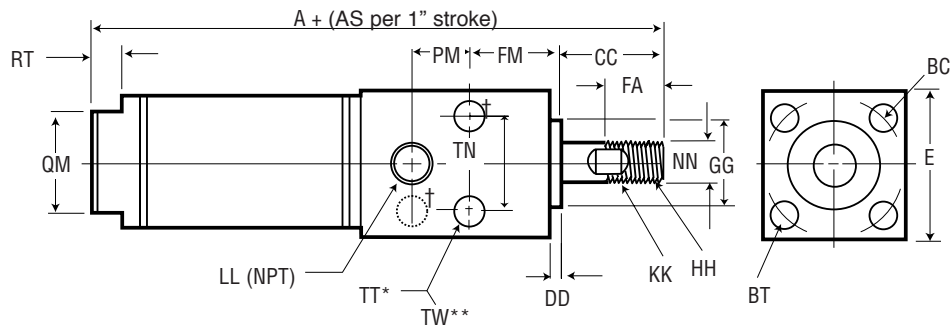

* TT - Two thru holes drilled and counterbored on port side for cap screw size listed.

** TW - Above thru holes tapped on opposite side for additional mounting option.

† Mounting hole locations for 1/2-inch models.

Dimensional Data

Series S

Dim Code	Cylinder Description	CYLINDER BORE (INCHES)							
		1/2	3/4	1-1/16	1-1/4	1-1/2	1-3/4	2	2-1/2
Double Acting									
A	SDXX-D4B4-XXX	3.88	5.03	5.32	6.83	6.63	8.57	8.31	8.31
A	Block Front Mount	2.62	4.03	4.75	-	5.44	-	-	-
AS	Block Front Mount	1.00	1.00	1.00	-	1.00	-	-	-
AS	SDXX-D4B4-XXX	.50	1.00	1.00	1.00	1.00	1.00	1.00	1.00
BB	SDXX-D4B4-XXX	.41	.50	.50	.62	.62	.75	.81	.81
BC	Bolt Circle Dia.	.75	1.00	1.25	-	1.75	-	-	-
BT	Threaded Hole	8-32	10-32	10-32	-	1/4-20	-	-	-
CC	Block Front Mount	.50	1.06	1.12	-	1.50	-	-	-
CC	SDXX-D4B4-XXX	.50	.50	.62	1.00	1.00	1.19	1.25	1.25
DD	Block Front Mount	.06	.09	.09	-	.12	-	-	-
DD	SDXX-D4B4-XXX	.04	.07	.07	.07	.07	.09	.12	.12
E	Block Front Mount	.75	1.00	1.25	-	1.75	-	-	-
EE	SDXX-D4B4-XXX	.37	.48	.52	.69	.62	.72	.69	.69
FA	Block Front Mount	.50	.75	.75	-	1.25	-	-	-
FA	SDXX-D4B4-XXX	.50	.50	.50	.75	.75	.88	.88	.88
FF	SDXX-D4B4-XXX	2.07	3.03	3.07	3.58	3.39	4.69	4.19	4.19
FM	Block Front Mount	.31	.48	.72	-	1.00	-	-	-
GG	Block Front Mount	.437	.625	.750	-	1.00	-	-	-
GG	SDXX-D4B4-XXX	.437	.625	.625	.750	.750	1.030	1.50	1.50
HH	All Types	10-32	1/4-28	5/16-24	7/16-20	7/16-20	1/2-20	1/2-20	1/2-20
JJ	SDXX-D4B4-XXX	7/16-20	5/8-18	5/8-18	3/4-16	3/4-16	1-14	1-1/4-12	1-3/8-12
KK	All Types	None	None	.25	.38	.38	.44	.50	.50
LL	All Types	10-32	1/8	1/8	1/8	1/8	1/4	1/4	1/4
MM	SDXX-D4B4-XXX	.62	.88	1.12	1.31	1.55	1.81	2.07	2.62
NN	All Types	.187	.250	.312	.437	.437	.500	.625	.625
PM	Block Front Mount	.44	.51	.54	-	.66	-	-	-
QM	Block Front Mount	.37	.62	.87	-	.87	-	-	-
RT	Block Front Mount	.12	.16	.25	-	.25	-	-	-
TN	Block Front Mount	.44	.62	.81	-	1.12	-	-	-
TT	Block Front Mount	8-32	10-32	10-32	-	1/4-20	-	-	-
TW	Block Front Mount	-	1/4-20	1/4-20	-	5/16-18	-	-	-

Features

Series S (Hall Effect Switches)

Hall Effect Sensors are typically used in conjunction with computers, programmable controllers or other solid state devices to sense and process cylinder rod proximity. The solid state circuitry in this sinking switch (NPN) provides clean, fast output without “bounce.” The 300 mW power capability restricts its use to low power loads. One switch kit fits all Silverair cylinders for reduced and simplified inventory. 3/8 inch effective area per switch. For two switches, a minimum of 1-inch stroke is recommended.



118123-200
Series S (Hall Effect Switch)

Performance Specifications

Series S (Hall Effect Switches)

Input Voltage:	5 to 24 VDC
Input Current:	25 mA maximum
Output Voltage Drop:	0.4 VDC maximum
Output Current:	330 mA maximum
Power Dissipation:	300 mW maximum
Temperature Range:	-20° to 185°F (-29° to 85°C)

Ordering

Series S (Hall Effect Switches)

Model No.	Description
118123-100	w/LED, 5-24 VDC, 24 inch leads (includes 118124 Mounting Kit)
118123-200	w/LED, 5-24 VDC, 144 inch leads (includes 118124 Mounting Kit)

Series S (Reed Switches)

Epoxy encapsulated reed switches are ideal for harsh environments. One switch kit fits all Silverair cylinders for reduced and simplified inventory. 50 watt reed is common in all sensors. Model 117045-300 lights up during reed engagement in low voltage applications. Model 117045-500 lights up over wide voltage range. Model 117045-100 is a basic sensor with no LED.

Performance Specifications

Series S (Reed Switches)

Contacts:	Normally open
Contact Rating:	50 W maximum
Switching Current:	1 A maximum
Initial Contact Resistance:	1 Ohm
Min. Break Down Voltage:	225 VDC, 275 VAC
Temperature Range:	-40° to 200°F (-40° to 93°C)

Ordering

Series S (Reed Switches)

One 118124 Mounting Kit is included with each Reed Switch

Model No.	Description
117045-100	No LED, 120 VAC or 200 VDC max., 24 inch leads
117045-200	No LED, 120 VAC or 200 VDC max., 144 inch leads
117045-500	w/LED, 120 VAC or 200 VDC max., 24 inch leads
117045-600	w/LED, 120 VAC or 200 VDC max., 144 inch leads

Technical Information:

- Do not exceed specification, permanent damage to the sensor may occur.
- For reed switch type sensors, polarity must be observed for the proper functioning of LED. Connect the brown wire in series with load positive (+) and the blue wire to negative (-) or power source space. If the polarity is reversed, reed switch remains functional but LED will remain in “OFF” state.
- For solid-state type sensors, polarity must also be observed. Connect brown wire to the positive (+) and the blue to the negative (-) of DC power source. The black wire must connect to the load ONLY. If the black wire is accidentally connected to the power source, permanent damage to the sensor may occur.
- An external protection circuit may be required if the reed switch is used with inductive load, such as relay or solenoid. For DC inductive load, attach an external diode parallel to the load and use R-C circuit parallel with AC inductive load.
- Keep sensors away from stray magnetic field to prevent malfunctions.
- When using reed switch with capacitive load or if the lead wire length exceeds 10-meter, and inductor must be installed in series with the sensor to prevent damage (Sticking effect).

Silverair™ Volume Chambers

Features

Series S (Stainless Steel Volume Chambers)

Volume chambers are used wherever there is the need to accumulate or store a volume of air or vacuum, such as a time delay in a circuit.

- Stainless steel body and aluminum endcaps offer excellent corrosion resistance in adverse environments.
- Available in lengths up to 24 inches, at 1/8-inch increments, providing a capability to meet very specific pneumatic accumulator applications.

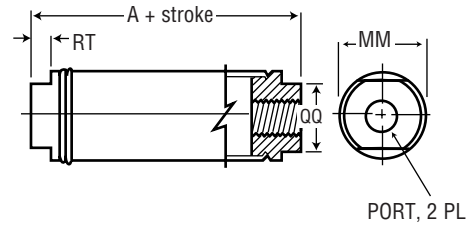

Performance Specifications

Operating Pressures:	0 - 200 PSIG (14 bar)
Temperatures Ranges:	-40° to 160°F, ambient (-40° to 71°C)
Operation:	Compressed air or with vacuum

Volume (ci)	Cylinder Bore (Inches)			
	3/4	1-1/16	1-1/2	2

Add per 1.0 inch of length	.44	.89	1.77	3.14
----------------------------	-----	-----	------	------

Basic Volume (add to total)	.41	.92	1.80	4.44
-----------------------------	-----	-----	------	------

Ordering

Reference	Cylinder Bore (Inches)			
	3/4	1-1/16	1-1/2	2
A	1.91	2.18	2.26	2.81
MM	.81	1.11	1.55	2.07
QQ	.62	.88	.88	1.25
RT	.16	.25	.25	.32
PORT	.125	.125	.125	.25

Position		1		2
Example:	11811	X	-	XX X

Position 1 Bore Size	Position 2 Chamber Length (1" Increments, 1" through 4")	
5 - 3/4"	Whole Inches	Fraction Inches
6 - 1-1/16"	00 = 0"	0 = None
7 - 1-1/2"	01 = 1"	1 = 1/8"
8 - 2"	02 = 2"	2 = 1/4"
	03 = 3"	3 = 3/8"
	04 = 4"	4 = 1/2"
	05 = 5"	5 = 5/8"
	06 = 6"	6 = 3/4"
	10 = 10"	7 = 7/8"
	etc.	

• Under 1" stroke, use 00 and fraction designation.
Example: 1/2" stroke = 004

NOTE: Bold selections denote most popular models.

Economair®

Features

Series 23, 24, & 28

Economair round cylinders are medium to heavy-duty units that can be installed anywhere that a repairable cylinder is desired. Prelubed, they're suitable for operation without externally applied lubrication. Unique endcap retention design provides a concentric assembly, resulting in a service life superior to tie rod cylinder construction.

- Cylinder heads are high tensile strength aluminum alloy, retained by a feed ring wire, a simple design that eliminates excess cylinder weight and bulk.
- The barrel I.D. is hard-coated aluminum with a Rockwell C60 hardness. A finish of 16 microinches or better insures low friction and smooth operation.
- Piston rod is ground and polished, hard-chrome plated steel for minimum friction and maximum packing life. Optional 303 stainless steel is excellent for corrosion resistance and washdown applications (303 stainless steel is standard on 1-1/8-inch bore cylinders).
- Adjustable cushions provide excellent control of cylinder deceleration. Full range adjustability (except fixed cushions on 1-1/8-inch bore).
- High grade, self-lubricating bronze rod bearing reduces friction and promotes smooth operation.
- Piston seal selection insures job-matched performance - Buna N O-ring, Low Friction U-cup and self-lubricating packings available.
- Wear compensating rod wiper protects internal seals and parts from dirt, grit and debris.
- NPTF dry seal pipe threads on ports.
- Optional self-lubricating U-cup seals reduce drag and promote extra cylinder life.



Performance Specifications

Bore Sizes:	1-1/8", 1-1/2", 2", 2-1/2", 3" and 4"
Maximum Output Force:	2,513 pounds (4-inch bore)
Air Pressure:	To 200 p.s.i. (14 bar) May be operated hydraulically (200 p.s.i., nonshock).
Operating Temperature Range:	0° to 180° F (-18° to 82° C).
Seals:	Viton seals available for high heat applications. Consult factory.
Notes:	Wide range of mounting styles and attachable mounting hardware/ accessories allows cylinders to be applied in nearly any pneumatic application.



Economair®

Ordering Include dashes. Dashes are significant.

Position	1	2		3	4	5		6
Example:	2X	XX	-	X	X	X9	-	XX X

Position 1 Series	Position 2 Bore Size	Position 3 Cylinder Type	Position 4 Packing	Position 5 Options
23 - Noncushioned 24 - Cushioned, Both Ends 28 - Magnetic Piston, Cushioned Both Ends <small>Note: 1-1/8 inch bore not available in Magnetic Piston, Cushioned both ends</small>	18 - 1-1/8" 15 - 1-1/2" 20 - 2" 25 - 2-1/2" 30 - 3" 40 - 4"	1 - Double Acting, Rear Tang 5 - Double Acting, No Rear Tang 2 - Double Acting, Double Rod <small>Not available in Series 28</small>	0 - O-Ring, Nitrile 2 - O-Ring, Low Friction 3 - O-Ring, Viton 4 - Lip, Nitrile (pneumatic) 5 - Lip, Self-Lubricating (low friction) 6 - Lip, Viton <small>Not available in Series 28</small>	09 - Standard Rod 89 - 303 Stainless Steel Rod <small>Standard on 1-1/8" bore cylinder.</small>

Not available in Series 28

These packings add one inch to cylinder

Position 6 Stroke Length	
Whole Inches	Fraction Inches
00 = 0"	0 = None
01 = 1"	1 = 1/8"
02 = 2"	2 = 1/4"
03 = 3"	3 = 3/8"
04 = 4"	4 = 1/2"
05 = 5"	5 = 5/8"
06 = 6"	6 = 3/4"
10 = 10"	7 = 7/8"
- to -	
99 = 99"	
etc.	

NOTE: Bold selections denote most popular models.

Mounts

	Cylinder Bore (Inches)					
	1-1/8	1-1/2	2	2-1/2	3	4
L-Mount (2 qty.)	20533	20534	20534	20535	20535	20536
Flange Mount	20537	20538	20538	20539	20539	20540
Clevis Bracket	20546	20547	20547	20548	20548	20549
Mounting Nut (2 qty.)	-	20530	20530	20531	20531	20532
Trunnion	-	-	20557	20558	-	-
Aluminum Rod Clevis	-	20542	20543	20544	20544	20545
Steel Rod Clevis	20541	115906	115907	115908	115908	115909

(1" Increments, 1" through 10" plus 1 1/2", 2 1/2" and 3 1/2")

Note: Order cylinder, rod clevis and clevis bracket separately. Every Economair Cylinder includes rod nut. Trunnion Mount does not include pillow block.

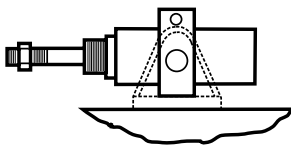

Trunnion

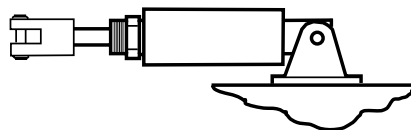

Rod Clevis & Clevis Bracket



Mounting Nut

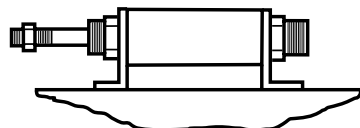

L-Mount

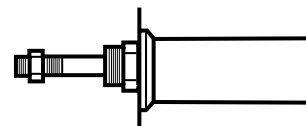

Flange Mount

Dimensional Data

Series 23, 24, & 28

Reference	Cylinder Bore (Inches)					
	1-1/8	1-1/2	2	2-1/2	3	4
Rod dia.	0.38	0.50	0.63	0.75	0.75	1.00
A	1.625	3.00	3.00	4.00	4.00	5.00
B	1.281	1.50	1.50	2.00	2.00	2.625
C	1.00	1.688	1.688	2.25	2.25	3.00
D-dia*	.250	.250	.250	.375	.375	.438
E	.250	.313	.313	.375	.375	.438
F	.625	.906	.906	1.219	1.219	1.469
G	.375	.500	.500	.625	.625	.750
H	1.00	1.531	1.531	2.094	2.094	2.531
J	.750	1.00	1.00	1.25	1.25	1.188
K	.375	.469	.469	.781	.781	.781
L-HEX	1.0625	1.438	1.438	2.0625	2.0625	2.50
M-dia.	1.25	1.75	1.75	2.438	2.438	2.938
N	2.00	2.50	2.50	3.375	3.375	4.00
P	2.50	3.25	3.25	4.50	4.50	5.188
Q	.688	.594	.594	.719	.719	.844
R	1.219	1.750	1.750	2.375	2.375	3.00
S	.313	.313	.313	.375	.375	.438
T	2.250	3.00	3.00	4.00	4.00	5.00
U	1.75	2.25	2.25	3.00	3.00	3.75
V	1.75	2.25	2.25	2.688	2.688	3.375
W	1.406	1.75	1.75	2.0625	2.0625	2.625
X	.750	1.00	1.00	1.25	1.25	1.50
Y-dia.*	.250	.3125	.3125	.438	.4375	.625
Z	.656	.688	.688	.875	.875	1.063
ZZ	.3125	.375	.375	.500	.500	.625
TA	-	-	4.125	5.375	-	-
TB	-	-	3.00	3.75	-	-
TC-dia.	-	-	.500	.750	-	-
TD	-	-	3.125	4.00	-	-
TE	-	-	1.375	1.875	-	-
TF	-	-	1.250	1.50	-	-
TG-dia.*	.250	.3125	.3125	.4375	.4375	.500
TH-Thd.	3/8-16	1/2-13	5/8-11	3/4-10	3/4-10	1-8
TK	-	2.0625	2.0625	2.50	2.50	3.25
TL	-	.875	.875	1.00	1.00	1.325
TM	-	1.0625	1.0625	1.438	1.438	1.938
TN	-	1.813	1.00	1.813	1.813	1.50

*Bolt or pin diameter

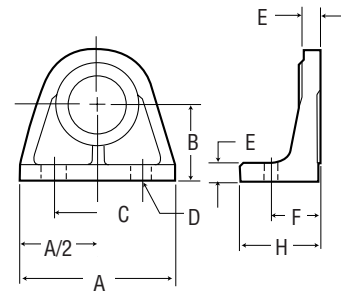

L-Type

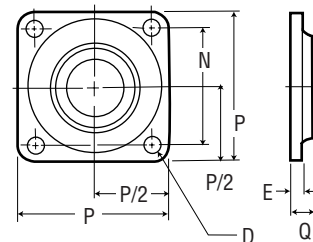

Flange

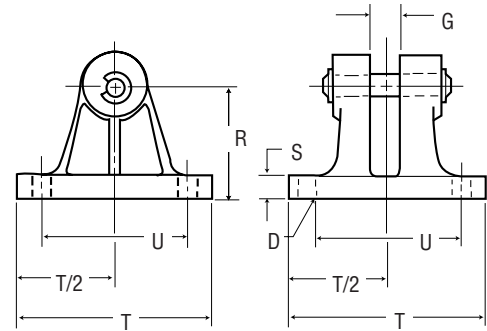

Clevis Bracket

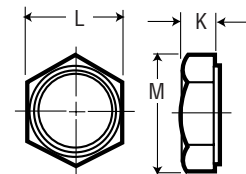

Mounting Nut

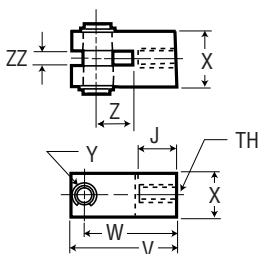

Steel Rod Clevis

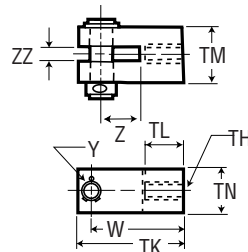

Aluminum Rod

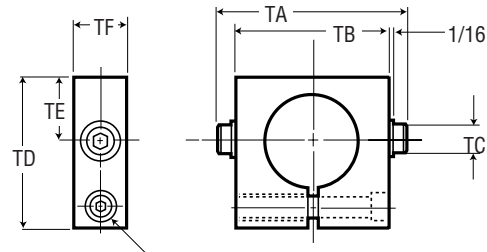

Trunnion

Economair®

Dimensional Data

Series 23, 24, & 28

(Double Acting with Tang)

AA = Double acting with O-ring or low friction packing.
LP = Double acting with U cup packing.

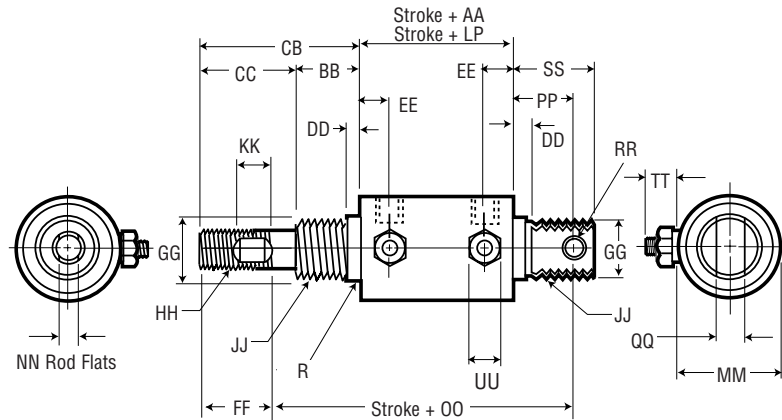

(Double Acting, No Tang)

AA = Double acting with O-ring or low friction packing.
LP = Double acting with U cup packing.

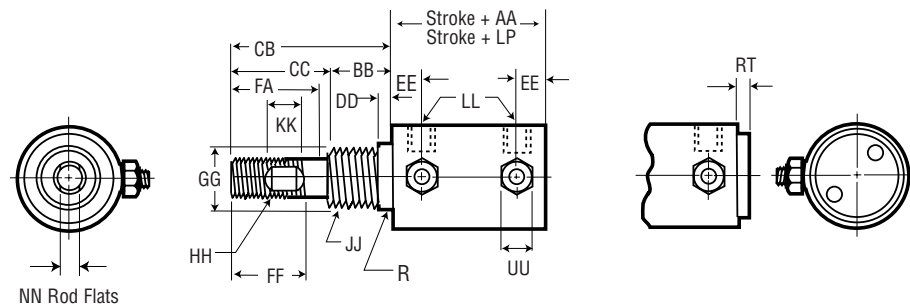

(Double Acting, Double Ended)

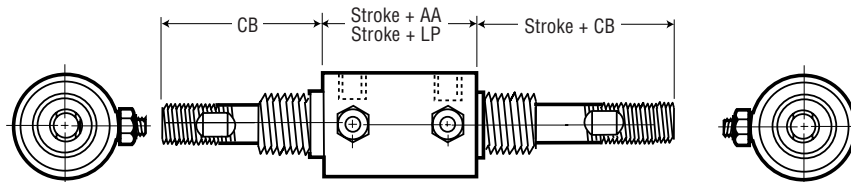

Dimensional Reference	Cylinder Bore (Inches)					
	1-1/8	1-1/2	2	2-1/2	3	4
Rod Diameter	.38	.50	.63	.75	.75	1.00
Stroke Factor	AA*	2.031	2.625	2.625	2.875	4.00
Stroke Factor	LP**	3.031	3.625	3.625	3.875	5.00
BB	.750	1.00	1.00	1.250	1.250	1.250
CB	1.750	2.438	2.438	2.938	2.938	3.500
CC	1.00	1.438	1.438	1.688	1.688	2.250
DD	.125	.219	.219	.344	.344	.406
EE	.422	.516	.516	.563	.563	.813
FA	.781	1.156	1.156	1.375	1.375	1.750
FF▲	.875	1.250	1.250	1.50	1.50	1.875
(± .002) GG	.748	1.057	1.057	1.432	1.432	1.777
(UNC-2A) HH	3/8-16	1/2-13	5/8-11	3/4-10	3/4-10	1-8
JJ	3/4-16	1-1/16-18	1-1/16-18	1-3/8-12	1-3/8-12	1-3/4-12
	UNF-2A	UNEF-2A	UNEF-2A	UNF-2A	UNF-2A	UN-2A
KK	.313	.500	.500	.500	.500	.500
(NPTF) LL	1/8-27	1/4-18	1/4-18	3/8-18	3/8-18	1/2-14
MM	1.375	1.750	2.250	2.750	3.250	4.250
NN	.313	.406	.500	.625	.625	.875
OO	4.594	5.688	5.688	6.688	6.688	8.063
PP	.688	.875	.875	1.375	1.375	1.438
QQ	.375	.500	.500	.625	.625	.750
(RAD.) R	.016	.016	.016	.094	.094	.094
RR	.250	.313	.313	.438	.438	.500
RT	-	.172	-	.438	.438	.438
SS	.969	1.25	1.25	2.00	2.00	2.188
TT	-	.438	.438	.438	.438	.438
UU	-	.500	.500	.500	.625	.625

*Double acting with O-ring or low friction packing **Double acting with U-cup packing ▲ FF shows total thread, including run out.

Switches (Specifications / Ordering)

Switch

Model Number	119581-1	119581-2	119581-3	119582-1	119582-2	119582-3	119583-1	119583-2	119583-3
Lead Length/Type	1m bare	3m bare	Plug	1m bare	3m bare	Plug	1m bare	3m bare	Plug
Lead Color	Black			Grey			Black		
Switch Type	REED			PNP(SOURCING)			NPN (SINKING)		
Input Voltage	100 VDC, 125 VAC Max.			10 - 30 VDC			5 - 30 VDC		
	-			-			5 - 100mA @ 5V		
Operating Current	300mA (150mA Inductive)			7 - 100mA @ 12V			10 - 200mA @ 12V		
	-			14 - 200mA @ 24V			20 - 200mA @ 24V		
Detecting Distance	2.5 mm			1.5 mm			1.5 mm		
Detecting Width	-			3.0 mm			3.0 mm		
Response Time	1 mSec. Min.			-			-		
LED Function	18mA Min.			1mA Min.			1mA Min.		

Switch Mounting Brackets

Bore	Model Number
1-1/8"	119897-18
1-1/2"	119897-15
2"	119897-20
2-1/2"	119897-25
3"	119897-30
4"	119897-40



Note: Order bracket and switch separately.

Technical Information:

1. Do not exceed specification, permanent damage to the sensor may occur.
2. For reed switch type sensors, polarity must be observed for the proper functioning of LED. Connect the brown wire in series with load positive (+) and the blue wire to negative (-) or power source space. If the polarity is reversed, reed switch remains functional but LED will remain in "OFF" state.
3. For solid-state type sensors, polarity must also be observed. Connect brown wire to the positive (+) and the blue to the negative (-) of DC power source. The black wire must connect to the load ONLY. If the black wire is accidentally connected to the power source, permanent damage to the sensor may occur.
4. An external protection circuit may be required if the reed switch is used with inductive load, such as relay or solenoid. For DC inductive load, attach an external diode parallel to the load and use R -C circuit parallel with AC inductive load.
5. Keep sensors away from stray magnetic field to prevent malfunctions.
6. When using reed switch with capacitive load or if the lead wire length exceeds 10-meter, and inductor must be installed in series with the sensor to prevent damage (Sticking effect).

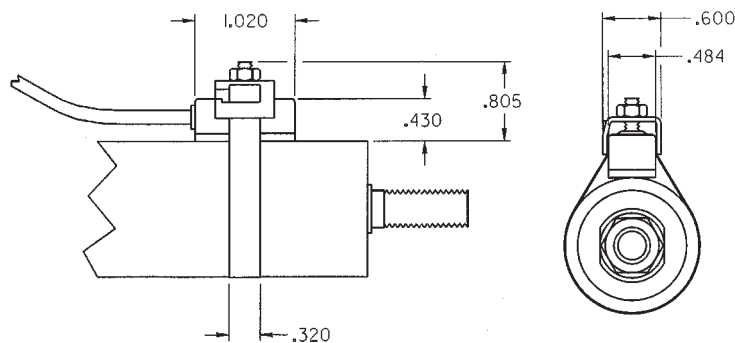

Rod Alignment Cylinders

Features

- Slide applications no longer require costly precision cylinder machining for mounting fixed or rigid guide.
- Friction due to misalignment is eliminated, increasing cylinder efficiency.
- An angular error of 2° and 1/16 inch lateral misalignment on push and pull stroke is compensated.
- Cylinder and component wear is reduced, providing increased reliability.
- Field alignment problems are rectified.
- All components are heat treated for improved corrosion resistance, wear resistance, and fatigue properties.

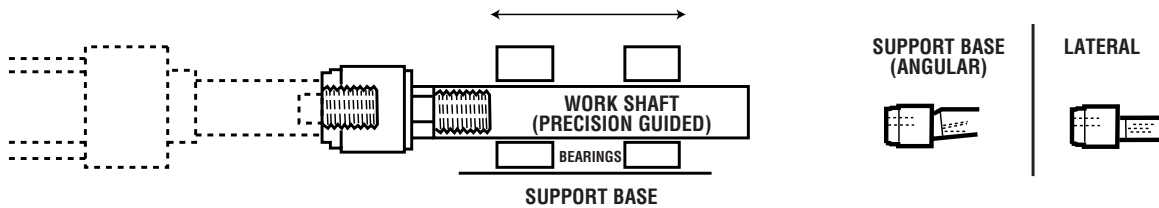

Ordering

Coupler Number	Dimensions								Max. Pull At Yields (Pounds)
	A	B	C	D	E	F	G	H	
118684	7/16-20	1.25	2.00	.50	.75	.625	.50	1.00	10,000
118685	1/2-20	1.25	2.00	.50	.75	.625	.50	1.00	14,000
118686	1/2-13	1.25	2.00	.50	.75	.625	.50	1.00	14,000
118687	5/8-18	1.25	2.00	.50	.75	.625	.50	1.00	19,000
118688	3/4-16	1.75	2.31	.50	1.125	.97	.813	1.50	34,000
118689	3/4-10	1.75	2.31	.50	1.125	.97	.813	1.50	34,000
118690	7/8-14	1.75	2.31	.50	1.125	.97	.813	1.50	39,000
118691	1-14	2.50	2.94	.50	1.625	1.375	1.16	2.25	64,000
118692	1-8	2.50	2.94	.50	1.625	1.375	1.16	2.25	64,000
118693	1-1/4-12	2.50	2.94	.50	1.625	1.375	1.16	2.25	78,000
118694	1-3/8-12	2.50	2.94	.50	1.625	1.375	1.16	2.25	78,000
118695	1-1/2-12	3.25	4.375	.812	2.25	1.375	1.50	3.00	134,000

Dimensional Data

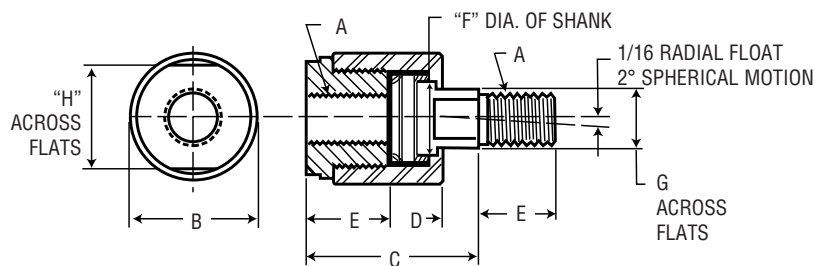

Provenair®

Provenair®...The Most Flexible Cylinder for New or Retrofit

Your best creations are only as good as their parts. Ensure performance to your customer's expectations by including ARO® Provenair Cylinders in your original specifications. They are precision built using the latest extrusion technologies and feature a profiled barrel that is not only good looking, but eliminates cumbersome and dirt-catching tie rods. At the same time, the profiled barrel provides superior strength compared to traditional tie rod constructed cylinders. Provenair end caps, mounts, and rod end accessories - even our position sensor brackets, are protected against corrosion. To maximize cycle life, every Provenair has a factory-installed PTFE coated wearband on the piston. A "Floating" rod bushing provides smooth strokes and maximized wear; reduced galling compared to bronze bushings. Maintenance and repair of ARO® Provenair Cylinders is very simple and fast. The rod bushing is retained by a stainless steel spiro retaining ring and is easily removed with a small screwdriver. The retaining ring slides off the rod along with the bushing and its captive seals. There are no small screws to lose on the floor or under your machine, and no seals to fall inside the cylinder. Replacement of the reciprocating assembly and its seals is equally simple and, unlike tie rod cylinders, you needn't worry about equalizing torque on the Provenair tie bolts!

Provenair is flexible, you can change it to fit most of your application requirements. Factory installed mounts save you time, but you may easily change your Provenair Cylinder mount



with an ARO® mounting kit. If you require an oversized rod diameter, Provenair converts easily - right on your machine! Simply specify the piston rod diameter, thread style, and material (chrome steel or stainless steel) when ordering the replacement reciprocating assembly; order a rod bushing for the new piston rod diameter and you're ready to install. Your original Provenair now needs a magnetic piston? Order a magnet and easily install it and you can select from three types of attachable position sensors.

- Tie bolt construction eliminates rod binding and tie rod torque problems. (Series AN up to 4" bore)
- Series SN all stainless steel cylinders are corrosion resistant and have tie rods.
- Rugged thick walled tubes resist denting.
- NFPA repairable and interchangeable.
- 15 NFPA mounting styles.
- Factory lubricated grease that won't wash out.
- Optional oversized rods available to provide extra column strength. (Series AN and SN)
- Operates on air pressure up to 250 p.s.i.
- Output forces up to 19,635 lbs. (10" bore at 250 p.s.i.).
- Std. operating temp: 0° to 185°(F), -18° to 82° (C).
- Rotated ports are optional.
- Viton seals for high heat applications (up to 300° F, 149° C)

Provenair®

Performance Specifications

Aluminum NFPA Interchangeable

Bore sizes:	1-1/2", 2", 2-1/2", 3-1/4", 4", 5", 6", 8" and 10"
Seals:	Buna-N, Viton or Slippery (Aluminum alloy piston with lip-type seals)
Barrel:	Profiled Extrusion (5", 6", 8" and 10" have tie rods.) (Patented)
Bushings:	"Floating" Rod bushings for low friction, superior wear and side load resistance
Switches:	Metal Jacketed
Piston Rods:	Chrome plated ground and polished high tensile steel
Options:	Optional Piston Magnet Double Rod End 303 S.S. Piston Rods Studded male rods for 50% stronger threads than cold rolled thread rod ends

Stainless Steel NFPA Interchangeable

Bore sizes:	1-1/2", 2", 2-1/2", 3-1/4", 4", 5", 6", and 8"
Rod Bushing:	Bronze
Rod Wiper:	PTFE coated
External Components:	303/304 – End caps, tie rods, piston rods, mounts (barrel is 316)
Mounting Styles:	15 NFPA
Options:	Optional adjustable cushions Piston Magnet Viton Seals (Wiper PTFE coated) Double rod ends



Aluminum NFPA

Ordering Include dashes. Dashes are significant.

Series AN (1-1/2' thru 10" Bore)

Position	1	2	3	4	5		6	7	8	9	10		11
Example:	A	N	X	X	X	-	X	X	X	X	X	-	XXX

Position 1 Actuators	Position 2 Series (NFPA)	Position 3 Type	Position 4 Bore Size	Position 5 Rod Diameter
A - Aluminum actuators	N - All Provenair Cylinders	A - Double Acting, Single Rod B - Double Acting, Double Rod	Q - 1- 1/2" S - 2" T - 2- 1/2" W - 3-1/4" 4 - 4" 5 - 5" 6 - 6" 8 - 8" Y - 10" <small>Note: 5", 6", 8" & 10" bores have tie rods</small>	K - 5/8" Note: Available in 1-1/2", 2" and 2-1/2" bores only. M - 1" Note: Available in 2", 2-1/2", 3-1/4", 4" and 5" bores only. P - 1 3/8" Note: Available in 3-1/4", 4", 5", 6" and 8" bores only. Q - 1 3/4" Note: Available in 6", 8" and 10" bores only. S - 2" Note: Available in 10" bores only.

Position 6 Rod Style	Position 7 Seals	Position 8 Cushions	Position 9 Port Location
A - Chrome, Std Male (KK₁) B - Chrome, Intermed. Male(KK ₂) C - Chrome, Full Male (CC) D - Chrome, Female (KK ₁) F - Chrome, No Threads G - S.S., Standard Male (KK ₁) H - S.S., Intermediate Male (KK ₂) J - S.S., Full Male (CC)	K - S.S., Female (KK ₁) L - S.S., No Threads 1 - KK ₁ Chrome, Studded 2 - KK ₂ Chrome, Studded 3 - CC Chrome, Studded 4 - KK ₁ SS, Studded 5 - KK ₂ SS, Studded 6 - CC SS, Studded	B - Buna-N V - Viton S - Slippery G - Buna-N + Magnetic Piston H - Viton + Magnetic Piston J - Slippery + Magnetic Piston	X - No Cushions B - Cushion Both Ends H - Cushion Head End (Rod End) C - Cushion Cap End A - H1, C1 (Std.) B - H1, C2 C - H1, C3 D - H1, C4 F - H2, C1 G - H2, C2 H - H2, C3 J - H2, C4 <small>(MS4 mounts: Port locations other than "A", call factory. Trunnion mounts: ports "A" or "C" only.)</small>

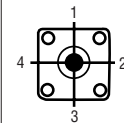

Position 10 Mount	Position 11 Stroke Length
A MS1 (8" and 10" Bore ME3, ME4) B MS4** (Mounts must be factory installed on 5", 6", 8" and 10" Bore) C MP1** D MP2** F MF1/ME3** H MF2/ME4** K MP4* L MS7*	Q MX1 T MX2 U MX3 4 FMB/MS4* All mounts available through 8" Bore except: * 1 1/2" - 4" Bore Only ** Available 1 1/2" - 10" Bore

Whole Inches	Fraction Inches
00 = 0"	0 = None
01 = 1"	1 = 1/8"
02 = 2"	2 = 1/4"
03 = 3"	3 = 3/8"
04 = 4"	4 = 1/2"
05 = 5"	5 = 5/8"
06 = 6"	6 = 3/4"
- to -	7 = 7/8"
99 = 99"	
etc.	Maximum stroke 99 7/8", for longer strokes consult factory. Stroke lengths 20" and longer may require stop tubes, see page 7.

NOTE: Bold selections denote most popular models.

Stainless Steel NFPA

Ordering Include dashes. Dashes are significant.

Series AN (1-1/2' thru 10" Bore) All SN Series Cylinders have tie rods.

Position	1	2	3	4	5		6	7	8	9	10		11
Example:	S	N	X	X	X	-	X	X	X	X	X	-	XXX

Position 1 Actuators	Position 2 Series (NFPA)	Position 3 Type	Position 4 Bore Size	Position 5 Rod Diameter
S - Stainless Steel	N - All Provenair Cylinders	A - Double Acting, Single Rod B - Double Acting, Double Rod <small>Not available in 8" bore.</small>	Q - 1- 1/2" S - 2" T - 2- 1/2" W - 3-1/4" 4 - 4" 5 - 5" 6 - 6" 8 - 8"	K - 5/8" Available in 1-1/2", 2" & 2-1/2" bores only. M - 1" Available in 2", 2-1/2", 3-1/4", 4" & 5" bores only. P - 1 3/8" Available in 3-1/4", 4", 5", 6" & 8" bores only. Q - 1 3/4" Available in 6" & 8" bores only.

Position 6 Rod Style	Position 7 Seals	Position 8 Cushions	Position 9 Port Location
G - S.S., Standard Male (KK ₁) H - S.S., Intermediate Male (KK ₂) J - S.S., Full Male (CC) K - S.S., Female (KK ₁) L - S.S., No Threads	B - Buna-N V - Viton S - Slippery G - Buna-N + Magnetic Piston <small>Note: PTFE Wiper standard</small> H - Viton + Magnetic Piston J - Slippery + Magnetic Piston	X - No Cushions B - Cushion Both Ends H - Cushion Head End (Rod End) C - Cushion Cap End	A - H1, C1 (Std.) B - H1, C2 C - H1, C3 D - H1, C4 F - H2, C1 G - H2, C2 H - H2, C3 J - H2, C4 <small>(MS4 mounts: Port locations other than "A", call factory. Trunnion mounts: ports "A" or "C" only.)</small>

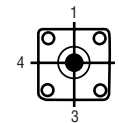

Determine port location looking at rod end of cylinder.

Position 10 Mount	Position 11 Stroke Length																						
B MS4** (8" Bore ME3, ME4) C MP1** (Mounts must be factory installed) F MF1/ME3** H MF2/ME4** K MP4* * 1 1/2" - 6" Bore Only Q MX1 ** Available 1 1/2" - 4" Bore Only T MX2 U MX3 X No Mount	<table border="0"> <tr> <td>Whole Inches</td> <td>Fraction Inches</td> </tr> <tr> <td>00 = 0"</td> <td>0 = None</td> </tr> <tr> <td>01 = 1"</td> <td>1 = 1/8"</td> </tr> <tr> <td>02 = 2"</td> <td>2 = 1/4"</td> </tr> <tr> <td>03 = 3"</td> <td>3 = 3/8"</td> </tr> <tr> <td>04 = 4"</td> <td>4 = 1/2"</td> </tr> <tr> <td>05 = 5"</td> <td>5 = 5/8"</td> </tr> <tr> <td>06 = 6"</td> <td>6 = 3/4"</td> </tr> <tr> <td>- to -</td> <td>7 = 7/8"</td> </tr> <tr> <td>99 = 99"</td> <td></td> </tr> <tr> <td>etc.</td> <td></td> </tr> </table> <p>Maximum stroke 99 7/8", for longer strokes consult factory. Stroke lengths 20" and longer may require stop tubes, see page 7.</p>	Whole Inches	Fraction Inches	00 = 0"	0 = None	01 = 1"	1 = 1/8"	02 = 2"	2 = 1/4"	03 = 3"	3 = 3/8"	04 = 4"	4 = 1/2"	05 = 5"	5 = 5/8"	06 = 6"	6 = 3/4"	- to -	7 = 7/8"	99 = 99"		etc.	
Whole Inches	Fraction Inches																						
00 = 0"	0 = None																						
01 = 1"	1 = 1/8"																						
02 = 2"	2 = 1/4"																						
03 = 3"	3 = 3/8"																						
04 = 4"	4 = 1/2"																						
05 = 5"	5 = 5/8"																						
06 = 6"	6 = 3/4"																						
- to -	7 = 7/8"																						
99 = 99"																							
etc.																							

NOTE: Bold selections denote most popular models.

Attachable Mounting Kits for Series AN

Series AN (1-1/2" Thru 4" Bore)

	1 1/2"	2"	2 1/2"	3 1/4"	4"
MS7 Side End Lugs (Steel)	115277	115278	115279		115281
MP2 HD Clevis (Iron) *	118696	118697	118698	118699	118700
MP4 HD Eye (Iron)	118701	118702	118703	118704	118705
MF1, MF2 Flange (Steel)	115282	115283	115284	115285	115286
MP1 Fixed Clevis (Alum.) *	115477	115478		115480	115481
MP2 Det. Clevis (Alum.) *	115287	115288	115289	115290	115291
MP4 HD Eye (Alum.) *	115292	115293	115294	115295	115296

Above kits include all necessary hardware to complete mounting to Provenair cylinders. AN Series only.
 *Pivot pin included in kit. (Kits not available for 5", 6", 8", or 10" Bores) (Kits not available for SN Models)



MX1, 2 or 3 Tie Rod Extensions

MX1 requires two tie rod extension bolt kits (four extension studs per kit).

Factory Installed Mounts

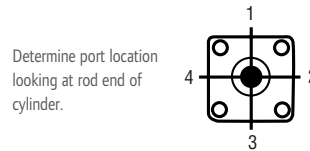
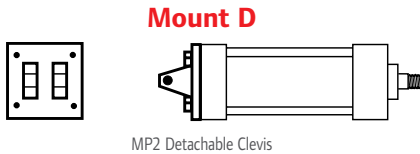
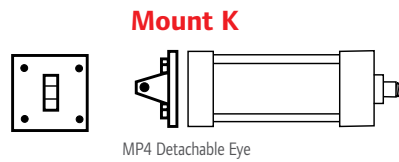
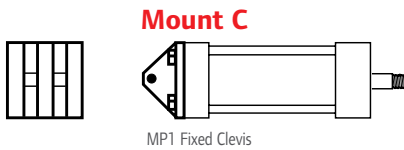

Note: Not all mounts are available on stainless steel models.

Provenair®

Mounting Data

Series AN, SN (1-1/2" Thru 10" Bore)

Factory Installed Mounts

Mount B

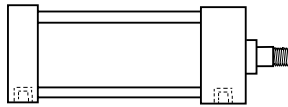

MS4 Side Tapped

Mount A

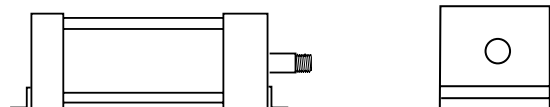

MS1 Side End Angle

Mount H

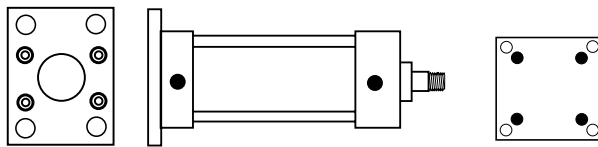

MF2 Cap. Rec. Flange

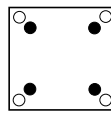

ME4 8" Bore

Mount F

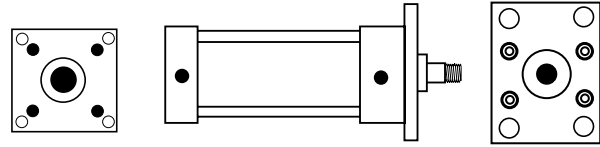

ME3 8" Bore

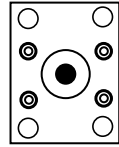

MF1 Head Rec. Flange

Mount Q

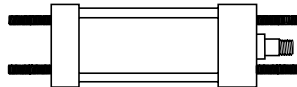

MX1 Cap and Head Ext. Tie Rod

Mount T

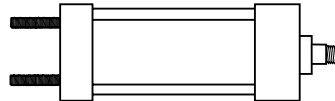

MX2 Cap Ext. Tie Rod

Mount U

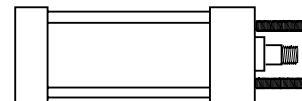

MX3 Head Ext. Tie Rod

Note: Mounts H & F 8" and 10" bore cylinders use oversized end cap as shown (ME3 or ME4).
A steel rectangular flange plate is used for all MF1 or MF2 (1 1/2 thru 6" bore).

Note: Not all mounts are available on stainless steel models (Series SN)

Dimensional Data

Series AN, SN (Rod End)

Rod End Dimensions for 1-1/2" - 10" Bore Sizes

	Cylinder Bore (Inches)							
	1-1/2, 2, 2-1/2	2, 2-1/2	3-1/4, 4	3-1/4, 4	5	5, 6, 8	6, 8, 10	10
Rod Diameter (Inches)	5/8	1	1	1-3/8	1	1-3/8	1-3/4	2
KK1 THD. (M OR F)	7/16"-20	3/4"-16	3/4"-16	1"-14	3/4"-16	1"-14	1-1/4"-12	1-1/2"-12
KK2 THD. (MALE)	1/2"-20	7/8"-14	7/8"-14	1-1/4"-12	7/8"-14	1-1/4"-12	1-1/2"-12	1-3/4"-12
CC (MALE)	5/8"-18	1"-14	1"-14	1-3/8"-12	1"-14	1-3/8"-12	1-3/4"-12	2"-12
A	.75	1.13	1.13	1.63	1.13	1.63	2.00	2.25
B	1.13	1.50	1.50	1.50	1.50	2.00	2.38	2.38
C	.34	.62	.48	.60	.50	.63	.75	.88
D	.50	.88	.88	.81	.81	1.13	1.50	1.75
F	.325	.325	.625	.625	.625	.625	.625	.75
MM	.625	1.00	1.00	1.00	1.00	1.375	1.75	2.00
V	.66	.75	.89	1.02	.25	.38	.38 *	.38
	-	-	-	-	-	-	*(.50 on 10")	

Selection of oversize piston rod affects the following dimensions: ZB, ZC, ZD, ZE, ZF, ZL, ZM, XC, XD, XE, XG, XJ, XS, XT, V, W, WF, C, V, LA. See rod end dimensions.

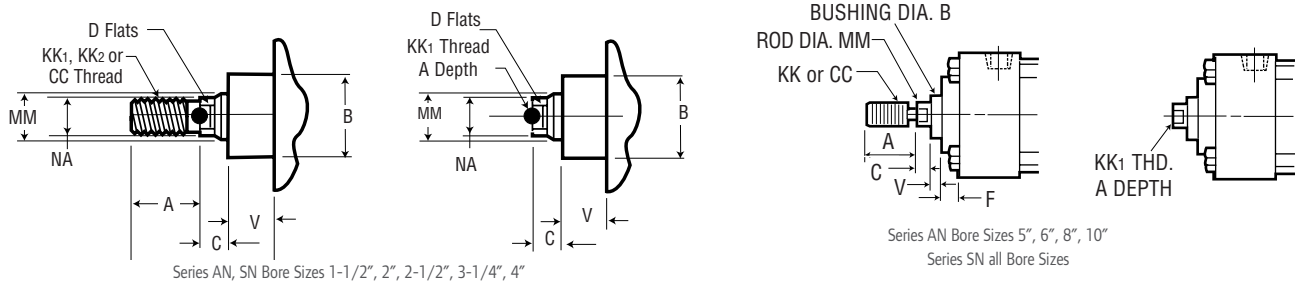

Series AN, SN (With Standard Rod)

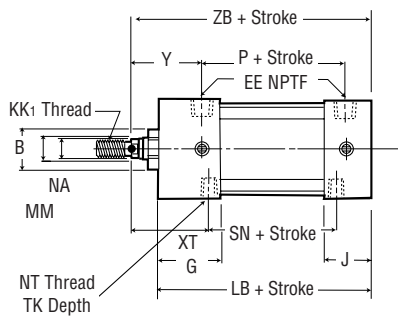

Double Rod End MS4 MOUNT B

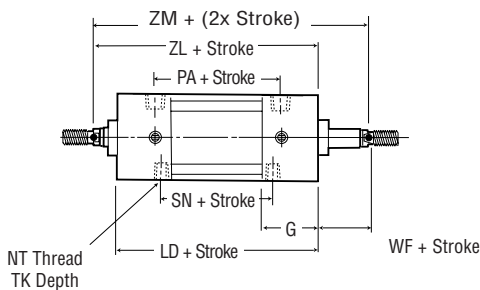

Rect. Flange - Head-MF1, Cap-MF2 MOUNT F & H (1 1/2\" - 4\" BORE ONLY)

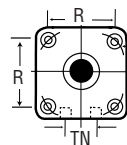
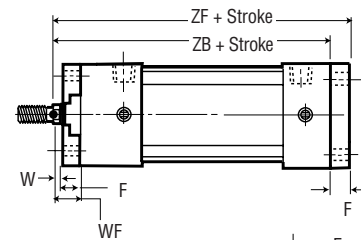
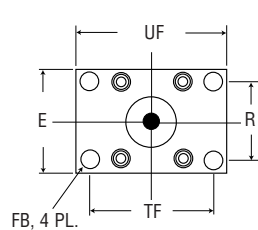

Side Tapped MS4 MOUNT B

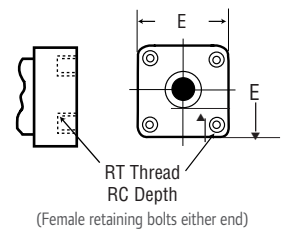

Head Trunnion MT1 Cap Trunnion MT2 MOUNT M & P

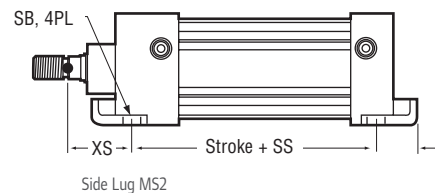
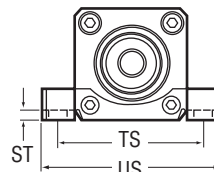

Provenair®

Dimensional Data

Series AN, SN (1-1/2" Thru 4" Bore w/standard rod)

	Cylinder Bore (Inches)				
	1-1/2	2	2-1/2	3-1/4	4
B	1.13	1.13	1.13	1.50	1.50
BC	2.02	2.60	3.10	3.90	4.70
E	2.00	2.50	3.00	3.75	4.50
EE	3/8-18	3/8-18	3/8-18	1/2-14	1/2-14
F	.38	.38	.38	.63	.63
FB	.31	.38	.38	.44	.44
G	1.44	1.44	1.44	1.69	1.69
J	.94	.94	.94	1.19	1.19
KK1 (thread)	7/16-20	7/16-20	7/16-20	3/4-16	3/4-16
LB	3.62	3.62	3.75	4.25	4.25
LD	4.12	4.12	4.25	4.75	4.75
MM (rod dia.)	5/8	5/8	5/8	1.00	1.00
NA	.59	.59	.59	.97	.97
NT	1/4-20	5/16-18	3/8-16	1/2-13	1/2-13
P	2.25	2.25	2.38	2.62	2.62
PA	2.75	2.75	2.88	3.12	3.12
R	1.43	1.84	2.19	2.76	3.32
RC	.41	.538	.41	.599	.44
RT	1/4-28	5/16-24	5/16-24	3/8-24	3/8-24
SB	.38	.38	.38	.50	.50
SN	2.25	2.25	2.38	2.63	2.63
SS	2.88	2.88	3.00	3.25	3.25
ST	.56	.69	.81	1.00	1.19
SX	.34	.34	.34	.47	.47
SY1	1.34	1.53	1.53	2.13	2.19
SY2	.94	1.13	1.13	1.50	1.56
TF	2.75	3.38	3.88	4.69	5.44
TK	.38	.43	.69	.75	.75
TN	.63	.88	1.25	1.50	2.06
TS	2.75	3.25	3.75	4.75	5.50
UF	3.38	4.13	4.63	5.50	6.25
US	3.50	3.69	4.50	5.75	6.50
UT	4.00	4.50	5.00	5.75	6.50
W	.66	.66	.66	.75	.75
WF*	1.00	1.00	1.00	1.38	1.38
XG*	1.75	1.75	1.75	2.25	2.25
XJ*	4.12	4.12	4.25	5.00	5.00
XS*	1.38	1.38	1.38	1.88	1.88
XT*	1.94	1.94	1.94	2.44	2.44
Y*	1.94	1.94	1.94	2.44	2.44
ZB*	4.63	4.63	4.75	5.63	5.63
ZF*	5.00	5.00	5.12	6.25	6.25
ZL*	5.12	5.12	5.25	6.12	6.12
ZM*	6.15	6.15	6.27	7.52	7.52

* Oversize piston rod option affects these dimensions. See rod end dimensions.

Dimensional Data

Series AN, SN (1-1/2" Thru 10" Bore w/standard rod)

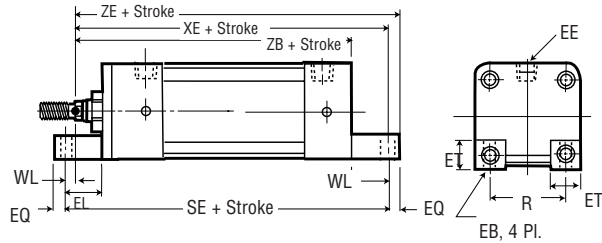

Side End Lugs MS7
MOUNT L

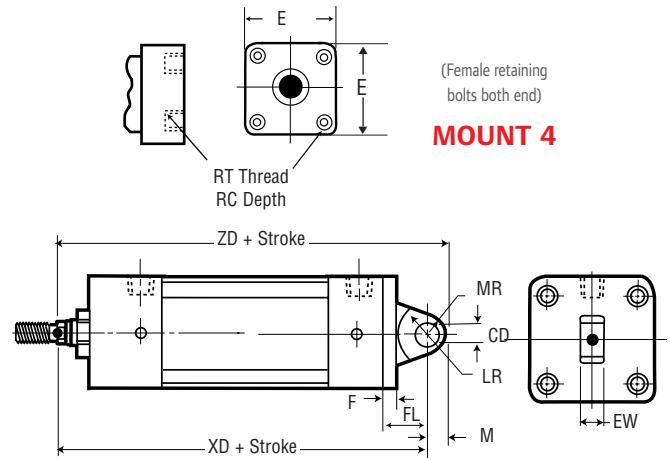

Detachable Eye MP4
MOUNT K

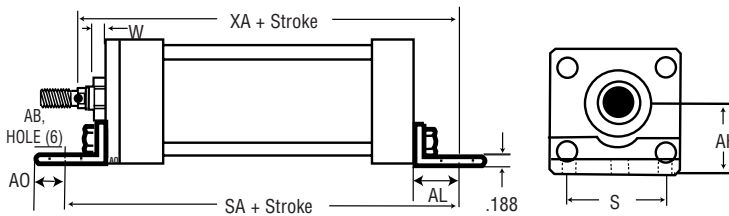

Angle Mount MS1
MOUNT A

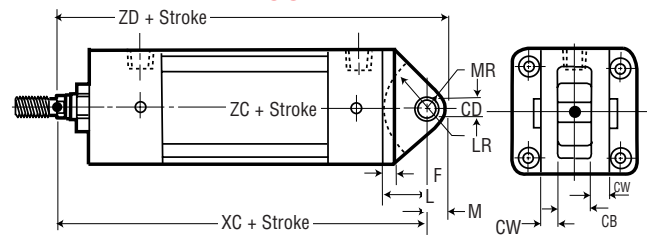

Fixed Clevis MP1
MOUNT C

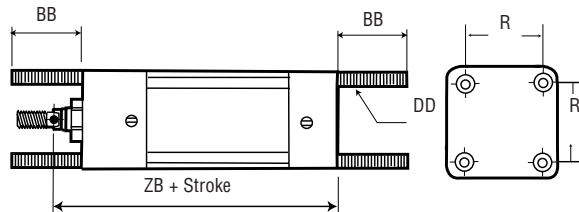

Tie Rod Mounts

MX1 Extended Both Ends MX3 Extended Head End
MOUNT Q, T & U

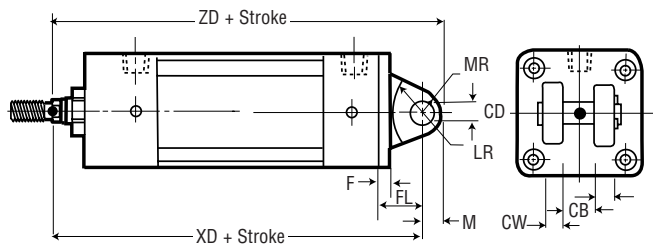

Detachable Clevis MP2
MOUNT D (AN Series only)

Dimensional Data

Series AN (1-1/2" Thru 4" Bore w/standard rod)

	Cylinder Bore (Inches)						Cylinder Bore (Inches)						Cylinder Bore (Inches)				
	1-1/2	2	2-1/2	3-1/4	4		1-1/2	2	2-1/2	3-1/4	4		1-1/2	2	2-1/2	3-1/4	4
AB	.38	.38	.38	.50	.50	EQ	.25	.31	.31	.38	.38	SE	5.50	5.88	6.25	6.63	6.88
AH	1.18	1.44	1.62	1.94	2.25	ET	.56	.69	.81	1.00	1.19	W*	.66	.66	.66	.75	.75
AL	1.00	1.00	1.00	1.25	1.25	EW	.75	.75	.75	1.25	1.25	WL	.14	.33	.45	.13	.25
AO	.38	.38	.38	.50	.50	F	.38	.38	.38	.63	.63	XA	5.62	5.62	5.75	6.88	6.88
BB	1.00	1.13	1.13	1.38	1.38	KK ₁ (Thread)	7/16-207/16-207/16-20	3/4-16	3/4-16			XC*	5.38	5.38	5.50	6.88	6.88
CB	.75	.75	.75	1.25	1.25	FL	1-1/8	1-1/8	1-1/8	1-7/8	1-7/8	XD*	5.75	5.75	5.88	7.50	7.50
CD	.50	.50	.50	.75	.75	L	3/4	3/4	3/4	1-1/4	1-1/4	XE*	5.38	5.56	5.81	6.50	6.63
CW	.50	.50	.50	.63	.63	LR	3/4	3/4	3/4	1-1/4	1-1/4	ZB*	4.63	4.63	4.75	5.63	5.63
DD	1/4-28	5/16-24	5/16-24	3/8-24	3/8-24	M	5/8	5/8	5/8	7/8	7/8	ZC*	5.84	5.88	6.00	7.63	7.63
E	2.00	2.50	3.00	3.75	4.50	MR	.47	.50	.50	.75	.75	ZD*	6.22	6.25	6.38	8.25	8.25
EB	.28	.34	.34	.38	.38	R	1.43	1.84	2.19	2.76	3.32	ZE*	5.63	5.84	6.13	6.88	7.00
EE (NPTF)	3/8-18	3/8-18	3/8-18	1/2-14	1/2-14	S	1.25	1.75	2.25	2.75	3.50						
EL	.75	.94	1.06	.88	1.00	SA	6.00	6.00	6.12	7.38	7.38						

* Oversize piston rod option affects these dimensions.

Provenair®

Dimensional Data

Series AN, SN (5", 6", 8" and 10" Bore)

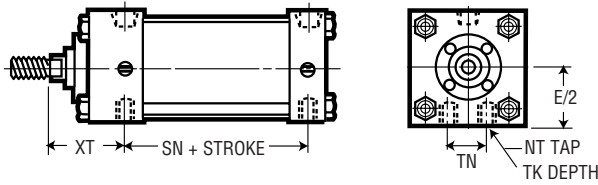

Side Tapped MS4

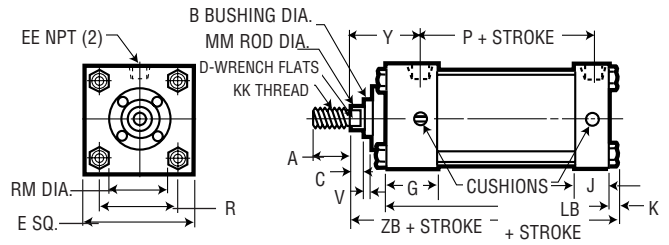

Basic Cylinder Dimensions

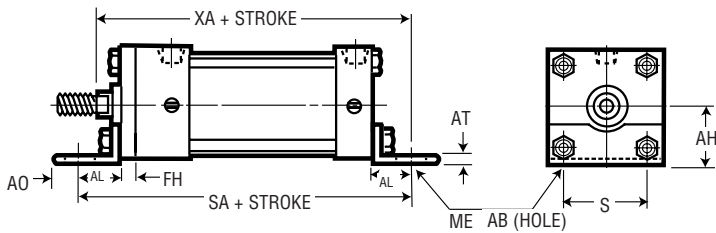

End Angle MS1

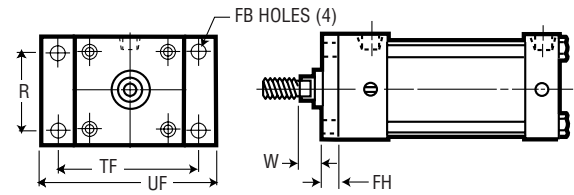

Head Rectangular Flange MF1

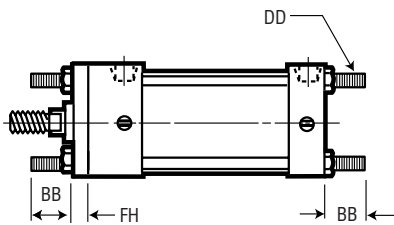

Tie Rods Extended Both Ends MX1

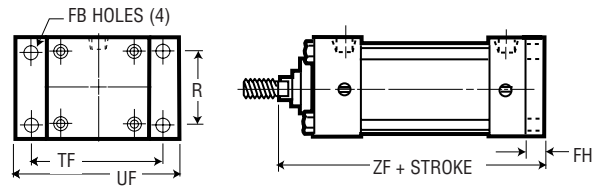

Cap Rectangular Flange MF2

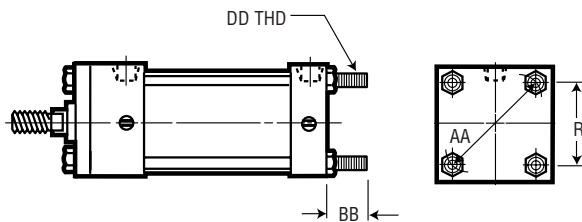

Tie Rods Extended, Cap End MX2

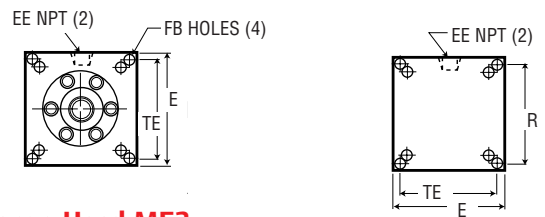

Flange Head ME3

Flange Cap ME4

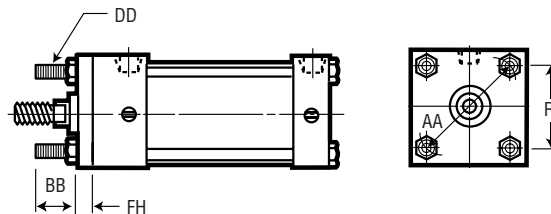

Tie Rods Extended, Head End MX3

Dimensional Data

Provenair Mounts

Series AN, SN (5", 6", 8", & 10" Bore)

ROD	CYLINDER BORE (INCHES)							
	5 1	5 1-3/8	6 1-3/8	6 1-3/4	8 1-3/8	8 1-3/4	10 1-3/4	
A	1.13	1.63	1.63	2.00	1.63	2.00	2.00	
AA	5.18	5.18	6.90	6.90	9.10	9.10	11.20	
AB	.69	.69	.81	.81	.81	.81	-	
AH	2.88	2.88	3.25	3.25	4.25	4.25	-	
AL	1.38	1.38	1.38	1.38	1.81	1.81	-	
AO	.63	.63	.63	.63	.69	.69	-	
AT	.19	.19	.19	.19	.25	.25	-	
B	1.50	2.00	2.00	2.38	2.00	2.38	2.38	
BB	1.81	1.81	1.81	1.81	2.31	2.31	2.69	
C	.50	.63	.63	.75	.63	.75	.75	
CB	1.25	1.25	1.50	1.50	1.50	1.50	2.00	
CD	.75	.75	1.00	1.00	1.00	1.00	1.38	
CW	.63	.63	.75	.75	.75	.75	1.00	
D	.81	1.13	1.13	1.50	1.13	1.50	1.50	
DD	1/2"-20	1/2"-20	1/2"-20	1/2"-20	5/8"-18	5/8"-18	3/4"-16	
E	5.50	5.50	6.50	6.50	8.50	8.50	10.63	
EE (NPTF)	1/2	1/2	3/4	3/4	3/4	3/4	1.00	
F	.63	.63	.63	.75	.63	.75	.63	
FB	.56	.56	.56	.56	.69	.69	.81	
FH	.63	.63	.75	.75	-	-	.63	
FL	2.13	2.13	2.25	2.25	-	-	-	
G	1.75	1.75	2.00	2.00	2.00	2.00	2.25	
J	1.25	1.25	1.50	1.50	1.50	1.50	2.00	
K	.44	.44	.50	.50	.63	.63	.69	
KK ₁ THREAD	3/4-16	1-14	1-14 1/4-12	1-14 1/4-12	1-14 1/4-12	1-1/4-12		
L	1.25	1.25	1.50	1.50	1.50	1.50	2.13	
LB	4.25	4.25	5.00	5.00	5.13	5.13	6.38	
LD	4.75	4.75	5.50	5.50	5.63	5.63	6.63	
M	.88	.88	1.00	1.00	1.00	1.00	1.38	
MM	1	1-3/8	1-3/8	1-3/4	1-3/8	1-3/4	1-3/4	
NT	5/8"-11	5/8"-11	3/4"-10	3/4"-10	3/4"-10	3/4"-10	1-8	
P	2.63	2.63	3.00	3.00	3.13	3.13	4.31	
R	4.10	4.10	4.88	4.88	7.57	7.57	7.92	
RM	2.63	3.38	3.38	3.50	3.38	3.50	3.50	
S	4.25	4.25	5.25	5.25	7.13	7.13	7.13	
SA	7.63	7.63	8.50	8.50	8.75	8.75	-	
SN	2.88	2.88	3.13	3.13	3.25	3.25	4.13	
TD	1.00	1.00	1.38	1.38	1.38	1.38	-	
TE	-	-	-	-	7.57	7.57	9.40	
TF	6.63	6.63	7.63	7.63	7.57*	7.57*	-	
TK	1.00	1.00	1.13	1.13	1.13	1.13	1.50	
TL	1.00	1.00	1.38	1.38	1.38	1.38	-	
TN	2.69	2.69	3.25	3.25	4.50	4.50	5.50	
UF	7.63	7.63	8.63	8.63	-	-	-	
UT	7.50	7.50	9.25	9.25	11.25	11.25	-	
V	.25	.38	.38	.38	.38	.38	.50	
W	.75	1.00	.88	1.13	1.63	1.88	1.88	
XA	7.00	7.25	8.00	8.25	8.56	8.81	-	
XC	6.88	7.13	8.13	8.38	8.25	8.50	10.38	
XD	7.75	8.00	8.88	9.13	-	-	-	
XG	2.25	2.50	2.63	2.88	2.63	2.88	-	
XJ	5.00	5.25	5.88	6.13	6.00	6.25	-	
XT	2.31	2.56	2.81	3.06	2.81	3.06	3.13	
Y	2.44	2.44	2.88	2.88	2.88	2.88	3.00	
ZB	6.06	6.31	7.13	7.38	7.38	7.63	8.94	
ZF	6.50	6.75	7.38	7.63	6.75	7.00	8.25	
ZM	7.75	8.25	8.75	9.25	8.88	9.38	10.63	

* R Dimension on 8" bore.

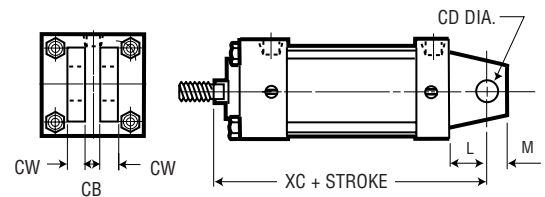

Fixed Clevis MP1

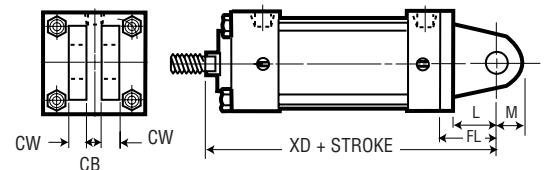

Detachable Clevis MP2

(Not available on 8-inch bore)

Cap Rectangular Flange MF2

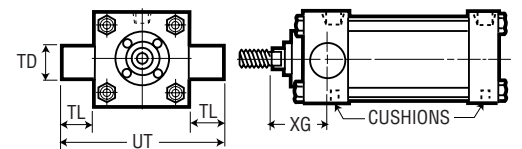

Head Trunnion

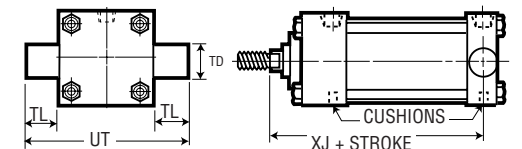

Cap Trunnion MT2

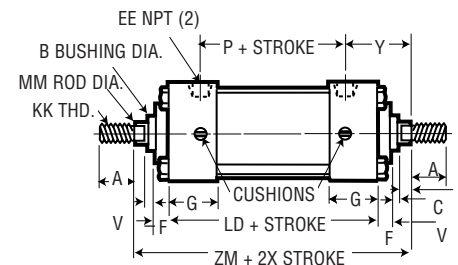

Double Rod End

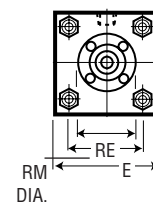

Accessories

Series AN (5/8" thru 1-3/4" Rod)

Socket Head Rod Studs

	ROD DIAMETER (INCHES)			
	5/8	1	1-3/8	1-3/4
	Stud Thread Part Number	Stud Thread Part Number	Stud Thread Part Number	
KK1	7/16"-20 x 3/4"	3/4"-16 x 1-1/8"	1"-14 x 1-1/8"	-
	117812-101	117812-201	117812-301	
KK1 (2 x length)	7/16"-20 x 1-1/2"	3/4"-16 x 2-1/4"	1"-14 x 2-1/4"	-
	117812-121	117812-221	117812-321	
KK2 (1st oversize)	1/2"-20 x 3/4"	7/8"-14 x 1-1/8"	1-1/4"-12 x 1-5/8"	-
	117812-102	117812-202	117812-302	
CC Full (2nd oversize)	5/8"-18 x 3/4"	1"-14 x 1-1/8"	1-3/8"-12 x 1-5/8"	-
	117812-103	117812-203	117812-303	

	Rod Thread			
	7/16-20	3/4-16	1-14	1-1/4-12
ROD CLEVIS KIT (includes pin)	116183	116046	116049	116052
ROD EYE KIT	116184	116047	116050	116053
CLEVIS PIN	115299	115300	-	-
PIVOT PIN	-	-	116048	116051

Mating parts to rod end accessories and mounting brackets

Clevis Bracket (Iron)	-	117206-5	117206-6	-
Eye Bracket (Iron)	-	117205-5	117205-6	-

Dimensional Data

ROD DIAMETER (INCHES)	5/8	1	1-3/8	1-3/4
Rod Eye, Rod Clevis and Pin				
A	.75	1.13	1.63	2.00
CA	1.50	2.06	2.81	3.44
CB	.75	1.25	1.50	2.00
CD	.50	.75	1.00	1.38
CD1	.44	.75	-	-
CE	1.50	2.38	3.13	4.13
CH	1.00	1.25	1.50	2.00
CW	.50	.63	.75	1.00
ER	.72	1.06	1.00	1.38
HP	.156	.156	-	-
KK1	7/16-20	3/4-16	1-14	1 1/4-12
L	.75	1.25	1.50	2.13
LH	2.25	3.13	3.75	5.00
LP	2.10	2.75	3.25	4.50

Mating parts to rod end accessories and mounting brackets

BA	-	2.56	3.25	-
CB	-	1.25	1.50	-
CD	-	.75	1.00	-
CW	-	.63	.75	-
DD DIA.	-	.53	.66	-
DD TAP	-	1/2-20	5/8-18	-
E	-	3.50	4.50	-
F	-	.63	.75	-
FL	-	1.88	2.25	-
M	-	.75	1.00	-

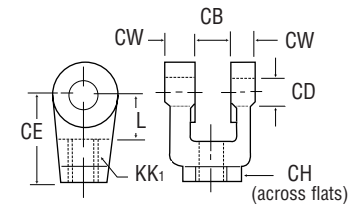

Rod Clevis

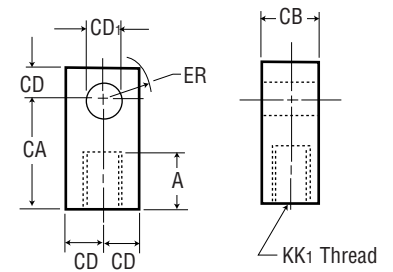

Rod Eye

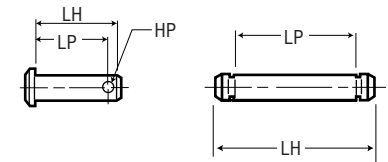

Pivot Pin

Use for Both Pins

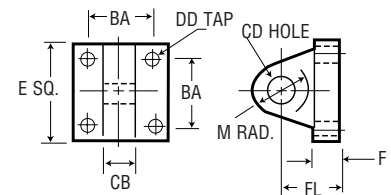

Eye Bracket*

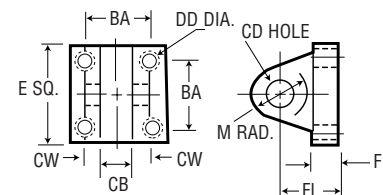

Clevis Bracket*

* These accessory brackets attach to mating cylinder mounts. See Cylinder Mounting Dimensions on page 39.

Tanks & Reservoirs (1-1/2" thru 4" Bore)

Two Provenair tank styles provide unique capabilities for your applications.

Style A air-over-oil tanks provide the smooth control hydraulic systems are known for, without the expense, using shop air.

Style T reservoirs provide a supply of air near the point of use, allowing your system to use a smaller compressor or smaller system supply lines.



Air Reservoir

Ordering Include dashes. Dashes are significant.

Position	1	2	3	4	5	6	7	8	9	10	11	
Example:	A	N	T	X	X	-	X	X	X	X	-	XX X

Position 1 Actuators	Position 2 Series (NFPA)	Position 3 Type	Position 4 Bore Size	Position 5	Position 6 Tank Style	Position 7 Seals	Position 8 Sight Glass Location
All actuators begin with A	N - All Provenair Cylinders	T - TANK	Q - 1- 1/2" S - 2" T - 2- 1/2" W - 3-1/4" 4 - 4"	Enter X in this position	A - Air / Oil T - Air Reservoir	B - Buna-N V - Viton	X - None* A - 1 B - 2 C - 4 <small>*X must be used with Tank Style T</small>

Position 9 Port Location	Position 10 Mount	Position 11 Stroke	
A - H1, C1 (Std.) B - H1, C2 D - H1, C4 F - H2, C1 G - H2, C2 J - H2, C4 U - H4, C4 <small>MS4 mounts: Port locations other than "A", call factory.</small>	A - MS1 B - MS4 L - MS7 X - No Mount	Whole Inches	Fraction Inches
		00 = 0"	0 = None
		01 = 1"	1 = 1/8"
		02 = 2"	2 = 1/4"
		03 = 3"	3 = 3/8"
		04 = 4"	4 = 1/2"
		05 = 5"	5 = 5/8"
		06 = 6"	6 = 3/4"
		- to -	7 = 7/8"
		99 = 99"	<small>Maximum stroke 99 7/8", for longer strokes consult factory. Style T Minimum stroke 2". Style A Note: Sight glass (required) Minimum 5" stroke.</small>



Air/Oil Tank
250 P.S.I.
Sight glass available in Style A only

Note: Tank Dimensions and the Useable Volume Finder are located on page 45.

Provenair®

Position Sensors (Switches)

Reed Switches

Switch is normally open, load can be attached to BROWN or BLUE lead. The BROWN lead is the higher potential side of the switch. In a magnetic field, the two reeds are brought into contact to “make” the circuit. Reed switches have black, ‘two wire’ leads.

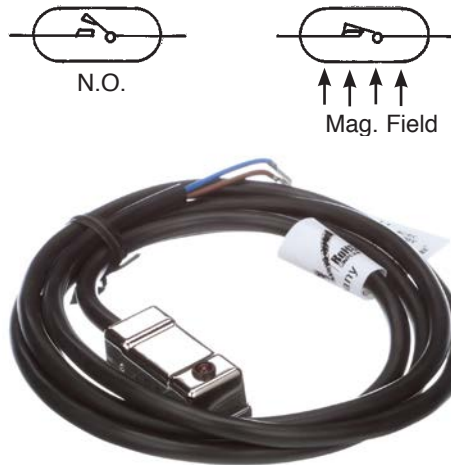

Hall Effect Switches

It is important to note that Hall Effect switches must always have current through them to work. In a magnetic field, the semiconductor generates a voltage across the sense leads. Removing the magnetic field returns the switch to its normally open state. Hall effect switches have ‘three wire’ leads. Black leads are sinking (NPN). Grey leads are sourcing (PNP). Load is controller.

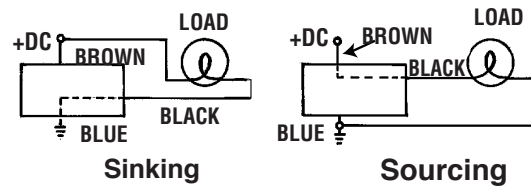

There are two types of Hall Effect switches. Each is connected differently. Check your PLC for the input method used. Sinking (NPN) will sink current to ground. Sourcing (PNP) will provide current from the +VDC.

Switch Mounting Brackets

Bore	Model Number
1-1/2"	119584
2", 2-1/2"	119585
3-1/4" and 4"	119586



Note: Operating temperature is 14 - 140° F and the environmental rating is IEC IP 67 in all three switch types. Std. Red LED requires min 18 mA.

Technical Information:

1. Do not exceed specification, permanent damage to the sensor may occur.
2. For reed switch type sensors, polarity must be observed for the proper functioning of LED. Connect the brown wire in series with load positive (+) and the blue wire to negative (-) or power source space. If the polarity is reversed, reed switch remains functional but LED will remain in "OFF" state.
3. For solid-state type sensors, polarity must also be observed. Connect brown wire to the positive (+) and the blue to the negative (-) of DC power source. The black wire must connect to the load ONLY. If the black wire is accidentally connected to the power source, permanent damage to the sensor may occur.
4. An external protection circuit may be required if the reed switch is used with inductive load, such as relay or solenoid. For DC inductive load, attach an external diode parallel to the load and use R-C circuit parallel with AC inductive load.
5. Keep sensors away from stray magnetic field to prevent malfunctions.
6. When using reed switch with capacitive load or if the lead wire length exceeds 10-meter, and inductor must be installed in series with the sensor to prevent damage (Sticking effect).

Switch Specifications

Model Number	119581-1	119581-2	119581-3	119582-1	119582-2	119582-3	119583-1	119583-2	119583-3
Lead Length/Type	1m bare	3m bare	Plug	1m bare	3m bare	Plug	1m bare	3m bare	Plug
Lead Color	Black			Grey			Black		
Switch Type	REED			PNP (SOURCING)			NPN (SINKING)		
Input Voltage	100 VDC, 125 VAC Max.			10 - 30 VDC			5 - 30 VDC		
Operating Current	300mA (150mA Inductive)			7 - 100mA @ 12V			10 - 200mA @ 12V		
	-			14 - 200mA @ 24V			20 - 200mA @ 24V		
Detecting Distance	2.5 mm			1.5 mm			1.5 mm		
Detecting Width	-			3.0 mm			3.0 mm		
Response Time	1 mSec. Min.			-			-		
LED Function	18mA Min.			1mA Min.			1mA Min.		

Dimensional Data

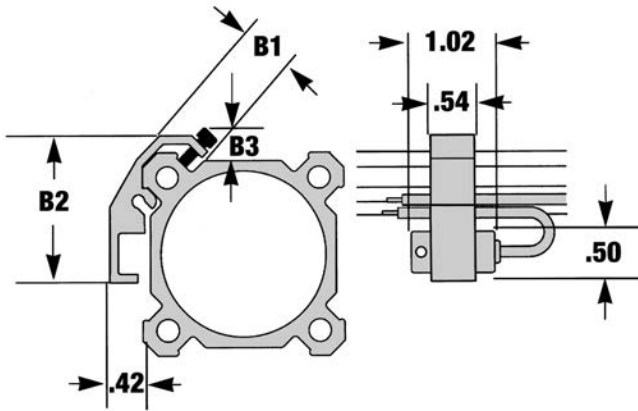

Cylinder Bore (Inches)

	1 1/2"	2 & 2 1/2"	3 1/4" & 4"
B1	.51	.60	.80
B2	1.50	1.77	2.45
B3	.26	.26	.33

Useable Volume Finder

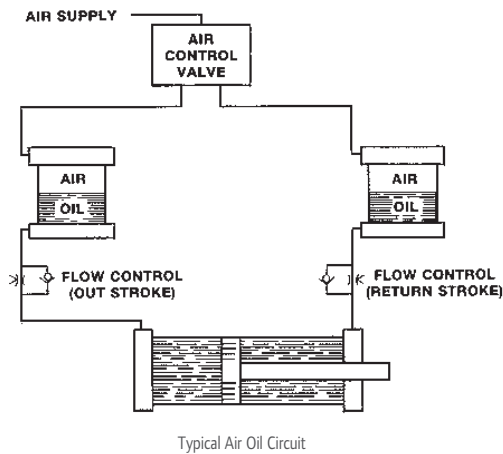

Useable Volume Finder

	Bore	Style A	Style T
Q	1-1/2"	1.33	1.77
S	2"	2.36	3.14
T	2-1/2"	3.68	4.91
W	3-1/4"	6.22	8.29
4	4"	9.42	12.56

Style T or A

Derive required circuit volume (V) in Cu. In.

Divide (V) by factor from chart above to determine stroke (enter stroke value into model number).

Find unit length by adding stroke to dimension A from tank dimension table.

Tank Dimensions

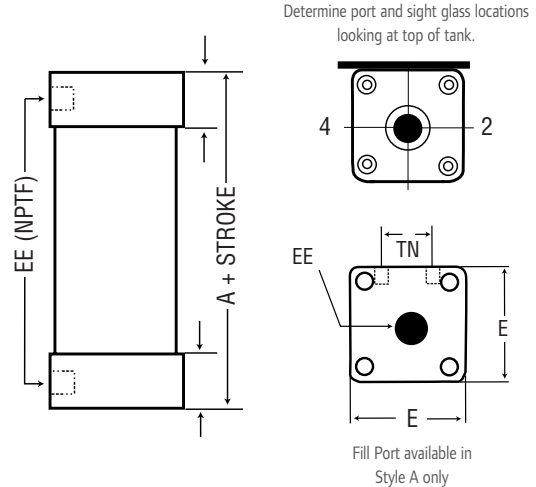

Tank Dimensions

	BORE	A	J	TN	E	EE NPTF
Q	1-1/2"	2.005	0.94	0.63	2	3/8-18
S	2"	2.005	0.94	0.88	2.5	3/8-18
T	2-1/2"	2.005	0.94	1.25	3	3/8-18
W	3-1/4"	2.505	1.19	1.50	3.75	1/2-14
4	4"	2.505	1.19	2.06	4.5	1/2-14

Repair Kits and Reciprocating Assemblies

Ordering

Micro-Air Seal Kits

BORE SIZE (Inches)	1/2	3/4	1-1/8
	7150	7151	7152

Economair Seal Kits

EXAMPLE: **28 20 - 5 3 09-040**

- To order a repair kit, 1) Obtain model number from label on cylinder.
 2) Write "RK" for Repair Kit
 3) Using number from cylinder label, construct proper kit number as directed below.

Order Kit No:

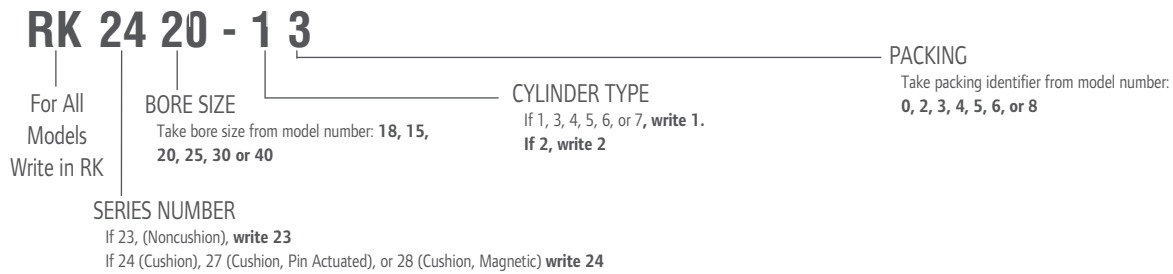

Economair Reciprocating Assembly

EXAMPLE: **28 20 - 2 3 8 9-040**

- To order a reciprocating assembly, 1) Obtain model number from label on cylinder.
 2) Write "RA" for reciprocating assembly
 3) Using number from cylinder label, construct proper assembly number as directed below.

Order Assembly No.:

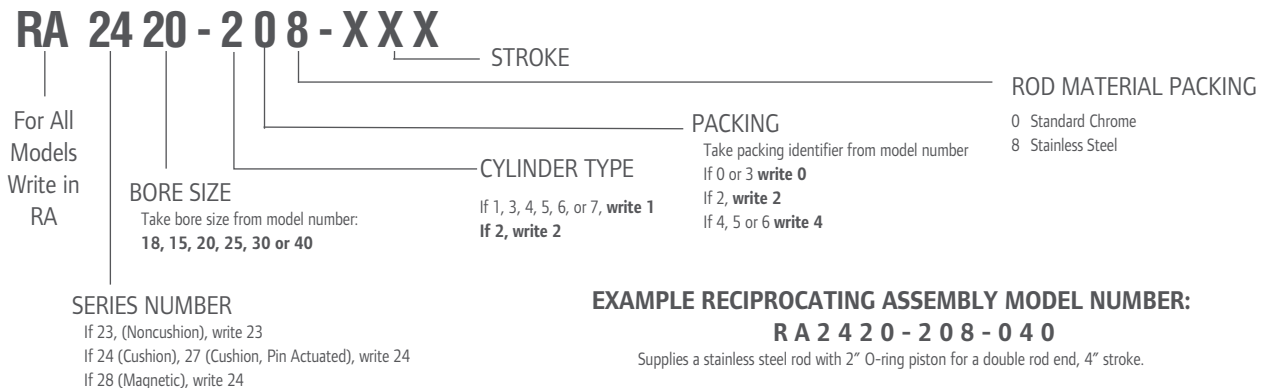

Repair Kits (Provenair Single Rod End Bushings) Order two kits for double rod end cylinders

Rod Diameter	Cylinder Bore Size (Inches)								
	1-1/2	2	2	2-1/2	2-1/2	3-1/4	3-1/4	4	4
Series AN Bushing	119454	119455	119456	119455	119456	119457	119458	119457	119458
Series SN Bronze Bushing	114171	114171	114172	114171	114172	114172	114173	114172	114173

Rod Diameter	Cylinder Bore Size (Inches)								
	5	5	6	6	8	8	10	10	
Series AN Bushing	-	115074	115075	115075	115076	115075	115076	115076	114130
Series SN Bronze Bushing	-	114172	114173	114172	114173	114173	114174	114174	114175

Repair Kits and Reciprocating Assemblies

Provenair Repair Kits

Example Repair Kit Model: **R K N A W M - V B**

Position	1			2	3	4		5	6	7	8	9		10
Cylinder Model No.	X	X	N	X	X	X	-	X	X	X	X	X	-	XXX
Repair Kit Model No.	RKN or SKN*			X	X	X	-	Not Used	X	B	Not Used			

*To order a repair kit, use the model number from the cylinder label. Provenair repair kits start with the letters "RKN", "SKN" and appear in the first three positions. Using the numbers from the cylinder label, construct the remainder of the Repair Kit or number as directed below.

Position 1 Repair Kit Designators	Position 2 Type	Position 3 Bore Size	Position 4 Rod Diameter	Position 5	Position 6 Replacement Seals	Position 7 Replacement Cushion Seals	Position 8 - 10
S or R and K for Repair Kit, N for Provenair	A - Double Acting Single Rod B - Double Acting Double Rod	Q - 1- 1/2" S - 2" T - 2- 1/2" W - 3-1/4" 4 - 4" 5 - 5" 6 - 6" 8 - 8" Y - 10"	K - 5/8" M - 1" P - 1-3/8" Q - 1- 3/4" S - 2"	Rod Style Not Used	B - Buna-N V - Viton S - Self-Lube H -	(All Seal Kits Use "B") X - No Cushion Seals B - Cushion Both Ends C - Cushion Cap H - Cushion Head	Port Location Not Used, Mounts Not Used, Stroke Not Used

Provenair Reciprocating Assembly

Example Reciprocating Assembly Model: **RANASK-AB-120**

Supplies 5/8" diameter chrome rod, KK1 threads, cushioned, 12" stroke and 2" diameter piston for single rod end cylinder.

Position	1			2	3	4		5	6	7	8	9		10
Cylinder Model No.	X	X	N	X	X	X	-	X	X	X	X	X	-	XXX
Repair Kit Model No.	RAN or RSN*			X	X	X	-	X	Not Used	X	Not Used			

*To order a reciprocating assembly, use the model number from the cylinder label. Provenair reciprocating assemblies start with the letters "RAN" or "RSN" and appear in the first three positions. Using the numbers from the cylinder label, construct the remainder of the reciprocating assembly number as directed at left.

Position 1 Repair Kit Designators	Position 2 Type	Position 3 Bore Size	Position 4 Rod Diameter	Position 5 Rod Style	Position 6 Seals	Position 7 Replacement Cushion Seals	Position 8 - 10
RA or RS for Repair Kit, N for Provenair	A - Double Acting Single Rod B - Double Acting Double Rod	Q - 1- 1/2" S - 2" T - 2- 1/2" W - 3-1/4" 4 - 4" 5 - 5" 6 - 6" 8 - 8" Y - 10"	K - 5/8" M - 1" P - 1-3/8" Q - 1- 3/4" S - 2"	A - Chrome, Std Male (KK ₁) B - Chrome, Intermediate Male (KK ₂) C - Chrome, Full Male (CC) D - Chrome, Female (KK ₁) F - Chrome, No Threads G - S.S., Standard Male (KK ₁) H - S.S., Intermediate Male (KK ₂) J - S.S., Full Male (CC) K - S.S., Female (KK ₁) L - S.S., No Threads	Not Used	X - No Cushion Seals B - Cushion Both Ends	Port Location Not Used, Mounts Not Used, Stroke Not Used

Premair Round Compact

Premair Series Round Compact, Interchangeable Cylinders

Superior Interchangeable Industrial Air Cylinders

Big Value in a Compact Package— Stainless steel tie bolts and aluminum spacers lock precision machined heads tightly around a heavy walled, aluminum alloy cylinder barrel. The barrel's extremely smooth, self-lubricating interior surface insures highly reliable performance and extended seal life.



Features

- 6 bore sizes 1-1/8" thru 4" Strokes to 4" standard bore
- Available in 4 styles:
 - Double acting, single end rod (Model SCC)
 - Double acting, double end rod (Model SCD)
 - Single acting, spring retract rod (Model SCS)
 - Reverse acting, spring extend rod (Model SCR)
- Superior Piston Rod Bushing:
 - Captive in cylinder head
 - Self lubricating
 - Higher load bearing capacity
 - Lower coefficient of friction
- Aluminum Alloy Barrel
 - Extremely smooth interior
 - Lighter weight
- Hard chrome plated stain-less steel piston rod
- Captive Rod Seal in precision machined groove
 - Internally lubricated (Buna-N O'Ring)
- Buna-N O'Ring tube seals
- Magnalube®G lubrication
- Aluminum alloy spacers (clear anodized) enclose stainless steel tie bolts
- Aluminum alloy heads (clear anodized)
- Internally lubricated Carboxylated Nitrile O'Ring or optional U-Cup seals
- Thick cover prevents impact damage
- High strength threaded fastener and adhesive mates piston to rod

Ratings

Body	Aluminum Alloy
Heads	Clear anodized aluminum alloy
Tie Bolts	Stainless steel
Rod	Chrome plated stainless steel
Piston	Aluminum alloy
Rod end	Female thread with wrench flats
Ports	Position #1
Seals	Internally lubricated Nitrile
Lubrication	Magnalube®-G
Rod bushing	High density iron
Stroke tolerance	± 1/64"
Media	Air
Max. pressure rating,	250 psi
Min. recommended operating pressure	15 psi
Temp. rating cylinder	-25° to +225°F (-32° to +121°C)
Temp. rating electronic sensors	-5° to +175°F (-20° to +80°C)

Cylinder Sizing Guide

Bore Dia.	1-1/8"	1-1/2"	2"	2-1/2"	3"	4"
Rod Dia.	0.50"	0.63"	0.75"	0.75"	0.88"	1.00"
Rod Area	0.19"	0.31"	0.44"	0.44"	0.60"	0.79"
Push Area Single Rod	0.88"	1.76"	3.14"	4.91"	7.07"	12.57"
Push Area Double Rod	0.69"	1.45"	2.66"	4.47"	6.47"	11.78"
Pull Area	0.69"	1.45"	2.66"	4.47"	6.47"	11.78"

Spring Forces

Bore (in.)	Max. Force	Spring Rate (lbs/in.) for stroke range			
		0.12" - 1"	1.001" - 2"	2.001" - 3"	3.001" - 4"
1-1/8 (11)	11.50	6.00	2.50	1.76	1.25
1-1/2 (15)	13.00	5.50	2.25	1.60	1.13
2 (20)	13.00	5.50	2.25	1.60	1.13
2-1/2 (25)	25.00	6.50	2.75	1.93	1.38
3 (30)	25.00	6.50	2.75	1.93	1.38
4 (40)	25.00	6.50	2.75	1.93	1.38

Ordering Include dashes. Dashes are significant.

Position	1	2	3		4	5	6	7	8		9
Example:	SC	X	XX	-	X	X	X	X	X	-	XXX

Position 1 Series	Position 2 Type	Position 3 Bore Size	Position 4 Mounting Options	Position 5 Bumper/Seal Option
SC - Select, Compact	C - Double Acting, Single Rod End D - Double Acting, Double Rod End S - Double Acting R - Reverse Acting	11 - 1- 1/8" 15 - 1-1/2" 20 - 2" 25 - 2-1/2" 30 - 3" 40 - 4"	C - Pivot Mount D - Pivot Mount 90 From Standard E - Trunnion Mount, Both Ends (See Note #5) M - Trunnion Mount, Front (See Note #5) P - Trunnion Mount, Rear (See Note #5) G - Threaded Mounting Holes, Both Ends F - Threaded Mounting Holes, Front H - Threaded Mounting Holes, Rear J - Screw Clearance Holes, Both Ends K - Screw Clearance Holes, Front L - Screw Clearance Holes, Rear N - Nose Mount For SCC, SCR & SCS Only (See Note #6) X - Standard Counterbored Mounting holes/Bumper/	B - Bumpers, Both Ends (SCC & SCD Models Only) F - Bumpers, Front Only (SCR Models Only) R - Bumpers, Rear Only (SCR Models Only) L - Low Friction Seals M - Low Friction & Low Temperature Seals N - Low Friction & Viton Seals Q - Low Temperature Operation (-40 F to 200 F) V - Viton Seals For Media Compatibility W - Rod Wiper, Buna-N Only X - No Additional Options Required

Position 6 Thread Rod Options	Position 7 Magnet/Sensor Options	Position 8 Head/Port Options
D - Coarse Female Thread, Dimension "E" E - Male Rod End With Coarse Threads H - Hollow Rod, (SCD) Models Only M - Male Rod End, Fine, Thread N - Non-Threaded Rod W - 1/4" Extra Rod Extension Y - 1/2" Extra Rod Extension Z - 1" Extra Rod Extension X - No Additional Options Required	E - Magnetic Piston Only (See Note #7) X - No Additional Options Required	H - Heavy Duty Rear Head J - Fail Safe Operation (SCS Models Only) (See Note #5) P - Front Port Position #2 R - Front Port Position #3 S - Front Port Position #4 X - No Additional Options Required

Position 9 Stroke Length		
Tens	Ones	Fraction Inches
0	0 - 9	0 = None
0		1 = 1/8"
		2 = 1/4"
		3 = 3/8"
		4 = 1/2"
		5 = 5/8"
		6 = 3/4"
		7 = 7/8"

NOTES:
6) Includes heavy duty rear head (H) and rod wiper (W)
7) 3/8" stroke minimum. Not available with Viton seals or low temperature seals

Premair Round Compact

Accessories

Selection Guide	
Accessory	Standard Series
Clevis Bracket	✓
Trunnion Bracket	✓
Rod Pivot	✓

Clevis Bracket

Anodized aluminum alloy
Chrome plated steel pin included

The bracket is intended for mounting with either a rod pivot or pivot mount; it is not intended to mount directly with the rear cylinder head.

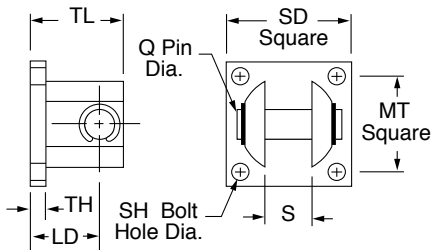

Dimensions (inches)									
Kit No.	Bore	LD	MT	Q	S	SH	SD	TH	TL
SCABC-1	1-1/8 (11)	0.56	0.75	1.87	0.39	#6	1.00	0.16	0.78
	1-1/2 (15)								
SCABC-2	2 (20)	0.94	1.38	0.375	0.75	#10	1.75	0.22	1.34
	2-1/2 (25)								
SCABC-3	3 (30)	1.25	2.00	0.625	1.00	0.25	2.50	0.25	1.81
	4 (40)								

Trunnion Bracket (pair)

Anodized aluminum alloy complete with bronze pivot bushings.

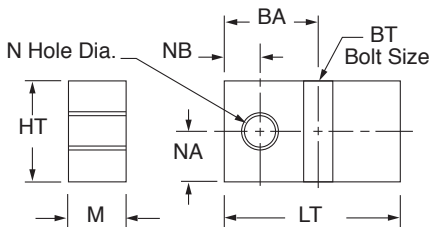

Dimensions (inches)									
Kit No.	Bore	BA	BT	HT	LT	M	ND	NA	NB
SCABT-2	1-1/8 (11)								
	1-1/2 (15)	0.81	1/4	0.88	1.50	0.50	0.251	0.38	0.31
	2 (20)								
SCABT-3	2-1/2 (25)	0.94	5/16	1.00	1.63	0.63	0.313	0.45	0.38
	3 (30)								
SCABT-4	4 (40)	1.06	3/8	1.25	1.88	0.75	0.376	0.55	0.44

Rod Pivot

Steel with bronze pivot bushing and nut

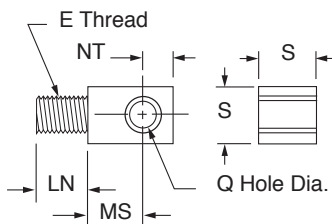

Dimensions (inches)							
Kit No.	Bore	E	LN	MS	NT	Q	S
SCARP-2	1-1/8 (11)	5/16 - 24 UNF	0.63	0.47	0.25	0.187	0.38
SCARP-3	1-1/2 (15)	3/8 - 24 UNF	0.63	0.72	0.44	0.375	0.75
SCARP-4	2 (20)	1/2 - 20 UNF	0.75	0.72	0.44	0.375	0.75
	2-1/2 (25)						
SCARP-5	3 (30)	5/8 - 18 UNF	0.88	1.00	0.63	0.625	1.00
SCARP-6	4 (40)	3/4 - 16 UNF	0.88	1.00	0.63	0.625	1.00

Premair Round Compacts

Magnetic Position Sensing

- Encased in a plastic housing, dovetail style electronic sensors are corrosion resistant. 45° wire outlet allows close mounting.
- Two methods of mounting are available:
 1. Tie bolt spacer mounted clamps
 2. Adhesive mounted dovetail extrusions
- Order sensors separately from the table below Sensor

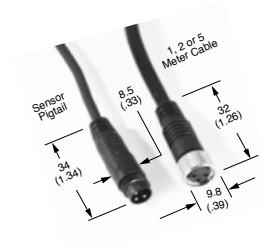
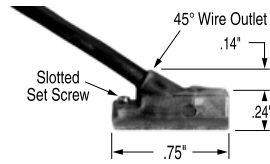

▀ Cable Sensor Specifications & Ordering

Ordering Guide Dovetail Style Magnetic Sensor with LED					Female Cordsets for Quick Disconnect	
Sensor Type	Prewired 9 ft. Part No.	Quick Disconnect Part No.*	Wire Leads	Electrical Characteristics	Length	Part No.
Electronic	SCAMS-1	SCAMS-3	3	Sourcing PNP 6-24 VDC, 0.20 Amp Max current, 0.5 Voltage Drop	1 Meter 2 Meters 5 Meters	- SCAFC-2 SCAFC-5
Electronic	SCAMS-2	SCAMS-4	3	Sinking NPN 6-24 VDC, 0.20 Amp Max current, 0.5 Voltage Drop		

Note*: Quick disconnect styles are supplied with 6 inch pigtail with male connector. Order female cordsets separately.

▀ Spacer Mounted Clamps for Position Sensors

Clamp Selection Guide				
Part No.	SCAMC-3	SCAMC-4	SCAMC-5	SCAMC-6
To Fit Bore	1-1/8"	1-1/2" & 2"	2-1/2" & 3"	4"

Order clamps and sensors separately



Premair Round Compact

Model SCC

Double Acting, Single Rod

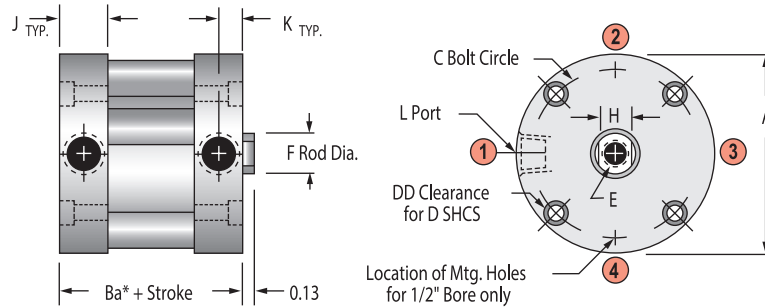

*Note: Some options effect cylinder length

Standard Strokes – All Models: • 1/8 • 1/4 • 3/8 • 1/2 • 5/8 • 3/4 • 7/8 • 1 • 1-1/4 • 1-1/2 • 1-3/4 • 2 • 2-1/2 • 3 • 3-1/2 • 4

Model SCD

Double Acting, Single Rod

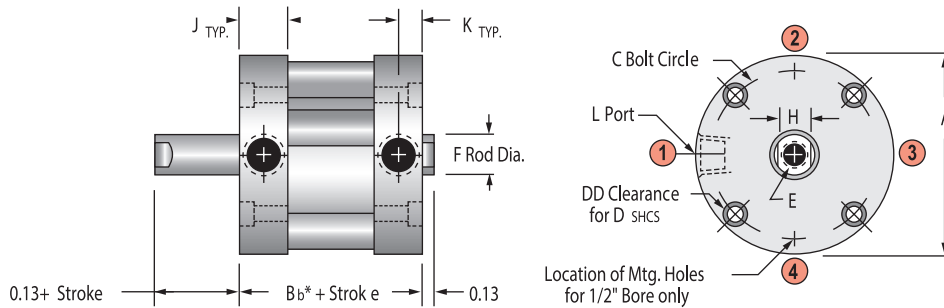

*Note: Some options effect cylinder length

Dimensions (inches)													
Bore	A	Ba*	Bb*	Bc* for Stroke Range				Bd* for Stroke Range				C	DD
				0-1	1.001-2	2.001-3	3.001-4	0-1	1.001-2	2.001-3	3.001-4		
1-1/8 (11)	2.00	0.88	0.94	0.88	1.50	2.13	2.75	1.38	2.00	2.63	3.25	1.69	4
1-1/2 (15)	2.62	0.88	1.00	0.88	1.50	2.13	2.75	1.38	2.00	2.63	3.25	2.19	4
2 (20)	3.12	0.94	1.06	0.94	1.56	2.19	2.81	1.44	2.06	2.69	NA	2.69	4
2-1/2 (25)	3.75	1.19	1.31	1.19	2.06	2.94	3.81	1.94	2.81	2.81	NA	3.25	4
3 (30)	4.25	1.25	1.38	1.25	2.12	3.00	3.88	2.00	2.88	2.88	NA	3.78	4
4 (40)	5.50	1.56	1.69	1.56	2.44	3.31	4.19	2.31	3.19	3.19	NA	4.94	4

Model SCS

Single Acting, Spring Retract

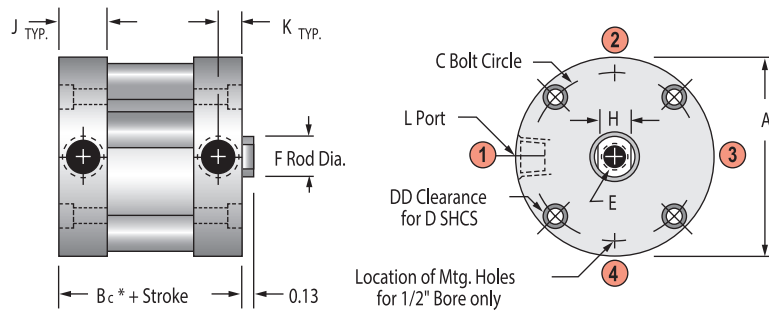

*Note: Some options effect cylinder length

Standard Strokes – All Models: · 1/8 · 1/4 · 3/8 · 1/2 · 5/8 · 3/4 · 7/8 · 1 · 1-1/4 · 1-1/2 · 1-3/4 · 2

Model SCR

Reverse Acting, Spring Extended

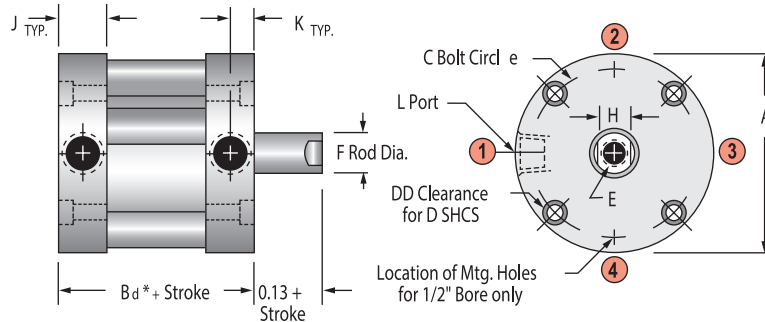

*Note: Some options effect cylinder length

Approximate Cylinder Weights (ounces) SCC, SCS, SCD, SCR

Bore	SCC, SCS		SCD			SCR		Nose Mount Option
	Base	Adder per 1/8 of Stroke	Base	Adder per 1/8 of Stroke	Adder per 1/8 of Stroke for -H Option	Base	Adder per 1/8 of Stroke	Adder to Base Weight
1-1/8 (11)	4.9	0.3	5.8	0.4	0.3	5.3	0.3	1.1
1-1/2 (15)	9.6	0.4	11.2	0.6	0.5	10.5	0.4	1.8
2 (20)	13.0	0.5	15.2	0.7	0.6	14.0	0.5	2.7
2-1/2 (25)	22.4	0.6	28.0	0.8	0.7	25.0	0.6	3.1
3 (30)	28.9	0.8	38.0	1.1	0.9	32.5	0.8	3.5
4 (40)	55.7	1.0	71.8	1.3	1.1	61.8	1.0	5.9

Dimensions (inches)

Bore	D	E Standard	E Depth for Stroke Range		F	H	J	K	L
			1/8 - 1/2	5/8 +					
1-1/8 (11)	#6	5/16-24 UNF	0.37 - 0.63	0.70	0.50	0.44	0.50	0.25	1/8 NPT
1-1/2 (15)	#10	3/8-24 UNF	0.37 - 0.70	0.70	0.63	0.50	0.50	0.25	1/8 NPT
2 (20)	#10	1/2-20 UNF	0.30 - 0.63	0.70	0.75	0.63	0.53	0.25	1/8 NPT
2-1/2 (25)	1/4	1/2-20 UNF	0.42 - 0.70	0.70	0.75	0.63	0.66	0.33	1/4 NPT
3 (30)	1/4	5/8-18 UNF	0.45 - 0.73	0.73	0.88	0.75	0.69	0.33	1/4 NPT
4 (40)	5/16	3/4-16 UNF	0.40 - 0.70	0.80	1.00	0.88	0.84	0.42	3/8 NPT

Premair Round Compact

Model Options

Male Rod Ends

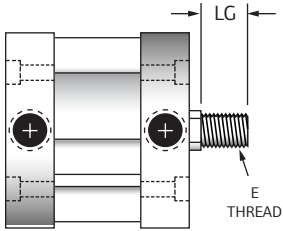

Thread Sizes		
E Thread		
Bore	M (Fine)	LG
1-1/8 (11)	5/16-24 UNF	0.50
1-1/2 (15)	3/8-24 UNF	0.50
2 (20)	1/2-20 UNF	0.63
2-1/2 (25)	1/2-20 UNF	0.63
3 (30)	5/8-18 UNF	0.75
4 (40)	3/4-16 UNF	0.75

Rod Wiper (Buna-N only)

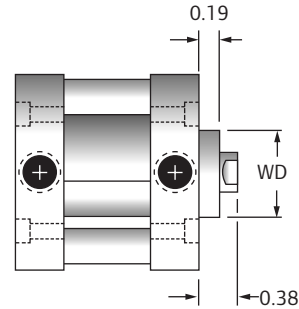

Boss Dia	
Bore	WD
1-1/8 (11)	0.88
1-1/2 (15)	1.00
2 (20)	1.13
2-1/2 (25)	1.13
3 (30)	1.25
4 (40)	1.38

Mounting Options

Trunnion Mount

Available rear, front or both.

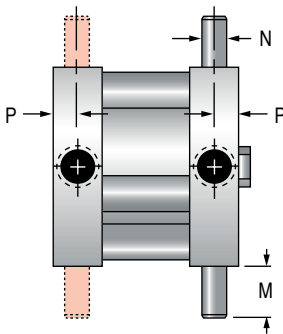

Pivot Mount

Complete with bronze pivot bushing.
Not available as an accessory.

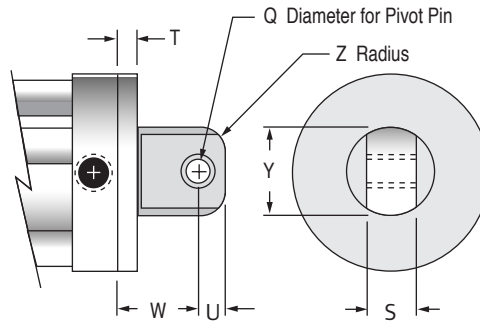

Screw Clearance Holes

Available either or both ends.

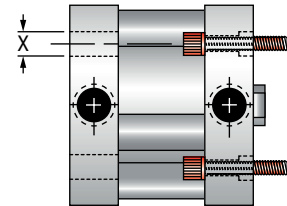

Dimensions (inches)											
Bore	M	N	P	Q	S	T	U	W	X	Y	Z
1-1/8 (11)	0.50	0.250	0.25	0.19	0.38	0.25	0.25	0.81	0.25	0.75	0.19
1-1/2 (15)	0.50	0.250	0.25	0.38	0.75	0.25	0.44	1.19	0.34	1.38	0.38
2 (20)	0.50	0.250	0.25	0.38	0.75	0.31	0.44	1.25	0.34	1.38	0.38
2-1/2 (25)	0.63	0.312	0.33	0.38	0.75	0.38	0.44	1.31	0.41	1.38	0.38
3 (30)	0.63	0.312	0.33	0.63	1.00	0.38	0.56	1.69	0.41	1.88	0.38
4 (40)	0.75	0.375	0.42	0.63	1.00	0.44	0.56	1.75	0.50	1.88	0.38

Premair Round Compact

Deviations from Standard Dimensions

Bore	Length Adder (inches)				
	Low Friction Seals	Heavy Duty Rear Head ‡	Magnetic Position Sensing† (E or M)		
			SCC,SCD	SCS	SCR
1-1/8 (11)	0.38	0.19	0.88	0.88	0.88
1-1/2 (15)	0.38	0.19	0.88	0.88	0.88
2 (20)	0.38	0.19	0.88	0.88	0.88
2-1/2 (25)	0.38	0.25	0.88	0.88	0.88
3 (30)	0.50	0.25	0.88	0.88	0.88
4 (40)	0.50	0.38	0.88	0.88	0.88

‡ Heavy duty rear head is recommended for applications where the cylinder is mounted on the front face or trunnion-mounted, and impact loading (20 or more cycles/minute) occurs between the piston and rear head. It increases the overall length of the cylinder as shown.
 † A minimum stroke of 3/8" is required to sense end-of-stroke positions. For low friction seals used in conjunction with magnetic position sensing, use "E" or "M" sensor options only.

Hollow Rod Option

Bore	Hole Diameter	
	Female Rod Thread	Male Rod Thread
1-1/8 (11)	0.22	0.16
1-1/2 (15)	0.28	0.19
2 (20)	0.38	0.25
2-1/2 (25)	0.38	0.25
3 (30)	0.44	0.31
4 (40)	0.50	0.38

Threaded Mounting Holes

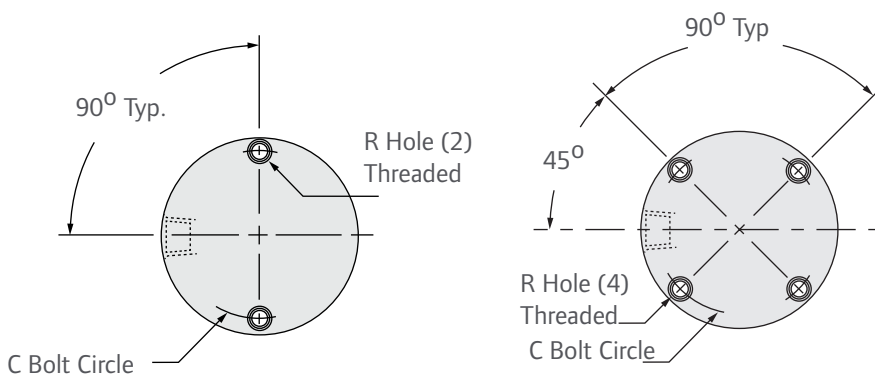

Nose Mount

Available on SCC, SCS, SCR.
 Included heavy duty rear head. See length adder above.

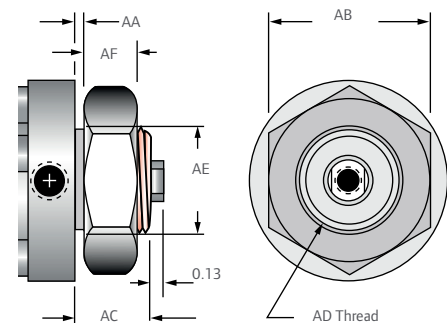

Dimensions (inches)

Bore	AA	AB	AC	AD	AE	AF	C	R
1-1/8 (11)	.13	1.50 Hex	.75	1- 14 UNF-2A	1.00	.55	1.69	# 6 - 32 UNC
1-1/2 (15)	.13	1.88 Hex	.75	1-1/4 - 12 UNF-2A	1.25	.52	2.19	# 10 - 24 UNC
2 (20)	.19	1.88 Hex	.88	1-3/8 - 12 UNF-2A	1.38	.52	2.69	# 10 - 24 UNC
2-1/2 (25)	.25	1.88 Hex	1.00	1-3/8 - 12 UNF-2A	1.38	.52	3.25	1/4 - 20 UNC
3 (30)	.25	1.88 Hex	1.00	1-3/8 - 12 UNF-2A	1.38	.52	3.78	1/4 - 20 UNC
4 (40)	.19	2.62 Hex	1.12	1-3/4 - 12 UN-2A	1.75	.88	4.94	5/16 - 18 UNC

Maximum Torque for Nose Mount Option

Bore	Foot-Pounds
1-1/8 (11)	100
1-1/2 (15)	120
2 (20)	130
2-1/2 (25)	130
3 (30)	130
4 (40)	150

Premair Square Compact

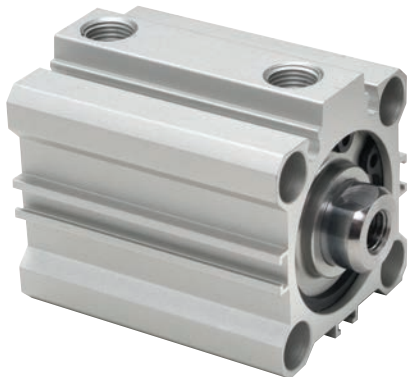

10 Bore Sizes 12mm thru 100mm

- NPT Ports
- Stainless Steel Rod
- Space Saving Design
- Buna Seals Standard
- Light Weight Aluminium Body
- Female Rod Threads Standard

Low-profile, aluminum cylinders are designed for compact, spacesaving applications. All models have magnetic pistons and are switch-ready for accurate position sensing. Low-profile, solid state switches slide into machined grooves located on the cylinder body. Stainless steel piston rods are hard chrome plated for superior wear and corrosion resistance. Piston is attached to rod with a flat head screw to minimize pounding and vibration. Mounting through holes are threaded for easy mounting hardware installation.

Ratings

- Fluid AIR
- Max. Operating Pressure 140 PSI
- Min. Operating Pressure 7 PSI
- Ambient and Fluid Temperature . . . 15-140 F (-10 - 60 C)
- Lubrication Not Required
- Cushion None
- Rod End Thread Female (standard)
- Stroke Tolerance 0.039 in (+10/-0mm)
- Mounting Through Hole (Standard)
- Piston Speed 2-20inch/sec (50-500mm/sec)

Cylinder Force

Bore Size	Operating Pressure PSI			Bore Size	Operating Pressure PSI		
	50	75	100		50	75	100
012 (1/2 nom)	8.7	13.1	17.5	040 (1 1/2 nom.)	97.4	146	195
	6.6	9.8	13.1		81.8	123	164
016 (5/8 nom)	15.6	23.4	31.2	050 (2 nom)	152	228	304
	11.7	17.5	23.4		128	192	256
020 (3/4 nom)	24.3	36.5	48.6	063 (2 1/2 nom)	242	362	483
	18.2	27.3	36.5		217	326	434
025 (1 nom)	38	57	76	080 (3 1/4 nom)	390	584	779
	29.3	43.9	58.5		352	527	703
032 (1 1/4 nom)	62.3	93.5	125	100 (4 nom)	609	913	1217
	46.8	70.1	93.5		554	831	1108

Basic Cylinder Weights (lbs)

Bore (in)	Stroke(inch)											
	5 (.20)	10 (.39)	15 (.59)	20 (.79)	25 (.98)	30 (1.18)	35 (1.38)	40 (1.57)	45 (1.77)	50 (1.97)	75 (2.95)	100 (3.94)
1/2	0.110	0.126	0.141	0.157	0.172	0.187	-	-	-	-	-	-
5/8	0.157	0.181	0.207	0.232	0.256	0.280	-	-	-	-	-	-
3/4	0.229	0.271	0.315	0.359	0.406	0.450	0.494	0.540	0.584	0.631	-	-
1	0.284	0.331	0.395	0.423	0.472	0.518	0.564	0.613	0.657	0.706	-	-
1-1/4	0.571	0.598	0.624	0.650	0.701	0.750	0.800	0.851	0.902	0.961	1.22	1.47
1-1/2	0.752	0.805	0.858	0.908	0.953	0.997	1.05	1.09	1.14	1.2	1.44	1.68
2	-	1.10	1.17	1.25	1.34	1.43	1.5	1.58	1.66	1.78	2.18	2.5
2-1/2	-	1.60	1.69	1.78	1.87	1.97	2.06	2.15	2.23	2.38	2.84	3.29
3-1/4	-	3.53	3.74	4.0	4.16	4.36	4.57	4.78	4.99	5.28	6.31	7.33
4	-	5.55	5.68	5.81	6.05	6.29	6.52	6.75	6.97	7.31	8.45	9.59

Ordering Include dashes. Dashes are significant.

Position	1	2	3	4		5	6	7	8	9		10
Example:	M	D	S	XX	-	A	A	A	D	N	-	XXX

Position 1 Series	Position 2 Type	Position 3 Rod Type	Position 4 Metric Bore Size	Position 5 Mounting Option	Position 6 Seats/Bumpers	Position 7 Rod Options	Position 8 Magnetic Piston	Position 9 Port/Rod Thread	Position 10 Metric Stroke
M - Premair Metric	D - Double Acting	S - Single Acting, (Standard)	12 - 12mm 16 - 16mm 20 - 20mm 25 - 25mm 32 - 32mm 40 - 40mm 50 - 50mm 63 - 63mm 80 - 80mm 100 - 100mm	A - Threaded Thru Hole (Standard)	A - Buna	A - None, Standard Female Rod Thread	D - Magnetic	N - NPT ports inch rod threads	005 - 5mm (3/16") 010 - 10mm (25/64") 015 - 15mm (19/32") 020 - 20mm (25/32") 025 - 25mm (1") 030 - 30mm 1-11/64") 050 - 50mm (1-31/32") 075 - 75mm (2-61/64") 100 - 100mm (3-15/16")

Available models

Bore(mm)	Stroke (mm)	Model number	Bore(mm)	Stroke (mm)	Model number
12	5	MDS12-AAADN-005	40	35	MDS40-AAADN-035
12	10	MDS12-AAADN-010	40	40	MDS40-AAADN-040
12	15	MDS12-AAADN-015	40	45	MDS40-AAADN-045
12	20	MDS12-AAADN-020	40	50	MDS40-AAADN-050
12	25	MDS12-AAADN-025	40	75	MDS40-AAADN-075
12	30	MDS12-AAADN-030	40	100	MDS40-AAADN-100
16	5	MDS16-AAADN-005	50	10	MDS50-AAADN-010
16	10	MDS16-AAADN-010	50	15	MDS50-AAADN-015
16	15	MDS16-AAADN-015	50	20	MDS50-AAADN-020
16	20	MDS16-AAADN-020	50	25	MDS50-AAADN-025
16	25	MDS16-AAADN-025	50	30	MDS50-AAADN-030
16	30	MDS16-AAADN-030	50	35	MDS50-AAADN-035
20	5	MDS20-AAADN-005	50	40	MDS50-AAADN-040
20	10	MDS20-AAADN-010	50	45	MDS50-AAADN-045
20	15	MDS20-AAADN-015	50	50	MDS50-AAADN-050
20	20	MDS20-AAADN-020	50	75	MDS50-AAADN-075
20	25	MDS20-AAADN-025	50	100	MDS50-AAADN-100
20	30	MDS20-AAADN-030	63	10	MDS63-AAADN-010
20	35	MDS20-AAADN-035	63	15	MDS63-AAADN-015
20	40	MDS20-AAADN-040	63	20	MDS63-AAADN-020
20	45	MDS20-AAADN-045	63	25	MDS63-AAADN-025
20	50	MDS20-AAADN-050	63	30	MDS63-AAADN-030
25	5	MDS25-AAADN-005	63	35	MDS63-AAADN-035
25	10	MDS25-AAADN-010	63	40	MDS63-AAADN-040
25	15	MDS25-AAADN-015	63	45	MDS63-AAADN-045
25	20	MDS25-AAADN-020	63	50	MDS63-AAADN-050
25	25	MDS25-AAADN-025	63	75	MDS63-AAADN-075
25	30	MDS25-AAADN-030	63	100	MDS63-AAADN-100
25	35	MDS25-AAADN-035	80	10	MDS80-AAADN-010
25	40	MDS25-AAADN-040	80	15	MDS80-AAADN-015
25	45	MDS25-AAADN-045	80	20	MDS80-AAADN-020
25	50	MDS25-AAADN-050	80	25	MDS80-AAADN-025
32	5	MDS32-AAADN-005	80	30	MDS80-AAADN-030
32	10	MDS32-AAADN-010	80	35	MDS80-AAADN-035
32	15	MDS32-AAADN-015	80	40	MDS80-AAADN-040
32	20	MDS32-AAADN-020	80	45	MDS80-AAADN-045
32	25	MDS32-AAADN-025	80	50	MDS80-AAADN-050
32	30	MDS32-AAADN-030	80	75	MDS80-AAADN-075
32	35	MDS32-AAADN-035	80	100	MDS80-AAADN-100
32	40	MDS32-AAADN-040	10	10	MDS10-AAADN-010
32	45	MDS32-AAADN-045	10	15	MDS10-AAADN-015
32	50	MDS32-AAADN-050	10	20	MDS10-AAADN-020
32	75	MDS32-AAADN-075	10	25	MDS10-AAADN-025
32	100	MDS32-AAADN-100	10	30	MDS10-AAADN-030
40	5	MDS40-AAADN-005	10	35	MDS10-AAADN-035
40	10	MDS40-AAADN-010	10	40	MDS10-AAADN-040
40	15	MDS40-AAADN-015	10	45	MDS10-AAADN-045
40	20	MDS40-AAADN-020	10	50	MDS10-AAADN-050
40	25	MDS40-AAADN-025	10	75	MDS10-AAADN-075
40	30	MDS40-AAADN-030	10	100	MDS10-AAADN-100

Premair Square Compact

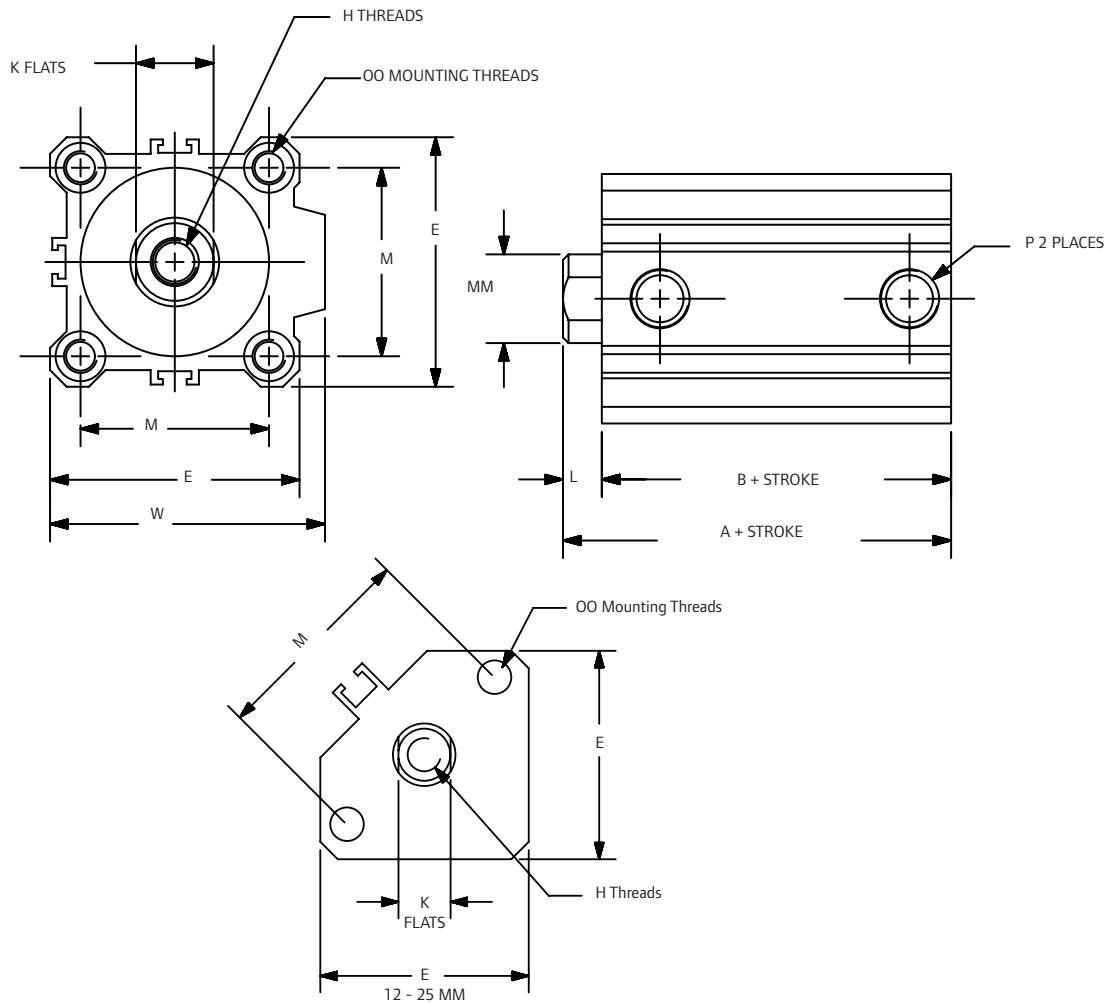

Dimensions mm (inch)											
BORE mm (Nom. in)	A	B	E	H (inch)	K	L	M	MM	OO	P (NPT)	W
12 (1/2)	31.5 (1.24)	28.0 (1.10)	25 (0.98)	8-32	5 (0.20)	3.5 (0.14)	22 (0.87)	6 (0.236)	6.5(0.26)	10-32	23(0.90)
16 (5/8)	34.0 (1.34)	30.5 (1.20)	29 (1.14)	8-32	6 (0.24)	3.5 (0.14)	28 (1.10)	8 (0.315)	6.5(0.26)	10-32	27.2(1.07)
20 (3.4)	36.0 (1.42)	31.5 (1.24)	36 (1.42)	10-32	8 (.031)	4.5 (0.18)	36 (1.42)	10 (0.394)	9(0.35)	10-32	31.2(1.23)
25 (1)	37.5 (1.48)	32.5 (1.28)	40 (1.57)	1/4-28	10 (0.39)	5 (0.20)	40 (1.57)	12 (0.472)	9(0.35)	10-32	36.9(1.45)
32 (1-1/4)	40.0 (1.57)	33.0 (1.30)	44.5 (1.75)	5/16- 24	14 (0.55)	7 (0.28)	34 (1.34)	16 (0.630)	9(0.35)	1/8	49.3(1.94)
40 (1-1/2)	46.5 (1.83)	39.5 (1.56)	52 (2.05)	3/8-24	14 (0.55)	7 (0.28)	40 (1.57)	16 (0.630)	9(0.35)	1/8	57(2.24)
50 (2)	48.5 (1.91)	40.5 (1.59)	63.7 (2.51)	1/2-20	17 (0.67)	8 (0.31)	50 (1.97)	20 (0.787)	11(0.43)	1/4	70.6(2.78)
63 (2-1/2)	54.0 (2.13)	46.0 (1.81)	76.7 (3.02)	1/2-20	17 (0.67)	8 (0.31)	60 (2.36)	20 (0.787)	14(0.55)	1/4	83.6(3.29)
80 (3-1/4)	63.5 (2.50)	53.5 (2.11)	97.8 (3.85)	5/8-18	22 (0.87)	10 (0.39)	77 (3.03)	25 (0.984)	17.5(0.69)	3/8	104(4.09)
100 (4)	75.0 (2.95)	63.0 (2.48)	115.3 (4.54)	3/4-16	27 (1.06)	12 (0.47)	94 (3.70)	30 (1.181)	17.5(0.69)	3/8	121.9(4.80)

Premair Square Compact



Flange Mount

Bore mm (in)	Part Number
12 (1/2)	114815-12
16 (5/8)	114815-16
20 (3/4)	114815-20
25 (1)	114815-25
32 (1-1/4)	114815-32
40 (1-1/2)	114815-40
50 (2)	114815-50
63 (2-1/2)	114815-63
80 (3-1/4)	114815-80
100 (4)	114815-100



Foot Mount

Bore mm (in)	Part Number
12 (1/2)	114816-12
16 (5/8)	114816-16
20 (3/4)	114816-20
25 (1)	114816-25
32 (1-1/4)	114816-32
40 (1-1/2)	114816-40
50 (2)	114816-50
63 (2-1/2)	114816-63
80 (3-1/4)	114816-80
100 (4)	114816-100

Premair Square Compact

Double Clevis

Dimensions-inch

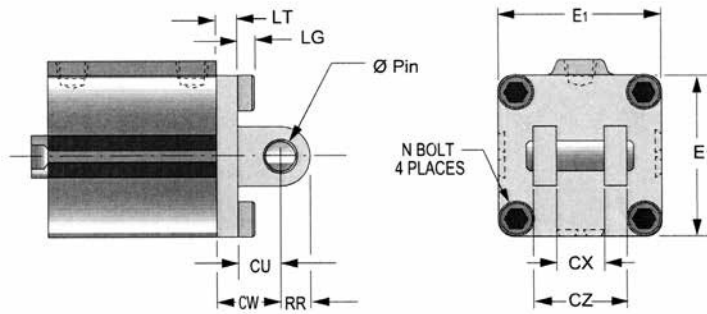

Bore(in)	Pin (in)	CW	CU	CX	CZ	LT	LG	RR	E1	N(bolt)
12 (1/2)	0.187	0.55	0.28	0.02	0.39	0.20	0.11	0.24	0.98	M4x.07
16 (5/8)	0.187	0.59	0.39	0.03	0.47	0.20	0.11	0.24	1.14	M4x.07
20 (3/4)	0.312	0.71	0.47	0.33	0.63	0.20	0.16	0.35	1.42	M6x1.0
25 (1)	0.375	0.79	0.55	0.41	0.79	0.20	0.16	0.39	1.57	M6x1.0
32 (1-1/4)	0.375	0.79	0.55	0.72	1.42	0.24	0.16	0.39	1.75	M6x1.0
40 (1-1/2)	0.375	0.87	0.55	0.72	1.42	0.31	0.16	0.39	2.05	M6x1.0
50 (2)	0.500	1.10	0.79	0.88	1.73	0.31	0.20	0.55	2.51	M8x1.25
63 (2-1/2)	0.500	1.18	0.79	0.88	1.73	0.39	0.24	0.55	3.02	M10x1.5
80 (3-1/4)	0.750	1.50	1.07	1.11	2.20	0.43	0.28	0.71	3.85	M12x1.75
100 (4)	0.875	1.77	1.22	1.27	2.52	0.55	0.28	0.87	4.54	M12x1.75

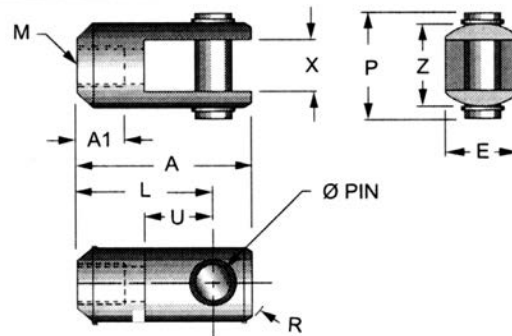

Rod Clevis

Dimensions-inch

Bore mm (in)	L	U	X	Z	P	E	A1	A	R	M (thds) Inch/Metric
12 (1/2)	0.63	0.27	0.21	0.39	0.55	0.39	0.24	0.85	0.25	#8-32 M3x0.5
16 (5/8)	0.83	0.39	0.26	0.47	0.63	0.47	0.24	1.10	0.47	#8-32 M4x0.7
20 (3/4)	0.98	0.45	0.33	0.63	0.83	0.63	0.24	1.34	0.41	#10-32 M5x0.8
25 (1)	1.18	0.55	0.41	0.78	0.98	0.78	0.31	1.61	0.50	1/4-28 M6x1.0
32 (1-1/4)	1.18	0.55	0.72	1.44	1.61	0.87	0.63	1.65	0.47	5/16-24 M8x1.25
40 (1-1/2)	1.18	0.55	0.72	1.44	1.61	0.87	0.63	1.65	0.47	3/8-24 M8x1.25
50 (2)	1.57	0.79	0.88	1.75	1.97	1.10	0.79	2.20	0.63	1/2-20 M10 x 1.5
63(2-1/2)	1.57	0.79	0.88	1.75	1.97	1.10	0.79	2.20	0.63	1/2-20 M10 x 1.5
80 (3-1/4)	1.97	1.06	1.12	2.19	2.46	1.50	0.91	2.80	0.83	5/8-18 M16x2.0
100 (4)	2.17	1.22	1.28	2.50	2.78	1.73	0.95	3.11	0.95	3/4-16 M20x2.5

Premair Square Compact

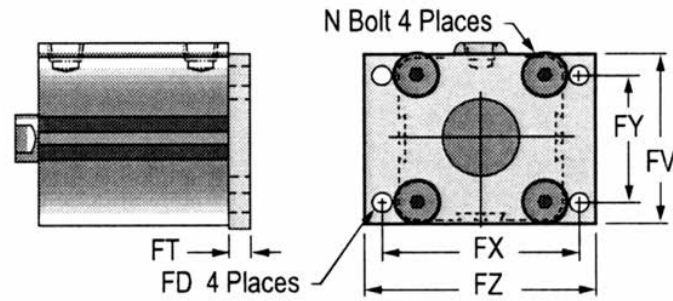

Flange Mount

Dimension (inches)

Bore mm (in)	FT	L	N Bolt	FD	FY	FX	FV	FZ
12 (1/2)	0.22	0.31	M4 x 0.7	1.80	-	1.77	0.98	2.17
16 (5/8)	0.22	0.31	M4 x 0.7	1.80	-	1.77	1.18	2.17
20 (3/4)	0.31	0.26	M6 x 1.0	0.26	-	1.89	1.54	2.36
25 (1)	0.31	0.28	M6 x 1.0	0.26	-	2.05	1.65	2.52
32 (1-1/4)	0.31	0.35	M6 x 1.0	0.22	1.34	2.20	1.89	2.56
40 (1-1/2)	0.31	0.35	M6 x 1.0	0.22	1.57	2.44	2.13	2.83
50 (2)	0.35	0.35	M8 x 1.25	0.26	1.97	2.99	2.64	3.50
63 (2-1/2)	0.35	0.35	M10 x 1.50	0.35	2.36	3.62	3.15	4.25
80 (3-1/4)	0.43	0.35	M12 x 1.75	0.43	3.03	4.57	3.90	5.28
100 (4)	0.43	0.43	M12 x 1.75	0.43	3.70	5.35	4.61	6.06

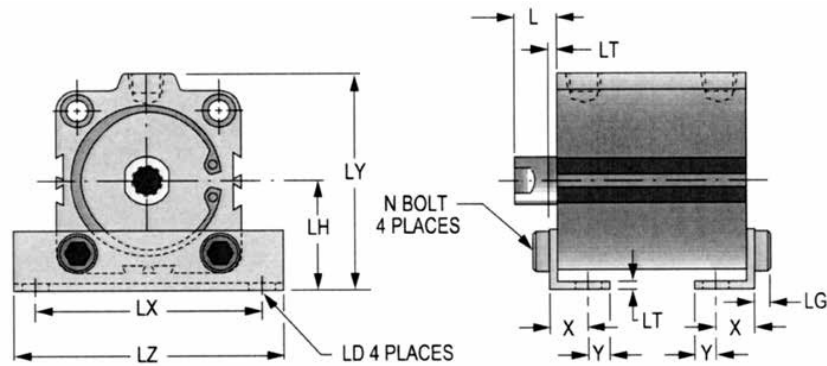

Foot Mount

Dimension (inches)

Bore mm (in)	LD	LH	LX	LY	LZ	L	LT	X	Y	LG
12 (1/2)	0.18	0.67	1.34	1.16	1.73	0.53	0.08	0.31	0.18	0.11
16 (5/8)	0.18	0.75	1.50	1.32	1.89	0.53	0.08	0.31	0.20	0.11
20 (3/4)	0.26	0.94	1.89	1.65	2.44	0.57	0.13	0.36	0.23	0.16
25 (1)	0.26	1.02	2.05	1.81	2.60	0.59	0.13	0.42	0.23	0.16
32 (1-1/4)	0.26	1.18	2.24	2.24	2.80	0.67	0.13	0.44	0.23	0.16
40 (1-1/2)	0.26	1.30	2.52	2.52	3.07	0.67	0.13	0.44	0.28	0.60
50 (2)	0.35	1.54	3.11	3.07	3.74	0.71	0.13	0.58	0.31	0.20
63 (2-1/2)	0.43	1.81	3.74	3.60	4.45	0.71	0.13	0.64	0.35	0.24
80 (3-1/4)	0.51	2.32	4.65	4.49	5.51	0.79	0.18	0.77	0.43	0.28
100 (4)	0.51	2.80	5.39	5.35	6.38	0.87	0.24	0.91	0.49	0.28

Premair Square Compact

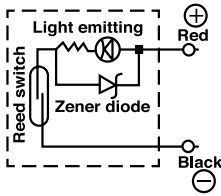

Sensors

Part Number	Type	Switching Current	Switching Voltage
114811	Reed Sensor	0.5 Amp. Max	0-120VDC/VAC
114812	Reed Sensor	0.03 Amp Max.	5-120VDC/VAC
114813	Sourcing Sensor	0.20 Amp Max.	Sourcing PNP 6-24VDC
114814	Sinking Sensor	0.20 Amp Max.	Sinking NPN 6-24VDC

Model	114811	114812	114813	114814
TYPE	REED	REED	PNP(SOURCING)	NPN(SINKING)
	2 WIRE	2 WIRE	3 WIRE	3 WIRE
LEAD	PREWIRED 9'	PREWIRED 9'	PREWIRED 9'	PREWIRED 9'
MAX WATTAGE	0-120VDC/VAC	5-120 VDC/VAC	6-24 VDC	6-24 VDC
INPUT VOLTAGE	10	4	0.2	0.2
VOLTAGE DROP		2	0.5	0.5
LED	N/A	YES	YES	YES

Repair Kits (Round and Square Cylinders)

Round

Bore	Buna	Viton	Low Temp	Low Friction	Low Friction + Viton	Low Friction + Low Temp
1-1/8"	RKSC11-B	RKSC11-V	RKSC11-Q	RKSC11-L	RKSC11-N	RKSC11-M
1-1/2"	RKSC15-B	RKSC15-V	RKSC15-Q	RKSC15-L	RKSC15-N	RKSC15-M
2"	RKSC20-B	RKSC20-V	RKSC20-Q	RKSC20-L	RKSC20-N	RKSC20-M
2-1/2"	RKSC25-B	RKSC25-V	RKSC25-Q	RKSC25-L	RKSC25-N	RKSC25-M
3"	RKSC30-B	RKSC30-V	RKSC30-Q	RKSC30-L	RKSC30-N	RKSC30-M
4"	RKSC40-B	RKSC40-V	RKSC40-Q	RKSC40-L	RKSC40-N	RKSC40-M

Square mm(n)

12 (1/2)	RKM012-V
16 (5/8)	RKM016-V
20 (3/4)	RKM020-V
25 (1)	RKM025-V
32 (1-1/4)	RKM032-V
40 (1-1/2)	RKM040-V
50 (2)	RKM050-V
63 (2-1/2)	RKM063-V
80 (3-1/4)	RKM080-V
100 (4)	RKM100-V

Flow Controls

Features

In-Line, Composite

- Four Stage, tapered needle design provides infinite control settings.
- Composite body is tough and corrosion resistant.
- Color-coded micrometer & calibrated adjustment knob provide instant reference points for repeat settings. Press red locking ring down prevents adjustment. Tamper resistant wire supplied in package.
- Units are threaded for easy remote panel mounting. Order panel nuts below.
- Needle Valve is available with stainless steel needle & inserts. Order 104104-NS2.

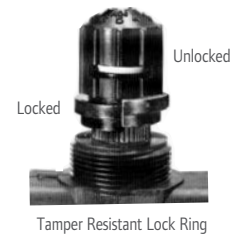

Ordering

Position			1	2
Example:	104104	-	X	XX

Position 1 Valve Type	Position 2 Port Size	
C - Check Valve	01 - 1/8-27 NPTF	S2* - 1/4-18 NPTF
F - Flow Control	02 - 1/4-18 NPTF	Stainless Steel inserts & stem & viton seals
N - Needle Valve	03 - 3/8-18 NPTF	
	04 - 1/2-14 NPTF	
	06 - 3/4-14 NPTF	* Available on needle valve only.

Panel Mounting Nuts	Port Size
104096	1/8" & 1/4"
104094	3/8", 1/2" & 3/4"

Performance Specifications

Operating Pressure:
200 PSI (13.8 bar)

Operating Temperature:
0° to 200°F (-18° to 93°C)

Flow:
100 PSI Inlet

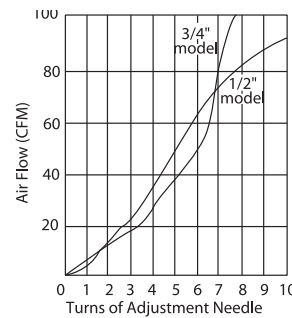
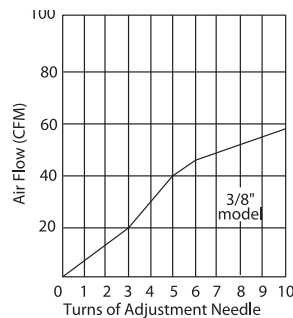
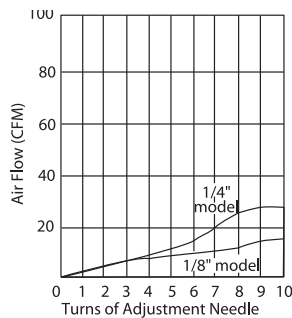

Dimensional Data

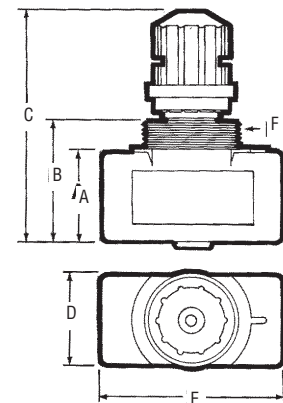
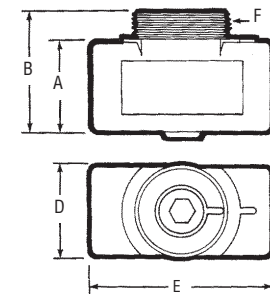
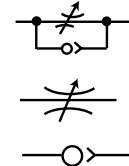

Model	Port* NPT(F)	A Inches (mm)	B Inches (mm)	C Inches Min. Max.	D Inches (mm)	E Inches (mm)	F Inches (mm)
01	1/8-27	15/16 (23.8)	1-11/32 (34.1)	2-33/64 (63.9) 2-53/64 (71.6)	15/16 (23.8)	1-29/32 (48.4)	1-20 UNEF-2A
02	1/4-18	15/16 (23.8)	1-11/32 (34.1)	2-33/64 (63.9) 2-53/64 (71.6)	15/16 (23.8)	1-29/32 (48.4)	1-20 UNEF-2A
03	3/8-18	1-5/16 (33.3)	1-11/16 (42.9)	3-23/64 (85.3) 3-55/64 (97.8)	1-5/16 (33.3)	2-27/32 (72.2)	1-3/16-18 UNEF-2A
04	1/2-14	1-5/16 (33.3)	1-11/16 (42.9)	3-23/64 (85.3) 3-55/64 (97.8)	1-5/16 (33.3)	2-27/32 (72.2)	1-3/16-18 UNEF-2A
06	3/4-14	1-9/16 (39.7)	2 (50.8)	3-43/64 (93.3) 4-11/64 (105.7)	1-9/16 (39.7)	3 (76.2)	1-3/16-18 UNEF-2A

Flow Controls

Features

- 360° swivel eases tube alignment. Preapplied thread sealant eliminates PTFE taping.
- Choose threaded or instant tube fitting inlets; slotted or knob flow adjustment.
- Sturdy components include nickel-plated brass body, black anodized aluminum swivel, Buna-N seals and a stainless steel spring.
- Ready for installation on all ARO and competitive cylinders.



Ordering

Slotted Adjust		Knob Adjust	
119307-XXX	119309-XXX	119308-XXX	119310-XXX
Male x Female thd	Male thd x fitting	Male x Female thd	Male thd x fitting
Description	Description	Description	Description
XXX Male x Female	xxx Male x Tubing	xxx Male x Female	XXX Male x Tubing
103 10-32x10-32	103 10-32 x 5/32"	125 1/8" x 1/8" NPT	120 1/8" x 5/32"
125 1/8" x 1/8" NPT	120 1/8" x 5/32"	250 1/4" x 1/4" NPT	125 1/8" x 1/4"
250 1/4" x 1/4" NPT	125 1/8v x 1/4"	375 3/8" x 3/8" NPT	250 1/4" x 1/4"
375 3/8" x 3/8" NPT	250 1/4" x 1/4"	500 1/2" x 1/2" NPT	255 1/4" x 3/8"
500 1/2" x 1/2" NPT	255 1/4" x 3/8"		375 3/8" x 3/8"
	375 3/8" x 3/8"		

Performance Specifications

Operating Pressure: 15-150 PSI (1-10 bar)

Operating Temperature: -32°F to 158°F

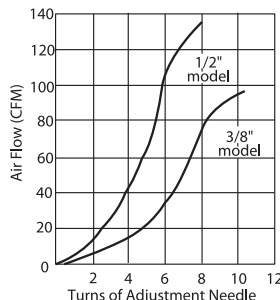
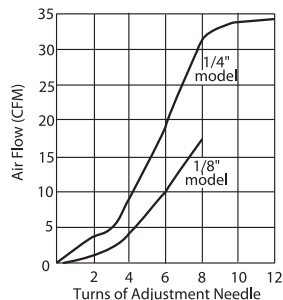
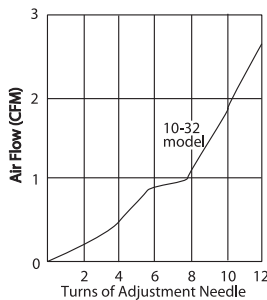

	Port Size A & B	C Inches (mm)	D Inches (mm)	E Inches (mm)	F Inches (mm)	G Inches (mm)	H Inches (mm)	I Inches (mm)	J Inches (mm)	K Inches (mm)
SLOTTED ADJUST	10/32	5/16 (8)	1/8 (3.2)	27/64 (11)	53/64 (21)	27/64 (11)	11/32 (9)	7/16 (11)	37/64 (14.7)	53/64 (21.1)
	1/8	1/2 (13)	0	25/32 (19.8)	1-17/64 (32)	19/32 (15)	19/32 (15)	33/64 (13)	47/64 (18.5)	1-3/64 (26.7)
	1/4	43/64 (17)	0	1-1/64 (25.8)	1-39/64 (41)	3/4 (19)	3/4 (19)	23/32 (18)	7/8 (22.5)	1-19/64 (32.9)
	3/8	7/8 (22)	0	1-9/64 (29)	1-27/32 (47)	29/32 (23)	29/32 (23)	29/32 (23)	1-1/8 (28.5)	1-39/64 (41)
	1/2	1-1/16 (27)	0	1-27/64 (36)	2-9/32 (58)	1-7/64 (28)	1-7/64 (28)	63/64 (25)	1-7/32 (31)	1-53/64 (46.3)
KNOB ADJUST	1/8	33/64 (13)	0	25/32 (19.8)	1-7/8 (47.5)	19/32 (15)	19/32 (15)	33/64 (13)	47/64 (18.5)	1-3/64 (26.7)
	1/4	43/64 (17)	0	1-1/64 (25.8)	2-9/32 (58)	3/4 (19)	3/4 (19)	45/64 (18)	57/64 (22.5)	1-19/64 (32.9)
	3/8	7/8 (22)	0	1-9/64 (29)	2-37/64 (65.5)	29/32 (23)	29/32 (23)	29/32 (23)	1-1/8 (28.5)	1-39/64 (41)
	1/2	1-1/16 (27)	0	1-27/64 (36)	3-5/32 (80)	1-7/64 (28)	1-7/64 (28)	63/64 (25)	1-7/32 (31)	1-53/64 (46.3)

Dimensional Data

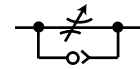

KNOB ADJUST

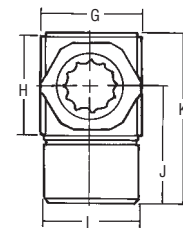
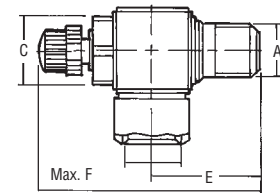

SLOTTED ADJUST

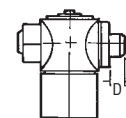
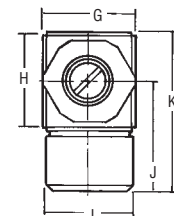
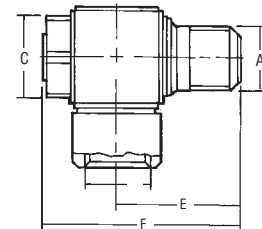

Air System Components

Overview

Filters

ARO-Flo compressed air filters are designed to remove airborne solid and liquid contaminants. Filters can be ordered with different elements, including coalescing models which are capable of removing oil aerosols and particles down to 0.3 micron. Standard filters are sold with 5-micron elements; 40-micron elements can be purchased and installed separately.



Regulators

Air line regulators provide controlled, consistent air pressure as required for specific pneumatic equipment connected to the air system. All ARO-Flo regulators are offered with a standard adjustment range of 0 – 140 psig (0 – 9.6 barg). Alternative spring ranges are offered for easy conversion to suit different requirements. Non-relieving regulators are offered for applications where the venting of downstream overpressure is undesirable.



Lubricators

ARO-Flo mist-type lubricators help ensure that pneumatic devices receive the required lubrication to maintain peak performance, reduce wear, and prolong service life. They are designed to provide the correct amount of oil required for most general applications in a pneumatic system, delivering a constant ratio of oil to air flow. Precise oil feed adjustment sets the proper oil drip rate. Lubricators should be installed close to the downstream application to ensure effective distribution of oil.



Piggyback Filters / Regulators

Filter-regulators, or “piggybacks,” combine the functions of both a filter and regulator. Piggybacks are compact and most effective when space is a constraint. Piggybacks can be ordered with different filter elements and can be modified with different springs, depending on the filtration and air regulating requirements.



Combinations

Filters, regulators, lubricators, and piggybacks can be combined together to form combinations. They are typically strung together in the F+R+L arrangement (three-piece combo) and F/R+L (two-piece combo) arrangement, although other configurations are also used depending on application needs. ARO-Flo combination FRLs are easily assembled using modular spacer kits. Panel nuts not included with units. Must be ordered separately.



Air System Components

Features

By utilizing a modular lockout valve the user can close off the downstream air supply for maintenance and pressure isolation. Units are threaded for direct plumbing or can be installed in the modular arrangement.

Optional filter life indicator works off of pressure differential to show a visible alert when the filter needs replacement.

A T-bracket wall mount is standard on all combo units.

The settable gauge fan is a visual reference that allows the user to display the specific pressure range that is needed for their application.



Use of modular threaded pipe adapters allow for ease of service by allowing a unit to be quickly removed from the air line. Adapters can be used to pipe different thread sizes in the plumbing setup.

The ARO soft-start valve allows system pressure to build gradually, protecting downstream equipment and creating a safer start-up condition.

A panel nut is standard on all individual ARO-Flo regulators and piggybacks. Must be ordered separately on combination units.

Spares and Accessories

See our accessories catalog or go to our Web site for the complete selection of accessories for your application.



Refurb kits
104302



Mounting brackets
104409



Replacement parts
104338



Pressure switch
104415

The pressure switch is typically threaded into a manifold port block, and allows the sensing of high or low pressure thresholds set by the user.

The oil drip rate is controlled by adjusting the sight dome adjustment screw in a clockwise or counter-clockwise direction.

The auto-fill option is standard on all ARO-Flo lubricators. Lubricating oil can be added while lubricators are under pressure.



The ARO-Flo check valve is typically installed downstream of the regulator. It is used to help prevent downstream pressure from moving upstream of the valve in the event of upstream pressure loss.

The positive locking thumb switch engages with an audible click, and visually aligns to the locking symbols.

Optional tamper kit installs in seconds and prevents adjustment of the regulated pressure.

The installation of a manifold port block enables design flexibility by allowing clean, regulated air to be diverted to other applications.



Gauges
104334

Manifold block kit
104413-3-2

Lubricating oil
29665

1000 Series



1000 Series

1/8" and 1/4" Ports

Max flow: 59 scfm
Series size: Miniature

1500 Series



1500 Series

1/4" and 3/8" Ports

Max flow: 113 scfm
Series size: Compact

2000 Series



2000 Series

3/8", 1/2", and 3/4" Ports

Max flow: 222 scfm
Series size: Standard

3000 Series



3000 Series

3/4" and 1" Ports

Max flow: 368 scfm
Series size: Heavy-Duty

Super-Duty Series



Super-Duty Series

1", 1-1/4", 1-1/2", 2" and 3" Ports

Max flow: 1,770 scfm

Specialty Items



Specialty Items

1/8", 1/4", 3/8", 1/2", and 3/4" Ports

Specialty line

Air System Components

Selection

When selecting an FRL or individual filter, regulator and lubricator units, the air consumption of the tools or equipment to be serviced should be correlated with the flow capacity of the FRL. ARO Filters, Regulators and Lubricators are designed to flow in excess of that indicated in the maximum recommended flow table shown below. This table gives recommended flows for pipe sizes at listed pressures and should be used as a guide in sizing piping and equipment for compressed air systems.

Maximum recommended air flow (scfm) thru ANSI standard weight

Applied Pressure PSIG	Nominal Standard Pipe Size — Inches										
	1/8"	1/4"	3/8"	1/2"	3/4"	1"	1-1/4"	1-1/2"	2"	2-1/2"	3"
5	0.5	1.2	2.7	4.9	6.6	13	27	40	80	135	240
10	0.8	1.7	3.9	7.7	11.0	21	44	64	125	200	370
20	1.3	3.0	6.6	13.0	18.5	35	75	110	215	350	600
40	2.5	5.5	12.0	23.0	34.0	62	135	200	385	640	1100
60	3.5	8.0	18.0	34.0	50.0	93	195	290	560	900	1600
80	4.7	10.5	23.0	44.0	65.0	120	255	380	720	1200	2100
100	5.8	13.0	29.0	54.0	80.0	150	315	470	900	1450	2600
150	8.6	20.0	41.0	80.0	115	220	460	680	1350	2200	3900
200	11.5	26.0	58.0	108.0	155.0	290	620	910	1750	2800	5000
250	14.5	33.0	73.0	135.0	200	370	770	1150	2200	3500	6100

The flow values in the chart above are based upon a pressure drop (ΔP) as set forth in

Pressure Drop (ΔP) per 100 ft. of Pipe	Pipe Size — Inches
10% of Applied Pressure	1/8, 1/4, 3/8, 1/2
5% of Applied Pressure	3/4, 1, 1-1/4, 1-1/2, 2, 2-1/2, 3

Installation

The filter, regulator and lubricator should be installed in the order shown in the illustration below.

If a coalescing filter is required, it should be installed downstream from a standard filter. Individual take-off lines to the FRL and air tool or equipment should be from the top of the compressed air line. Make sure that air flow markings are followed for proper flow direction through the FRL units.

To trap and expel water, sludge and other contaminants which may collect on the bottom of the air line, a drip leg drain should be used. Drip leg drains should be installed at low points in the piping system and at the far end of the distribution system.

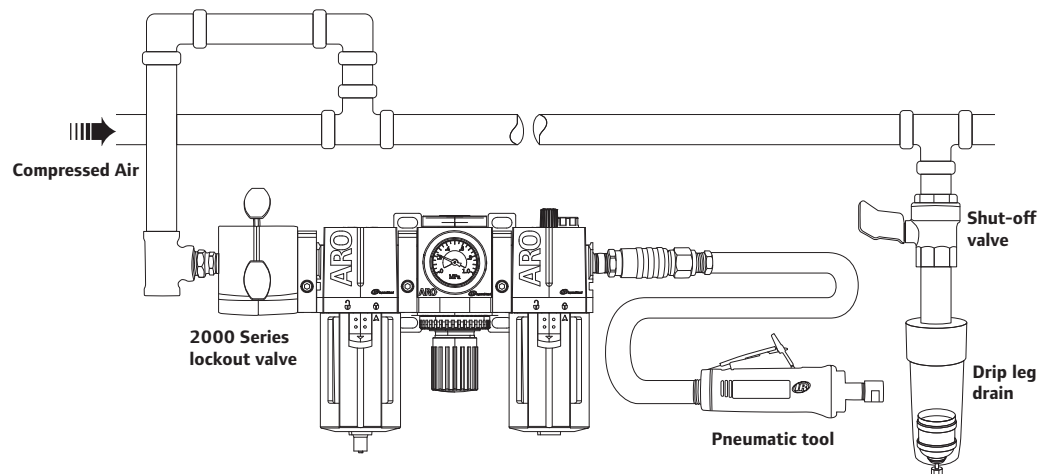

General Information

Warnings

Harmful Compressor Oils & Other Materials

Some oils used in air compressors contain chemicals harmful to Buna-N seals, if not adequately filtered at the compressor. The most common of these oils, in addition to other harmful material, are listed below.

Compressor Oils	Compressor Oils	Other Materials
Cellulube No. 150 & 220	Phrano	Garlock No. 98403 (Polyurethane)
Haskel No. 568-023	Pydraul AC	Parco No. 3106 (Neoprene)
Houghton & Co. Oil No. 1120, No. 1130, No. 1055	Sears Regular Motor Oil Sinclair Oil "Lily White" (Polyurethane)	Some Loctite Compounds Stillman No. SR269-75
Houtosafe 1000	Skydrol	Stillman No. SR513-70 (Neoprene)
Kano Kroil	Tenneco Anderol No. 495	CAUTION: Compounded oils containing graphite and fillers are not recommended for use with cylinders.
Keyston Penetrating Oil No. 2 & No. 500 Oils		
Marvel Mystery Oil		

Air and Lubrication Requirement

Air Pressure: Limited to 200 psig (14 bar)* FILTRATION: 40 Micron. Proper moisture removal and filtration of contaminants will promote good service life and operation. Install an air regulator to control the operating pressure, insure smooth operation and conserve energy.

Lubrication: All ARO® Cylinders are lubricated at the factory. This lubrication should provide satisfactory operation and cycle life. For maximum performance and life expectancy, standard air line lubrication should be used. If air line cylinders or other air line devices, used in conjunction with ARO® valve, require lubrication, be sure the lubricating oils used are compatible with the valve seals and are of sufficient viscosity to assure adequate lubrication. ARO® recommends an oil lubricant with a viscosity of 100-200 SUS at 100° F and an airline point above 200° F.

NOTICE: The use of compound oils containing graphite filters, extremely low viscosities and other non-fluid lubricants is not recommended.

RECOMMENDED: ARO 29665 air line lubricator oil is available in one quart containers.

WARNING

The following are hazards or unsafe practices which could result in severe personal injury, death or substantial property damage. Heed the following. Use safeguards. Insure that provisions are made to prevent the valve from being accidentally operated (actuated.)

Hazardous Air Pressure. Shut off, disconnect and relieve any trapped air pressure from system before performing service or maintenance.

Hazardous Voltage. Do not attempt any service without disconnecting all electrical supply sources.

* Provenair Cylinder inlet is up to 250-psi (17-bar)

General Information

To obtain information or to receive technical literature for specific cylinders: contact ARO® Customer Service at (800) 495-0276 or contact your nearest ARO® distributor. Selected parts are provided in kit form. The ARO® Parts List/Service Instructions contain Repair Kit information and complete Service Parts information and are available upon request. Order Manuals as shown. The following Operator's Manuals are available.

Operator's Manual	Part Number
ARO® Cylinders	119999-27
Provenair	119999-30
Econoair	119999-16
Microair	119999-41
Premair Compacts	119999-78
Provenair Tanks	119999-032

Cylinder Warranty

Five Year Product Warranty

The ARO® Cylinders, in this catalog are backed up by our famous 5-year warranty, as a measure of the confidence we place in the quality of these products. A confidence that you can share.

Ingersoll Rand/ARO warrants to the original use purchaser of Ingersoll Rand/ARO® manufactured cylinders that Ingersoll Rand/ARO will repair or replace, free of charges, including return shipping costs within the Continental United States of America, any such product which under normal use and service proves defective in material or workmanship, as determined by Ingersoll Rand/ARO Inspection, within FIVE YEARS from date of shipment from Ingersoll Rand/ARO, provided the claimed defective product, or part thereof, is promptly returned to the Ingersoll Rand/ARO factory or Ingersoll Rand/ARO authorized warranty repair center with transportation prepaid.

This warranty does not cover failure of parts or components due to normal wear or damage, which in the judgment of Ingersoll Rand/ARO, arises from misuse, abrasion, corrosion, negligence, accident, substitution of non-Ingersoll Rand/ARO® parts, faulty installation or tampering.

If Ingersoll Rand/ARO Inspection discloses no defect in material or workmanship, repair or replacement and return will be made at customary charges.

Equipment not covered by Ingersoll Rand/ARO warranty: accessories or components of equipment sold by Ingersoll Rand/ARO that are not manufactured by Ingersoll Rand/ARO (such as switches, hoses, gasoline engines, etc.) are subject to the warranty, if any, of their manufacturer. Ingersoll Rand/ARO will provide the purchaser with reasonable assistance in making such claims.

The foregoing warranty supersedes, voids and is in lieu of all or any other warranties, express or implied, and no warranty or merchantability or fitness for particular purpose is intended or made. Ingersoll Rand/ARO's sole obligation and the original use purchaser's sole remedy is as stated above and in no event shall Ingersoll Rand/ARO be liable for any special, direct, indirect, incidental, consequential or other damages, or expenses of any nature including, without limitation, loss of profits or production time incurred by the original use purchaser or any other party.



Distributed by:

www.AROzone.com

arotechsupport@irco.com

youtube.com/aropumps

(800) 495-0276

ARO®

ARO® is a brand of Ingersoll Rand. Ingersoll Rand (NYSE:IR) advances the quality of life by creating comfortable, sustainable and efficient environments. Our people and our family of brands—including Club Car®, Ingersoll Rand®, Thermo King® and Trane®—work together to enhance the quality and comfort of air in homes and buildings; transport and protect food and perishables; and increase industrial productivity and efficiency. We are a \$14 billion global business committed to a world of sustainable progress and enduring results. For more information, visit www.ingersollrand.com.