



## PoKeys plugin for Mach3

---

Version: 9/8/2018

## SAFETY INFORMATION



This product is intended for integration by the user into a computer numerical control (CNC) machine. It is the user's responsibility to assess the overall system design and address all safety considerations that affect the users and equipment. The user assumes all responsibility for system design, including compliance with regulatory standards and codes issued by the applicable entities. PoLabs do not make any claims as to the suitability of this equipment for the user's application. Serious personal injury or equipment damage can occur from the improper integration, installation or operation of this product.

This product is not guaranteed to be fail-safe. The system that this equipment is used with shall be fitted with a separate means of fail-safe protection, emergency-stop capability and/or system power removal. This equipment may be connected to dangerous power sources, including electrical power sources. Dangerous voltage levels may be present at this equipment or at connected devices. Measures must be taken to prevent persons from contacting voltage sources which may be present. Equipment should be housed inside an enclosure suitable for the intended environment. Safety interlocks should be provided to prevent any and all dangers to personnel.

CNC machine tools are inherently dangerous, and can cause injury to operators and maintenance personnel. Operators and maintenance personnel shall be properly trained in the safe use, operation and maintenance of such machines. Automated machines that this equipment may be used with can move at any time. All persons exposed to such machines must understand the dangers that are present.

### Introduction

PoKeys56 and PoKeys57 series devices feature PoKeys ‘Pulse engine’, an interface that enables the device to produce step and direction signals for stepper or servo motors. The plugin for Mach3 is an interface between the Mach3 software and the PoKeys device.

This manual describes how the plugin for Mach3 is installed and configured.

### Table of contents

Introduction.....	3
Table of contents.....	3
Pulse engine hardware options.....	5
PoKeys57CNC .....	5
PoKeys57CNCdb25 .....	5
PoKeys56 and PoKeys57 series general purpose devices .....	6
Option 1: Integrated pulse generator - up to 3 axes at 25 kHz step frequency .....	6
Option 2: Simple external pulse generator - up to 8 axes at 125 kHz step frequency.....	7
Option 3: External pulse generator with dedicated IO capability - up to 8 axes at 125 kHz step frequency.....	7
10-pin motor driver connector pinout .....	9
Dedicated axis switch inputs .....	9
Relay outputs.....	9
Open-collector outputs .....	10
0-10 V voltage output.....	10
Additional digital inputs .....	10
PoKeys Mach3 plugin .....	11
Installing plugin .....	11
PoKeys Mach3 plugin functionality .....	11
Plugin configuration .....	12
Step-by-step installation .....	13
Installing Mach3 .....	13
Creating profile.....	13
Enabling the PoKeys plugin .....	14
New PoKeys devices .....	14
PoKeys57CNC and PoKeys57CNCdb25 .....	14
Other PoKeys devices .....	14
Enabling Pulse engine.....	16

## PoKeys Pulse engine v2 documentation

Motors/axis setup .....	17
PoKeys device pinout .....	18
Axis switches configuration .....	19
Setting up digital inputs and outputs mapping .....	20
Pendant mode .....	21
PoPendant configuration.....	22
Encoder (MPG) settings.....	23
MPG (manual pulse generator) setup .....	23
PoKeys IO status .....	28
Other (miscellaneous) settings.....	28
Reading and writing of IO from VB script.....	32
Example script (finds the PoKeys device with the serial number 25000, then toggles the IO 1 on and off at a rate of 1 Hz): .....	32
Additional OEM buttons.....	34
Additional OEM LEDs.....	34
Pulse engine v2 operating principles.....	35
Modes of operation.....	36
Safety charge-pump output .....	37
Motor driver enable outputs.....	37
Axis parameters.....	37
Custom external pulse generator without IO functionality .....	37
Pulse engine limitations: .....	38
Frequently asked questions .....	39

## Pulse engine hardware options

There are a few possibilities on how PoKeys hardware can be used to generate the step and direction signals.

### PoKeys57CNC

PoKeys57CNC devices feature an integrated pulse generator for 8 axes. See the products user manual for more information on the device.

**In Mach3 settings, the following option must be selected for pulse generator type:** External 6ch with IO



### PoKeys57CNCdb25

PoKeys57CNCdb25 devices feature an integrated pulse generator for 4 axes. See the products user manual for more information on the device.

**In Mach3 settings, the following option must be selected for pulse generator type:** External 4ch without IO



## PoKeys56 and PoKeys57 series general purpose devices

Devices: PoKeys56U, PoKeys56E, PoKeys57U and PoKeys57E

### Option 1: Integrated pulse generator - up to 3 axes at 25 kHz step frequency

**Pulse generator type:** Internal/integrated 3ch

Pin	Function
38	Direction output – x
39	Direction output – y
40	Direction output – z
46 !	Step output – x
48 !	Step output – y ( <b>external 470 <math>\Omega</math> pull-up resistor required</b> )
49 !	Step output – z ( <b>external 470 <math>\Omega</math> pull-up resistor needed</b> )
52	Emergency switch input
53	Safety charge pump 5 kHz output

Inputs for limit, home and probing switches can be freely connected to any PoKeys pin and configured in software.

### Remarks:

- **Watch for pin 47! It is not used for step output!**
- **All switch inputs expect normally closed (NC) switches and must be connected between specified PoKeys input pin and ground.**
- **We advise adding an additional 1 k $\Omega$  pull-up resistor on pins with an external switch**
- **Emergency switch must be connected in such way so that it cuts the power supply to the motors when the switch is activated.**

### External pull-up resistor wiring for pins 48 and 49

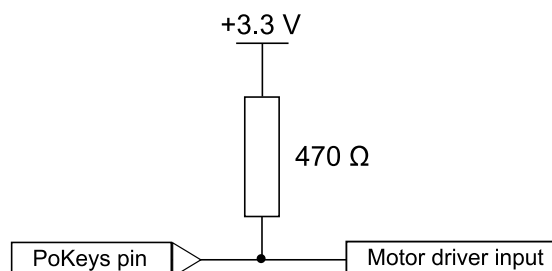

## PoKeys Pulse engine v2 documentation

### Option 2: Simple external pulse generator - up to 6 axes at 125 kHz step frequency<sup>1</sup>

**Pulse generator type:** External 4/6ch without IO

A device such as PoExtBusOC16CNC can be connected to PoKeys device as indicated in the table below. This device enables the PoKeys device to drive up to 8 axes (6 axes in Mach3) with 125 kHz step frequency.

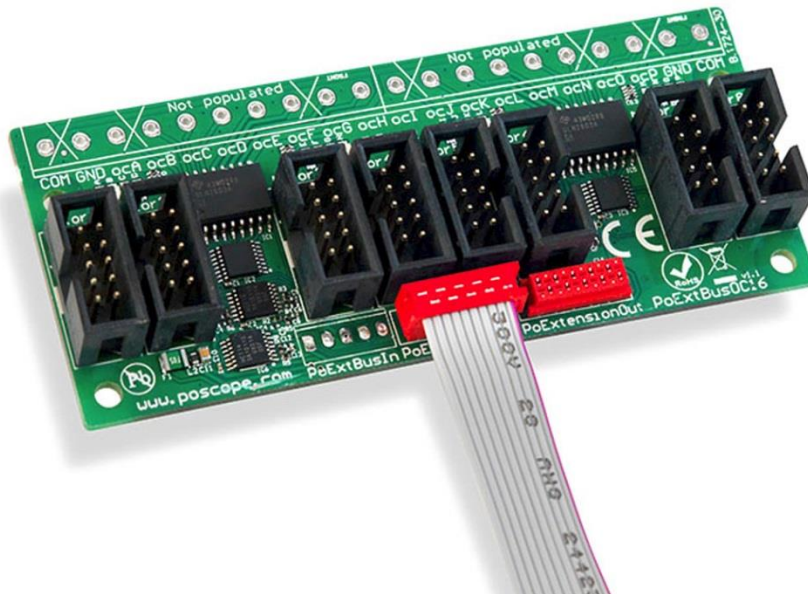

Pin	Description	PoKeys56U/57U	PoKeys56E/57E
		pin	pin
<b>1</b> <b>(red)</b>	5 V power supply	5 V	5 V
2	PoKeys ground	GND	GND
3	Enable signal for axes 1-8	any pin	any pin
4	Unused		
5	Unused		
6	Unused		
7	Unused		
8	Signal for pulse generation	<b>23</b>	<b>9</b>
9	Signal for pulse generation	<b>25</b>	<b>11</b>
10	Signal for pulse generation	<b>26</b>	<b>51</b>

### Option 3: External pulse generator with dedicated IO capability - up to 8 axes at 125 kHz step frequency<sup>2</sup>

**Pulse generator type:** External 4/6ch with IO

<sup>1</sup> Note that PoKeys Mach3 plugin supports only 6 axes

<sup>2</sup> Note that PoKeys Mach3 plugin supports only 6 axes

**The PoKeys CNC addon devices are not available any more in 2016 - see PoKeys57CNC device**

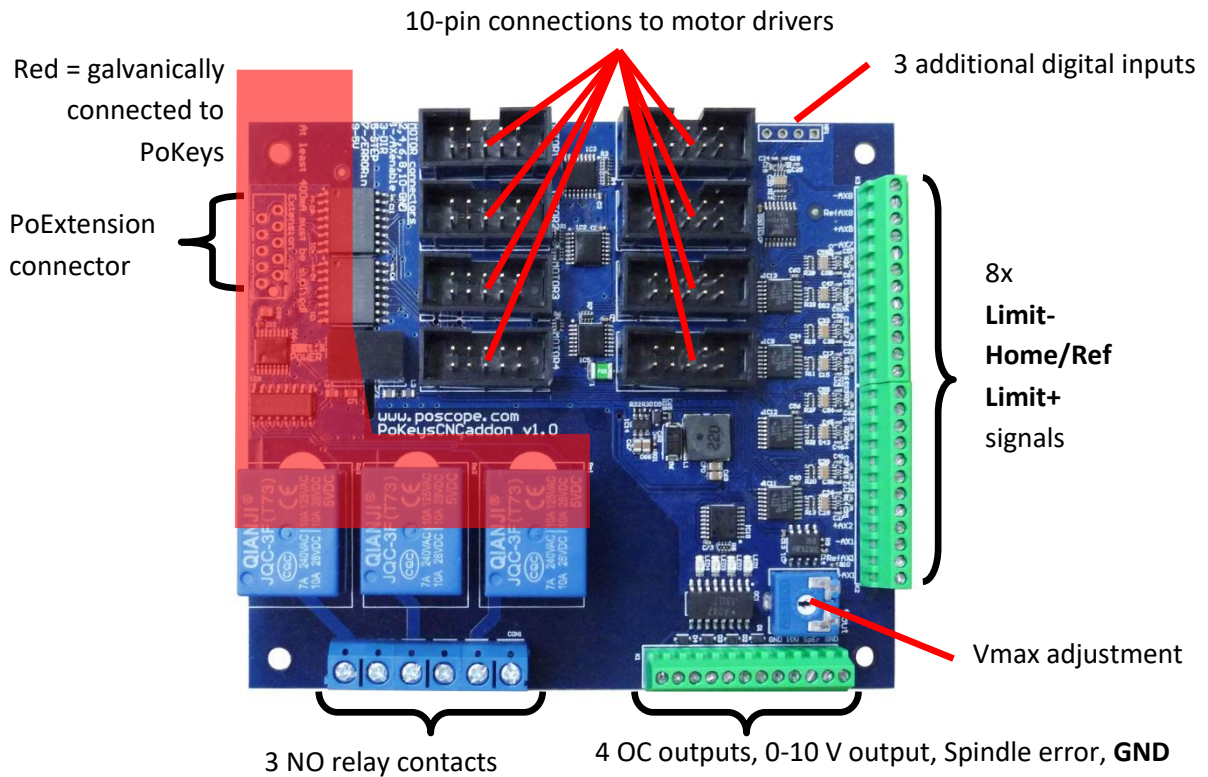

Please pay attention to connecting the PoKeysCNCaddon to PoKeys device. PoKeysCNCaddon connects to PoKeys using the Expansion port flat cable, attached to the board. The Expansion port signals should be connected to PoKeys as follows:

Pin	Description	PoKeys56U/57U	PoKeys56E/57E
		pin	pin
<b>1 (red)</b>	5 V power supply to the PoKeysCNCaddon - <b>must supply at least 400 mA for correct operation</b>	5 V	5 V
2	PoKeys ground ( <b>not to be used for PoKeysCNCaddon IO</b> )	GND	GND
3	PWM signal for 0-10 V output	17-22	17-22
4	Signal for IO capabilities (output)	38	38
5	Signal for IO capabilities (output)	37	37
6	Signal for IO capabilities (output)	36	36
7	Signal for IO capabilities (input)	35	35
8	Signal for pulse generation	<b>23</b>	<b>9</b>
9	Signal for pulse generation	<b>25</b>	<b>11</b>
10	Signal for pulse generation	<b>26</b>	<b>51</b>



## PoKeys Pulse engine v2 documentation

### 10-pin motor driver connector pinout

Pin	Function
1	Axis enable output
3	Direction output
5	Step output
7	Error input
2, 4, 6, 8, 10	GND
9	Not connected

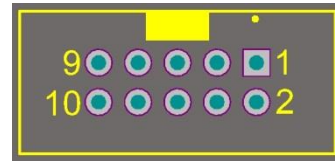

### Dedicated axis switch inputs

All inputs have built-in pull-up resistor - switches must be connected between **GND (on the PoKeysCNCaddon)** and the corresponding input. Select 'Dedicated pin' in the axis settings.

-AX8	
RefAX8	
+AX8	
-AX7	
RefAX7	
+AX7	
-AX6	
RefAX6	
+AX6	
-AX5	
RefAX5	
+AX5	
-AX4	
RefAX4	
+AX4	
-AX3	
RefAX3	
+AX3	
-AX2	
RefAX2	
+AX2	
-AX1	
RefAX1	
+AX1	

Pin (from top to bottom)	Function
-AX8	Limit- for axis 8
RefAX8	Ref/home for axis 8
+AX8	Limit+ for axis 8
-AX7	Limit- for axis 7
RefAX7	Ref/home for axis 7
+AX7	Limit+ for axis 7
-AX6	Limit- for axis 6
RefAX6	Ref/home for axis 6
+AX6	Limit+ for axis 6
-AX5	Limit- for axis 5
RefAX5	Ref/home for axis 5
+AX5	Limit+ for axis 5

Pin (continued)	Function
-AX4	Limit- for axis 4
RefAX4	Ref/home for axis 4
+AX4	Limit+ for axis 4
-AX3	Limit- for axis 3
RefAX3	Ref/home for axis 3
+AX3	Limit+ for axis 3
-AX2	Limit- for axis 2
RefAX2	Ref/home for axis 2
+AX2	Limit+ for axis 2
-AX1	Limit- for axis 1
RefAX1	Ref/home for axis 1
+AX1	Limit+ for axis 1

### Relay outputs

PoKeysCNCaddon board features 3 relay outputs with normally-open contacts.

Rating:

- max. 7A/240VAC, max. 10A/125VAC or max. 10A/28VDC.

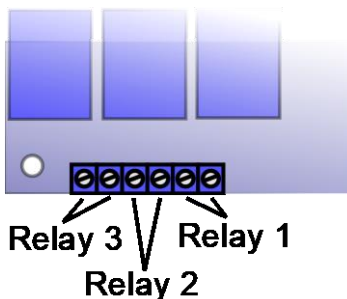

## PoKeys Pulse engine v2 documentation

### Open-collector outputs

PoKeysCNCaddon board features 4 open-collector outputs with LEDs for signaling the output state.

Rating:

- Maximum applied voltage: 80 V
- Maximum DC current: up to 50 mA

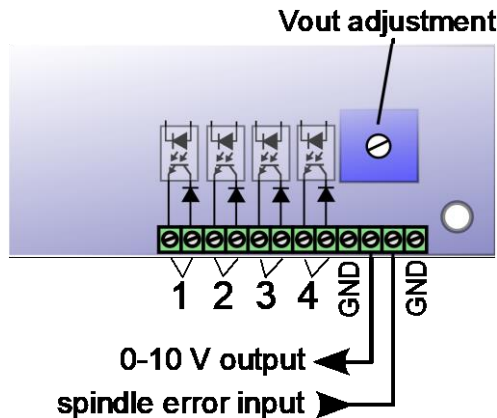

### 0-10 V voltage output

PWM signal is used to create the 0-10 V voltage output. PWM signal with 0% duty cycle produces 0 V on output, while 100% duty cycle produces  $V_{max}$  on output.  $V_{max}$  can be adjusted using the potentiometer 'Vout'.

In order to convert PWM signal to an analog output, a low-pass filter with the time constant of 1 ms is applied to the source signal. In order to avoid ripples in the analog output, use PWM frequency of 10 kHz or more.

**Setup/calibration:** either set the duty cycle to 100% or connect the PWM signal input to PoKeysCNCaddon board (pin 3) to +3.3V. Use the multimeter to measure voltage between GND and 0-10 V output. Use the Vout adjustment potentiometer to adjust the voltage to 10 V (

### Additional digital inputs

There are 4 additional digital inputs: spindle error input and 3 general purpose external digital inputs, available on the top right corner of the PoKeysCNCaddon board.

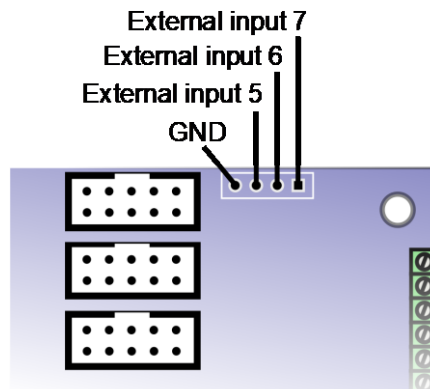

### PoKeys Mach3 plugin

#### Installing plugin

In order to install PoKeys Mach3 plugin, simply copy the Pokeys.dll to the Mach3 plugin folder (by default C:\Mach3\Plugins\).

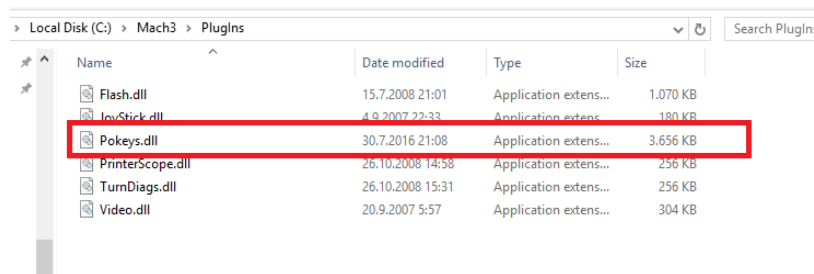

No additional resources are necessary for the plugin to operate.

However, we suggest installing PoKeys setup package which contains:

- Dedicated USB driver for PoKeys devices
- PoKeys configuration application for updating the firmware and pairing PoNET devices (kbd48CNC)

#### PoKeys Mach3 plugin functionality

- Support for up to 6-axis CNC machine
- Support for all PoKeys devices
- Mapping of PoKeys digital inputs to Mach3 OEM LEDs and OEM buttons
- Mapping of Mach3 OEM LEDs to PoKeys digital outputs
- Mapping of PoKeys encoders to Mach3 DROs
- Support for matrix keyboard
- Support for kbd48CNC keyboard on I2C address 1
- Support for PWM outputs
- Support for alphanumeric LCD display
- Support for analog inputs (analog joystick, analog to DRO mapping, offsets and gains adjustment, automatic calibration)
- Support for IO mapping (Mach3 native input-output pins, additional 100 Mach3 IO device pins - device name PoKeys\_{serial number})
- Support for pendant with the activation switch
- Spindle speed measurement
- Usage of PoKeys Pulse engine (available on PoKeys56U and Pokeys56E devices) as external motion controller for Mach3
- Safety charge pump output on pin 53
- Soft-limits and limit-override support
- Probing support
- Experimental support for torch height controller

## PoKeys Pulse engine v2 documentation

### Plugin configuration

The PoKeys plugin configuration is stored in separate PoKeysMachConfig.xml file in the *AppData\Local* folder in your system.

## Step-by-step installation

### Installing Mach3

Install latest version of Mach3 (Mach3 R3.043.066) with default settings (install to C:\Mach3). Parallel port driver installation is optional.

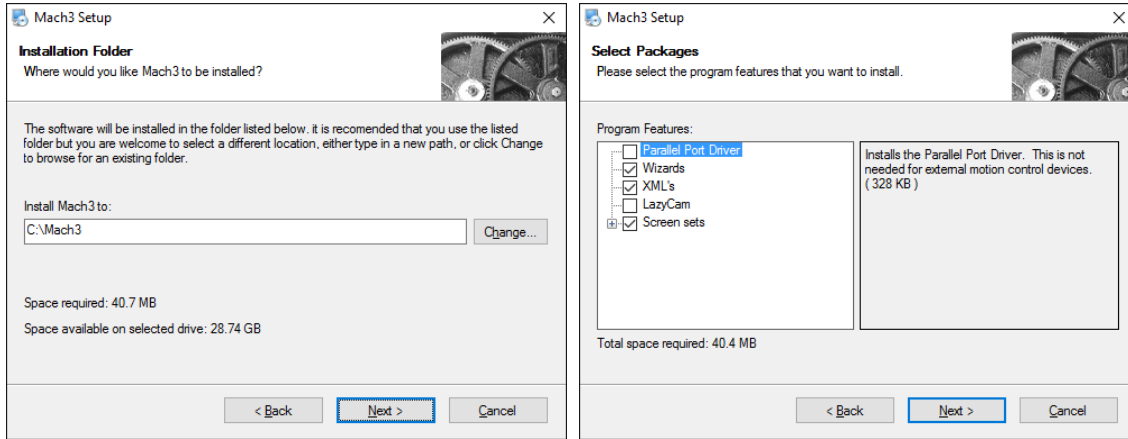

### Creating profile

Start Mach3 loader and select 'Create profile'. Create new profile and select it in the next step.

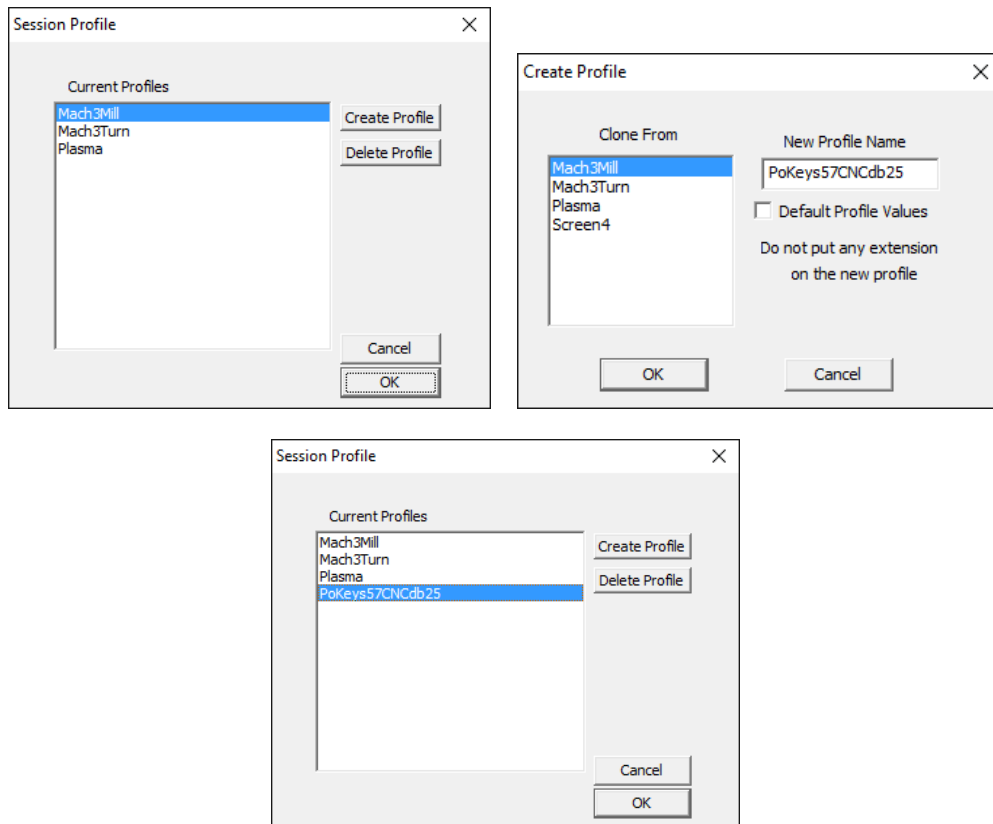

## PoKeys Pulse engine v2 documentation

### Enabling the PoKeys plugin

Open Mach3 and go to Config -> Config plugins.. The following dialog will appear.

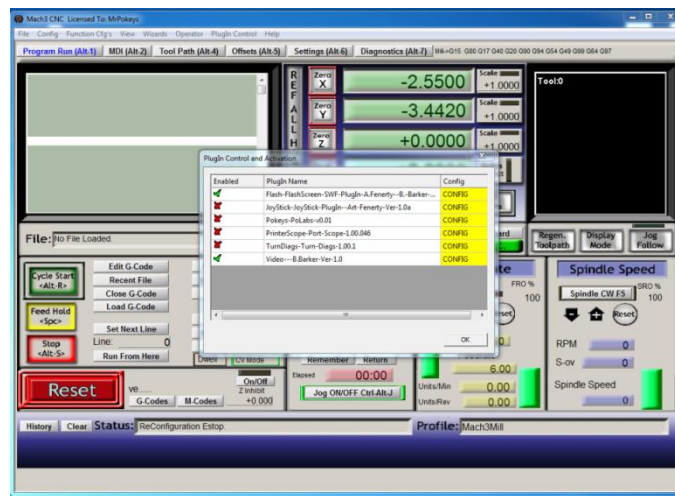

Enable the PoKeys-Polabs plugin by clicking on the red cross. We suggest to restart Mach3.

### New PoKeys devices

#### PoKeys57CNC and PoKeys57CNCdb25

On first start, PoKeys plugin for Mach3 will search for PoKeys devices and if PoKeys57CNC or PoKeys57CNCdb25 device is found, the device will be automatically configured for operation. If needed, you will be prompted to restart Mach3 to complete the install.

#### Other PoKeys devices

Other PoKeys devices must be manually configured. Open Plugin control menu and select option PoKeys plugin settings.... You can also access the same dialog via Config -> Config plugins and clicking on yellow 'CONFIG' field, as shown below.

**Note: if Plugin control menu is empty, check that the PoKeys plugin is enabled.**

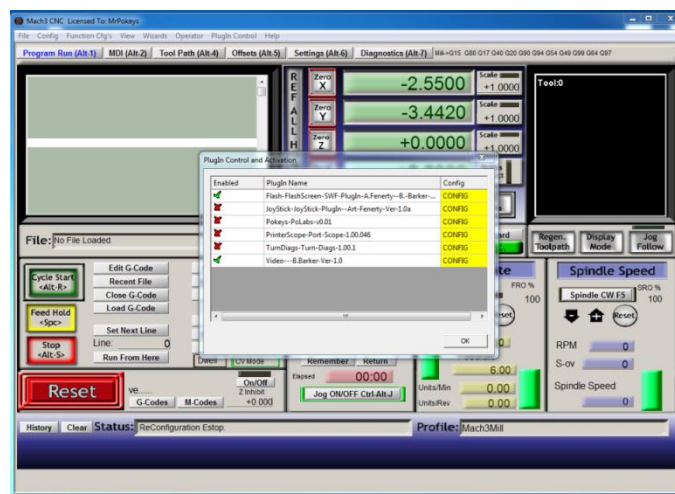

Click CONFIG to start configuring the plugin. PoKeys plugin support multiple PoKeys devices (PoKeys55, PoKeys56U and PoKeys56E). To add a new device configuration, click the 'Add new' button and select the PoKeys device (as illustrated in the image below).

## PoKeys Pulse engine v2 documentation

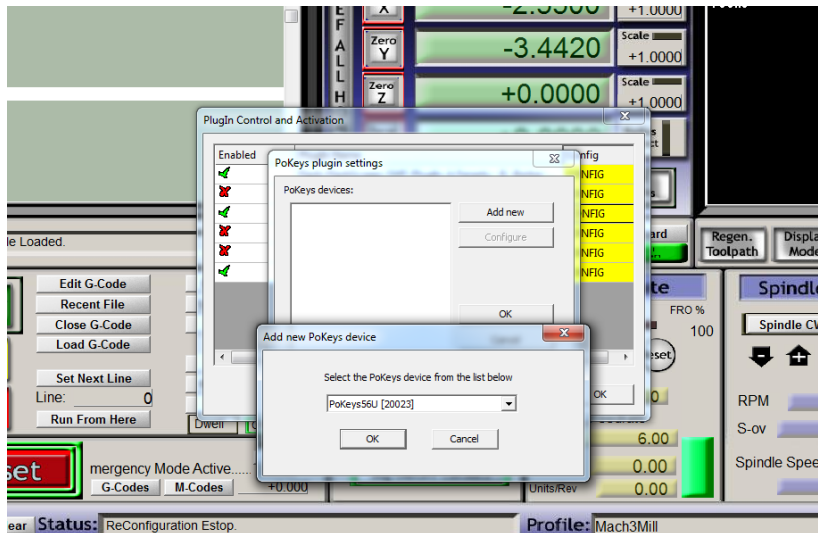

After new device configuration is added, **Mach3 MUST BE RESTARTED!**

After restart, the option 'Configure' is enabled. This opens the device configuration dialog where user can configure the device. The same can be achieved using a dedicated device menu entry in the Mach3 Plugin Control menu.

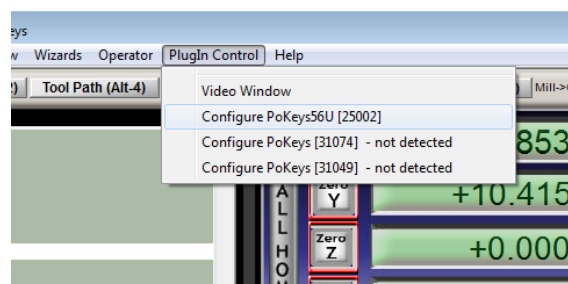
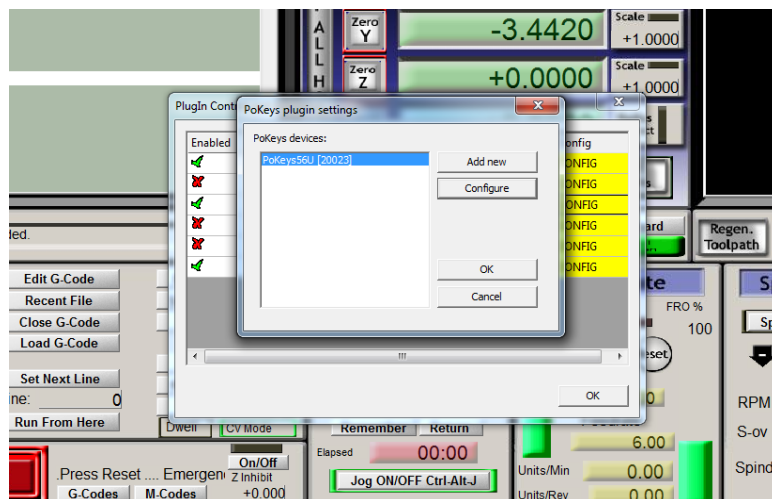

## PoKeys Pulse engine v2 documentation

### Enabling Pulse engine

In order to use Pulse engine support, go to device configuration, switch to 'Pulse engine' tab and enable one of the following options:

- Integrated 3ch: use the integrated pulse engine support in PoKeys56U and PoKeys56E. This option supports step frequencies up to 25 kHz
- External 4/6ch without IO: use the pulse engine with conjunction with a simple external pulse engine adapter. This option supports step frequencies up to 125 kHz. In case of PoKeys57CNCdb25, this option is automatically preselected and cannot be changed.
- External 4/6ch with IO: use the pulse engine with PoKeysCNCaddon external boards. This option supports step frequencies up to 125 kHz. In case of PoKeys57CNC, this option is automatically preselected and cannot be changed.

**In case of PoKeys57CNC and PoKeys57CNCdb25, the correct setting will automatically be preselected by the plugin.**

After selecting one of the options above, click OK and restart Mach3 in order to allow Mach3 recognize an external motion controller.

On the next Mach3 startup, the following dialog will appear, notifying you that the motion control hardware plugin was detected. Select PoKeys-Polabs and click OK.

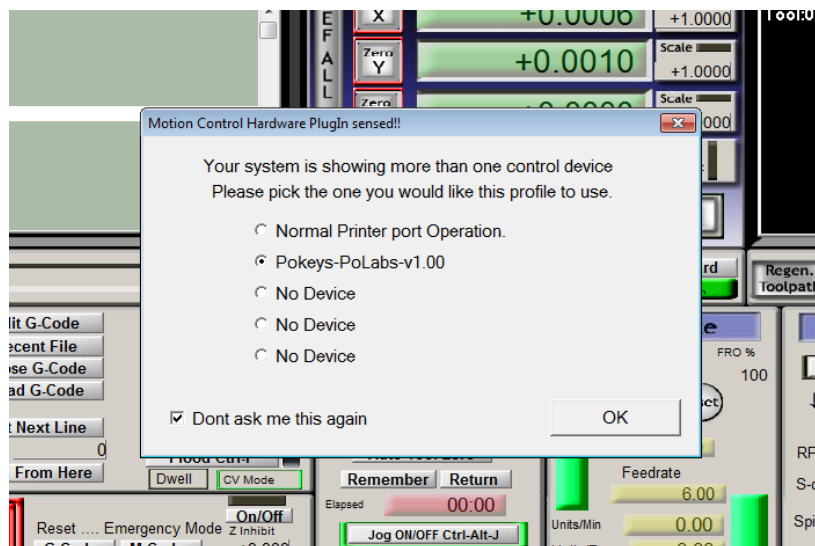

**To enable Pulse engine, the emergency switch input must be connected between pin 52 and ground. The switch must be NC (normally closed) type.**

**In case of PoKes57CNCdb25, pin 10 is used as emergency switch input.**

At this step, configure the axes as normally through Config -> Motor tuning. See below for details.



## PoKeys Pulse engine v2 documentation

### Motors/axis setup

Open Config > Ports & Pins. The following dialog will appear.

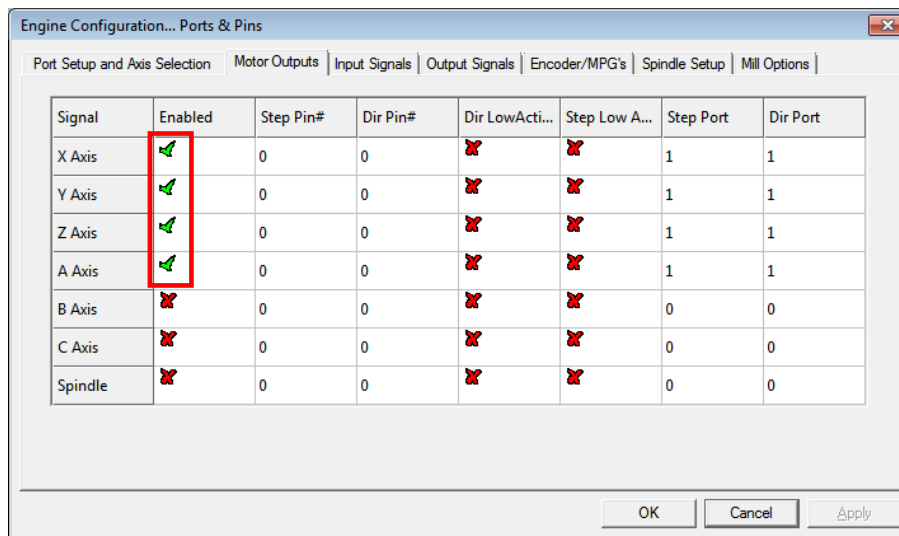

Please check that the X, Y and Z axis are enabled (enable axes A, B or C if external pulse generator with 4 or more supported axes is used). Other settings are **ignored**.

After enabling the axes, open the Motor tuning dialog (Config > Motor tuning).

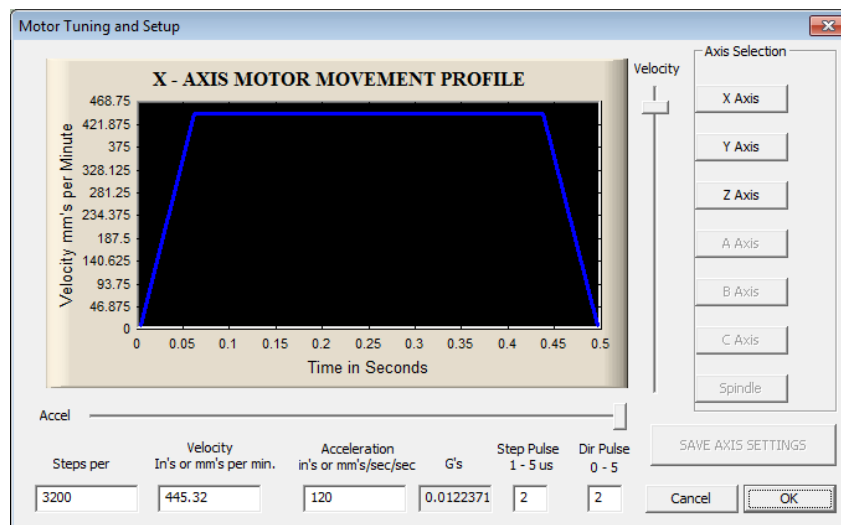

Follow the Mach3 motor tuning procedure to setup the appropriate values for 'Steps per', 'Velocity' and 'Acceleration' for each axis. The 'Step pulse' and 'Dir pulse' options are IGNORED.

To setup Home/Soft Limits, go to the menu Config > Homing/Limits. In this dialog, software limits and homing speeds can be setup. Use the 'Reversed' and 'Home neg' options to setup the axes directions. Please note that 'Slow Zone' is not supported.



## PoKeys Pulse engine v2 documentation

### Axis switches configuration

In order to configure the axis switches, open Device configuration (either via Config Plugins or via a dedicated device configuration menu in Plugin Control main menu in Mach3) and switch to Pulse engine settings tab. The following dialog appears.

There is a separate drop-down menu for each available switch. If external pulse engine with IO functionality is selected, external dedicated option can be selected in the menu for each switch or a standard PoKeys digital input pin (the latest is the only option to use when using integrated pulse engine or external pulse engine without IO functionality).

Home/ref switch has some additional options:

- **Shared with Limit-**: Limit- switch functions both as Limit- and as home position switch. During homing, Limit- functionality is temporarily disabled
- **Shared with Limit+**: same as above, but with Limit+ switch

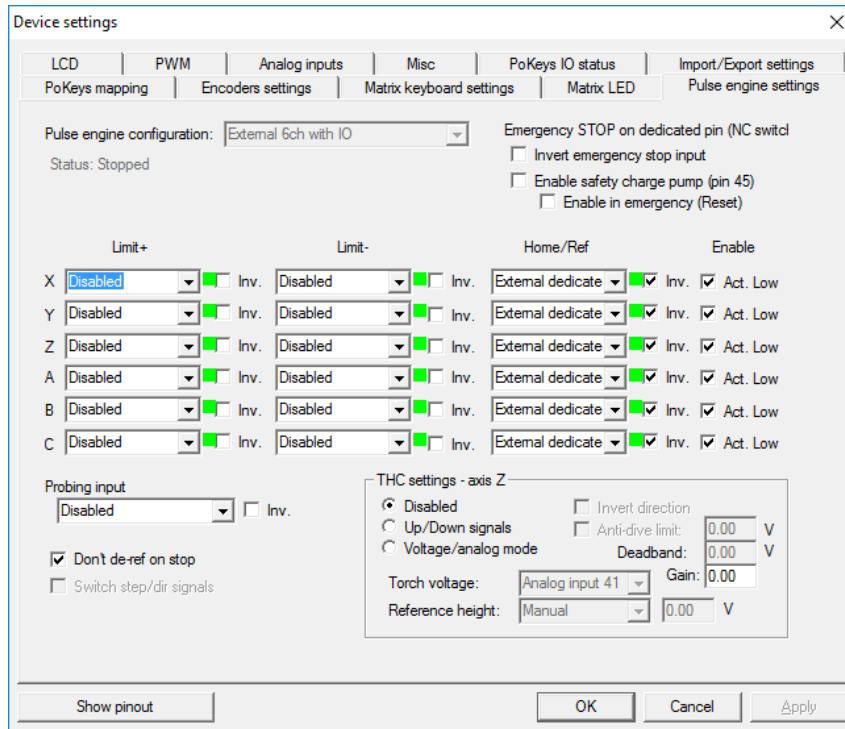

All switches can be inverted - the green/red blocks on the right of the switch selection options display the current switch status, with green indicating a free (non-tripped) switch and red indicating tripped switch. Use the 'Invert' option to switch between the states if necessary. If limit switches are enabled, PoKeys Pulse engine will enter emergency mode if any limit switch gets triggered.

The last column of settings ('Enable') allows to active 'Active low' enable signal for the stepper motor drivers.

The probing input option is available at the bottom of the dialog and offers mapping the probing input to either external digital inputs or PoKeys digital input pins.

Experimental settings for torch height controller are available in bottom right.

### Setting up digital inputs and outputs mapping

To access the digital inputs and output mapping, open the menu PlugIn control > Configure PoKeys {your serial number}.

The following dialog will appear

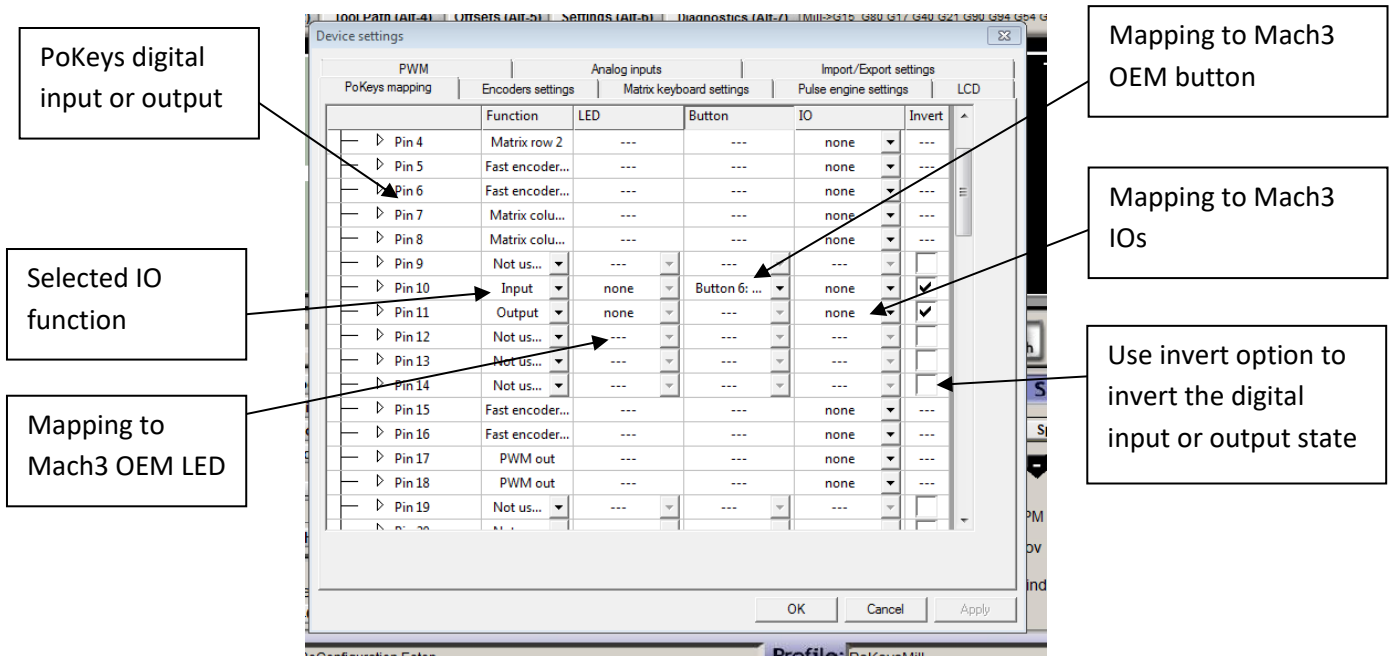

First column displays a list of all inputs or outputs, available on your PoKeys device. Use the tree structure to navigate between different peripherals and their IO pins.

The second column displays the pin function. If the pin is assigned a special function, a description of this function will be displayed. If multiple special functions are assigned, a red 'Conflict' warning will be displayed.

Third column (available for digital inputs and outputs) enables selection of mapping to Mach3 OEM LEDs. If the pin function is set to 'Input', this mapping will enable setting of Mach3 OEM LED state based on PoKeys IO pin state. If the pin function is set to 'Output', Mach3 OEM LED state will be reflected to PoKeys IO pin state.

Fourth column (available only for digital inputs) enables selection of IO mapping to Mach3 OEM buttons. When PoKeys IO pin is triggered, the selected Mach3 OEM button will be triggered also.

Fifth column (available for digital inputs and outputs) enables selection of mapping to/from Mach3 IOs (outputs, such as spindle relay, vacuum, ... used internally by Mach to control different external devices and inputs, such as limit, home switches, ... used internally by Mach to detect the status of the machine) and Mach3 IODevice inputs and outputs (accessible via VBScript).

**Pendant mode**

Plugin supports the usage of pendant with activation switch. If such pendant is connected to PoKeys, 'Pendant mode' should be enabled (checkbox at the bottom of the 'PoKeys mapping' dialog). In this mode, jog action will be deactivated when the activation switch is released and will be automatically activated when there is a signal detected for both the axis and step selection.

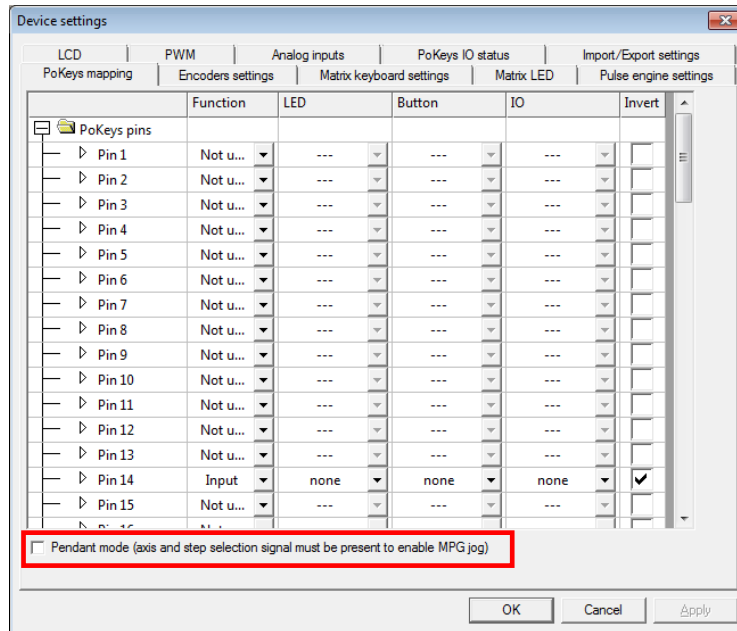

**Increasing the resolution of the MPG pendant**

PoKeys devices use integer ratios between the MPG counts and motor pulse counts. In case of smaller jogging increments (e.g. 0.1 or 0.01), the use of integer ratios result in inaccurate jogging moves. PoKeys57 series can improve the resolution of such jogging moves with the use of the 'MPG divider' factor. The MPG count is first divided by that amount, allowing more finer resolution of pulse steps. 'Auto' button allows an easy and automatic setup of the best division ratio for the current machine configuration.

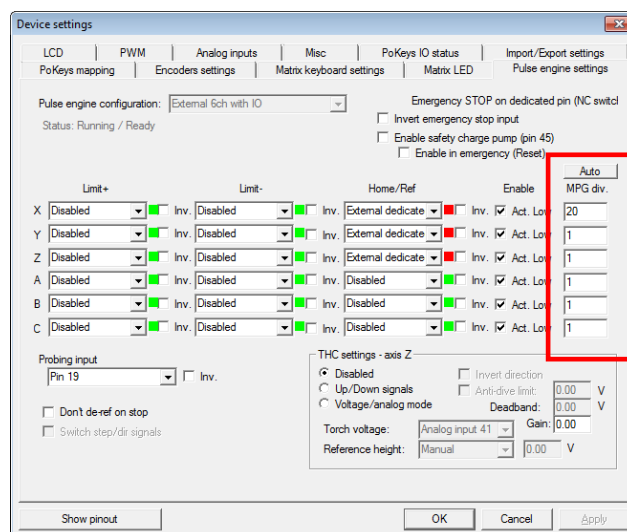

## PoKeys Pulse engine v2 documentation

### PoPendant configuration

Use the following table to configure PoPendant with Mach3. Activate 'Pendant mode' in Mapping page in order to activate the MPG jogging activation/deactivation using the 'Control switch' on the side of the PoPendant.

The configuration can also be downloaded (see PoPendant homepage) and imported into Mach3 (go to Import/Export tab in plugin configuration and select 'PoKeys pin mapping' and 'Encoder settings and mapping', then click on 'Import' and select the PoPendant configuration file).

**Note: the following table only gives an example on how to connect the PoPendant to PoKeys device. To ease the setup process, the configuration file for this example is provided on PoPendant homepage. Wiring can be rearranged by the user, but the plugin configuration must be adjusted accordingly.**

If PoKeys Pulse engine is used, 'Let PoKeys handle MPG jogging' must be checked in encoder configuration page.

Wire	PoPendant "wire colour"	Function	PoKeys pin number	Mach3 Mapping
1	red	MPG +5V	5V	/
2	black	MPG GND	GND	/
3	green	MPG A	1	MPG1 B
4	white	MPG B	2	MPG1 A
3*	purple	N.C.	N.C.	/
4*	purple/black	N.C.	N.C.	/
5	green/black	Lamp +	+3.3V	/
6	white/black	Lamp -	14	DO LED 57
7	yellow	X axis	19	Button 185
8	yellow/black	Y axis	20	Button 186
9	brown	Z axis	21	Button 187
10	brown/black	A axis	22	Button 188
9*	pink*	B axis	24	Button 189
10*	pink/black*	C axis	27	Button 190
11	gray	x1	3	Button 191
12	gray/black	x10	4	Button 192
13	orange	x100	7	Button 193
14	orange/black	Ctrl Switch	GND	/
15	Light blue	Estop	52	IO Estop**
16	blue/black	Estop GND	GND	/
17	red/black	N.C.	N.C.	/
	shield	shield	GND	/

\* Not available on all units  
 \*\* Don't configure Estop mapping if pulse engine is enabled  
 N.C.= not connected  
 DO = digital output  
 DI = digital input

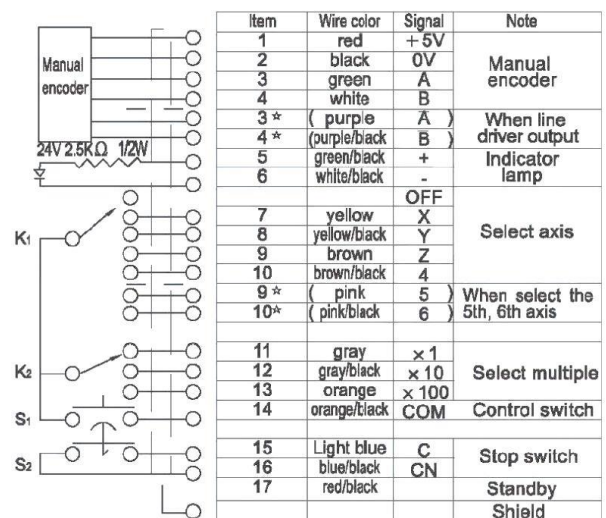
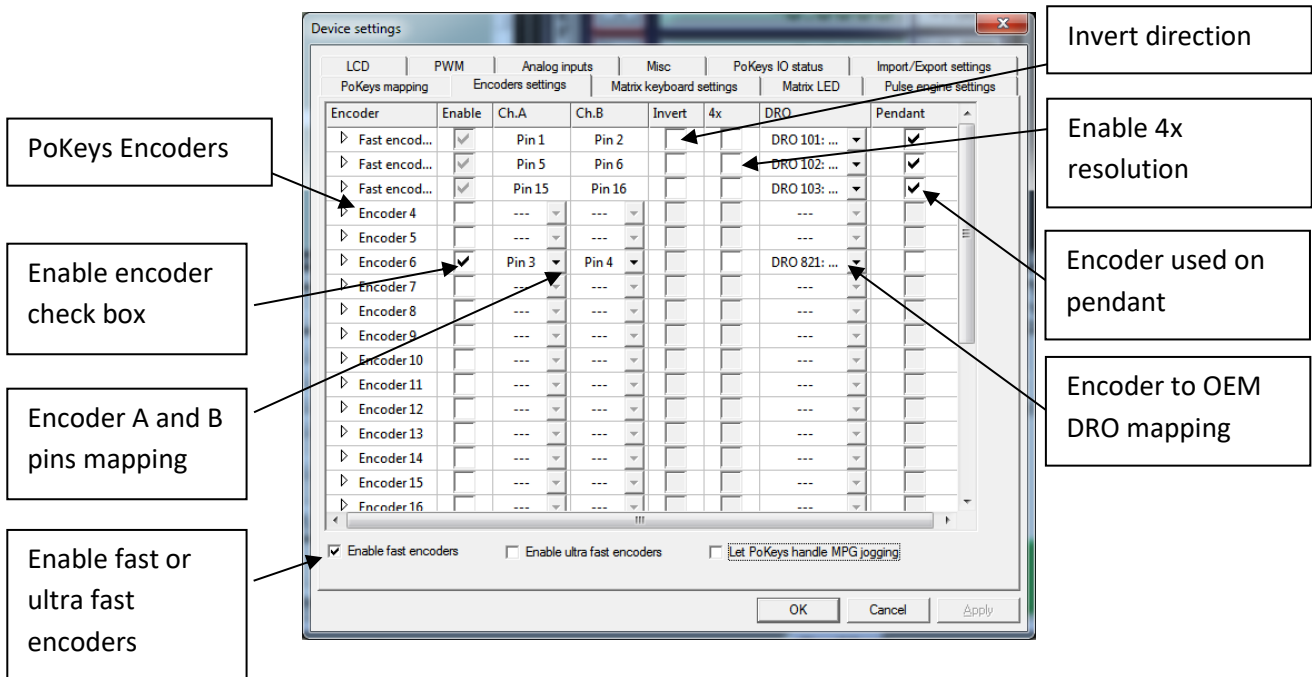

Figure 1: PoPendant internal wiring

Encoder (MPG) settings



The encoder page lists all supported encoders with their current settings. Fast encoders (replacing encoders 1-3) can be enabled by selecting the 'Enable fast encoders' option in the bottom part of the dialog. Ultra fast encoders (available on PoKeys56 devices) appear as encoder 26 and can also be enabled using the check box at the bottom of the window.

For other ('normal') encoders channel A and B signals must be setup. Select the appropriate PoKeys pin in each list. The selected pin will be automatically set as digital input.

To invert the encoder direction (instead of switching A and B signal connections physically) use the 'Invert' option. The check box in the sixth column enables 4x greater encoder resolution. The second to last column enables selection of encoder to Mach3 OEM DRO mapping.

The option in the last column 'Pendant' tells PoKeys plugin which encoder is used as MPG on the pendant. In case the 'Pendant mode' is enabled and there is an invalid signal from connected pendant, changes of encoders marked with 'Pendant' will have no effect on Mach3 or motion.

**MPG (manual pulse generator) setup**

PoKeys plugin ties itself directly into Mach3 core and does not represent a device a an LPT port-based extension. **Therefore Mach3's Ports and Pins configuration should not be used to setup the MPGs. If you configure MPG in Mach3's Ports and Pins dialog, these MPGs won't work with PoKeys.**

In order to setup MPG, follow the instructions above for an encoder, but select 'DRO 101 (MPG1)' (for MPG1), 'DRO 102' (for MPG2) or 'DRO 103' (for MPG3) in DRO field for that encoder. Also note, that the corresponding MPG must be only enabled in Mach3's Ports and pins under MPG tab.

**If PoKeys Pulse engine is used, 'Let PoKeys handle MPG jogging' must be checked.**

### Matrix keyboard setup

The matrix keyboard setup gives the options to activate matrix keyboard, select its width and height and assign PoKeys pins to matrix keyboard row and column connections.

The selected pins are automatically setup as digital inputs and outputs.

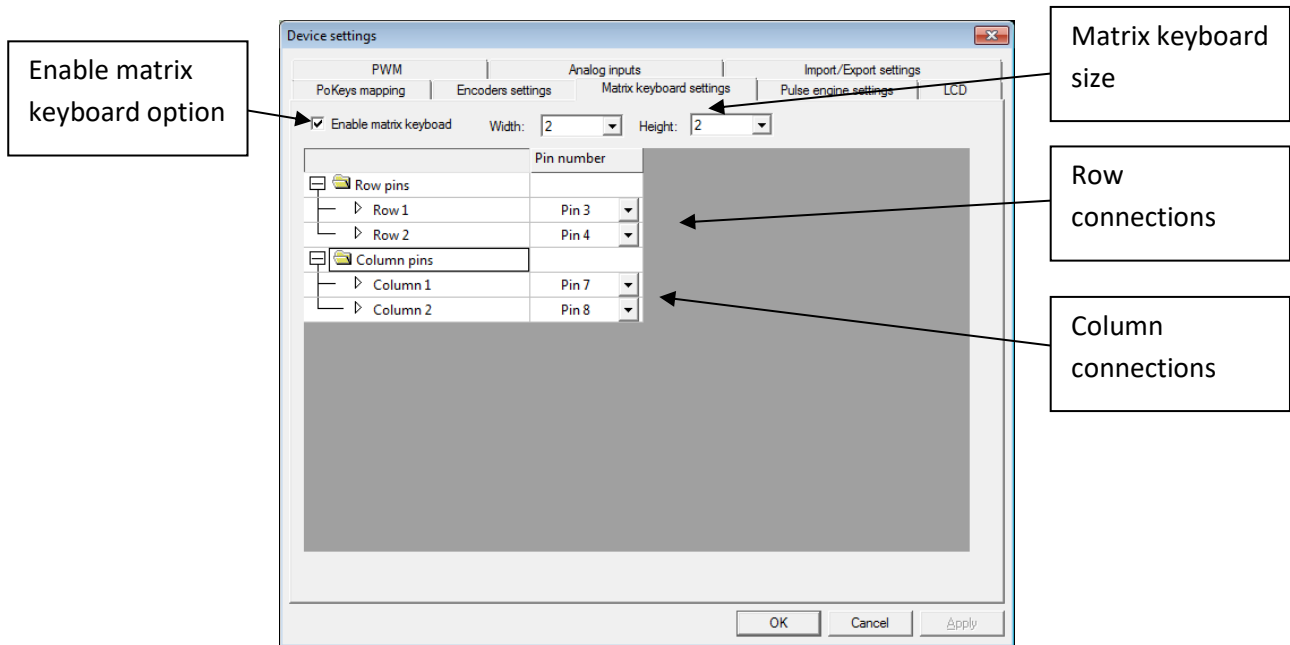

To setup mapping of matrix keyboard keys to OEM LEDs and buttons, go back to 'PoKeys mapping' tab and select appropriate functions for the matrix keyboard entries in the list of available IOs.



### LCD setup

The LCD configuration dialog can be used to enable LCD, select connection option (primary or secondary pins, as defined in the PoKeys manual), select LCD size and edit contents of the LCD.

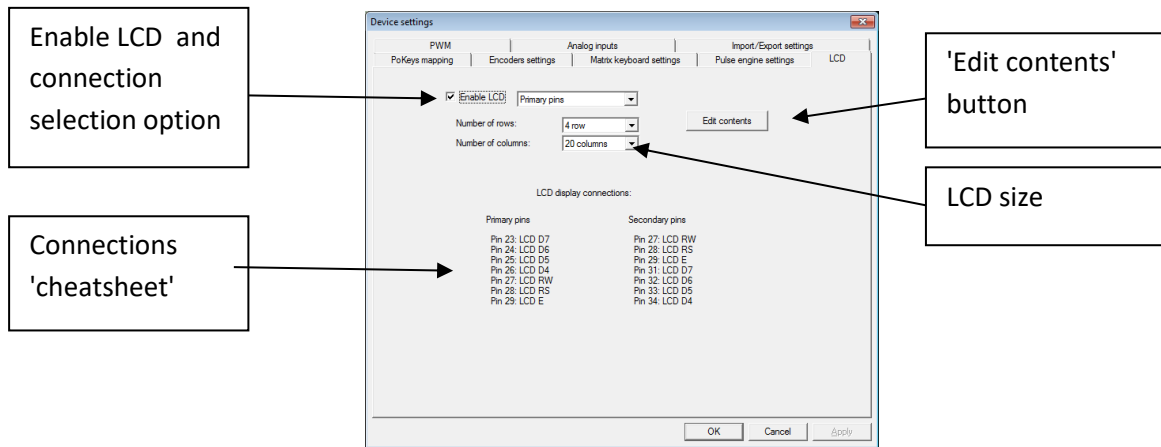

To edit the LCD contents, setup the LCD first, then click on 'Edit contents' button. The following dialog will appear

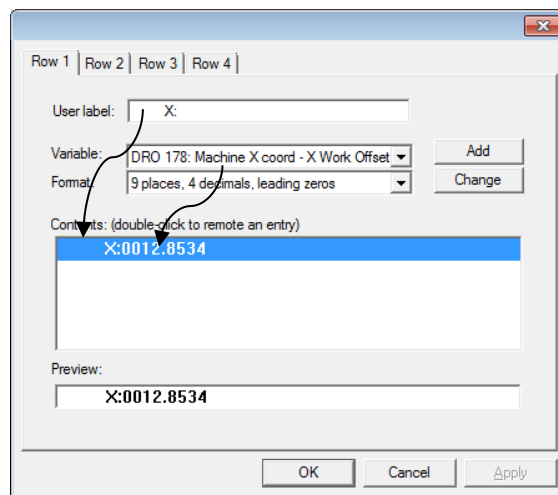

The dialog holds as many tabs as there are configured LCD lines in the previous step. The 'Row 1' dialog is used to setup only the line 1 of the LCD display ('Row 2', ... are used to setup the other lines of the display).

Each row can hold multiple entries – either label only, either holding a numeric display of one of the available variables. To add a new entry, enter the 'User label' (optional), select a variable you would like to display and its display format. Then click 'Add' button. The contents list will be updated with the new entry. To remove the entry, double-click on it. Although entries are displayed in the list in the vertical manner, they are combined on the LCD horizontally as is displayed in the 'Preview' field at the bottom.

### PWM (Pulse-width modulated) outputs

PoKeys devices support up to 6 pulse-width modulated digital outputs. All outputs share the same PWM total period (specified in microseconds) and have separately configurable duty cycles. Duty cycles can be specified either in 0-100% or as raw PWM duty cycle period in microseconds.

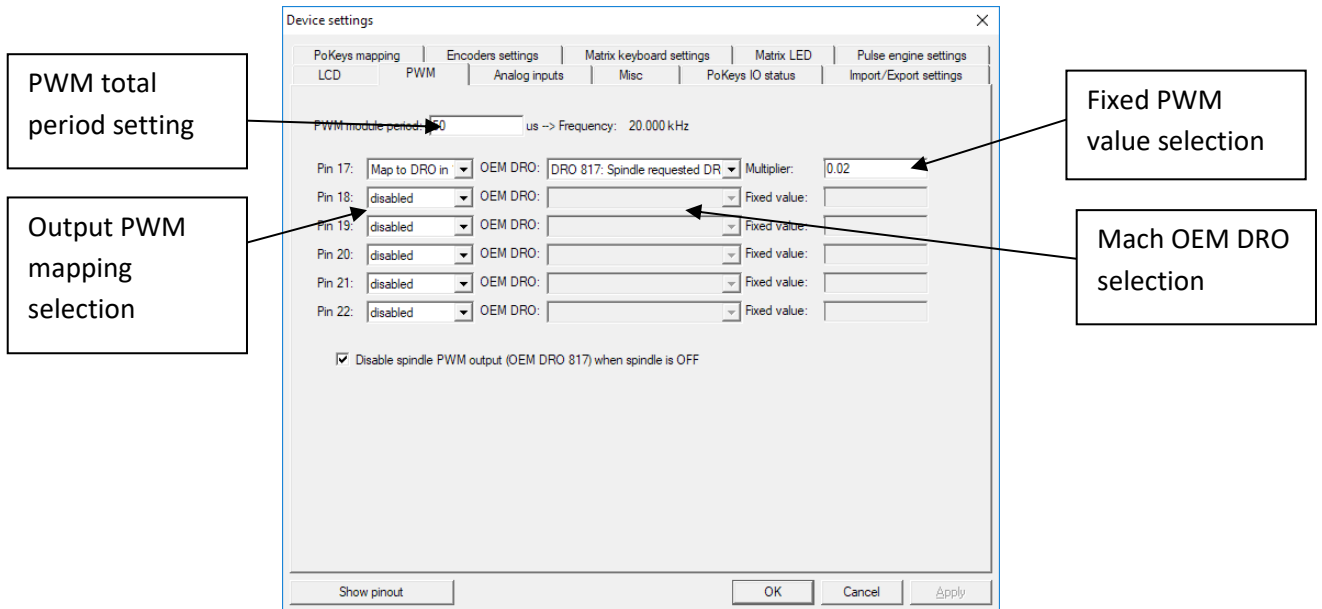

Each PWM output can be deactivated, mapped to Mach3 OEM DRO (PWM period in microseconds or in %) or assigned a fixed value (PWM period in microseconds or in %).

#### *Example: spindle speed control via PWM output*

On PoKeys57CNC device, pin 17 is connected to isolated PWM to analog converter, that enables 0-10V voltage to be generated for controlling standard spindle drives.

First, configure the PWM period to 50 us (frequency of 20 kHz). Select 'Map to DRO in %' for Pin 17, select DRO 817 in the middle list.

The multiplier value tells the PoKeys device how to adjust the PWM output in regards to the DRO value. The DRO value is first multiplied by the specified multiplier, then used by the device. Since we selected 'Map to DRO in %', PoKeys will expect the final value to be between 0 and 100, which will result in the PWM output being modulated from 0 to 100 % (0 to 10 V).

If the maximum spindle speed (at 10V output) is to be 5000 RPM, use the multiplier value of  $100/5000 = 0.02$ . In this case, value of 4000 RPM in the OEM DRO 817 will result in  $4000 * 0.02 = 80$  producing 8 V at the output.

Analog inputs

Available analog inputs on the PoKeys device (pins 43-47 on PoKeys55 and pins 41-47 on PoKeys56) can be either mapped to Mach3 OEM DRO register or used as an analog joystick axis, used for jogging.

Analog inputs are displayed as 12-bit value (10-bit analog values on PoKeys55 devices are up-scaled to 12-bit) and can be configured with user specific offset and gain value using the following formula:

$$u_{corrected} = \frac{u_{AD} - u_{offset}}{4096} * u_{gain}$$

where  $u_{corrected}$  is the corrected value of analog to digital readout  $u_{AD}$  using the offset  $u_{offset}$  and gain  $u_{gain}$ . The offset and gain values can be adjusted for each analog input separately. Mapping to DRO or analog joystick is done using the corrected value  $u_{corrected}$ .

Analog input	Current value	Offset	Gain	Corrected value	Analog joystick	DRO
Analog input 41:	1979 (1.594 V)	1983	2.000	-0.002	Not used	none
Analog input 42:	1996 (1.608 V)	1996	2.000	0.000	Axis Y	none
Analog input 43:	0 (0.000 V)	0	0.000	0.000	Not used	none
Analog input 44:	1961 (1.580 V)	0	0.000	0.000	Not used	none
Analog input 45:	0 (0.000 V)	0	0.000	0.000	Not used	none
Analog input 46:	2358 (1.900 V)	0	0.000	0.000	Not used	none
Analog input 47:	0 (0.000 V)	0	0.000	0.000	Not used	none

Analog joystick functionality enables convenient jogging option. Based on the analog voltage, present on the selected pin, the selected axis can be jogged progressively. To enable analog joystick, assign the axes in the 'Analog joystick' column and click 'Calibrate' button at the bottom of the dialog. A simple wizard will walk you through the process and enable you to calibrate (automatically set the gain and offset values) based on your input. After the successful calibration, enable analog joystick functionality by checking the box 'Enable analog joystick'.

To disable unwanted jogging in zero position, adjust the parameter 'Deadband' based on the noise of your analog input (enter value in analog value ticks – 0 to 2048). If the  $|u_{AD} - u_{offset}| < u_{deadband}$  the axis will not be jogged.

If 'Use OEM LED 1911 to enable the joystick' option is checked, analog joystick can be enabled and disabled using the OEM LED 1911 signal.

## PoKeys Pulse engine v2 documentation

### PoKeys IO status

This tab gives the user an overview of the PoKeys inputs and outputs. PoKeys pins are represented as a grid of colored squares, each resembling a single PoKeys pin and encoder values are listed at the bottom of the dialog.

By clicking the 'Open status', a floating dialog is displayed, giving the user an overview of PoKeys inputs and outputs, encoder values and PoKeys Pulse engine states even when configuration dialog is closed.

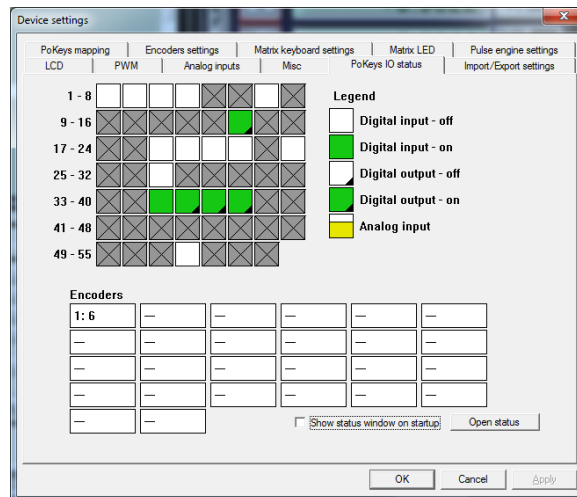

### Other (miscellaneous) settings

Misc tab contains additional miscellaneous settings.

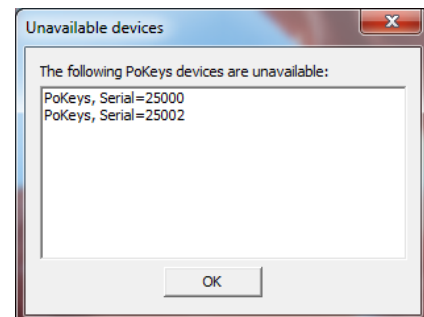
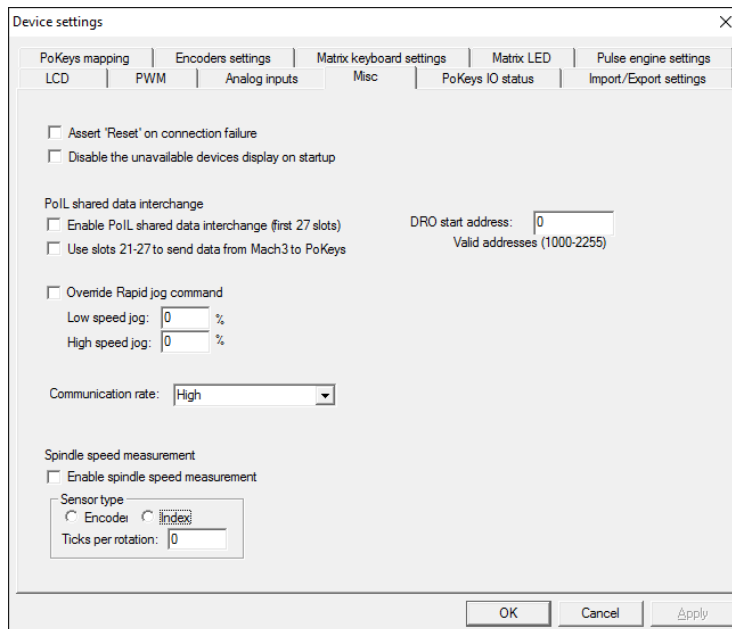

**Assert 'Reset' on connection failure:** if checked, Mach3 will be but into 'Reset' mode when the connection with the PoKeys device is dropped.

**Disable the unavailable devices display on startup:** if checked, PoKeys plugin won't display the 'Unavailable devices' window on Mach3 startup if the current device is not available

## PoKeys Pulse engine v2 documentation

### PoIL shared data interchange

This option enables interchange between PoIL shared slots (see PoBlocks manual) and Mach3 DRO registers. Once enabled, first 27 shared data slots are copied from PoKeys PoIL core to Mach3 DROs, starting by the Mach3 DRO number, specified in the field on the right (values between 1000 and 2255 are valid).

If 'Use slots 21-27 to send data from Mach3 to PoKeys' option is enabled, slots 21 to 27 are read from specified Mach3 DRO registers and sent to PoKeys PoIL core.

Custom operations can be performed on data from various PoKeys peripherals and result forwarded to Mach3 (e.g. spindle speed calculation, product counting, PID control with reference set by Mach3, ...).

### Override rapid jog command

Select custom normal and rapid jog speeds.

### Communication rate

Setting that can be used to reduce the amount of processing power PoKeys plugin consumes if needed (only for PoKeys devices used for I/O - PoKeys devices with motion controller enabled require Fast communication rate).

### Spindle speed measurement

Connect the spindle index sensor or encoder with index to the 'Ultra fast encoder' input of the PoKeys device, then enable this setting to allow PoKeys device to measure spindle speed.

THC - Torch height controller

**Warning: Support for THC is experimental.**

The purpose of torch height controller is to adjust the height of the plasma torch above the cutting surface depending on the feedback received from the plasma controller.

Two types of inputs are supported:

- Digital up/down and plasma OK signals: connect these to PoKeys digital inputs and map them to THC Up/Down and THC On Mach3 input signals
- Analog mode with plasma OK signal: connect analog voltage (via correct attenuation circuit) to PoKeys analog input and plasma OK to THC On Mach3 input signal. This mode has additional options:
  - o Torch voltage input: select analog input, where attenuated plasma voltage is connected to
  - o Reference height: select 'Manual' and enter the reference voltage (corresponding to reference height) into the field to the right or select an analog input that is used by the operator to set the reference plasma height/voltage
  - o Deadband: select the analog input deadband around the reference voltage - this will define the range where the controller will not move the torch
  - o Gain: select the gain for the torch height controller - higher value will result in faster responses of the torch height
  - o Anti-dive limit: select the voltage at which the anti-dive will be activated. While the voltage stays above this threshold, the torch will not dive (move down).

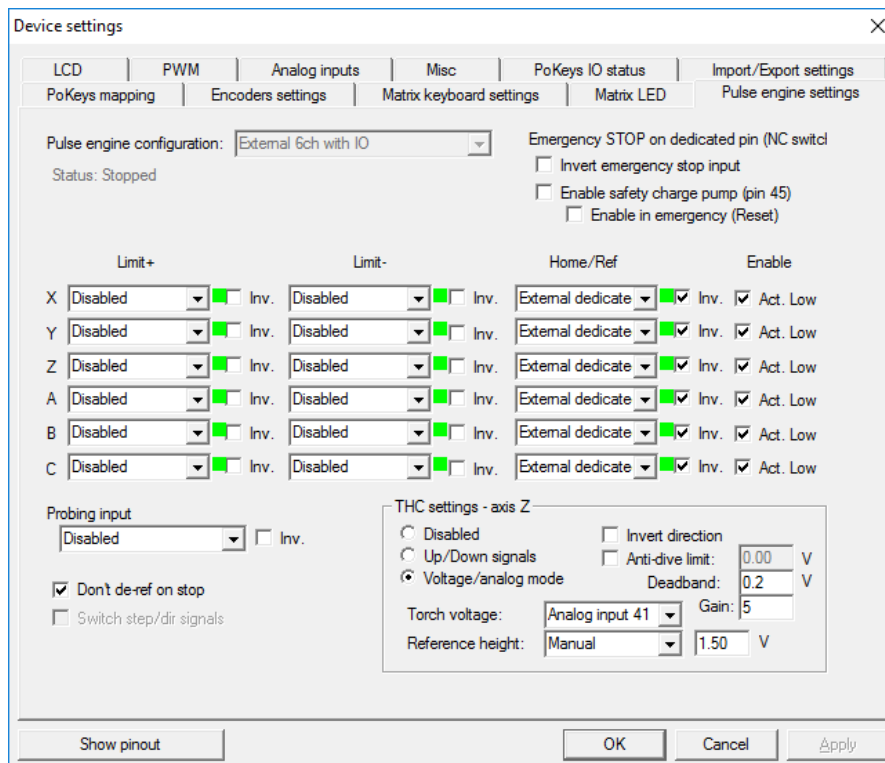

## PoKeys Pulse engine v2 documentation

Mach3 was designed in such a way that the z-axis DRO does not display the actual state of the axis while THC operation is active. Use the plasma screen and observe 'Curr' position. Once THC or torch is disabled, the z-position DRO is updated with the actual position.

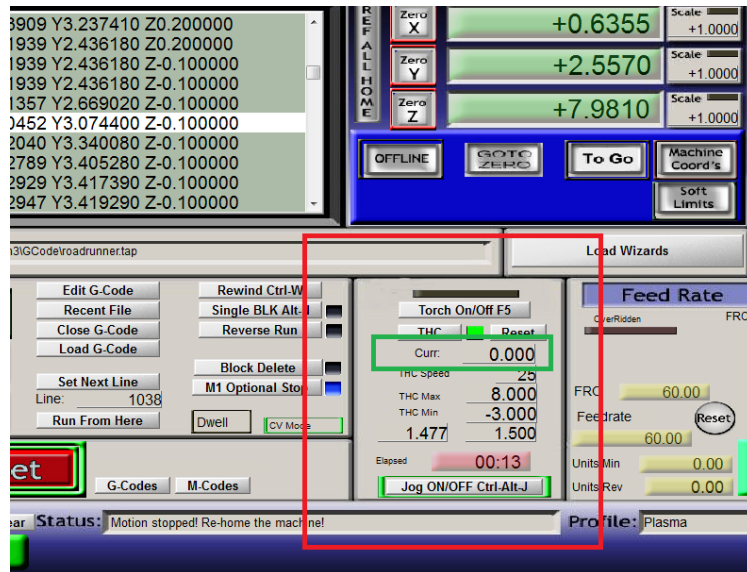

### Example configuration of THC functionality with Up/Down THC controller

First, make sure that the latest PoKeys firmware is installed along with the latest version of the Mach3 plugin.

Follow these steps:

1. Under PoKeys mapping tab of the PoKeys plugin settings, map the following signals:
  - a. a digital input (Arc good signal) must be mapped to 'LED 36 - THC Arc Good LED' in the LED column
  - b. digital inputs (THC up and down from your THC controller) mapped to 'Input THC Up' and 'Input THC Down' in the IO column
2. Enable THC in PoKeys plugin settings under Pulse engine - select Up/Down signals option and set the gain to 1.00

## PoKeys Pulse engine v2 documentation

### Reading and writing of IO from VB script

PoKeys Mach3 plugin exposes each PoKeys device (named PoKeys\_{serial}, where serial is the serial number of the PoKeys device) as 100 virtual IO pins that can be accessed from Mach3 VB script with the following functions:

#### *GetIODeviceName( DevID As Short ) Return String*

DevID - Device ID's start at zero and go up.

Return - Returns the name of the Device as a String. If the device ID is out of range the return will be "NoDevice"

#### *GetIODeviceInput( DevID As Short , IONumber As Short ) Return Double*

DevID - Device ID's start at zero and go up.

IONumber - The number of the IO Starting at zero (Pin number -1)

Return - Returns the value of an input OR the value that an output is set to . If the device is not found a return of 999 will be sent back.

#### *SetIODeviceOutput(DevID As Short , IONumber As Short, Value As Double)*

Return Short

DevID - Device ID's start at zero and go up.

IONumber - The number of the IO Starting at zero (Pin number -1)

Value - Any value to set the output to. for digital outputs 0 and 1 are used as on and off

Return - Return of 0 if there are no faults, 1 is returned if he pin is not found , 2 is returned if the pin is an output pin.

***Example script (finds the PoKeys device with the serial number 25000, then toggles the IO 1 on and off at a rate of 1 Hz):***

```
Sub Main()  
DevName = "PoKeys_25000"  
Outputnumber = 1  
  
DevID = -1  
  
Do  
DevID = DevID+1
```



## PoKeys Pulse engine v2 documentation

```
SearchName = GetIODevName(DevID)'Search for the Device
If(SearchName = "NoDevice") Then
  MsgBox ("Error Finding Device")
  Exit Sub
End If
Loop While (DevName <> SearchName)

For d=0 To 60'Loop 60 times to toggle the output on and off for one min
  r = SetIODevOutput(DevID,Outputnumber,1)'Activate the output
  If(r<>0) Then
    MsgBox("Output#" & Outputnumber & " " & GetIODevIName(DevID,Outputnumber) & " is Not
an
output" )
    Exit Sub
  End If
  Sleep(500) 'Wait .5 sec
  SetIODevOutput(DevID,Outputnumber,0)'Turn the output off
  Sleep(500)'Wait .5 sec

Next d

End Sub

Main
```

### Additional OEM buttons

OEM button	Function
1900	Plugin Jog Toggle
1901	Plugin Jog +
1902	Plugin Jog -
1903	Plugin Rapid Jog Toggle
1904	Plugin Goto 0's
1910	Plugin Spindle CW
1911	Plugin Spindle Stop
1912	Plugin Spindle CCW

### Additional OEM LEDs

OEM LED	Function
1900	Plugin Jog X axis LED
1901	Plugin Jog Y axis LED
1902	Plugin Jog Z axis LED
1903	Plugin Jog A axis LED
1904	Plugin Jog B axis LED
1905	Plugin Jog C axis LED
1906	Plugin Jog Select 0.001 increment LED
1907	Plugin Jog Select 0.01 increment LED
1908	Plugin Jog Select 0.1 increment LED
1909	Plugin Jog Select 1 increment LED

## Pulse engine v2 operating principles

PoKeys Pulse engine v2 (upgrade of the original PoKeys Pulse engine) is available on PoKeys56U and PoKeys56E devices and enables a direct control of a positioning systems that accepts step/direction signals (stepper motors, servo systems, etc.).

PoKeys Pulse engine divides the operations into 1 millisecond time slots, during which the pulse frequency is held constant, and supports the generation of up to 25 pulses per 1 millisecond time slot using integrated pulse generator or up to 125 pulses per 1 millisecond time slot using external pulse generator circuit (which equates to 25/125 kHz maximum pulse frequency supported).

At each time slot beginning, the selected limit and home switches are read and evaluated. If emergency switch or any activated limit switch (enabled in the configuration) is tripped, the pulse engine is put into Error mode and no more pulses are generated (with hard-stop mechanism). Limit switches can be disabled using the 'Limit override' function. In addition, PoKeys pulse engine also supports 'Soft-limit' function, which limits the machine motion using the virtual limit switches.

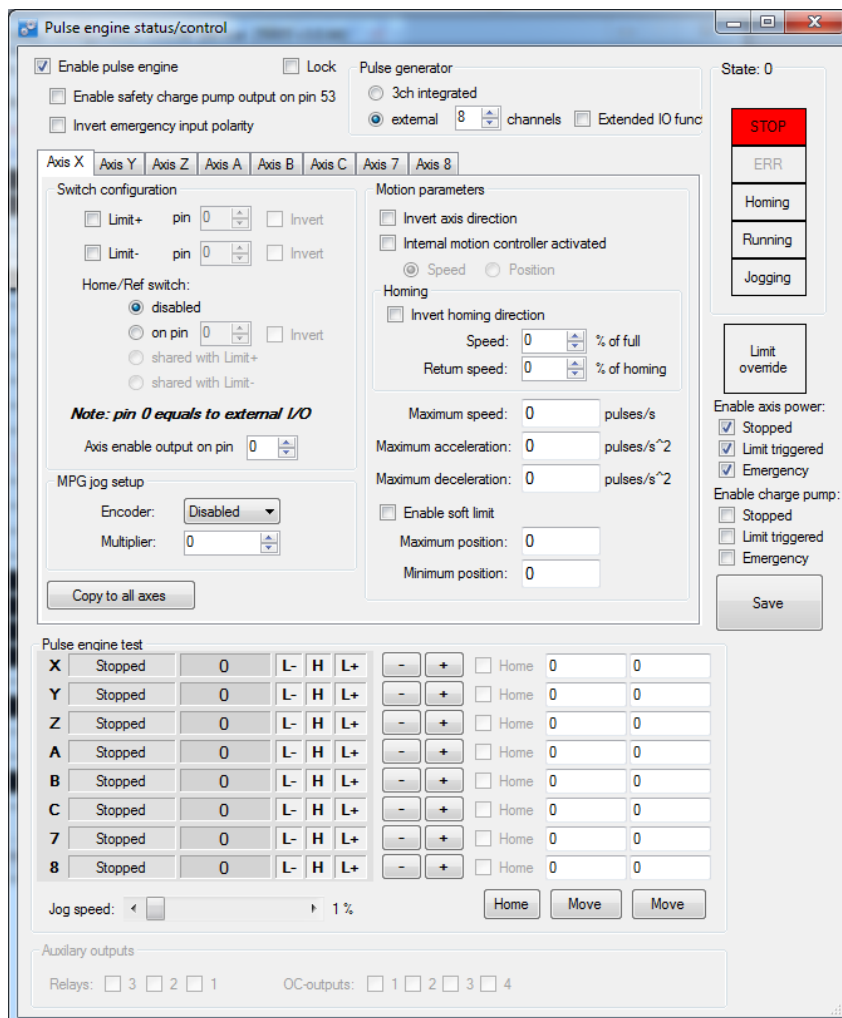

Figure 2: Pulse engine configuration window in PoKeys configuration software

PoKeys Pulse engine operates in different modes with additional modes selectable per each axis.

### Modes of operation

- **Stopped:** the pulse engine does not generate any pulses.
- **Error:** the pulse engine encountered an error (e.g. limit switch was activated).
- **Homing:** homing mode is activated. In this mode, one or more axes can be homed. The selected axis (or axes) moves in negative direction at predefined fraction of the maximum speed until the home switch is tripped. Then, the direction is changed to positive and speed decreased to half the previous speed. When the switch is tripped, the internal position counter is reset and the axis is commanded to stop. This operation does not include moving back to position 0. The state of homing procedure is reflected in axes states.
- **Probing:** during probing, selected axes are actuated by PoKeys device until a probe signal has changed to a predefined state. The position of the axes is saved and the motion is stopped.
- **(MPG) Jogging:** if axis has an MPG assigned, the MPG jog is done by PoKeys device itself using the MPG multiplier value.
- **Running:** normal operation mode. In this mode, each axis can be put into either the 'buffer' mode (the internal controller is disabled and the slots are fed directly from a slot buffer, which must be constantly filled by the external application) or into the 'internal controller mode':
  - internal position control: moves the axis to the desired position, following the limitations set by the axis parameters,
  - internal speed control: moves the axis at the desired speed, following the limitations set by the axis parameters.

Internal controller modes and buffer mode utilize separate internal buffers for operation. Hence, changing between internal or external (buffered) mode does not require clearing the motion buffers. Moreover, internal controller can be used on selected axes in parallel to the external (buffered) mode on other axes (new to Pulse engine v2).

In buffer (slave) mode, the generated motion is transferred and temporarily stored in the timeslot buffer - a 128-slots deep buffer that holds pulse frequencies for each axis, giving a 128 millisecond buffered motion period. Each slot entry in the buffer holds 16 bytes (2 byte per axis) and each axis entry uses 15-bits for pulse frequency and MSB bit for the direction signal (if MSB bit is set, the direction output is activated). Although buffer holds 16 bytes per time slot, only [number of activated axes] bytes are transferred for each slot using default 'Fill motion buffer' command.

Fill buffer command is used to transfer the data to the slot buffer. Application that uses the fill buffer command should send as much time slot data as possible. PoKeys Pulse engine will then return the number of accepted time slots. This omits the need of additional query on the buffer free space in PoKeys Pulse engine buffer. Application should only then increase the 'read pointer' based on the number of accepted slots. Additionally, fill buffer command returns a number of parameters of the pulse engine (position, engine state, state of limit and home switches and states of each axis).

In Mach3 plugin, PoKeys Pulse engine operates in buffer (slave) mode during job execution and executes the motion, generated by Mach3 motion planner. During jogging, MPG jogging, homing, probing operations, the selected axis is switched to internal motion controller, enabling real-time

## PoKeys Pulse engine v2 documentation

responses and high accuracy of positioning. MPG jogging uses encoder (MPG) values directly to feed the internal motion controller with the up-to-date information on MPG position. This results in fast responses of the machine to the MPG input.

### Safety charge-pump output

When activated, 5 kHz square safety charge-pump signal is present on pin 53 if the Pulse engine is in normal operating mode. The safety charge-pump in other operating mode can be enabled by the user by selecting the 'Enable charge-pump' check boxes.

In Mach3 plugin, the user can select whether charge pump output is active during emergency.

### Motor driver enable outputs

Motor driver enable outputs are available only with conjunction with PoKeysCNCaddon. User can select modes in which the motor drivers are enabled by selecting the 'Enable axis power' check boxes.

In Mach3 plugin, the motor driver enable outputs settings are joined with safety charge-pump settings.

### Axis parameters

Internal mode uses the following axis parameters of motion:

- Maximum speed: maximum frequency of pulses (in pulses/s)
- Acceleration: maximum acceleration (in pulses/s<sup>2</sup>)
- Deceleration: maximum deceleration (in pulses/s<sup>2</sup>)
- Limit and home switches configuration
- Direction change configuration: direction can be changed separately for each of the axes
- Homing direction configuration: direction of homing can be changed separately for each of the axes

### Custom external pulse generator without IO functionality

External pulse generator is a simple circuit for deserializing step and direction data, coming from PoKeys device. The circuit uses 74HCT595 IC that is connected to PoKeys board as shown in the table below.

Two 74HCT595 can be cascaded in order to support 8 axes, but single one can be used for up to 4 axes. When cascading, CLOCK and LATCH signals are shared between both ICs, while DATA out (pin 9) of the first IC is used as DATA signal of the second IC.

Pin	Description	PoKeys56U	PoKeys56E/57E
		pin	pin
5V	5 V power supply	5 V	5 V
GND	PoKeys ground	GND	GND
DATA	Signal for pulse generation	23	9
CLOCK	Signal for pulse generation	25	11
LATCH	Signal for pulse generation	26	51

## PoKeys Pulse engine v2 documentation

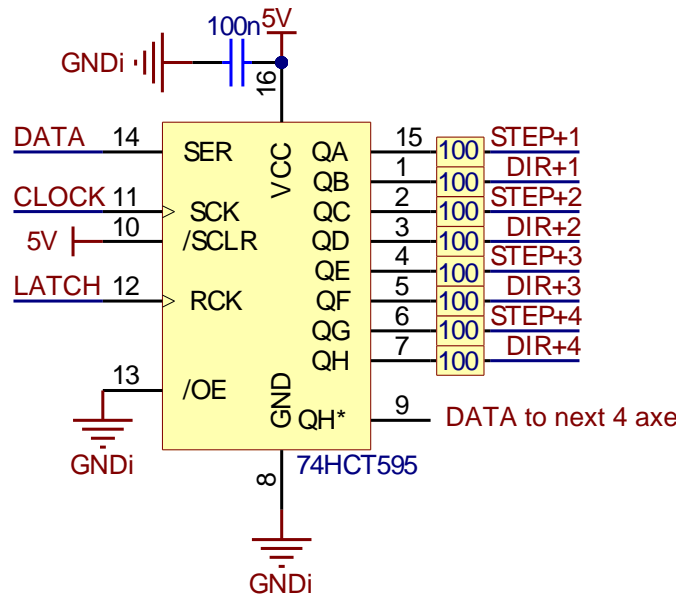

### Pulse engine limitations:

- Minimum/maximum position:
  - Internal motion controller: -/+ ~16.8 million ticks

External (buffered) mode: -/+ ~2100 million ticks

## Frequently asked questions

**Whenever Mach “reset” is blinking the stepper motor power is engaged, and you cannot turn the motor shaft with your fingers. When “reset” is released, the motors loose power.**

There is an option 'Invert enabled signal' in the 'Pulse engine' tab of the PoKeys Mach3 plugin. There are two types of stepper drivers - ones expect active low signal for enabling the outputs, the others expect active high signal. Since PoKeys is not a LPT port extension, the Mach3's Ports & Pins is not functional and all configuration is done via PoKeys plugin configuration dialogs.

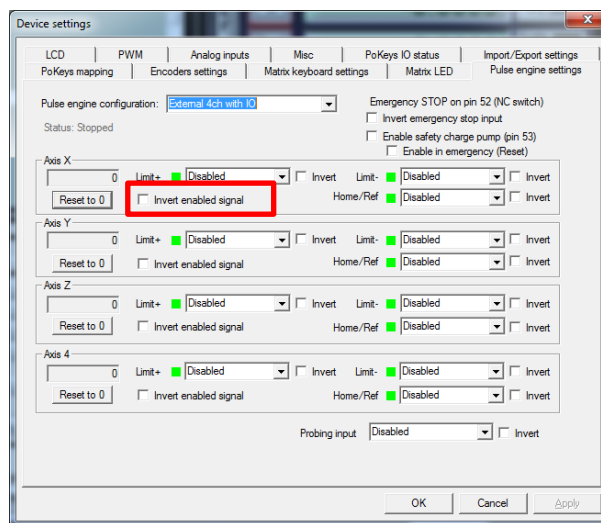

**I really do not know how to set up the spindle control. Normally I would use for example the S60 (for spindle speed of 60 to produce an analog output to control the spindle). I do not know how to tell the pokeys CNC addon board how to pick up this S command.**

This is achieved using the PWM output of the PoKeys board, connected to the pin 3 of the PoKeysCNCaddon board connection. Go to PoKeys Mach3 plugin configuration, tab 'PWM', select 'Map to DRO in %' and select DRO202. Then set the appropriate multiplier that the DRO value is multiplied with before sending it to the output (the output goes from 0 to 100 %, so in case you have values between 0 and 500 in this DRO, set the multiplier to 0.2). If you want to lower the output range, lower the multiplier value (digitally scale the output voltage instead of using the pot).

Similarly, spindle relay outputs can be configured in the 'PoKeys mapping' tab for one of the pins (for example, configuring one pin as Digital output and mapping it to LED 11 (Spindle ON LED)).

### Please read the following notes

1. All information included in this document is current as of the date this document is issued. Such information, however, is subject to change without any prior notice.
2. PoLabs does not assume any liability for infringement of patents, copyrights, or other intellectual property rights of third parties by or arising from the use of PoLabs products or technical information described in this document. No license, express, implied or otherwise, is granted hereby under any patents, copyrights or other intellectual property rights of PoLabs or others. PoLabs claims the copyright of, and retains the rights to, all material (software, documents, etc.) contained in this release. You may copy and distribute the entire release in its original state, but must not copy individual items within the release other than for backup purposes.
3. Descriptions of circuits, software and other related information in this document are provided only to illustrate the operation of the products and application examples. You are fully responsible for the incorporation of these circuits, software, and information in the design of your equipment. PoLabs assumes no responsibility for any losses incurred by you or third parties arising from the use of these circuits, software, or information.
4. PoLabs has used reasonable care in preparing the information included in this document, but PoLabs does not warrant that such information is error free. PoLabs assumes no liability whatsoever for any damages incurred by you resulting from errors in or omissions from the information included herein.
5. PoLabs devices may be used in equipment that does not impose a threat to human life in case of the malfunctioning, such as: computer interfaces, office equipment, communications equipment, test and measurement equipment, audio and visual equipment, home electronic appliances, machine tools, personal electronic equipment, and industrial robots.
6. Measures such as fail-safe function and redundant design should be taken to ensure reliability and safety when PoLabs devices are used for or in connection with equipment that requires higher reliability, for example: traffic control systems, anti-disaster systems, anticrime systems, safety equipment, medical equipment not specifically designed for life support, and other similar applications.
7. PoLabs devices shall not be used for or in connection with equipment that requires an extremely high level of reliability and safety, as for example: aircraft systems, aerospace equipment, nuclear reactor control systems, medical equipment or systems for life support (e.g. artificial life support devices or systems), and any other applications or purposes that pose a direct threat to human life.
8. You should use the PoLabs products described in this document within the range specified by PoLabs, especially with respect to the maximum rating, operating supply voltage range and other product characteristics. PoLabs shall have no liability for malfunctions or damages arising out of the use of PoLabs products beyond such specified ranges.
9. Although PoLabs endeavors to improve the quality and reliability of its products, semiconductor products have specific characteristics such as the occurrence of failure at a certain rate and malfunctions under certain use conditions. Further, PoLabs products are not subject to radiation resistance design. Please be sure to implement safety measures to guard them against the possibility of physical injury, and injury or damage caused by fire in the event of the failure of a PoLabs product, such as safety design for hardware and software including but not limited to redundancy, fire control and malfunction prevention, appropriate treatment for aging degradation or any other appropriate measures.
10. Usage: the software in this release is for use only with PoLabs products or with data collected using PoLabs products.
11. Fitness for purpose: no two applications are the same, so PoLabs cannot guarantee that its equipment or software is suitable for a given application. It is therefore the user's responsibility to ensure that the product is suitable for the user's application.
12. Viruses: this software was continuously monitored for viruses during production, however the user is responsible for virus checking the software once it is installed.
13. Upgrades: we provide upgrades, free of charge, from our web site at [www.poscope.com](http://www.poscope.com). We reserve the right to charge for updates or replacements sent out on physical media.
14. Please contact a PoLabs support for details as to environmental matters such as the environmental compatibility of each PoLabs product. Please use PoLabs products in compliance with all applicable laws and regulations that regulate the inclusion or use of controlled substances, including without limitation, the EU RoHS Directive. PoLabs assumes no liability for damages or losses occurring as a result of your noncompliance with applicable laws and regulations.
15. Please contact a PoLabs support at [support@poscope.com](mailto:support@poscope.com) if you have any questions regarding the information contained in this document or PoLabs products, or if you have any other inquiries.
16. The licensee agrees to allow access to this software only to persons who have been informed of and agree to abide by these conditions.
17. Trademarks: Windows is a registered trademark of Microsoft Corporation. PoKeys, PoKeys55, PoKeys56U, PoKeys56E, PoScope, PoLabs and others are internationally registered trademarks.