POLARIS GENERAL (2 & 4 SEATER) - 6" PORTAL GEAR LIFT KIT

PGL-660DI-GEN1 (60% Dual Idler Kit)

PGL-645DI-GEN1 (45% Dual Idler Kit)

PGL-645-GEN1 (45% Single Idler Kit)



Parts Available For These Popular Brands and Others

POLARIS

can-am



Kawasaki



HIGHLIFTER



sales@highlifter.com



800-699-0947 | 8:00am - 6:00pm CST



780 Professional Drive North, Shreveport, LA 71105



www.highlifter.com

IMPORTANT PRODUCT USE AND SAFETY INFORMATION / WARNINGS

This product is designed for use on ATVs and/or RUVs to lower the final drive gear ratio and increase ground clearance. Purchasers should be aware that use of this product may increase the frequency of required maintenance, part wear, and will raise the center of gravity on your ATV and/or RUV, increasing risk of roll-over, injury and death on all types of terrain. It is your responsibility to always inform other operators and passengers of this vehicle about the added risks with this product.

High Lifter's products are designed to best fit user's ATV/RUV under stock conditions. Adding, modifying, or fabricating any OEM or aftermarket parts will void warranty. High Lifter Products, products could interfere with other aftermarket accessories. If the user has aftermarket products on machine, contact High Lifter Products to verify that they will work together. Adding aftermarket suspension components and/or more aggressive tires can cause breakage of other OEM driveline components such as differentials, axles or drive shafts.

Riders should be advised that the handling characteristics of a taller ATV and/or RUV are different and require extra care when riding, particularly on the side of hills or off-camber situations. If you further raise the center of gravity by adding taller tires, heavy loads to racks or seats, or by any other means, the ATV and/or RUV must be operated with even more care, at slower speeds and on relatively flat ground. All turns should be done at a slow speed, even on level ground.

Operation of an ATV and/or RUV with or without modified suspension components, while or shortly after consuming alcohol or drugs, subjects the rider and passengers to the risk of serious bodily harm or possible death. This risk is compounded if the riders do not wear an approved helmets and other safety gear. High Lifter urges that all approved safety gear be worn when riding an ATV and/or RUV as a driver or passenger.

By purchasing and installing High Lifter Products, products, user agrees that should damages occur, High Lifter Products will not be held responsible for loss of time, use, labor fees, replacement parts, or freight charges. High Lifter Products will not be held responsible for any direct, indirect, incidental, special, or consequential damages that result from any product purchased from High Lifter Products. The total liability of seller to user for all damages, losses, and causes of action, shall not exceed the total purchase price paid for the product that gives rise to the claim.

Dealers and other Installers

You are responsible for informing your customer and end user of the information contained above and the increased potential hazards of operating an ATV and/or RUV equipped with modified suspension components. If you install any suspension modifying components, it is your responsibility to also install the warning label prominently in view of the driver and in prominent view of the driver and passenger on RUVs and multi-passenger ATVs. They should also be instructed to notify anyone operating the vehicle, as well as any passengers, that said vehicle is modified.

As discussed above, it is critically important that they be instructed in the need for slower speed operation, regardless of terrain, after this lift kit is installed.

The product is/will:

- Designed and intended for use on a UTV at slow speeds.
- Increase the center of gravity.
- Increase the turning radius.
- Increase the stopping distance when adding larger tires.
- Increase and accelerate wear of factory components including bushings, bearings, ball joints, and tie rod ends.
- We cannot guarantee fitment with other aftermarket accessories.

Safety Guidelines:

- Inspect all moving factory suspension components particularly ball joints, tie rod ends, control arm connections, and brakes prior to each ride and replace if worn.
- Inspect clearances with control arms and brake lines prior to each ride.
- Wheel spacers should not be used with a Portal Gear Kit.
- 14" or larger wheels must be used with the Portal Gear Kit. 12" wheels cannot be used.
- Jumping, high speeds, and quick maneuvering should be avoided.

Maintenance Information:

- Check gear oil in portal boxes following 25 hours of riding or sooner, depending on how you ride.
- Use 4 oz of SAE 80W-90 Gear Lubricant as needed in each portal box.
- Replace worn factory components including bushings, bearings, ball joints, brakes, and tie rod ends when they show wear.

Any vehicle equipped with a Portal Gear Kit must have the enclosed large format "Warning to Driver" decal installed on the inside of the windshield or on the vehicle's dash, within driver's view. The "Warning to Driver" decal is to act as a constant safety reminder for whoever may be operating the vehicle.

INSTALLING dealer: It is your responsibility to install the "Warning to Driver" decal and forward these installation instructions to the vehicle owner for review of warnings, product use, and maintenance information. Replacement Warning Decals are available FREE on request. These instructions are to be kept with the vehicle registration papers and owner's manual for the service life of the vehicle.

REFUSED Shipments/Order CANCELLATION:

Refused shipments are subject to a 20% restocking fee plus all associated freight costs. It is our goal to ship all orders in a timely manner. If a customer wishes to cancel an order (provided it is not a special order product), it is the responsibility of the customer to cancel the order prior to the product being shipped. If a customer cancels an order after product has been shipped, refused shipment, cancellation, or return will be subject to a 20% restocking fee and any freight charges incurred. For orders outside the United States, any fees associated with customs or duties are non-refundable.

DAMAGED Shipments:

All claims for damaged shipments must be made within 72 hours of delivery to the point of destination. Any damage to package should be noted with carrier at the time of delivery if possible. We will not be responsible for damage claims made over 72 hours after delivery to the point of destination.

INTRODUCTION

- Read these instructions carefully. It is recommended that a professional mechanic perform the installation. Care should be taken to follow all standard safety procedures.
- PRIOR to installation, a thorough inspection of the suspension should be made. Inspect the vehicles steering, driveline, and brake systems, paying close attention to the suspension link arms and bushings, anti-sway bars and bushings, tie rod ends, ball joints and wheel bearings.
- Also check the steering sector-to-frame and all suspension-to-frame attaching points for stress cracks. The overall vehicle must be in excellent working condition. Any worn, bent or broken parts should be repaired and/or replaced.

NOTE: Do not add or fabricate any components to gain additional suspension height.

NOTE: AFTER installation, another inspection should be made, checking for loose components or missing hardware. Inspect, again after eight (8) hours of operation. Remember, check your lug nuts again.

NOTE: A factory service manual should be on hand for reference. The manual will contain fastener torque specs, assembly techniques, and special tool requirements that are unique to this particular year and model vehicle.

TOOLS REQUIRED

- Metric & standard socket assortments
- Metric & standard hex key/sockets
- Torque wrench
- Multi-purpose pliers
- Wire cutter/snips
- Mallet (Soft face hammer)
- Drift punch/pin

WHEEL REQUIREMENTS

- 18" or larger wheel required
- 18" wheels cannot exceed 4-1/2" backspacing
- 20" and larger wheels cannot exceed 5" backspacing

SUPPLIES REQUIRED

- Water-resistant grease
- DOT 4 brake fluid
- 80w90 gear oil

TIRE REQUIREMENTS

- Up to 30" Stock
- 31" with 3" Lift Kit
- 32" to 33" Forward Kit 1.5"
- 34" Forward Kit and Lift Kit
- 35" to 37" Big Lift Kit (45%)
- 38" to 39" Big Lift Kit (45% or 60%)
- 40" and UP Big Lift Kit (STRONGLY SUGGEST 60%)

FRONT INSTALLATION STEPS

1. Prepare vehicle, front
2. Removal of front brake calipers & hubs
3. Front backing plate install
4. Front portal box assembly
5. Install front portal box
6. Install front drive shaft nut & portal box lid cap
7. Assemble all brake rotors and wheel hubs
8. Install front brake rotor assembly
9. Install front brake calipers
10. Install and route front brake lines

REAR INSTALLATION STEPS

11. Prepare vehicle, rear
12. Removal of rear brake calipers & hubs
13. Install bushings into backing plate assembly
14. Install rear backing plate assembly
15. Rear portal box assembly
16. Install rear portal box
17. Install rear drive shaft jam nut & portal box lid cap
18. Install rear brake rotor assembly
19. Install rear brake calipers
20. Install and route rear brake lines

FINAL INSTALLATION

21. Bleed brakes
22. Fill portal boxes with oil
23. Install wheels
24. Front alignment
25. Warning decals

PARTS DIAGRAM

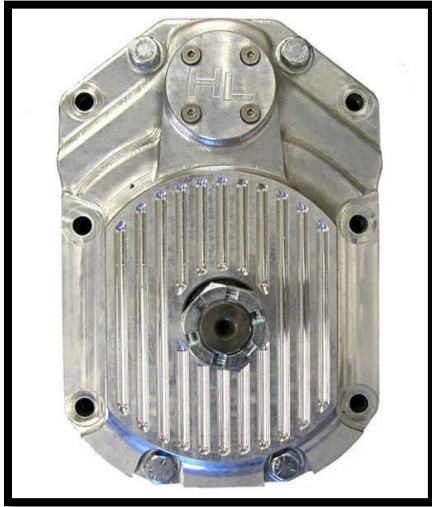

6" Dual Idler 60% Reduction

PGL-660DI-GEN1

Front & Rear Box (4ea) PGLAB-660-DI-P601

6" Dual Idler 45% Reduction

PGL-645DI-GEN1

Front & Rear Box (4ea) PGLAB-645-DI-P601

6" Single Idler 45% Reduction

PGL-645-GEN1

Front & Rear Box (4ea) PGLAB-645-P601

PGLBOX-P601-B1
(Hubs & Rotors)

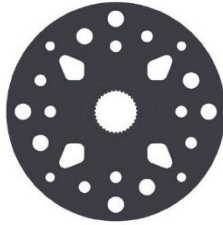

Multi Pattern
Hub (4ea)
PGLC-HUB-201

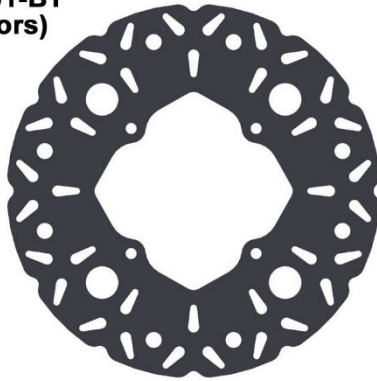

Brake Rotor (4ea)
PGLC-ROTOR-3

PGLBOX-P605-B2B1
(BOX #2)

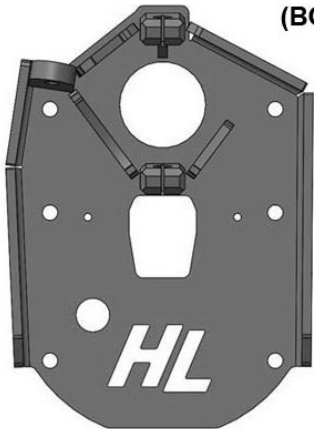

Front Left Backing
Plate (1ea) 101i-L



Front Right Backing
Plate (1ea) 101i-R

PGLBOX-P605-B3B1
(BOX #3)

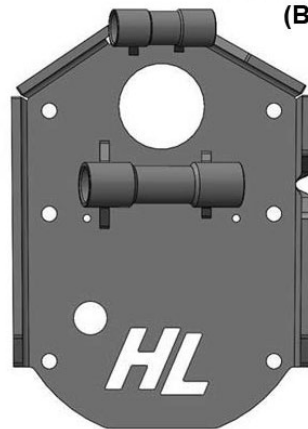

Rear Left Backing
Plate (1ea) 101J-L

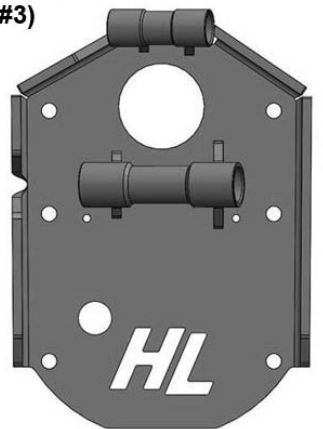

Rear Right Backing
Plate (1ea) 101J-L

PGLBOX-P605-B1
(BOX #1)
Hardware

1/2"x4-3/4" Bolt (8ea)
HC812434Z



1/2"x4-1/2" Bolt (16ea)
HC812412Z



1/2" Flat Washer
(48ea) FW12SAE



M18 Axle Nut w/Shoulder
(4ea) PGLC-AXNUT-4

3/8"x1-1/4" Bolt (16ea)
HC838114Z



3/8" Lock Washer
(16ea) LW38Z



1/2" Lock Nut
(24ea) NLN812

5mm x 20mm Bolt (4ea)
MCS520



5mm Flat Washer
(4ea) MFW5



5mm Lock Nut
(4ea) MLN5-0.8



12mm x 1.5 Stud
(16ea) PGLC-WSTUD-102



5/32x2" Cotter Pin
(4ea) CP5322Z



1/2" Rotor Spacer
(16ea) PGLC-ROTOR-SP



1/2" Loom Clamp
(4ea) WL-CLAMP-12



Red Loctite (1ea)
LOCTITE-02
Blue Loctie (1ea)
LOCTITE-02-B



1/4" Clear Hose
(3ft) SK-VT-1



FRONT Caliper
Mount Bracket (2ea)
PGLC-BCB-115N



8" Zip Tie
(16ea) T50RB



REAR Caliper
Mount Bracket (2ea)
PGLC-BCB-118o

Brake Line (107A)	LENGTH
FRONT RIGHT	54"

Brake Line Kit (96A)	LENGTH
REAR LEFT	60"
REAR RIGHT	70"



The new larger spindle castle nut provided in this kit will require using a 46mm socket. We offer one to purchase if you do not have one.

**Part #
PGLC-SOCKET-46MM**

FRONT LEFT
DRIVER SIDE (DR)
LEFT HAND (LH)

↑
FRONT

FRONT RIGHT
PASSENGER SIDE (PA)
RIGHT HAND (RH)

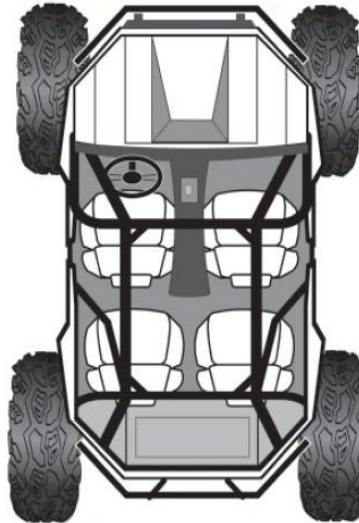

REAR LEFT
DRIVER SIDE (DR)
LEFT HAND (LH)

REAR RIGHT
PASSENGER SIDE (PA)
RIGHT HAND (RH)

FRONT INSTALLATION

1. PREPARE VEHICLE, FRONT [PASSENGER SIDE]

- Begin by loosening the lug nuts on both front tires.
- Using a suitable lifting device or jack, raise the unit until the front tires are off the ground an additional 6".
- If using a floor jack with stands, chock the rear wheels to prevent the unit from rolling. If using jack stands, make sure the stands are placed under the frame and not the body.
- Make sure the unit is stable and secure. Remove lug nuts and front wheels.

2. REMOVAL OF FRONT BRAKE CALIPERS AND HUBS

- Remove the upper & lower caliper mounting bolts (15mm). Retain the factory bolts & nuts.
- It is not necessary to remove the brake line from the caliper at this time. Leave the brake hose attached to the caliper and hang the calipers out of the way. Take precautions to ensure the brake hose isn't stretched or pinched.
- Remove the plastic shield and front scraper (8mm).

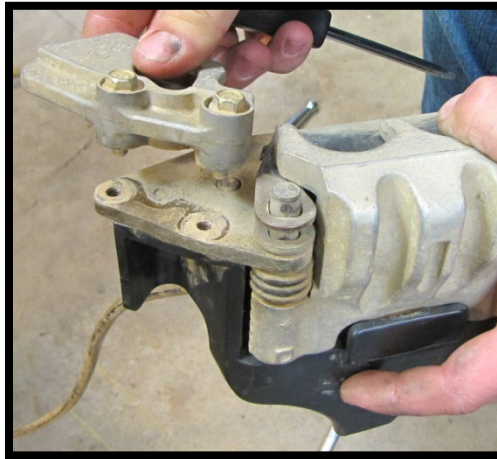
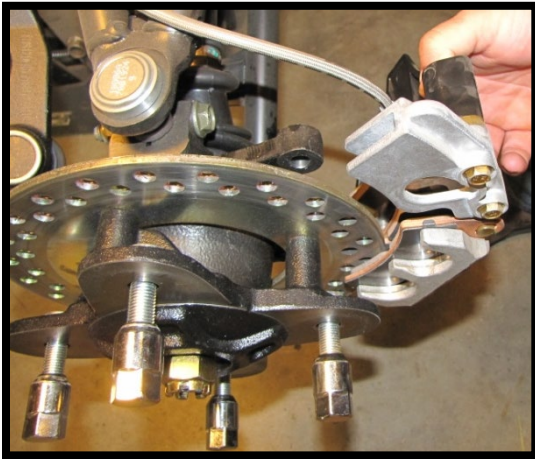

- Remove the cotter pin and the front wheel hub castle nut. (27mm)
- Remove the hub and the front brake rotor assembly.
- Disconnect the tie rod. (18mm)

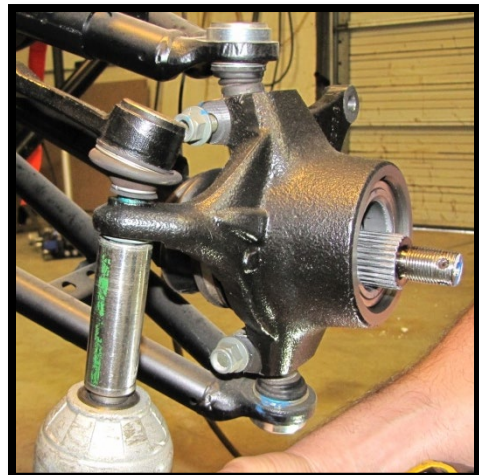
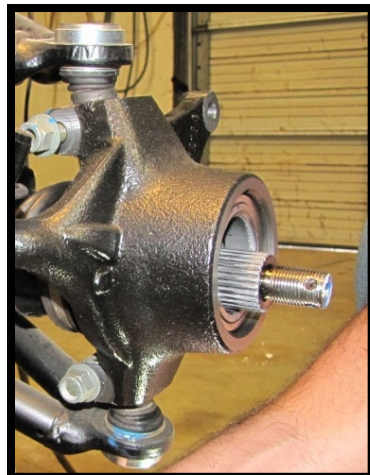
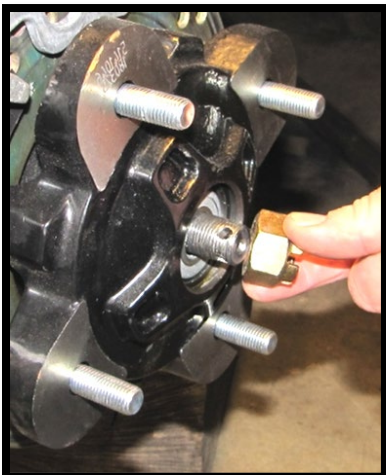

- g. Remove the upper ball joint from the knuckle (15mm). You may need a mallet to break it free.
- h. Remove the lower ball joint from the knuckle (15mm).
- i. Remove the knuckle and retain factory hardware.

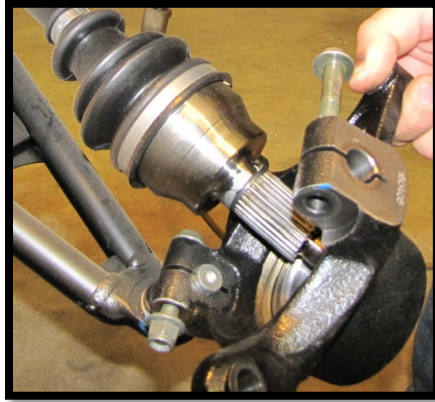
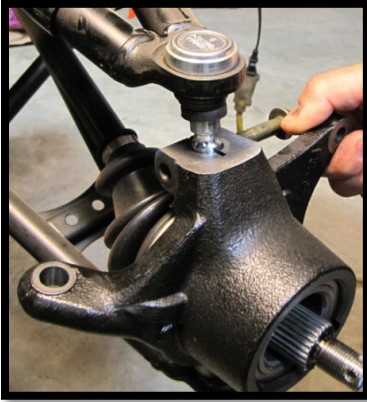

3. FRONT BACKING PLATE INSTALL

- a. Find the **front right backing plate (101i-R)**.
- b. Insert the drive shaft into the backing plate. Then place the upper ball joint into the upper ball joint mount bracket. Fasten it with the factory hardware. (15mm)[50 ft lbs]
Note: You may need to clean powder coating from the holes.



- c. Properly position the lower ball joint into the lower ball joint mounting bracket on the backing plate assembly. Then fasten the front lower ball joint with the factory hardware. (15mm)[50 ft lbs]
Note: You may need to clean powder coating from the holes

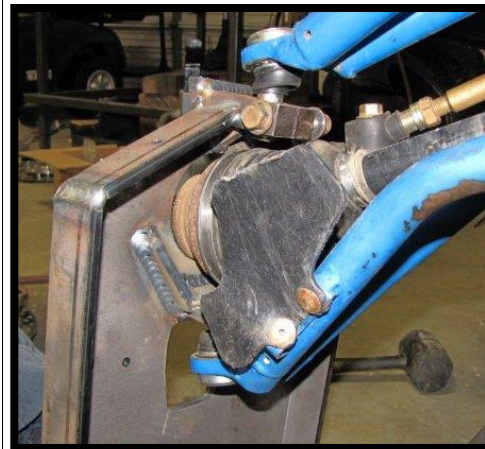
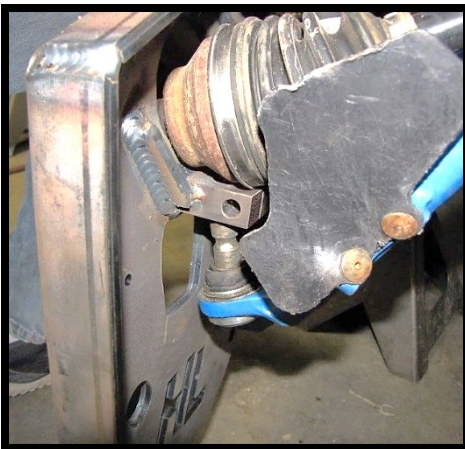

4. FRONT PORTAL BOX ASSEMBLY

- a. Find an **assembled portal box**.
- b. Remove the 1/4-20 x 3/4" screws, cap, & gasket from the lid of the portal box.



- c. Find the caliper mounting bracket **PGLC-BCB-115N** and place it in the corresponding fitted front section of the portal box. Then insert a 1/2 x 4-3/4" bolt and 1/2" washer into the bracket holes & box.



- d. Slide a 1/2" flat washer onto (4) 1/2 x 4-1/2" bolts and insert them into the remaining four holes of the box.



5. INSTALL FRONT PORTAL BOX

- a. Apply water-resistant grease to the drive splines. Be sure to apply product all around the outer edge as well.
- b. Rotate the portal box assembly 'Up & In' as you guide the drive shaft axle through the inner drive gear.
- c. Insert the bolts through the corresponding holes in the backing plate.



- d. Loosely fasten the all six bolts with **1/2" flat washers** and **1/2" lock nuts**. Recheck all parts that were used and make sure everything fits correctly, and then go ahead and fasten all bolts. (3/4)[105 ft lbs]



- e. Install the tie rod end into the backing plate tie rod mount bracket. Fasten the tie rod end with the factory hardware. (18mm)[90 ft lbs]

NOTE: If you are using our High Lifter Big Lift or Front Forward Arms in conjunction with this portal kit, you may need to drill out the tie rod mount bracket to utilize the steering hardware you are currently using.

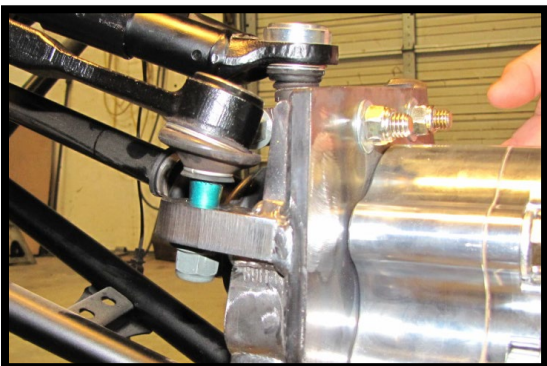

6. INSTALL FRONT DRIVE SHAFT NUT & PORTAL BOX LID CAP

- a. With the portal box assembly in place, double check that the factory axle shaft is properly aligned into the drive gear of the portal box.
- b. Apply **LOCTITE (BLUE)** to the supplied M18 axle nut with shoulder **PGLC-AXNUT-4**, then tighten & torque onto the drive shaft axle. (30mm)[20 ft lbs]

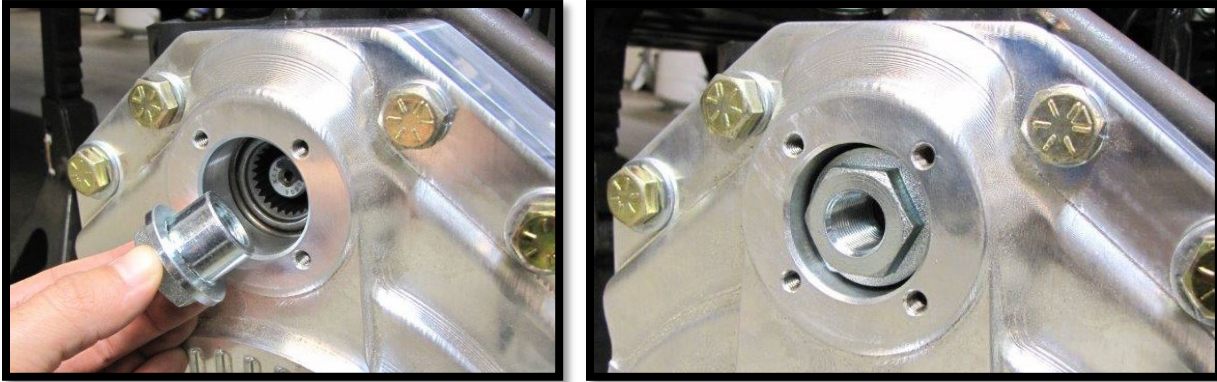

- c. Align the portal box lid cap & gasket. Use the **1/4-20 x 3/4"** screws and install to the box. (3/16)[8 ft lbs]

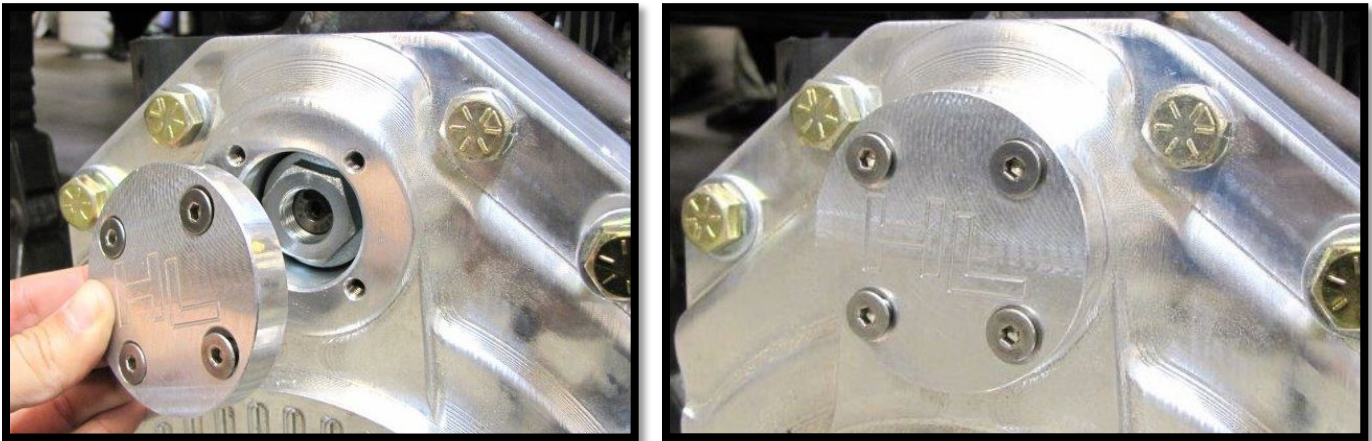

7. ASSEMBLE ALL BRAKE ROTORS & WHEEL HUBS

- a. Locate all (4) **PGLC-HUB-201** multi pattern hubs so they can all be assembled at the same time. They are designed to work with different bolt patterns.
NOTE: They may have oil on them to prevent corrosion. If so, you will need to use a cleaner and remove most of the oil.
- b. One side of the hub has a shorter lip than the other. This side will face away from the UTV when installed. Place this side face down on your working surface for the following steps.

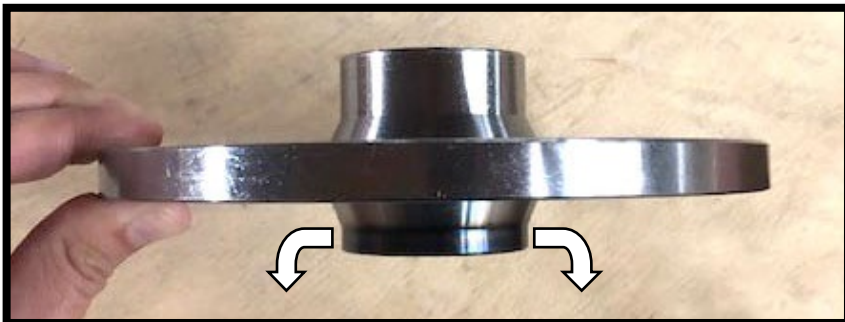

- c. With the shorter lip side faced down, find the bolt pattern that corresponds to your make and model. Use the provided studs **PGLC-WSTUD-102 (12mm-1.5 stud) (4/156mm bolt pattern)**

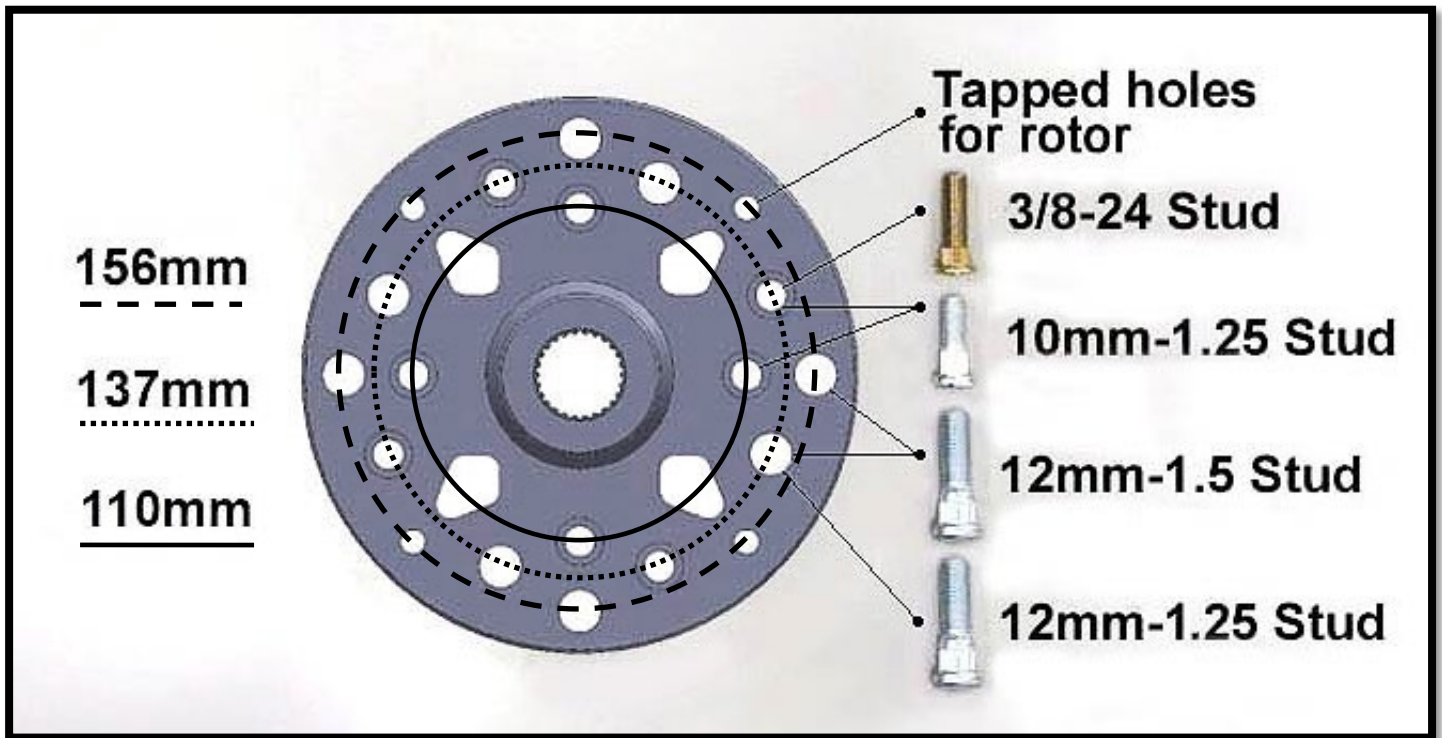

- d. You can use a press to install the studs. You can also use large sockets as spacers to press them in. **Take care not to press the studs into the threaded tapped holes for the rotor!**

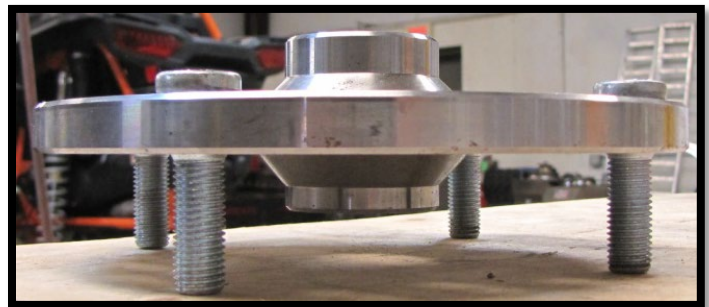
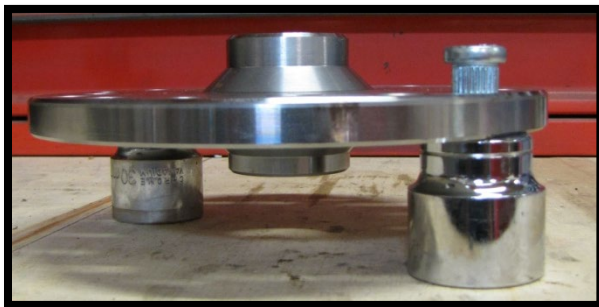

- e. Once the studs are pressed in, place (4) ½" brake rotor spacers PGLC-ROTOR-SP over the tapped holes.



- f. Locate a brake rotor PGLC-ROTOR-3. Place the rotor on to the hub and line the holes up with the rotor spacers and tapped holes.

NOTE: They may have oil on them to prevent corrosion. If so, you will need to use a cleaner and remove most of the oil.



- g. Slide a 3/8" lock washer onto (4) 3/8 x 1-1/4" hex head bolts. Apply LOCTITE (RED) to each screw. Insert them through the rotor, the spacers, and then into the hub. Tighten and torque. (9/16) [45 ft lbs]



8. INSTALL FRONT BRAKE ROTOR ASSEMBLY

- a. Apply water resistant grease to the spindle splines and slide the brake rotor assembly onto the spindle shaft.

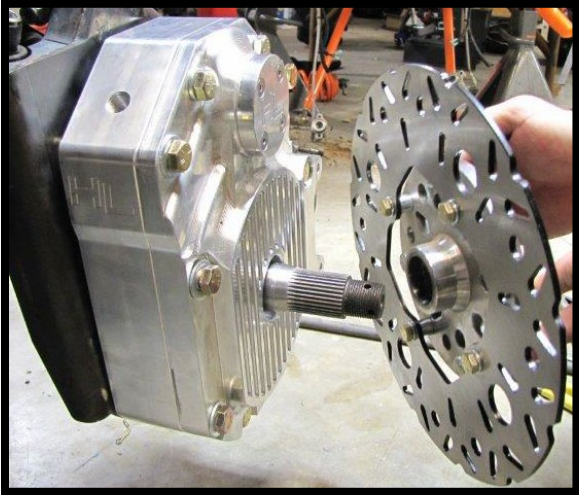

- b. Slide on the supplied **30mm lock washer**, followed by the **30mm spindle castle nut**. (46mm) [**Min 120 ft lbs**] Tighten the castle nut further if needed to align grooves with holes in the spindle for the cotter pin. Install the supplied **cotter pin**. Both ends of the cotter pin must be folded.

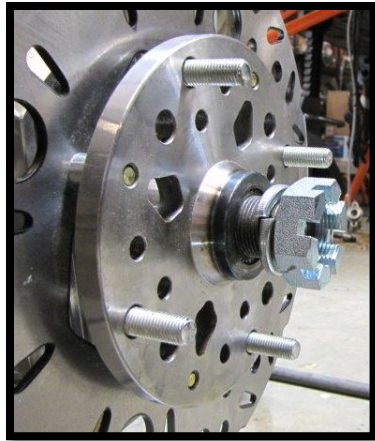
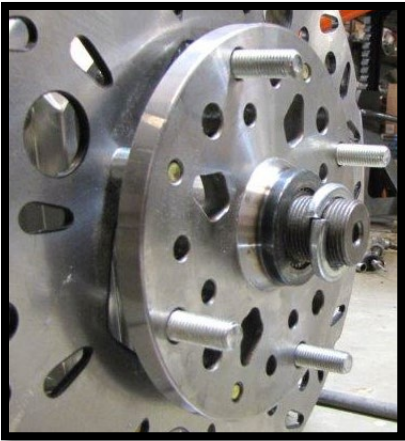

9. INSTALL FRONT BRAKE CALIPERS

- a. Disconnect the front calipers from the factory brake lines. Have a container to collect brake fluid.
- b. Install the caliper onto the portal box between the new caliper bracket and rotor. Use the factory mounting bolts. (15mm) [30 ft lbs] **NOTE: Remember, the bleed off valve always goes to the TOP of the caliper.**

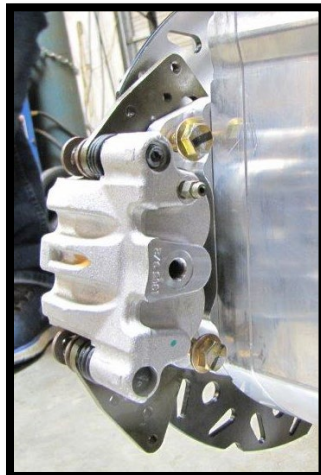

10. INSTALL & ROUTE FRONT BRAKE LINES

(PA) = Passenger Side (DR) = Driver Side

Here is what you will be doing in the following steps... Take the new extended length brake line and install it on the (PA) side. Take the factory (PA) side brake line and install it on the (DR) side. Remove the original (DR) side brake line and put it in a Zip-Loc bag and label it - (DR) side front. Put it where you can find it if needed. (It will not be reused during this installation).

- Disconnect and free the brake lines from any retaining clips or ties that hold them in place on the upper control arms and frame.
- Find the master cylinder on the (DR) side. First, unplug the connector. Then disconnect the banjo bolt and brake lines from the master cylinder. Make sure to save the washers from the factory that separate the two front lines.

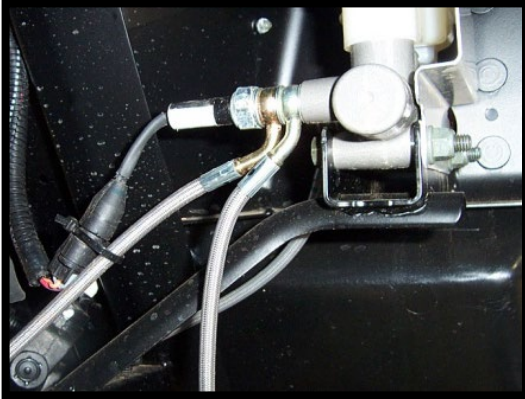

- Install the new longer brake line **107A** to the banjo bolt. Run the line back through the frame and to the (PA) side hub.



- Use the existing factory (PA) side brake line and install it to the banjo bolt. This is replacing the factory (DR) side brake line.



- The factory brake line banjo bolt should be in this sequence: **bolt, washer, (PA) extended length brake line, washer, (DR) brake line, and washer.**
- Tighten & torque banjo bolt to master cylinder. (12mm) [50 ft lbs]
- Use the factory A-arm clips and the supplied **zip ties** to reposition the brake lines.

- h. Next, use a supplied **p-clamp (WL-CLAMP-12)** to secure the brake line to the front portal backing plate. Insert a **5mm x 20mm bolt** through the clamp and backing plate, followed by a **5mm washer** and **5mm lock nut**.

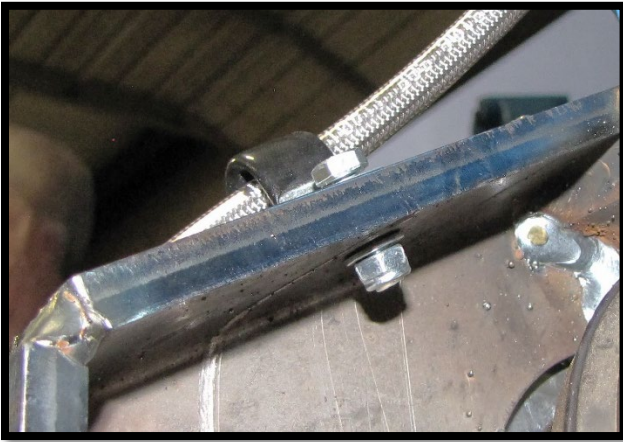

- i. Use the factory A-arm clips and the supplied **zip ties** to reposition the brake lines, then fasten the brake line back to the caliper. **Make sure there's no binding in the lines, even at full turn.**



REAR INSTALLATION

11. PREPARE VEHICLE, REAR [PASSENGER SIDE]

- a. Begin by loosening the lug nuts on both rear tires. Using a suitable lifting device or jack, raise the unit until the front tires are off the ground an additional 6”.
- b. If using a floor jack with stands, chock the front wheels to prevent the unit from rolling. If using jack stands, make sure the stands are placed under the frame and not the body.
- c. Make sure the unit is stable and secure. Remove lug nuts and rear wheels.

12. REMOVAL OF REAR BRAKE CALIPERS & HUBS

- a. Remove the upper & lower caliper mounting bolts. Retain the factory bolts & nuts. They will be reused during the installation of the Portal Boxes & Mounting Brackets. (15mm)

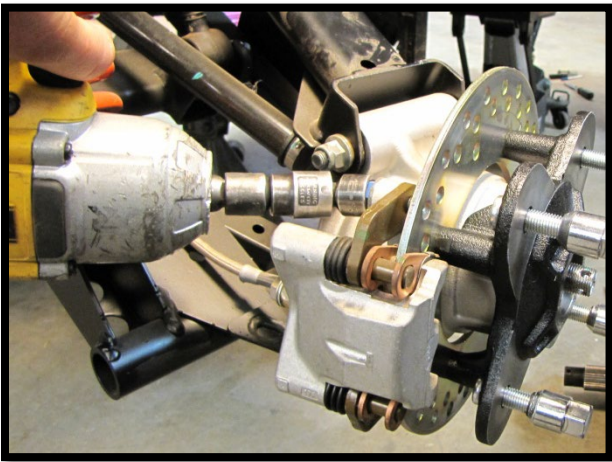

- b. Remove the caliper from the rear hub. It is not necessary to remove the brake line from the caliper at this time. Leave the brake hose attached to the caliper and hang the calipers out of the way. Take precautions to ensure the brake hose isn't stretched or pinched.

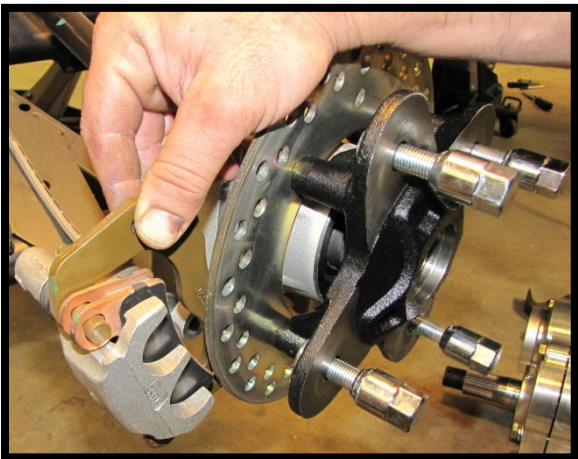

- c. Remove the cotter pin and loosen the rear wheel hub castle nut (27mm). Remove the nut from the rear wheel hub assembly. Then remove the brake rotor assembly.

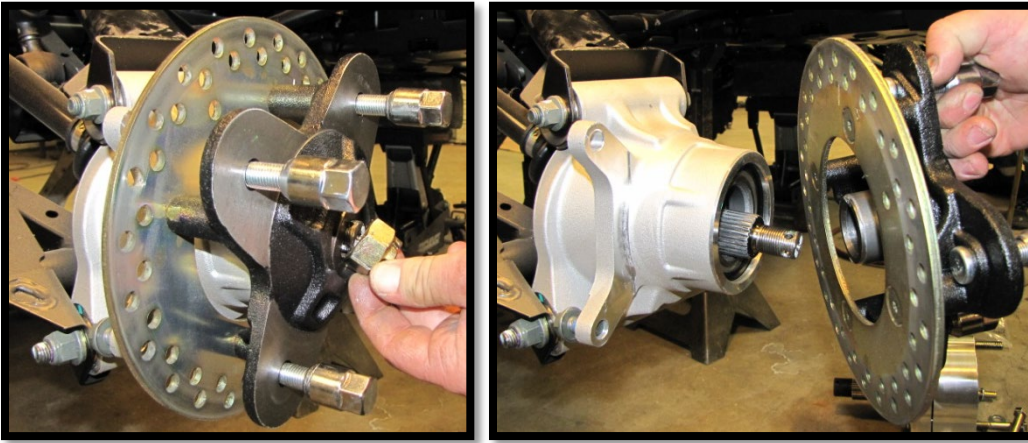

- d. Remove the bolts and nuts that attach the rear knuckle to the upper & lower A-arms. Retain the factory hardware. They will be reused during the installation of the Portal Boxes & Mounting Brackets. (15mm)
e. Remove the rear knuckle.

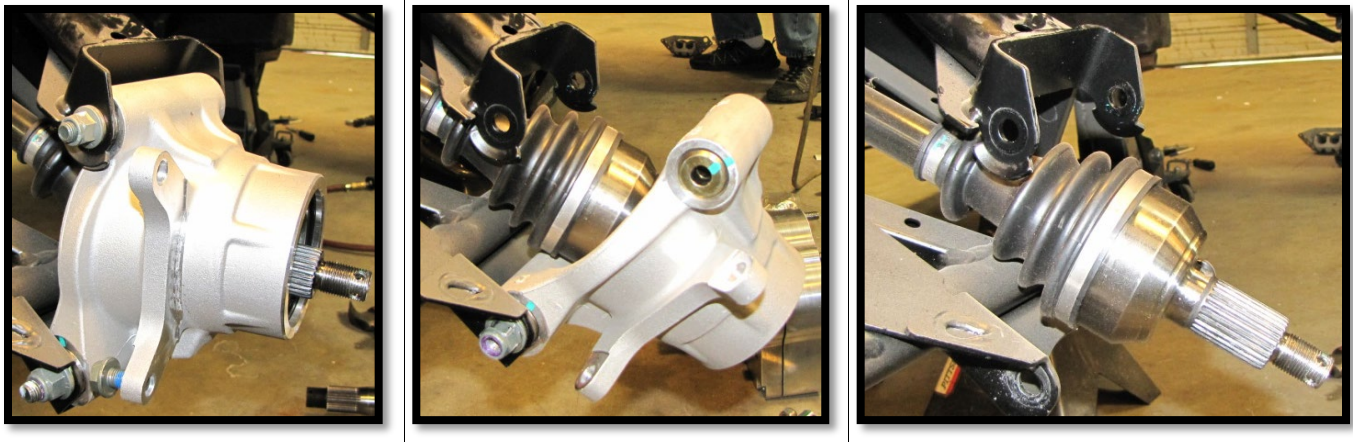

- f. While you have the knuckle removed and have more access to the lower arm. You will need to drill/remove the rivet of the p-clamp on the lower factory arm (Or you can simply cut the clamp if you don't want to re-use it). Doing this now will make the new rear brake line installation easier later in the instructions.



13. INSTALL BUSHINGS INTO BACKING PLATE ASSEMBLY

- a. The factory bushings and pivot tubes will be re-used if they are in good condition.
- b. To remove the bushings from the knuckle, slide the pivot tubes out and then remove the bushings. You may need to use a drift punch/drift pin. Inspect the bushings and pivot tubes for excessive wear or damage. If these items have excessive wear or damage, they need to be replaced.

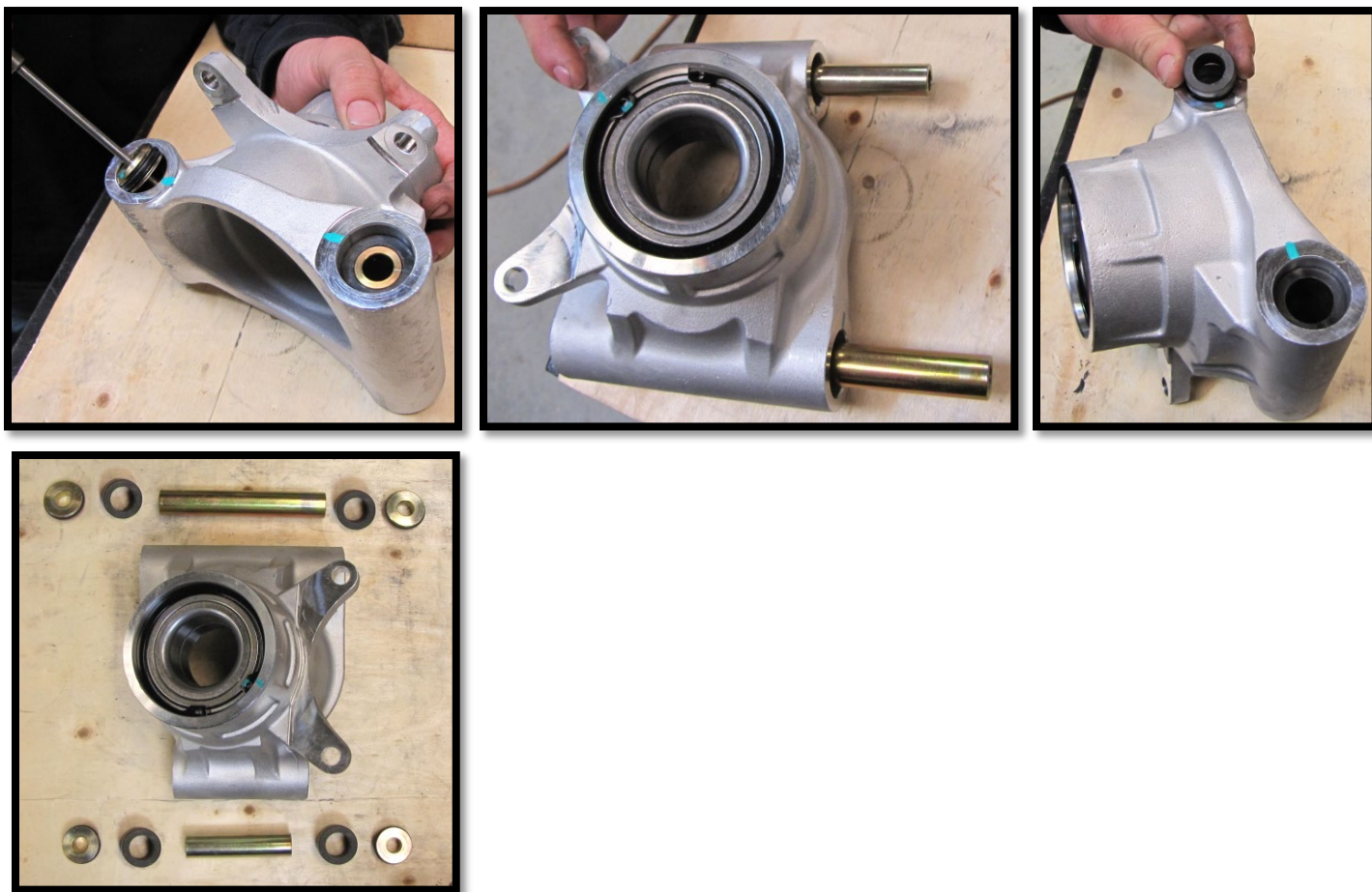

- c. Insert the bushings, pivot tubes, and pivot caps into the collars of the **rear right backing plate (101J-R)**.
NOTE: We recommend applying good water-resistant grease to the bushings and especially the pivot tube. This will help prevent excessive friction & wear plus add longevity to the life of the bushings and pivot tube.

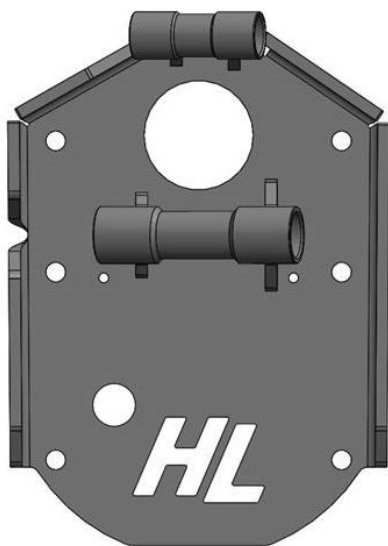

14. INSTALL REAR BACKING PLATE ASSEMBLY

- a. Place the backing plate into position on the control arms and guide the drive shaft through. Using the factory hardware, fasten to the lower control arm. (15mm)[90 ft. lbs] Then fasten to the upper control arm. (15mm)[50 ft. lbs]

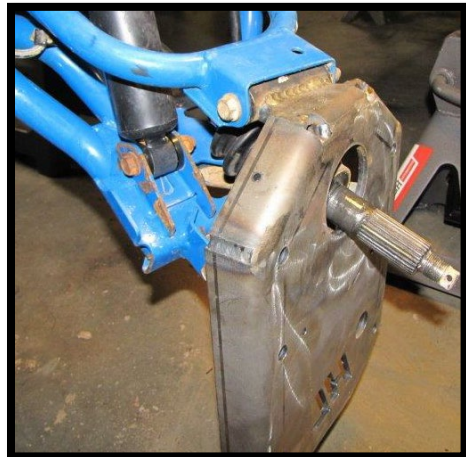

15. REAR PORTAL BOX ASSEMBLY

- a. Find your assembled rear portal box.
- b. Remove the 1/4-20 x 3/4" screws, cap, & gasket from the lid of the portal box.



- c. Find caliper mounting bracket **PGLC-BCB-118o** and place it in the corresponding fitted REAR section of the portal box. Then insert a **1/2 x 4-3/4" bolt** and **1/2" washer** into the bracket holes & box.

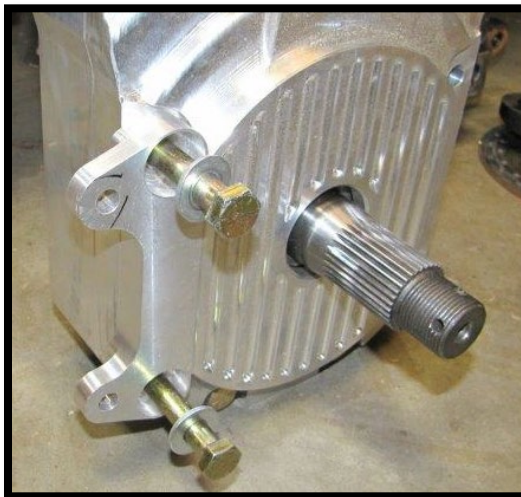

- d. Slide a **1/2" flat washer** onto (4) **1/2 x 4-1/2" bolts** and insert them into the remaining four holes of the box.



16. INSTALL REAR PORTAL BOX

- Apply water-resistant grease to the drive splines.
- Rotate the portal box assembly 'Up & In' as you guide the drive shaft axle through the inner drive gear.
- Insert the bolts through the corresponding holes in the backing plate.



- Loosely fasten the all four bolts with **1/2" flat washers** and **1/2" lock nuts**. Recheck all parts that were used and make sure everything fits correctly, and then go ahead and tighten and torque all bolts. (3/4)[105 ft lbs]



17. INSTALL REAR DRIVE SHAFT JAM NUT, SPINDLE SPACER, & PORTAL BOX LID CAP

- a. With the portal box assembly in place, double check that the factory axle shaft is properly aligned into the drive gear of the portal box.
- b. Apply **LOCTITE (BLUE)** to the supplied M18 axle nut with shoulder **PGLC-AXNUT-4**, then tighten & torque onto the drive shaft axle. (30mm)[20 ft lbs]

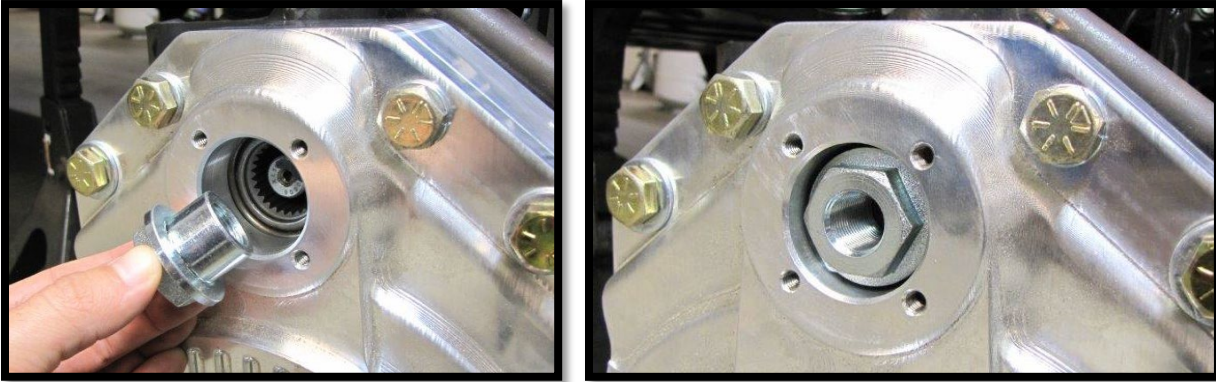

- c. Align the portal box lid cap & gasket. Use the **1/4-20 x 3/4"** screws and install to the box. (3/16)[8 ft lbs]

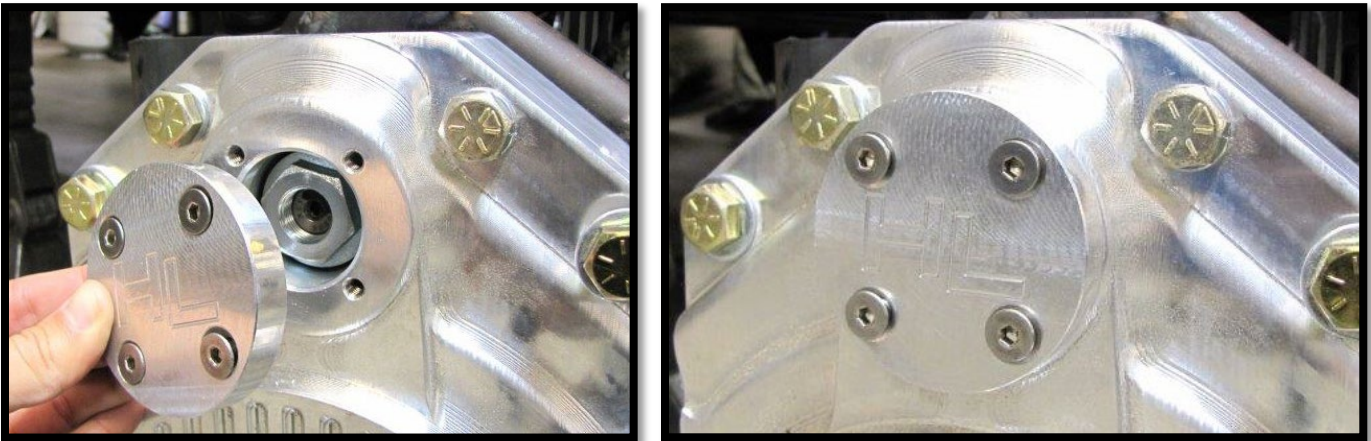

18. INSTALL REAR BRAKE ROTOR ASSEMBLY

- a. Apply water resistant grease to the spindle splines and slide the brake rotor assembly onto the spindle shaft.

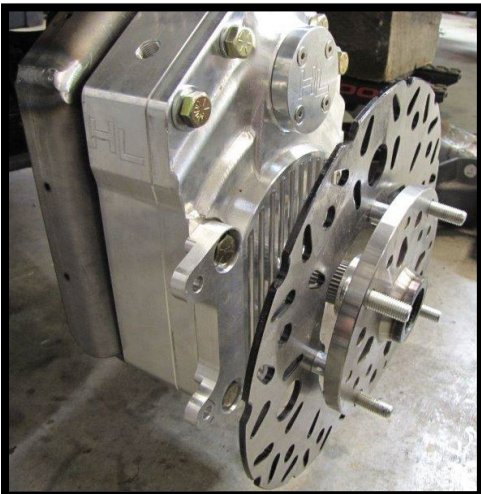

- b. Slide on the supplied **30mm lock washer**, followed by the **30mm spindle castle nut**. (46mm) [Min 120 ft lbs] Tighten the castle nut further if needed to align grooves with holes in the spindle for the cotter pin. Install the supplied **cotter pin**. Both ends of the cotter pin must be folded.

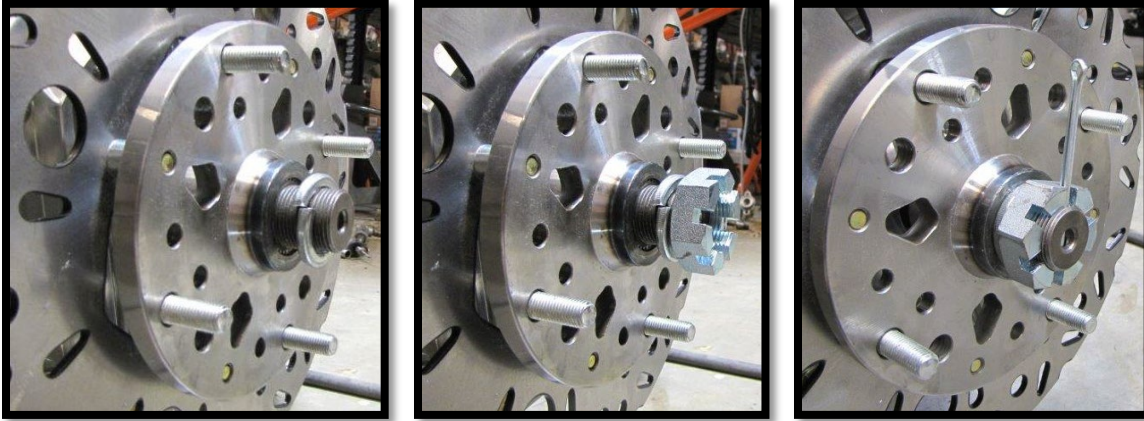

19. INSTALL REAR BRAKE CALIPERS

- a. Disconnect the rear calipers from the factory brake lines. Have a container to collect brake fluid.
- b. Install the caliper onto the portal box between the new caliper bracket and the rotor. Tighten & torque using the factory mounting bolts. (15mm)[30 ft lbs]

NOTE: Remember, the bleed off valve always goes to the TOP of the caliper.

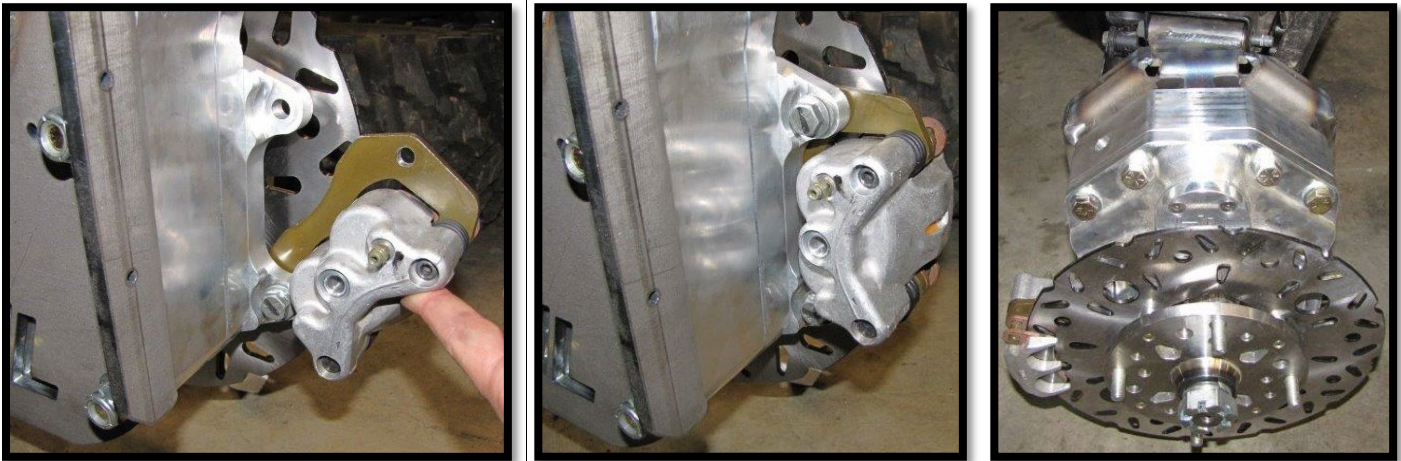

20. INSTALL & ROUTE REAR BRAKE LINES

- a. Raise the bed on the driver side.
- b. Disconnect and remove rear factory brake lines from the rear brake line block. Have a container to collect brake fluid.

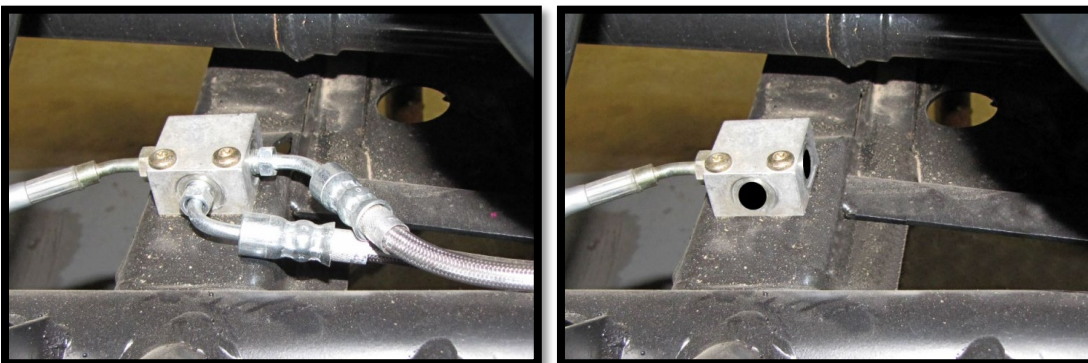

- c. Install the new **70" rear right** (pass. side) brake line to the t-block. It will need to be routed down the same passage where the factory line was.

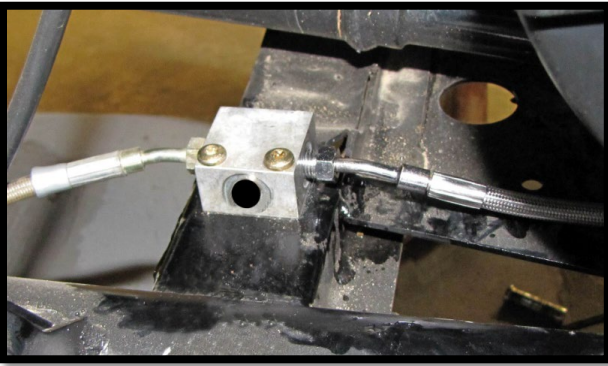

- d. Before installing the new **60" rear left** (driver side). First install the 3/8 adapter. The arched end should face out once installed. Now attach the brake line to the adapter.

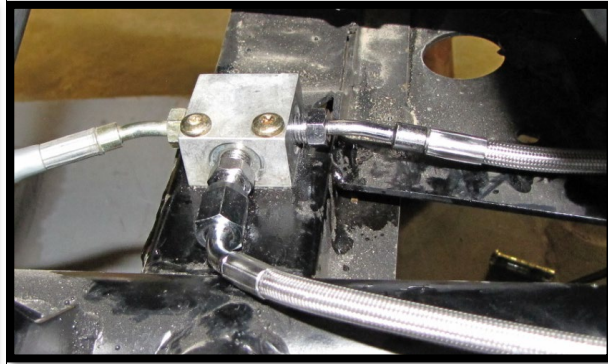
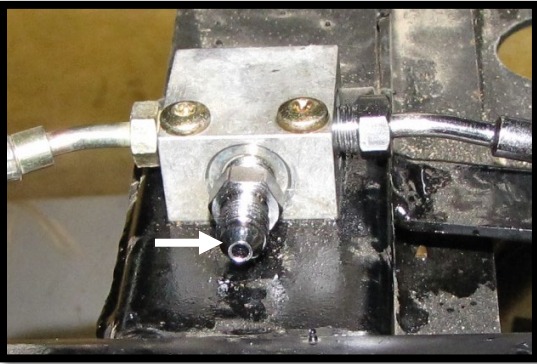

- e. Reattach the brake line to the calipers.

- f. Slide a **p-clamp (WL-CLAMP-12)** over the brake line. Secure it to the rear backing plate using a **5mm x 20mm bolt** through the clamp and backing plate, followed by a **5mm washer** and **5mm lock nut**.

NOTE: If you are routing the line back down the lower arm, secure the p-clamp to a lower hole on the backing plate.



- g. Secure the brake lines by using the provided **zip ties**. Make sure there is no binding in the lines once they are secured. (Re-using the factory clamps is optional, but you may need new hardware)

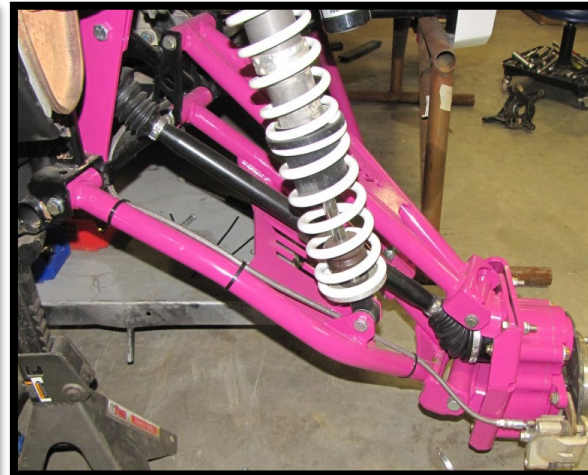
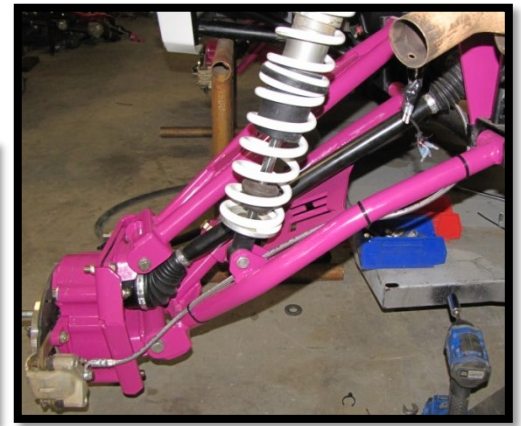

21. BLEED BRAKES

CAUTION: ALWAYS wear eye protection like safety glasses. Brake fluid will damage finished surfaces. Do not allow brake fluid to come in contact with finished surfaces.

- Bleeding the brakes is a two person job; you will need someone at the brake caliper and someone to pump the brake foot pedal. Take precautions due to the vehicle being on jacks and/or jack stands.
- Clean the master cylinder cover thoroughly and remove the cover.
- With all bleeder screws open, a gravity bleed is recommended to start with. This will push all the air out at once and eliminate most of the air bubbles. **(Have area prepared for spills and cleaning)**
- Add brake fluid to the indicated MAX level of the reservoir. (Any DOT 4 Brake Fluid)
- Close off each line once you steadily see fluid coming out.
- Begin final bleeding procedure with the caliper that is the farthest from the master cylinder. It should be this sequence - (PA) REAR, (DR) REAR, (PA) FRONT, and then (DR) FRONT.

g. You can use the supplied **clear hose** to attach to the caliper bleeder screw. Be sure the hose fits tightly on fitting. Now place the other end of the hose into a clean container.

h. Install a box end wrench on the caliper bleeder screw. Have your brake buddy slowly pump the foot pedal until pressure builds and holds. Have your buddy hold brake pedal down to maintain pedal pressure. Now slowly open the caliper bleeder screw 1/4" turn so the air and fluid will displace into the container.

i. Close bleeder screw, and then have your buddy release the foot pedal.
NOTE: Do not release foot pedal before the bleeder screw is tight or air may be drawn into the master cylinder... and you have to start all over again!

j. Check the master cylinder fluid level.

NOTE: You must maintain at least 1/2" (1.27cm) of brake fluid in the reservoir to prevent air from entering the master cylinder

k. Repeat steps until clean fluid appears in the bleeder hose & all the air has been purged... Close bleeder screw, pump brakes, hold pressure, open bleeder, close bleeder, release foot pedal, check master cylinder.

l. Tighten bleeder screw securely and remove bleeder hose. Torque the bleeder screw. [4 ft lbs]

m. **REPEAT** procedure steps for the other three (3) brake calipers in the sequence listed above.

n. Add brake fluid to MAX level inside master cylinder reservoir after the last caliper is completed. Install master cylinder reservoir cover. Check brake system for leaks.



22. FILL PORTAL BOXES WITH OIL

- a. Make sure the vehicle is positioned securely and 'Level'. If necessary, until the portal box assembly is level with the ground: front to back and side to side.
- b. Use **SAE 80W-90 oil**. This gear lubricant is designed for gears operating under severe temperature and load conditions, and whose SAE 80W-90 viscosity grade offers extended drain performance.
- c. On the top of the box is the vent hole and plug. Using an Allen wrench, make sure the plug is tightened. [20 ft lbs] (8mm) **NOTE: A optional vent line kit will be available to purchase in the future.**
- d. On the bottom of the box is the drain hole and plug. Make sure the plug is tightened. [20 ft lbs] (8mm)
- e. On the lower backside of the backing plate is an opening for the portal box fill hole and plug. (It is always toward the front of the vehicle.) Remove the fill plug. (8mm)
- f. Take the gear oil bottle and fit the spout into the fill hole. You can gently 'Squeeze' the bottle to help the process.
- g. **Fill the portal box until the fluid starts draining back out of the fill hole.** Then reinstall the fill plug. [20 ft lbs]
CAUTION: Do not over fill past the fill plug. If the oil heats up or expands, it will cause the oil to exhaust out the axle seal.

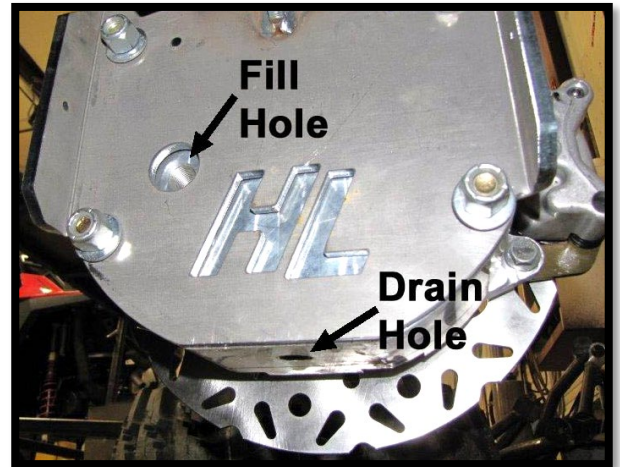

23. INSTALL WHEELS

Wheel Requirements:

- 18" or larger wheel required
- 18" wheels cannot exceed 4-1/2" backspacing
- 20" and larger wheels cannot exceed 5" backspacing

Tire Requirements:

- Up to 30" Stock
- 31" with 3" Lift Kit
- 32" to 33" Forward Kit 1.5"
- 34" Forward Kit and Lift Kit
- 35" to 37" Big Lift Kit (45%)
- 38" to 39" Big Lift Kit (45% or 60%)
- 40" and UP Big Lift Kit (STRONGLY SUGGEST 60%)

- a. Install wheel lug nuts and securely tighten.
- b. Remove all jacks, jack stands, and other devices used to lift and hold the vehicle.
- c. With the suspension supporting vehicle weight, torque the wheel lug nuts using an "X" tightening pattern.

Aluminum wheels = [90 ft lbs]

Steel wheels = [50 ft lbs]

WARNING: Retighten lug nuts at eight (8) hours after any wheel change or anytime wheel nuts are loosened. Failure to do so could cause wheels to come off while the vehicle is in motion. This is a warning and reminder.

REMEMBER: You just bled the brakes, unbolted and bolted steering and drive train components, added more take-off torque and made many changes by adding the portal boxes. FIELD TEST this machine at LOW speed before putting into full time Play or Work Mode. Check the brakes for proper braking action & pedal reserve.

24. FRONT ALIGNMENT

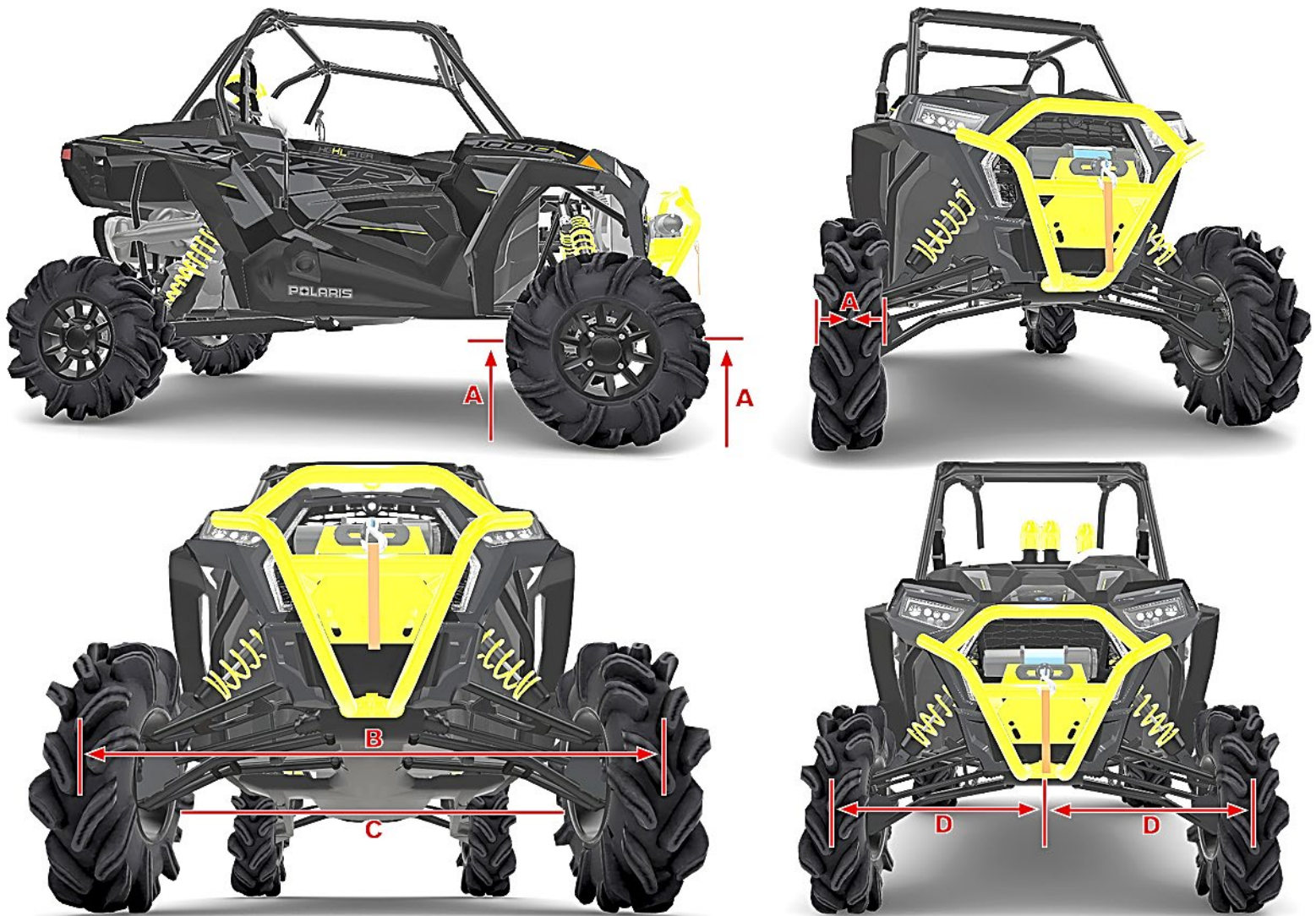

Place the machine on a smooth level surface and set the steering wheel in a 'straight ahead' position. Secure the steering wheel in this position.

- Measure from the floor and place a chalk mark at the center of both front tires. You need mark it at the front and at the rear of each tire, and as close to the hub center line as possible.
NOTE: It is important the height of both marks be equally positioned to get an accurate measurement.
- In the 'Front' of the tires, measure the distance between the center mark of the (LH) tire to the center mark of the (RH) tire. Record the measurement as 'B'.
- In the 'Rear' of the tires, measure the distance between the center mark of the (LH) tire to the center mark of the (RH) tire. Record the measurement as 'C'.

Subtract measurement 'C' from measurement 'B'. The difference between measurement 'B' and 'C' is the vehicle toe alignment. ($B - C = \text{Toe Alignment}$)

The recommended vehicle toe tolerance is 1/8" to 1/4" (3.175-6.35mm) toe out. This means the front measurement (B) is wider than the rear measurement (C).

- d. If the toe alignment is incorrect, measure the distance between vehicle center and each wheel (use the chalk mark as wheel center). This will tell you which tie rod needs adjusting.

IMPORTANT NOTE: Be sure the steering wheel is straight ahead before determining which tie rod needs adjustment. When tightening the tie rod end jam nuts, the tie rod ends must be held parallel to prevent rod end damage and premature wear. Damage may not be immediately apparent if done incorrectly.

To adjust the toe alignment, hold the tie rod end to keep it from rotating. Loosen the jam nuts at both ends of the tie rod. Shorten or lengthen the tie rod (screw it in or screw it out) until alignment is as required to achieve the proper 'Toe Out' front setting.

After alignment is complete, tighten & torque tie rod end jam nuts to specifications. [12-14 ft lbs]

25. WARNING DECALS

NOTICE TO DEALER, INSTALLER, AND VEHICLE OWNER:

Any vehicle equipped with a portal gear lift must have the "WARNING Rollover Hazard" decals installed on the inside of the windshield or on the vehicle's dash, within driver's view.

INSTALLING DEALER:

It is your responsibility to install warning decals and forward these installation instructions to the vehicle owner for review of warnings, product use, and maintenance information. Replacement Warning Decals are available FREE upon request. These instructions are to be kept with the vehicle registration.

The **WARRANTY IS VOIDED** unless the official decals are in place.

Thank You
For Choosing
HIGHLIFTER

High Lifter Portal Gear Warranty Program

Thank you for purchasing a High Lifter Products Portal Gear Lift. Our Portal Gear Lifts have been engineered to provide superior performance on your ATV/UTV.

LIMITED LIFETIME WARRANTY:

HIGH LIFTER PRODUCTS, INC. warrants to the **ORIGINAL** purchaser of any Portal Gear Kit for a lifetime of protection from the date of purchase against defects in materials or workmanship, subject to the following conditions:

- a) The product must be properly installed according to all installation instructions.
- b) **HIGH LIFTER** is not liable for any incidental or consequential damages to anything other than the Portal Gear Kit covered by this warranty. **HIGH LIFTER** is not liable for any incurred expenses, labor costs to install/remove/reinstall Portal Gear Kit or any OEM or aftermarket components, loss of use of machine, damage to housings or damage to any aftermarket accessory or OEM components.
- c) If the Portal Gear Kit has been disassembled or modified by a third party, the warranty is null and void.
- d) Any Portal Gear Kit damaged in a collision with any object is excluded from this warranty. However, the Portal Gear Kit may be refurbished for a fee upon repair authorization by the owner. Costs will vary depending on the condition of each Portal Gear Kit assembly.
- e) Warranty is non-transferable from the **ORIGINAL** purchaser.
- f) **HIGH LIFTER** reserves the right to inspect the Portal Gear Kit for determining if there were any defects in the installation and to determine the validity of any warranty claim. The warranty process may require the **ORIGINAL** purchaser to provide photographs of the ATV/UTV and its installed Portal Gear Kit.
- g) Items that will not be covered under the warranty are but not limited to: Bearings, Seals, Gaskets, and Wheel Studs. All other components in kit are subject to review by **HIGH LIFTER** to determine reason for failure and if they meet requirements for warranty coverage.
- h) Warranty will be void on products that show; misapplication, improper installation, abuse, lack of proper maintenance, negligence, or alteration from original design.
- i) Any parts used to repair a portal kit must be purchased from **HIGH LIFTER** or warranty will be voided. For safety reasons it is important that the proper fastener grade, thread engagement, and torque specification be followed to prevent parts from failing. See instructions for torque data/specifications.

REFUSED SHIPMENTS/ORDER CANCELLATION:

Refused shipments are subject to a 20% restocking fee plus all associated freight costs. It is our goal to ship all orders in a timely manner. If a customer wishes to cancel an order (provided it is not a special-order product), it is the responsibility of the customer to cancel the order prior to the product being shipped. If a customer cancels an order after product has been shipped, they refused shipment, cancellation, or return will be subject to a 20% restocking fee and any freight charges incurred. For orders outside the United States, any fees associated with customs or duties are non-refundable.

DAMAGED SHIPMENTS:

All claims for damaged shipments must be made within 72 hours of delivery to the point of destination. Any damage to package should be noted with carrier at the time of delivery if possible. We will not be responsible for damage claims made over 72 hours after delivery to the point of destination.

OBTAINING A WARRANTY CLAIM:

All returns for warranty must be pre-approved by calling 1.800.699.0947. After warranty approval has been granted and a Return Merchandise Approval (RMA) number issued, the Portal Gear Kit must be received by HIGH LIFTER PRODUCTS within 15 calendar days. The RMA number must be clearly displayed on the return box or the return will be refused. An RMA number does not imply that a replacement or refund will be issued on any product, but only that we will inspect the Portal Gear Kit for warranty claims. For orders outside the United States, any freight or fees associated with customs and duties are the responsibility of the purchaser and are non-refundable. All claims must be accompanied by the sales receipt detailing date and place of purchase, a written explanation of the problem, a phone number, and e-mail address. A copy of this receipt must be included with the Portal Gear Kit submitted for warranty repair or replacement. The purchaser is responsible for any freight charges on all warranty claims, including incoming freight to High Lifter and return freight to the purchaser.



High Lifter Products Warranty Claim

Name: _____

Address: _____

Phone Number: _____

E-Mail Address: _____

Portal Gear Kit Product Number: _____

Place of Purchase: _____

Date of Purchase: _____

Reason for Return: _____

Return Merchandise Authorization (RMA) Number: _____

High Lifter Products
780 Professional Drive North • Shreveport, Louisiana • 71105
1.800.699.0947
www.HighLifter.com