

## **POWERPUBS**

---

**PLANO, TX**



# **Polishing Aluminum Alloy Harley Parts**

# Polishing Aluminum Alloy Harley Parts

---

This anniversary publication is dedicated to the memory of:

William Harley and Arthur Davidson

Walter Davidson

William Davidson

And all those dedicated to the pride and enjoyment  
of the most unique of experiences: a Harley-Davidson

This first edition is copyright free and may be used and reproduced by anyone by  
any means that is in the interest of Harley-Davidson motorcycle enthusiasts.

2004 Country Club Drive • Plano TX 75074  
nodawgs1@attbi.com

## About the Front Cover

This immaculate, fully polished chopper was designed and built by Doug Card. The frame is a 1956 "K" model with a bolted on hardtail section. The engine is a 1964 Sportster with .080 removed from the jugs. Cams are stock "P" cams and the carb is a modified Keihin butterfly with a Thunderjet. The front wheel is a 1957 BSA Goldstar that's been chromed and re-laced with stainless spokes. The rear wheel is a Hallcraft with chrome spokes. The rear brake is a homemade disc setup using a Hurst/Airhart caliper. The seat is homemade using "K" model internal seat post springs and Big Twin buddy seat springs on the outside. The wheel spacers and magneto advance/retard base are also homemade.

## Trademark Acknowledgements

All terms mentioned that are known to be trademarks or service marks have been appropriately capitalized. The use of a term in this manual should not be regarded as affecting the validity of any trademark or service mark.

## Acknowledgements

Special thanks are extended to contributors noted herein for their contributions used to graphically depict various aspects of aluminum alloy polishing.

## Disclaimer

Every effort has been made to make this document as complete and accurate as possible, but no warranty or fitness is implied. This information is provided on an "as is" basis. The author, PowerPubs, and any business entity mentioned herein shall have neither liability nor responsibility to any person or entity with respect to any loss or damages arising from the information contained in this document.

## About the Author

"Nodawgs" is an electrical and mechanical engineering generalist, technical writer, watermelon hauler, and exotic dancer that found his way out of the Tennessee hills only by falling off a turnip truck making a hard right turn. The writing the author normally does is politically correct, formal business writing that is subjected to the whims of editors, resulting in thick hernia books no one gives a rat's ass about reading, anyway. Having written a zillion corporate documents when most folks of today still had tan poop, the author is even more convinced that crappy grammar, his native hayseed talk, and a little humor can communicate better to an audience of any level...and they actually like and use the stuff.

(Unintentionally left blank)

# Polishing Aluminum Alloy Harley Parts

*Doing a frame-up rebuild of an old vintage Harley or building a custom chopper? Perhaps, just polishing stock finishes to a mirror luster? For any of these, this manual reveals the metal finishing industries' secrets of polishing...except we go one better!*

**P**olishing aluminum alloy castings and machined parts takes a ton of time, is extremely labor intensive, and has got to be one of the messiest jobs on the planet. Matter of fact, if you want to know the truth, the best thing to use for polishing aluminum alloy parts is a pen and checkbook. However, if you're still up to it, keep reading...but don't say I didn't tell you.

What we're going to do here is show you how to do professional level polishing in your own garage or home-based shop. We're approaching this knowing that some folks might not know squat about polishing, so you people that have had a prior hand at this bear with me on the monkey-see, monkey-do part.

We're going to cover the tools, materials, polishing techniques, and routine maintenance of polished, bare aluminum alloy, mirror luster finishes:

- Surface preparation and cleaning
- Sanders and sanding
- Buffer motors
- Buffing wheels and accessories
- Polishing compounds
- Polishing Techniques
- Polishing Tips and Tricks
- Dust control
- Safety Precautions
- Retarding oxidation of finished work
- Periodic maintenance of mirror finishes

<b>1</b>	<b>POLISHING AND BUFFING AT A GLANCE .....</b>	<b>9</b>
	<b>Figure 1. General Polishing and Buffing Process for Aluminum Alloy Harley Parts.....</b>	<b>9</b>
<b>2</b>	<b>SURFACE CLEANING.....</b>	<b>9</b>
2.1	Inspection .....	10
<b>3</b>	<b>SANDING .....</b>	<b>10</b>
3.1	Sanders .....	10
	<b>Figure 2. Typical Electric Orbital Palm Sanders.....</b>	<b>11</b>
3.2	Sandpaper .....	11
3.2.1	Sandpaper Grits .....	11
	<b>Figure 3. Sandpaper Selection.....</b>	<b>12</b>
3.2.2	Sanding Out the Dings .....	14
	<b>Figure 4. Sanding Out Dings.....</b>	<b>15</b>
<b>4</b>	<b>POLISHING AND BUFFING MATERIALS AND TOOLS .....</b>	<b>16</b>
4.1	Buffer Motors .....	17
4.1.1	Makeshift, Rinky-dink, Thin-wallet, Buffer Motor.....	17
	<b>Figure 5. Half-inch Arbor for ¼-inch Drill .....</b>	<b>18</b>
	<b>Figure 6. Makeshift Buffer Motor Using a High-Speed Hand Drill .....</b>	<b>18</b>
4.1.2	General Purpose Motor Fitted with an Arbor .....	19
	<b>Figure 7. Arbor Extensions for Motor Shafts .....</b>	<b>20</b>
4.1.3	Specialized Buffer Motors .....	20
	<b>Figure 8. Buffer Motors .....</b>	<b>21</b>
4.1.4	Buffer Motor Stands.....	22
	<b>Figure 9. Full Clearance Buffer Motor Stand .....</b>	<b>23</b>
	<b>Figure 10. Home-made Buffer Motor Stand Dimensions .....</b>	<b>24</b>
4.2	Polishing and Buffing Wheels .....	24
4.3	Polishing and Buffing Compounds .....	25
4.4	Buffing Wheel and Compound Sources of Supply .....	25
4.4.1	Southwest Metal Finishing Supply Company.....	25
	<b>Figure 11. Southwest Metal Finishing Motorcycle Kit.....</b>	<b>26</b>
4.4.2	Formax Manufacturing Company.....	27
	<b>Figure 12. Formax Polishing and Buffing Materials .....</b>	<b>27</b>
<b>5</b>	<b>POLISHING AND BUFFING OPERATIONS .....</b>	<b>28</b>
5.1	The Polishing and Buffing Process .....	29
5.1.1	Differences in Buffs. ....	31
	<b>Figure 13. Full Disc Buffs, a Loose Ply (left) and a Circle Sewn (Right) ...</b>	<b>31</b>
	<b>Figure 14. Wear Pattern of Full Disc Buffs, new (left) and worn (right) ....</b>	<b>32</b>
	<b>Figure 15. Bias Cut Buffs .....</b>	<b>33</b>

<b>Figure 16. Flanges for Use with Bias Cut Buffs.....</b>	<b>33</b>
5.2 Loading the Buff.....	34
<b>Figure 17. Loading the Buff.....</b>	<b>34</b>
5.3 Using a Rake .....	35
<b>Figure 18. Buffing Wheel Rake .....</b>	<b>35</b>
5.4 Avoiding Cross-contamination of Compounds .....	36
5.4.1 A Different Buffing Wheel for Each Operation.....	36
5.4.2 Clean Your Hands or Gloves between Operations.....	37
5.4.3 Clean Parts between Operations.....	37
5.4.4 Protecting Buffing Wheels .....	38
5.4.5 Protecting Finished Parts.....	38
5.5 Polishing Technique Tips and Tricks .....	38
5.5.1 Cutting and Coloring Strokes.....	38
<b>Figure 19. Cutting and Coloring Strokes.....</b>	<b>39</b>
5.5.2 Part Orientation Relative to the Buffing Wheel.....	39
5.5.3 Part Temperature .....	40
5.5.4 Polishing with Sets of Strokes at 90-Degrees.....	40
<b>Figure 20. Cam Cover from a 1978 Glide.....</b>	<b>41</b>
5.6 Problem Parts: High Porosity Castings .....	41
<b>Figure 21. Problem Part.....</b>	<b>42</b>
<b>Figures 22. First and Second Sandpaper Cuts .....</b>	<b>43</b>
<b>Figures 23. Third and Fourth Sandpaper Cuts .....</b>	<b>44</b>
5.6.1 Trick Number 1, Intentionally “Overloading” the Buff.....	44
<b>Figure 24. A Single Surface Pore after Wet-sanding .....</b>	<b>45</b>
<b>Figure 25. Filling Surface Pores with Compound .....</b>	<b>46</b>
<b>Figure 26. After 1<sup>st</sup> Polishing Operation (cutting down) with Emery Cake.....</b>	<b>47</b>
5.6.2 Problem Part Cleaning .....	47
<b>Figure 27. Finally!...Starting to Take a Shine .....</b>	<b>48</b>
<b>Figure 28. Finished with the Tripoli .....</b>	<b>48</b>
<b>Figure 29. Part They Say Won’t Polish.....</b>	<b>49</b>
<b>Figure 30. Effects of Surface Flow.....</b>	<b>50</b>
<b>6 DUST CONTROL .....</b>	<b>50</b>
<b>Figure 31. Garage or Shop without Dust Collection.....</b>	<b>51</b>
6.1 Dust Control.....	51
6.2 Homemade, El Cheapo Dust Collector .....	51
<b>Figure 32. El-Cheapo Box Fan Dust Collector .....</b>	<b>52</b>
<b>Figure 33. Box Fan Dust Collection, Conventional Motor Stand.....</b>	<b>54</b>
<b>Figure 34. Homemade Dust Collection.....</b>	<b>55</b>
<b>Figure 35. Buffing Wheel Shield .....</b>	<b>56</b>
6.3 Dust Collectors .....	57
<b>Figure 36. Dust Collectors.....</b>	<b>57</b>

**7 Safety Precautions .....57**

7.1.1 Hand Protection ..... 58

7.1.2 Use a Dust Mask ..... 58

7.1.3 Eye Protection ..... 58

7.1.4 Around Buffer Motors..... 59

**8 SEALING.....59**

**Figure 37. Alcoa Bare Aluminum Sealant ..... 60**

**9 MAINTENANCE OF POLISHED SURFACES..... 60**

9.1 Deoxidizing and Cleaning ..... 61

**Figure 38. Using Cleaners Not Compatible with Bare Aluminum Alloys ..61**

**Figure 39. Cleaner Compatible for Bare Aluminum Alloys ..... 62**

9.2 Scratches and other Blemishes ..... 62

**Figure 40. Shank-mounted Buffs ..... 63**

9.3 Sealing the Finish ..... 63

**10 Harley Aluminum and other Precious Metals ..... 63**

**Figure 41. 1964 Sportster Engine (bike featured on the cover)..... 64**

10.1 Something that Chaps my Butt ..... 64



## 1 POLISHING AND BUFFING AT A GLANCE

The following Figure 1 is a general overview of the process for polishing and buffing Harley bare aluminum alloy cast and machined parts to a chrome-like, mirror luster. Enjoy Figure 1 because this is about as fancy as it's going to get.

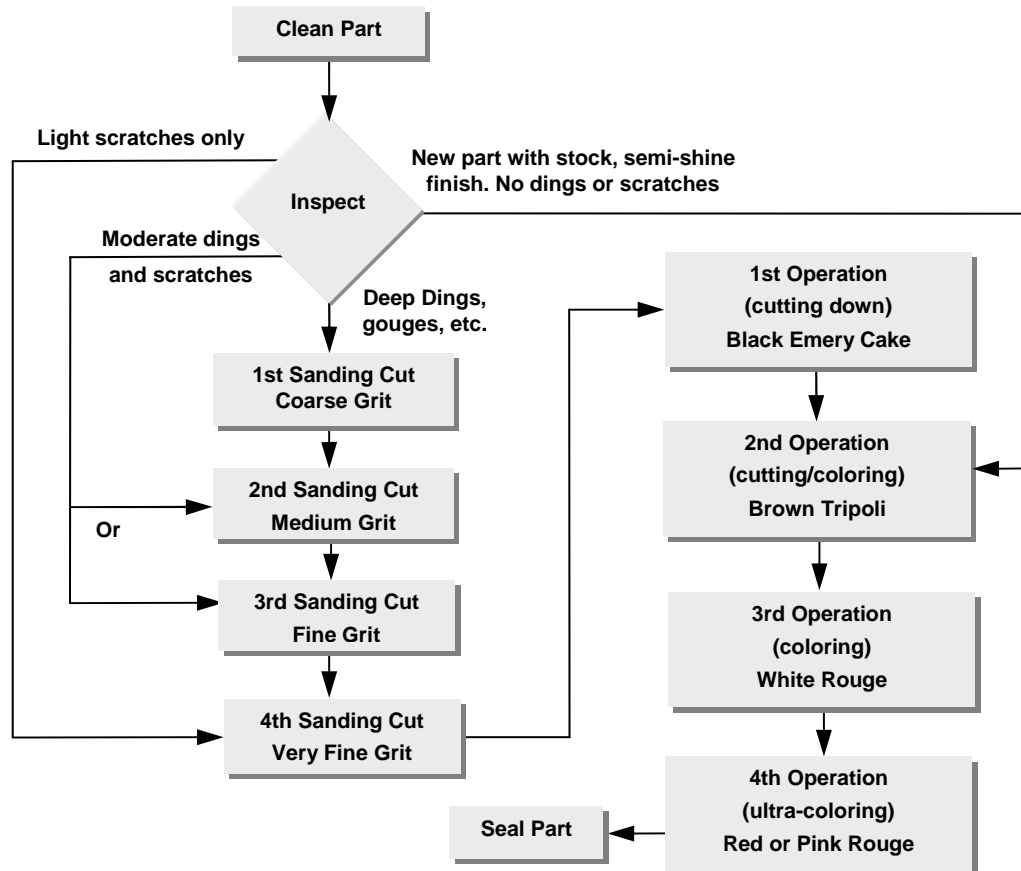

**Figure 1. General Polishing and Buffing Process for Aluminum Alloy Harley Parts**

Yeah, I know. That's a lot of sanding, polishing, and buffing. However, starting with coarse, 1<sup>st</sup> cut sanding is for worse case stuff, like some old vintage, beat up, old rat bike you found and are doing a frame-up rebuild or maybe a part with road rash. On some parts you can skip sanding altogether and on new, unblemished parts you can likely skip both the sanding and the 1<sup>st</sup> polishing operation, going straight to brown Tripoli. We'll get into that later, but it's all going to depend on part condition.

## 2 SURFACE CLEANING

Of course, you've got to start by getting the parts off the bike and giving them a good cleaning. For crying out loud, don't use some brand-x concoction cleaner intended for chrome plated surfaces! Otherwise, you could wind up with a chemically etched doorstop needing the sanding and polishing

emergency room for more reasons than one. If you think I'm pulling your leg, temporarily jump to Section 9.1 and take a gander at a prior patient in Figure 38.

Clean off any dirt, road grime, and oil residue with clean kerosene. Afterward, wash the part with ordinary dish detergent such as liquid Palmolive or Dawn and rinse thoroughly. If the part is a cam cover, tranny cover, primary cover, rocker cover, etc., it will have engine oil residue on the gasket side. All oil must go. Otherwise, when handling the part under a buffing wheel, the slightest amount of oil residue that gets on your hands or gloves, will wind up as a black, oily mess all over the work piece. Not good, folks.

## 2.1 Inspection

Now that the part is clean, inspect the surface closely for pits, dings, gouges, and scratches. You'll probably see dings you didn't even notice earlier. The depth and quantity of dings, gouges, and scratches, etc., will determine what grit sandpaper you need to use for a first cut.

## 3 SANDING

Okay, we now have a clean part and are ready to boogie. If the part is pretty well dinged up, scored, pitted, and heavily scratched, you're going to have to hit it with some serious sandpaper cuts before polishing. You can skip sanding if:

- It's an old part completely free of pits, dings, and deep scratches (unlikely)
- A new, completely unblemished, stock part you're merely polishing to a chrome-like luster
- You're willing to live with a shiny part that still has dings, pits, scores, and deep scratches

For severely damaged parts, the quality of the final mirror finish is heavily dependent on the sanding preparation. You cannot compound out deep dings, gouges, and deep scratches. Believe me on that one. If you blow off the sanding and just jump in and start polishing...say, in the July...you'll still be polishing when you're singing Jingle Bells and will merely have a shiny part with the same dings, scores, and gouges detracting from the mirror finish you really wanted. Matter of fact, depending on the buff and compound, you can actually make some types of dings even deeper. If it's dinged up, we gotta sand, folks.

### 3.1 Sanders

First, let's get a sander. What seems to work best for Harley size and shape castings and most other Harley parts is a small, orbital, 1/4-sheet, palm sander. Typically, these haul buns and crank out from around 8,000 to 14,000 orbits/minute, depending on the brand. The little red Milwaukee shown in Figure 2 screams at 14,000. Don't use one of those little 115-volt vibrator sanders. They're primarily for wood and as far as removing material, they work about as well with the power switch off as on. Also, detail sanders are handy for getting in tight places you can't reach otherwise. Using the corners of the pad for tight places, a small palm sander, whether air or electric, will do 99% of it. For places you just can't reach, there's another sander out there called "hand." It comes in two types...left and right, often accompanied with sweat. Figure 2 shows typical orbital palm sanders. Look about 12 inches or so down from your elbow for an example of a hand sander.



**Figure 2. Typical Electric Orbital Palm Sanders**

There are a zillion brands of ¼-sheet orbital palm sanders out there, all of them pretty good for what we're doing here. The sanders in Figure 2 are merely two I pulled out of the air.

## 3.2 Sandpaper

Okay, we now have a cleaned part and a palm sander. Now, let's find the right sandpaper for sanding. If you start with a grit that's too fine, you'll know. When you've been sanding until you're blue in the face and realize you're not making enough headway on removing material to eliminate the dings during this century, you need to gear down to a coarser grit. That's okay...that's the way to do it. It's always better to try a finer grit and then gear down if necessary. A coarse grit cuts the material down quickly and you can come back on the next cuts, working your way back up with progressively finer grits, getting the scratches out from the cut prior. When you've done a bunch of this, you'll be able to take a look at a part and tell at a glance which grit you need to initially start using to get the job done quickly and looking good at the same time.

Another reason to gear down to a coarser grit is to keep from sanding so long in one spot to get out a problem ding. If you keep sanding in the same spot, you'll be sanding a low place in the part that's going to show up as a visible hollow swag after it's polished. Keep the surface uniform and free of low places that would otherwise become obvious after it's polished. Remember, we're going for a chrome-like, mirror luster and a hollow place will stick out like a sore thumb later.

### 3.2.1 Sandpaper Grits

Norton, for instance, makes a good mixed-pack of metal-sanding emery grits. I'm sure 3M makes a similar pack as well, and of course, there are others. Personally, when sanding with coarse grits, I sand dry, then wet sand when I get into the finer grits. Sandpaper for metal sanding is commonly available in local do-it-yourself mega-retail stores, automotive supply stores, and suppliers of products to the auto body repair industry. One commonly available Norton product is a metal sanding pack of assorted, coarse, medium, and fine 9 x 11 inch sheets of emery bonded with resin to a cloth backing.



**Figure 3. Sandpaper Selection**

As an example, this mixed pack is locally available at Home Depot stores, plus you might want to throw in a sheet of 280 grit as I have here, or maybe a “very fine” sanding sponge.

You’ll find that emery sanding packs of assorted grits are vaguely labeled “course,” “medium,” and “fine.” They equate to the grit shown in the following section. A quarter of a 9 x 11 sheet perfectly fits standard ¼-sheet palm sanders. Just fold to crimp and tear off in quarters. To take the cloak of secrecy out of this grit business, I’ve included a grit guide in the following section.

**3.2.1.1 Grit Guide**

This “course,” “medium,” and “fine” business has always made me wonder what grit we’re talking about, here. It’s like the folks that made the stuff aren’t real sure themselves. I know what prompts this, but it doesn’t really make any difference because we still have the same problem as a user...no number for a point of reference to numerical grit grades. Although a broad brush of sorts, here’s a grit guide I came across from one of the leading abrasives manufacturers:

<b>Table 1. Grit Guide</b>	
<b>Description</b>	<b>Grit Grade</b>
Extra coarse	30, 40, 50
Coarse	68, 80
Medium	100, 120
Fine	150, 180
Very fine	220, 240, 280
Super fine	400
Ultra fine	600, 800, 1000, 1200, 1500

What's really happening here is that variations in the backing, the adhesive system used to bond the grit to the backing, the grit material itself, whether it's dry sanding or wet, and endless variables in sanding dynamics, can result in a dramatic difference in the scratch. This variation is so wide that it's possible for a coarser grit of one construction and use to actually sand smoother than a finer grit of a different construction and use. The metal-sanding sandpaper we're recommending here is natural emery, resin bonded to a cloth or waterproof paper backing.

### 3.2.1.2 Grit Chart

Personally, I prefer grit designations that get to the point, like: rougher than a cob, coarse, sorta course, happy medium, fine, mighty fine, dang fine, and plumb smooth. However, the abrasive folks seem to want to count molecules. You might want to memorize this little chart real quick for handy reference:

FEPA (P-Grade)	CAMI	Finishing Scale	Average Particle Size (inches)	Micron Scale $\mu$
P2000	1000	-	.00042	9.5
P1500	800	-	.00051	12.3
P1200	-	A16	.00060	15.3
-	600	-	.00062	16.0
P1000	-	-	.00071	18.3
-	500	-	.00077	19.7
-	-	-	.00079	20.0
P800	-	A25	.00085	21.8
-	400	A30	.00092	23.6
-	-	-	.00098	25.0
P600	-	A35	.00100	25.75
-	360	-	.00112	28.8
-	-	-	.00118	30.0
P500	-	-	.00018	30.2
P400	-	A45	.00137	35.0
-	320	-	.00140	36.0
-	-	-	.00158	40.0
P360	-	-	.00158	40.5
-	280	-	.00172	44.0
-	-	-	.00177	45.0
P320	-	A60	.00180	46.2
-	-	-	.00197	50.0
P280	-	-	.00204	52.5
-	240	A65	.00209	53.5
-	-	-	.00217	55.0
P240	-	A75	.00228	58.5
-	-	-	.00230	60.0
P220	-	A90	.00254	65.0
-	220	A85	.00257	66.0
P180	180	A110	.00304	78.0
-	160	A130	.00363	93.0
P150	-	-	.00378	97.0
-	120	-	.00452	116.0
P120	-	A160	.00495	127.0
-	100	-	.00550	141.0

**Table 2. Grit Chart**

FEPA (P-Grade)	CAMI	Finishing Scale	Average Particle Size (inches)	Micron Scale $\mu$
P100	-	A200	.00608	156.0
-	80	-	.00749	192.0
P80	-	-	.00768	197.0
P60	-	-	.01014	260.0
-	60	-	.01045	268.0
P50	-	-	.01271	326.0
-	50	-	.01369	351.0
P40	-	-	.01601	412.0
-	40	-	.01669	428.0
P36	-	-	.02044	524.0
-	36	-	.02087	536.0
P30	-	-	.02426	622.0
-	30	-	.02488	638.0
-	24	-	.02789	715.0
P24	-	-	.02886	740.0

### 3.2.2 Sanding Out the Dings

Got all that? Good! We're sandpaper experts, now. As I mentioned earlier, ¼-sheet palm sanders will get almost every nook and cranny on most Harley aluminum alloy parts. At the same time, a palm sander has a large enough sanding surface area to avoid sanding in hollows caused by sanding too long in one spot. Tight places you can't reach can be gotten by hand or with a detail sander. However, when detail sanding, spread the sanding out enough to avoid hollows and blend it into areas sanded with the palm sander. If you want a ding-free surface after polishing, it must be ding-free after sanding. Figure 4 represents possible cross sections of the work piece. It should pretty much show you what we're faced with, here.

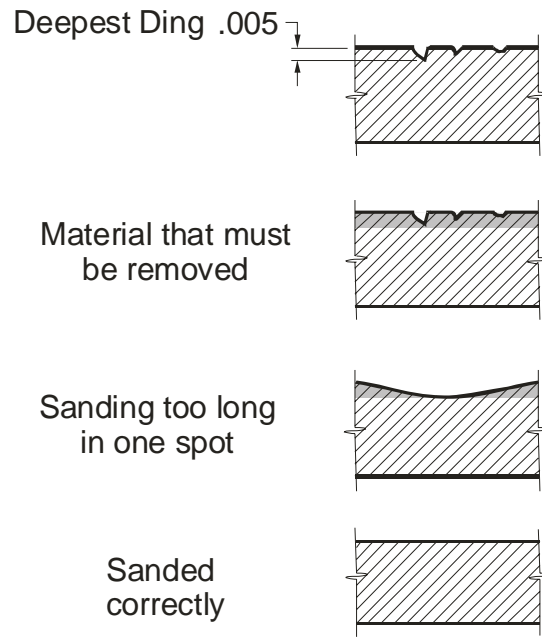

**Figure 4. Sanding Out Dings**

Not that we're going to actually get down and measure the depth of a darn ding, but if the deepest ding is, say, .005 of an inch deep, we need to remove .005 inches of material to remove all dings. Figure 4 is highly exaggerated scale, so don't let the figure make you think you're removing a ton of material that will weaken the part. Put it this way, the average human hair is .001 of an inch in diameter...except maybe for big Betty Lou Buford back in my home state of Tennessee...and what her species may actually be is debatable, anyway. A rather stout Harley part is not even going to know the difference if the thickness of a mere 5 hairs is missing.

Following the instructions in Table 3 will pretty much keep you out of trouble. If in doubt when on your first shot at this, start with one of the finer grits and work your way back to a coarser grit if it turns out to be a slow go by not removing material fast enough for the condition of the part. Years ago, on my first go at this, I was bored one evening and started sanding late, late one evening close to midnight. I started out with 320 grit paper because I was scared to death to use something coarser on a 35-year old irreplaceable Harley part. I was still sanding past 2:30 AM and still staring at the same darn dings. They were microscopically shallower and that's about it. The only other time I was ever up at such an ungodly hour was back in Tennessee when my Aunt Miranda got a shot glass hung in her throat at 3:00 AM in the morning.

Unlike me back then, you likely won't need to start with the coarsest grit shown for the 1<sup>st</sup> cut unless your part has a real bad case of the uglies...like butt ugly or road rash. A coarse grit is for severely abused basket case parts only. It rapidly removes a lot of material, leaving scratches consistent with the grit...that you have to get out with the next finer grit. See Section 1, Figure 1 as a sanding reference, then use the following Table 3.

**Table 3. Sanding Out Dings**

Cut	Sandpaper	Sanding	Finish Appearance
1 <sup>st</sup>	Coarse	If you have some seriously deep dings, scratches, and gouges, you'll have to start with this grit. Usually, this is confronted during a re-build of an old bike or one that's been badly abused or has been horizontal and has a case of road rash. Sand the dings out, making sure you also sand quite a distance away from the problem areas as well. This avoids creating hollows that will show up when the surface achieves a mirror finish. If you have doubts about needing to start with something this coarse, start with the grit shown for the 2 <sup>nd</sup> cut below, or even the 3 <sup>rd</sup> cut. You can always come back.	Flow with clean water and inspect closely. It should be pretty darn scratchy from the coarse grit, but uniformly scratchy. Make sure that all deep dings, etc., are now gone. Of course, if you have a ding that's unusually deep you judge to be completely impractical to remove, just live with it and go to the next cut. After removing other dings, it will at least be shallower and less noticeable.
2 <sup>nd</sup>	Medium	You have to get out all scratches made from the 1 <sup>st</sup> cut. That's extremely important!...a "have-to." It's not likely that the 3 <sup>rd</sup> cut is going to do it if you don't do it here.	Flow with clean water and inspect closely. All scratches made by the 1 <sup>st</sup> cut have been replaced with finer scratches of the 2 <sup>nd</sup> cut. The part has a uniform, flat, brushed look.
3 <sup>rd</sup>	Fine	You've heard this before, but again, you have to get out all scratches made from the 2 <sup>nd</sup> cut before going to the third. Extremely important...and again, a "have-to." If you don't, they'll still be there, later. I suggest wet sanding with this grit.	Looking pretty good. It now has no scratches left from the 2 <sup>nd</sup> cut. It has a clean, smooth finish having a uniform texture left from the grit of this third cut only.
4 <sup>th</sup>	Very Fine	Wet sand by hand with an extra fine sanding sponge or sheet...say, 280 or 300. It's not that big of a deal because it goes quickly. Further smooth the already smooth texture left from the previous cut. What you do here depends on how the part is going to respond when we start polishing.	You should start seeing a satin smooth finish, even a slight hint of a shine, free of any scratches visible with the naked eye. Wash the part thoroughly! We're ready to polish!

Caution: Unless you want some Harley bookends, do not allow sandpaper to come in contact with a mating surface that provides the seat for a gasket seal!

Some folks prefer to continue sanding with something much finer than what you see in Table 3, making successive cuts with, say, 400, 600, and higher. That's up to you. However, the 1<sup>st</sup> operation polishing compound we'll be recommending later is a cut down operation with an aggressive grit that allows you to go directly from a "very fine" sanding cut to the 1<sup>st</sup> polishing operation. This is much quicker, easier, and more appropriate for the contours common to Harley castings than to continue sanding with progressively finer sandpaper.

## 4 POLISHING AND BUFFING MATERIALS AND TOOLS

We ain't polishing, yet, but we've got this sandpaper and sanding business out of the way. Next, we need to identify all the polishing and buffing related stuff you need and where you're going to get it. Once we do that, we'll throw some power on a buffing motor and get down to the nitty gritty in Section 5.

I'll be mentioning a number of brands of equipment and manufacturers of compounds, tools, and sources of supply, etc. No, I don't own stock in any of these guys, I haven't been slipped some bucks for a plug, nor have any vested interest. It's just that these materials are top notch stuff and are the best I know for the job. There are numerous sources for commercial grade materials, but the vast majorities are distributors and will not sell directly to the consumer in smaller quantities. However, I've managed to scrape up a couple of sources.



First, some polishing and buffing lingo so you'll know what I'm talking about from here on. When I say "cutting" or "cutting down," that's a metal finishing buzzword describing the preliminary use of a coarse compound grit to remove material in order to further smooth the surface prior to the next polishing operation with a finer compound. I refer to each as an "operation," although some cut, some combination cut and color, and other operations only color with negligible removal of material.

"Coloring" is another metal finishing buzzword that refers to a light buffing with an extremely fine compound grit to bring up the luster and add "color" and depth. Also, the metal finishing folks make a distinction between "polishing" and "buffing." I know what they're talking about, but some aren't too sure themselves and just throw that in there to confuse us. They will sometimes make a distinction between polishing wheels and buffing wheels or polishing compounds and buffing compounds. This is our deal, so we'll call it what we want. In here, we're "polishing"...and we're going to "buff" to get there...how's that sound?

## 4.1 Buffer Motors

Well, you can go three ways, depending on the size of your job and the thickness of your billfold. For smaller amounts of rinky-dink polishing, you might get away with using an ordinary stationary-mounted, high-speed hand drill. However, you're going to be limited to lower arbor speeds as the fastest high-speed drill is relatively slow compared to a 3450 rpm buffer motor. This means far fewer linear feet/minute at the buffing wheel's edge and a much longer time to get the job done. If you're doing a frame-up rebuild of an old vintage Harley, want to polish every piece on the bike, and expect to do more polishing later, you'd be way ahead to go ahead and get a specialized buffer motor we'll talk about later.

### 4.1.1 Makeshift, Rinky-dink, Thin-wallet, Buffer Motor

For small jobs, you can wrap padding around an ordinary 115-volt, 1/4-inch, high-speed hand drill and clamp it up in a vise. Don't try to use a battery-powered drill. Most of those have ample torque, but they barely run fast enough to stir coffee. Of course, battery life isn't long enough to even get warmed up good. We're talking a long time here, not a mere few minutes. If you have more than one 115-volt drill, I'd suggest using the one that has the highest rpm. You'll have to run a 6-inch buffing wheel to get any usable speed at the buff's edge. I hope it's a cheap drill. Reason I say that is because electric drill manufacturers didn't have constant running in mind when they designed and manufactured the drill motor. In other words, you stand the chance of overheating and burning up the armature or field windings if the bearings and gears don't poop out first. On the other hand, a polish shop would probably charge you more than the cost of a six-pack of cheap, cheap drills, anyway...depending on how much polishing you're doing. If you're lucky, you'll just wind up with a rather loosey-goosey, well broken-in drill motor. Better yet, borrow your mother-in-law's drill and tell her you just need to drill a couple of holes in soft wood.

Just keep in mind that these smaller, 1/4-inch drills only run from 1200 to about 1500 rpm, depending on the brand and model. However, you can also find some that will run up to about 2500 rpm. If you're going to go the drill route, that's what you need. With a 6-inch buff, that'll give you nearly 3800 linear feet/minute. However, this is still slower than the itch in polishing circles for a 6-inch buff on an aluminum alloy surface. If you use a 1200 to 1500 rpm drill, you might consider taking a sack lunch when you go out to the garage to start polishing. Preferably, you'd really want around 5000 linear feet/minute. If you think you can beat the game by going to a larger drill, say a 3/8 or 1/2-

inch...well, don't. Those only turn around 600 to 800 rpm, some even less. You'll be going backwards and to get any speed at the business edge of the buff, the buff would have to be about the same diameter as a hula hoop. First, get a drill arbor as shown in Figure 5.



**Figure 5. Half-inch Arbor for 1/4-inch Drill**

You can get a 1/2-inch arbor from about any hardware store to chuck up in 1/4-inch drill to accept a buffing wheel. They normally come with a pair of large, conical washers and a nut for mounting various types of wheels.



**Figure 6. Makeshift Buffer Motor Using a High-Speed Hand Drill**

For cushioning in the vise, the goofy deal you're looking at in Figure 6 uses 3 layers of that perforated rubbery stuff sold by Home Depot, Lowes, etc., for use as kitchen shelf lining, as opposed to ordinary

shelf paper. Darndest non-slip stuff I've ever seen. Anyway, 3 layers offer a lot of padding and really get a super grip on the drill without having to crank the vise down so tight you booger up the drill housing. It's truly non-slip...like, really weird. That notch cut in the padding is to keep from obstructing the air vents as much as possible. Just make sure you have it held snugly enough so that it won't jump loose, run up your chest, and relocate your facial features. Speaking of that, this whole drill motor thing is just an option you can do at your own risk...not my official recommendation. I don't need some big, bad tattooed dude in a black leather jacket banging on my door while wearing a new nose piercing in the form of a buffing wheel and mandrel.

When using a bias cut buff (see Figure 15), the steel center of these buffing wheels are much thinner than full disc buffs. You'll need to insert a spacer such as a short piece of PVC pipe behind the buff so that only a thread or so will protrude past the nut. Otherwise you're going to have over a 1/2-inch of arbor threads sticking out. Here's the prob: when polishing, you work from the end of the buff with the drill pointing toward you, not the side like a grinder. In the event you slip or the buff grabs the part, you darn sure don't want the part to get smacked by the end of the arbor and get a nasty ding. If that happens, the spinning arbor will leave a bunch of pigtail-shaped, curlicue gouges on the part...and you're now back to sanding. Don't ask me how I know that. Slap a piece of masking tape over the end of the mandrel and nut to be safe.

**WARNING:** Figure 6 actually shows a major no-no. Bias cut buffs are normally always used with a pair of flanges like those shown in Figure 15. These flanges prevent the buff material from pulling out of the crimped, steel fingers at higher rpm. However, as long as you're confined to the limited rpm of a little drill motor, you're probably safe. Use caution because when these things turn loose, you can catch it smack in the face.

Even with a notch cut in the padding to provide a little opening for the air vents, you might need to let this thing rest once in awhile to cool down, depending on the brand and model...unless you want to pop popcorn on it at the same time. If you think you smell something like electrical insulation burning, it's not a Fig Newton of your imagination. It's a pretty good hint you forgot.

You'll need a good work light. A fluorescent, dual-lamp desk light is perfect. When you start the polishing and buffing process, you'll need to be able to see extremely small micro-details on the surface of the work piece. As you move on up to finer compound grits for coloring operations, the micro-scratches will cease to be visible with the naked eye. You'll be observing your progress on bringing up the luster by viewing the surface at an angle and looking at the reflection.

#### **4.1.2 General Purpose Motor Fitted with an Arbor**

Here's the next best solution...and a pretty darn good one in a pinch...well, next to buying a true-blue buffer motor. If you have a table saw or other general purpose, 3450 rpm motor, you can temporarily swipe it from whatever it was on and convert it to work as a buffer motor. I wouldn't suggest swiping the motor from your wife's clothes dryer. She's probably already wondering who whacked out a hunk of her rubbery, kitchen shelf lining stuff and is looking all over the house for the missing desk lamp. Of course, a general purpose motor needs to have the pulley removed and be fitted with an arbor. You can likely find arbor extensions locally. See Figure 7.



**Figure 7. Arbor Extensions for Motor Shafts**

I'd suggest using something like the longer extension on the right because a conventional motor converted to buffing use isn't going to have a longer armature shaft like a regular buffer motor. A longer arbor extension will get the buffing wheel away from the motor housing to provide more room to manipulate the part when polishing. These extensions are commonly available for 1/2-inch or 5/8-inch arbors. The arbor extensions shown in Figure 7 are a snug, slip-fit over standard motor shafts and are secured with Allen head set screws. If you can't find a local source, here's a web source that has about every kind of special arbor imaginable:

<http://qualitybuff.com/c6.html>

**WARNING:** When using a bias cut buff, you absolutely must use a pair of flanges to make sure the buff doesn't fly apart from centrifugal force. Believe me on this. We're in rpm range where it's an absolute necessity. See Figure 15.

#### 4.1.3 Specialized Buffer Motors

Okay...we're now stepping on up to the big time. See Figure 8. Here's the best route if you're going to take on a big batch of dead serious polishing...like a whole bike you're spending a ton of money on anyway or a couple of bikes or more. These are specialized motors with buffing in mind only...well, I said that, but some are merely bench grinders with the shields removed, then labeled, "buffing motor."

Commonly available in 6 and 8-inch, they accommodate a buffing wheel on each end. The long arbor shafts get the buffing wheels out far enough to provide as much clearance as possible between the motor housing and the part when polishing larger parts. Of course, they're always changing up web

page URLs, so if you click on a dud shown below, just copy/paste the URL up to and including the “.com” part and go fish.

#### 4.1.3.1 Sources of Supply for Buffer Motors

This section contains a few of the more popularly used buffer motors, though there are others out there. You should have a pretty good selection here because I’ve included high, in-between, and low end makes and models. If you go to the respective URLs, you’ll see others as well, but any of these would fit our purpose very well.

Here’s one of the best buffers ½-inch buffers you’ll ever find. However, expect to pay the price because it’s top of the line, professional grade stuff.

**Baldor:** sold by Southwest Metal Finishing Supply Company  
<https://www.tyler.com/secure/swmetal/shop/catalog.php?Cat=equipment>

This buffer is certainly at the right price for a buffer having a rather stout 5/8-inch arbor. Just make sure you order 5/8-inch accessories as well.

**Central Buffer:** sold by Quality Buff Company  
<http://qualitybuff.com/p26.html>

At the bottom of the price range, here’s a Dayton distributed by Grainger.

**Dayton:** W. W. Grainger, Inc.  
<http://www.grainger.com/Grainger/productdetail.jsp?xi=xi&ItemId=1611747073>



**Figure 8. Buffer Motors**

Left to right, Figure 8 shows a Baldor, a model by Central Buffer, and Grainger’s Dayton brand buffer motors. Bench mounting doesn’t work, here. Remember this, because you’ll hear about it later. The usable portion of the buffing wheel is the lower half of the wheel only!...totally different than a grinder. As you’ll find out, buffing with anything other than the lower half is not only dangerous, but you also can’t see what you’re doing unless you have x-ray vision and can see through the part.

Also, this isn’t going to be like using a grinder where you stand in front of the motor. You’ll be positioned at the end of the motor with the arbor pointing toward you while performing left to right and right to left strokes, rather than in front. Believe me; you sure don’t want to be positioned in the plane of the buff unless you want a head-to-toe, black racing stripe of messy, greasy buffing stuff.

Rather than bench mount, you have to have a stand similar to that shown with the Baldor in the pic on the left in Figure 8. Otherwise, you're not going to have room to manipulate the part when polishing. However, the Baldor is shown mounted on what is commonly used for a grinding stand. If I had a stand like that, I believe I'd knock off an inch or so off each side of the pedestal and to get it down to the same size as the buffer motor base. You darn sure want to get rid of those sharp corners or you'll sooner or later get big dings on larger castings you didn't have earlier. You need every inch of clearance you can get when polishing the largest Harley parts.

#### **4.1.4 Buffer Motor Stands**

Personally, I have different thoughts on the whole subject of buffer motor stands...well, when it comes to polishing the shape, contour and size of larger Harley parts. What would really be ideal is to have the entire area beneath the motor free and clear so you could easily manipulate large parts such as primary cover castings...well, for that matter, something as large as entire Sportster engine casings. Remember, only the lower half of the buffing wheel is usable and you'll be working with the arbor pointing toward you, not from the side. Normally, the ideal clearance needed for something like big primary covers, can't be had. This is because the motor has to have a base for it to mount and a stand, which will get in the way of larger parts. It'd be nice if the motor had no mounting base or stand and it'd just levitate in thin air. Take a look again at the stand the Baldor is mounted in Figure 8 (the motor on the left). I imagine that your first thoughts are that the arbors stick out far enough that the motor base or stand couldn't possibly get in the way. Well, it does on the largest parts if you buff the way I do. I'll cover this more in detail later, but here's the deal:

The most effective, high-luster buffing is done with sets of passes that are at 90 degrees to each other. In other words, you'd make left to right and right to left cutting and coloring strokes in one direction, then rotate the part 90 degrees while repeating the strokes, then rotate it 90 degrees again, continue buffing, and rotate again, etc. This technique cuts faster, provides a more uniform surface when cutting, and results in the highest luster a compound is capable when coloring. If you're going to buff that way for the shine of all shines, the motor mount, the stand, or both can get in the way on the largest of parts.

Being as the motor won't levitate, what'd really be cool is something that'd suspend the motor upside down from above with the motor mount turned upwards. This would leave the entire area under the motor free and clear, like suspended upside down on the end of the arm of a radial arm saw. There's a new buffer stand that does this, but it's pricey and is about 400+ pounds of steel. See Figure 9.

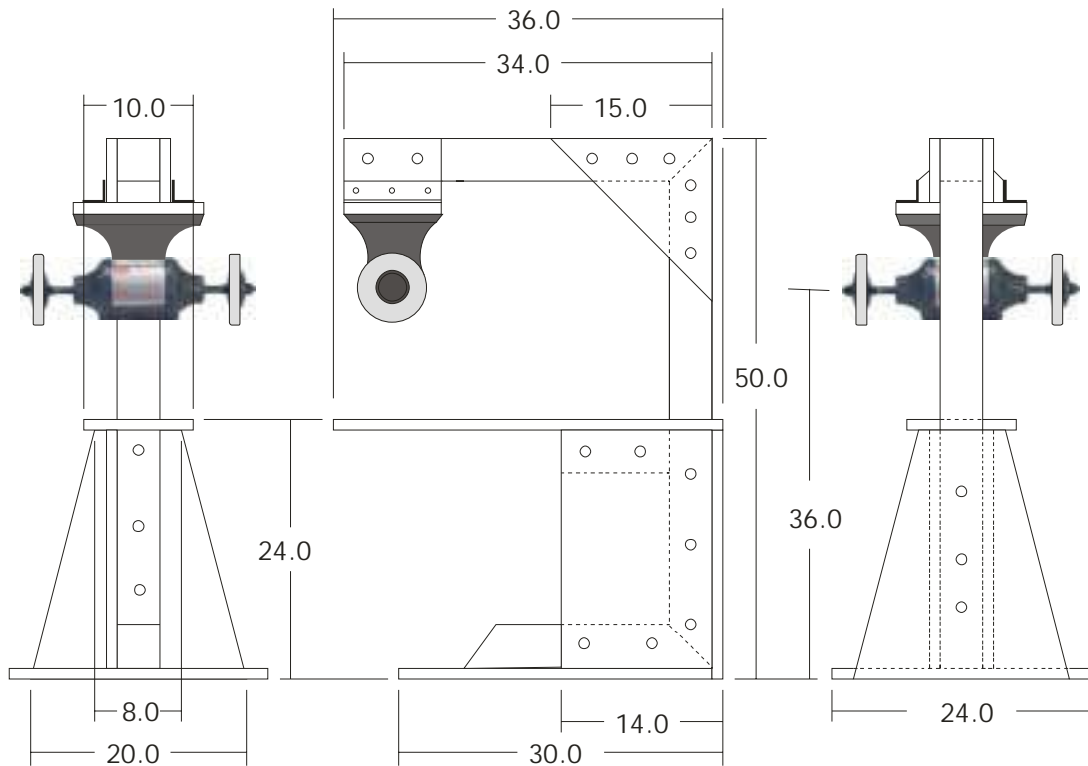

**Figure 9. Full Clearance Buffer Motor Stand**

Nahhhh...just kidding. I made that hummer, myself. The shop gray, water-based primer is deceiving. It's not steel at all and it sure isn't pricey...matter of fact, dirt cheap. I built that dude from nothing more than a 4 x 4 fence post, some  $\frac{3}{4}$ -inch particle board, wood glue, and a handful of thru-bolted fasteners. All fasteners are torqued to about 3 blood veins to tightly clamp up a powerful glue bond that supplements the fasteners. A couple of pieces of angle iron provide reinforcement at the head to support the motor (~30 pounds). Due to the glue bonds, this thing becomes one rock-solid, inseparable, sturdy piece of stuff, yet you can easily slide it around to move it here or there. The narrow, ironing board-like work surface below the motor is removable to allow clearance for the largest part you'd ever confront and have strength to hold up under a buffing wheel. With this kind of clearance, you can darn near get a whole bike under this thing, including the rider.

As you can tell, the buffer motor is now mounted upside down. The motor I used is a  $\frac{1}{2}$  hp, 3450 rpm, 6-inch Dayton sold by Grainger Industrial Supply mentioned earlier. Of course, other buffer motor brands will work just as well. This configuration allows me to buff in sets of strokes at  $90^\circ$  to one another by providing the necessary clearance for the larger parts. Pretty slick, huh? If you're really faced with a bunch of polishing and want to build one of these little jewels, see Figure 10 and have at it. The price for the plans is right, too...free.





**Figure 10. Home-made Buffer Motor Stand Dimensions**

The dimensions are based on my personal sit-down ergonomics. I'm 5'10"...standing...not sitting. That's big Betty Lou Buford. As far as I'm concerned, polishing ain't a stand-up job...I sit. That's the reason the motor shaft centerline is intentionally only 36 inches from the floor. With a 6-inch buffing wheel, the lower edge of the buff is now only 33 inches off the floor. Bingo! Just right for sitting and polishing...for me, anyway. For versatility and work comfort, this little jewel beats the pants off about any buffer motor/buffer stand configuration I've seen. A comfy old office chair on casters is my idea of a shop stool.

When you move up to a 3450 rpm motor, you can really boogie. For a 6-inch buff, that puts the speed at the edge of the buff's polishing surface to over 5400 linear feet/minute...almost 3 times faster than a 1200 rpm drill motor and 6-inch buffing wheel. At the same time, the surface temp of the part will be higher due to friction and the compound can do a much better job. However, you don't want a hot, hot part, either. We'll talk about the role of part temperature later in "Polishing Tips and Tricks."

## 4.2 Polishing and Buffing Wheels

Okay, presuming you've one way or another swiped or come up with some kind of a buffer motor and stand, we now need a buffing wheel to put on the arbor so we can polish. Let me first say that there are zillions of different buffing wheels...gobs of them. Some are mill treated with starch, some untreated, some are loose plied, there's circle-sewn cotton, others are spiral-sewn, and then there's flannel, muslin, and a whole series of bias cut buffs, just to mention a few. Others have alternating layers of sisal...well, you get my drift. It all depends on what you're doing...whether cutting down or



coloring, combination cut/coloring, and whether it's stainless steel, aluminum, plastic, precious metals, hard rubber, glass, etc. On top of all this, buffing wheels come in diameters up to 20 inches for factory production polishing, and then there are buffs all the way down to a 1-inch and smaller polishing bobs. There are even smaller felt bobs for Dremel and jewelers tools.

The bad news is that the ranges of buffs we need simply aren't available at your local mega-retail hardware stores. The buffs we'll be using are industrial supply, professional items as opposed to general purpose polishing, do-it-yourself products you might find in retail stores. Using the right buff with the right compound is a major factor. See Section 4.4 for the full array of buffing wheels needed.

### 4.3 Polishing and Buffing Compounds

Before I get into this, I realize that other folks having a hand at polishing aluminum alloys may have a different way of achieving good results as well. They may use entirely different buffs and compounds. I'm certainly not knocking that at all. I'm sure there are number of ways of getting good results if one wants to accept the time it takes to get there as a trade-off. It's just that the materials used in conjunction with the methods I'm suggesting produce tried and proven results, are widely used, and will make the job go quickly with mind-boggling results. Long story made short, what I have here will enable you to cut down and color a part faster, more uniformly, and get it to a higher level of chrome-like, mirror luster, quicker. As labor intensive and messy as this job is, we certainly don't want to drag it out. You'll see, but for now, just take my word for it.

The following section describes the compounds we'll be using. All compounds must be used in a specific sequence with the appropriate buffing wheels we'll be talking about. You can buy bars of compound in various sizes from over 2 pounds down to 4-ounce. On a home shop basis, 2 pound bars will wind up being willed to your great-great grandkids, unless you do a heck of a lot of buffing and polishing. However, I suggest you order something a heck of a lot bigger than 4-ounce bars or you'll run out before you get warmed up good. One-pound bars are good hand-sized bars when loading buffs and are ideal for what we're doing, here.

### 4.4 Buffing Wheel and Compound Sources of Supply

This section provides you with some sources of supply for commercial grade compounds, buffing wheels, and accessories you can get direct or through a distributor that will sell to individuals.

#### 4.4.1 Southwest Metal Finishing Supply Company

<http://www.tyler.com/secure/swmetal/>

Southwest Metal Finishing Supply Company is major supplier that will sell directly to the consumer, even in smaller quantities. They have an extremely large variety of compounds, compound kits, buffing wheels, buffing motors, accessories, and other stuff. They are a specialty company dealing in metal finishing products only and have a complete catalog on their web page that provides descriptive information on all their products. Southwest does not have a minimum order requirement, but does have a small charge for packaging and shipping. In other words, if you merely need replenishment supplies, you can buy as little as a single item without it costing you an arm and a leg for minimum order charges. Figure 11 shows Southwest Metal's motorcycle kit, though they have many others. They have several pre-kitted items for specific applications or you can put together any combination of items you want directly from their secure, on-line store.



**Figure 11. Southwest Metal Finishing Motorcycle Kit**

Their motorcycle kit shown in Figure 11 is a pretty good collection of stuff, but to get down and do some pretty extensive polishing, really need the full array of items listed in Table 4. The descriptions shown below are used for ordering data as opposed to part or stock numbers.

**Table 4. Southwest Metal Finishing Ordering Info.**

Item No.	Qty Reqd	Description	Note:
1	1 ea	Yellow Mill Airway 6" x 3" x 16 ply x 1/2" Center plate	A good substitute buff might be: Muslin buff, 6" x 20ply x 1/4"ss x 1/2" Arbor hole. (Stack 2 buffs. This is a tight, circle sewn buff that will provide needed stiffness for a cut down operation).
2	1 ea	White Firm Airway 6" x 3" x 16 ply x 1/2" Center plate	A good substitute buff might be: Muslin buff, 6" x 40ply x 1/2"cs x 1/2" Arbor hole. This is circle sewn buff that is slightly softer, yet firm sufficiently firm for cut/color with Tripoli.
3	4 ea	Muslin buff 6" x 40ply x loose x 1/2" Arbor hole	Recommend stacking 2 (2 for white rouge, 2 for red rouge). Once used, do not intermix buff uses.
4	1 ea	Compound, emery cake, 1lb bar	
5	1 ea	Compound, Tripoli brown rouge, 1 lb bar	
6	1 ea	Compound, white rouge, 1lb bar	

Item No.	Qty Reqd	Description	Note:
7	1 ea	Compound, pink rouge, 1 lb bar	
8	1 ea	Rake, buffing wheel	
9	2 ea	Buffing wheel, 3" dia, 50-ply muslin, 1/4" shank mounted cotton	
10	2 ea	Buffing wheel, 2" dia, 1/4" 50-ply shank mounted cotton	

Southwest Metal Finishing has a large array of buffs, compounds, and accessories. See their web page for other items. <http://www.tyler.com/secure/swmetal/>

#### 4.4.2 Formax Manufacturing Company

<http://www.formaxmfg.com>

Formax does not sell directly to the consumer, but their products shown below may be purchased from J&L Industrial Supply, <http://www.jlindustrial.com>, a large supplier to the metal working industry. Each numbered item in Figure 12 correlates to the item number in Table 5. Note that both item 3 buffs are the same type buff, however a separate buff is required for each compound to avoid cross contamination of grits.

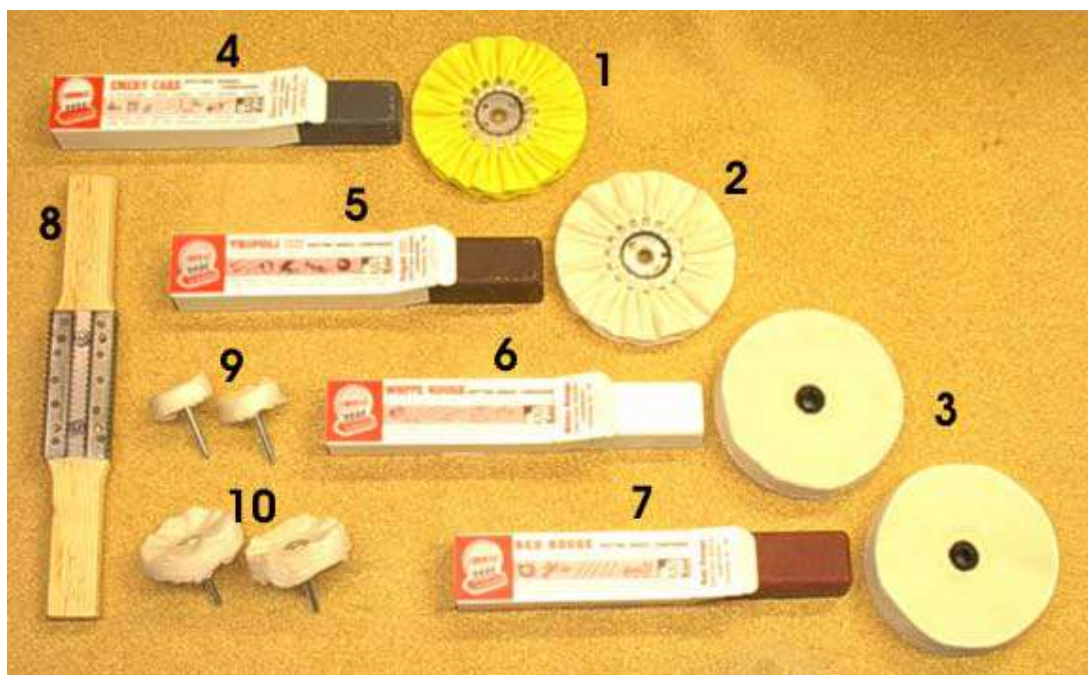

**Figure 12. Formax Polishing and Buffing Materials**

You may order from: <http://www.jlindustrial.com>

Important: See notes immediately following the Table 5.

**Table 5. J&L Ordering Info**

Item No.	Qty Reqd	J&L Order No.	Description	Formax Product No.
1	1 ea	ABW-35030C	Buffing wheel, 6" dia, mill treated bias-cut cotton	515-7212
2	1 ea	ABW-34030H	Buffing wheel, 6" dia, bias-cut cotton	515-7201
3	2 ea	/1. /2.	Buffing wheel, 6" dia, loose sewn cotton	21154
4	1 ea	ABW-27100H	Compound, emery cake, 1lb bar	515-6263
5	1 ea	ABW-11100A	Compound, Tripoli brown rouge, 1 lb bar	515-6260
6	1 ea	ABW-13100E	Compound, white rouge, 1lb bar	515-6261
7	1 ea	ABW-15100L	Compound, red rouge, 1 lb bar	515-6262
8	1 ea	ABW-51573L	Rake, buffing wheel	515573
9	2 ea	ABW-21500K	Buffing wheel, 3" dia, 1/4" shank mounted cotton	515403
10	2 ea	ABW-22500E	Buffing wheel, 2" dia, 1/4" shank mounted cotton	515402

- /1. Use the Formax product number for ordering. The buffs listed for item 3 are not carried in the J&L catalog or web page. They are special order...no biggie. However, if someone previously ordered them, J&L likely bought a case from Formax and they're probably available for immediate shipment without backorder.
- /2. Although these are identical buffs, they are used with different compounds and must not be intermixed. Use a separate buff for each compound, ordering at least 2 as shown in "quantity required" column.

The J&L minimum order was \$25.00 at the date of this publication.

I've listed the Formax product numbers in Table 5 for reference only. You can read all about the specifics of each item and Formax's types and grades of materials and accessories from their link at the beginning of this section. However, you must order from J&L unless you got so carried away with this thing you went out and bought a metal finishing company and can now buy case lots of each item listed.

## 5 POLISHING AND BUFFING OPERATIONS





So far, we've established what materials and tools are necessary. To the surprise of many, polishing and buffing techniques are not simply a matter of holding a part up to a rotating buffing wheel and moving it around until a shine appears. In addition to the "how-to" of polishing and buffing, this section also covers a lot of info that one must know prior to turning on the buffer motor. We're going to cover:

- The polishing and buffing process
- Loading the buff with compound
- Avoiding cross-contamination of compound grits
- Polishing and buffing techniques, tips and tricks
- Maintaining the buff surface with a rake
- The final buffing operations (called “coloring”)
- Safety Precautions (take this seriously)
- Sealing the finished part

## 5.1 The Polishing and Buffing Process

The follow Table 6 describes the sequence of steps, what compounds are used with what buffs, any pertinent polishing characteristics, and a general description of what the part should look like. Each buffing wheel must always be used with the buffing compound listed, never with a different compound.

**Table 6. The Polishing and Buffing Sequence**

Operation	Compound	Buffing Wheel	Polishing and Buffing	Finish Appearance
1 <sup>st</sup>	Emery Cake	Mill treated bias-cut cotton 	This is the most aggressive abrasive of the 4 operations. This compound is used to cut down parts that previously required sanding to get out dings. It removes the texture left from the final sanding and smooths the surface in preparation for the next operation. Use caution. This compound and buff combination cuts aggressively! Constantly move the work piece around to keep the surface uniform and avoid creating lows and highs.	All texture from the last sanding cut must be completely gone. You should now have a satin-like, semi-shine.
2 <sup>nd</sup>	Tripoli	Bias cut cotton 	Tripoli is a popular, general purpose, middle-of-the-road grit for aluminum. It cuts and also colors in preparation for further coloring.	The semi-shine of the cutting down operation has been replaced with a brighter luster.
3 <sup>rd</sup>	White Rouge	20-ply, loose-plied cotton  /1.	This is a very fine grit that's ideal for coloring aluminum alloys. It does not "cut" and removes only a negligible amount of material.	A higher luster.
4 <sup>th</sup>	Red or Pink Rouge	20-ply, loose-plied cotton  /1., /2.	This extremely fine grit is normally for polishing precious metals. Its purpose here is to obtain a mirror finish whose luster exceeds any other polishing approach. These compounds primarily "flow" the surface material under heat and pressure or the ultimate luster.	Get out your sunglasses.

/1. These are the same type buffs, but you must dedicate one buff for the 3<sup>rd</sup> operation only, the other for the 4<sup>th</sup> operation only. Buy a buff for each compound and do not commingle uses!

/2. Do not commingle buffs and compounds! The red or pink rouge would be irreversibly compromised if it came in contact with the smallest amount of a coarser compound. Intended primarily for precious metals, this compound removes virtually no stock, but flows the surface metal through pressure, speed, heat, and the hardness of the extremely fine abrasive.

### 5.1.1 Differences in Buffs.

We can't cover all buffs available or we'd wind up with a hernia book. However, to simplify this thing, you can break the primary buff classifications down into two general categories: (1) full disc and (2) buffs bias cut buffs. You may also hear bias cut buffs called "airway" or "ventilated" buffs.

#### 5.1.1.1 Full Disc Buffs

Full disc buffs consist of layers of cotton sheeting, muslin, etc., that are sewn together in varying thicknesses, depending on what you want and the capacity of your arbor. Full disc buffs may be loose sewn like the one on the left in Figure 13 or sewn in concentric circles like the one on the right. They may also be spiral sewn, the idea being that circle and spiral sewn buffs create additional stiffness. The stiffness can be varied by the frequency of stitching. Other full disc buffs may be sisal or have alternating layers of sisal for heavy cutting down when working with metals other than aluminum. Buffs can be made very thick or as thin as a ¼-inch., depending on how many plies are assembled into the final buff. On buffs that around ¼-inch thick or so, you'll find you can stack multiple buffs on one arbor to get the thickness you want. Of course, you can always order thicker buffs. When working with thicker or stacked buffs, expect to generate the kind of heat on the part that will have you blowing on your fingers pretty quick.

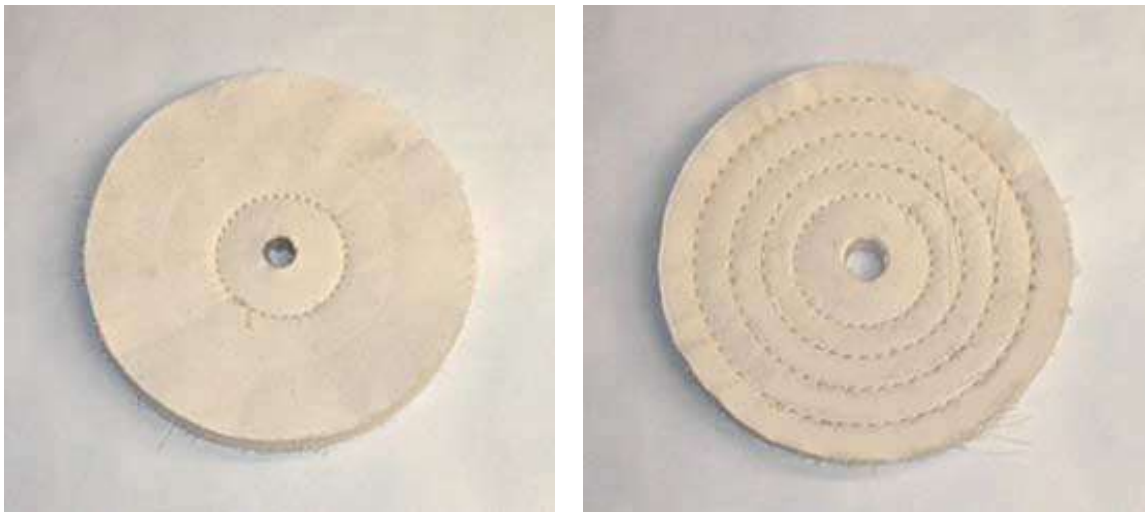

**Figure 13. Full Disc Buffs, a Loose Ply (left) and a Circle Sewn (Right)**

These particular buffs are from Southwest Metal Finishing <https://www.tyler.com/secure/swmetal/>. You can also find a broad array at Quality Buff Company. <http://qualitybuff.com/>. For coloring operations, you need a soft, loose plied buff like the one on the left in Figure 13. These will look rather floppy at rest because they aren't supported with stitching other than around the arbor hole. However, the moment you turn on the buffer motor, centrifugal force will sling each ply out as tight as a banjo string. As mentioned earlier, a loose ply buff can "mush buff" around projecting features of a part.

A circle sewn buff like the one on the right in Figure 13 would be a good choice for cut/color compound with Tripoli. Of course, you can also get these in versions having stitching down to only ⅛-inch spacing. With closer, spiral or concentric stitching, they can be as stiff as a board, primarily



for pretty heavy duty cutting down. When you first start a break-in on either one of these buffs, strings may fly out like an explosion in an angel hair spaghetti factory until it's broken in. You'll want to take some scissors and trim the longer strings that are whizzing around in the air. In case you didn't figure this out, turn the motor off first unless you're real fast with the scissors. Some buffs may come already "tamed" and pre-raked.

With a little wear on a full disc buff, you'll notice that you're losing strands of the weave every 90 degrees around the buff due to centrifugal force. Of course, in those areas, the weave of the cloth is more susceptible to being pulled out. Note that in between those areas, the buff remains fairly intact because the weave is on the bias (at a 45-degree angle) to the periphery.

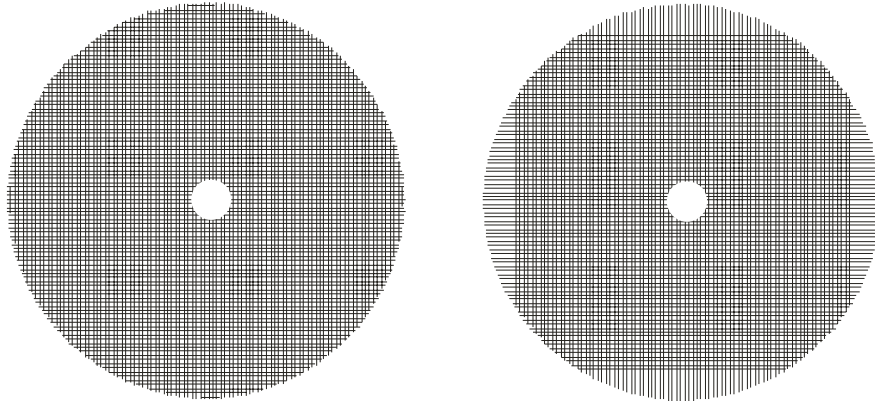

**Figure 14. Wear Pattern of Full Disc Buffs, new (left) and worn (right)**

On better full disc buffs, the orientation of the weave is rotated a few degrees with each ply making up the buff. This way, wear from the loss of loose strands is fairly even all the way around the buff periphery rather than you winding up with a vibrating square buff. Full disk buffs are very popular and variations in their sewing allow them to fit a broad range of buffing applications.

#### **5.1.1.2 Bias Cut Buffs**

Bias cut buffs are constructed quite differently. The yellow buff on the left in Figure 15 is mill treated to give it extra stiffness for cutting down operations. They also come available in a variety of other mill treatments, ply construction, thread counts, etc.

Personally, I like to use a bias cut, mill-treated, yellow buff for cutting down with emery cake as shown for the 1<sup>st</sup> operation in Table 6. When I shift gears and start the next operation with Tripoli, I stick with a bias cut, but use a non-treated, bias cut like the one shown on the right in Figure 15. Although the basic construction is the same in either case, the non-treated, white buff is softer and ideal for the cut/coloring characteristics of Tripoli compounds.

The steel centers in these type buffs ruffles and crimps the fabric such that all threads are at a 45° angle to the periphery, in other words, on the bias. This minimizes fraying of threads at the edge of the buff and pulling out. In addition, the ruffled edge works well around tight places. There's one very important thing you've got to know when using a bias cut buff. Always use a pair of flanges like shown in Figure 16! As mentioned earlier, you may also hear these buffs referred to as "airway" or



“ventilated” buffs. Although some have reusable center plates, the ones we’re using here are one-piece construction.

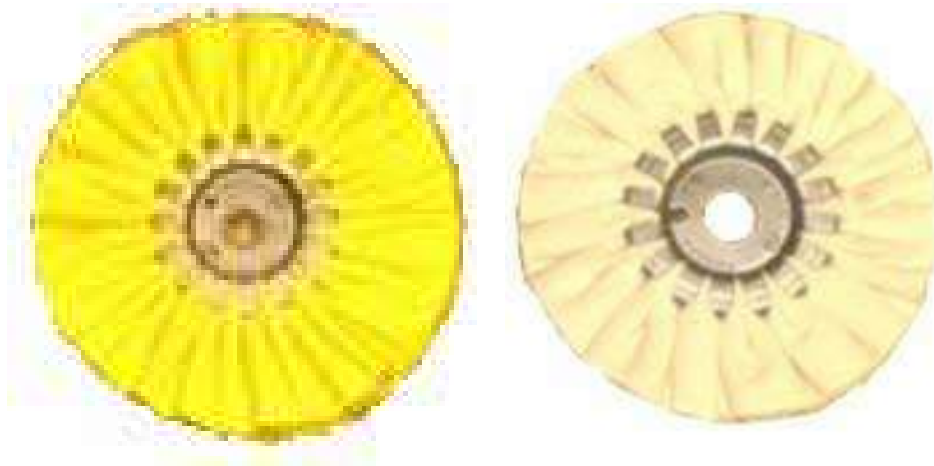

**Figure 15. Bias Cut Buffs**

You’ll hear folks state that bias cut buffs run cooler due to the crimped, steel center plate. When someone convinces me that cotton is high on the scale of thermal conductivity, I’ll believe that. Any cooling is a result of a lot more air being stirred up by the ruffled construction and nothing more. The main advantage of a bias cut buff is the fact it’s less prone to fraying and is sturdier due to its ruffled construction.



**Figure 16. Flanges for Use with Bias Cut Buffs**

Unless you’re running extremely low speeds like our drill mounted in a vise back there in Figure 5, you’ll definitely need to use flanges when using any bias cut buff. Otherwise, centrifugal force can cause the crimped steel fingers to turn loose and give you a face full of ripped up, high rpm, buffer material. If you bought any of the buffer motors we previously talked about, the motor will likely come with a pair of rather heavy duty flanges that will give the a bias cut buff all the support it needs. If the stock flanges that came with the buff motor look a little wimpy or don’t completely cover the steel center, you’ll have to have a pair of these.

Before using any buff, read all of the section on Safety Precautions. Some stuff in there is very important and I guarantee you there are safety precautions in Section 7 that will surprise you. Also, read “Polishing Tips and Tricks” in Section 5 so you won’t booger up your part or yourself.

## 5.2 Loading the Buff

Okay, we’re getting close, here. Before you can polish and buff, you obviously have to get compound from the molded bar to the surface of the buffing wheel. A charged, rotating buff can then move the compound across the surface of the part. Each compound listed in previous sections consists of a grit of specific size, sharpness, and ability to maintain a cutting edge for a predetermined time before dulling. In some compound formulations, the grit particles fracture into smaller particles to result in a gradually finer grit during use. Actually, there are a zillion other dynamics, but that’s it in a nutshell. In our case, the grit is suspended in an animal fat medium which makes up the molded bar of compound like a giant bar of soap.

**IMPORTANT:** The big thing here is to remember to not overload the buff! The buff is loaded with compound by bringing the end of the bar in contact with the rotating buffing wheel. Holding the bar of compound against the spinning buff under slight pressure will cause friction to quickly bring the bar to melting temperature and transfer the compound to the buff. Apply small amounts of compound to the wheel for only a couple of seconds at a time to avoid compound waste and to achieve a higher luster. We’re only talking a few seconds of contact between the bar the buff! If you put too much compound on at one time, it will back transfer to the part and you’ll end up having to clean off extra tallow or greases that are left on the part. It’s always easier to apply more compound than it is to rake out the wheel, and have to start over. You’ll get much better results and a higher luster by frequently loading the buff as needed while polishing. You’ll be able to tell when the buff starts running dry. See Figure 17.



**Figure 17. Loading the Buff**

As the melting compound starts transferring to the rotating buff, loose particles will fly off in the direction of the buffing wheel’s rotation. Repeating myself once more, don’t load the buff too heavily. Just hold it gently against the buff for 2-3 seconds at a time.

If you don't have a powerfully sucking dust collector, this can be messy business. There's not much way around it...it comes with the territory. If the bar is held in relationship to the buffing wheel as shown in Figure 17, most loose particles of compound will be directed to the floor as opposed to up in the air and all over your garage or shop and you. A cut-down corrugated box or other device can be positioned below the spinning buff to catch as many wayward compound particles as possible. If you don't do this, these same particles stick to your feet...big time...and can be tracked into your car or inside the house. Unless you'd rather sleep with your Harley than your significant other, you might keep this in mind. Even with dust control and shop vacuuming the floor, compound particles and buffing dust will stay with you like stepping on chewing gum in a hot parking lot. Even with all the cleanup, you might consider stepping out of dedicated "polishing shoes" before going back in the house. If you don't take some precautions to control this stuff at the source, about the only way you're going to clean it up quickly is with dynamite. We'll remedy most of this mess-making later when we talk about dust control...well, a lot of it, anyway.

Buff loading hint: Another good way to conserve material as well as minimize particles slung to the floor is to hold the work piece against the lowest part of the buff in one hand while holding the bar and loading the buff with the other. This tends to embed particles in the buff that would ordinarily wind up on the floor. Guess I should have shown that in Figure 17, but I forgot and didn't want to redo the pics. Just use your imagination.

### 5.3 Using a Rake

A buff can gradually become compacted with dried-out compound to the point the polishing surface glazes, turns firm, and loses much its ability to make use of the compound's grit as an abrasive. A wheel rake is held to the spinning buff to rake out the dried material and fluff the nap of the polishing surface. You'll also use a rake to rake out an over-loaded buff, which you'll probably do until you get the hang of it.

Hold it at about the same angle to the buff as shown in Figure 17 to force the bigger stuff that's raked out toward the floor, except this will be a two-handed deal. If you're holding the rake against the buff and it's not working, you forgot to turn on the motor. The rake will remove hardened, glazed compound and return the buff to a nice fluff. The buff can then be reloaded with fresh compound, reactivating its effectiveness and working life. See Figure 18.



**Figure 18. Buffing Wheel Rake**

If you don't get one of these, you can always use something like the edge of a pruning saw or something similar. However, a buffing wheel rake has multiple rows of teeth and does it quite a bit better and quicker. If you do much polishing and buffing, bite the bullet and get one because you'll be doing a lot of raking. When retiring a buff after an operation, always give it a quick fluff with the rake to prevent an accumulation of dried-out compound.

Some use a rake to remove compound from one operation before going to the next so they can use the same buff. That's okay for more run-of-the-mill polishing, but we definitely can't do that here due to the likelihood of intermixing compounds of different grits. As I mentioned before, we're going a notch higher than an ordinary luster by kicking it up to a get-out-your-sunglasses, mirror luster beyond the best.

If you didn't get the message before, wear safety glasses and a dust mask before you do this. This is exactly how I got popped in the eye when removing my glasses for a couple of seconds while raking a buff. Not smart on my part.

## **5.4 Avoiding Cross-contamination of Compounds**

Cross-contamination of compound grits can quickly prevent you from getting a true chrome-like, mirror luster. By cross-contamination, I mean getting the smallest amount of a coarser grit on a part or buffing wheel when going to the next operation with a finer grit compound. The part might wind up being shiny, but it will be a long ways from shiny-shiny, the chrome-like, mirror luster we're after. The shine we're talking about here is a notch up from what other folks call "shiny." The following sections will show you how to avoid cross-contamination. This involves:

- Using a different buffing wheel for each operation
- Cleaning hands or changing gloves between operations
- Cleaning parts between operations
- Protecting buffing wheels and finished parts from flying compound particles and dust when polishing without effective dust collection

### **5.4.1 A Different Buffing Wheel for Each Operation**

As I mentioned earlier, some folks use a rake on the buffing wheel between operations to clean the grit from the buffing wheel in order to use the same buff for the next finer grit. If it's well raked, this is okay for run-of-the mill polishing and buffing applications, but not here. We're going for the max. You can easily leave a small amount of the coarser grit in the buff. The only sure-fire way to guarantee that residual amounts of a coarser compound do not get intermixed with a finer compound is to use a different buff. Besides, we're talking about parts here that are darn near worth their weight in gold, anyway. The cost of an extra buff just isn't that big of a deal when the payback is assurance of getting the full potential out of the compound. The buffing wheels I've listed for the 1<sup>st</sup> operation (cutting down) and 2<sup>nd</sup> operation (combination cutting and coloring) are specialized for their particular use and should not be used with any other compound. Although the 3<sup>rd</sup> and 4<sup>th</sup> operations use the same type of buff, the same buff must always be used with its respective compound to avoid

cross contamination. Should cross-contamination happen, we cannot achieve the level of mirror luster we're after. If necessary, mark identical buffs with a felt marker to keep them separated.

To get a grip on the effects of polishing with intermixed compounds, imagine sanding with 2, 2-inch strips of sandpaper attached side-by-side on your palm sander...one coarse, the other fine. Obviously, the coarse grit is going to booger up what the finer grit is trying to do. Remember, we're going after a mirror luster that's a notch over and above any conventional aluminum shine. Exactly like the sandpaper cuts, we have to remove all micro-scratches made from the operation prior with the next operation...not put scratches back in at the same time. Of course, when you get past the 2<sup>nd</sup> operation, these "scratches" are truly microscopic which you'll see with the unaided eye only as varying levels of luster by turning the part at an angle to view the luster as it increases during the operation.

I know what folks that have done this before are now thinking...they're thinking, "Well, I'll be dipped!...that's the reason I polished and polished and polished and that dude just got up to so-so shiny and wouldn't go any further! You're correct...although it could be other things as well, chances are you cross-contaminated a compound grit with a previously used, coarser grit. This is usually the case when folks start with brown Tripoli, and then try to use the same buff with white rouge. They are buffing with white rouge that has the coarser brown Tripoli intermixed on the buff and don't know it.

#### **5.4.2 Clean Your Hands or Gloves between Operations**

There's no way to polish without getting compound and buffing residue all over your hands or gloves. Obviously, if you have relatively coarser compound all over your hands, you're going to transfer it to the part when you start the next operation. Disposable vinyl gloves work great. They're dirt cheap throw-aways and you can find them anywhere paints are sold. You can change gloves between operations or simply wash your gloved hands in a de-grease type dish detergent. Liquid Palmolive dish detergent or Dawn works fine. Once you have clean gloves for the next operation, don't touch a buffing wheel or anything having compound on it from a prior operation. The best way to do this is hit all of one batch of parts with a 1<sup>st</sup> polishing operation and change gloves. Then, hit the entire batch with the 2<sup>nd</sup> operation buff and compound, change gloves again for the 3<sup>rd</sup> operation coloring, and once again for the 4<sup>th</sup> final coloring. Of course, if your gloves stay intact that long, a good hand washing with your gloves on will work just as well as changing gloves.

#### **5.4.3 Clean Parts between Operations**

After each operation, clean parts, first, with a soft rag to make sure no compound is left in recessed holes or other features of the part. (See the next section on cleaning rags). If a buffing wheel picks this stuff up, it would have a coarser compound grit intermixed on the wheel as described earlier. After cleaning off as much as possible, wash off what you can't see with ordinary liquid dish detergent like Palmolive liquid, Dawn, or similar. Finally, dry with a clean, soft cloth. Again, all of this is done between each and every operation.

##### **5.4.3.1 Cleaning Rags**

Keep a big box of soft, cleaning rags...gobs of them. When cleaning parts just mentioned, keep cleaning rags you're using for different operations separated...like, 1<sup>st</sup> operation rags, 2<sup>nd</sup> operation rags, and so forth. If you're getting ready to do cleanup on a part that's just received its final mirror-luster coloring and, say, grab a rag you previously used to clean up a part after its 1<sup>st</sup> polishing operation, you can micro-scratch the part, which you'd see with the naked eye as an area not quite as

shiny as others. You can buy bundled rags from hardware stores or simply cut up a bunch of old worn-out t-shirts...or anything else that's cotton and soft.

If you get to a point to you need to wash a bunch of rags to restock your supply, for Pete's sake wait, until your significant other is out of the house. The buffing residue in the rags leaves a large, black, greasy ring around the clothes washer that will initially almost give you a coronary. No biggie...whew!...it wipes right out with one swipe, but I still wouldn't do it while she's around the house. There's no since in catching all the flak for something that looks far worse than it is. Throw'em in the dryer real quick and stash them back out in the garage. They'll never know squat unless they stick their head in the dryer immediately afterwards and sniff something weird. Clean out the dryer filter to cover your tracks.

#### **5.4.4 Protecting Buffing Wheels**

If you're not using a powerful dust collector like you'd find in metal finishing shops, compound particles when loading buffs and dust from polishing, buffing, and raking will be all over the immediate work area. Keep buffs not being used in covered storage or somehow covered.

#### **5.4.5 Protecting Finished Parts**

Keep finished parts covered. If buffing dust somehow gets on finished parts, don't wipe it off with a dry cloth. Instead, flow it off under water. This is particularly true of softer alloy parts, such as the derby on a Sportster. There are a few other Harley parts that are also a much softer aluminum alloy than the cam, primary, and tranny covers.

## **5.5 Polishing Technique Tips and Tricks**

By now, you should have an information overload. Good. We're ready to put a shine on some Harley parts that will knock your socks off. Not only that, but it will knock the socks off others and your ride will wind up being the subject of conversation wherever you go...well, unless you're riding 2-up with some hot babe that detracts from anyone noticing you're even on a bike.

### **5.5.1 Cutting and Coloring Strokes**

Whether it's an initial cutting down operation with emery, Tripoli, or a 3<sup>rd</sup> or 4<sup>th</sup> coloring operation, a part being polished and buffed has distinctively different cutting and coloring strokes. When the part is moved in the opposite direction of buff rotation, you can clearly feel a cutting effect...a slight "drag" of sorts when making left to right strokes. On the return stroke, the part is moving in the same direction as buff rotation and you can clearly feel a lighter, buffing effect...coloring.

When cutting, hold the part against the buff with only moderate force, allowing the compound grit to perform the work, frequently reloading the buff very lightly so as not to overload it. Coloring is the return stroke in the same direction as the buff. See Figure 19.

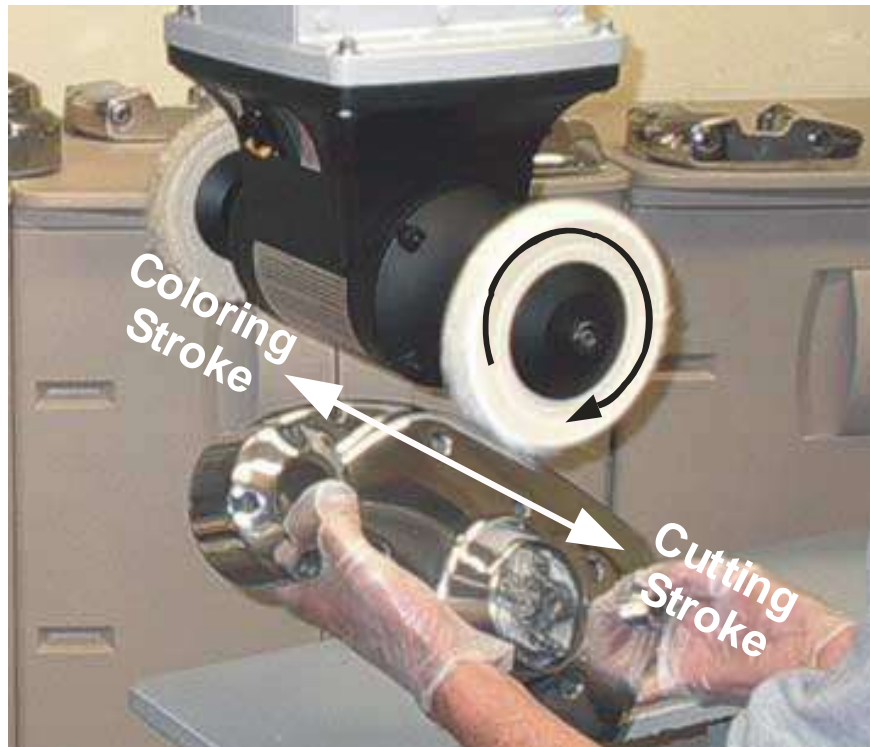

**Figure 19. Cutting and Coloring Strokes**

The final, two-step coloring is done with very light pressure, allowing the very fine grit to bring out the luster. That part in Figure 19 is the cam cover off an old abused rat bike I found in a rural storage shed that'd been there 14 years, untouched...a 1000cc, 1972 XLH Sportster. It still had the same 1988 plates and inspection sticker. Kinda brings a new definition to the phrase, "precious metals."

### **5.5.2 Part Orientation Relative to the Buffing Wheel**

The first and most fundamental thing that comes to mind about polishing and buffing is the orientation of the part relative to a fast-moving buff. Believe me, you'll catch on to this one real fast! When you get close to the edge of a part, you have to rotate the part 180 degrees to get all the way to the edge you were approaching. Otherwise, getting too close to the edge will result in the buffing wheel grabbing the part edge, violently yanking it out of your hand, and slinging it across your garage or shop. This happens faster than you can begin to even think about reacting. You couldn't prevent the part from becoming airborne even if you had a death grip on it. If you could hold the part that tight, you and the part would wind up being traveling companions. Whether you're running a ½ hp or bigger motor or an ordinary drill motor in a vise, the buff snagging the work piece can be catastrophic for both you and the part. Fortunately, it's usually the part that gets the blunt of it from bouncing around on the concrete. When that happens, you're usually back to square one...sanding out ugly dings. It's a bummer, believe me.

Take another look at Figure 19 and note the rotation direction of the buff. Imagine continuing moving the part to the left until the buff reached the sharp edge of the cam cover at the end held by the right hand as shown in the figure. The sharp edge would all of a sudden get caught on the buff...and



POW!!!...the part is airborne. You have to stop well short of the part edge, change ends, and then buff the rest of it. Of course, if you're using the buff that's on the arbor at other end of the motor, your position relative to the whole enchilada is just the opposite...a mirror image.

I can tell you right now what's going to happen...sooner or later. Most are prone to want to delay having to turn the darn part around. For some reason, they want to see how close they can get to the very edge of the part while holding the part the same way, being as they are convinced they have Superman coordination. What happens is that in trying to get as close to the edge as possible, they get too close. By then, it's too late to wish they'd stopped a little further back before the part made like a Frisbee breaking the sound barrier. The rework from bouncing across the concrete ain't fun, folks...particularly if you were all the way down to your final coloring operation. Don't ask me how I know this.

### **5.5.3 Part Temperature**

One polishing trick is to keep larger parts warm...not hot-hot, but warm. By keeping the part warm, the compounds can do a better job. If the part is cool, the part can draw the compound out of the buff, leaving deposits in little spots or black globs. Of course, this might also indicate you've overloaded the buff, need to rake and start over.

When buffing smaller, thin-wall parts, they will usually automatically stay fairly warm just from the friction. Matter of fact, some may get quite hot, which you don't want, because it can actually warp thin-sectioned parts or you'll see an aluminum "bubble" of sorts roll up on the surface. However, this will not likely happen with the larger and thicker cross sections of Harley parts when using motors, buffing wheels, and speeds we've been discussing, here. Just keep this in mind if you somehow wind up polishing a thin-section part.

There may be several ways to pre-heat parts, but during winter, but I use an infrared lamp similar to what fast-food burger joints use to keep French fries warm for hours on end...until you could dip one in ketchup and drive it in a board with a hammer. During the winter, I'll have several parts under the lamp "idling" until it's their turn in the barrel. However, in the Dallas area where I am, I'll guarantee you that keeping parts warm is no problem during the summer.

### **5.5.4 Polishing with Sets of Strokes at 90-Degrees**

I mentioned this earlier, but this technique pushes a compound to its fullest potential...the ultimate. If you have the clearance between the buffing wheel, motor mount, and stand, make your cutting and coloring strokes in one direction relative to the length or width of the part, then rotate the part 90° and make more cutting or coloring strokes (going crossways). Continue this sequence of sets of strokes in 90° rotations until you've achieved all that the particular compound is capable. Of course, if you really want to go goofy here, rotate it in 45° increments as well.

When cutting down with the 1<sup>st</sup> polishing operation, you'll also notice that rotating the part in 90° increments makes the cutting action go faster. The custom, home-built stand shown in Section 4.1.4, Figures 9 and 10, is the only stand configuration that provides the clearance you need to do this with big primary covers, or for that matter, as large a part as you have strength to hold under the buff.

If you achieve the objective of each operation prior to going to the next, you'll have a mirror luster indistinguishable from the brightest of the brightest chrome plate. Matter of fact, it will be so slick,



I've had flies limping around in my garage because they tried to land on a finished part and twisted an ankle. Here's an example:



**Figure 20. Cam Cover from a 1978 Glide**

How you like that? As Figure 20 states, that cam cover is from an old 1978 glide. Before starting, this thing was pitiful. Dings ran up to about .010 deep, requiring removal of the same amount of material. That's a lot...and a ton of sanding...far from sanding wood, folks. In the case of this old cam cover, it took more time to get through all 4 sandpaper cuts than it took for the 4 polishing and buffing operations. You should expect that on truly old and deeply blemished parts. The payoff is finding out that for really dinged-up parts, the prerequisite sandpaper cuts are a major contributor to the final finish. The cam cover is a relatively small part, but in this case, a ton of work. Pretty cool, huh? That thing might look like aluminum, but it ain't...that's Harley "gold."

## 5.6 Problem Parts: High Porosity Castings

Okay, if you've been absorbing this stuff, I guess you're ready for an advanced course. Tell you what...had this section you're reading at this moment been right at the front of this silly book, you would've said, "To hell with it," and be inclined to just paint the whole bike with roll-on, flat latex. Here's the deal:

Once in awhile, you'll run into a casting that has a degree of porosity. If you've ever wondered what "the pits" are, well...this is it...the pits. The tell-tale sign is inspecting a freshly cleaned part and seeing an abundance of small pits obviously not inflicted by use of the bike. There's not much to say here other than the fact the part was produced in an improperly designed mold that didn't compensate for the configuration of the part. It may have been poor riser design, failure to allow for proper outgassing, and a zillion other mold design considerations, all pointing to poor mold design.

What happens here is after cleaning and identifying the sandpaper grit you need to start, you commence sanding and begin noticing pits you didn't have before. In trying to eliminate those pits, you wind up sanding down, only to replace those pits with more pits lurking only a few 10-thousandths of an inch or so below the surface. In other words, the pits are all the way through the part like Swiss cheese and sanding is not going to remove them. These dudes will multiply like Amoebas while sanding. What's worse is the fact that these parts resist being polished by normal approaches in that they simply won't take a shine using methods we've discussed so far.

There are metal finishing experts out there that will tell you that these type parts simply won't polish, period, much less take a luster. Being a bunch of dumb-ass bikers, we're going to ignore that and make'em shine, anyway. Ok...here's what we do: Just start out as usual and sand the surface uniformly, continuing to sand with subsequently finer grits to get out the scratch caused by the grit prior like any other part. Don't worry about the pits.

Examples of parts that are notorious for extreme porosity are the front and rear brake side plates on older brake-shoe type bikes. You might run into similar parts. If so, you have my sympathy, but the same thing we're going to do here will work for any high-porosity aluminum part. Figure 21 is the front brake side plate from an old 1972 XLH Sportster, heavily abused at that. In terms of porosity, these take the cake. The rear brake side plate is a ditto of the front brake side plate.

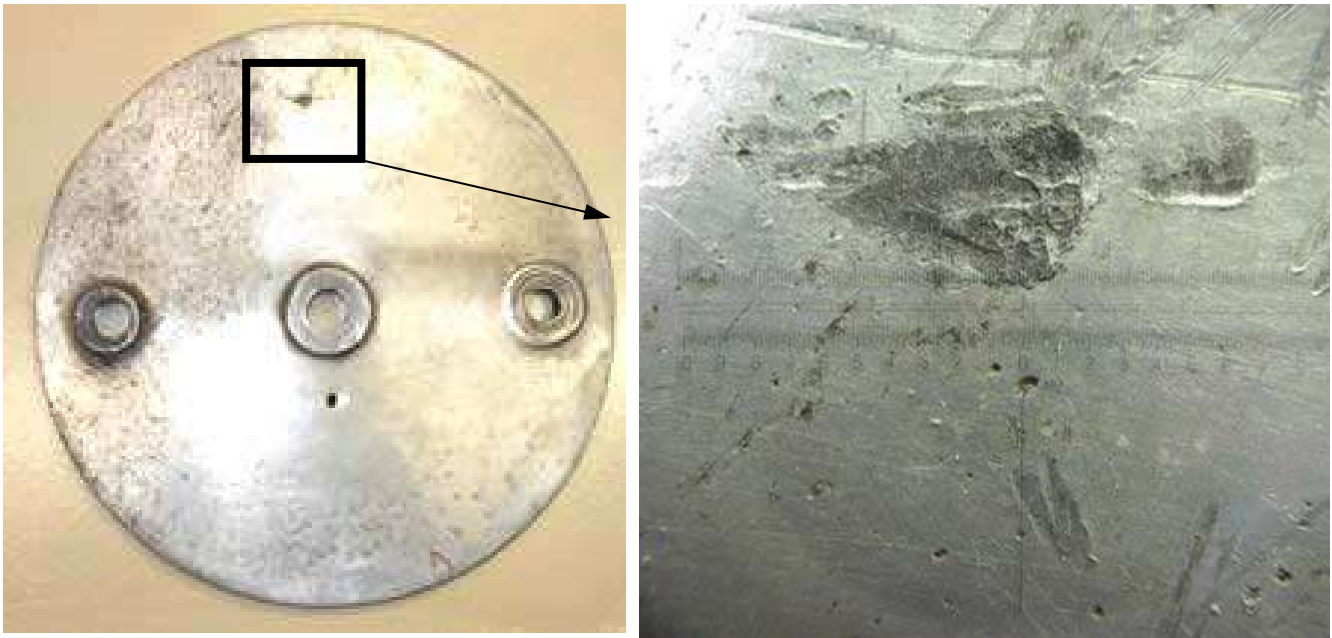

**Figure 21. Problem Part**

At first glance, the old front brake side plate shown on the left looks like a typical old part with merely more than its share of dings and gouges. I've highlighted a few massive dings in the square on the left that are shown magnified 10X on the right. These dings aren't the problem. Look closer at the pic to the right. You see those pits?...the pores?...the little holes? Yeah, that's them...and those dudes are all over this thing. The dings and gouges we can get out. That's mere poo-poo...no prob whatsoever. However, those pits were cast into the part when it was brand new. If you can zoom in far

enough on this thing, you might make out that the upper scale is in .005-inch increments. These zillion little pits measure anywhere from less than .005-inch diameter, upward to as much as .020 or so and look like the surface of the moon if you zoomed in enough. What you want to do here is concentrate on sanding out what are obviously major dings and gouges inflicted on the part over the years and basically forget about the pits. In sanding out big dings and gouges, you'll take out a ton of pits that were visible before you started, but will find you've only gone down a few 10-thousandths of an inch to another fresh batch of pits just molecules below the surface. In other words, you now have a part free of dings and gouges, but have a new set of pits, except we still have a few of the original "craters" that run deeper into the part than is practical to sand.

On this part, I went through a four grits of sandpaper: course, medium, fine, and finally, 320 grit. I dry sanded with coarse and medium, and then shifted to a wet-sand for the fine and 320 grit.

Now, take a look at the part in Figure 22 after a 1<sup>st</sup> cut (coarse) and a 2<sup>nd</sup> cut (medium) sanding, then a 3<sup>rd</sup> (fine) and 4<sup>th</sup> cut (very fine) in Figure 23.



(10X magnification)

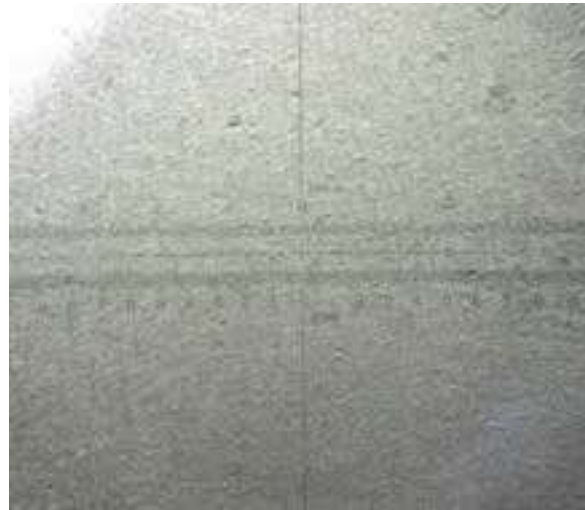

(10X magnification)

**Figures 22. First and Second Sandpaper Cuts**



(10X magnification)



(10X magnification)

**Figures 23. Third and Fourth Sandpaper Cuts**

Without doing a major zoom-in, I don't think you can see this, but the pits are still there, though the surface between the pits is smooth and ready for the 1<sup>st</sup> cut down, polishing operation. You don't see as many pits only because this thing is so magnified. Under magnification, the surface looks like the surface of the moon...pits are still everywhere, even after sanding with 4 different grits. The last two cuts were wet sanded until this thing was smoother than a baby's butt...except for those darn pits.

#### **5.6.1 Trick Number 1, Intentionally "Overloading" the Buff**

If you were to just start out buffing one of these type parts like any other part, you'll quickly find that the part mysteriously doesn't want to respond to buffing and yield a shine for no apparent reason. Using the normal approach, you can buff until the cows come home and there won't be a noticeable change. I mean, it will be so bad, you can't even get a slight shine started, much less the makings of a luster. Hold up, here...let's think about this.

First of all, we know that the only difference in overall appearance is the fact the part has pits...scads of pits. We know we're not going to shine individual pits, so the logical question is, "Why won't the darn part shine in areas all around the pits?" To determine what's happening, we have to microscopically climb down inside a few pits and see what's going on down there. Well, that's exactly what I did, using sufficient magnification to actually see down inside a bunch of these jagged "craters."

As this part is fresh out of wet sanding, it's smooth and polish-ready except where we have sudden drop-offs into pits all over the surface. While climbing out of some craters...like scaling a cliff, what I found was that the wet-sanding had sharpened the edges around the pores. The very edges are now razor sharp and hanging out there to snag compound from the buff. See Figure 24.

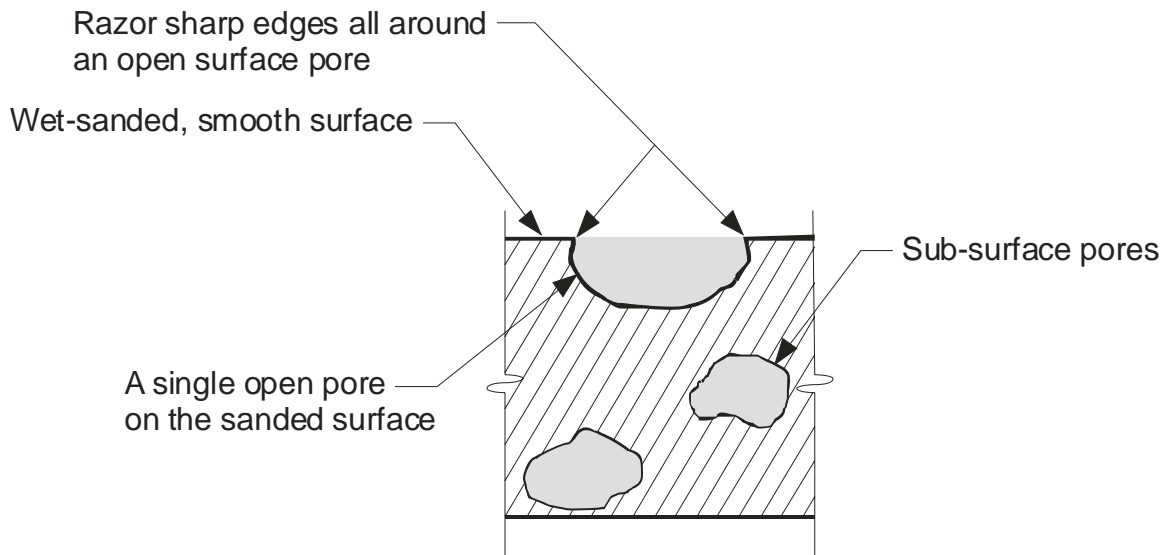

**Figure 24. A Single Surface Pore after Wet-sanding**

When starting to buff, the freshly sanded pores are now razor-edged from sanding and are stripping the compound right out of the buff. What's deceiving is the fact that the total number and depth of all pits (pores) have a far greater volume than the amount of compound we loaded on the buff at onset. The second the rotating buff comes in contact with the surface of the work piece, our compound is being immediately stripped out as if you'd used a zillion, ultra-efficient, miniature rakes. With no compound on the buff, you don't polish...it's that simple. Thus, the riddle of "unpolishable" parts is explained.

When bringing the work piece in contact with a buff a mere second or two after just after we got through loading the thing, it'd be hard to convince someone they are near instantly running a buff as free of compound as a frog has hair. I mean...they just got through loading the buff a split second ago!...how could this be? When they get discouraged and reload the buff once more...and still don't get results, they will likely give up on the part, settling for a dull surface finish. Actually, all they had to do was keep reloading and reloading until the surface pores filled with compound.

What we're onto here is a way to defeat these weird polishing dynamics. The way to defeat this thing is to "overload" the buff like crazy...like ever few seconds...keep reloading and buffing, reloading and buffing. You'll notice that the compound seems to mysteriously "disappear." Actually, you're not really overloading the buff at all, merely reloading to replace the compound as fast as it's being stripped from the buff by the razor sharp edges of all these blame pits. Reload and buff...reload and buff...and keep going. You'll know when you get there. The pits will finally get compacted full of compound, and at some point in time, you might get close to actually overloading the buff and have to back off.

Aha!!!...a slight shine gradually starts showing through just at the time we've filled all pits up to the top...filled with compound and buffing particles. Now, slack off the loading and keep buffing, making sure you don't start running lean again. I know all this is the exact opposite of everything else



we've talked about when it comes to loading buffs, but we have an entirely different set of buffing dynamics taking place. If you try this on a normal part, you'll merely have an overloaded buff and a mess you'll have to rake out. Take a look at Figure 25.

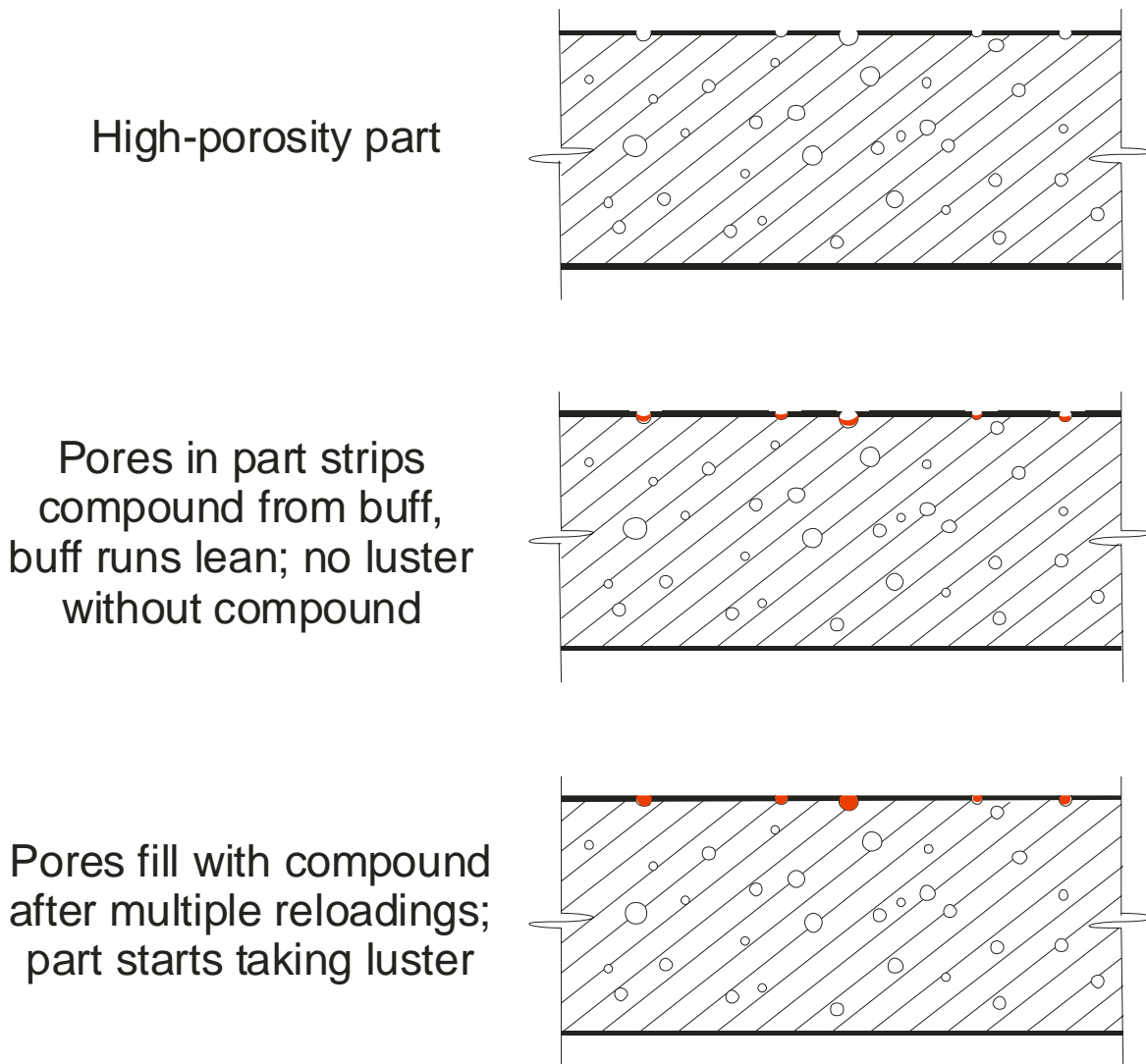

**Figure 25. Filling Surface Pores with Compound**

Okay, hold up right here. We gotta prob. We're sitting here holding a part that looks it's supposed to look right after a cutting down operation. The big difference is we are also holding a porous part having compound in a zillion little pores that isn't going to respond to normal cleaning.

If you remember the previous sections, you know full well we can't intermix compound grits. This means we've got to figure out how we're going to get all that residual compound out that we compacted in all those little pits. We've got to do that before we move to the next finer grit. Otherwise, we've put the brakes on getting a shine any better than what we should expect from an

initial cutting down operation directly after sanding. Of course, that's no luster at all, just smoother. Figure 26 shows you the brushed look you'd expect after the final sanding, followed by an initial cut down with emery cake.



**Figure 26. After 1<sup>st</sup> Polishing Operation (cutting down) with Emery Cake**

Before we move on to Tripoli, we're going to have to get innovative on how to clean this thing. The cleaning process will be far more intensive than is necessary for a non-porous part.

### **5.6.2 Problem Part Cleaning**

We're about to clean this thing before going to the next grit. This is the other reason that some polishing folks will tell you these parts are "impossible" to polish. In addition to problem number 1 (stripping compound out of the buff as fast as we load it), they are also not getting the part clean prior to starting the next polishing operation and are inadvertently creating problem number 2 (intermixing compound grits).

Here's what you have to do: clean the part with Fantastic cleaner or 409. You can use any one of those more powerful household degreasers. I used Fantastic, myself...and it worked like a hose. You can see the stuff float out of the pores right in front of your eyes. These degreaser type cleaners start working instantly and it will pretty much dissolve and wash out the pores in nothing flat. However, repeat the washing/degreasing a couple of times, at least. Some pores will entrap compound because the opening of the pore at the surface is smaller than that part of the pore down a little deeper...like an underground fox den where the pore opening at the surface is smaller than the void just below. These parts are way too much work to let the few extra seconds of cleaning time result in not getting all compound out of the pores. After a very thorough cleaning, dry the part and go on to the next compound and polishing operation with Tripoli. Load and reload the buff every few seconds just as we did before...until the pores are once more filled. When you get the pores filled by repeatedly loading and reloading the buff, a shine consistent with Tripoli will finally emerge.



**Figure 27. Finally!...Starting to Take a Shine**

Well, it's looking a tad better...though we're only about halfway through a cut/coloring operation with Tripoli at this point. After taking the Tripoli as far as it will go, we're going to have a lot of compound embedded in those pores needing cleaning out once more. Again, clean thoroughly two or three times with Fantastic, 409, or a similar.



**Figure 28. Finished with the Tripoli**

Figure 28 shows the part after we've gone about as far as we can go with Tripoli. After the Tripoli, rinse and clean about three times. Now, we're ready to color with white rouge, refilling the pits all over again before we can get the luster going once more. White rouge really brings out depth in the part and will further advance the mirror finish...well...except for the pores we've had from the start.



Wow! It's getting there! After this operation, clean the part several just as before times and start refilling the pores, this time with pink rouge. The part must be extremely clean to avoid contamination with the slightest trace of the prior grit. We're through!

As you already know, make sure you use a different buff with each operation. Keep the heat up pretty high on the part, being careful to keep the part evenly heated so it won't warp. I stacked 2, ½-inch thick, loose ply, muslin buffs in the case of the part shown in Figure 29. However, you can use a single ½-inch buff, depending on the part shape contours, tight places you have to navigate around, etc. I did the final coloring on the part in Figure 29 with pink rouge from Southwest Metal Finishing. <https://www.tyler.com/secure/swmetal/>

If you're running a 1-inch stack at 3450 rpm, you can expect the part to get hotter than you can comfortably hold in your bare hands. Enough if this...go take a look.



**Figure 29. Part They Say Won't Polish**

A strange thing will happen during coloring. These extremely fine rouges will actually cause microscopic "surface flow" of aluminum alloy material across the surface of the part. Now, this isn't going to fill in Grand Canyon-like pits, but it will certainly diminish the effect of the pot hole-like pits we had earlier. We've filled in the gaps with parent material. A look at Figure 30 will give you an idea of what's happened to the surface.

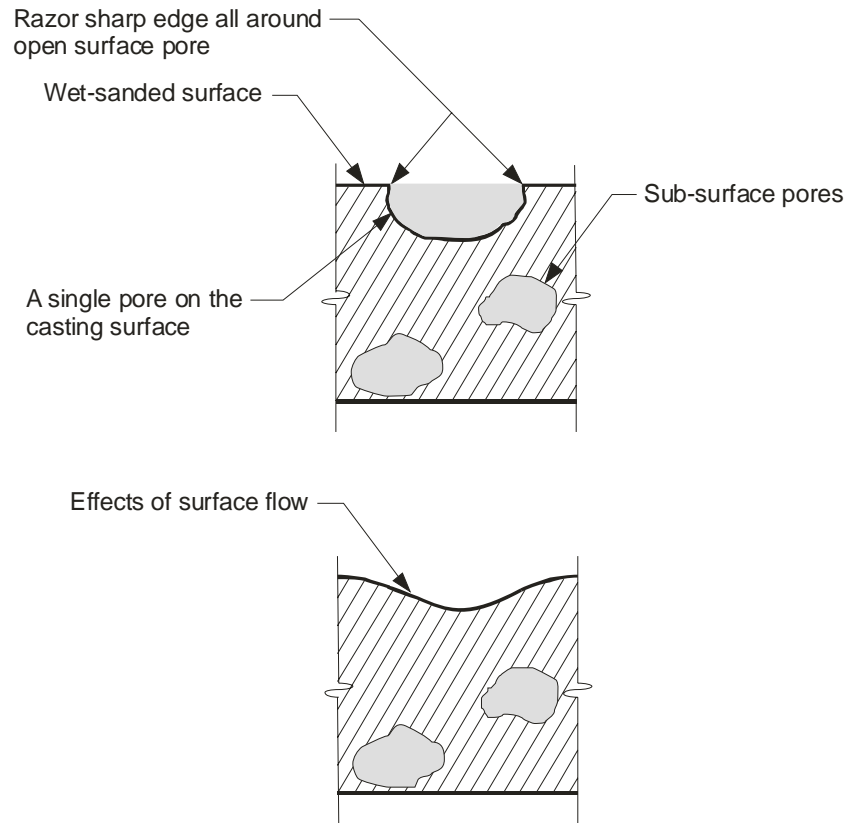

**Figure 30. Effects of Surface Flow**

Figure 30 is a “before and after” of sorts. The illustration at the top is how we started out. The lower illustration shows how the combination of heat and abrasive dynamics have moved surface material from one area of the work piece to another to help fill and “level” a lot of the pits. Some smaller pits will nearly disappear, dramatically improving surface reflectance. Larger pits that remain will be more visible because they will reflect in a slightly different direction. This is because the surface cannot be made mirror flat by building it up with material we don’t have. Nevertheless, even those areas contribute immensely to the overall luster because we have improved the ability of the surface to reflect more light closer to being in the same plane. I never said this was easy, but it looks to me we have a pretty darn good luster, particularly for a part that was never supposed to shine at onset. You owe me a beer.

## 6 DUST CONTROL

Here’s where you have to make a major decision. Without metal dust collection equipment similarly used by finishing shops, the mere polishing of a couple of little parts you can hold in the palm of your hand can wind up being an unbelievably big deal in terms of work area cleanup. Work area cleanup becomes a zillion times worse if you start polishing quite a few large parts that take hours and hours of polishing, buffing, loading buffs, and raking over and over. I’ll guarantee you that you’ll create the mother of all messes.

Go out there and look around your garage. If have no form of dust collection whatsoever, whatever is out there is going to wind up being covered in a layer of soot black, sticky dust that, in comparison, has a particle size that makes flour seem like gravel. Around the immediate work area will be larger particles of compound from loading buffs and raking. As I mentioned earlier, this stuff and the dust on the floor will stick to you like a magnet and will be all over your carpet in the house...big time. Believe me, this is not a normal garage mess you'd make when doing other stuff in your garage. Nothing I can think of even comes close. Besides that, you're going to wind up knowing the local carpet cleaning folks on a first name basis. Figure 31 shows a garage or shop without some form of dust collection.

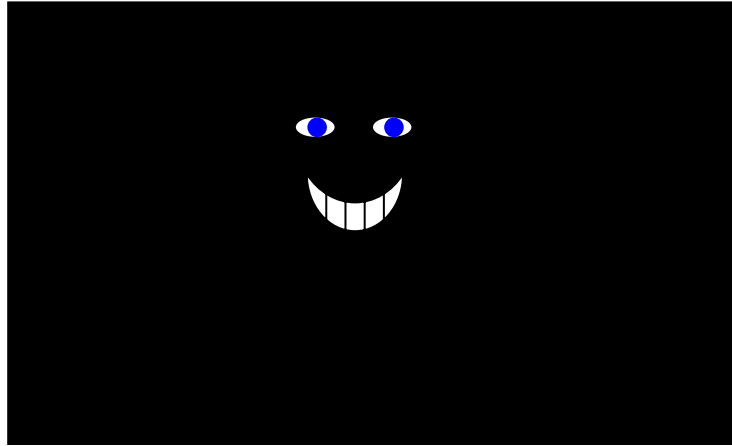

**Figure 31. Garage or Shop without Dust Collection**

Well, I guess you get the message. You'd better drum up something. The following sections offer some options.

## 6.1 Dust Control

Production shops have piped-in dust collection systems strong enough to suck a bowling ball off the floor, one reason being, it's an OSHA requirement in terms of respiratory hazards. On a garage or home shop basis, we don't normally have that kind of dust collection system, so this stuff is going to be tough to control. We have to try to confine as much of it as possible and capture it in other ways. Of course, we minimize respiratory hazards by wearing an appropriate dust mask. That's a "have-to." However, we would still have the mess.

Buffing stuff slings out like a pinwheel...like, imagine a water-soaked buff with the motor running. Larger particles pretty much spin off in the plane of the buff wheel, but the breeze stirred up by the same wheel pretty much disperses micro-fine buffing dust everywhere.

## 6.2 Homemade, El Cheapo Dust Collector

Don't snicker or slap your leg and point at this thing, because it works better than you'd think. You can do this with a pair of ordinary old box fans of about 20 x 20 inches, duct tape, and a pair of

furnace filters. Yeah, you'll have to find two fans; one won't cut the mustard. Cut a small notch in the filter for the power cord to exit and tape the filters to the intakes (the back side) of both fans. Of course, note the air flow direction arrows printed on the filters so you won't stick it on backwards and suck all the fiberglass filter fuzz into the fan blades. You'll want to use these cranked it up to their highest speed...the more powerful the box fans, the better.

No, it's not going to trap the truly small micron stuff. That's why you have to wear a dust mask, but you'll be shocked to see what it does trap. After all, house dust particles can be pretty darn small, too. I suggest using the cheap throw-away filters unless you want to mess with washable, reusable filters. You'd probably have a tough time washing all this stuff out, anyway. See Figure 32.



**Figure 32. El-Cheapo Box Fan Dust Collector**

When loading or raking a buff, larger compound particles will likely escape the comparatively wimpy draft of your box fan “dust collector” setup we’ll describe shortly. A little box fan is a long way from being as powerful as multi-horsepower, squirrel-cage blower type, dust collector. But, we can soup it up a little.

I was never one to leave well enough alone, even as a 15-year old, pink-nosed kid squeezing huge OHV V-8s into 30s and 40s model Fords. Yeah, I know what you’re thinking...and your right. If I was messing with old rods that far back, my driver’s license number must be in Roman numerals. At 14, after covertly milling a full .060 off the head of my Dad’s flat-head lawnmower on the shop end-mill at high school, disabling the governor, and disemboweling the muffler, I think we had the only ultra-high compression, combination rotary mower/hover craft in town that would ping on premium leaded gas at the rpm of a dentist drill. Thinking back, how those little underhead valves kept from smacking the head, I’ll never know. Of course, starting it required about the same pull on the rope as rope-starting a bull dozer in the dead of winter. Anyway, if it’s a rainy day and you have nothing constructive to do anyway, here’s how to soup up an ordinary box fan:

If it’s a relatively recent, el cheapo model, the grills on the intake and exhaust side are likely plastic. As the size of the individual plastic grill segments is many times wider and closer together than the

wire construction, they present a major air restriction. Consumer protection laws did that to keep little kiddos' fingers from getting into the fan blade. Depending on the brand, as much as 20% of both the intake and exhaust area is consumed by the comparatively wide segments of plastic. Oddly enough, upon removing the plastic grill from the intake and exhaust, the combined intake and exhaust area may be increased by as much as 40% with proportional increase in air flow. What's equally significant is that the turbulent air flow generated by the flat plastic segments of the grill is now replaced with a smoother, laminar flow that allows the blades to get a better bite. If you really go nuts here and it's a truly crummy, rainy day with nothing else pressing, you can kick it up still another notch. Take a piece of ordinary galvanized flashing used for roofing and run it around the inside of the box, fastening it with a sheet metal screw every 90° to form a shroud similar to the fan shroud on your car's radiator. This results in a better pulling axial fan and prevents reverse air flow in the corners of the square box due the air pressure differential between the front and backside of the fan blade. The pic to the right in Figure 32 shows the dragster version of this silly thing...complete with a drag pipe shroud. Compared to before, it will now flat suck up some polishing dust...well, for what it is.

Although the intake side is now covered with the filter...and nice and safe...the back side has the bare fan blade exposed. Of course, you can probably figure out what I was going to say next, but I'm not. Just keep any unwary toddlers away...that shouldn't be out there at onset. I doubt these size motors and plastic blades would really do adult fingers much harm, but it'd probably feel like a manicure with a ball peen hammer.

Okay, here's why you need two fans and why they need to be installed similar to Figure 33. If you use only one, I'll guarantee you, you'll only get half the mess and the other half is a nightmare. In this case, I'm presuming you have a regular vertical standing buffer motor stand.

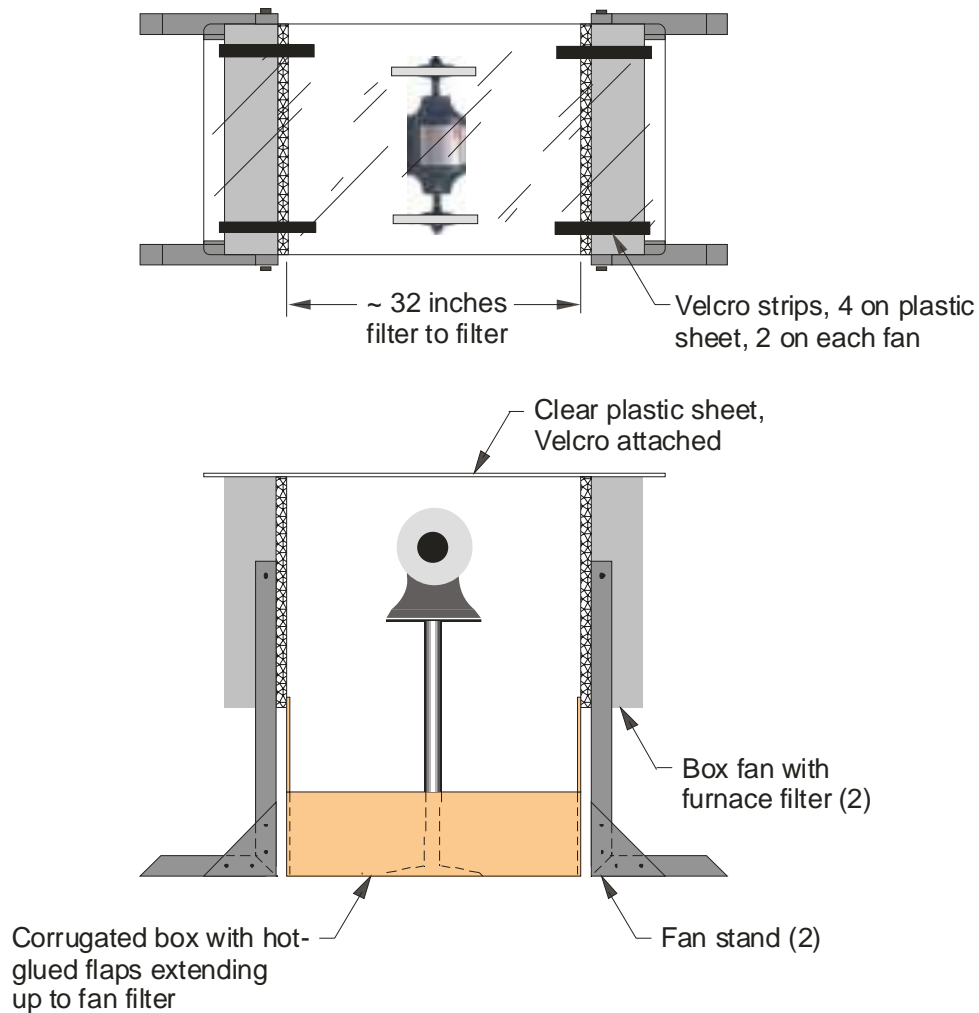

**Figure 33. Box Fan Dust Collection, Conventional Motor Stand**

Of course, you'll have to knock out a pair of stands to support the fans. You can do that with a little dab of wood like shown and a couple of cross braces. Use .093 or thicker, clear plastic sheet stock (Lexan or Plexiglas) across the tops of the fans as shown to deflect wayward stuff. I said, "Tops of the fans," but you really want to mount the fans in the stand sideways or upside down so the switch won't interfere with the clear plastic. The fan is square and it won't know the difference.

Clear plastic will prevent the dark shadow that an opaque material would cast on your work piece. Matter of fact, the top side of the plastic sheet is a good place to fasten a dual-lamp, fluorescent fixture flat down on the plastic, shining light through. If you fasten the fluorescent fixture in 3 or 4 places on each side with screw, flat washer, lock washer, nut, it will lend stiffening structural support to the plastic and keep it from bending like a hammock. Attach the clear plastic sheet to the fans with Velcro only so you can move them in and out to accommodate part size.

When polishing smaller parts, pull the fans in as close as possible, but so you'll still have just enough room to manipulate the part. To collect stuff that's thrown downward, you can go with a large box

and simply sit the buffer motor stand inside, or use a long, narrow box on each side. If you can't find a box the size you want, you can always cut and hot-glue one together. This Rube Goldberg deal will get the far majority of the mess that escapes the fan draft. The 32-inch dimension shown will give you enough room to polish about the largest Harley part you'll run into. For super large parts, simply pull the fans out as far as they can go and still be Velcro attached under the plastic sheet. Now, if you could get 4 more box fans... just kidding.

If you build my version of a buffer motor stand, this same home-made approach to dust collection might look something like Figure 34.

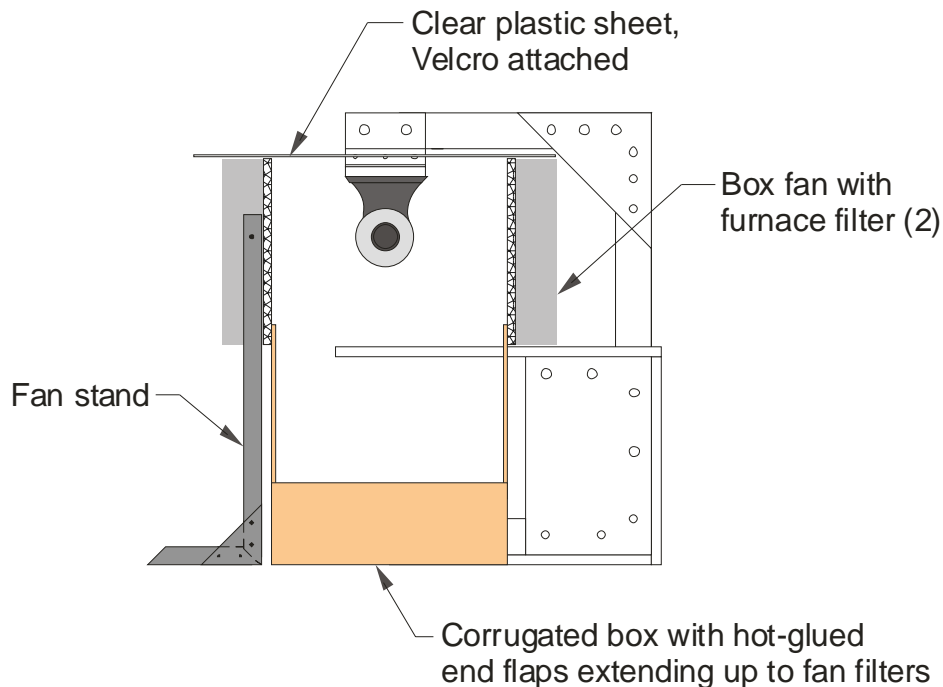

**Figure 34. Homemade Dust Collection**

This is the same stand shown back there in Figures 9 and 10. All I've done here is sit one fan on the ironing board-like work surface and mount the other on a stand on the opposite side. A box with hot-glued end flaps extending up to the filter captures any stuff thrown in that direction as well as catches anything thrown directly toward the floor that escapes both fans. Like before, Velcro is affixed to the top of the fan box and the underside of the plastic sheet so that that either fan can be moved to adjust for part size. Now, if you think all of this is overkill, just start polishing and buffing and you'll see what I mean. The mess you generate will have you looking for box fans real quick...or something.

If you're handy at fabricating stuff, a shield like shown in Figure 35 confines it better and cuts out messing with a larger sheet of clear plastic, the Velcro, and all that. I'm just throwing this up in the air so you can control this stuff one way or another. You can make a shield to control what comes off the top half of the buff by making a shield out of .093-inch thick Lexan or Plexiglas. Usually, you can buy it in small pieces at Home Depots, Lowes, etc. Don't use anything opaque or you'll cast a shadow on the work piece. I formed a piece using a pair of charcoal grill mittens while holding the thing in

front of one of those propane garage heaters that looks like a little rocket sitting on the floor. You could probably do something similar by holding it over a gas charcoal grill while bending it into the shape you want.



**Figure 35. Buffing Wheel Shield**

If you try to thermo-form a perfect semicircle, it'll not only drive you nuts, but you'll find the stuff won't cooperate and only wants to bend in the hottest spot. Anyway, I settled on the three bends you see in Figure 35. You have to get it pretty hot, so wear your outdoor grill mitts for this, cover your leg with a towel, and bend it over your leg. I got pretty sharp bends when bending it over my leg. They don't call me "chicken legs" for nothing. I intentionally left a lot of clearance between the buff and the shield in order to make changing buffs easier.

Many buffing motor mounts I've seen have 4 raised areas for feet at corners, raising the rest of the motor mount about 1/8-inch off the surface it's mounted. Using that small crack of a space, I slide a 1/8-inch thick x 1-inch wide piece of steel through that gap, letting it stick out the other side by the same amount to support a shield over the opposite arbor as well. On the Dayton motor in Figure 35, six #8 screws hold down the motor electrical access cover just under the base. Two of these screws were right in line with the steel strap. By drilling a couple of matching holes in the strap, those same two #8 fasteners also double to hold it in place as well as hold on the electrical access cover. A pair of #10 screws, nuts, flat washers, and lock washer hold the plastic sheet to the strap over both arbors.



If you're using a conventional, floor-mounted buffing motor stand, you could probably do about the same thing, except, bend the steel strap to make a "Z" bracket and screw it to a pair of strong stud finder magnets, and then stick them on the motor casing. Presuming your buffing wheel is in reasonable balance, it shouldn't vibrate at all. Mine didn't...rock solid, matter of fact. Go ahead and do the fan thing on each side of the buffing wheel as shown in prior figures.

### 6.3 Dust Collectors

Admittedly, you've got to get pretty darn serious about polishing and buffing to go this far, but you might have other stuff in your garage or shop that would benefit from a dust collector as well. Matter of fact, if you do much of this, you're going to wish you had bought one of these before you ever started.

Most dust collectors are made for industrial use, but there's a few in the right range for a garage. Lowes carries Delta brand dust collectors in the 500 to 600+ cfm range that have 30 micron bags. See Figure 36. The price on some of these ain't bad, either...not what you'd think.



Figure 36. Dust Collectors

Typical Delta brands that Lowe's carries are on the left and in the middle. The Sears Craftsman is the one on the right. Of course, you can buy all kinds, shapes, and sizes of intake fittings to adapt these to fit your particular buffing motor setup.

If you get one of these and later wind up missing your cat or Chihuahua, you might go out to the garage and kick the bag to see if anything in there moves. You can take a look at several models through the links below.

[http://www.deltawoodworking.com/catalog/default.asp?cat\\_id=4](http://www.deltawoodworking.com/catalog/default.asp?cat_id=4)

[http://www.newsales.com/wood/dust\\_collectors.htm](http://www.newsales.com/wood/dust_collectors.htm)

<http://www.northwestpowertools.com/dustcollectors/50820.htm>

## 7 Safety Precautions

The majority of us stay out of trouble by using good, common sense. Folks, the following sections aren't merely politically correct safety warnings intended to cover the idiots in this world. There's

stuff in here the best of us may not be aware. In other words, the following sections can't be shrugged off even if you have your head screwed on right. Follow these precautions or you'll sooner or later have a serious problem...it'll just be a matter of "when."

### **7.1.1 Hand Protection**

If you're polishing parts with sharp edges, you'd be wise to use leather shop gloves. The polishing edge of 6-inch buff on a 3450 rpm motor is hauling buns at over 5,400 linear feet per minute. If you fail to watch what you're doing every split second (you will definitely sooner or later screw up), one slip the wrong way and the buff can violently yank the part from your hand faster than you can blink. You can wind up with a nasty gash in addition to watching the part and a half a finger sail to the other end of your garage or shop at about mach 2. This is particularly true when using larger horsepower motors and higher speeds.

Smaller parts can get very hot, very quick from friction created by the buffing wheel...like near instantaneous. As a matter of fact, if you're polishing and buffing screw heads, the frictional heat can quickly brand a screw thread in your fingerprints before you can react. Well, this ain't super dangerous, but you'll be hopping around your garage blowing on the affected digits and screaming "Oh, shucks!" or "I'll declare!" Don't ask me how I know this, except I don't think I was screaming those exact words. You'll want leather shop gloves when doing little screw heads or hold them with a hand tool.

On larger parts, I use disposable vinyl gloves, changing them between cuts to avoid getting the grit of one compound that got on my hands, intermixed with the cut prior and hosing up my polishing. They are thin, but oddly enough, stuff is prone to slip and slid over the vinyl as opposed to snagging a hunk of skin. Obviously, don't expect to have major physical protection with thin, vinyl gloves.

### **7.1.2 Use a Dust Mask**

I hate to tell you this, but you're also going to have to wear an appropriate dust mask, even if you use some form of dust collection attached to your buffer motor. Before you shrug this one off, listen up! All compounds and the polishing and buffing process, itself, will produce a micro-fine, metallic and dried grease dust in the air that will collect on everything in the immediate area. If you don't see this stuff collecting around you...well, I guess the dust collector was you...you inhaled it all. Buffing dust particles suspended in your lungs in the presence of a spark or other ignition source can cause your upper torso to explode. Not really...just kidding. Wear an appropriate dust mask to prevent filling your lungs with metallic and dried grease particles. It's more than common sense...it's an absolute necessity.

### **7.1.3 Eye Protection**

Wear safety glasses or eye shields and always buff below the centerline of the wheel. Although these compounds are non-toxic, biodegradable, and all that, a high-speed particle slung into the eye can cause a pink-eye infection or major eye damage. I pulled this stunt. I took my glasses off for a split second and got hit in the eye with a high-speed compound particle when raking a buff. Had the mother of all pink-eye infections. Was the pits. Additionally, if the edge of a part gets snagged by the buffing wheel, you can catch it smack in the face. With safety glasses, at least you'll be able to see to pick your nose back up off the floor.

### 7.1.4 Around Buffer Motors

Buffer motors of the type seen in here have no guards...just a bare, exposed 3450 rpm wheel is hanging out there. Has to pretty much be that way or you couldn't polish and buff. If you let a loose garment or that chain hanging around your neck with a big chrome skull it get caught in the wheel and motor shaft, you're going high-speed kiss the motor and get bent into the shape of a pretzel in the process. I haven't done that one yet, but I inadvertently had a large shop rag give me a demo. At any rate, keep any loose clothing away from the buff, take off any jewelry, and if you polish your nose ring, take it out of your nose, first.

## 8 SEALING

If all the preceding was done right, we now have a bunch of Harley aluminum parts that are polished to a true chrome-like, mirror luster a notch beyond the best and you have the nastiest garage on the planet, depending on your dust control. Before we bolt these glamour goodies back on the bike or bare engine, we have one last step. Don't worry, it's a quick one and you won't even break a sweat.

This last step is going to assure the polished parts retain their mirror luster for the longest possible time between intervals of periodic shine maintenance. The only way to do this is to prolong the tendency for natural oxidation to occur in the time element it normally and inevitably will happen. Actually, polished parts are far less susceptible to oxidation because polishing and buffing to a mirror luster results in a surface with far less porosity and a much closer-knit molecular structure. Actually, I just made that up, but it sounds good. Not really, it's an actual fact.

An effective sealant can retard oxidation many times past the time when unsealed surfaces would normally be showing the dulling effects of natural oxidation. Don't get your panties in a wad, we're not talking the dreaded clearcoat, here...this is a surface treatment. One reason most sealants haven't been effective on Harley parts is because of their inability to function at higher temperatures, for instance, rocker covers. The sealers and the so-called residual protection left from polishes usually out-gasses as soon as the part heats up...and, poof...it's gone. Some even leave a slight discoloration.

Alcoa introduced a sealant developed specifically for bare aluminum, uncoated parts. I know what you're thinking...“It won't work under the heat of a rocker cover.” Got news. This particular sealant was originally developed for the huge, 18-wheeler size, bare (not clearcoated) aluminum alloy glamour wheels on big rigs that travel all over the country in various environments...like salted streets, coastal areas, etc. Atmospheric salts are the natural environmental catalyst that causes aluminum oxidation at onset. This same sealant will also withstand extremely high temperatures.

You may not have thought of this, but when commercial trucks are hard braking, particularly down long, mountain grades, enormous heat is conducted into the wheels. Heat generated by brake components of big rigs can exceed 1000° F. Some of it is conducted out through the wheels like a heat sink. Of course, the wheels get screaming hot, but they don't get that hot because that's in the melting temperature range for aluminum alloys. Nevertheless, they can get hotter than any Harley rocker cover. Coincidence or whatever, the same stuff Alcoa intended for big truck wheels is ideal for hot Harley parts. Again, the Alcoa Sealant is not a clearcoat. It's a surface treatment. It's also invisible to the naked eye and does not alter the mirror luster of highly polished parts. It's merely sprayed on the

aluminum part, allowed to dry for 5 minutes, rinsed thoroughly with cool water, and then dried with a soft cloth. By the way, the thorough rinsing is an important part of the sealing process. See Figure 37.



**Figure 37. Alcoa Bare Aluminum Sealant**

With the cap on, the package may look like an ordinary aerosol. Well, it's not. It's more like a miniature compressed gas cylinder. Oddly enough, you can buy this stuff straight from Alcoa at:

[http://www.alcoawheelaccessories.com/store/control/category;jrunsessionid=1085211010859204385?category\\_id=alucare](http://www.alcoawheelaccessories.com/store/control/category;jrunsessionid=1085211010859204385?category_id=alucare)

### **WARNING!**

The Alcoa Sealant is not only flammable, but extremely flammable! It should not be used in the proximity of a flame or spark, including a gas water heater closet in a garage. Safety warnings on the can must be followed to the letter as this material is also a severe eye, skin, and respiratory tract irritant. Of course, those are the same potent ingredients that allow the product to do what it does. Alcoa promises the sealant to retard the dulling effects of oxidation 6 times longer than untreated, polished surfaces. Like any industrial-strength material, use with great caution and follow directions on the container to the letter! Whatever you do, keep this stuff somewhere...anywhere...where there's no possibility whatsoever that a little kiddo or someone not understanding what it is could come in contact with it!

## **9 MAINTENANCE OF POLISHED SURFACES**

If you do the periodic maintenance stuff correctly, you can keep it down to twice a year at worst case...well, presuming you want to keep that mirror shine you worked your butt off under a buffing wheel to get. Twice a year or so just isn't all that bad and this is pretty quick. There are crappy weather days you won't ride, anyway. Periodic shine maintenance involves 4 steps:

- Deoxidizing and cleaning
- Scratch removal

- Restoring to original mirror finish
- Sealing

## 9.1 Deoxidizing and Cleaning

Eventually, with enough time, the luster of any bare aluminum, polished surface exposed to the atmosphere of planet earth will begin to slightly dull. It all depends on how long overdue you are for a fresh shine. If you're one of these picky dudes that keeps your bike always looking its best, a gentle application of Mother's polish is quick and easy. However, if you've let it get out of hand, you might have to resort to a combination cleaner/deoxidizer. Here's one that removes both road grime and oxidation without harming the base metal. Alcoa calls it, "Cleaner"...catchy name, huh? Wonder how many meetings it took marketing to brainstorm that one up. You can buy the stuff directly from Alcoa off their web page or find it in an auto parts store:

[http://www.alcoawheelaccessories.com/store/control/category;jrunsessionid=1085211010859204385?category\\_id=alucare](http://www.alcoawheelaccessories.com/store/control/category;jrunsessionid=1085211010859204385?category_id=alucare)

One reason I'm emphasizing this stuff is because some folks put concoctions on their engine that simply doesn't work or is not designed for bare aluminum, but chrome or clearcoated surfaces. In fiddling with bikes, I see more of that than you'd think. To give you an idea of what the wrong stuff does, here's a recent patient shown in Figure 38...a cam cover from a 2000 model, 1200cc Sportster.



**Figure 38. Using Cleaners Not Compatible with Bare Aluminum Alloys**

That's a mess, ain't it?...and this is after it's thoroughly cleaned! The discoloration that dribbled down the cam cover is actually chemically etched into the surface. It's permanent. The only way to fix it, is to remove the part from the bike and cut it down on a buff with an aggressive polishing compound. You can then either attempt to match the stock, semi-shine or take it all the way to a mirror luster. Of course, if you're going for a mirror luster and want all parts to match, you'll have to remove all other castings and polish them as well. In case you're wondering what that is in the ignition area, that's

newspaper I crammed in there before masking off to keep polishing dust out during polishing. Anyway, the right type of stuff to use is shown in Figure 39.



**Figure 39. Cleaner Compatible for Bare Aluminum Alloys**

That spray bottle looks like a regular spray bottle, but it's not. That thing has a push-button locking nozzle for a good reason and the wall thickness of the container is extra thick for another good reason. The stuff can be dangerous if not used properly.

Use the Cleaner exactly as stated by the directions on the container. Spray it on and let it work for 15-20 minutes. Don't let it dry out! Keep it wetted out during the entire 15-20 minutes. Then, rinse the part thoroughly with cool water and let it air dry. A leaf blower makes a good dryer. If the parts are on a bike that's been in salt air a lot or hasn't been maintained, you might have a thicker than usual layer of oxidation and need to repeat the process. Make sure the parts you're spraying aren't hot. The hot surfaces will cause fumes and you darn sure don't want to breathe the slightest sniff of this stuff. Surfaces must be cool to the touch.

### **WARNING!**

Read the entire label on the backside of the Alcoa Cleaner container before you even as much as think about using this stuff. It's potent! It's far from being a docile cleaner you'd find under someone's kitchen sink. You don't want it on your skin (can cause burns) and you darn sure don't want it in your eyes (can cause corneal damage). Use eye protection and avoid skin contact! Whatever you do, store this stuff where there's no chance of a kiddo grabbing it, or for that matter, anyone else that might not know what it is and how it's safely used.

## **9.2 Scratches and other Blemishes**

Well, we've got a prob, here. The parts are on the bike. It's not all that bad and this is a perfect thing to do in the garage on a rainy day. Remember those little 1/4-inch shank-mounted buffs I stuck in there way back in Tables 4 and 5? Here's their time to rise and shine. Those little dudes will make pulling out any micro-scratches or similar blemishes a snap. See Figure 40.

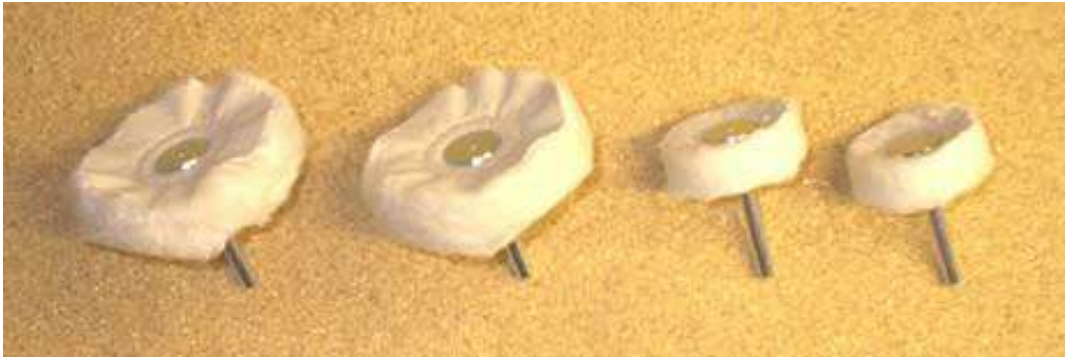

**Figure 40. Shank-mounted Buffs**

These are loose sewn cotton buffs. They might look rather squooshy, but centrifugal force holds the plies out there rather rigidly, particularly if running at a pretty good rpm. However, as your part is on the bike, it can't be more ideally manipulated under a buff as it could off the bike. However, these little dudes will mush buff over irregular features and get about every nook and cranny. They will chuck up on a 1/4-inch high-speed drill, but if you have a 1/4-inch rotary tool or a flex shaft that will run at a higher rpm, they work even better.

I shouldn't need to tell you much, here. You have all the compounds, so based on the severity of any damage, just pick the appropriate compounds from what we've learned and have at it. Using the same methods we used to get there at onset, you can take it back to its original mirror luster.

**IMPORTANT:** Same as before, don't use the same buff with different compounds! Mark them with a felt tip marker or something to correlate the compound with that particular buff. Finish up with the white rouge, then the red or pink, and you now have the original mirror luster completely restored. Give these little guys a gentle rake to fluff them back up before retiring them.

As before, clean off any compound that may have caught on fasteners or depressions exactly as we did when buffing with the part removed, and dry with a fresh, soft cloth. If you use a soft cloth, make sure there's no foreign material in the cloth that will scratch.

### 9.3 Sealing the Finish

Here, you simply repeat the same sealing process you used before you put the parts back on the bike. See Section 8. After sealing, you should now be okay for about 6 months, maybe more before you need to do a little shine maintenance. Not that it hurts anything, but I'd throw a cloth over the engine to shield anything you don't want to come in contact with the sealer.

## 10 Harley Aluminum and other Precious Metals

Precious metals include gold, silver, platinum, and old Harley aluminum. If you have any doubts about that metallurgical classification, just feast your eyeballs on Figure 41. We're revisiting Doug's self-designed and built-from-scratch custom vintage chopper featured on the front cover.





**Figure 41. 1964 Sportster Engine (bike featured on the cover)**

Dang! I love those old bikes!...the days of magnetos and kickers!...the latter explaining why some walked with a slight limp and others had their upper teeth marks in their right kneecap. Well, back in my days of the 50's, anyway.

Wow!...and that's a 38-year old Harley engine at the time of publication. Today, it's literally put together better than new. Of course, Doug is a master builder. Truly remarkable...and anything less than polishing to a mirror luster just wouldn't do it justice. My kinda hog. Thanks for use of the pic, Doug!

## **10.1 Something that Chaps my Butt**

Speaking of aluminum alloys, you ever hear these 3<sup>rd</sup> party makers of Harley performance stuff brag that their product is made from "aircraft aluminum"?...like it was Kryptonite from the same planet as Superman? Actually, there ain't no such thing as "aircraft aluminum." It's aluminum alloy. Although in engineering circles, we'll slangly use the word "aluminum" as well, it's used knowing full well that



the word “aluminum” used alone actually refers to pure aluminum, known as the “1100” series. Anything else that requires the least bit of structural integrity is aluminum alloy. A beer or soft drink can is close to 1100 pure aluminum. I believe if I was trying to make folks think I knew my metal properties, I’d at least call it by the name it’s referred to in technical terms in the event some aren’t naïve on the subject.

A popularly used aircraft aluminum alloy is 2024 sheet stocks. It has good ductility, cold works to pick up strength in areas where it’s formed, and is commonly used for stringers and beltframes in the fuselage, ribs in the wings, etc. It has numerous other roll-formed and die-formed applications to create numerous structural components throughout an aircraft’s primary and secondary structure. It’s an all-around, strong, structural material. Unfortunately, it’s not corrosive resistant worth a flip and must be Alodined (trade name for a chromate conversion), then primed and sealed with a zinc chromate primer. However, the material is not ideal for about any part of a motorcycle, although it’s “aircraft aluminum.”

There is an aluminum alloy used in ordinary household and consumer items that has numerous other properties exceeding that of 2024...not structural, but other areas such as weldability, heat treatability, and superb corrosion resistance. It’s the 6061 series, which is also found in aircraft for dozens of avionics chassis designs and numerous other electrical/electronic, and similar non-structural applications, yet it’s pretty darn strong. You can also find this alloy elsewhere in all types of aircraft. It’s just plain, ordinary, commonly used stuff, yet it’s also “aircraft aluminum.”

Another popular aluminum alloy for aircraft use is highly machinable 7075 plate stocks. As an example, 7075-T6511 (the latter number being the temper designation) is the thick, machined plate bolted to the cargo tie down points on the floor beams and intercostals in the C-130 gunship series to mount 20 and 40mm cannons, etc. It has numerous uses, including hydraulic components.

Any Joe Blow can trot down to the local metals distributor and buy all the “aircraft aluminum” they want. Whoopy. So much for rare, exotic “aircraft aluminum.” My point is, whether it’s a material also consumed by the aircraft industry, you always use the aluminum alloy appropriate for the application.

Did you guys see the Jesse James thing on the Discovery Channel?...yunno... where Jesse took off to Sturgis powered by his 3<sup>rd</sup> party monster V-twin, got about half-way there and blew a head off? You see that? Wow! A brand spanking new engine! Anyway, here old Jesse is in a parking lot doing major surgery and having to drill out holes, tap threads, and install thread inserts. I was sitting there marveling at all that...wondering how in the world some self-anointed engineer and copy cat V-twin manufacturer hosed it up. The factory apparently didn’t allow for the correct edge distance on the untapped hole or had insufficient thread depth...maybe tapped sloppy threads, or just didn’t get a grip on the fact that a thread insert might be required to accommodate the function of the fastener. I guess that little scenario didn’t put their so-called “aircraft aluminum” in good light, did it? Bottom line...if it’s not designed correctly at onset, it doesn’t make much difference what material you use.

Keep it vertical and ride safe,

Nodawgs

(Unintentionally left blank)