

Pool Copings



14 unique aesthetic options

TECHO — BLOC

Pacific



Chestnut Brown



Champlain Grey



Shale Grey

Champlain Grey

Cap

Depth: 11 $\frac{13}{16}$ in 300 mm

1 $\frac{3}{16}$ x 3 $\frac{15}{16}$
30 x 100





Travertina Raw & Bali Travertina Raw



Travertina Raw in Ivory



Bali Travertina Raw in Ivory



Rock Garden Brown

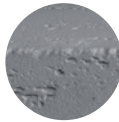

Riviera



Ivory



Rock Garden Brown



Riviera



Ivory

12" x 30"
Depth: 11 3/4 in 298 mm

14" x 28"
Depth: 14 in 356 mm

Depth: 12 in 305 mm

2 1/4 x 30
57 x 762

2 1/4 x 28
57 x 711

2 1/4 x 2 3/4 x 16
57 x 70 x 406



Cap

Bullnose



Chocolate Brown



Chestnut Brown



Sandlewood



Champlain Grey

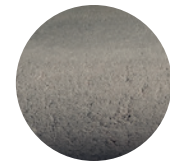

Shale Grey

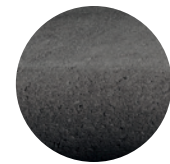

Onyx Black

Onyx Black

Depth: 12 in 305 mm

$2\frac{3}{8} \times 5\frac{7}{8}$
60 x 150





Bullnose Grande

Beige Cream



Greyed Nickel

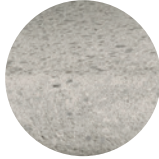

Greyed Nickel

Depth: 12 in 305 mm

2 1/4 x 2 3/4 x 16
57 x 70 x 406



Piedimonte



Rock Garden Brown

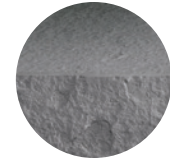

Riviera

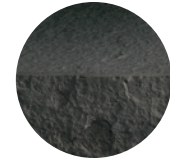

Onyx Black

Riviera

12" x 30" ———
Depth: 11 3/4 in 298 mm

14" x 30" ———
Depth: 14 in 356 mm

28" x 28" ———
Depth: 28 in 711 mm

2 1/4 x 30
57 x 762

2 1/4 x 30
57 x 762

2 7/8 x 28
73 x 711





Portofino

Chocolate Brown

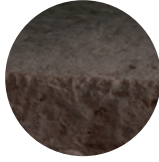

Rock Garden Brown



Baja Beige



Riviera

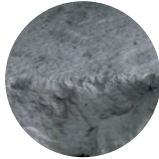

Azzurro

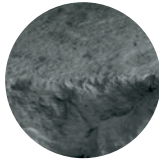

Onyx Black

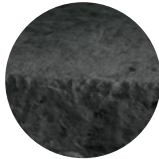

Baja Beige

Various sizes

Depth: 14 1/2 in 368 mm

2 1/4 x 11 3/4 x 9 3/8
57 x 298 x 238

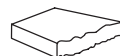

2 1/4 x 15 7/8 x 13 3/4
57 x 403 x 349



2 1/4 x 18 13/16 x 16 1/2
57 x 478 x 419



2 1/4 x 19 x 19
57 x 483 x 483



Raffinato



Chestnut Brown



Sandlewood



Beige Cream



Champlain Grey



Greyed Nickel

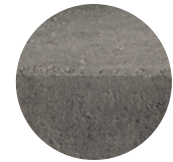

Shale Grey

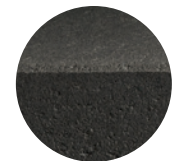

Onyx Black

Onyx Black

60 mm
Depth: 14 in 356 mm

$2 \frac{3}{8} \times 28$
60 x 711



90 mm
Depth: 14 in 356 mm

$3 \frac{3}{16} \times 28$
90 x 711





York

Chocolate Brown

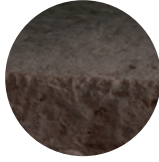

Rock Garden Brown



Baja Beige



Riviera

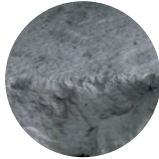

Onyx Black

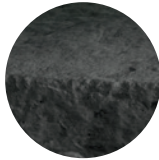

Riviera

16", 32" & 48"
Depth: 14 in 356 mm

Wall Cap 14x48"
Depth: 14 in 356 mm

2 1/4 x 16
57 x 406

2 1/4 x 32
57 x 813

2 1/4 x 48
57 x 1 219

2 1/4 x 48
57 x 1 219



Compatibility Chart

They say good design is found at the core, but great design is in the details. Techo-Bloc caps and pool copings are the finishing touch to any landscape project. Offered in a large array of colors, finishes and shapes, each cap serves many purposes and matches Techo-Bloc's collection of slabs and decorative walls to complete an outdoor project. See the Compatibility Chart to see which caps best fit your application.

	Bali Travertina Raw	Bullnose	Bullnose Grande	Pacific	Piedimonte 12" x 30"	Piedimonte 14" x 30"	Piedimonte 28" x 28"	Portofino	Raffinato 60 mm	Raffinato 90 mm	Travertina Raw 12" x 30"	Travertina Raw 14" x 28"	York wall caps 16", 32", 48"
Step		x	x		x	x		x	x	x	x	x	x
Concrete & step overlay system				x									
Pool coping	x	x	x	x	x	x		x	x	x	x	x	x
Wall single-sided		x	x	x	x	x		x	x	x	x	x	x
Wall double-sided					x	x		x	x	x	x	x	x
Counter top						x							x
Pillar								x	x			x	

Pool coping installation (on concrete base)

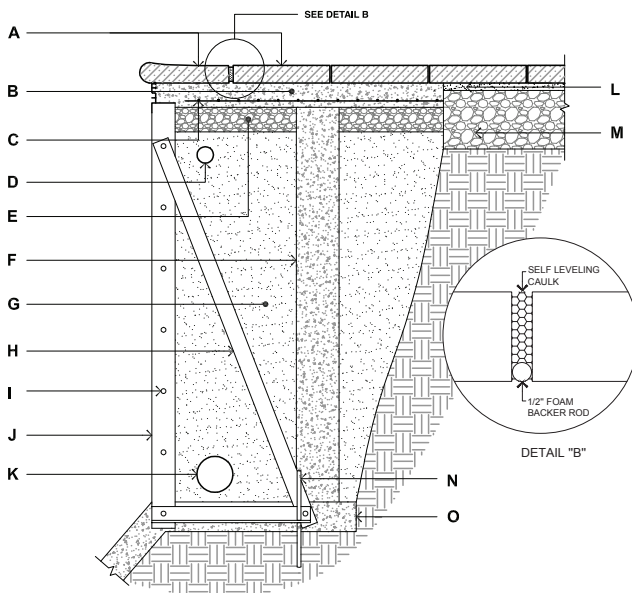

- A. TECO-BLOC POOL COPING AND PAVER SECURED TO CONCRETE SLAB WITH ADHESIVE OR MORTAR
- B. CONCRETE DECK 39" (1 m) WIDE BY 4" (100 mm) THICK MIN.
- C. WELDED WIRE MESH, 6 X 6 - W1.4/W1.4 (152 X 152 MW9.1 X MW9.1)
- D. POOL PLUMBING PIPING
- E. CLEAN STONE 3/4" (20 mm), 2" (50 mm) THICK MIN.
- F. CONCRETE PILLAR, 6" (150 mm) DIAM.
- G. SAND BACKFILL
- H. STRUT
- I. POOL PANEL
- J. POOL LINER
- K. PERFORATED DRAIN, 4" (100 mm) DIAM. WRAPPED WITH A GEOTEXTILE
- L. BEDDING COURSE, 1" (25 mm)
- M. COMPACTED GRANULAR BASE 0-3/4" (0-20 mm)
- N. STEEL ROD 3/8" (10 mm) ANCHORED TO SUBGRADE
- O. CONCRETE FOOTING, 4" (100 mm) THICK MIN.

Pacific Pool coping installation

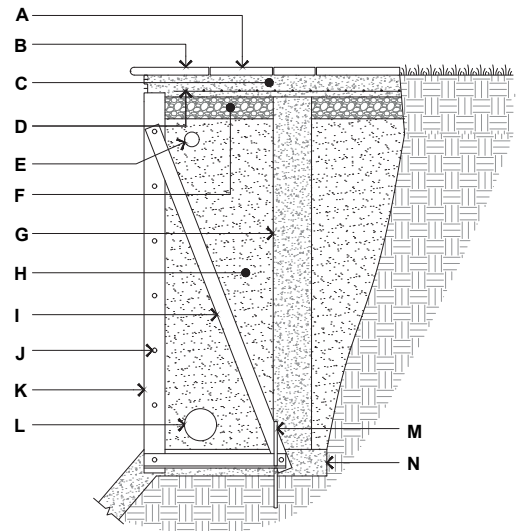

- A. TECO-BLOC PACIFIC SLAB
- B. TECO-BLOC PACIFIC CAP
- C. CONCRETE DECK 39" (1 m) WIDE BY 4" (100 mm) THICK MIN.
- D. WELDED WIRE MESH, 6X6-W1.4/W1.4 (152 X 152 MW9.1 X MW9.1)
- E. POOL PLUMBING PIPING
- F. CLEAN STONE 3/4" (20 mm), 2" (50 mm) THICK MIN.
- G. CONCRETE PILLAR, 6" (150 mm) DIAM.
- H. SAND BACKFILL
- I. STRUT
- J. POOL PANEL
- K. POOL LINER
- L. PERFORATED DRAIN, 4" (100 mm) DIAM.
- M. STEEL ROD 3/8" (10 mm) ANCHORED TO SUBGRADE
- N. CONCRETE FOOTING, 4" (100 mm) THICK MIN.

Pool coping installation (on permeable base)

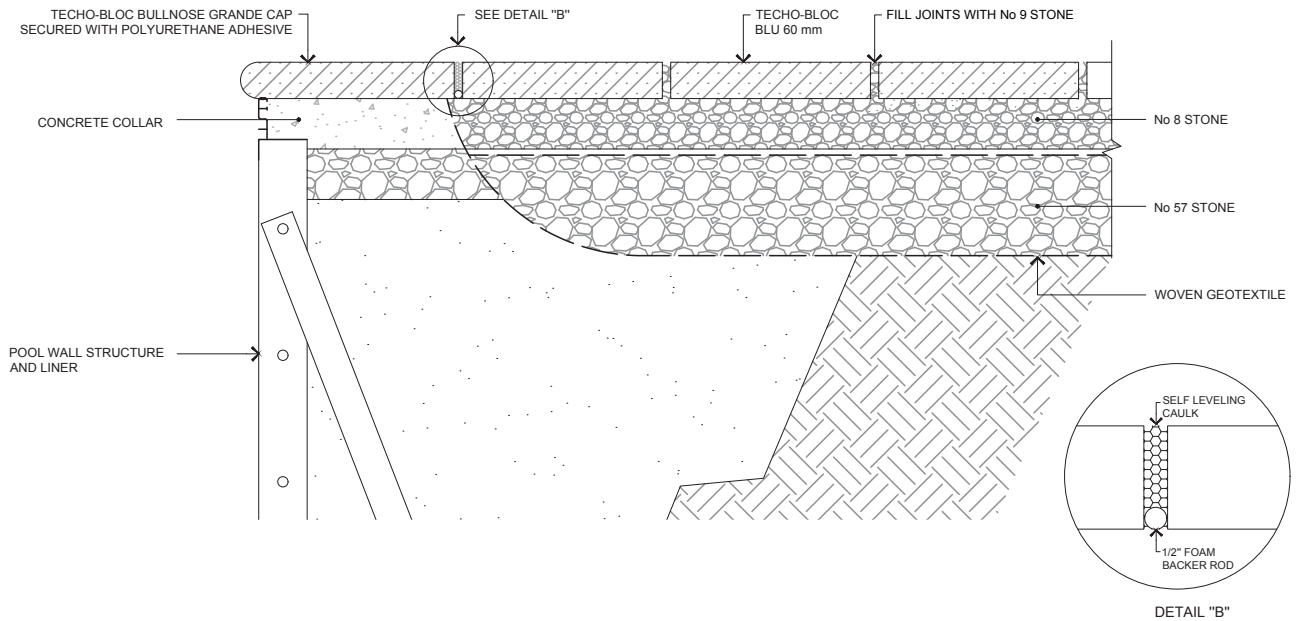

Pool cover anchor installation

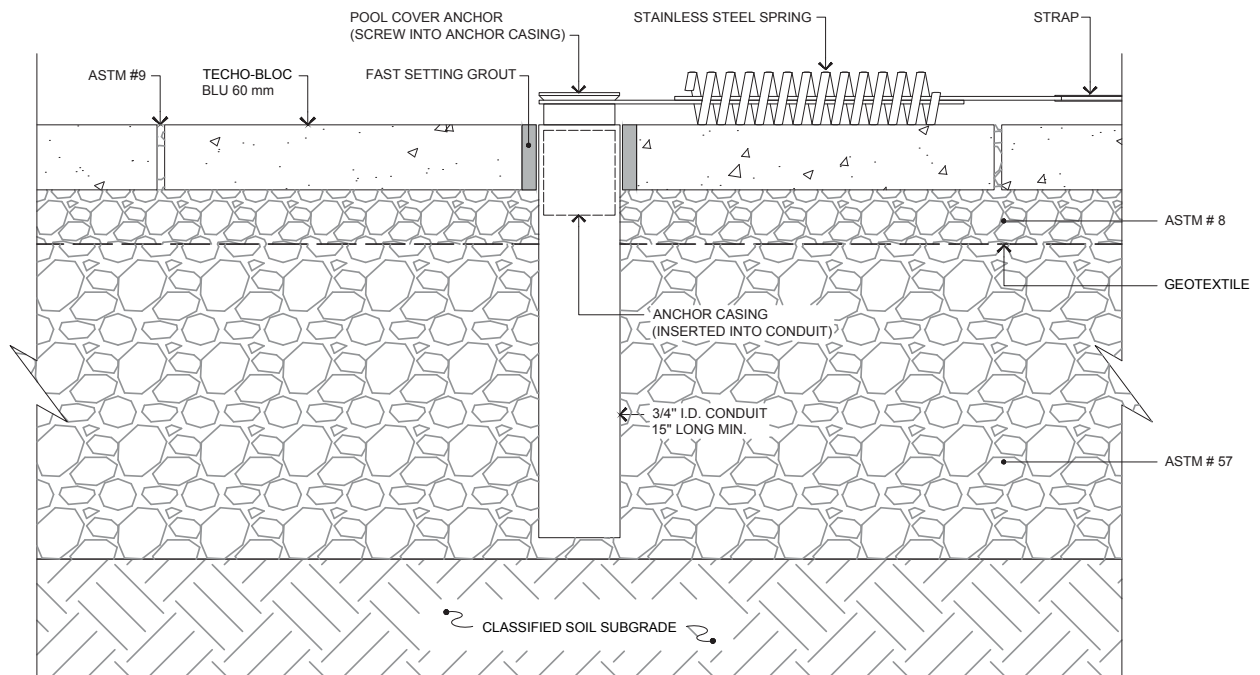

LEGEND

T TECHO-BLOC COLLECTION PRODUCTS

S STONEDGE COLLECTION PRODUCTS

 SALINE POOL CERTIFIED

 DE-ICING RESISTANT

 DO NOT USE DE-ICING RESISTANT

For an authentic look, each color option is composed of a variety of darker & lighter tones. Natural ingredients are present within the recipe to allow for a range in tones, veining and textures from one stone to another. Color samples for reference only. Actual product colors may vary.

CANADA

MONTREAL

5255 Albert-Millichamp Street,
Saint-Hubert, QC J3Y 8Z8

CHAMBLY

7800 Samuel-Hatt Street
Chambly, QC J3L 6W4

OTTAWA

3455 Hawthorne Road,
Ottawa, ON K1G 4G2

TORONTO

10 Freshway Drive,
Vaughan, ON L4K 1S3

TORONTO

1050 Industrial Road,
Ayr, ON N0B 1E0

USA

ILLINOIS

8201, 31st Street West,
Rock Island, IL 61201

ILLINOIS

24312 W. Riverside Dr,
Channahon, IL 60410

INDIANA

2397 County Road 27,
Waterloo, IN 46793

MARYLAND

6710 Binder Lane
Elkridge, MD 21075

MASSACHUSETTS

70 East Brookfield Rd.,
North Brookfield, MA 01535

MINNESOTA

4372 170th Street West
Farmington, MN 55024

NEW YORK

55-65 South 4th Street,
Bay Shore, NY 11706

NORTH CAROLINA

5135 Surrent Drive,
Archdale, NC 27263

OHIO

97 Industrial Street,
Rittman, OH 44270

PENNSYLVANIA

852 W. Pennsylvania Avenue,
Pen Argyl, PA 18072

PENNSYLVANIA

23 Quarry Road,
Douglassville, PA 19518

CONTACT US

TOLL FREE:

1.877.832.4625

WWW.TECHO-BLOC.COM

PROUD MEMBER OF



TECHO — BLOC

INSPIRING ARTSCAPES

