

powermax1250[®]

Plasma Arc Cutting System

***Service Manual
803940 – Revision 4***

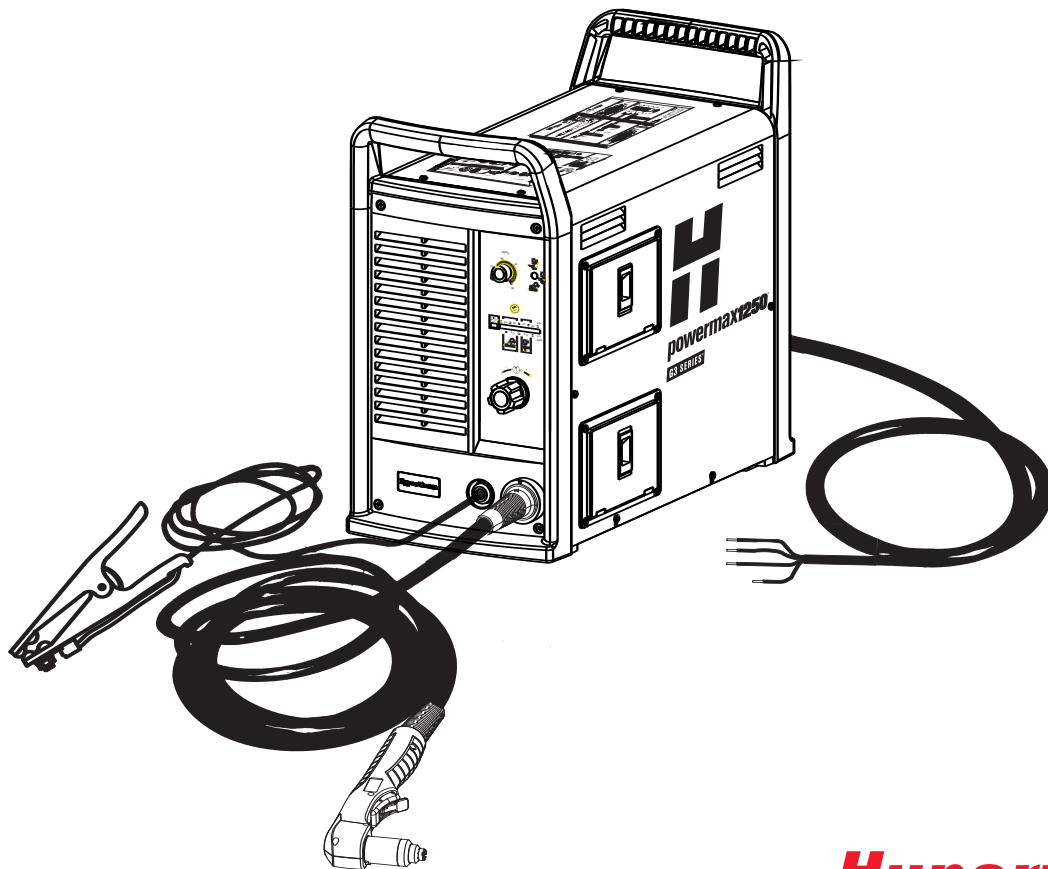

Hypertherm[®]

*The world leader in
plasma cutting technology™*

powermax1250

Service Manual

(P/N 803940)

Revision 4 – July 2006

**Hypertherm, Inc.
Hanover, NH USA**

www.hypertherm.com

**© Copyright 2006 Hypertherm, Inc.
All Rights Reserved**

**Hypertherm and Powermax are trademarks of Hypertherm, Inc.
and may be registered in the United States and/or other countries.**

Hypertherm, Inc.

Etna Road, P.O. Box 5010
Hanover, NH 03755 USA
603-643-3441 Tel (Main Office)
603-643-5352 Fax (All Departments)
info@hypertherm.com (Main Office Email)
800-643-9878 Tel (Technical Service)
technical.service@hypertherm.com (Technical Service Email)
800-737-2978 Tel (Customer Service)
customer.service@hypertherm.com (Customer Service Email)

Hypertherm Automation

5 Technology Drive, Suite 300
West Lebanon, NH 03784 USA
603-298-7970 Tel
603-298-7977 Fax

Hypertherm Plasmatechnik, GmbH

Technologiepark Hanau
Rodenbacher Chaussee 6
D-63457 Hanau-Wolfgang, Deutschland
49 6181 58 2100 Tel
49 6181 58 2134 Fax
49 6181 58 2123 (Technical Service)

Hypertherm (S) Pte Ltd.

No. 19 Kaki Bukit Road 2
K.B. Warehouse Complex
Singapore 417847, Republic of Singapore
65 6 841 2489 Tel
65 6 841 2490 Fax
65 6 841 2489 (Technical Service)

Hypertherm (Shanghai) Trading Co., Ltd.

Unit 1308-09, Careri Building
432 West Huai Hai Road
Shanghai, 200052
PR China
86-21 5258 3330/1 Tel
86-21 5258 3332 Fax

Hypertherm

Branch of Hypertherm, UK, UC
PO Box 244
Wigan, Lancashire, England WN8 7WU
00 800 3324 9737 Tel
00 800 4973 7329 Fax
00 800 4973 7843 (Technical Service)

France (Representative office)

15 Impasse des Rosiers
95610 Eragny, France
00 800 3324 9737 Tel
00 800 4973 7329 Fax

Hypertherm S.r.l.

Via Torino 2
20123 Milano, Italia
39 02 725 46 312 Tel
39 02 725 46 400 Fax
39 02 725 46 314 (Technical Service)

Hypertherm Europe B.V.

Vaartveld 9
4704 SE Roosendaal, Nederland
31 165 596907 Tel
31 165 596901 Fax
31 165 596908 Tel (Marketing)
31 165 596900 Tel (Technical Service)
00 800 49 73 7843 Tel (Technical Service)

Japan (Representative office)

801 Samty Will Building
2-40 Miyahara 1-Chome,
Yodogawa-ku, Osaka
532-0003, Japan
81 6 6170 2020 Tel
81 6 6170 2015 Fax

HYPERTHERM BRASIL LTDA.

Rua Jati, 33
CEP 07180-140 Cumbica
Guarulhos, SP - Brasil
55 11 6482 1087 Tel
55 11 6482 0591 Fax

EMC INTRODUCTION

Hypertherm's CE-marked equipment is built in compliance with standard EN50199. The equipment should be installed and used in accordance with the information below to achieve electromagnetic compatibility.

The limits required by EN50199 may not be adequate to completely eliminate interference when the affected equipment is in close proximity or has a high degree of sensitivity. In such cases it may be necessary to use other measures to further reduce interference.

This plasma equipment is designed for use only in an industrial environment.

INSTALLATION AND USE

The user is responsible for installing and using the plasma equipment according to the manufacturer's instructions. If electromagnetic disturbances are detected then it shall be the responsibility of the user to resolve the situation with the technical assistance of the manufacturer. In some cases this remedial action may be as simple as earthing the cutting circuit, see *Earthing of Workpiece*. In other cases it could involve constructing an electromagnetic screen enclosing the power source and the work complete with associated input filters. In all cases electromagnetic disturbances must be reduced to the point where they are no longer troublesome.

ASSESSMENT OF AREA

Before installing the equipment the user shall make an assessment of potential electromagnetic problems in the surrounding area. The following shall be taken into account:

- a. Other supply cables, control cables, signalling and telephone cables; above, below and adjacent to the cutting equipment.
- b. Radio and television transmitters and receivers.
- c. Computer and other control equipment.
- d. Safety critical equipment, for example guarding of industrial equipment.
- e. Health of the people around, for example the use of pacemakers and hearing aids.
- f. Equipment used for calibration or measurement.
- g. Immunity of other equipment in the environment. User shall ensure that other equipment being used in the environment is compatible. This may require additional protection measures.
- h. Time of day that cutting or other activities are to be carried out.

The size of the surrounding area to be considered will depend on the structure of the building and other activities that are taking place. The surrounding area may extend beyond the boundaries of the premises.

METHODS OF REDUCING EMISSIONS

Mains Supply

Cutting equipment must be connected to the mains supply according to the manufacturer's recommendations. If interference occurs, it may be necessary to take additional precautions such as filtering of the mains supply. Consideration should be given to shielding the supply cable of permanently installed cutting equipment, in metallic conduit or equivalent. Shielding should be electrically continuous throughout its length. The shielding should be connected to the cutting mains supply so that good electrical contact is maintained between the conduit and the cutting power source enclosure.

Maintenance of Cutting Equipment

The cutting equipment must be routinely maintained according to the manufacturer's recommendations. All access and service doors and covers should be closed and properly fastened when the cutting equipment is in operation. The cutting equipment should not be modified in any way except for those changes and adjustments covered in the manufacturer's instructions. In particular, the spark gaps of arc striking and stabilizing devices should be adjusted and maintained according to the manufacturer's recommendations.

Cutting Cables

The cutting cables should be kept as short as possible and should be positioned close together, running at or close to the floor level.

Equipotential Bonding

Bonding of all metallic components in the cutting installation and adjacent to it should be considered. However, metallic components bonded to the workpiece will increase the risk that the operator could receive a shock by touching these metallic components and the electrode at the same time. The operator should be insulated from all such bonded metallic components.

Earthing of Workpiece

Where the workpiece is not bonded to earth for electrical safety, nor connected to earth because of its size and position, for example, ship's hull or building steelwork, a connection bonding the workpiece to earth may reduce emissions in some, but not all instances. Care should be taken to prevent the earthing of the workpiece increasing the risk of injury to users, or damage to other electrical equipment. Where necessary, the connection of the workpiece to earth should be made by a direct connection to the workpiece, but in some countries where direct connection is not permitted, the bonding should be achieved by suitable capacitances selected according to national regulations.

Note. The cutting circuit may or may not be earthed for safety reasons. Changing the earthing arrangements should only be authorized by a person who is competent to assess whether the changes will increase the risk of injury, for example, by allowing parallel cutting current return paths which may damage the earth circuits of other equipment. Further guidance is given in IEC/TS 62081 Arc Welding Equipment Installation and Use.

Screening and Shielding

Selective screening and shielding of other cables and equipment in the surrounding area may alleviate problems of interference. Screening of the entire plasma cutting installation may be considered for special applications.

WARRANTY

WARNING

Genuine Hypertherm parts are the factory-recommended replacement parts for your Hypertherm system. Any damage caused by the use of other than genuine Hypertherm parts may not be covered by the Hypertherm warranty.

WARNING

You are responsible for the safe use of the Product. Hypertherm does not and cannot make any guarantee or warranty regarding the safe use of the Product in your environment.

GENERAL

Hypertherm, Inc. warrants that its Products shall be free from defects in materials and workmanship, if Hypertherm is notified of a defect (i) with respect to the power supply within a period of two (2) years from the date of its delivery to you, with the exception of Powermax Series power supplies, which shall be within a period of three (3) years from the date of delivery to you, and (ii) with respect to the torch and leads within a period of one (1) year from its date of delivery to you. This warranty shall not apply to any Product which has been incorrectly installed, modified, or otherwise damaged. Hypertherm, at its sole option, shall repair, replace, or adjust, free of charge, any defective Products covered by this warranty which shall be returned with Hypertherm's prior authorization (which shall not be unreasonably withheld), properly packed, to Hypertherm's place of business in Hanover, New Hampshire, or to an authorized Hypertherm repair facility, all costs, insurance and freight prepaid. Hypertherm shall not be liable for any repairs, replacement, or adjustments of Products covered by this warranty, except those made pursuant to this paragraph or with Hypertherm's prior written consent. **The warranty above is exclusive and is in lieu of all other warranties, express, implied, statutory, or otherwise with respect to the Products or as to the results which may be obtained therefrom, and all implied warranties or conditions of quality or of merchantability or fitness for a particular purpose or against infringement. The foregoing shall constitute the sole and exclusive remedy for any breach by Hypertherm of its warranty.** Distributors/OEMs may offer different or additional warranties, but Distributors/OEMs are not authorized to give any additional warranty protection to you or make any representation to you purporting to be binding upon Hypertherm.

PATENT INDEMNITY

Except only in cases of products not manufactured by Hypertherm or manufactured by a person other than Hypertherm not in strict conformity with Hypertherm's specifications and in cases of designs, processes, formulae, or combinations not developed or purported to be developed by Hypertherm, Hypertherm will defend or settle, at its own expense, any suit or proceeding brought against you alleging that the use of the Hypertherm product, alone and not in combination with any other product not supplied by

Hypertherm, infringes any patent of any third party. You shall notify Hypertherm promptly upon learning of any action or threatened action in connection with any such alleged infringement, and Hypertherm's obligation to indemnify shall be conditioned upon Hypertherm's sole control of, and the indemnified party's cooperation and assistance in, the defense of the claim.

LIMITATION OF LIABILITY

In no event shall Hypertherm be liable to any person or entity for any incidental, consequential, indirect, or punitive damages (including but not limited to lost profits) regardless of whether such liability is based on breach of contract, tort, strict liability, breach of warranties, failure of essential purpose or otherwise and even if advised of the possibility of such damages.

LIABILITY CAP

In no event shall Hypertherm's liability, whether such liability is based on breach of contract, tort, strict liability, breach of warranties, failure of essential purpose or otherwise, for any claim action suit or proceeding arising out of or relating to the use of the Products exceed in the aggregate the amount paid for the Products that gave rise to such claim.

INSURANCE

At all times you will have and maintain insurance in such quantities and types, and with coverage sufficient and appropriate to defend and to hold Hypertherm harmless in the event of any cause of action arising from the use of the Products.

NATIONAL AND LOCAL CODES

National and Local codes governing plumbing and electrical installation shall take precedent over any instructions contained in this manual. **In no event** shall Hypertherm be liable for injury to persons or property damage by reason of any code violation or poor work practices.

TRANSFER OF RIGHTS

You may transfer any remaining rights you may have hereunder only in connection with the sale of all or substantially all of your assets or capital stock to a successor in interest who agrees to be bound by all of the terms and conditions of this Warranty.

Electromagnetic Compatibility	i
Warranty	ii
Section 1 SAFETY	
Recognize Safety Information.....	1-2
Follow Safety Instructions.....	1-2
Cutting Can Cause Fire or Explosion	1-2
Electric Shock Can Kill.....	1-3
Cutting Can Produce Toxic Fumes	1-3
A Plasma Arc Can Cause Injury and Burns	1-4
Arc Rays Can Burn Eyes and Skin	1-4
Grounding Safety.....	1-4
Compressed Gas Equipment Safety	1-5
Gas Cylinders Can Explode If Damaged	1-5
Noise Can Damage Hearing.....	1-5
Pacemaker and Hearing Aid Operation	1-5
A Plasma Arc Can Damage Frozen Pipes	1-5
Additional Safety Information.....	1-5
Warning Label.....	1-6
Section 1a SÉCURITÉ	
Identifier les consignes de sécurité.....	1a-2
Suivre les instructions de sécurité	1a-2
Danger Avertissement Précaution	1a-2
Le coupage peut provoquer un incendie ou une explosion	1a-2
Prévention des incendies, Prévention des explosions	1a-2
Risque d'explosion argon-hydrogène et méthane.....	1a-2
Détonation de l'hydrogène lors du coupage de l'aluminium.....	1a-2
Les chocs électriques peuvent être fatals.....	1a-3
Prévention des chocs électriques	1a-3
Le coupage peut produire des vapeurs toxiques.....	1a-3
L'arc plasma peut provoquer des blessures ou des brûlures	1a-4
Torches à allumage instantané	1a-4
Les rayons de l'arc peuvent brûler les yeux et la peau.....	1a-4
Protection des yeux, Protection de la peau, Zone de coupage	1a-4
Mise à la masse et à la terre.....	1a-4
Câble de retour, Table de travail, Alimentation	1a-4
Sécurité des bouteilles de gaz comprimé	1a-5
Les bouteilles de gaz comprimé peuvent exploser en cas de dommages	1a-5
Le bruit peut provoquer des problèmes auditifs.....	1a-5
Pacemakers et prothèses auditives.....	1a-5
Un arc plasma peut endommager les tuyaux gelés.....	1a-5
Étiquette de sécurité	1a-6
Section 1b SEGURIDAD	
Reconocimiento de información de seguridad.....	1b-2
Siga las instrucciones de seguridad	1b-2

TABLE OF CONTENTS

Peligro...Advertencia...Precaución	1b-2
Los cortes pueden provocar incendios o explosiones	1b-2
Prevención ante el fuego, Prevención ante explosiones	1b-2
Peligro de explosión argón-hidrógeno y metano.....	1b-2
Detonación de hidrógeno con el corte de aluminio	1b-2
El choque eléctrico puede provocar la muerte	1b-3
Prevención ante el electrochoque	1b-3
Los cortes pueden producir humos tóxicos	1b-3
El arco de plasma puede causar lesiones y quemaduras	1b-4
Antorchas de encendido instantáneo.....	1b-4
Los rayos del arco pueden producir quemaduras en los ojos y en la piel	1b-4
Protección para los ojos, Protección para la piel, Área de corte.....	1b-4
Seguridad de toma a tierra	1b-4
Cable de trabajo, Mesa de trabajo, Potencia primaria de entrada.....	1b-4
Seguridad de los equipos de gas comprimido.....	1b-5
Los cilindros de gas pueden explotar si están dañados	1b-5
El ruido puede deteriorar la audición	1b-5
Operación de marcapasos y de audífonos	1b-5
Un arco plasma puede dañar tubos congelados	1b-5
Etiqueta de advertencia	1b-6

Section 2 SPECIFICATIONS

Power supply	2-2
Dimensions and weight	2-3
T80 torches.....	2-4
Dimensions	2-5
Symbols and markings	2-6
[S] Mark.....	2-6
IEC symbols	2-6

Section 3 MAINTENANCE

Controls and indicators	3-3
Indicator LEDs.....	3-3
Theory of operation.....	3-4
General	3-4
Functional description	3-4
Sequence of operation	3-5
Troubleshooting preparation	3-6
Test equipment.....	3-6
Troubleshooting procedures and sequence	3-6
External inspection.....	3-6
Internal inspection	3-7
Initial resistance check.....	3-7
Check power switch	3-8
Hypertherm IGBT tester	3-9
Indicator LEDs and device tests	3-9
IGBT test preparation.....	3-10
IGBT device test using the Hypertherm tester	3-10
Troubleshoot the Hypertherm IGBT tester	3-11
Schematic for building an IGBT tester.....	3-11
IGBT device test using non-Hypertherm tester	3-12
Troubleshooting guide	3-14

Control board LEDs.....	3-20
Test 1 – voltage input	3-22
Test 2 – voltage balance	3-23
Test 3 – output diodes	3-24
Test 4 – pilot arc IGBT (Q8)	3-25
Test 5 – inverter IGBT (Q6) and PFC IGBT (Q7)	3-26
Test 6 – flyback circuit	3-27
Test 7 – torch stuck open (TSO)	3-28
Test 8 – plasma start	3-29
Test 9 – torch cap sensor	3-29
Test 10 – gas solenoid	3-30
Test 11 – incoming line voltage (VACR)	3-30
Test 12 – pressure switch.....	3-30
Test 13 – fan.....	3-30
Test 14 – AUX switch	3-31
Test 15 – flyback circuit failure	3-31
T60 hand torch connector pinout diagrams and assembly	3-32
T60M machine torch connector pinout diagrams and assembly	3-33
Component replacement	3-34
Power cord replacement	3-34
Torch replacement.....	3-35
Filter element replacement.....	3-37
Work cable replacement	3-38
Capacitor replacement	3-39
Power board removal and replacement	3-40
Heat sink component replacement.....	3-43
Section 4 PARTS – POWER SUPPLY	
Exterior	4-2
Interior right side	4-3
Back interior right side	4-4
Interior fan side	4-5
Heat sink assembly.....	4-6
Recommended spare parts	4-7
Section 5 PARTS – TORCH AND CONSUMABLES	
T80 hand torch assembly	5-2
T80M machine torch assembly.....	5-4
T80 consumable configurations	5-6
T80M consumable configurations.....	5-7
Recommended spare parts	5-8
Section 6 WIRING DIAGRAMS	
Timing diagrams	6-2
Electrical schematics	6-5

Section 1

SAFETY

In this section:

Recognize Safety Information.....	1-2
Follow Safety Instructions.....	1-2
Cutting Can Cause Fire or Explosion	1-2
Electric Shock Can Kill.....	1-3
Cutting Can Produce Toxic Fumes	1-3
A Plasma Arc Can Cause Injury and Burns	1-4
Arc Rays Can Burn Eyes and Skin	1-4
Grounding Safety.....	1-4
Compressed Gas Equipment Safety	1-5
Gas Cylinders Can Explode If Damaged	1-5
Noise Can Damage Hearing.....	1-5
Pacemaker and Hearing Aid Operation	1-5
A Plasma Arc Can Damage Frozen Pipes	1-5
Additional Safety Information	1-5
Warning Label.....	1-6



RECOGNIZE SAFETY INFORMATION

The symbols shown in this section are used to identify potential hazards. When you see a safety symbol in this manual or on your machine, understand the potential for personal injury, and follow the related instructions to avoid the hazard.



FOLLOW SAFETY INSTRUCTIONS

Read carefully all safety messages in this manual and safety labels on your machine.

- Keep the safety labels on your machine in good condition. Replace missing or damaged labels immediately.
- Learn how to operate the machine and how to use the controls properly. Do not let anyone operate it without instruction.

- Keep your machine in proper working condition. Unauthorized modifications to the machine may affect safety and machine service life.

DANGER WARNING CAUTION

A signal word DANGER or WARNING is used with a safety symbol. DANGER identifies the most serious hazards.

- DANGER and WARNING safety labels are located on your machine near specific hazards.
- WARNING safety messages precede related instructions in this manual that may result in injury or death if not followed correctly.
- CAUTION safety messages precede related instructions in this manual that may result in damage to equipment if not followed correctly.



CUTTING CAN CAUSE FIRE OR EXPLOSION

Fire Prevention

- Be sure the area is safe before doing any cutting. Keep a fire extinguisher nearby.
- Remove all flammables within 35 feet (10 m) of the cutting area.
- Quench hot metal or allow it to cool before handling or before letting it touch combustible materials.
- Never cut containers with potentially flammable materials inside – they must be emptied and properly cleaned first.
- Ventilate potentially flammable atmospheres before cutting.
- When cutting with oxygen as the plasma gas, an exhaust ventilation system is required.

Explosion Prevention

- Do not use the plasma system if explosive dust or vapors may be present.
- Do not cut pressurized cylinders, pipes, or any closed container.
- Do not cut containers that have held combustible materials.



WARNING

Explosion Hazard
Argon-Hydrogen and Methane

Hydrogen and methane are flammable gases that present an explosion hazard. Keep flames away from cylinders and hoses that contain methane or hydrogen mixtures. Keep flames and sparks away from the torch when using methane or argon-hydrogen plasma.



WARNING

Hydrogen Detonation with Aluminum Cutting

- When cutting aluminum underwater, or with the water touching the underside of the aluminum, free hydrogen gas may collect under the workpiece and detonate during plasma cutting operations.
- Install an aeration manifold on the floor of the water table to eliminate the possibility of hydrogen detonation. Refer to the Appendix section of this manual for aeration manifold details.



ELECTRIC SHOCK CAN KILL

Touching live electrical parts can cause a fatal shock or severe burn.

- Operating the plasma system completes an electrical circuit between the torch and the workpiece. The workpiece and anything touching the workpiece are part of the electrical circuit.
- Never touch the torch body, workpiece or the water in a water table when the plasma system is operating.

Electric Shock Prevention

All Hypertherm plasma systems use high voltage in the cutting process (200 to 400 VDC are common). Take the following precautions when operating this system:

- Wear insulated gloves and boots, and keep your body and clothing dry.
- Do not stand, sit or lie on – or touch – any wet surface when using the plasma system.
- Insulate yourself from work and ground using dry insulating mats or covers big enough to prevent any physical contact with the work or ground. If you must work in or near a damp area, use extreme caution.
- Provide a disconnect switch close to the power supply with properly sized fuses. This switch allows the operator to turn off the power supply quickly in an emergency situation.
- When using a water table, be sure that it is correctly connected to earth ground.

- Install and ground this equipment according to the instruction manual and in accordance with national and local codes.
- Inspect the input power cord frequently for damage or cracking of the cover. Replace a damaged power cord immediately. **Bare wiring can kill.**
- Inspect and replace any worn or damaged torch leads.
- Do not pick up the workpiece, including the waste cutoff, while you cut. Leave the workpiece in place or on the workbench with the work cable attached during the cutting process.
- Before checking, cleaning or changing torch parts, disconnect the main power or unplug the power supply.
- Never bypass or shortcut the safety interlocks.
- Before removing any power supply or system enclosure cover, disconnect electrical input power. Wait 5 minutes after disconnecting the main power to allow capacitors to discharge.
- Never operate the plasma system unless the power supply covers are in place. Exposed power supply connections present a severe electrical hazard.
- When making input connections, attach proper grounding conductor first.
- Each Hypertherm plasma system is designed to be used only with specific Hypertherm torches. Do not substitute other torches which could overheat and present a safety hazard.



CUTTING CAN PRODUCE TOXIC FUMES

Cutting can produce toxic fumes and gases that deplete oxygen and cause injury or death.

- Keep the cutting area well ventilated or use an approved air-supplied respirator.
- Do not cut in locations near degreasing, cleaning or spraying operations. The vapors from certain chlorinated solvents decompose to form phosgene gas when exposed to ultraviolet radiation.
- Do not cut metal coated or containing toxic materials, such as zinc (galvanized), lead, cadmium or beryllium, unless the area is well ventilated and the operator wears an air-supplied respirator. The coatings and any metals containing these elements can produce toxic fumes when cut.
- Never cut containers with potentially toxic materials inside – they must be emptied and properly cleaned first.
- This product, when used for welding or cutting, produces fumes or gases which contain chemicals known to the State of California to cause birth defects and, in some cases, cancer.



A PLASMA ARC CAN CAUSE INJURY AND BURNS

Instant-On Torches

Plasma arc comes on immediately when the torch switch is activated.

The plasma arc will cut quickly through gloves and skin.

- Keep away from the torch tip.
- Do not hold metal near the cutting path.
- Never point the torch toward yourself or others.



ARC RAYS CAN BURN EYES AND SKIN

Eye Protection Plasma arc rays produce intense visible and invisible (ultraviolet and infrared) rays that can burn eyes and skin.

- Use eye protection in accordance with applicable national or local codes.
- Wear eye protection (safety glasses or goggles with side shields, and a welding helmet) with appropriate lens shading to protect your eyes from the arc's ultraviolet and infrared rays.

Skin Protection Wear protective clothing to protect against burns caused by ultraviolet light, sparks and hot metal.

- Gauntlet gloves, safety shoes and hat.
- Flame-retardant clothing to cover all exposed areas.
- Cuffless trousers to prevent entry of sparks and slag.
- Remove any combustibles, such as a butane lighter or matches, from your pockets before cutting.

Arc Current
 Up to 100 A
 100-200 A
 200-400 A
 Over 400 A



Lens Shade	
AWS (USA)	ISO 4850
No. 8	No. 11
No. 10	No. 11-12
No. 12	No. 13
No. 14	No. 14

Cutting Area Prepare the cutting area to reduce reflection and transmission of ultraviolet light:

- Paint walls and other surfaces with dark colors to reduce reflection.
- Use protective screens or barriers to protect others from flash and glare.
- Warn others not to watch the arc. Use placards or signs.



GROUNDING SAFETY

Work Cable Attach the work cable securely to the workpiece or the work table with good metal-to-metal contact. Do not connect it to the piece that will fall away when the cut is complete.

Work Table Connect the work table to an earth ground, in accordance with appropriate national or local electrical codes.

Input Power

- Be sure to connect the power cord ground wire to the ground in the disconnect box.
- If installation of the plasma system involves connecting the power cord to the power supply, be sure to connect the power cord ground wire properly.
- Place the power cord's ground wire on the stud first, then place any other ground wires on top of the power cord ground. Fasten the retaining nut tightly.
- Tighten all electrical connections to avoid excessive heating.

COMPRESSED GAS EQUIPMENT SAFETY

- Never lubricate cylinder valves or regulators with oil or grease.
- Use only correct gas cylinders, regulators, hoses and fittings designed for the specific application.
- Maintain all compressed gas equipment and associated parts in good condition.
- Label and color-code all gas hoses to identify the type of gas in each hose. Consult applicable national or local codes.

**GAS CYLINDERS CAN EXPLODE IF DAMAGED**

Gas cylinders contain gas under high pressure. If damaged, a cylinder can explode.

- Handle and use compressed gas cylinders in accordance with applicable national or local codes.
- Never use a cylinder that is not upright and secured in place.
- Keep the protective cap in place over valve except when the cylinder is in use or connected for use.
- Never allow electrical contact between the plasma arc and a cylinder.
- Never expose cylinders to excessive heat, sparks, slag or open flame.
- Never use a hammer, wrench or other tool to open a stuck cylinder valve.

**NOISE CAN DAMAGE HEARING**

Prolonged exposure to noise from cutting or gouging can damage hearing.

- Use approved ear protection when using plasma system.
- Warn others nearby about the noise hazard.

**PACEMAKER AND HEARING AID OPERATION**

Pacemaker and hearing aid operation can be affected by magnetic fields from high currents.

Pacemaker and hearing aid wearers should consult a doctor before going near any plasma arc cutting and gouging operations.

To reduce magnetic field hazards:

- Keep both the work cable and the torch lead to one side, away from your body.
- Route the torch leads as close as possible to the work cable.
- Do not wrap or drape the torch lead or work cable around your body.
- Keep as far away from the power supply as possible.

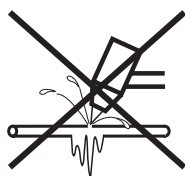
**A PLASMA ARC CAN DAMAGE FROZEN PIPES**

































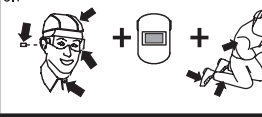



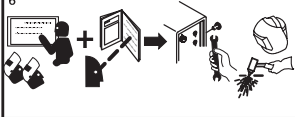













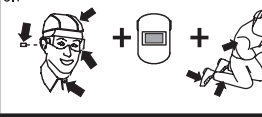



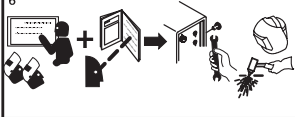









Frozen pipes may be damaged or can burst if you attempt to thaw them with a plasma torch.

ADDITIONAL SAFETY INFORMATION

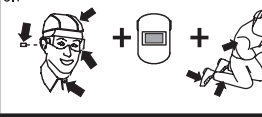
1. ANSI Standard Z49.1, *Safety in Welding and Cutting*, American Welding Society, 550 LeJeune Road, P.O. Box 351020, Miami, FL 33135
2. ANSI Standard Z49.2, *Fire Prevention in the Use of Cutting and Welding Processes*, American National Standards Institute, 1430 Broadway, New York, NY 10018
3. ANSI Standard Z87.1, *Safe Practices for Occupation and Educational Eye and Face Protection*, American National Standards Institute, 1430 Broadway, New York, NY 10018
4. AWS F4.1, *Recommended Safe Practices for the Preparation for Welding and Cutting of Containers and Piping That Have Held Hazardous Substances*, American Welding Society, 550 LeJeune Road, P.O. Box 351040, Miami, FL 33135
5. AWS F5.2, *Recommended Safe Practices for Plasma Arc Cutting*, American Welding Society, 550 LeJeune Road, P.O. Box 351040, Miami, FL 33135
6. CGA Pamphlet P-1, *Safe Handling of Compressed Gases in Cylinders*, Compressed Gas Association, 1235 Jefferson Davis Highway, Arlington, VA 22202
7. CSA Standard W117.2, *Code for Safety in Welding and Cutting*, Canadian Standards Association Standard Sales, 178 Rexdale Boulevard, Rexdale, Ontario M9W 1R3, Canada
8. NFPA Standard 51B, *Cutting and Welding Processes*, National Fire Protection Association, 470 Atlantic Avenue, Boston, MA 02210
9. NFPA Standard 70-1978, *National Electrical Code*, National Fire Protection Association, 470 Atlantic Avenue, Boston, MA 02210
10. OSHA, *Safety and Health Standards*, 29FR 1910, U.S. Government Printing Office, Washington, D.C. 20402

WARNING LABEL

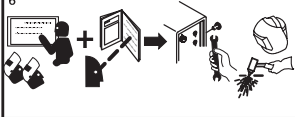
This warning label is affixed to some power supplies. It is important that the operator and maintenance technician understand the intent of these warning symbols as described. The numbered text corresponds to the numbered boxes on the label.

 <p>WARNING</p> <p>Protect yourself and others. Read and understand this marking.</p> <ul style="list-style-type: none"> • Disconnect power source before servicing. • Disconnect power source before disassembly of the torch. • Use torches specified in the instruction manual. • This plasma cutting machine must be connected to power source in accordance with applicable electrical codes. • Plasma arc cutting can be injurious to operator and persons in the work area. Before operating, read and understand the manufacturer's instructions and know your employer's safety practices. 	 <p>AVERTISSEMENT</p> <p>Pour votre protection et celle des autres, lire et comprendre ces consignes.</p> <ul style="list-style-type: none"> • Couper l'alimentation avant d'effectuer le dépannage. • Couper l'alimentation avant de démonter la torche. • Utiliser exclusivement les torches indiquées dans le manuel d'instructions. • Le raccordement au réseau de cette machine de coupage à arc-plasma doit être conforme aux codes de l'électricité pertinents. • Le coupage à arc-plasma comporte des risques pour l'utilisateur et les personnes se trouvant dans la zone de travail. Avant le coupage, lire et comprendre les instructions du fabricant. Appliquer également les consignes de sécurité de votre entreprise. 																																																		
 <p>Electric shock can kill.</p> <ul style="list-style-type: none"> • Do not touch live electrical parts. • Keep all panels and covers in place when the machine is connected to a power source.  <ul style="list-style-type: none"> • Insulate yourself from work and ground: wear insulating gloves, shoes and clothing.  <ul style="list-style-type: none"> • Keep gloves, shoes, clothing, work area, torch and this machinery dry. 	 <p>Fumes and gases can injure your health.</p> <ul style="list-style-type: none"> • Keep your head out of the fumes. • Provide ventilation, exhaust at the arc, or both to keep the fumes and gases from your breathing zone and the general area. • If ventilation is inadequate, use an approved respirator. <p>WARNING: This product, when used for welding or cutting, produces fumes or gases which contain chemicals known to the state of California to cause birth defects and, in some cases, cancer.</p>  <p>Heat, splatter and sparks cause fire and burns.</p> <ul style="list-style-type: none"> • Do not cut near combustible material. • Do not cut containers that have held combustibles. • Do not have on your person any combustibles such as a butane lighter or matches.  <p>Pilot arc can cause burns.</p> <ul style="list-style-type: none"> • Keep the torch nozzle away from yourself and others when the switch is depressed. • Wear correct eye and body protection. 																																																		
<p>DO NOT REMOVE THIS MARKING</p>	<p>NE PAS ENLEVER CET AVIS</p>																																																		
 <p>WARNING</p> <p>INSTANT START Arc starts instantly after torch switch is depressed.</p>	 <p>AVERTISSEMENT</p> <p>AMORÇAGE INSTANTANÉ L'arc s'amorce aussitôt qu'on enclenche l'interrupteur de la torche.</p>																																																		
<table border="1" style="width: 100%; border-collapse: collapse;"> <tr> <td style="width: 12.5%; text-align: center;">1</td> <td style="width: 12.5%; text-align: center;">1.1</td> <td style="width: 12.5%; text-align: center;">1.2</td> <td style="width: 12.5%; text-align: center;">1.3</td> <td style="width: 12.5%; text-align: center;">4</td> <td style="width: 12.5%; text-align: center;">4.1</td> <td style="width: 12.5%; text-align: center;">4.2</td> <td style="width: 12.5%; text-align: center;">4.3</td> </tr> <tr> <td></td> <td></td> <td></td> <td></td> <td></td> <td></td> <td></td> <td></td> </tr> <tr> <td style="text-align: center;">2</td> <td style="text-align: center;">2.1</td> <td style="text-align: center;">2.2</td> <td style="text-align: center;">2.3</td> <td style="text-align: center;">5</td> <td colspan="3" style="text-align: center;">5.1</td> </tr> <tr> <td></td> <td></td> <td></td> <td></td> <td></td> <td colspan="3" style="text-align: center;"></td> </tr> <tr> <td style="text-align: center;">3</td> <td style="text-align: center;">3.1</td> <td style="text-align: center;">3.2</td> <td style="text-align: center;">3.3</td> <td colspan="4" style="text-align: center;">6</td> <td style="text-align: center;">7</td> </tr> <tr> <td></td> <td></td> <td></td> <td></td> <td colspan="4" style="text-align: center;"></td> <td></td> </tr> </table>		1	1.1	1.2	1.3	4	4.1	4.2	4.3									2	2.1	2.2	2.3	5	5.1											3	3.1	3.2	3.3	6				7									
1	1.1	1.2	1.3	4	4.1	4.2	4.3																																												
																																																			
2	2.1	2.2	2.3	5	5.1																																														
																																																			
3	3.1	3.2	3.3	6				7																																											
																																																			

1. Cutting sparks can cause explosion or fire.
 - 1.1 Keep flammables away from cutting.
 - 1.2 Keep a fire extinguisher nearby, and have a watchperson ready to use it.
 - 1.3 Do not cut on any closed containers.
2. The plasma arc can cause injury and burns.
 - 2.1 Turn off power before disassembling torch.
 - 2.2 Do not hold the material near cutting path.
 - 2.3 Wear complete body protection.
3. Electric shock from torch or wiring can kill. Protect yourself from electric shock.
 - 3.1 Wear insulating gloves. Do not wear wet or damaged gloves.
 - 3.2 Insulate yourself from work and ground.
 - 3.3 Disconnect input plug or power before working on machine.
4. Breathing cutting fumes can be hazardous to your health.
 - 4.1 Keep your head out of the fumes.
 - 4.2 Use forced ventilation or local exhaust to remove the fumes.
 - 4.3 Use ventilating fan to remove the fumes.
5. Arc rays can burn eyes and injure skin.
 - 5.1 Wear hat and safety glasses. Use ear protection and button shirt collar. Use welding helmet with correct shade of filter. Wear complete body protection.
6. Become trained and read the instructions before working on the machine or cutting.
7. Do not remove or paint over (cover) warning labels.

Dans cette section :

Identifier les consignes de sécurité.....	1a-2
Suivre les instructions de sécurité	1a-2
Danger Avertissement Précaution	1a-2
Le coupage peut provoquer un incendie ou une explosion	1a-2
Prévention des incendies, Prévention des explosions	1a-2
Risque d'explosion argon-hydrogène et méthane.....	1a-2
Détonation de l'hydrogène lors du coupage de l'aluminium.....	1a-2
Les chocs électriques peuvent être fatals.....	1a-3
Prévention des chocs électriques	1a-3
Le coupage peut produire des vapeurs toxiques.....	1a-3
L'arc plasma peut provoquer des blessures ou des brûlures	1a-4
Torches à allumage instantané	1a-4
Les rayons de l'arc peuvent brûler les yeux et la peau.....	1a-4
Protection des yeux, Protection de la peau, Zone de coupage	1a-4
Mise à la masse et à la terre.....	1a-4
Câble de retour, Table de travail, Alimentation.....	1a-4
Sécurité des bouteilles de gaz comprimé	1a-5
Les bouteilles de gaz comprimé peuvent exploser en cas de dommages	1a-5
Le bruit peut provoquer des problèmes auditifs.....	1a-5
Pacemakers et prothèses auditives.....	1a-5
Un arc plasma peut endommager les tuyaux gelés.....	1a-5
Étiquette de sécurité	1a-6



IDENTIFIER LES CONSIGNES DE SÉCURITÉ

Les symboles indiqués dans cette section sont utilisés pour identifier les risques éventuels. Si vous trouvez un symbole de sécurité, que ce soit dans ce manuel ou sur l'équipement, soyez conscient des risques de blessures et suivez les instructions correspondantes afin d'éviter ces risques.



SUIVRE LES INSTRUCTIONS DE SÉCURITÉ

Lire attentivement toutes les consignes de sécurité dans le présent manuel et sur les étiquettes de sécurité se trouvant sur la machine.

- Les étiquettes de sécurité doivent rester lisibles. Remplacer immédiatement les étiquettes manquantes ou abîmées.
- Apprendre à faire fonctionner la machine et à utiliser correctement les commandes. Ne laisser personne utiliser la machine sans connaître son fonctionnement.

- Garder la machine en bon état. Des modifications non autorisées sur la machine peuvent engendrer des problèmes de sécurité et raccourcir la durée d'utilisation de l'équipement.

DANGER AVERTISSEMENT PRÉCAUTION

Les signaux DANGER ou AVERTISSEMENT sont utilisés avec un symbole de sécurité, DANGER correspondant aux risques les plus sérieux.

- Les étiquettes de sécurité DANGER et AVERTISSEMENT sont situées sur la machine pour signaler certains dangers spécifiques.
- Les messages d'AVERTISSEMENT précèdent les instructions d'utilisation expliquées dans ce manuel et signalent les risques de blessures ou de mort au cas où ces instructions ne seraient pas suivies correctement.
- Les messages de PRÉCAUTION précèdent les instructions d'utilisation contenues dans ce manuel et signalent que le matériel risque d'être endommagé si les instructions ne sont pas suivies correctement.



LE COUPAGE PEUT PROVOQUER UN INCENDIE OU UNE EXPLOSION

Prévention des incendies

- Avant de commencer, s'assurer que la zone de coupage ne présente aucun danger. Conserver un extincteur à proximité.
- Éloigner toute matière inflammable à une distance d'au moins 10 m du poste de coupage.
- Tremper le métal chaud ou le laisser refroidir avant de le manipuler ou avant de le mettre en contact avec des matériaux combustibles.
- Ne jamais couper des récipients pouvant contenir des matières inflammables avant de les avoir vidés et nettoyés correctement.
- Aérer toute atmosphère potentiellement inflammable avant d'utiliser un système plasma.
- Lors de l'utilisation d'oxygène comme gaz plasma, un système de ventilation par aspiration est nécessaire.

Prévention des explosions

- Ne pas couper en présence de poussière ou de vapeurs.
- Ne pas couper de bouteilles, de tuyaux ou autres récipients fermés et pressurisés.
- Ne pas couper de récipients contenant des matières combustibles.



AVERTISSEMENT

Risque d'explosion argon-hydrogène et méthane

L'hydrogène et le méthane sont des gaz inflammables et potentiellement explosifs. Conserver à l'écart de toute flamme les bouteilles et tuyaux contenant des mélanges à base d'hydrogène ou de méthane. Maintenir toute flamme et étincelle à l'écart de la torche lors de l'utilisation d'un plasma d'argon-hydrogène ou de méthane.



AVERTISSEMENT

Détonation de l'hydrogène lors du coupage de l'aluminium

- Lors du coupage de l'aluminium sous l'eau, ou si l'eau touche la partie inférieure de la pièce d'aluminium, de l'hydrogène libre peut s'accumuler sous la pièce à couper et détonner lors du coupage plasma.
- Installer un collecteur d'aération au fond de la table à eau afin d'éliminer les risques de détonation de l'hydrogène. Se référer à l'annexe du manuel pour plus de renseignements sur les collecteurs d'aération.



LES CHOCS ÉLECTRIQUES PEUVENT ÊTRE FATALS

Toucher une pièce électrique sous tension peut provoquer un choc électrique fatal ou des brûlures graves.

- La mise en fonctionnement du système plasma ferme un circuit électrique entre la torche et la pièce à couper. La pièce à couper et tout autre élément en contact avec cette pièce font partie du circuit électrique.
- Ne jamais toucher le corps de la torche, la pièce à couper ou l'eau de la table à eau pendant le fonctionnement du système plasma.

Prévention des chocs électriques

Tous les systèmes plasma Hypertherm utilisent des hautes tensions pour le coupage (souvent de 200 à 400 V). On doit prendre les précautions suivantes quand on utilise le système plasma :

- Porter des bottes et des gants isolants et garder le corps et les vêtements au sec.
- Ne pas se tenir, s'asseoir ou se coucher sur une surface mouillée, ni la toucher quand on utilise le système plasma.
- S'isoler de la surface de travail et du sol en utilisant des tapis isolants secs ou des couvertures assez grandes pour éviter tout contact physique avec le travail ou le sol. S'il s'avère nécessaire de travailler dans ou près d'un endroit humide, procéder avec une extrême prudence.
- Installer un sectionneur avec fusibles appropriés, à proximité de la source de courant. Ce dispositif permet à l'opérateur d'arrêter rapidement la source de courant en cas d'urgence.
- En cas d'utilisation d'une table à eau, s'assurer que cette dernière est correctement mise à la terre.

- Installer et mettre à la terre l'équipement selon les instructions du présent manuel et conformément aux codes électriques locaux et nationaux.
- Inspecter fréquemment le cordon d'alimentation primaire pour s'assurer qu'il n'est ni endommagé, ni fendu. Remplacer immédiatement un cordon endommagé.
Un câble dénudé peut tuer.
- Inspecter et remplacer les câbles de la torche qui sont usés ou endommagés.
- Ne pas saisir la pièce à couper ni les chutes lors du coupage. Laisser la pièce à couper en place ou sur la table de travail, le câble de retour connecté lors du coupage.
- Avant de vérifier, de nettoyer ou de remplacer les pièces de la torche, couper l'alimentation ou débrancher la prise de courant.
- Ne jamais contourner ou court-circuiter les verrouillages de sécurité.
- Avant d'enlever le capot du système ou de la source de courant, couper l'alimentation électrique. Attendre ensuite 5 minutes pour que les condensateurs se déchargent.
- Ne jamais faire fonctionner le système plasma sans que les capots de la source de courant ne soient en place. Les raccords exposés de la source de courant sont extrêmement dangereux.
- Lors de l'installation des connexions, attacher tout d'abord la prise de terre appropriée.
- Chaque système plasma Hypertherm est conçu pour être utilisé uniquement avec des torches Hypertherm spécifiques. Ne pas utiliser des torches inappropriées qui pourraient surchauffer et présenter des risques pour la sécurité.



LE COUPAGE PEUT PRODUIRE DES VAPEURS TOXIQUES

Le coupage peut produire des vapeurs et des gaz toxiques qui réduisent le niveau d'oxygène dans l'air et peuvent provoquer des blessures, voire la mort.

- Conserver le poste de coupage bien aéré ou utiliser un masque respiratoire homologué.
- Ne pas procéder au coupage près d'endroits où s'effectuent le dégraissage, le nettoyage ou la vaporisation. Certains solvants chlorés se décomposent sous l'effet des rayons ultraviolets et forment du phosgène.
- Ne pas couper des métaux peints ou contenant des matières toxiques comme le zinc (galvanisé), le plomb, le cadmium ou le béryllium, à moins que la zone de travail

soit très bien ventilée et que l'opérateur porte un masque respiratoire. Les revêtements et métaux contenant ces matières peuvent produire des vapeurs toxiques lors du coupage.

- Ne jamais couper de récipients pouvant contenir des matières inflammables avant de les avoir vidés et nettoyés correctement.
- Quand on utilise ce produit pour le soudage ou le coupage, il dégage des fumées et des gaz qui contiennent des produits chimiques qui, selon l'État de Californie, provoquent des anomalies congénitales et, dans certains cas, le cancer.



L'ARC PLASMA PEUT PROVOQUER DES BLESSURES OU DES BRÛLURES

Torches à allumage instantané

L'arc plasma s'allume immédiatement après que la torche soit mise en marche.

L'arc plasma coupe facilement les gants et la peau.

- Rester éloigné de l'extrémité de la torche.
- Ne pas tenir de métal près de la trajectoire de coupe.
- Ne jamais pointer la torche vers soi ou d'autres personnes.



LES RAYONS DE L'ARC PEUVENT BRÛLER LES YEUX ET LA PEAU

Protection des yeux Les rayons de l'arc plasma produisent de puissants rayons visibles ou invisibles (ultraviolets et infrarouges) qui peuvent brûler les yeux et la peau.

- Utiliser des lunettes de sécurité conformément aux codes locaux ou nationaux en vigueur.
- Porter des lunettes de protection (lunettes ou masque muni d'écrans latéraux et encore masque de soudure) avec des verres teintés appropriés pour protéger les yeux des rayons ultraviolets et infrarouges de l'arc.

- Gants à crispin, chaussures et casque de sécurité.
- Vêtements ignifuges couvrant toutes les parties exposées du corps.
- Pantalon sans revers pour éviter que des étincelles ou des scories puissent s'y loger.
- Avant le coupage, retirer de ses poches tout objet combustible comme les briquets au butane ou les allumettes.

Zone de coupage Préparer la zone de coupage afin de réduire la réverbération et la transmission de la lumière ultraviolette :

- Peindre les murs et autres surfaces de couleur sombre pour réduire la réflexion de la lumière.
- Utiliser des écrans et autres dispositifs de protection afin de protéger les autres personnes de la lumière et de la réverbération.
- Prévenir les autres personnes de ne pas regarder l'arc. Utiliser des affiches ou des panneaux.

Courant de l'arc

Jusqu'à 100 A
100-200 A
200-400 A
Plus de 400 A



Puissance des verres teintés

AWS (É.-U.)

N° 8
N° 10
N° 12
N° 14

ISO 4850

N° 11
N° 11-12
N° 13
N° 14



Protection de la peau Porter des vêtements de sécurité pour se protéger contre les brûlures que peuvent causer les rayons ultraviolets, les étincelles et le métal brûlant :



MISE À LA MASSE ET À LA TERRE

Câble de retour Bien fixer le câble de retour (ou de masse) à la pièce à couper ou à la table de travail de façon à assurer un bon contact métal-métal. Ne pas fixer le câble de retour à la partie de la pièce qui doit se détacher.

Table de travail Raccorder la table de travail à la terre, conformément aux codes de sécurité locaux ou nationaux appropriés.

Alimentation

- S'assurer que le fil de terre du cordon d'alimentation est connecté à la terre dans le coffret du sectionneur.
- S'il est nécessaire de brancher le cordon d'alimentation à la source de courant lors de l'installation du système, s'assurer que le fil de terre est correctement branché.
- Placer tout d'abord le fil de terre du cordon d'alimentation sur le plot de mise à la terre puis placer les autres fils de terre par-dessus. Bien serrer l'écrou de retenue.
- S'assurer que toutes les connexions sont bien serrées pour éviter la surchauffe.

SÉCURITÉ DES BOUTEILLES DE GAZ COMPRIMÉ

- Ne jamais lubrifier les robinets des bouteilles ou les régulateurs avec de l'huile ou de la graisse.
- Utiliser uniquement les bouteilles, régulateurs, tuyaux et accessoires appropriés et conçus pour chaque application spécifique.
- Entretenir l'équipement et les pièces d'équipement à gaz comprimé afin de les garder en bon état.
- Étiqueter et coder avec des couleurs tous les tuyaux de gaz afin d'identifier le type de gaz contenu dans chaque tuyau. Se référer aux codes locaux ou nationaux en vigueur.



LES BOUTEILLES DE GAZ COMPRIMÉ PEUVENT EXPLOSER EN CAS DE DOMMAGES

Les bouteilles de gaz contiennent du gaz à haute pression. Si une bouteille est endommagée, elle peut exploser.

- Manipuler et utiliser les bouteilles de gaz comprimé conformément aux codes locaux ou nationaux.
- Ne jamais utiliser une bouteille qui n'est pas placée à la verticale et bien assujettie.
- Le capuchon de protection doit être placé sur le robinet sauf si la bouteille est en cours d'utilisation ou connectée pour utilisation.
- Éviter à tout prix le contact électrique entre l'arc plasma et une bouteille.
- Ne jamais exposer des bouteilles à une chaleur excessive, aux étincelles, aux scories ou aux flammes nues.
- Ne jamais utiliser des marteaux, des clés ou d'autres outils pour débloquer le robinet des bouteilles.



LE BRUIT PEUT PROVOQUER DES PROBLÈMES AUDITIFS

Une exposition prolongée au bruit du coupage ou du gougeage peut provoquer des problèmes auditifs.

- Utiliser un casque de protection homologué lors de l'utilisation du système plasma.
- Prévenir les personnes aux alentours des risques encourus en cas d'exposition au bruit.



PACEMAKERS ET PROTHÈSES AUDITIVES

Les champs magnétiques produits par les courants à haute tension peuvent affecter le fonctionnement des prothèses auditives et des pacemakers. Les personnes portant ce type d'appareil doivent consulter un médecin avant de s'approcher d'un lieu où s'effectue le coupage ou le gougeage plasma.

Pour réduire les risques associés aux champs magnétiques :

- Garder loin de soi et du même côté du corps le câble de retour et le faisceau de la torche.
- Faire passer le faisceau de la torche le plus près possible du câble de retour.
- Ne pas s'enrouler le faisceau de la torche ou le câble de retour autour du corps.
- Se tenir le plus loin possible de la source de courant.

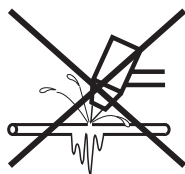



























UN ARC PLASMA PEUT ENDOMMAGER LES TUYAUX GELÉS

Les tuyaux gelés peuvent être endommagés ou éclater si l'on essaie de les dégeler avec une torche plasma.

Étiquette de sécurité

Cette étiquette est affichée sur la source de courant. Il est important que l'utilisateur et le technicien de maintenance comprennent la signification des symboles de sécurité. Les numéros de la liste correspondent aux numéros des images.

! WARNING		! AVERTISSEMENT					
Protect yourself and others. Read and understand this marking. <ul style="list-style-type: none"> Disconnect power source before servicing. Disconnect power source before disassembly of the torch. Use torches specified in the instruction manual. This plasma cutting machine must be connected to power source in accordance with applicable electrical codes. Plasma arc cutting can be injurious to operator and persons in the work area. Before operating, read and understand the manufacturer's instructions and know your employer's safety practices. 		Pour votre protection et celle des autres, lire et comprendre ces consignes. <ul style="list-style-type: none"> Couper l'alimentation avant d'effectuer le dépannage. Couper l'alimentation avant de démonter la torche. Utiliser exclusivement les torches indiquées dans le manuel d'instructions. Le raccordement au réseau de cette machine de coupage à arc-plasma doit être conforme aux codes de l'électricité pertinents. Le coupage à arc-plasma comporte des risques pour l'utilisateur et les personnes se trouvant dans la zone de travail. Avant le coupage, lire et comprendre les instructions du fabricant. Appliquer également les consignes de sécurité de votre entreprise. 					
 Electric shock can kill. <ul style="list-style-type: none"> Do not touch live electrical parts. Keep all panels and covers in place when the machine is connected to a power source. Insulate yourself from work and ground: wear insulating gloves, shoes and clothing. Keep gloves, shoes, clothing, work area, torch and this machinery dry. 	 Fumes and gases can injure your health. <ul style="list-style-type: none"> Keep your head out of the fumes. Provide ventilation, exhaust at the arc, or both to keep the fumes and gases from your breathing zone and the general area. If ventilation is inadequate, use an approved respirator. 	WARNING: This product, when used for welding or cutting, produces fumes or gases which contain chemicals known to the state of California to cause birth defects and, in some cases, cancer.					
 Explosion will result if pressurized containers are cut.	 Heat, splatter and sparks cause fire and burns. <ul style="list-style-type: none"> Do not cut near combustible material. Do not cut containers that have held combustibles. Do not have on your person any combustibles such as a butane lighter or matches. 	Pilot arc can cause burns. <ul style="list-style-type: none"> Keep the torch nozzle away from yourself and others when the switch is depressed. Wear correct eye and body protection. 					
 Arc rays can injure eyes and burn skin. <ul style="list-style-type: none"> Wear correct eye and body protection. 							
 Noise can damage hearing. <ul style="list-style-type: none"> Wear correct ear protection. 							
DO NOT REMOVE THIS MARKING		NE PAS ENLEVER CET AVIS					
! WARNING		! AVERTISSEMENT					
INSTANT START Arc starts instantly after torch switch is depressed.		AMORÇAGE INSTANTANÉ L'arc s'amorce aussitôt qu'on enclenche l'interrupteur de la torche.					
 1	 1.1	 1.2	 1.3	 4	 4.1	 4.2	 4.3
 2	 2.1	 2.2	 2.3	 5	 5.1		
 3	 3.1	 3.2	 3.3	 6			
110391 Rev A							

1. Les étincelles produites par le coupage peuvent provoquer une explosion ou un incendie.
 - 1.1 Pendant le coupage, éloigner toute matière inflammable.
 - 1.2 Conserver un extincteur à proximité et s'assurer qu'une personne soit prête à l'utiliser.
 - 1.3 Ne jamais couper de récipients fermés.
2. L'arc plasma peut provoquer des blessures et des brûlures.
 - 2.1 Couper l'alimentation avant de démonter la torche.
 - 2.2 Ne pas tenir la surface à couper près de la trajectoire de coupe.
 - 2.3 Porter des vêtements de protection couvrant tout le corps.
3. Un choc électrique causé par la torche ou les câbles peut être fatal. Se protéger contre les risques de chocs électriques.
 - 3.1 Porter des gants isolants. Ne pas porter de gants mouillés ou abîmés.
 - 3.2 S'isoler de la surface de travail et du sol.
 - 3.3 Débrancher la prise ou la source de courant avant de manipuler l'équipement.
4. L'inhalation des vapeurs produites par le coupage peut être dangereuse pour la santé.
 - 4.1 Garder le visage à l'écart des vapeurs.
 - 4.2 Utiliser un système de ventilation par aspiration ou d'échappement localisé pour dissiper les vapeurs.
 - 4.3 Utiliser un ventilateur pour dissiper les vapeurs.
5. Les rayons de l'arc peuvent brûler les yeux et provoquer des lésions de la peau.
 - 5.1 Porter un casque et des lunettes de sécurité. Se protéger les oreilles et porter une chemise dont le col peut être déboutonné. Porter un casque de soudure dont la protection filtrante est suffisante. Porter des vêtements protecteurs couvrant la totalité du corps.
6. Se former à la technique du coupage et lire les instructions avant de manipuler l'équipement ou de procéder au coupage.
7. Ne pas retirer ou peindre (recouvrir) les étiquettes de sécurité.

Sección 1b

SEGURIDAD

En esta sección:

Reconocimiento de información de seguridad.....	1b-2
Siga las instrucciones de seguridad	1b-2
Peligro...Advertencia...Precaución	1b-2
Los cortes pueden provocar incendios o explosiones	1b-2
Prevención ante el fuego, Prevención ante explosiones	1b-2
Peligro de explosión argón-hidrógeno y metano.....	1b-2
Detonación de hidrógeno con el corte de aluminio	1b-2
El choque eléctrico puede provocar la muerte	1b-3
Prevención ante el electrochoque	1b-3
Los cortes pueden producir humos tóxicos	1b-3
El arco de plasma puede causar lesiones y quemaduras	1b-4
Antorchas de encendido instantáneo.....	1b-4
Los rayos del arco pueden producir quemaduras en los ojos y en la piel	1b-4
Protección para los ojos, Protección para la piel, Área de corte.....	1b-4
Seguridad de toma a tierra	1b-4
Cable de trabajo, Mesa de trabajo, Potencia primaria de entrada.....	1b-4
Seguridad de los equipos de gas comprimido	1b-5
Los cilindros de gas pueden explotar si están dañados	1b-5
El ruido puede deteriorar la audición	1b-5
Operación de marcapasos y de audífonos	1b-5
Un arco plasma puede dañar tubos congelados	1b-5
Etiqueta de advertencia	1b-6



RECONOCIMIENTO DE INFORMACIÓN DE SEGURIDAD

Los símbolos que se muestran en esta sección se utilizan para identificar los posibles peligros. Cuando vea un símbolo de seguridad en este manual o en su máquina, recuerde que existe la posibilidad de que se produzcan lesiones personales y siga las instrucciones correspondientes para evitar el peligro.



SIGA LAS INSTRUCCIONES DE SEGURIDAD

Lea atentamente todos los mensajes de seguridad de este manual y las etiquetas de seguridad en su máquina.

- Mantenga las etiquetas de seguridad de su máquina en buen estado. Reemplace las etiquetas que se pierdan o se dañen inmediatamente.
- Aprenda a utilizar la máquina y a utilizar los controles de la manera correcta. No permita que sea utilizada por alguien que no conozca su funcionamiento.

- Mantenga su máquina en buenas condiciones de funcionamiento. La realización de modificaciones no autorizadas a la máquina puede comprometer la seguridad y la vida útil de la máquina.

PELIGRO ADVERTENCIA PRECAUCIÓN

Las palabras PELIGRO y ADVERTENCIA se utilizan conjuntamente con un símbolo de seguridad. La palabra PELIGRO se utiliza para identificar los mayores peligros.

- Encontrará etiquetas de seguridad con las inscripciones PELIGRO y ADVERTENCIA en su máquina, junto a peligros específicos.
- En este manual, la palabra ADVERTENCIA va seguida de instrucciones que, si no se siguen correctamente, pueden provocar lesiones e inclusive la muerte.
- En este manual, la palabra PRECAUCIÓN va seguida de instrucciones que, si no se siguen correctamente, pueden provocar daños en el equipo.



LOS CORTES PUEDEN PROVOCAR INCENDIOS O EXPLOSIONES

Prevención ante el fuego

- Asegúrese de que el área sea segura antes de proceder a cortar. Tenga a mano un extinguidor de incendios.
- Retire todos los materiales inflamables, colocándolos a por lo menos 10 metros del área de corte.
- Remoje los metales calientes o permita que se enfríen antes de que entren en contacto con materiales combustibles.
- Nunca corte depósitos que contengan materiales inflamables – primero es necesario vaciarlos y limpiarlos debidamente.
- Antes de realizar cortes en atmósferas potencialmente inflamables, asegúrese de ventilar bien.
- Al realizar cortes utilizando oxígeno como gas plasma, se requiere tener un sistema de ventilación de escape.

Prevención ante explosiones

- No corte en atmósferas que contengan polvo o vapores explosivos.
- No corte depósitos o tubos a presión ni cualquier depósito cerrado.
- No corte depósitos que hayan contenido materiales combustibles.



ADVERTENCIA

Peligro de explosión
Argón-Hidrógeno y metano

El hidrógeno y el metano son gases inflamables que suponen un peligro de explosión. Mantenga el fuego lejos de los cilindros y las mangueras que contengan mezclas de hidrógeno o metano. Mantenga la llama y las chispas lejos de la antorcha al utilizar metano o argón-hidrógeno como plasma.



ADVERTENCIA

Detonación de hidrógeno con
el corte de aluminio

- Al cortar aluminio bajo agua o con agua en contacto con el lado inferior del aluminio, puede acumularse gas hidrógeno bajo la pieza a cortar y detonar durante la operación de corte por plasma.
- Instale un múltiple de aireación en el fondo de la mesa de agua para eliminar la posibilidad de la detonación del hidrógeno. Consulte la sección del apéndice de este manual para conocer detalles acerca del múltiple de aireación.



EL CHOQUE ELÉCTRICO PUEDE PROVOCAR LA MUERTE

El contacto directo con piezas eléctricas conectadas puede provocar un electrochoque fatal o quemaduras graves.

- Al hacer funcionar el sistema de plasma, se completa un circuito eléctrico entre la antorcha y la pieza a cortar. La pieza a cortar es una parte del circuito eléctrico, como también cualquier cosa que se encuentre en contacto con ella.
- Nunca toque el cuerpo de la antorcha, la pieza a cortar o el agua en una mesa de agua cuando el sistema de plasma se encuentre en funcionamiento.

Prevención ante el electrochoque

Todos los sistemas por plasma de Hypertherm usan alto voltaje en el proceso de corte (son comunes los voltajes CD de 200 a 400). Tome las siguientes precauciones cuando se utiliza el equipo de plasma:

- Use guantes y botas aislantes y mantenga el cuerpo y la ropa secos.
- No se siente, se pare o se ponga sobre cualquier superficie húmeda cuando esté trabajando con el equipo.
- Aíslese eléctricamente de la pieza a cortar y de la tierra utilizando alfombrillas o cubiertas de aislamiento secas lo suficientemente grandes como para impedir todo contacto físico con la pieza a cortar o con la tierra. Si su única opción es trabajar en una área húmeda o cerca de ella, sea muy cauteloso.
- Instale un interruptor de corriente adecuado en cuanto a fusibles, en una pared cercana a la fuente de energía. Este interruptor permitirá al operador desconectar rápidamente la fuente de energía en caso de emergencia.
- Al utilizar una mesa de agua, asegúrese de que ésta se encuentre correctamente conectada a la toma a tierra.

- Instale este equipo y conéctelo a tierra según el manual de instrucciones y de conformidad con los códigos locales y nacionales.
- Inspeccione el cordón de alimentación primaria con frecuencia para asegurarse de que no esté dañado ni agrietado. Si el cordón de alimentación primaria está dañado, reemplácelo inmediatamente. **Un cable pelado puede provocar la muerte.**
- Inspeccione las mangueras de la antorcha y reemplácelas cuando se encuentren dañadas.
- No toque la pieza ni los recortes cuando se está cortando. Deje la pieza en su lugar o sobre la mesa de trabajo con el cable de trabajo conectado en todo momento.
- Antes de inspeccionar, limpiar o cambiar las piezas de la antorcha, desconecte la potencia primaria o desenchufe la fuente de energía.
- Nunca evite o descuide los bloqueos de seguridad.
- Antes de retirar la cubierta de una fuente de energía o del gabinete de un sistema, desconecte la potencia primaria de entrada. Espere 5 minutos después de desconectar la potencia primaria para permitir la descarga de los condensadores.
- Nunca opere el sistema de plasma sin que las tapas de la fuente de energía estén en su lugar. Las conexiones expuestas de la fuente de energía presentan un serio riesgo eléctrico.
- Al hacer conexiones de entrada, conecte el conductor de conexión a tierra en primer lugar.
- Cada sistema de plasma Hypertherm está diseñado para ser utilizado sólo con antorchas Hypertherm específicas. No utilice antorchas diferentes, que podrían recalentarse y ser peligrosas.



LOS CORTES PUEDEN PRODUCIR HUMOS TÓXICOS

Los cortes pueden producir gases y humos tóxicos que agotan el oxígeno y causan lesiones o inclusive la muerte.

- Mantenga el área de corte bien ventilada o utilice un respirador con suministro de aire aprobado.
- No realice sus cortes en sitios que se hallen cerca de operaciones de desengrasado, limpieza o aplicación de aerosoles. Los vapores de ciertos solventes clorados se descomponen y forman gas fosgeno al quedar expuestos a la radiación ultravioleta.
- No corte metales que contengan materiales tóxicos o que estén recubiertos con ellos, tales como el cinc (galvanizado), el plomo, el cadmio o el berilio, a menos

que el área se halle bien ventilada y el operador lleve puesto un respirador con suministro de aire. Los recubrimientos y todo metal que contenga estos elementos pueden producir gases o humos tóxicos al ser cortados.

- Nunca corte depósitos con materiales potencialmente tóxicos en su interior – primero es necesario vaciarlos y limpiarlos debidamente.
- Este producto, cuando se lo usa para soldar o cortar, produce humo y gases que se conocen en el estado de California como causantes de defectos de nacimiento, y en algunos casos, cáncer.



EL ARCO DE PLASMA PUEDE CAUSAR LESIONES Y QUEMADURAS

Antorchas de encendido instantáneo

El arco de plasma se enciende inmediatamente después de activarse el interruptor de la antorcha.

El arco de plasma puede cortar a través de guantes y de la piel con rapidez.

- Manténgase alejado de la punta de la antorcha.
- No sostenga el metal junto al trayecto de corte.
- Nunca apunte la antorcha hacia Ud. mismo o hacia otras personas.



LOS RAYOS DEL ARCO PUEDEN PRODUCIR QUEMADURAS EN LOS OJOS Y EN LA PIEL

Protección para los ojos Los rayos del arco de plasma producen rayos intensos visibles e invisibles (ultravioleta e infrarrojo) que pueden quemar los ojos y la piel.

- Utilice protección para los ojos de conformidad con los códigos locales o nacionales aplicables.
- Colóquese protectores para los ojos (gafas o anteojos protectores con protectores laterales, y bien un casco de soldar) con lentes con sombreado adecuado para proteger sus ojos de los rayos ultravioleta e infrarrojos del arco.

Protección para la piel Vista ropa de protección para proteger la piel contra quemaduras causadas por la radiación ultravioleta de alta intensidad, por las chispas y por el metal caliente:

- Guantes largos, zapatos de seguridad y gorro.
- Ropa de combustión retardada y que cubra todas las partes expuestas.
- Pantalones sin dobladillos para impedir que recojan chispas y escorias.
- Retire todo material combustible de los bolsillos, como encendedores a butano e inclusive cerillas, antes de comenzar a cortar.

Corriente del arco

Número del cristal

AWS (EE.UU.)	ISO 4850
No. 8	No. 11
No. 10	No. 11-12
No. 12	No. 13
No. 14	No. 14



Hasta 100A
100-200 A
200-400 A
Más de 400 A

Área de corte Prepare el área de corte para reducir la reflexión y la transmisión de la luz ultravioleta:

- Pinte las paredes y demás superficies con colores oscuros para reducir la reflexión.
- Utilice pantallas o barreras protectoras para proteger a los demás de los destellos.
- Advierta a los demás que no debe mirarse el arco. Utilice carteles o letreros.



SEGURIDAD DE TOMA A TIERRA

Cable de trabajo La pinza del cable de trabajo debe estar bien sujeta a la pieza y hacer un buen contacto de metal a metal con ella o bien con la mesa de trabajo. No conecte el cable con la parte que va a quedar separada por el corte.

Mesa de trabajo Conecte la mesa de trabajo a una buena toma de tierra, de conformidad con los códigos eléctricos nacionales o locales apropiados.

Potencia primaria de entrada

- Asegúrese de que el alambre de toma a tierra del cordón de alimentación está conectado al terminal de tierra en la caja del interruptor de corriente.
- Si la instalación del sistema de plasma supone la conexión del cordón de alimentación primaria a la fuente de energía, asegúrese de conectar correctamente el alambre de toma a tierra del cordón de alimentación primaria.
- Coloque en primer lugar el alambre de toma a tierra del cordón de alimentación primaria en el espárrago luego coloque cualquier otro alambre de tierra sobre el conductor de tierra del cable. Ajuste firmemente la tuerca de retención.
- Asegúrese de que todas las conexiones eléctricas están firmemente realizadas para evitar sobrecalentamientos.

SEGURIDAD DE LOS EQUIPOS DE GAS COMPRIMIDO

- Nunca lubrique reguladores o válvulas de cilindros con aceite o grasa.
- Utilice solamente cilindros, reguladores, mangueras y conectores de gas correctos que hayan sido diseñados para la aplicación específica.
- Mantenga todo el equipo de gas comprimido y las piezas relacionadas en buen estado.
- Coloque etiquetas y códigos de color en todas las mangueras de gas para identificar el tipo de gas que conduce cada una. Consulte los códigos locales o nacionales aplicables.



LOS CILINDROS DE GAS PUEDEN EXPLOTAR SI ESTÁN DAÑADOS

Los cilindros de gas contienen gas bajo alta presión. Un cilindro dañado puede explotar.

- Manipule y utilice los cilindros de gas comprimido de acuerdo con los códigos locales o nacionales aplicables.
- No use nunca un cilindro que no esté de pie y bien sujeto.
- Mantenga la tapa de protección en su lugar encima de la válvula, excepto cuando el cilindro se encuentre en uso o conectado para ser utilizado.
- No permita nunca el contacto eléctrico entre el arco de plasma y un cilindro.
- No exponga nunca los cilindros a calor excesivo, chispas, escorias o llamas.
- No emplee nunca martillos, llaves u otro tipo de herramientas para abrir de golpe la válvula del cilindro.



EL RUIDO PUEDE DETERIORAR LA AUDICIÓN

La exposición prolongada al ruido propio de las operaciones de corte y ranurado puede dañar la audición.

- Utilice un método de protección de los oídos aprobado al utilizar el sistema de plasma.
- Advierta a las demás personas que se encuentren en las cercanías acerca del peligro que supone el ruido excesivo.



OPERACIÓN DE MARCAPASOS Y DE AUDÍFONOS

Los campos magnéticos producidos por las elevadas corrientes pueden afectar la operación de marcapasos y de audífonos. Las personas que lleven marcapasos y audífonos deberán consultar a un médico antes de acercarse a sitios donde se realizan operaciones de corte y ranurado por plasma.

Para reducir los peligros de los campos magnéticos:

- Mantenga el cable de trabajo y la manguera de la antorcha a un lado, lejos del cuerpo.
- Dirija la manguera antorcha lo más cerca posible del cable de trabajo.
- No envuelva el cable de trabajo ni la manguera de la antorcha en su cuerpo.
- Manténgase tan lejos de la fuente de energía como sea posible.

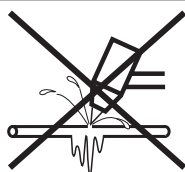





























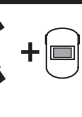

UN ARCO PLASMA PUEDE DAÑAR TUBOS CONGELADOS

Se puede hacer daño a los tubos congelados, o se los puede reventar, si uno trata de descongelarlos con una antorcha por plasma.

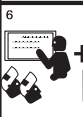
Etiqueta de advertencia

Esta etiqueta de advertencia se encuentra adherida a la fuente de energía. Es importante que el operador y el técnico de mantenimiento comprendan el sentido de estos símbolos de advertencia según se describen. El texto numerado corresponde a los cuadros numerados de la etiqueta.

! WARNING		! AVERTISSEMENT					
Protect yourself and others. Read and understand this marking. <ul style="list-style-type: none"> Disconnect power source before servicing. Disconnect power source before disassembly of the torch. Use torches specified in the instruction manual. This plasma cutting machine must be connected to power source in accordance with applicable electrical codes. Plasma arc cutting can be injurious to operator and persons in the work area. Before operating, read and understand the manufacturer's instructions and know your employer's safety practices. 		Pour votre protection et celle des autres, lire et comprendre ces consignes. <ul style="list-style-type: none"> Couper l'alimentation avant d'effectuer le dépannage. Couper l'alimentation avant de démonter la torche. Utiliser exclusivement les torches indiquées dans le manuel d'instructions. Le raccordement au réseau de cette machine de coupage à arc-plasma doit être conforme aux codes de l'électricité pertinents. Le coupage à arc-plasma comporte des risques pour l'utilisateur et les personnes se trouvant dans la zone de travail. Avant le coupage, lire et comprendre les instructions du fabricant. Appliquer également les consignes de sécurité de votre entreprise. 					
 <p>Electric shock can kill.</p> <ul style="list-style-type: none"> Do not touch live electrical parts. Keep all panels and covers in place when the machine is connected to a power source. Insulate yourself from work and ground: wear insulating gloves, shoes and clothing. Keep gloves, shoes, clothing, work area, torch and this machinery dry. 	 <p>Fumes and gases can injure your health.</p> <ul style="list-style-type: none"> Keep your head out of the fumes. Provide ventilation, exhaust at the arc, or both to keep the fumes and gases from your breathing zone and the general area. If ventilation is inadequate, use an approved respirator. 	<p>WARNING: This product, when used for welding or cutting, produces fumes or gases which contain chemicals known to the state of California to cause birth defects and, in some cases, cancer.</p>					
 <p>Explosion will result if pressurized containers are cut.</p>	 <p>Heat, splatter and sparks cause fire and burns.</p> <ul style="list-style-type: none"> Do not cut near combustible material. Do not cut containers that have held combustibles. Do not have on your person any combustibles such as a butane lighter or matches. 	<p>Pilot arc can cause burns.</p> <ul style="list-style-type: none"> Keep the torch nozzle away from yourself and others when the switch is depressed. Wear correct eye and body protection. 					
 <p>Arc rays can injure eyes and burn skin.</p> <ul style="list-style-type: none"> Wear correct eye and body protection. 							
 <p>Noise can damage hearing.</p> <ul style="list-style-type: none"> Wear correct ear protection. 							
DO NOT REMOVE THIS MARKING		NE PAS ENLEVER CET AVIS					
! WARNING		! AVERTISSEMENT					
INSTANT START Arc starts instantly after torch switch is depressed.		AMORÇAGE INSTANTANÉ L'arc s'amorce aussitôt qu'on enclenche l'interrupteur de la torche.					
							
							
							
110391 Rev A							

1. Las chispas producidas por el corte pueden causar explosiones o incendios.
 - 1.1 Mantenga los materiales inflamables lejos del lugar de corte.
 - 1.2 Tenga a mano un extinguidor de incendios y asegúrese de que alguien esté preparado para utilizarlo.
 - 1.3 No corte depósitos cerrados.
2. El arco de plasma puede causar quemaduras y lesiones.
 - 2.1 Apague la fuente de energía antes de desarmar la antorcha.
 - 2.2 No sostenga el material junto al trayecto de corte.
 - 2.3 Proteja su cuerpo completamente.
3. Los electrochoques provocados por la antorcha o el cableado pueden ser fatales. Protéjase del electrochoque.
 - 3.1 Colóquese guantes aislantes. No utilice guantes dañados o mojados.
 - 3.2 Aíslese de la pieza de trabajo y de la tierra.
 - 3.3 Antes de trabajar en una máquina, desconecte el enchufe de entrada o la potencia primaria.
4. La inhalación de los humos provenientes del área de corte puede ser nociva para la salud.
 - 4.1 Mantenga la cabeza fuera de los gases tóxicos.
 - 4.2 Utilice ventilación forzada o un sistema local de escape para eliminar los humos.
 - 4.3 Utilice un ventilador para eliminar los humos.
5. Los rayos del arco pueden producir quemaduras en los ojos y en la piel.
 - 5.1 Utilice un sombrero y gafas de seguridad. Utilice protección para los oídos y abróchese el botón del cuello de la camisa. Utilice un casco de soldar con el filtro de sombreado adecuado. Proteja su cuerpo completamente.
6. Antes de trabajar en la máquina o de proceder a cortar, capacítese y lea las instrucciones completamente.
7. No retire las etiquetas de advertencia ni las cubra con pintura.

Section 2

SPECIFICATIONS

In this section:

Power supply	2-2
Dimensions and weight	2-3
T80 torches	2-4
Dimensions	2-5
Symbols and markings	2-6
[S] Mark	2-6
IEC symbols	2-6

SPECIFICATIONS

Power supply

Rated open circuit voltage (U_0)	300 VDC		
Output characteristic* *Defined as a plot of output voltage versus output current	Drooping		
Rated output current (I_2)	25A – 80A		
Hypertherm standard rated output voltage (U_2)	150 VDC		
Duty cycle (X^*) at 104°F (40°C) at rated conditions (U_1, I_1, U_2, I_2) * $X = T_{on}/T_{base}$, T_{on} = time, minutes T_{base} = 10 minutes	U_1 – Volts AC rms	X	
	200-208 VAC 1PH	40%	
	230-240 VAC 1PH	50%	
	480 VAC 1PH	60%	
	200-208 VAC 3PH	50%	
	230-240 VAC 3PH	60%	
	380/400/415 VAC 3PH	60%	
	480 VAC 3PH	60%	
600 VAC 3PH	60%		
Operating temperature	14° to 104° F (-10° to 40° C)		
Rated AC phases (PH) and line frequency (Hz) Standard model CE model	PH	Hz	
	1-3	50-60	
	3	50-60	
Rated input voltage (U_1), rated input current (I_1) and I_{1eff} * at rated output U_2 and I_2 – cutting only. * $I_{1eff} = (I_1) \sqrt{X}$ used to determine rating of power cord.	U_1 – Volts AC rms	I_1 -Amps rms	I_{1eff}
	200-208 VAC 1PH	70	44
	230-240 VAC 1PH	60	42
	480 VAC 1PH	30	23
	200-208 VAC 3PH	40	28
	230-240 VAC 3PH	36	28
	380/400/415 VAC 3PH	21	16
	480 VAC 3PH	17	13
600 VAC 3PH	16.5	13	
Power factor	U_1 – Volts AC rms	Harmonic power factor	Displacement power factor
	200-208 VAC 1PH	0.99	0.99
	230-240 VAC 1PH	0.99	0.99
	480 VAC 1PH	0.91	0.99
	200-208 VAC 3PH	0.94	0.99
	230-240 VAC 3PH	0.94	0.99
	380/400/415 VAC 3PH	0.94	0.99
	480 VAC 3PH	0.94	0.99
600 VAC 3PH	0.80	0.99	
R_{sce} – short circuit ratio—CE model only	U_1 – Volts AC rms, 3PH	R_{sce}	
	400 VAC	228	
	230 VAC	163	
<i>This equipment conforms to IEC 61000-3-12, provided that $R_{sce\ min} = 228$ at 400VAC 3PH and 163 at 230 VAC 3PH.</i>			
IP code—degree of protection provided by enclosure	IP23CS* IP – “International Protection” 2 – No ingress foreign objects ≥ 12.5 mm (0.5 in) 3 – No harmful ingress spraying water C – AC line circuits protected against ingress of tool ≥ 2.5 mm dia. x 100 mm long (0.1 inch x 4.0 inch) S – fan stationary during water test * WARNING: DO NOT OPERATE IN THE RAIN		
Toppling, tilting (with or without wheel kit)	Up to a 15° incline		
Gas type	Air Nitrogen		
Gas quality	Clean, moisture-free, oil-free		
Gas inlet pressure and flow	90 psig (6.1 bar) 400 scfh/6.7 scfm (189 l/min)		

Dimensions and weight

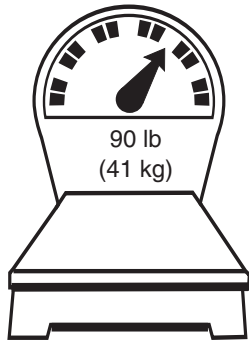

Weight of power supply without torch

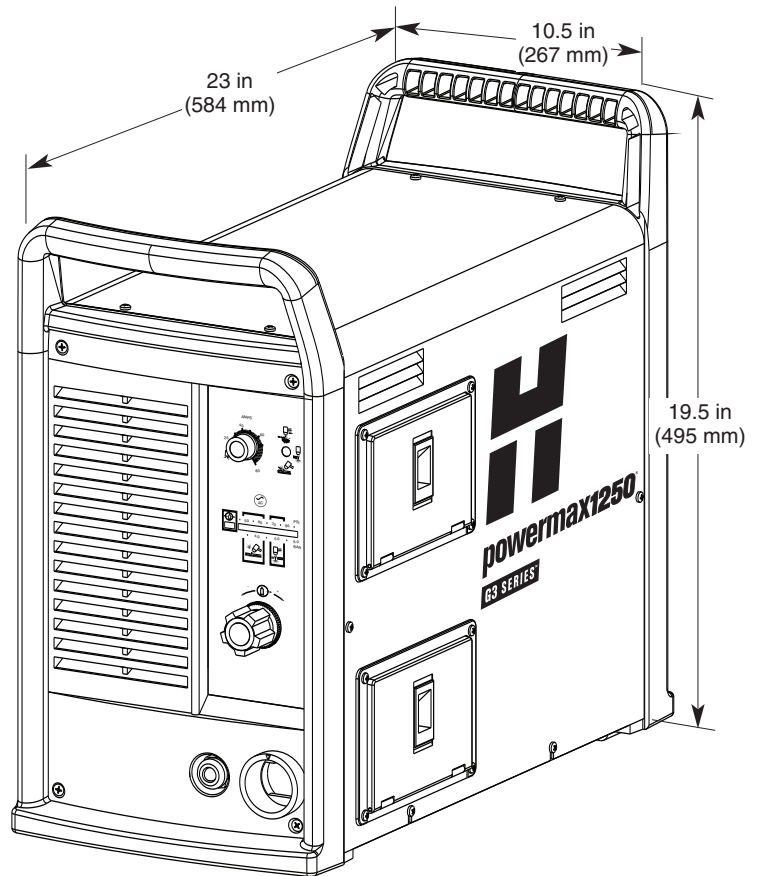

SPECIFICATIONS

T80 torches

Handheld cutting capacity at 80 amps	
Recommended capacity	7/8 inch (22 mm)
Maximum capacity	1-1/8 inch (29 mm)
Severance capacity	1-1/2 inch (38 mm)
Mechanized cutting capacity at 80 amps	
Recommended capacity	3/8 inch (10 mm)
Maximum capacity	5/8 inch (16 mm)
Gouging capability (metal removal rate on mild steel)	12.2 pounds (5.5 kg) / hour
Weight	
T80	7.2 pounds (3.3 kg) with 25 ft (7.5 m) lead 13.9 pounds (6.3 kg) with 50 ft (15 m) lead 20.6 pounds (9.4 kg) with 75 ft (22.5 m) lead
T80M	4.5 pounds (2.0 kg) with 15 ft (4.5 m) lead 8.3 pounds (3.8 kg) with 25 ft (7.5 m) lead 9.9 pounds (4.5 kg) with 35 ft (10.7 m) lead 15.0 pounds (6.8 kg) with 50 ft (15 m) lead 21.7 pounds (9.9 kg) with 75 ft (22.5 m) lead

Dimensions

T80 hand torch dimensions

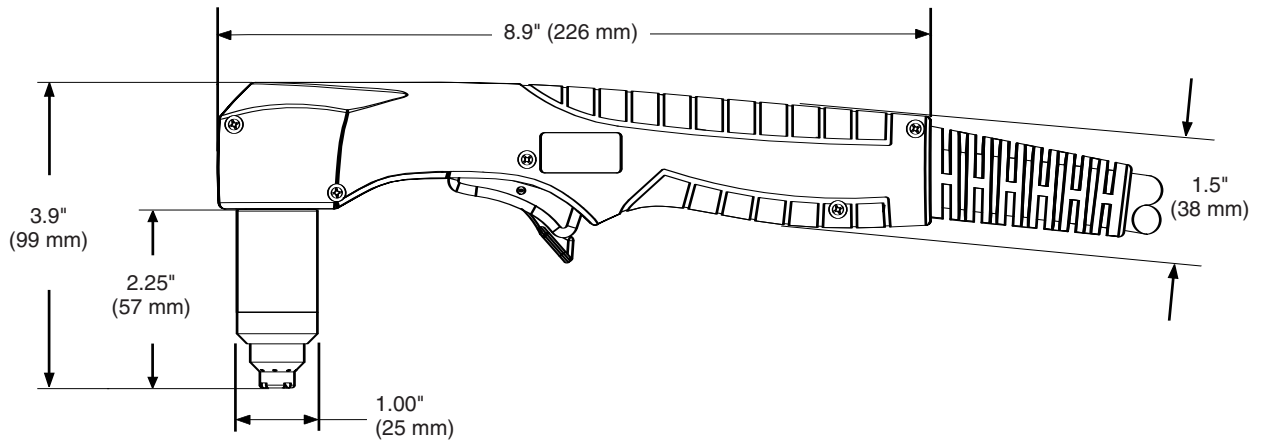

T80M machine torch dimensions

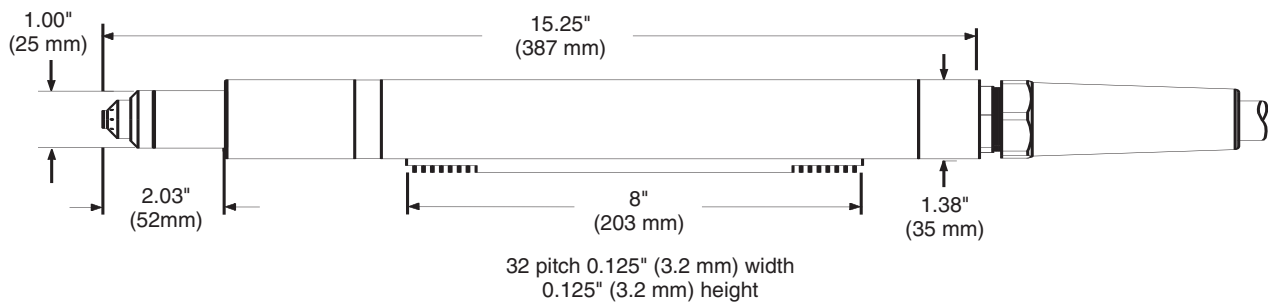











Symbols and markings

S Mark

The **S** mark indicates that the power supply and torch are suitable for use in environments with increased hazard of electrical shock. The hand torches must have shielded consumable parts to maintain **S** mark compliance.

IEC symbols

The following symbols may appear on the power supply data plate, control labels and switches.

	Direct current (DC)		An inverter-based power source
	Alternating current (AC)		Plasma torch in the TEST position (cooling and cutting gas exiting nozzle)
	Plasma torch cutting and gouging		Power is ON
	AC input power connection		Power is OFF
	The terminal for the external protective (earth) conductor		Volt/amp curve, "drooping" characteristic

In this section

Controls and indicators	3-3
Indicator LEDs.....	3-3
Theory of operation.....	3-4
General	3-4
Functional description	3-4
Sequence of operation	3-5
Troubleshooting preparation	3-6
Test equipment.....	3-6
Troubleshooting procedures and sequence	3-6
External inspection.....	3-6
Internal inspection	3-7
Initial resistance check.....	3-7
Check the power switch	3-8
Hypertherm IGBT tester	3-9
Indicator LEDs and device tests	3-9
IGBT test preparation	3-10
IGBT device test using the Hypertherm tester	3-10
Troubleshoot the Hypertherm IGBT tester	3-11
Schematic for building an IGBT tester.....	3-11
IGBT device test using a non-Hypertherm tester	3-12
Troubleshooting guide	3-14
Control board LEDs.....	3-20
Test 1 – voltage input	3-22
Test 2 – voltage balance	3-23
Test 3 – output diodes	3-24
Test 4 – pilot arc IGBT (Q8)	3-25
Test 5 – inverter IGBT (Q6) and PFC IGBT (Q7)	3-26
Test 6 – flyback circuit	3-27
Test 7 – torch stuck open (TSO)	3-28
Test 8 – plasma start	3-29
Test 9 – torch cap sensor	3-29
Test 10 – gas solenoid	3-30
Test 11 – incoming line voltage (VACR)	3-30
Test 12 – pressure switch.....	3-30
Test 13 – fan.....	3-30

MAINTENANCE

Test 14 – AUX switch	3-31
Test 15 – flyback circuit failure	3-31
T60 hand torch: connector pinout diagrams and assembly	3-32
T60M machine torch: connector pinout diagrams and assembly	3-33
Component replacement	3-34
Power cord replacement	3-34
Torch replacement.....	3-35
Filter element replacement.....	3-37
Work cable replacement	3-38
Capacitor replacement.....	3-39
Power board removal and replacement.....	3-40
Heat sink component replacement.....	3-43

Controls and indicators

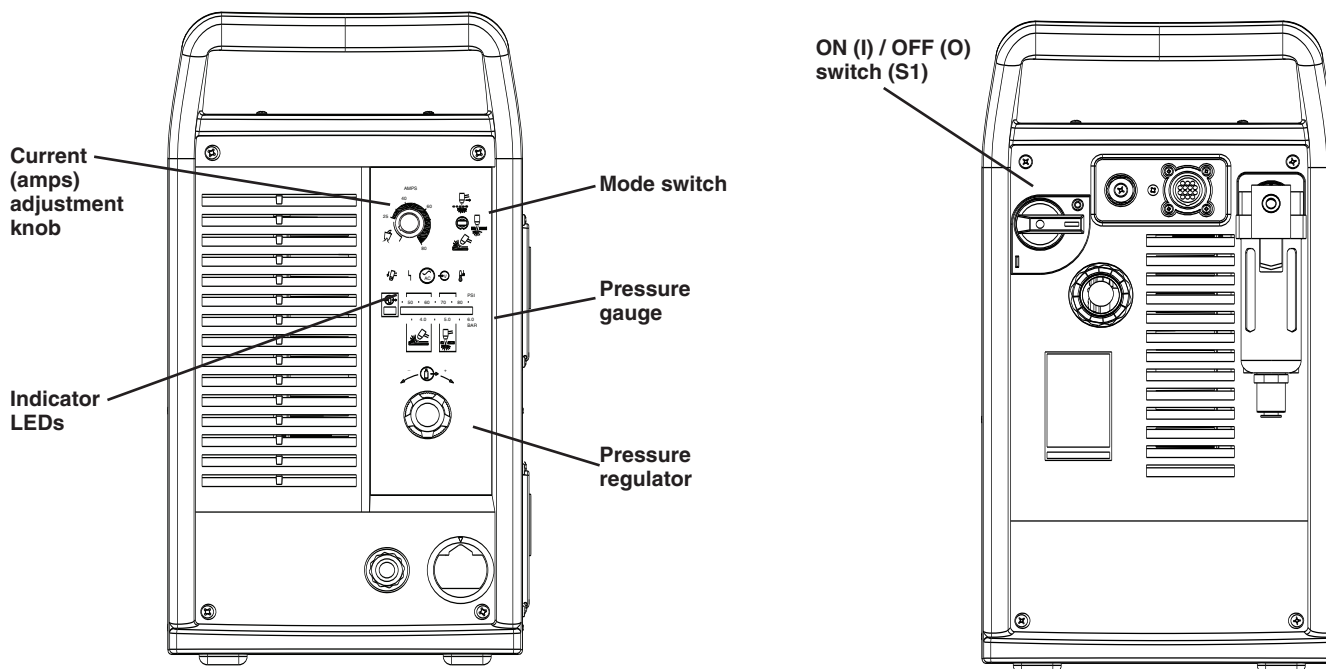

Indicator LEDs



Green power ON LED

When illuminated, indicates that power is applied to the system and the power switch is ON (I).

Gas pressure LED

Yellow: When flashing, indicates that the gas pressure is below 60 psig (4.1 bar) for cutting, or 40 psig (2.8 bar) for gouging.



Green: When illuminated, indicates that there is acceptable gas pressure for torch operation.
Note: This LED should illuminate when the power is ON (I).



Yellow torch cap LED

When illuminated, indicates that the retaining cap is loose or not installed.

Note: Turn OFF (O) the power, correct this fault condition, then turn ON (I) the power to extinguish the LED.



Yellow temperature LED

When illuminated, indicates that the power supply's temperature is too hot.



Red fault LED

When illuminated, indicates that a fault condition exists, which prevents system operation.



Yellow low line voltage LED

When illuminated, indicates that line voltage is below 170 VAC or above 680 VAC. On CE units, it can also indicate a missing phase.

Theory of operation

General

Refer to the *Functional description* and *Sequence of operation* sections below, and to Section 6, *Wiring diagrams*.

Functional description

AC power enters the system through the power switch (S1) to the input diode bridge (D24). The voltage from the diode bridge supplies the power factor correction (PFC) boost converter, which provides a 750 VDC bus voltage. The bus voltage then supplies voltage and current to the inverter and the flyback circuit power supply (DC to DC converter) on the power board (PCB2). The power board provides noise suppression and spike protection. A “soft start” is implemented via the power board resistor and relay (K1).

The PFC boost converter consists of an isolated gate bipolar transistor (IGBT Q7), choke and control circuit. It provides a 750 VDC bus voltage when the input AC voltage is between 170 and 540 VAC. When the input voltage is above 540 VAC the bus voltage will rise to $(V_{in})(\sqrt{2})$.

The inverter consists of an IGBT (Q6), the power transformer (T2), a current sense transformer and sections of the power board. The inverter operates as a pulse-width, modulator-controlled bridge circuit that is rectified by the output diode.

The output circuitry consists of 2 current-transfer sensors located on the power board, the pilot arc IGBT (Q8) and the output choke.

The control board's microprocessor monitors and regulates the system's operation and safety circuits. The current adjustment knob is used to set to the current to the desired value. The system compares the set-point to the output current by monitoring the current sensor and adjusting the pulse-width output of the inverter IGBT (Q6).

The control board (PCB3) includes a control switch for the pilot arc, which allows the operator to turn ON the pilot arc (useful when cutting expanded metal), turn OFF the pilot arc (for maximum life of consumables), or to increase the pilot arc to 20A (useful for gouging or non-transferred-arc cutting).

Sequence of operation

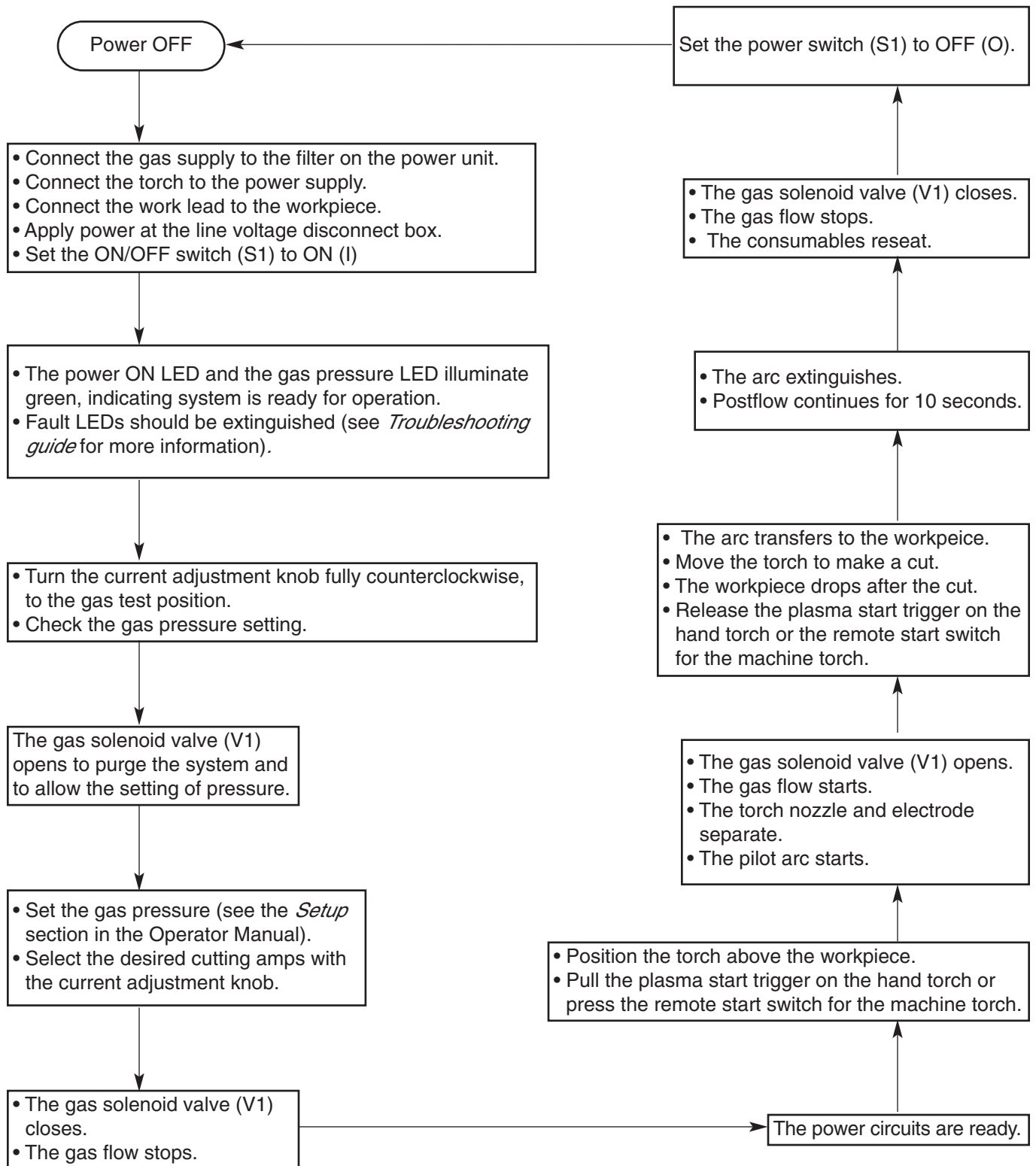

Troubleshooting preparation

The complexity of the circuits requires that service technicians have a working knowledge of inverter power supply theory. In addition to being technically qualified, technicians must perform all testing with safety in mind.

If questions or problems arise during servicing, call the nearest Hypertherm Technical Services Department listed in the front of this manual.

Test equipment

- Multimeter
- IGBT tester (part number 128883)

Troubleshooting procedures and sequence

When performing the troubleshooting procedures,





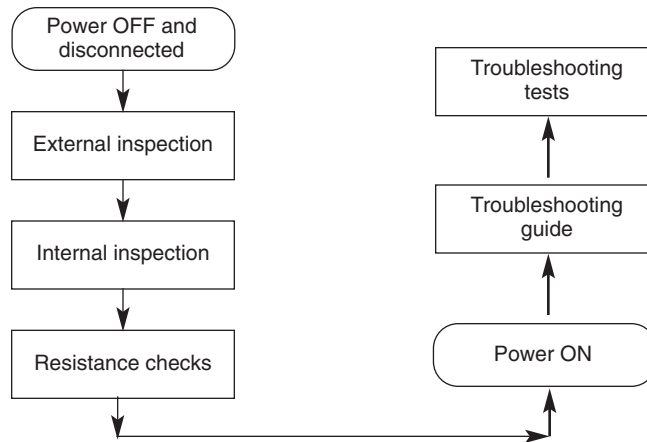

- Refer to Section 6 for the system wiring diagram;
- Refer to Section 4 to locate power supply components;
- Refer to Section 5 for torch components.

After the problem has been located and repaired, refer to the *Sequence of Operation* flow diagram in this section to test the power supply for proper operation.



External inspection

1. Inspect the exterior of the power supply for damage to the cover and external components.
2. Inspect the torch and the torch lead for damage.

 <h2 style="margin: 0;">DANGER</h2>	
 	<p>ELECTRIC SHOCK CAN KILL</p> <ul style="list-style-type: none"> • Turn off the power and remove the input power plug from its receptacle before removing the cover from the power supply. If the power supply is directly connected to a line disconnect box, switch the line disconnect to OFF (O). In the U.S., use a “lock-out / tag-out” procedure until the service or maintenance work is complete. In other countries, follow appropriate national or local safety procedures. • Do not touch live electrical parts! If power is required for servicing, use extreme caution when working near live electrical circuits. Dangerous voltages exist inside the power supply that can cause serious injury or death. • Do not attempt to repair the power board or control board. Do not cut away or remove any protective conformal coating from either board. To do so will risk a short circuit between the AC input circuit and the output circuit and may result serious injury or death.
	<p>HOT PARTS CAN CAUSE SEVERE BURNS</p> <ul style="list-style-type: none"> • Allow the power supply to cool before servicing.
	<p>MOVING BLADES CAN CAUSE INJURY</p> <ul style="list-style-type: none"> • Keep hands away from moving parts.
	<p>STATIC ELECTRICITY CAN DAMAGE CIRCUIT BOARDS</p> <ul style="list-style-type: none"> • Use proper precautions when handling printed circuit boards. <ul style="list-style-type: none"> – Wear a grounded wrist strap when handling PC boards. – Store PC boards in anti-static containers.

Internal inspection

1. Set the ON/OFF switch (S1) to O (OFF), unplug the power cord and disconnect the gas supply.
2. Remove the cover of the power supply by removing the 12 securing screws.
3. Inspect the inside of the power supply, especially on the side with the power board. Look for broken or loose wiring connections, burn and char marks, damaged components and so on. Repair or replace as necessary.

Initial resistance check

All resistance values must be taken with the power cord disconnected and all internal power supply wires attached. Perform the steps in *Internal inspection* before continuing in this section.

- If the resistance values are not close ($\pm 25\%$) to the values given in this section, isolate the problem by removing wires attached to the resistance check points or component until the problem is found.
- After the problem has been located and repaired, refer to the *Sequence of operation* flow diagram in this section to test the power supply for proper operation.

Check the power switch

1. With the power disconnected, set the ON/OFF switch (S1) to ON (I).
2. Check the resistance across the input leads.
3. Check the resistance from the input leads to ground.

Notes: With the power disconnected and the ON/OFF switch (S1) set to OFF (O), all circuits should read as open. All electrical values shown are $\pm 25\%$.

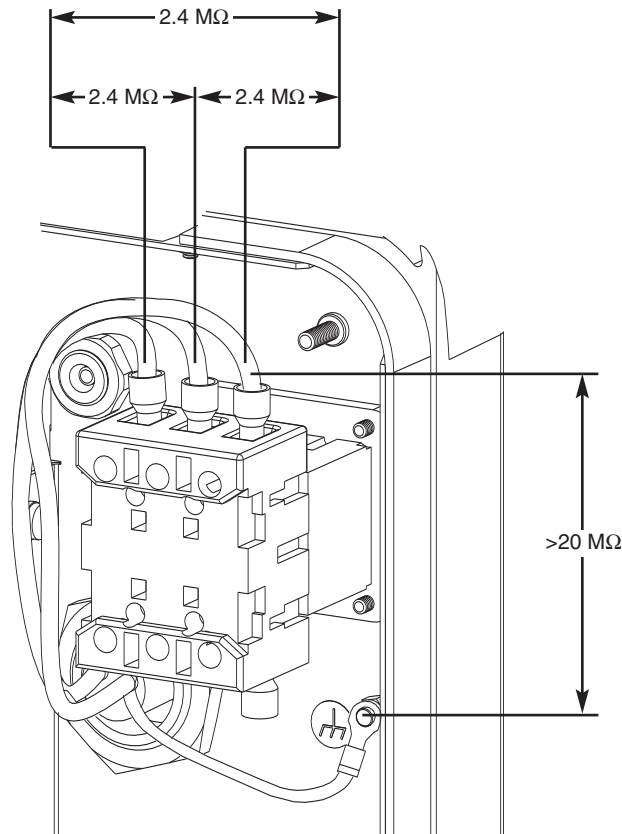

If no problems were found during the inspection or the initial resistance check, and the power supply still does not operate correctly, see the *Troubleshooting guide*.

Note: The *Troubleshooting guide* provides most probable causes and solutions. Study the system wiring diagram and understand the theory of operation before troubleshooting. Before purchasing a major replacement component, verify the problem with Hypertherm Technical Service or the nearest Hypertherm repair facility.

Hypertherm IGBT tester

Use the Hypertherm IGBT tester (part number 128883) as described in the following sections or assemble your own IGBT tester from the schematic diagram shown in *IGBT tester schematic* and use it to test the IGBTs.

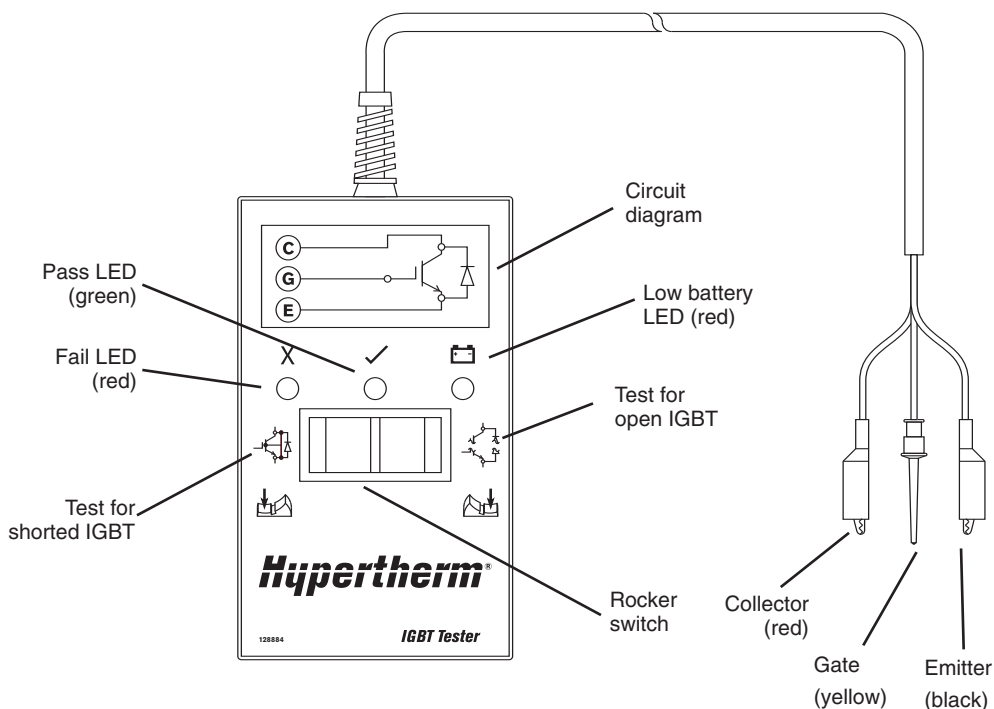

Indicator LEDs and device tests

- ✓ **Green “pass” LED**
When illuminated, this LED indicates that the IGBT passed the test for an open IGBT when switch is pressed to the right or for a short-circuited IGBT when switch is pressed to the left.
- X **Red “fail” LED**
When illuminated, this LED indicates that the IGBT failed the test for an open IGBT when switch is pressed to the right or for a short-circuited IGBT when switch is pressed to the left.
- 🔋 **Red “low battery” LED**
When illuminated, this LED indicates that the remaining voltage in the battery is insufficient to power the test circuitry. Replace the battery.

Note: The Hypertherm IGBT tester requires a minimum of 8V to power its circuitry properly.

IGBT test preparation

Before testing with the Hypertherm IGBT tester, connect the colored leads to the IGBT as shown on the next page.

Note: Before an IGBT can be tested, it must be electrically isolated from all circuits. If the IGBT is installed in a power supply, remove the power board and any lead connections before testing.



Caution: Failure to isolate the IGBT may result in false readings and/or damage to the IGBT tester.

The illustrations below depict three common configurations of an IGBT. Each connection on the IGBT will be labeled with an abbreviation. They may be labeled as C, E, G or 1, 2, 3 with a schematic that shows numbers and pin functions.

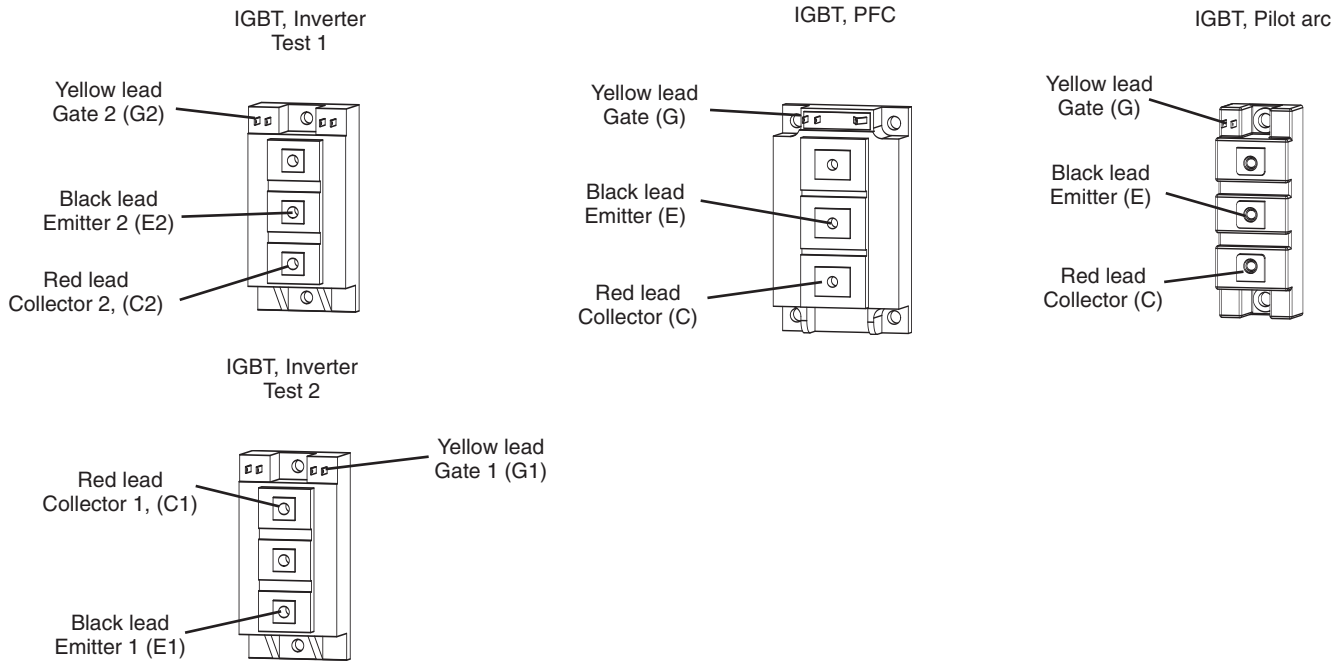

IGBT device test using the Hypertherm tester

Using the Hypertherm IGBT tester, press and hold the switch in the desired position to perform each test described in the following table.

Switch position	LED			This may mean	Corrective action
	Fail	Pass	Battery		
Left	X	–	–	IGBT is short-circuited	Replace IGBT
Left	–	X	–	IGBT passed the short-circuit test	None
Left	–	–	X	Battery below 8V	Replace battery
Left	–	–	–	Dead battery	Replace battery
Right	X	–	–	IGBT is open	Replace IGBT
Right	–	X	–	IGBT passed the open test	None
Right	–	–	X	Battery below 8V	Replace battery
Right	–	–	–	Dead battery	Replace battery

Troubleshoot the Hypertherm IGBT tester

1. Inspect the leads and the IGBT tester for damage.
2. Verify that the battery voltage is greater than 8V.
3. Test the IGBT Tester, itself, as shown below. If the results do not match the table, replace the lead connections.



Connect leads	Short test	Open test
None	Pass	Fail
Red to Black	Fail	Pass

Schematic for building an IGBT tester

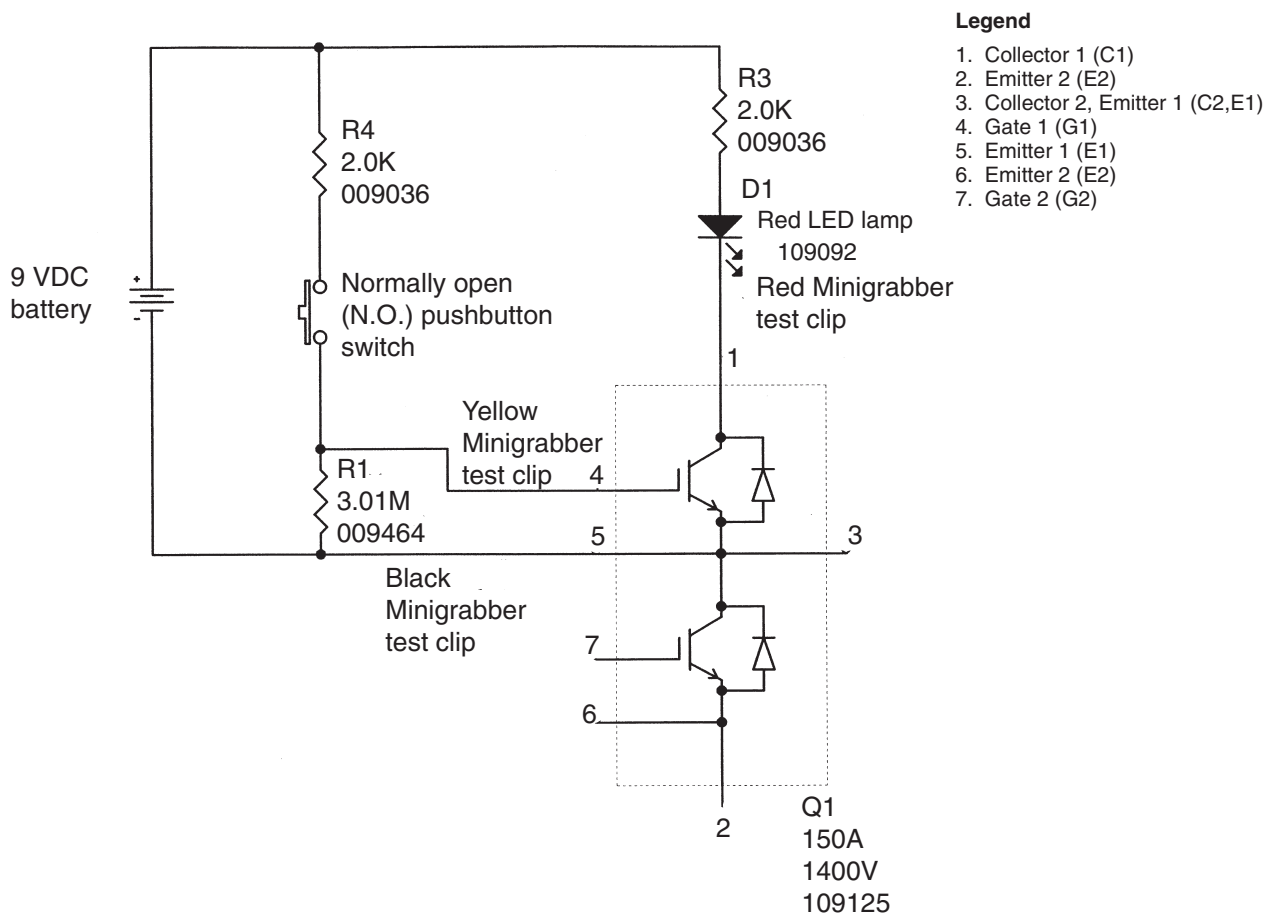

IGBT device test using a non-Hypertherm tester

The device tester shown in *Schematic for building an IGBT tester* has one LED and one pushbutton switch that are used in combination to perform two tests.

Note: Before an IGBT can be tested, it must be electrically isolated from all circuits. If the IGBT is installed in a power supply, remove the power board and any lead connections before testing.

1. Inspect the IGBT for cracks or black marks. If damaged, replace the IGBT.
2. Verify that the 9v battery reads greater than (>) 8.0v.
3. Connect the test leads as shown below.
4. With the test leads connected and without pressing the pushbutton switch, the LED should not illuminate. If the LED is illuminated, then the IGBT is shorted. Replace the IGBT.
5. With the test leads connected, press the pushbutton switch. This time, the LED should illuminate. If the LED does not illuminate, then the IGBT is open. Replace the IGBT.

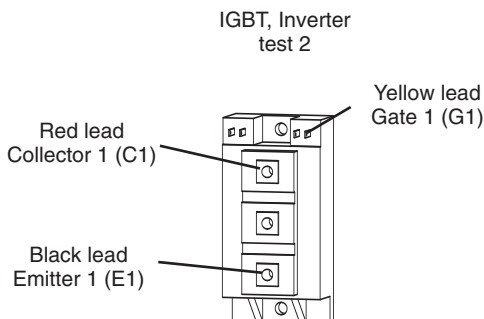
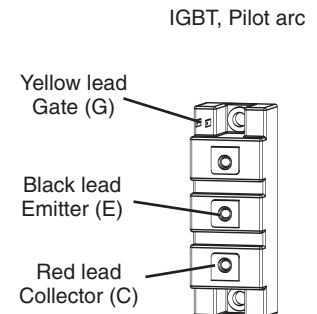
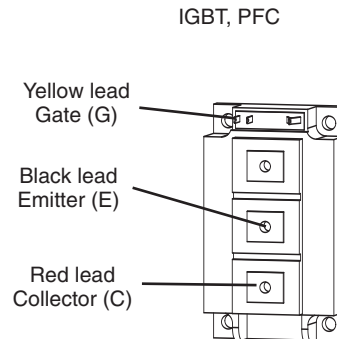
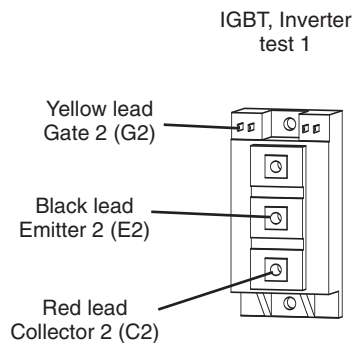

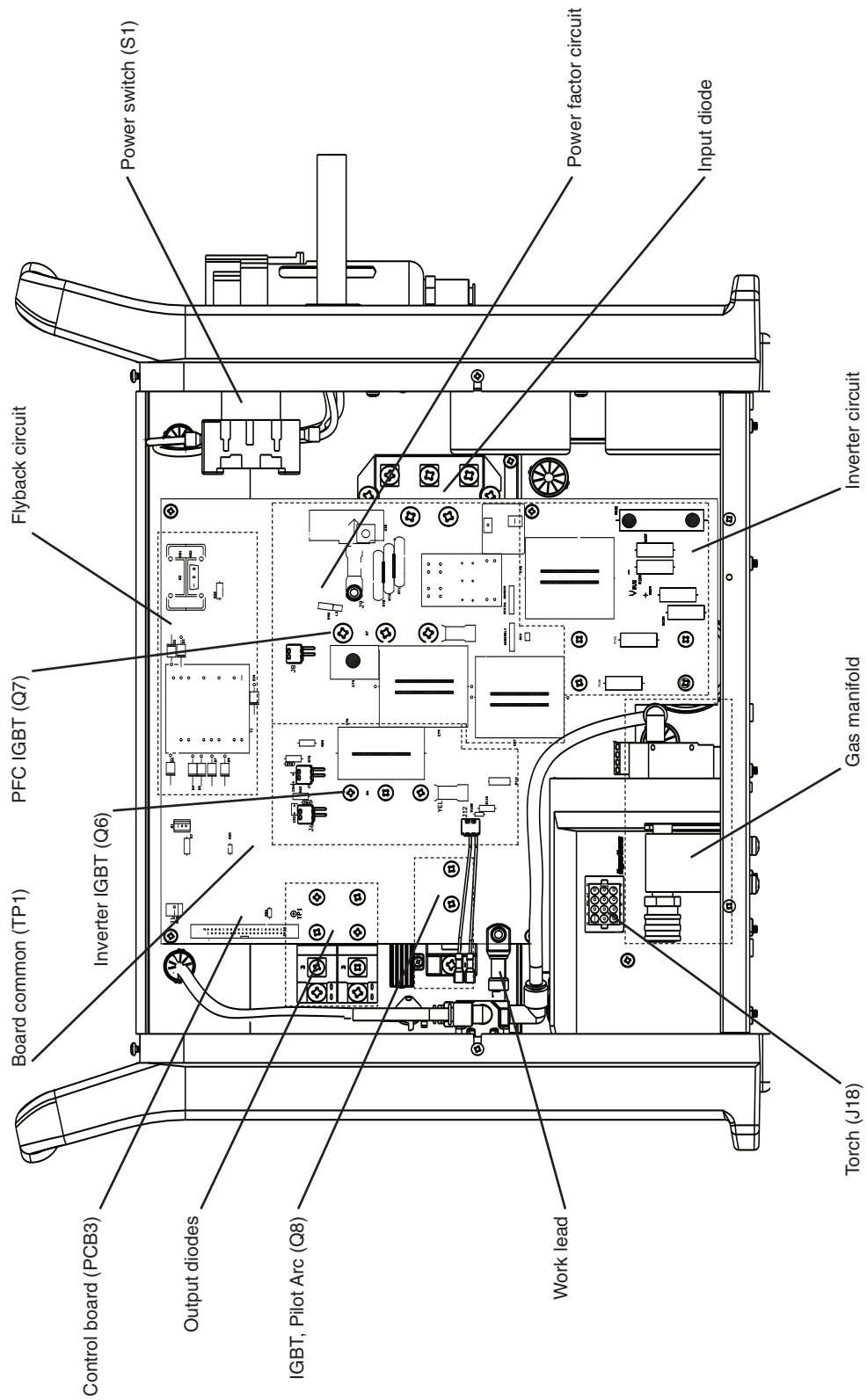

Troubleshooting Guide

Problem	Meaning	Cause	Solution
Power On LED does not illuminate or blinks when the power switch is ON.	Insufficient voltage to the control circuits, or a shorted power component.	No voltage, improper voltage applied to the unit, a faulty power switch (S1), or a faulty input diode.	Perform Test 1 and replace any faulty components as indicated by the results of the test.
		Faulty filter board (PCB1).	CE systems only: Measure the AC voltage at the CE filter. If there is no voltage or the voltage is low, replace the filter board.
		Faulty power board (PCB2), fan, or solenoid valve.	Disconnect J1 and J20 from the power board (PCB2) and perform Test 6. If all the voltages are not present or if the voltages are oscillating, replace the power board. If the voltages are correct, reconnect J1 and J20 one at a time and perform Test 6 after each reconnection. Replace the component that causes the voltage to oscillate or drop.
		Faulty power board (PCB2) or IGBT (Q6 or Q7).	Perform Tests 1 and 5 and replace any faulty components as indicated by the results of the tests.
		Faulty control board (PCB3).	Replace the control board (PCB3).
Power On LED blinks, flashes, or goes out while cutting.	Shorted power component or components.	Faulty power board (PCB2), fan, or solenoid valve.	Disconnect J1 and J20 from the power board (PCB2) and perform Test 6. If all the voltages are not present or if the voltages are oscillating, replace the power board. If the voltages are correct, reconnect J1 and J20 one at a time and perform Test 6. Replace the component that causes the voltage to oscillate or drop.
		Faulty power board (PCB2) or IGBT (Q6 or Q7).	Perform Tests 1 and 5 and replace any faulty components as indicated by the results of the tests.
		Faulty control board (PCB3).	Replace the control board (PCB3).

Problem	Meaning	Cause	Solution
Gas flows from the torch at power-up when neither the torch trigger nor the start switch is activated.	System is in gas test mode.	The current adjustment knob is in the gas test position.	Turn the current adjustment knob clockwise until it is set at 25 amps or above.
	Solenoid valve (V1) is stuck open or the power board (PCB2) is faulty.	Faulty valve, power board (PCB2) or control board (PCB3).	Perform Test 10 and replace any faulty components as indicated by the results of the test.
Voltage LED illuminates.	Improper line voltage or circuit size.	Voltage is below proper operating limits, or the phase is lost.	Verify the incoming line voltage and the circuit size according to the Operator Manual.
		Faulty power board (PCB2) or control board (PCB3).	Perform Tests 5, 6, and 11 and replace any faulty components as indicated by the results of the tests.
Gas pressure LED blinks yellow.	Insufficient gas pressure.	No gas supplied to the unit.	Connect the gas supply.
		Dirty air filter element.	Replace the air filter element.
		Restriction in the gas supply line.	Replace the gas supply line.
		Gas pressure setting is below operating requirements or the incoming gas pressure is dropping when trying to fire the torch.	Turn the current adjustment knob to gas test and set the pressure to 70 psi (4.8 bar) for cutting or 50 (3.4 bar) for gouging as required for system operation. Verify the gas source is within the setup specifications given in Section 2.
Yellow cap-sensing LED illuminates.	Cap-sensing circuit is not satisfied.	Faulty pressure sensor assembly or control board (PCB3).	Perform Test 12 and replace any faulty components as indicated by the results of the test.
		Consumables are not installed, are installed improperly, or are damaged.	Refer to the consumables diagram in Section 5 or to the Operator Manual for proper installation. Try new consumables and turn off the power and then turn it on again to clear the error.
		Damage to the cap-sensing circuit.	Perform Test 9 and replace any faulty components as indicated by the results of the test.

Problem	Meaning	Cause	Solution
Temperature LED illuminates.	Temperature sensors are indicating an over temperature condition.	Exceeded the duty cycle.	Allow the unit to cool. Work within the duty cycle limits in the Operator Manual.
		Fan is not operating or is operating improperly.	Perform Test 13 and replace any faulty components as indicated by the results.
		Faulty heat sink temperature switch (TP1). Check the switch when the system is cool, at least 15 minutes after use.	Remove the connector J2 from the power board (PCB2). Check the temperature sensor board (PCB4) by checking the resistance on pins 1 and 2. If the resistance is greater than 300Ω on the heat sink and 458Ω on the transformer, replace the control board (PCB3). If the resistance is lower than stated, replace the temperature sensor board (PCB4).
		Faulty power transformer (T2) or temperature sensor (TS2). Check these when the system is cool, at least 60 minutes after use.	Check the transformer sensor (T2) by checking the resistance on J21 pins 1 and 2. If the resistance is greater than 300Ω on the heat sink and 458Ω on the transformer, replace the control board (PCB3). If the resistance is lower than stated, replace the temperature sensor PCB (PCB4).
No gas flow when trying to fire the torch. Fault, gas pressure, and power ON LEDs illuminate.	Damaged torch or lead assembly.	Torch plunger stuck open or broken torch leads.	Verify that the torch stuck open (TSO) LED is illuminated (see <i>Control board LEDs</i>). Perform Test 7 and replace any faulty components as indicated by the results of the test.
	Pilot arc IGBT (Q8) not working.	Faulty pilot arc IGBT (Q8), power board (PCB2), or control board (PCB3).	Perform Test 4 and replace any faulty components as indicated by the results of the test.
	No output from power board (PCB2).	Faulty inverter IGBT (Q6) or power board (PCB2).	Perform Test 5 and replace any faulty components as indicated by the results of the test.
No gas flow when trying to fire the torch and no fault LEDs are illuminated. Gas flows when in gas test mode.	Start signal is not being received by the power supply.	Damage to the torch or lead assembly for the manual torch. Damage to the interface cable or no input from the CNC for mechanized applications.	Verify that the start LED is not illuminated (see <i>Control board LEDs</i>). Manual torch: check the start wires; see the wiring diagram. Mechanized torch, perform Test 8 and replace any faulty components as indicated by the results of the test.

Problem	Meaning	Cause	Solution
No gas flow when trying to fire the torch, no fault LEDs are illuminated and no gas flows when in test.	Solenoid valve is not working.	Valve is stuck or there is no voltage to valve.	Perform Test 10 and replace any faulty components as indicated by the results of the test.
When pressing the torch trigger or the start switch, gas flows from the torch, but the torch does not fire or fires for only a short duration.	Worn or damaged consumables.	Overused or improperly installed consumables.	Replace consumables.
	Insufficient gas flow.	Improper pressure setting.	Turn the current adjustment knob to the gas test position and set the pressure regulator to 70 psi (4.7 bar) for cutting or 50 psi (3.4 bar) for gouging.
	Damaged torch or lead assembly.	Electrode is not moving properly in the torch, or there is a short-circuit in the torch leads.	Perform Test 7 and replace any faulty components as indicated by the results of the test.
	Faulty power board (PCB2).	Voltage imbalance across the bus capacitors.	Perform Test 2 while trying to fire the torch. If the voltage across the capacitors is not balanced, then replace the power board (PCB2).
Arc goes out while cutting or intermittently will not re-fire.	Arc lost contact with the workpiece.	Faulty work lead, work lead connection, or connection between the work lead and the cutting table.	Check the physical condition of the work lead. Check for loose connections at the clamp and power supply. Reposition the work lead to connect directly to the workpiece. If the problem does not go away, clean the cutting table to improve the contact between the table and the work lead.
	Faulty fan.	Fan could be overloading the flyback circuit.	Disconnect J1 and perform Test 6. If the voltage values are correct, run with the fan disconnected. If system runs properly until the system reaches an over-temperature condition, replace the fan.

Problem	Meaning	Cause	Solution
<p>When pressing the torch trigger or start switch, the pilot arc starts but then extinguishes before the normal 5-second time-out period. Fault LEDs may illuminate.</p>	Worn consumables.	Worn-out consumables.	Replace the consumables.
	Improper gas pressure setting or low flow.	Insufficient gas supply or a gas leak in the supply line.	Turn the current adjustment knob to gas test and set the pressure regulator to 70 psi (4.7 bar) for cutting or 50 psi (3.4 bar) for gouging. If unable to adjust the system to the proper setting, check the external gas supply.
	Poor quality gas.	Moisture or contaminants in the gas supply.	Add appropriate filtration and purge the lines with nitrogen to flush out oil and moisture.
	Insufficient input power (low voltage and fault LEDs may not illuminate).	Undersized electrical supply installation: <ul style="list-style-type: none"> - Breaker or fuse - Supply wire - Extension cord 	Verify that the external electrical power is installed according to the specifications in Section 2. Check the input voltage while trying to fire the torch. A voltage drop indicates an undersized electrical supply installation.
	Inverter fault or interlock.	Power board (PCB2) failure.	Check the fault LEDs on the back of the control board (see <i>Control board LEDs</i>). If the inverter interlock (IF) LED is illuminated, disconnect J5 and place a jumper between pins 1 and 2 on the power board (PCB2). If the error clears, replace the power switch (S1). If not, perform Test 5. If either of the tests fails, replace the power board (PCB2) and the inverter IGBT (Q6).
	Capacitor voltage imbalance (C94/C98).	Faulty resistors on the power board (PCB2).	Perform Test 2 while trying to fire the torch. If the voltage across the capacitors is not balanced, then replace the power board (PCB2).

Problem	Meaning	Cause	Solution
<p>Machine will not cut well (does not appear to be operating at full cutting power), and the arc does not time out after 5 seconds.</p>	<p>Inadequate ground.</p>	<p>Poor work lead connection.</p>	<p>Verify that the work lead is attached to workpiece and the workpiece is free of rust, paint, or other coatings.</p>
		<p>Damaged work lead.</p>	<p>Check the resistance across the work lead. If the resistance is greater than 3Ω, replace or repair as required.</p>
		<p>Faulty pilot arc IGBT (Q8).</p>	<p>Turn the power OFF, remove the consumables, and check the resistance between the plunger and the work piece. If the resistance is less than 5kΩ, check the resistance across the pilot arc IGBT (two screws on Q8). If the resistance is less than 5kΩ, replace the pilot arc IGBT.</p>
		<p>Faulty control board.</p>	<p>Replace the control board (PCB3).</p>
	<p>Low output from the power supply.</p>	<p>Current adjustment is set too low.</p>	<p>Verify that the current adjustment knob is set at the maximum (fully clockwise).</p>
		<p>Faulty power board (PCB2) current sensor.</p>	<p>Verify that the yellow wire connected to the bottom of Q6 is wired through the bottom of L1. If so and if the inverter interlock (IF) LED is illuminating (see <i>Control board LEDs</i>), replace the power board and perform Test 5. If one of the two tests fails, replace the power board (PCB2) and the appropriate IGBT.</p>
		<p>Faulty control board (PCB3).</p>	<p>Verify that the transfer (XFR) LED illuminates properly (see <i>Control board LEDs</i>) on the control board (PCB3) and check the current on the work lead. If the current is between 15 and 25 amps and the LED illuminates, replace the control board.</p>
<p>Losing the pilot arc when going off the workpiece while in continuous pilot mode.</p>	<p>Continuous pilot arc does not work.</p>	<p>Mode switch is set incorrectly.</p>	<p>Set the mode switch to the correct position.</p>
		<p>Faulty control board (PCB3).</p>	<p>Verify that the transfer LED on the control board (PCB3) illuminates and that the inverter interlock (IF) LED does not (see <i>Control board LEDs</i>). If both are true, replace the control board (PCB3).</p>

Problem	Meaning	Cause	Solution
Fault LED illuminates when the power is turned ON.	Start signal on the control board is illuminated.	The torch trigger is defective or engaged or the CNC is issuing a plasma start signal in a machine application.	For a hand torch, check wiring of the torch trigger (see <i>T80 hand torch</i>). For a machine torch application, remove the interface cable from the back of the power supply and check the start LED (see <i>Control board LEDs</i>). If the start LED goes out, the problem is either a short circuit in the interface cable or the CNC is issuing a plasma start signal.
Red LED on the power board (PCB2) remains illuminated when the input voltage is between 200 and 540 VAC.	Faulty PFC circuit on the power board (PCB2), the inverter is going into an over-current state, or there is major component damage on the power board (PCB2).	Faulty or shorted inverter IGBT (Q6), PFC IGBT (Q7) or a faulty power board (PCB2).	Perform Test 5 and replace any faulty components as indicated by the results of the test.

Control board LEDs

If the fault LED illuminates, no yellow indicator LEDs are illuminated, and green AC and pressure LEDs remain illuminated, check LEDs on the rear of control board (PCB3).

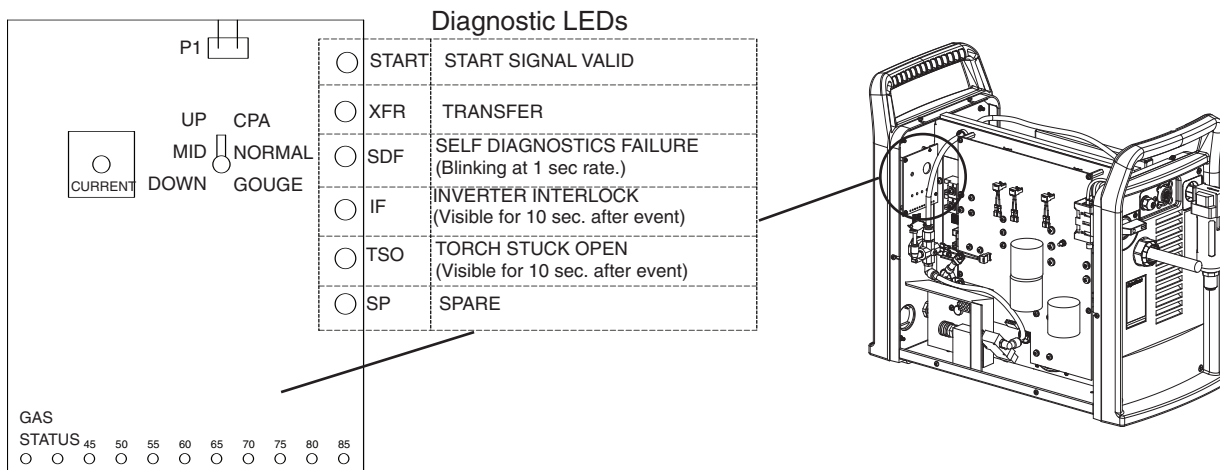

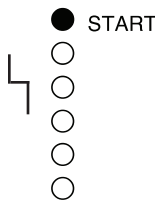
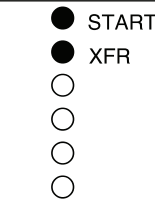
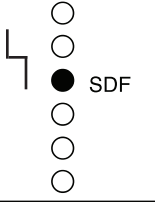
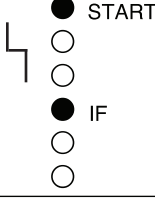
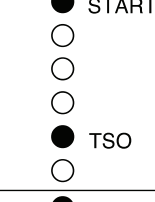
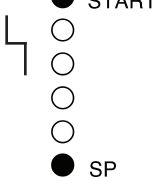
Problem	This may mean	Cause	Solution
 <p>The start LED on the control board (PCB3) and the fault LED are illuminated.</p>	A continuous start signal.	Shorted start wires or a stuck start trigger switch.	Check the start wires (blue and orange wires in the torch) for a short circuit.
		Receiving the start signal from the CNC.	Check the CNC cable for a start signal (Machine interface pins 3 and 4).
 <p>The start and XFR LEDs on the control board (PCB3) are illuminated.</p>	Arc transfer.	Normal operation.	Not applicable.
 <p>The SDF LED on the control board (PCB3) and the fault LED are illuminated.</p>	A self-diagnostic failure.	A microprocessor failure.	Replace the control board (PCB3). If the SDF LED remains illuminated, replace the power board (PCB2).
 <p>The start and IF LEDs on the control board (PCB3) and the fault LED are illuminated.</p>	Inverter interlock.	A faulty power board (PCB2), faulty PFC IGBT (Q7) or faulty inverter IGBT (Q6). Any or all of these parts can be faulty.	Perform Test 14 and Test 5.
 <p>The start and TSO LEDs on the control board (PCB3) are illuminated.</p>	The torch is stuck in the open position.	The torch plunger is stuck, the consumables are worn, or the pilot arc IGBT is faulty.	Perform Test 7.
 <p>The start and SP LEDs on the control board (PCB3) and the fault LED are illuminated.</p>	A control board failure.	A faulty control board (PCB3).	Replace the control board.

Test 1 – voltage input

- Check the line voltage to the top of the power switch (S1).
- Check the input voltage to the input diode bridge.
- The AC voltage between any 2 input wires should equal the line voltage.
- If there is proper voltage to the power switch and low voltage to the input diode, replace the power switch.
 - For CE systems, check the voltage at the CE filter. If there is proper voltage to CE filter and low voltage to the input diode, replace the CE filter.
- Check the output voltage of the input diode bridge.
- Output VDC = Line Voltage x 1.414

Note: All values can be $\pm 15\%$.

	Standard unit	CE unit
L1	Black	Black (U)
L2	White	Blue (V)
L3	Red	Brown (W)
PE	Green	Green/Yellow

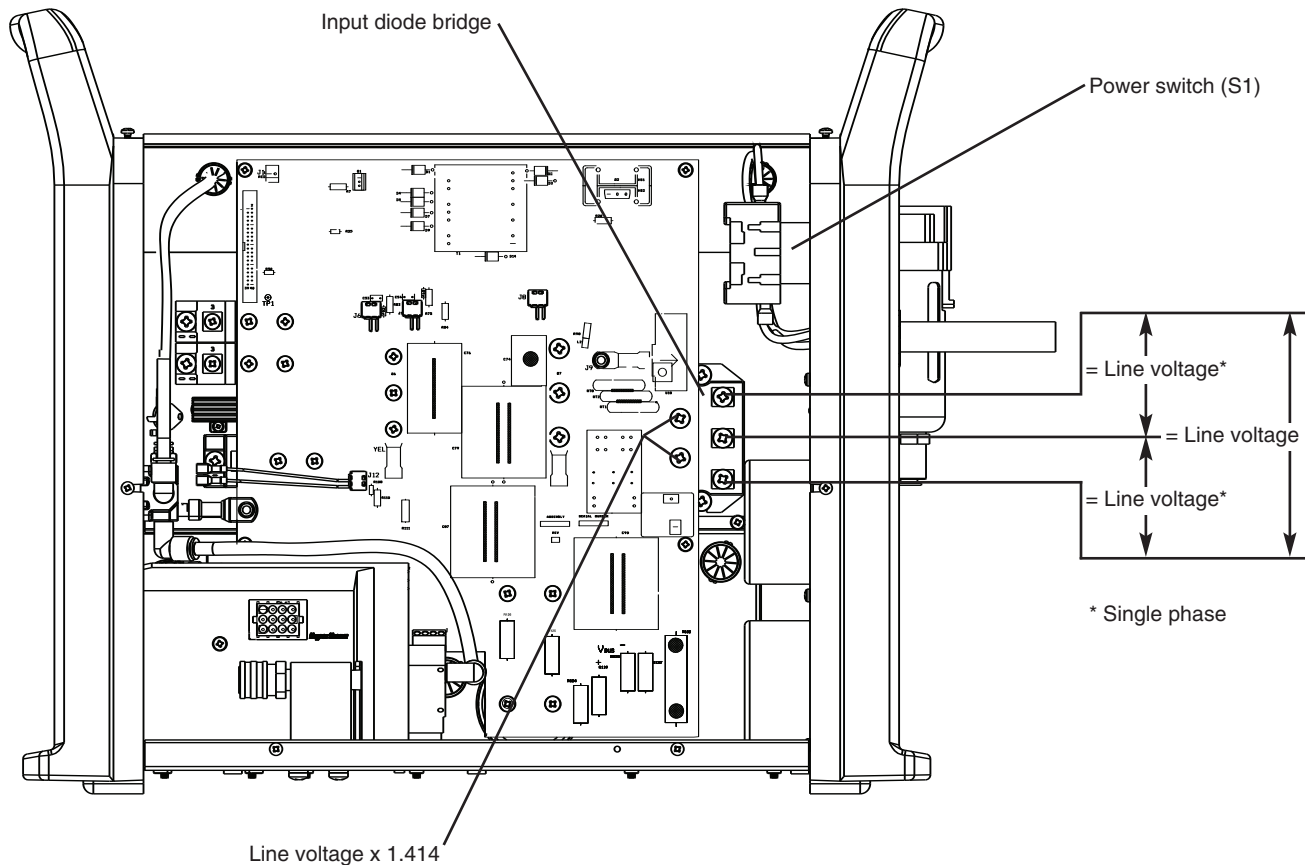
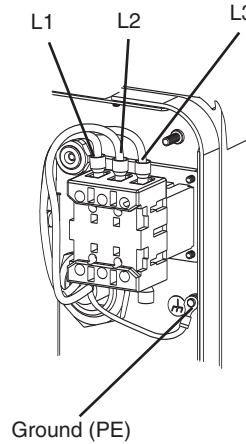

Test 2 – voltage balance

Test to check the balance of the bus voltage, the power-factor circuit, and the soft-start circuit.

- Verify the system's serial number. Serial numbers below 1250-008720 have a different power board from systems with serial numbers above 1250-008720.
- Remove screws from capacitors C94 and C98 before measuring the resistors listed below.
- Check the voltage across the inverter IGBT (Q6).
- Check the voltage across the capacitors (C94, C98) before and during torch operation.
- Voltage across both capacitors should be 375 VDC.

On systems with serial numbers below 1250-008720, if the capacitors are not balanced at 375 VDC, install the RCD resistor kit (part number 128963). For systems with higher serial numbers, replace the power board.

Note: All values can be $\pm 15\%$.

Bus-bleed and soft-start resistors for serial numbers below 1250-008720.

R118 = 3Ω
 R119 = $25k\Omega$
 R120 = $25k\Omega$

Bus-bleed and soft-start resistors for serial numbers above 1250-008720.

R124 = $75k\Omega$
 R125 = $75k\Omega$
 R126 = $75k\Omega$
 R127 = $75k\Omega$

Note: Bulk capacitors must be out of circuit.

R126 = $20.8k$ R120 = $21.2k$
 R125 = $21.0k$ R127 = $21.2k$
 R124 = $24.1k$
 R119 = $24.1k$

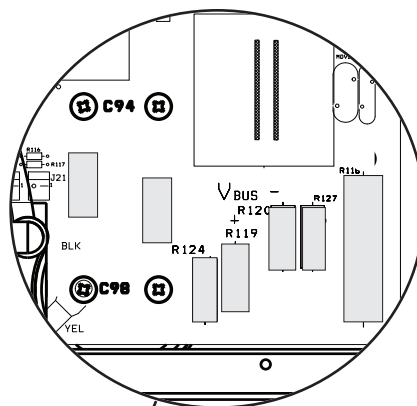

Inverter IGBT (Q6)

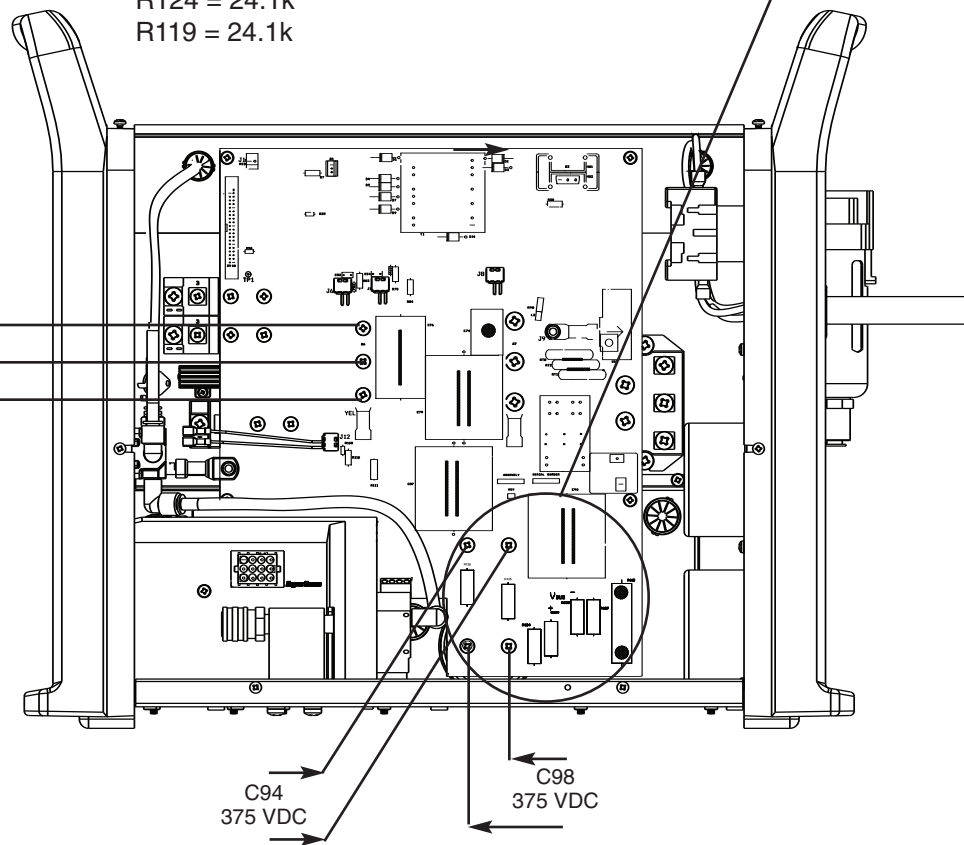
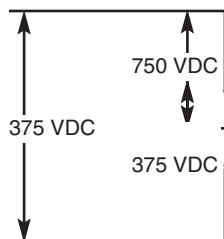

Test 3 – output diodes

- Check each diode (connection 1 and 3) with an ohm meter in diode test mode.
- For each diode, the value should be open with meter leads in one direction and 0.1V to 1.0V with the meter leads reversed.

The diode is shorted if the value is less than 0.1V. Replace the diode.

The diode is open if the value is greater than 1.0V in both directions. Replace the diode.

Note: In each case, common (black) should be on 3.

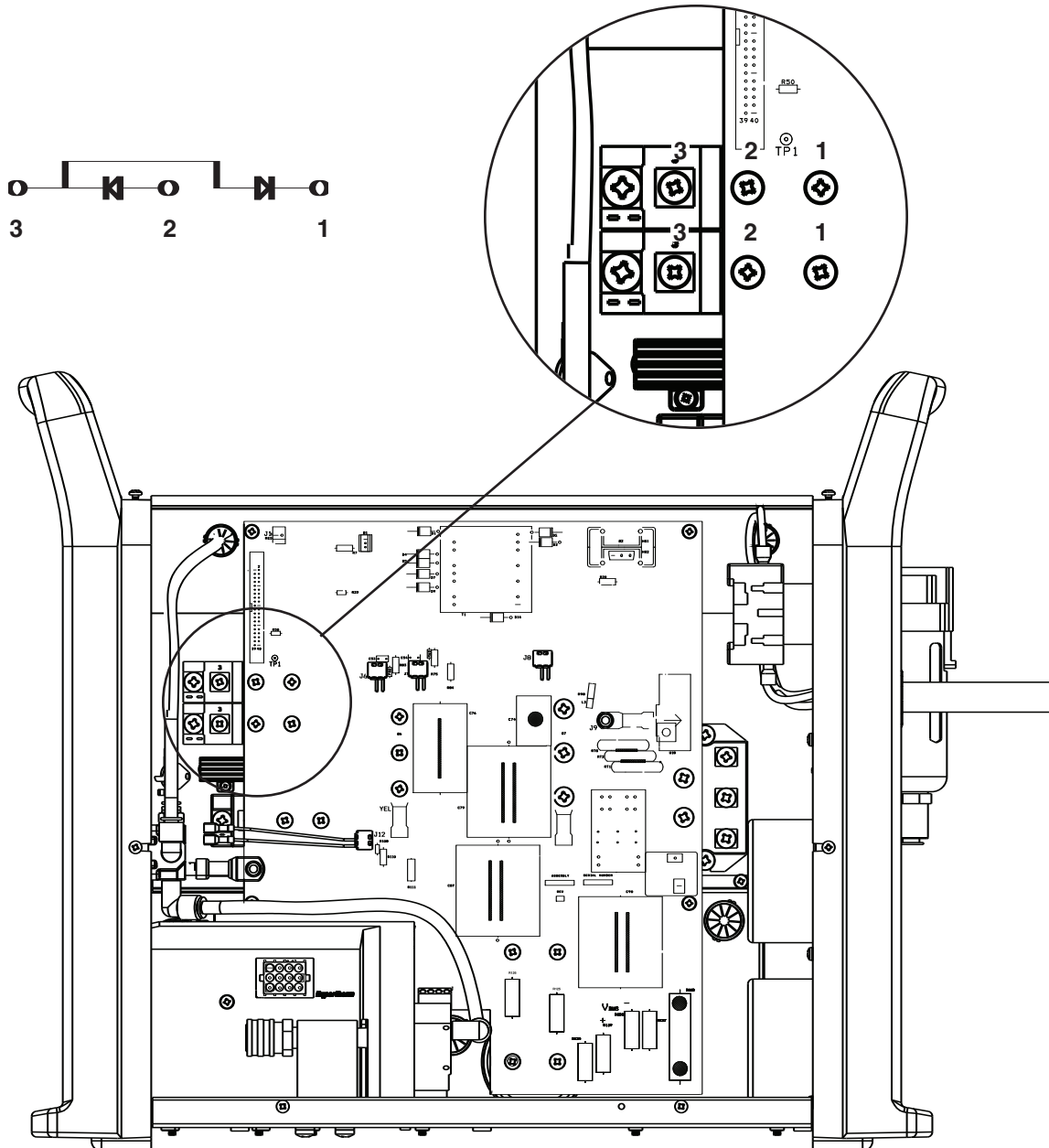

Test 4 – pilot arc IGBT (Q8)

- Check the resistance of the gate-drive circuit (R108, R110).
- If the values are not $\pm 15\%$ of the values listed below, replace the power board (PCB2) and the pilot arc IGBT (Q8).
- If the values are correct, check the pilot arc IGBT (Q8) with an IGBT tester. If it fails, replace the power board (PCB2) and the pilot arc IGBT (Q8).

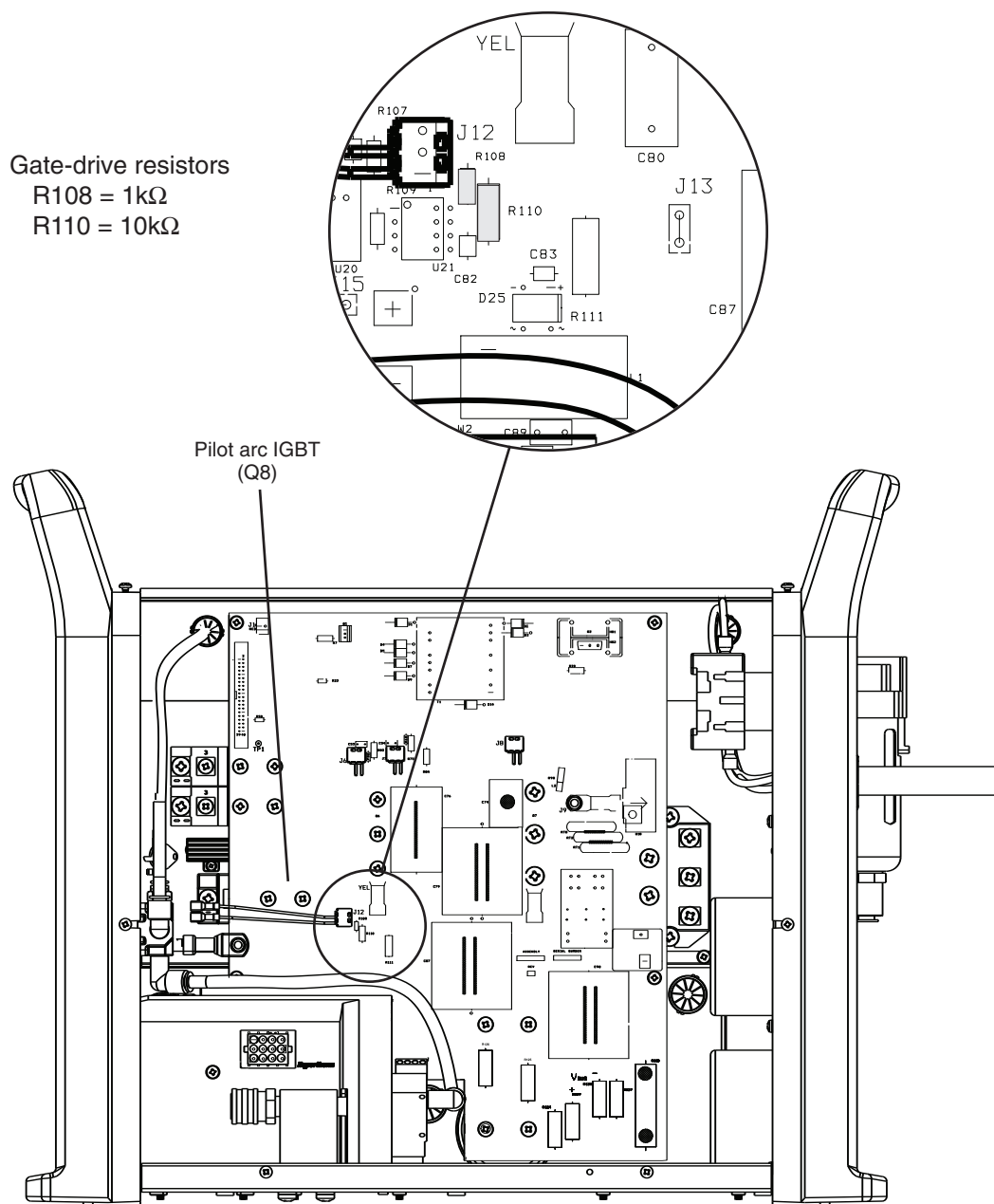

Test 5 – inverter IGBT (Q6) and PFC IGBT (Q7)

- Check the resistance of the gate-drive circuit.
- If values are not $\pm 25\%$ of the values shown below, replace the power board (PCB2) and the appropriate IGBT.
- If values are correct, check both IGBTs with an IGBT tester. If one IGBT fails, replace the power board (PCB2) and the failed IGBT.

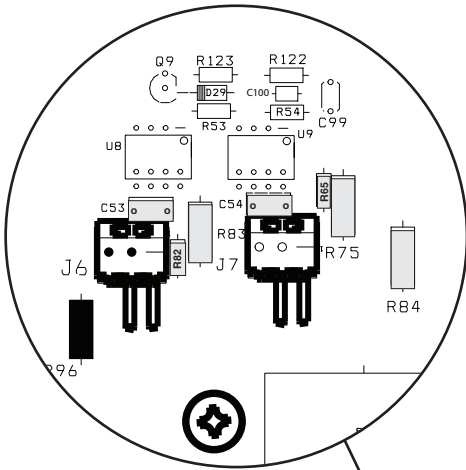

Inverter
 R82 = 994Ω
 R83 = 6.1Ω
 R65 = 995Ω
 R75 = 6.1Ω
 R84 = 10.4Ω
 R96 = .4Ω

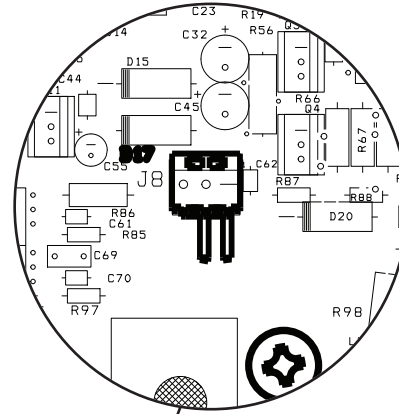

PFC
 R87 = 994Ω
 R56 = 4.1Ω
 R98 = 1Ω

Inverter IGBT (Q6)

PFC IGBT (Q7)

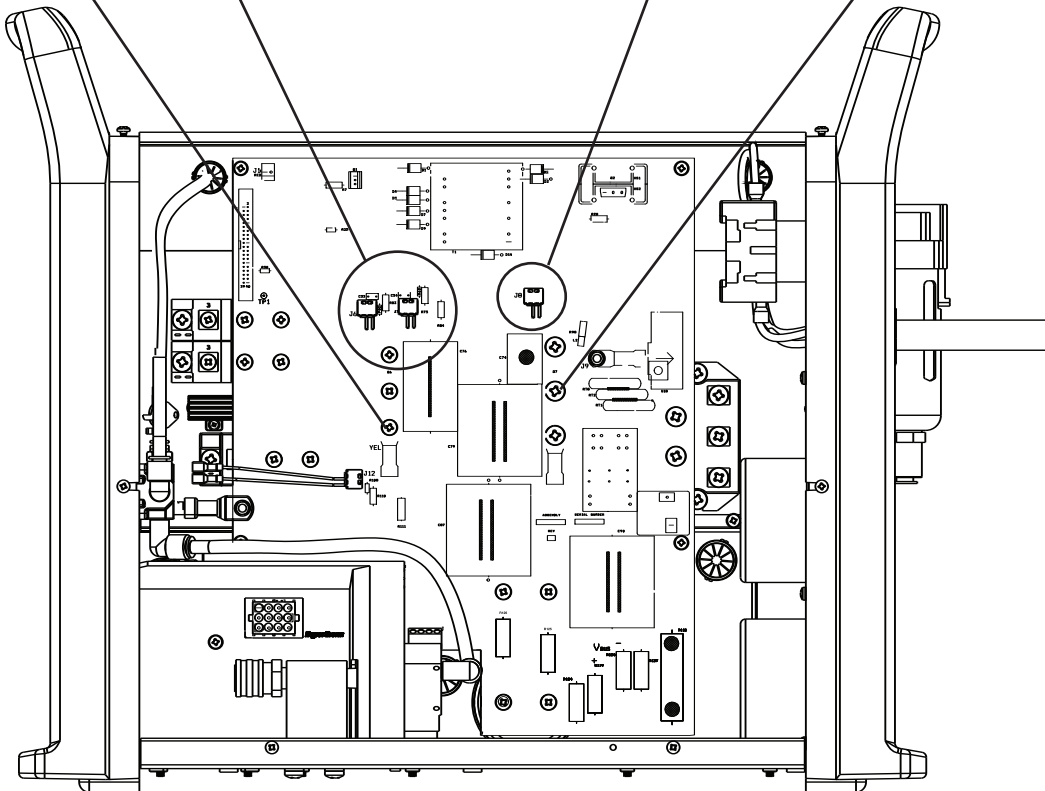

Test 6 – flyback circuit

DC power supply circuit test (+5 VDC, +10 VDC, +18 VDC, and +24 VDC).

- Verify that the diodes listed below are not short-circuited by checking their resistance (approximately 2k Ω).

Note: Check the voltage to TP1.

- Inspect the circuit for damage.

D4 = 24 VDC	R1 = 24 VDC
D5 = 24 VDC	R2 = 18 VDC
D7 = 10 VDC	R9 = -6 VDC
D9 = 18 VDC	R18 = 5 VDC
D17 = 5 VDC	R20 = 0.75 Ω
	R26 = 18 VDC
	R55 = 18 VDC

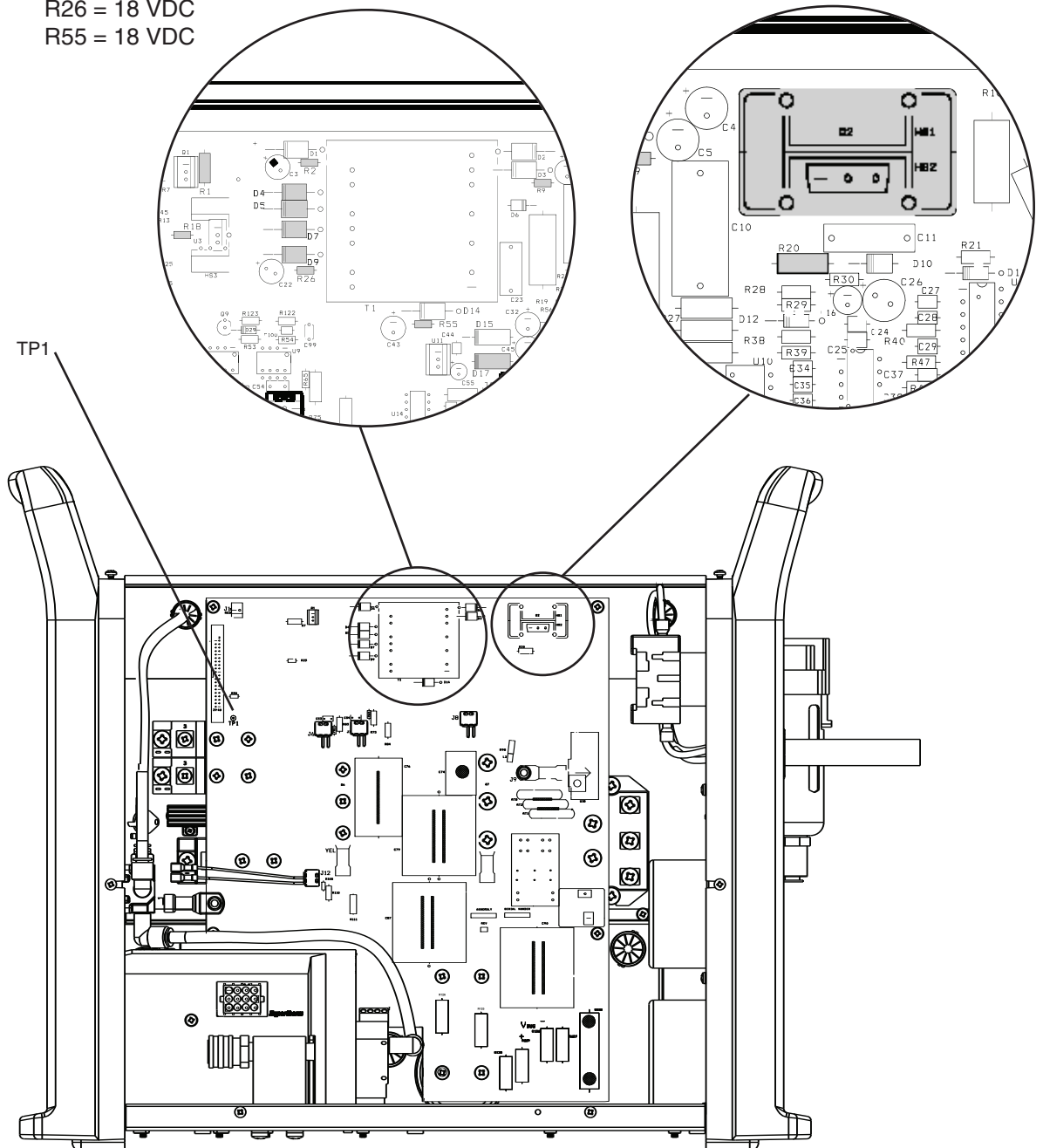

Test 7 – torch stuck open (TSO)

- Check the resistance between the pilot arc IGBT (Q8) and J17. The value should be less than ($<$) 100Ω .
- Switch to gas test mode and check the resistance again. The value should be greater than ($>$) $1k\Omega$.
- If the value is less than ($<$) 100Ω all the time, check the resistance between the pilot arc IGBT (Q8) and J17 with the torch removed. If the value is less than ($<$) $100k\Omega$, replace the pilot arc IGBT (Q8).
- If the resistance is always greater than ($>$) 100Ω , then the electrode/nozzle circuit is open.
 - Inspect the wiring to the torch.
 - Replace all consumables and verify that the torch will fire.
Note: The retaining cap should be snug, but not over-tightened.
 - If the torch plunger does not move freely in the torch head, replace the torch head.
- Verify that the pilot arc IGBT (Q8) is open by placing a jumper wire between J14 and the pilot arc IGBT (Q8). Then attempt to fire the torch. If the torch fires, replace the pilot arc IGBT (Q8).

Note: All values are $\pm 25\%$.

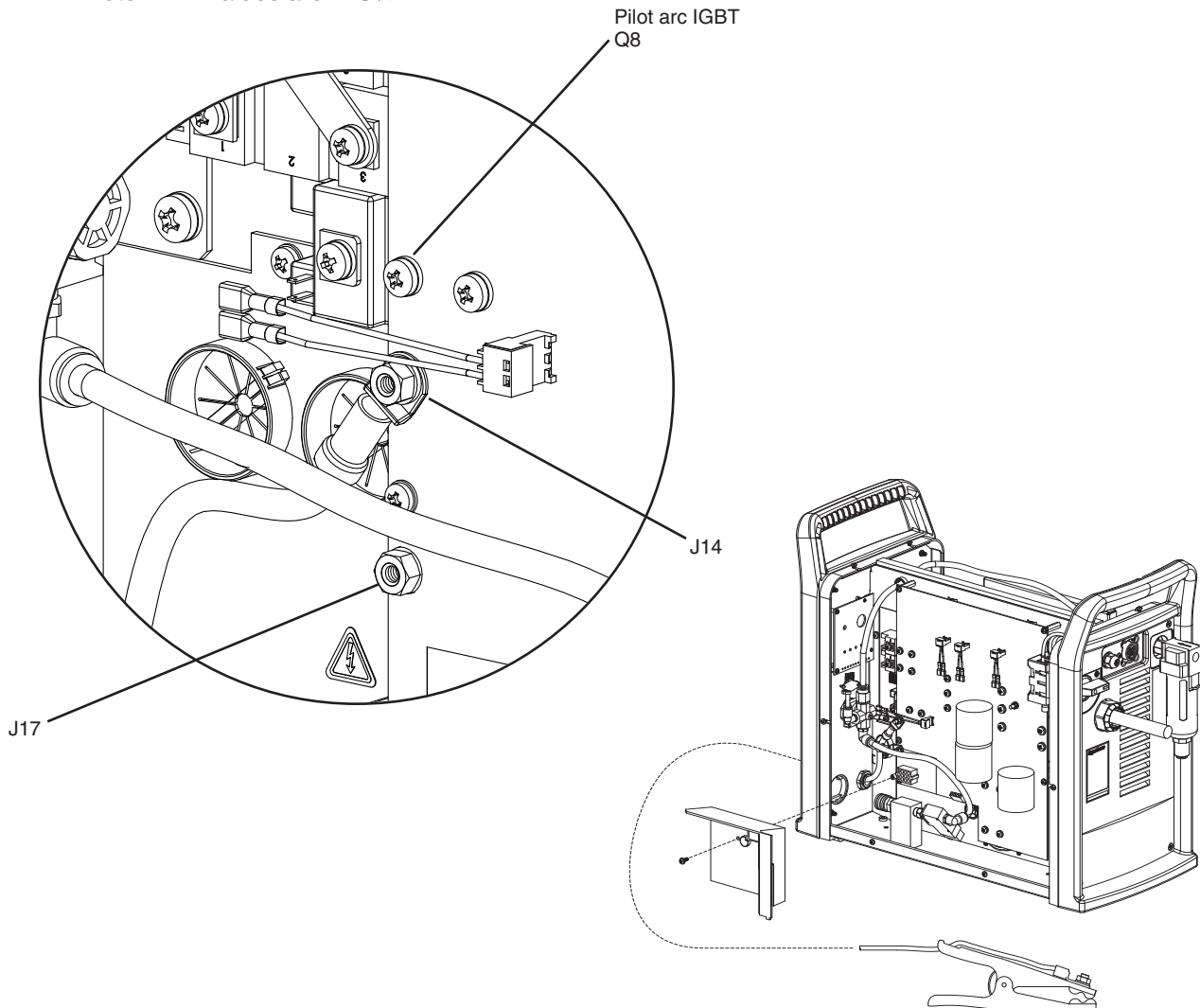

Test 8 – plasma start

- After you turn ON the power, place a jumper wire between red and white on the machine interface (J19). The torch should produce an arc.
- Note: This only applies to the machine torch.
- If the torch fires, inspect the machine interface cable and verify the start signal from the CNC by verifying that the start LED on the control board illuminates (see *Control board LEDs*).
- If torch does not fire, verify that the start LED on the control board (PCB3) also is not illuminating.
- To test hand torch operation, pull the trigger and verify that the start LED illuminates (see *Control board LEDs*).
- If the start LED is OFF, verify continuity between the purple and orange wires on the Easy Torch Removal (ETR) connector of the torch lead.
- If the start LED is OFF and the trigger works correctly, place a jumper wire between pins 3 and 4 of U22. If the start LED illuminates, replace the power board (PCB2). If it does not illuminate, replace the control board (PCB3).

Test 9 – torch cap sensor

- Remove the ETR connector (J18) from the power supply.
- Check the continuity of pins 11 and 12 with the consumables installed in the torch.
- If the connection is open, check the wiring in the torch leads and the cap-sensor switch.
- With the power OFF, place a jumper wire between pins 3 and 4 of U23.
- Turn ON the power. If the torch cap-sensor LED goes out, replace the power board (PCB2). If the LED remains illuminated, replace the control board (PCB3).

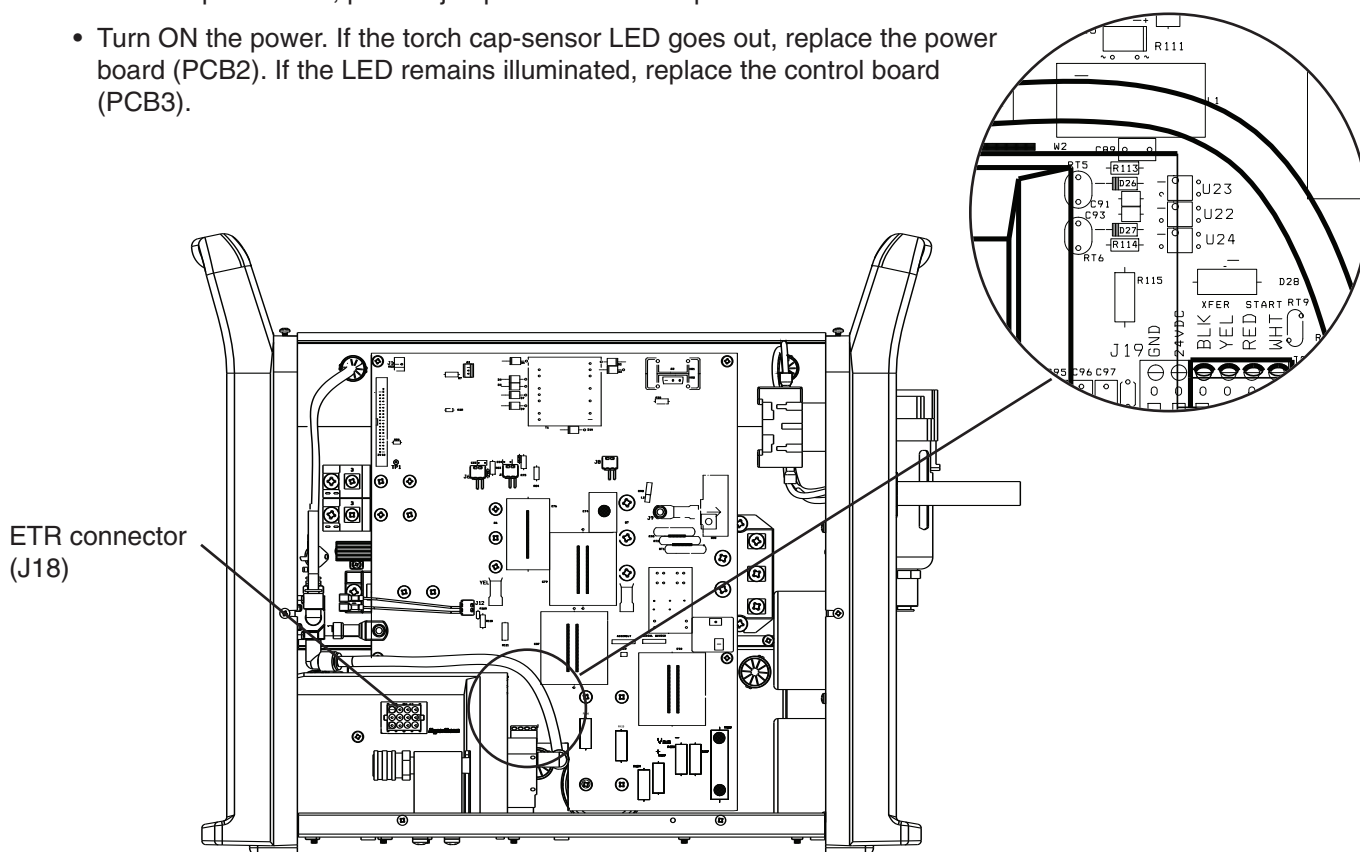

Test 10 – gas solenoid

- If the gas flows continuously, disconnect the gas solenoid connector (J20) from the power board (PCB2). If the gas does not shut off, replace the valve.
- If the gas stops, disconnect the ribbon cable (J4) from the power board (PCB2) and reconnect J20. If the gas remains off, replace the control board (PCB3). If the gas flow returns, replace the power board (PCB2).

Test 11 – incoming line voltage (VACR)

- Verify that the voltage on output of the input diode, equals 1.414 multiplied by the input voltage.
- If the value is low, check the input voltage or replace the diode.
- If the value is correct, verify that the voltage between the left side of R25 and ground (TP1) is 4.969 mV/V.
- If the value is correct, replace the control board (PCB3). If not, replace the power board (PCB2) and the PFC IGBT (Q7).

Test 12 – pressure switch

- Verify that the voltage from the right side of R50 to ground (TP1) reads approximately 0.0463 VDC multiplied by psi. For example, when the air regulator is set to 80 psi, the voltage should be approximately 3.7 VDC.
- If the value is correct, replace the control board (PCB3). If not, replace the pressure switch.

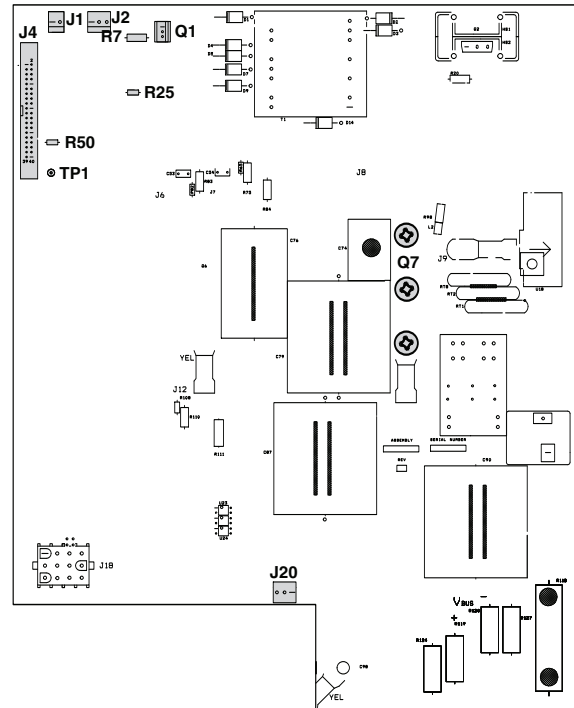

Test 13 – fan

- Force the fan into an over-temperature condition (place a jumper wire from J2 pin 1 to pin 2 to short it).
- Verify that the voltage across the fan on power board (PCB2) J1 pins 1 and 2 equals 24 VDC.
 - If it does not, remove the fan connector (J1) and check the voltage on the power board (PCB2) J1 pins 1 and 2 again.
 - If it equals 24 VDC now, continue to the next step. If not, perform Test 6 – flyback circuit.
- Place a jumper wire between the fan transistor (Q1) case to ground (TP1). If the fan turns on, continue to the next step. If not, replace the fan.
- Check the voltage between the left side of R7 and ground (TP1). If the VDC is zero (0), replace the control board (PCB3). If the value is 5 VDC, replace the power board (PCB2).

Test 14 – AUX switch

If the AUX switch on the ON/OFF switch (S1) is open when the system is powered up, the IF LED will illuminate when the torch trigger is pulled or the start switch is pressed.

- Remove the J3 plug from the power board.
- With the ON/OFF switch S1 in the OFF (O) position and the unit unplugged from electrical power, the AUX switch should read as open.
- With the ON/OFF switch in the ON (I) position, the AUX switch should read closed.

Test 15 – flyback circuit failure

Multiple flashing indicator LEDs can signal a failure in the flyback circuit.

- Unplug the fan. If the LEDs no longer flash, replace the fan. If the LEDs are still flashing, plug in the fan again and perform the next step.
- Unplug the solenoid valve. If the LEDs no longer flash, replace the solenoid valve. If the LEDs are still flashing, plug in the solenoid valve again and perform the next step.
- Unplug the CNC interface cable or the ON/OFF pendant on the back of the machine. If the LEDs are still flashing, plug in the CNC interface cable again and perform the next step.
- Measure for 5 VDC on the power board (R15 or J5 pin 2 to TP1) while the lights are flashing. If the value is not a constant 5 VDC ($\pm 0.5V$), disconnect the control board and measure for 5 VDC again. If it is still not a constant 5 VDC, replace the power board (PCB2).
- If no problems are found while completing the previous steps, replace the control board (PCB3).

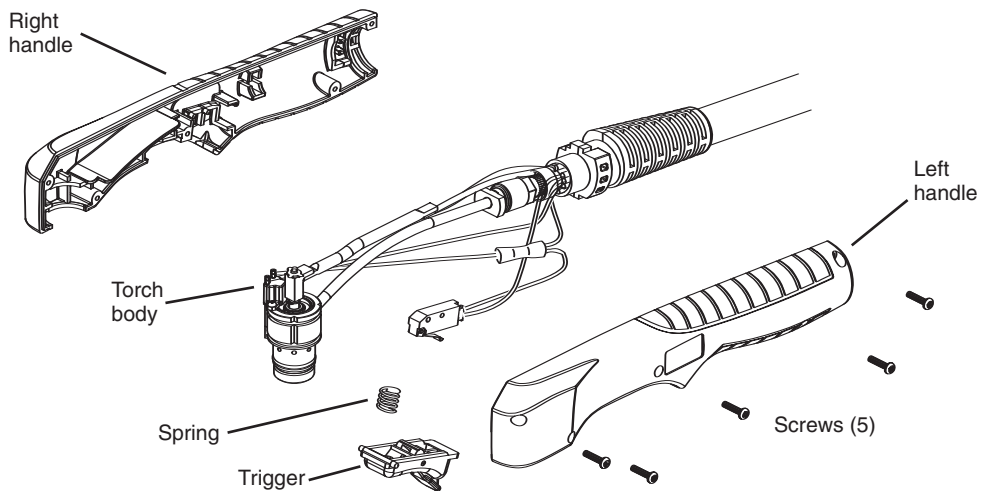
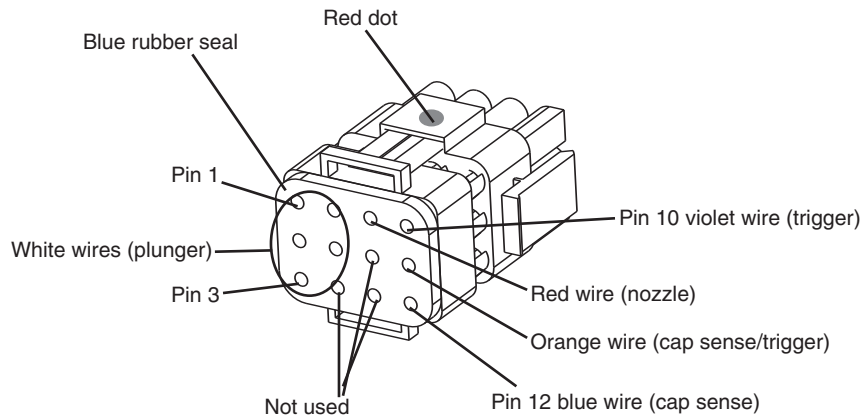
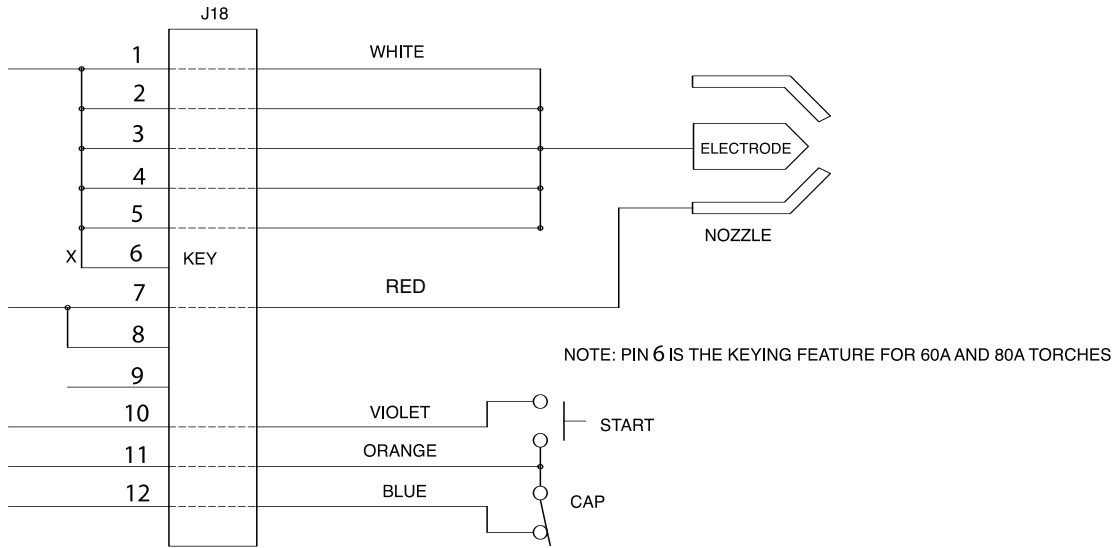

T80 hand torch: connector pinout diagrams and assembly

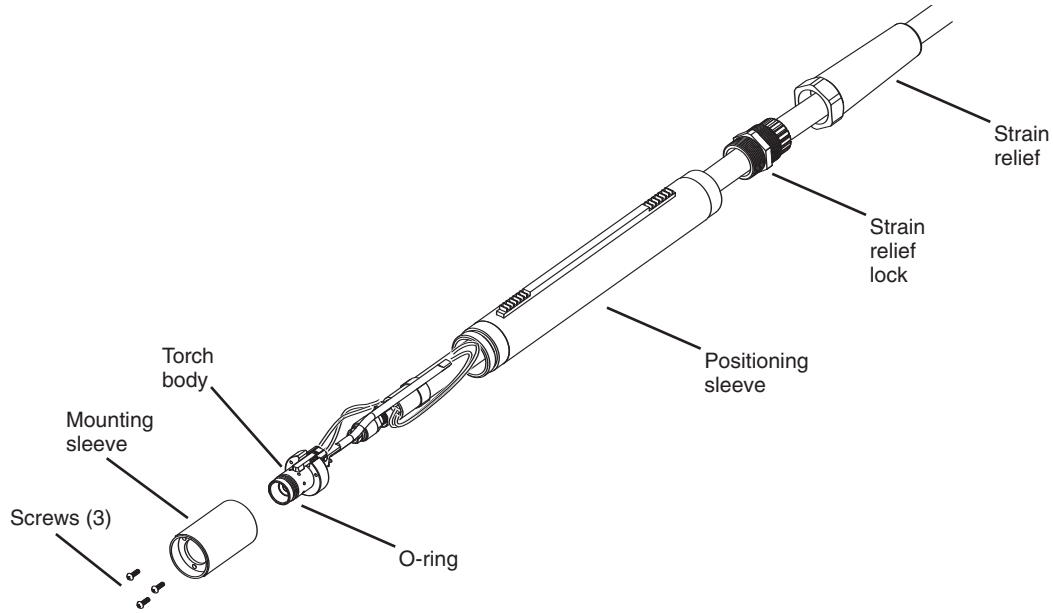
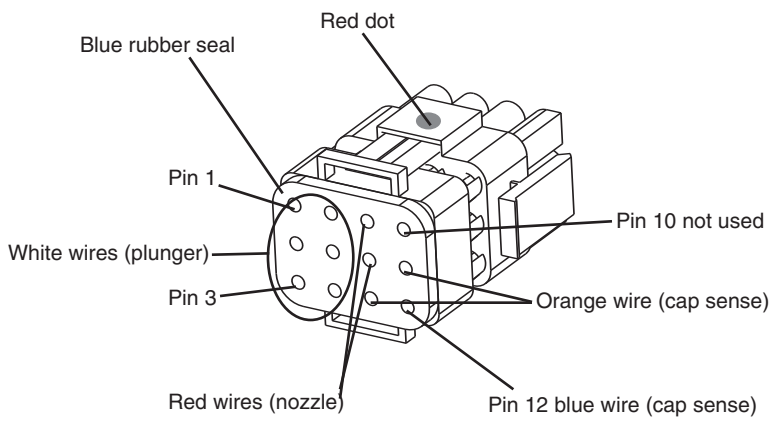
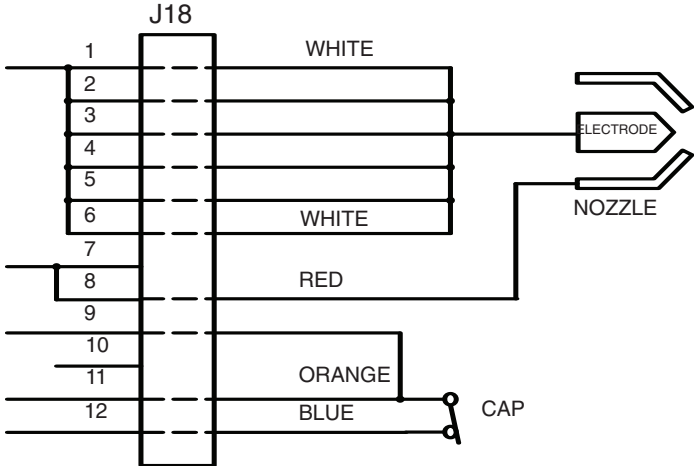

T80M machine torch: connector pinout diagrams and assembly



Component replacement

		DANGER
<p>ELECTRIC SHOCK CAN KILL</p> <ul style="list-style-type: none"> • Use extreme caution when working near live electrical circuits. Dangerous voltages exist inside the power supply that can cause serious injury or death. • See warnings on page 3-7 before proceeding. 		

Power cord replacement

Disconnect the electrical power and the gas supply before removing the old power cord.

1. Remove the power supply cover.
2. Insert the new power cord through the strain relief.
3. Install the power cord connections as shown below.
4. Tighten the strain relief onto the power cord.
5. Install the power supply cover.
6. Reconnect the electrical power and the gas supply.

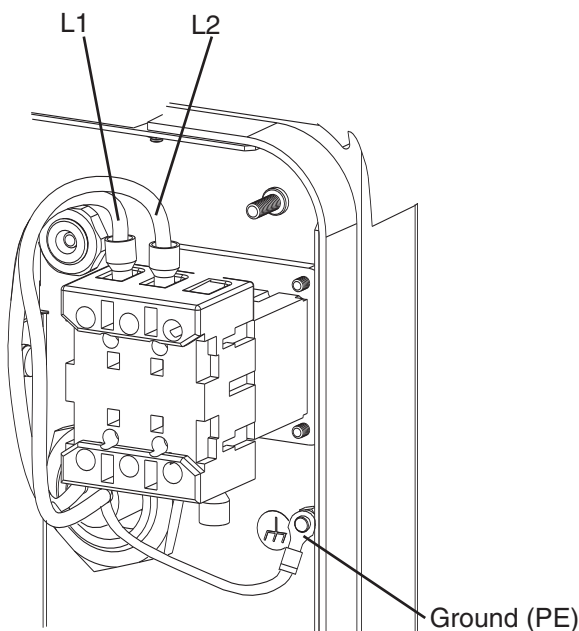

Single-phase

	Standard unit
L1	Black
L2	White
PE	Green

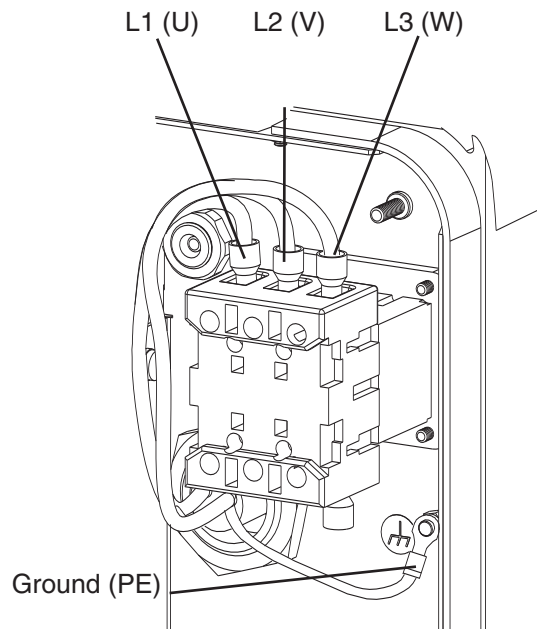

Three-phase

	Standard unit	CE unit
L1	Black	Black (U)
L2	White	Blue or Grey (V)
L3	Red	Brown (W)
PE	Green	Green/Yellow

Torch replacement

- ① Turn OFF (O) the power switch.

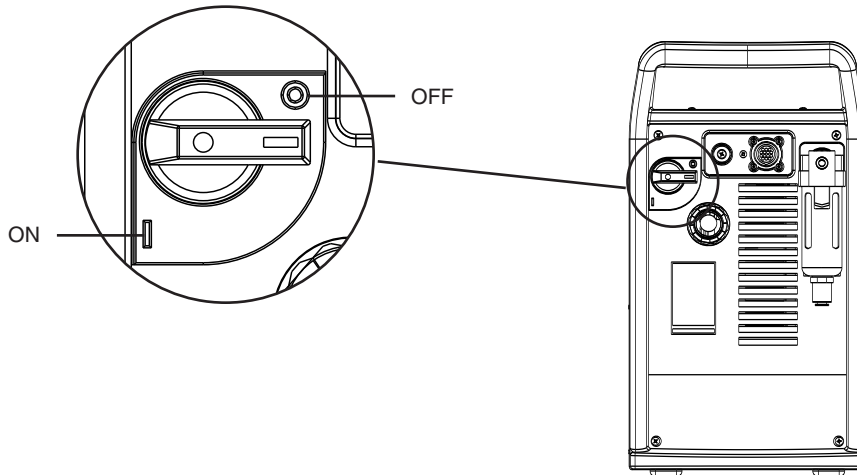

- ② Unplug the power cord from the power receptacle.

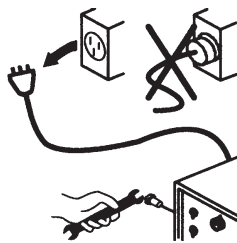

- ③ Open the Easy Torch Removal (ETR) door and route the lead through the end cap.

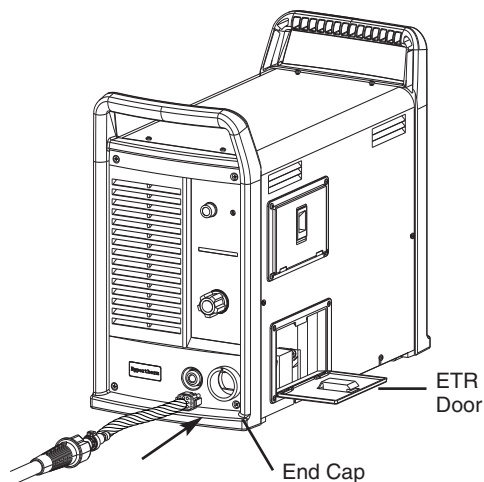

- ④ Align the marks on the strain relief with the marks on the end cap.

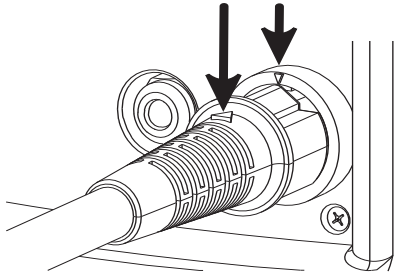

- ⑤ Pull back the quick-release collar and insert the lead's gas fitting.

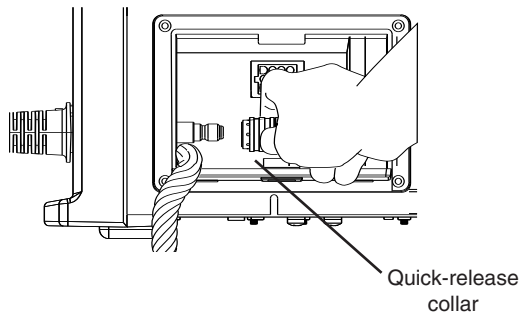

- ⑥ Slide the quick-release collar forward to lock in the gas fitting. Verify that the gas fitting is secure.

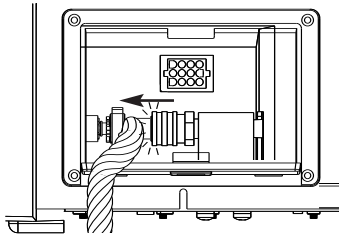

- ⑦ Verify that the red dot on the connector is on top, then plug in the electrical connector. Close the ETR door.

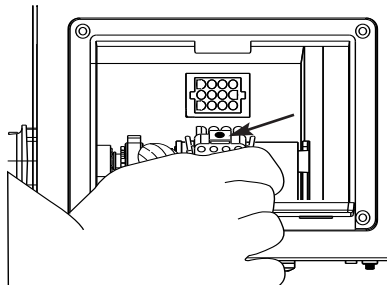

Filter element replacement

- ① Disconnect the electrical power and the gas supply.
Remove the filter bowl.
 - A. Pull down and hold the black release tab (If you do not see the tab, check the back of the filter bowl.)
 - B. Rotate the filter bowl in either direction until it releases.
 - C. Pull the filter bowl down to remove it. The bowl has an o-ring around the top. Do not discard the o-ring.

If the o-ring shows signs of wear or otherwise needs replacement, verify that you have the correct o-ring for the filter. (Each filter has a label on one side of the filter body.)

- For AF30 filters, use part number 011105.
- For NAF3000 filters, use part number 011094.

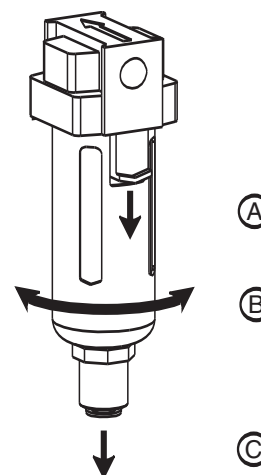

- ② Use a screwdriver to remove the old filter element from the filter housing. Then install the new filter element.

Note: Do not allow the filter element to turn when loosening the screw.

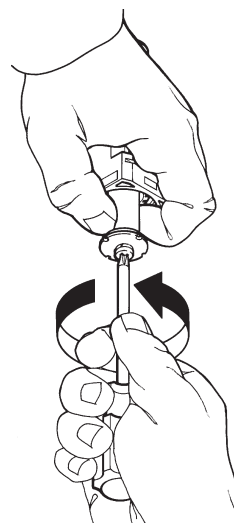

- ③ Re-install the filter bowl.
 - A. Hold the black tab down and slide the filter bowl over the filter element.
 - B. Align the marks on the filter bowl and the filter body.
 - C. Rotate the filter bowl until it locks in place.

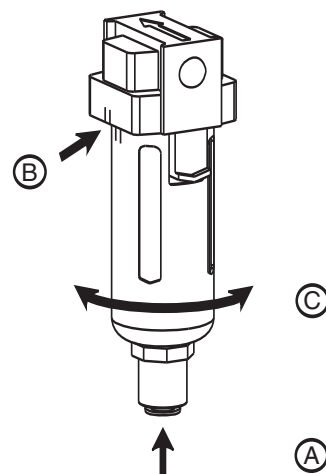

Work cable replacement

Disconnect the electrical power, gas supply and torch lead before removing the old work cable.

1. Remove the power supply cover.
2. Install the strain relief to the power supply and secure it with a nut.
3. Tighten the strain relief collar onto the cable.
4. Connect the work cable to the power board at J14. Tighten the nut to 10 in-lb (12 kg cm) of torque.
5. Install the ETR barrier.
6. Install the power supply cover.



Caution: This is a high-current connection. Proper torque is critical.

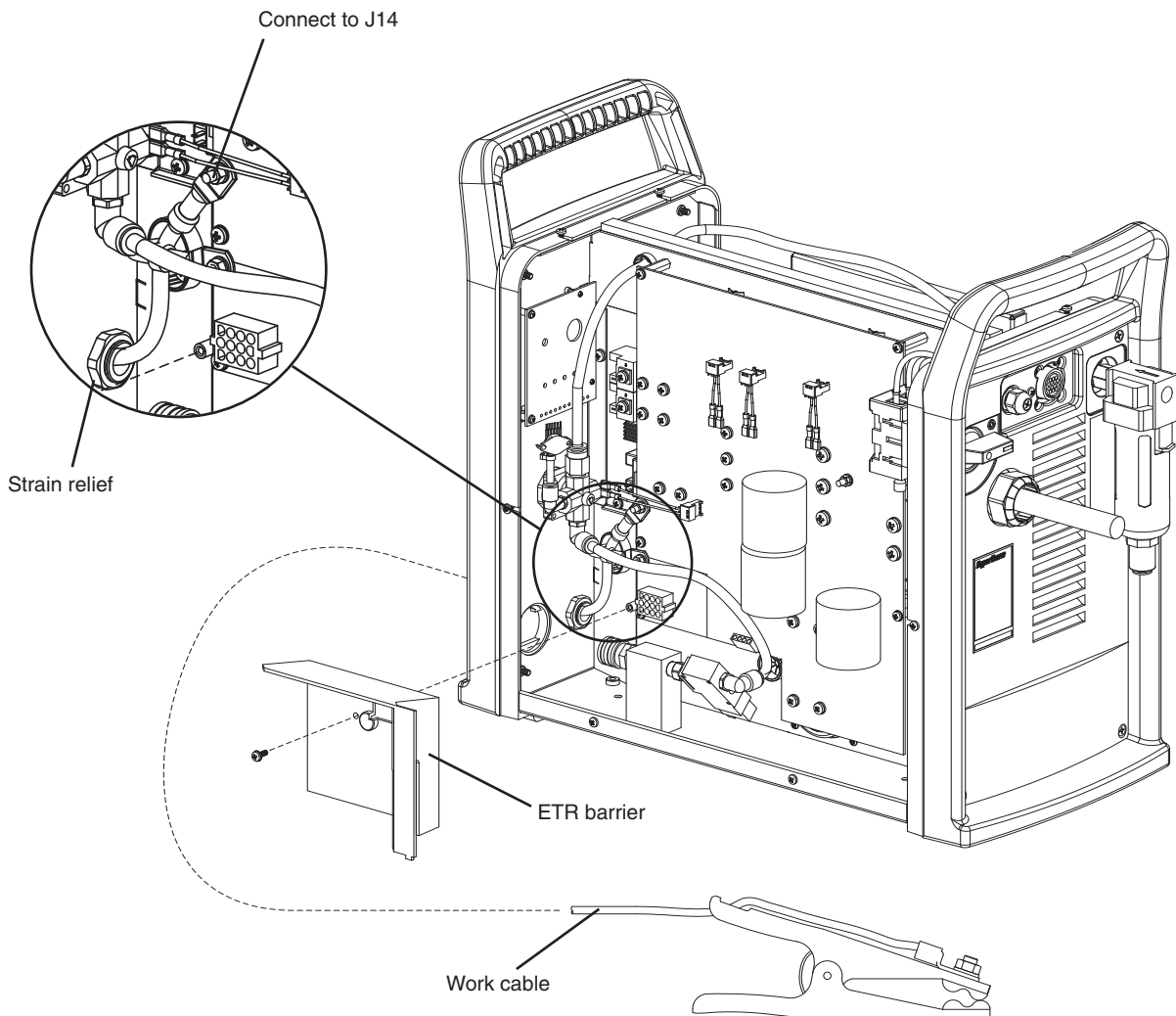

Capacitor replacement

Removal

1. Disconnect the electrical power and gas supply before removing the power supply cover.
2. Remove the two screws that secure the capacitor(either C94 or C98) to the power board.
3. Remove the fan assembly.
4. Remove the capacitor from the fan side of the power supply.

Installation

1. Align the bleeder hole on the capacitor with the view hole on the power board.
2. Install the new capacitor and secure it with 2 screws. Tighten the screws to 20 in-lb (24 kg cm) of torque.
3. Install the power supply cover.

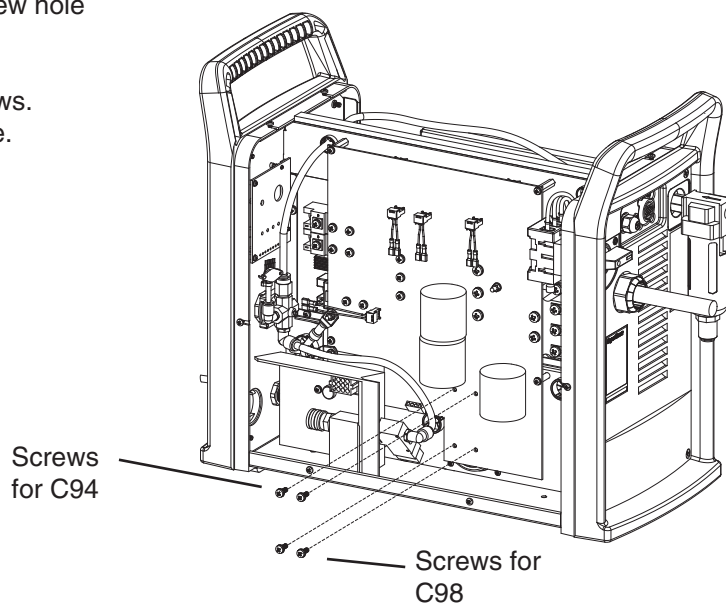

Remove and install screws from power board side.

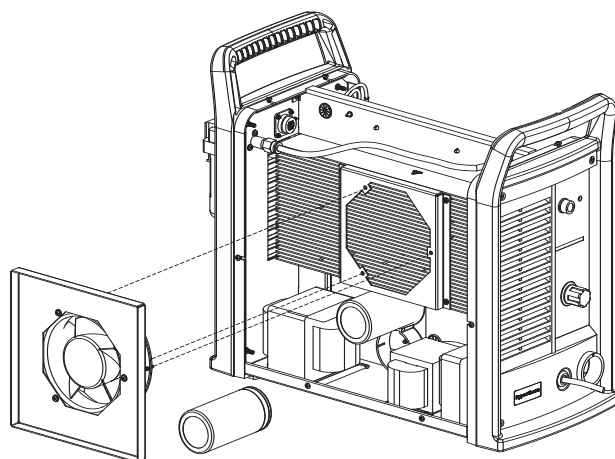

Remove and install capacitors from fan side.

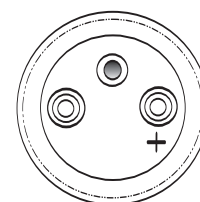
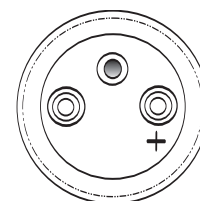

Correct installation

Power board removal and replacement

It may be necessary to remove the power board from the power supply to replace it or to replace components, such as IGBTs, located behind it.

	<p style="text-align: center;">CAUTION</p> <p style="text-align: center;">STATIC ELECTRICITY CAN DAMAGE CIRCUIT BOARDS</p> <p>Use proper precautions when handling printed circuit boards.</p> <ul style="list-style-type: none">• Store PC boards in anti-static containers.• Wear a grounded wrist strap when handling PC boards.
---	--

Removal

1. Disconnect the electrical power and the gas supply.
2. Remove the cover from the power supply by removing the 12 screws and then lifting off the cover.
3. Remove the insulation panel by removing the screws on the right edge and bottom edge.
4. Disconnect the torch lead and then remove the ETR barrier.
5. Disconnect the pilot arc gate drive and the IGBT gate drives from the power board. Then remove the nuts that attach the work lead and power cord ground cable to the power board.

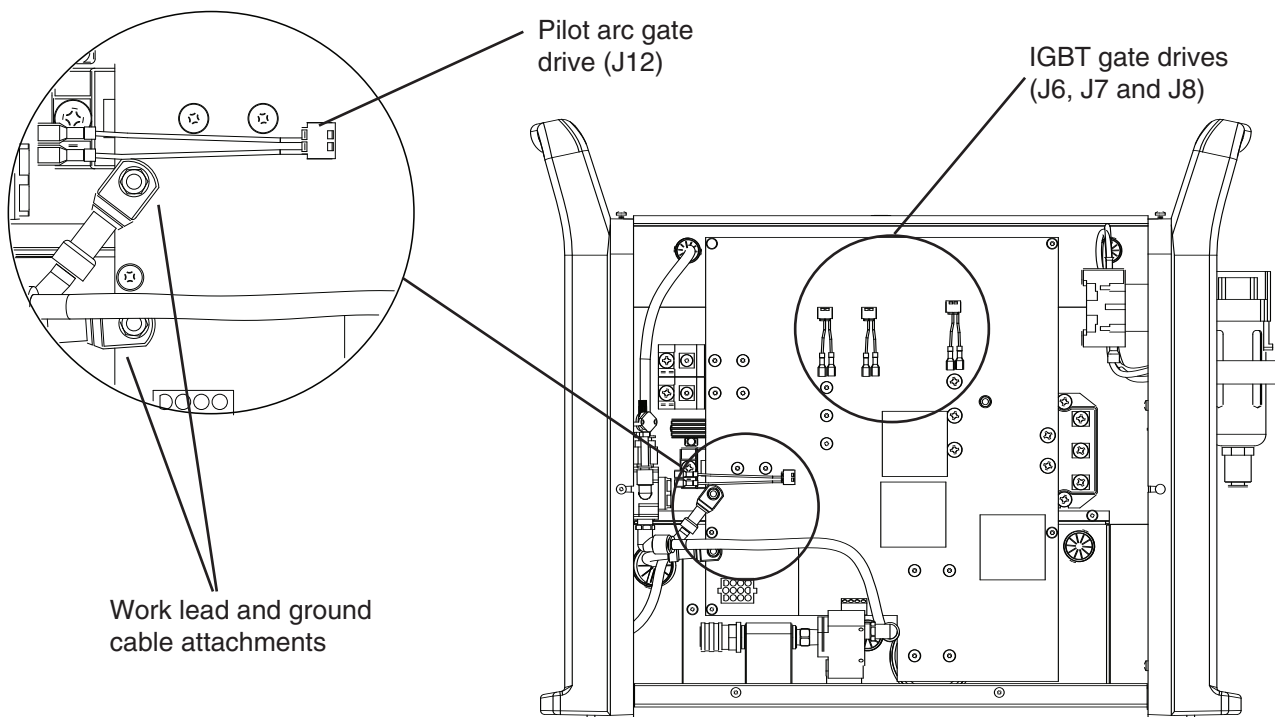

6. Disconnect the pin connectors and cables attached to the board at:

- J1, J2 and J3
- J5
- The ribbon cable at J14
- The current sensor cable at J9
- J11 and J13
- J20 and J21

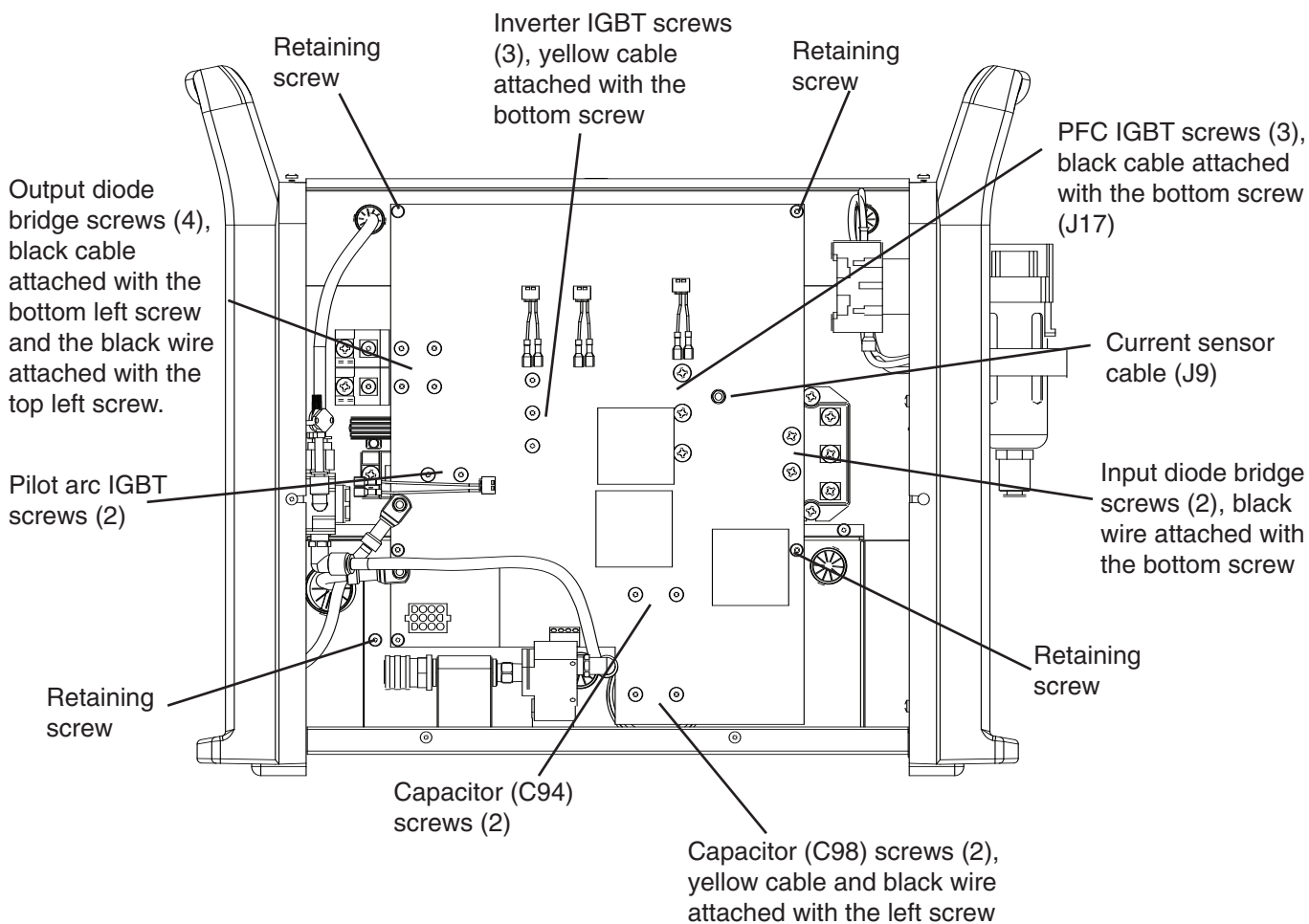

7. Remove the screws that secure the power board to the capacitors, the input diode bridge, and the IGBTs. Remove any cables connected at those points. Then remove the retaining screws from the power board.

8. Lift the power board out of the power supply and store it in an anti-static container until you are ready to re-install it.

Installation

1. Seat the power board into the base of the power supply. Then replace the retaining screws that hold the power board in place.
2. Attach all gate drives, cables, IGBT and capacitor screws, wires and input and output diode screws.

Note: The required torque for each of these screws is 20 in-lb (24 kg cm).

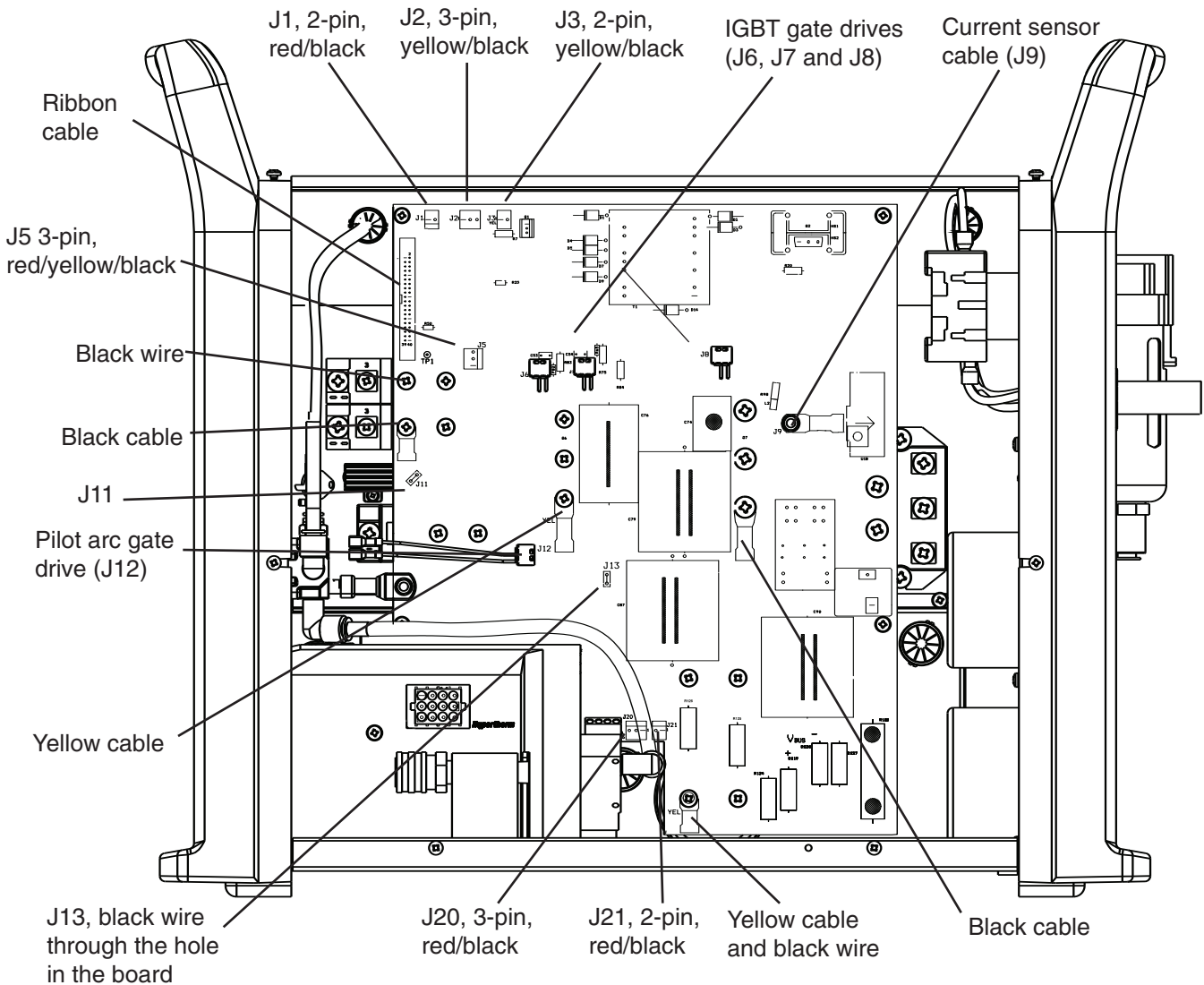

3. Reattach the work lead, and power cord ground cable.
4. Re-install the ETR barrier and reconnect the torch lead.
5. Replace the insulation panel and the cover on the power supply.
6. Reconnect the gas supply and the electrical power.

Heat sink component replacement

1. Unscrew the old components from the heat sink and use isopropyl alcohol to remove the old thermal grease.
2. Install the new components to the heat sink as shown below.
3. Use new thermal pads on the temperature sensor.
4. Use thermal grease on all components. Apply a thin coat (3 mils or paper equivalent) to the component, install with screws, and tighten to the required torque.
5. Clean the excess grease from the heat sink.

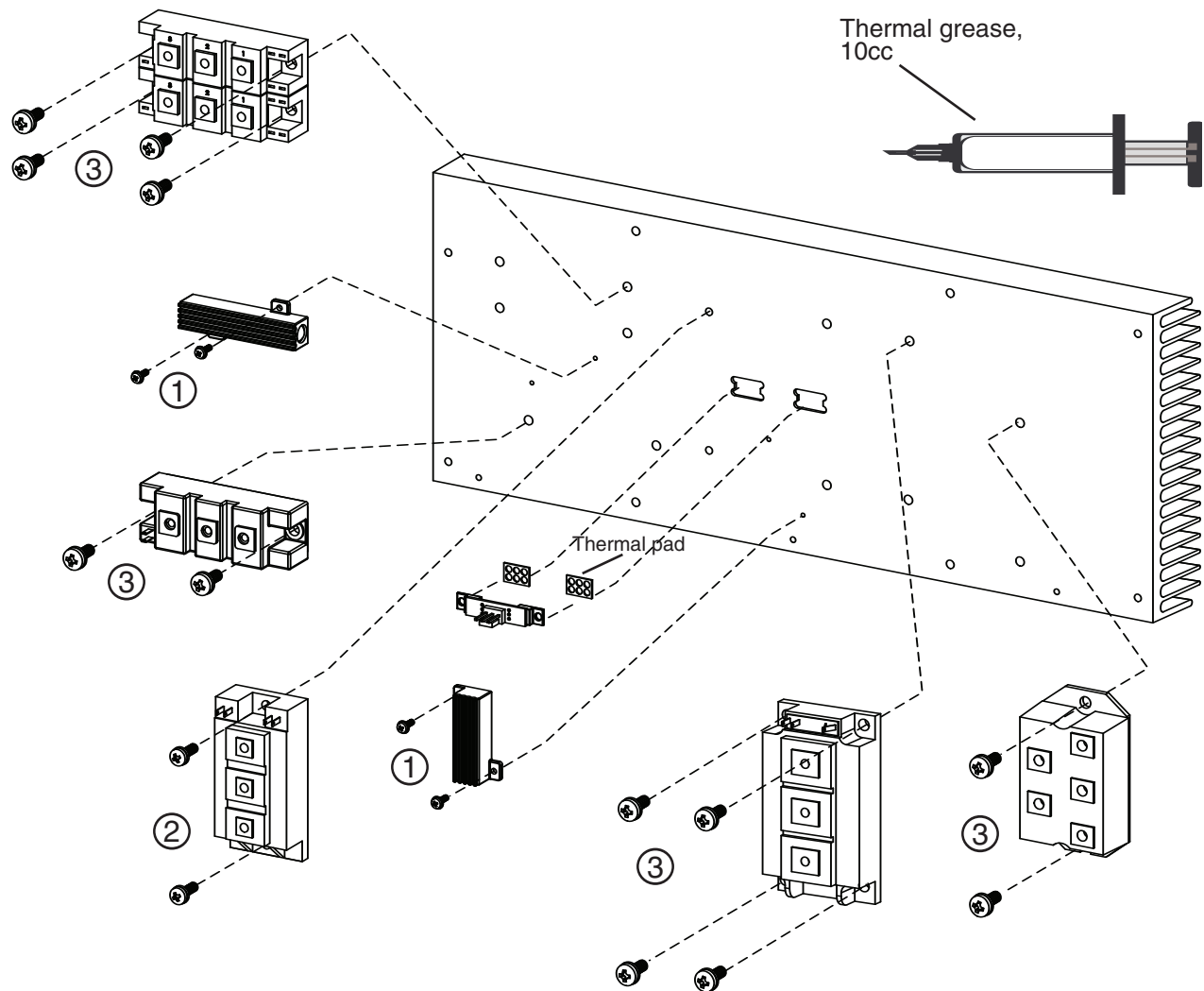

Notes:

- ① Apply thermal grease and torque to 8 in-lb (9 kg cm).
- ② Apply thermal grease and torque to 20 in-lb (23 kg cm).
- ③ Apply thermal grease and torque to 35 in-lb (40 kg cm).

Section 4

PARTS – POWER SUPPLY

In this section:

Exterior	4-2
Interior right side	4-3
Back interior right side	4-4
Interior fan side	4-5
Heat sink assembly.....	4-6
Recommended spare parts	4-7

Exterior

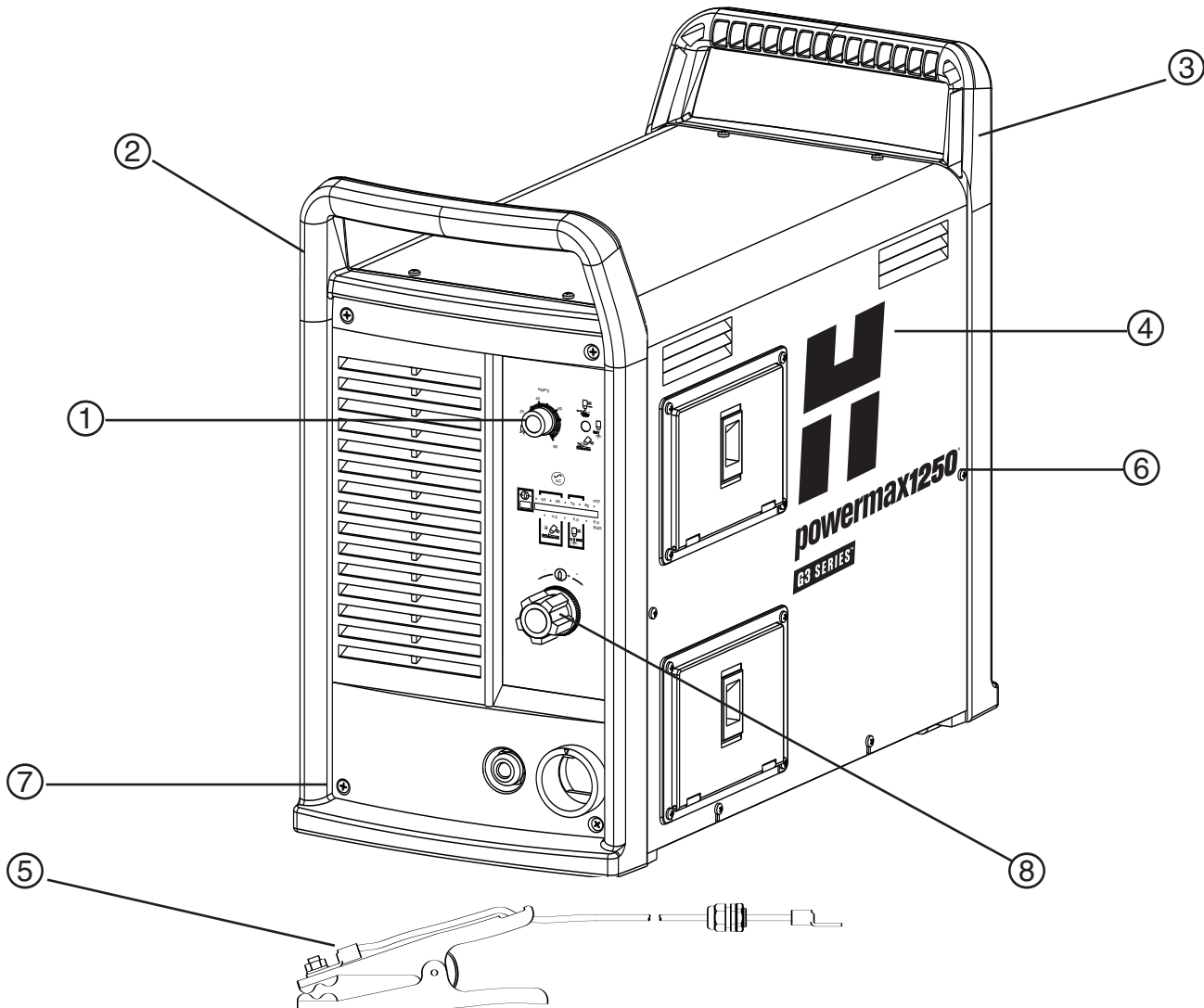

Item	Part number	Description	Qty.
	128631	Kit: Labels, domestic	1
	128632	Kit: Labels, CE	1
1	008965	Current adjustment knob	1
2	128624	Kit: Front panel, Domestic	1
	128625	Kit: Front panel, CE	1
3	128974	Kit: Rear panel	1
4	128620	Kit: Power supply cover with labels, domestic	1
	128621	Kit: Power supply cover with labels, CE	1
5	123645	Work cable with clip, 20 ft (6.1 m)	1
6	128629	Kit: Cover screws	12
7	128630	Kit: End panel screws	8
8	011096	Regulator knob	1

Interior right side

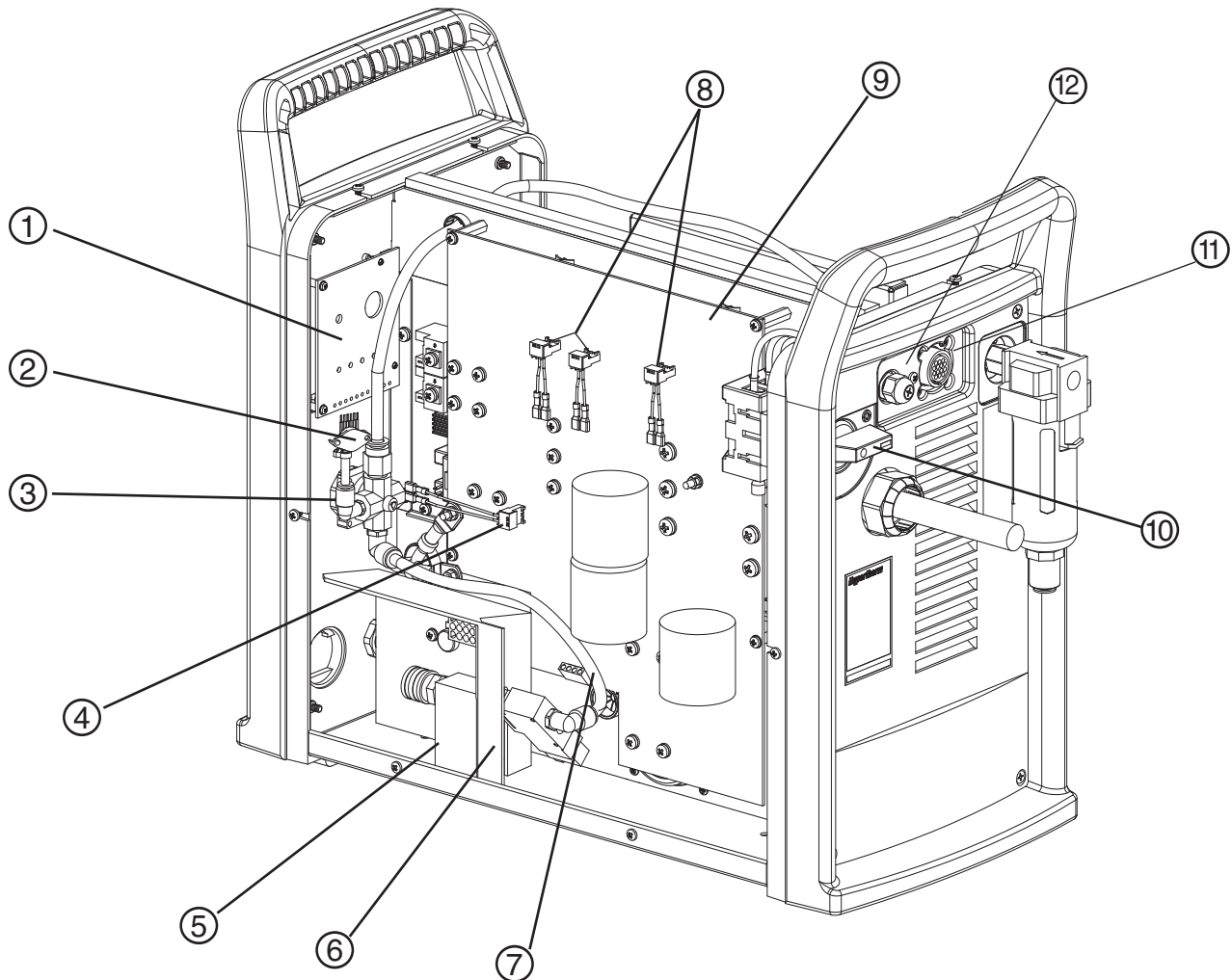

Item	Part number	Description	Designator	Qty.
1	128660	Kit: Control board, domestic	PCB3	1
	128661	Kit: Control board, CE	PCB3	1
2	128659	Kit: Pressure Sensor		1
3	128801	Kit: Pressure Regulator		1
4	123604	Pilot Arc IGBT Cable		1
5	128622	Kit: Gas Manifold with solenoid valve	V1	1
6	128628	Kit: ETR Box		1
7	046116	Tubing, 8mm OD, 6mm ID, nylon		3 ft.
8	123602	Gate Drive Cables		3
9	128663	Kit: Power board	PCB2	1
10	108211	On/Off Knob		1
11	128662	Kit: Machine Interface		1
12	128665	Kit: Strain relief, arc voltage		1

Back interior right side

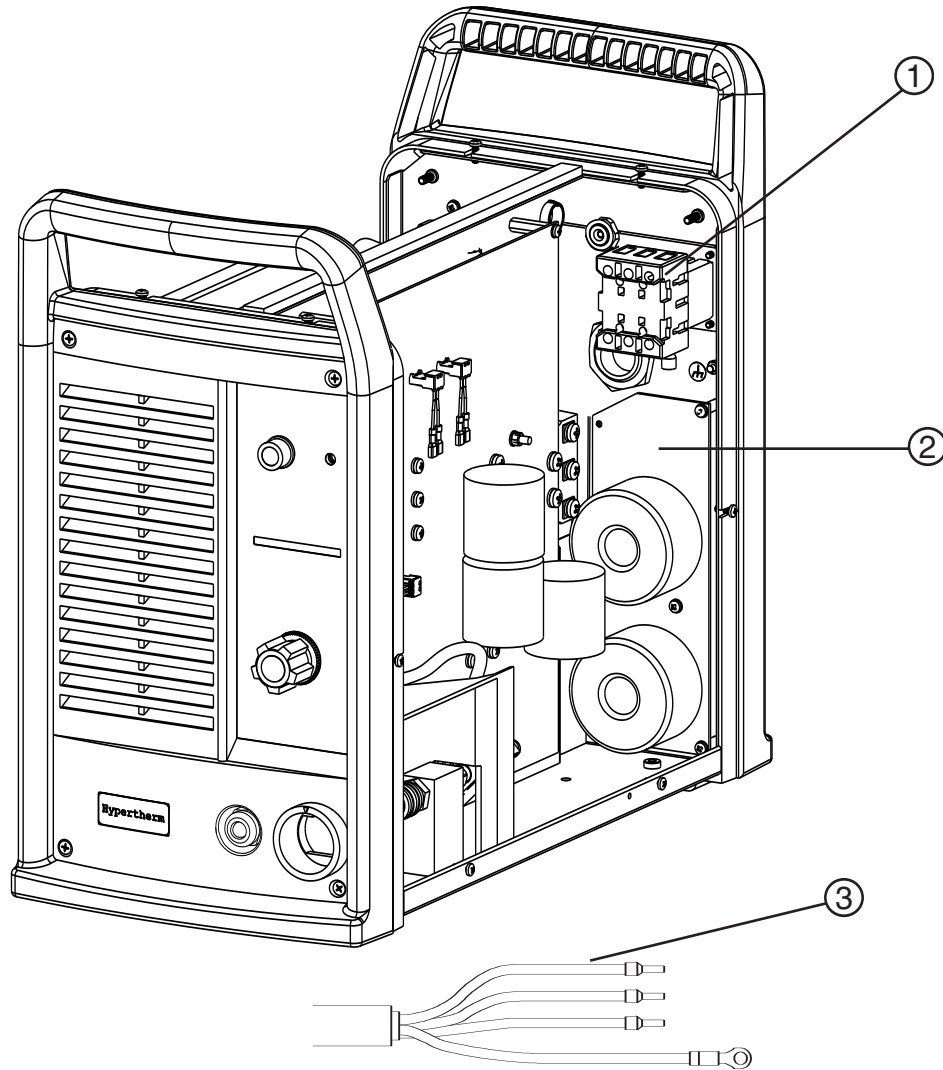

Item	Part number	Description	Designator	Qty.
1	128672	Kit: Power switch	S1	1
2	128671	Kit: EMI filter PCB, CE only	PCB1	1
3	128666	Kit: 8 ft (2.5 m) power cable, domestic 3PH		1
	128667	Kit: 8 ft (2.5 m) power cable, CE 3PH		1

Interior fan side

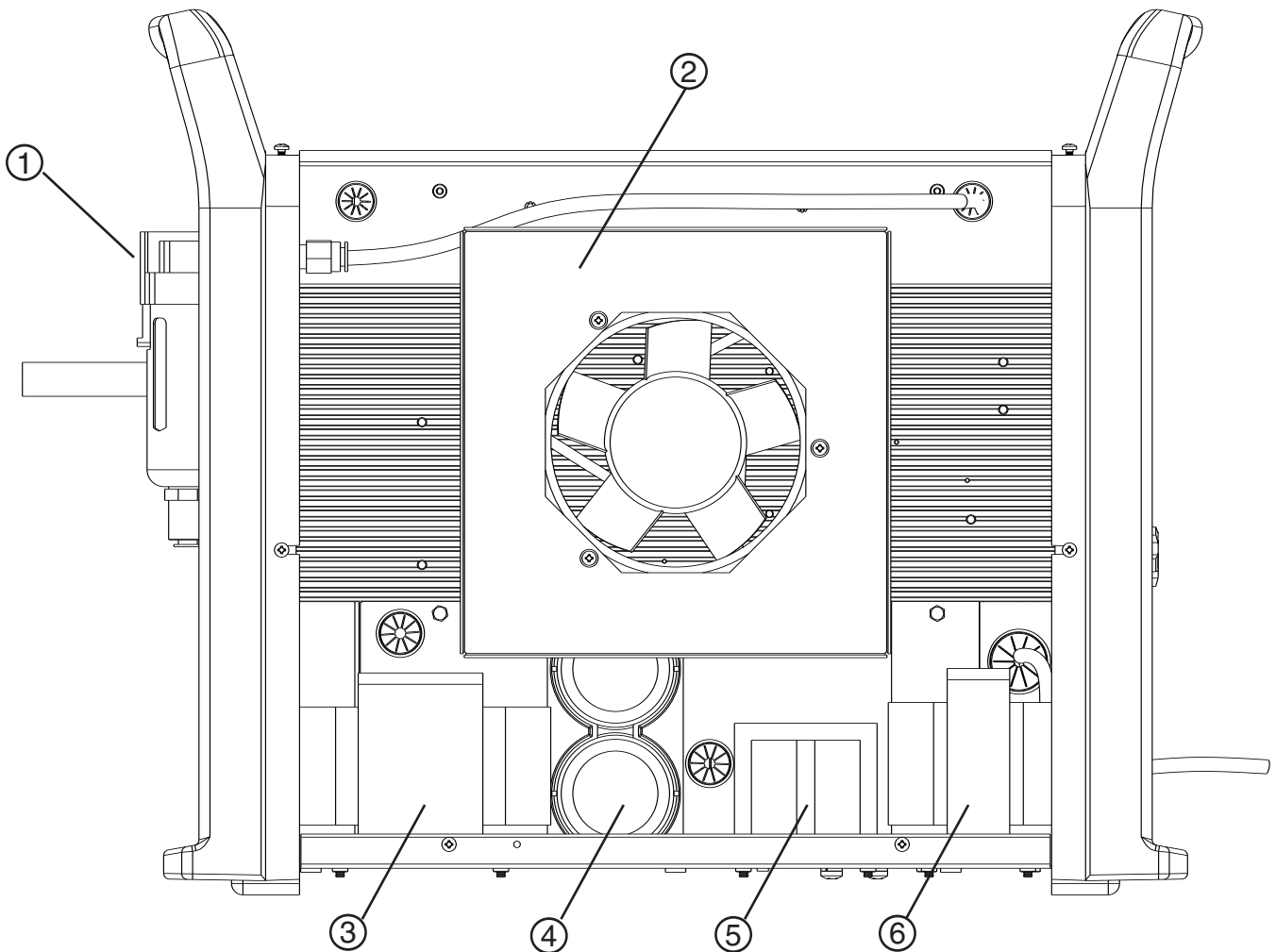

Item	Part number	Description	Designator	Qty.
1	128627	Kit: Filter		1
	011093	Air filter element		1
	011094	O-ring, NAF3000 filter		1
	011105	O-ring, AF30 filter		1
2	228021	Kit: Fan	M1	1
3	128680	Kit: Inductor, input choke	L2	1
4	128673	Kit: Capacitor	C94, C98	2
5	128664	Kit: Power transformer	T2	1
6	128679	Kit: Inductor, output choke	L1	1

Heat sink assembly

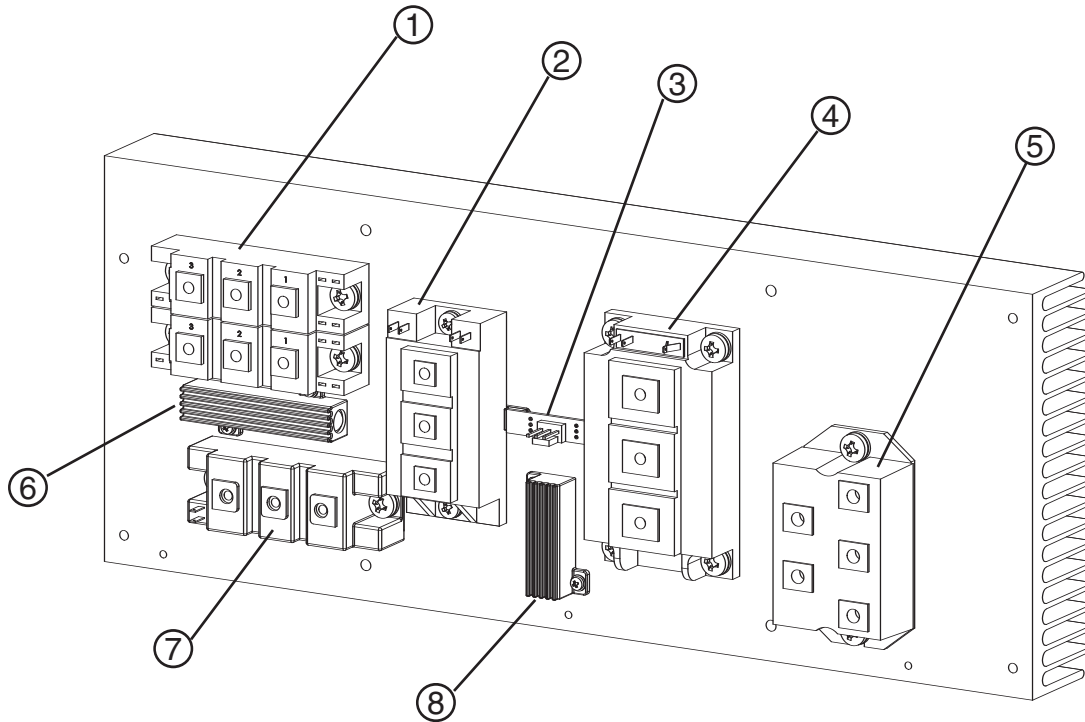

Item	Part number	Description	Designator	Qty.
	127128	Thermal grease, T-grease 2500™, 10cc		1
1	128677	Kit: Output diode bridge	D25	1
2	128676	Kit: Inverter IGBT	Q6	1
3	128684	Kit: Temperature Sensor	PCB4	1
4	228071	Kit: PFC IGBT	Q7	1
	128675	Kit: PFC IGBT		
		For serial numbers below 1250-014785 or 1250014795 (CE)		
5	128678	Kit: Input diode bridge	D24	1
6	128670	Kit: Snubber resistor (7.5 Ω)		1
7	128674	Kit: pilot arc IGBT	Q8	1
8	128669	Snubber resistor (20 Ω)		1

Reference Section 3, *Heat sink component replacement*, for torque specifications.

Recommended spare parts

Part number	Description.....	Page reference
008965.....	Current adjustment knob	4-2
128660.....	Kit: Control board, domestic	4-3
128661.....	Kit: Control board, CE.....	4-3
128659.....	Kit: Pressure sensor	4-3
128801.....	Kit: Pressure regulator.....	4-3
128622.....	Kit: Gas manifold with solenoid valve	4-3
123106.....	Work cable with clamp, 20 ft (6.1 m)	4-3
128663.....	Kit: Power board	4-3
128672.....	Kit: Power switch	4-4
128671.....	Kit: EMI Filter PCB, CE only	4-4
128627.....	Kit: Filter.....	4-5
011093.....	Air filter element.....	4-5
011094.....	O-ring, NAF3000 filter.....	4-5
011105.....	O-ring, AF30 filter.....	4-5
228021.....	Kit: Fan	4-5
128673.....	Kit: Capacitor	4-5
127128.....	Thermal grease, 10 cc T-grease 2500.....	4-6
128677.....	Kit: Output diode bridge.....	4-6
128676.....	Kit: Inverter IGBT	4-6
228071.....	Kit: PFC IGBT	4-6
128675.....	Kit: PFC IGBT	4-6
	For serial numbers below 1250-014785 or 1250-014795 (CE)	
128678.....	Kit: Input diode bridge.....	4-6
128674.....	Kit: Pilot arc IGBT	4-6

Section 5

PARTS – TORCH AND CONSUMABLES

In this section:

T80 hand torch assembly	5-2
T80M machine torch assembly	5-4
T80 consumable configurations	5-6
T80M consumable configurations	5-7
Recommended spare parts	5-8

T80 hand torch assembly

Item	Part number	Description	Quantity
	087001*	T80 hand torch assembly with 25 ft (7.6 m) lead	
	087002*	T80 hand torch assembly with 50 ft (15.2 m) lead	
	087047*	T80 hand torch assembly with 75 ft (22.5 m) lead	
1	128564	Kit: T80 torch main body replacement	1
2	027889	Retaining clip	1
3	058519	O-ring	1
4	128639	Kit: Cap-off sensor replacement	1
5	075571	Cap-off sensor screws	2
6	128521	Kit: T80/T80M torch head replacement	1
7	128644	Kit: Handle replacement	1
8	075586	Handle screws	5
9	002244	Safety trigger assembly	1
10	027254	Spring	1
11	128637	Kit: T80 25 ft (7.6 m) torch lead replacement	1
12	128636	Kit: T80 50 ft (15.2 m) torch lead replacement	1
13	128893	Kit: T80 75 ft (22.5 m) torch lead replacement	1
14	128638	Kit: ETR connector replacement	1
15	128642	Kit: T80 start switch replacement	1

* Top assembly includes the following consumables (See *T80 consumable configurations* for descriptions of consumable parts):

120926	Electrode	1
120925	Swirl ring	1
120928	Retaining cap	1
120929	Shield	1
120927	Nozzle	1

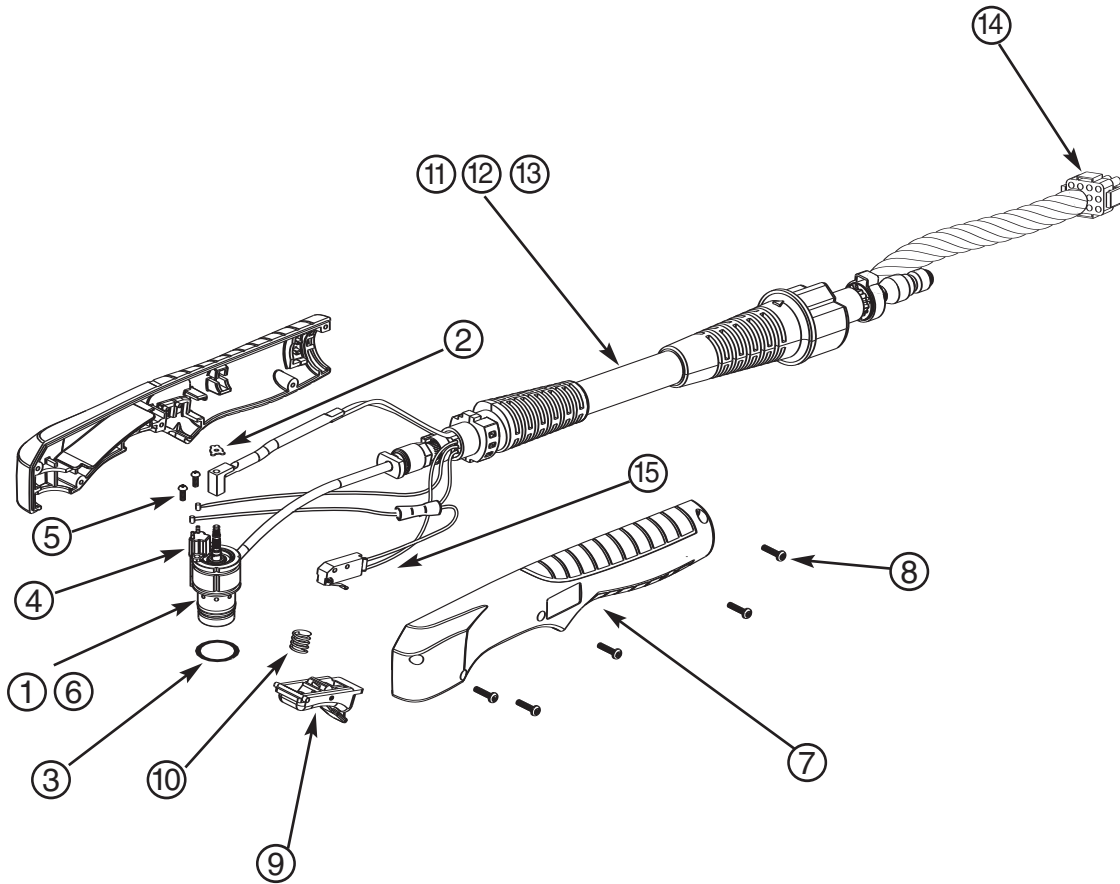

T80M machine torch assembly

Item	Part number	Description	Quantity
	087003*	T80M machine torch assembly with 15 ft (4.6 m) lead	
	087004*	T80M machine torch assembly with 25 ft (7.6 m) lead	
	087005*	T80M machine torch assembly with 35 ft (10.7 m) lead	
	087006*	T80M machine torch assembly with 50 ft (15.2 m) lead	
	087048*	T80M machine torch assembly with 75 ft (22.5 m) lead	
1	128640	Kit: T80M torch main body replacement	1
2	027889	Retaining Clip	1
3	058519	O-ring	1
4	128639	Kit: Cap-off sensor replacement	1
5	075571	Cap-off sensor screws	2
6	128521	Kit: T80/T80M torch head repair	1
7	128643	Kit: Torch mounting sleeve replacement	1
8	075004	Torch mounting screws	3
9	128710	Torch positioning sleeve	1
10	128634	Kit: 15 ft (4.6 m) torch lead replacement	1
11	128633	Kit: 25 ft (7.6 m) torch lead replacement	1
12	128635	Kit: 35 ft (10.7 m) torch lead replacement	1
13	128641	Kit: 50 ft (15.2 m) torch lead replacement	1
14	128894	Kit: 75 ft (22.5 m) torch lead replacement	1
15	128638	Kit: ETR Repair	1
	128645	Kit: Torch Mounting (for reassembly after installation)	1

* Top assembly includes the following consumables (See *T80M consumable configurations* for details of consumable parts):

120926	Electrode	1
120925	Swirl ring	1
120928	Retaining cap	1
120930	Shield	1
120927	Nozzle	1

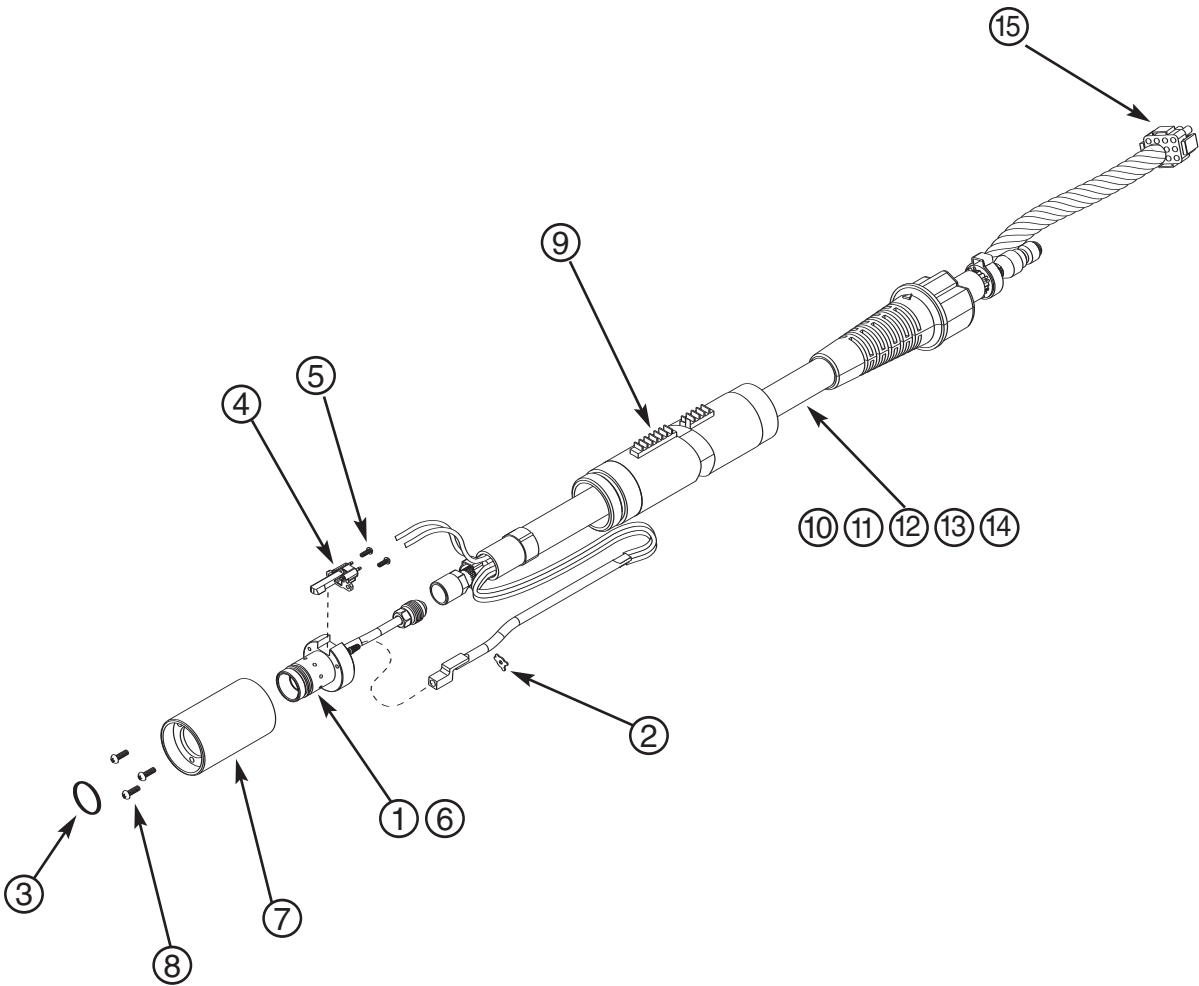

T80 consumable configurations

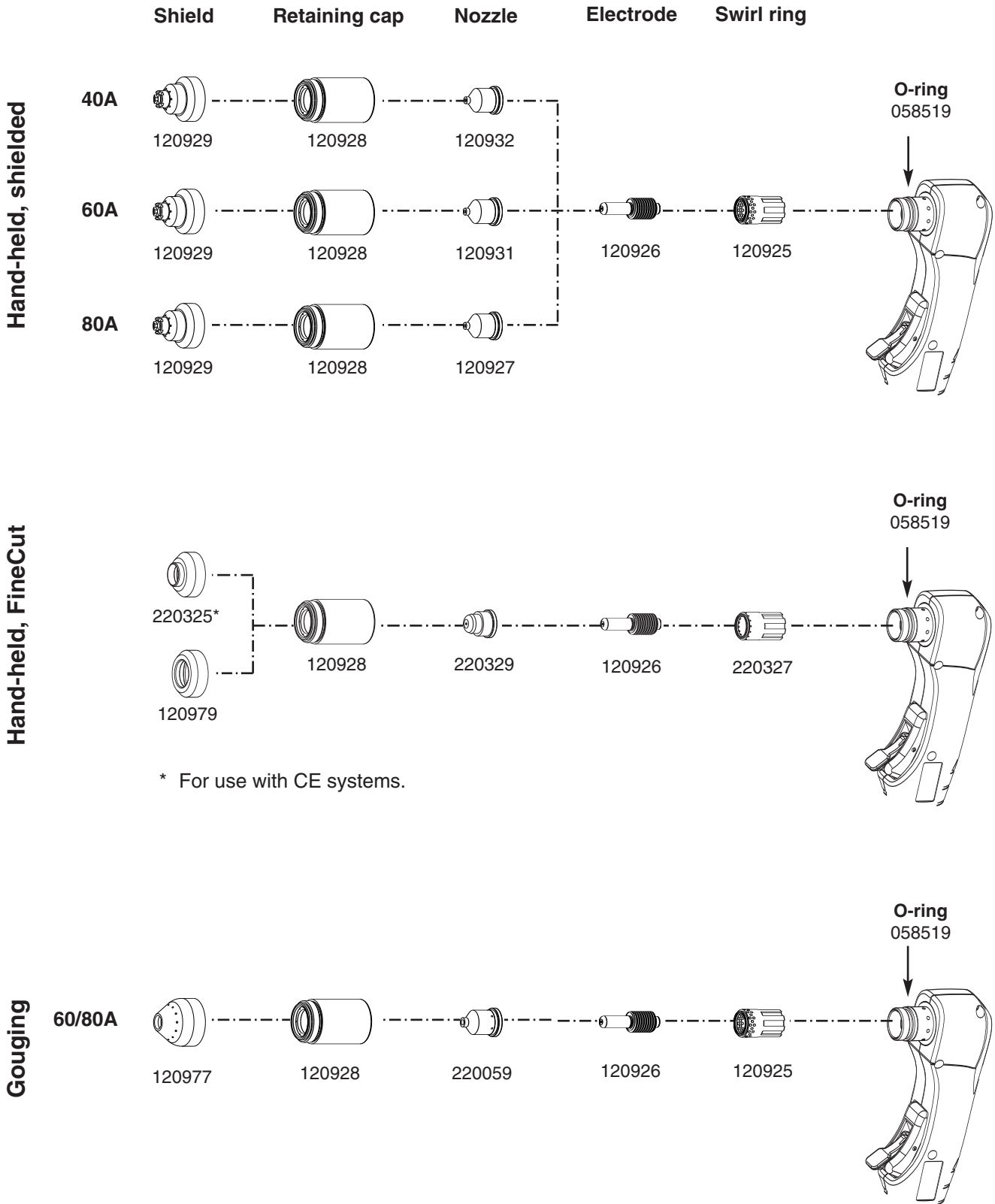

T80M consumable configurations

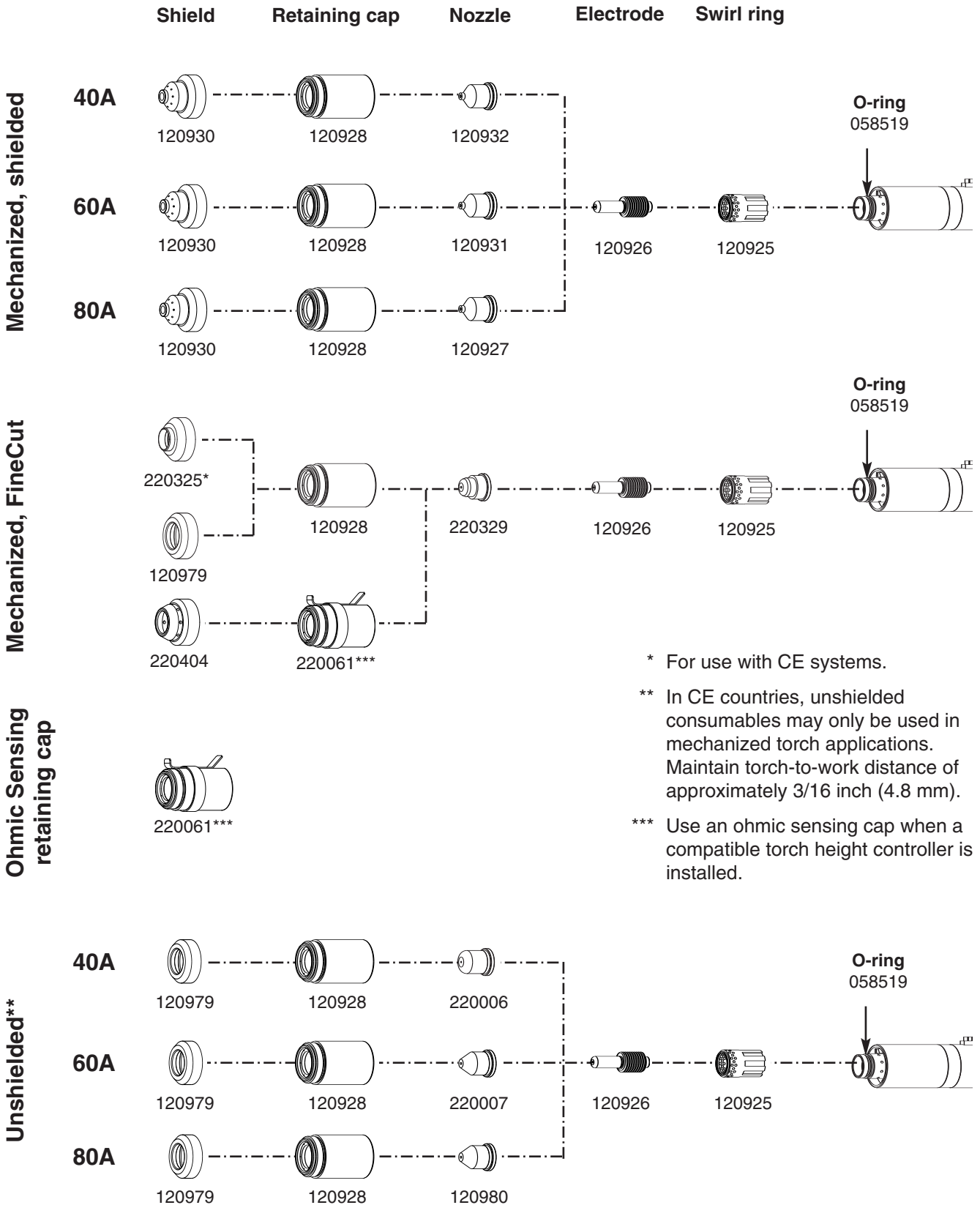

* For use with CE systems.

** In CE countries, unshielded consumables may only be used in mechanized torch applications. Maintain torch-to-work distance of approximately 3/16 inch (4.8 mm).

*** Use an ohmic sensing cap when a compatible torch height controller is installed.

Recommended spare parts

Part number	Description
058519	Torch o-ring
027055	Silicone lubricant, 1/4 Oz. Tube
128644	Kit: T80 torch handle replacement
128638	Kit: ETR connector replacement
075586	T80 torch handle screw (5 required)
002244	T80 torch trigger assembly with spring
027254	Replacement trigger spring, T80
128642	Kit: T80 start switch replacement
128564	Kit: T80 hand torch main body replacement
128640	Kit: T80M machine torch main body replacement
128639	Kit: T80/T80M torch cap sensor replacement
128888	Kit: FineCut consumables
128889	Kit: FineCut consumables – CE
087001	T80 hand torch assembly with 25 ft (7.6 m) lead
087004	T80M machine torch assembly 25 ft (7.6 m) lead

Section 6

WIRING DIAGRAMS

In this section:

Timing diagrams	6-2
Electrical schematics	6-5

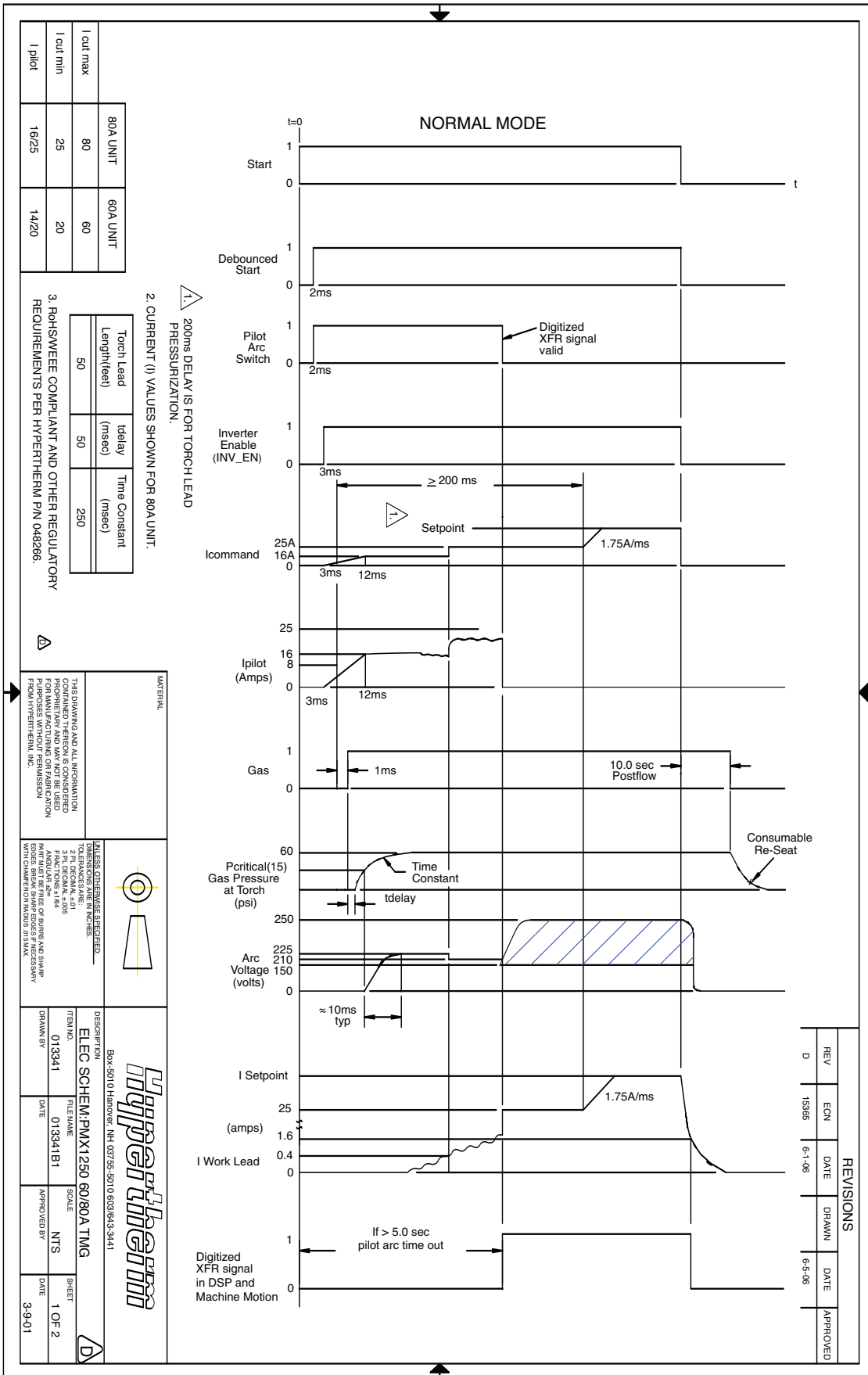

CPA OPERATION

NOTE: UNIT IS ALREADY IN TRANSFER MODE

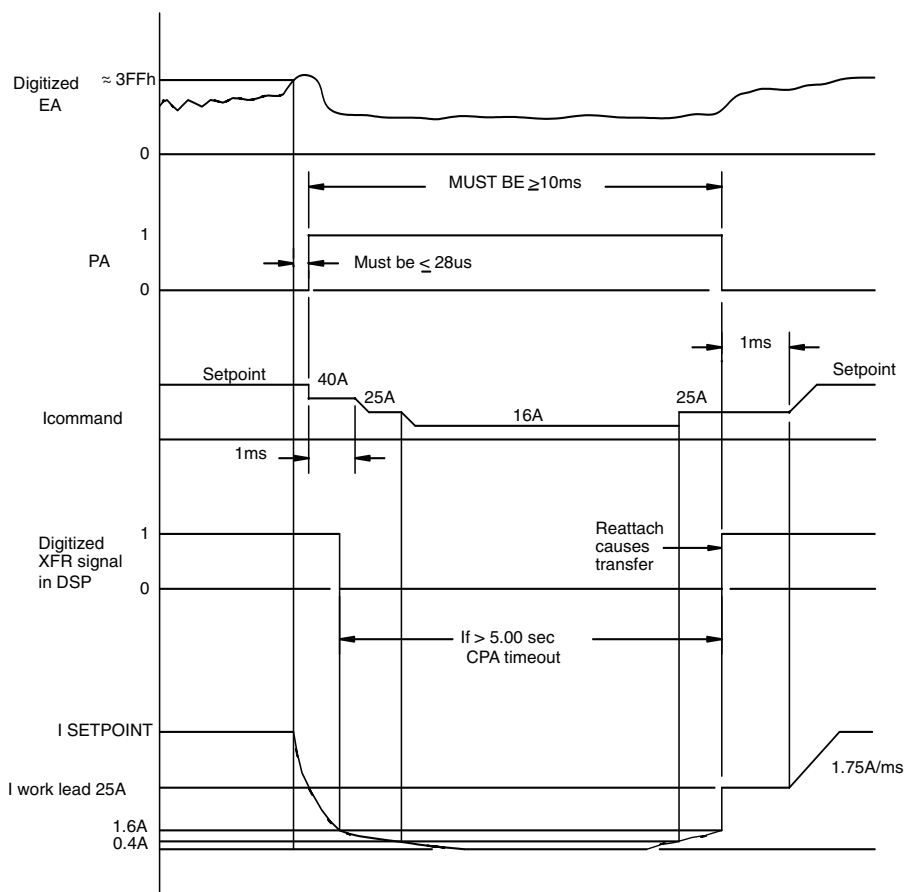

<p>THIS DRAWING AND ALL INFORMATION CONTAINED THEREON IS CONSIDERED PROPRIETARY AND MAY NOT BE USED FOR ANY OTHER PURPOSES WITHOUT PERMISSION FROM HYPERHERM, INC.</p>		<p>UNLESS OTHERWISE SPECIFIED, DIMENSIONS ARE IN INCHES. 1" = 25.4 MM 2 PL. DECIMAL, .01 3 PL. DECIMAL, .005 FRACTIONS, 1/64 PART MUST BE FREE OF BURRS AND SHARP EDGES. BREAK SHARP EDGES IF NECESSARY WITH CHAMFER OR RADIUS 0.125 MAX.</p>	
<p>Box: 5010 Hanover, NH 03755-5010 603.843.3441</p>			
<p>DESCRIPTION ELEC SCHEM-PMX1250 60/80A TMG</p>	<p>ITEM NO. 013341</p>	<p>FILE NAME 013341B2</p>	<p>SCALE NTS</p>
<p>DRAWN BY</p>	<p>DATE</p>	<p>APPROVED BY</p>	<p>SHEET 2 OF 2</p>
<p>DATE 3-9-01</p>	<p>DATE</p>		

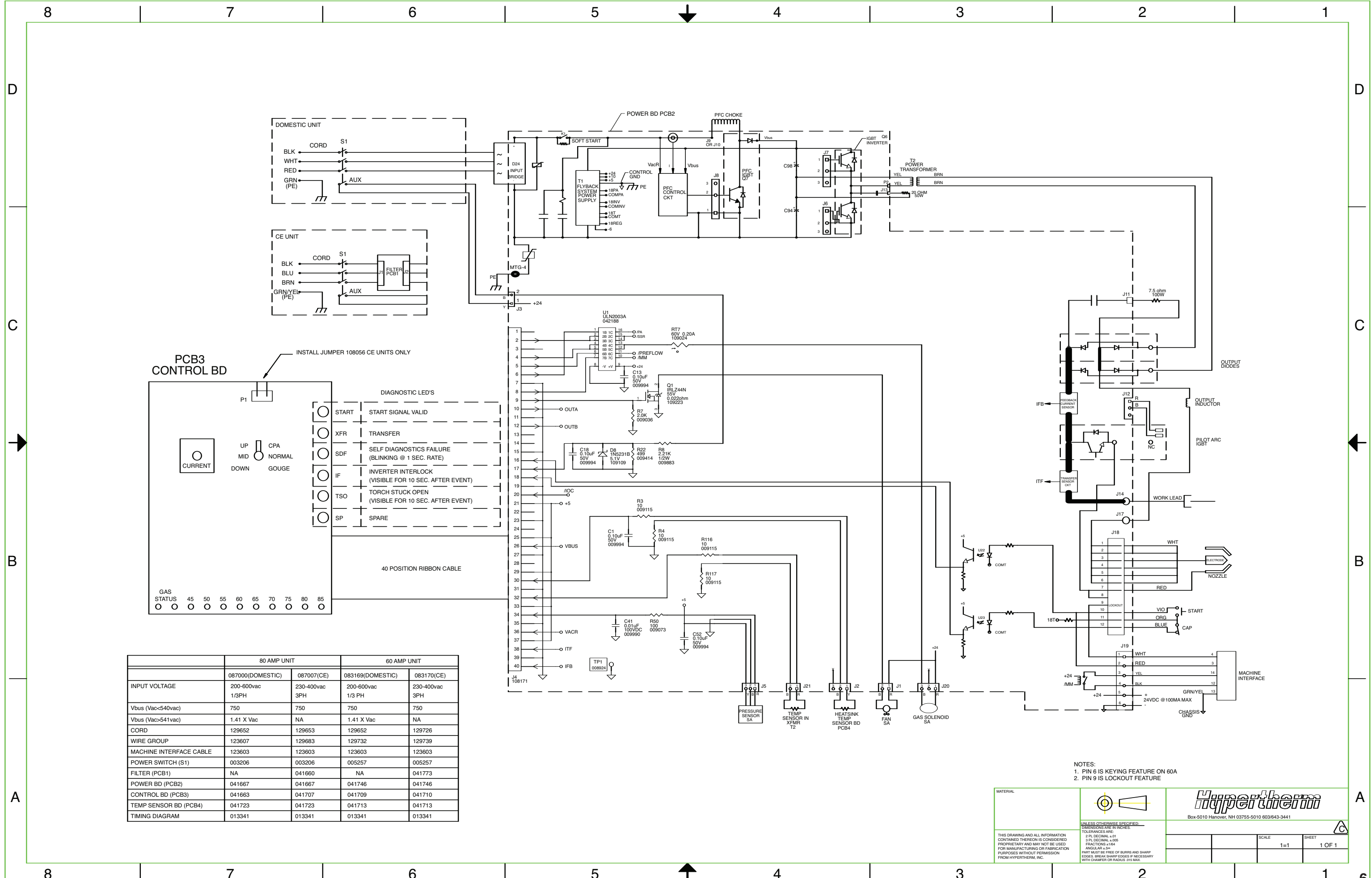

PCB3 CONTROL BD

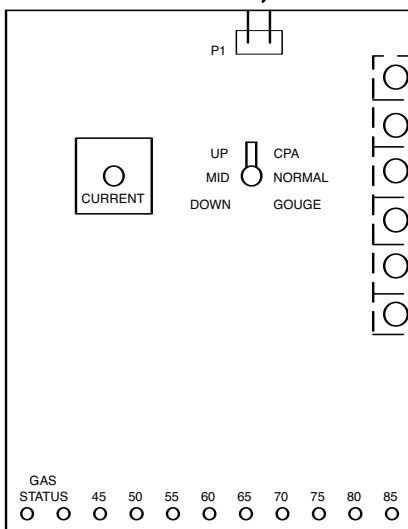

DIAGNOSTIC LED'S

START	START SIGNAL VALID
XFR	TRANSFER
SDF	SELF DIAGNOSTICS FAILURE (BLINKING @ 1 SEC. RATE)
IF	INVERTER INTERLOCK (VISIBLE FOR 10 SEC. AFTER EVENT)
TSO	TORCH STUCK OPEN (VISIBLE FOR 10 SEC. AFTER EVENT)
SP	SPARE

	80 AMP UNIT		60 AMP UNIT	
	087000(DOMESTIC)	087007(CE)	083169(DOMESTIC)	083170(CE)
INPUT VOLTAGE	200-600vac 1/3PH	230-400vac 3PH	200-600vac 1/3 PH	230-400vac 3PH
Vbus (Vac<540vac)	750	750	750	750
Vbus (Vac<541vac)	1.41 X Vac	NA	1.41 X Vac	NA
CORD	129652	129653	129652	129726
WIRE GROUP	123607	129683	129732	129739
MACHINE INTERFACE CABLE	123603	123603	123603	123603
POWER SWITCH (S1)	003206	003206	005257	005257
FILTER (PCB1)	NA	041660	NA	041773
POWER BD (PCB2)	041667	041667	041746	041746
CONTROL BD (PCB3)	041663	041707	041709	041710
TEMP SENSOR BD (PCB4)	041723	041723	041713	041713
TIMING DIAGRAM	013341	013341	013341	013341

- NOTES:
 1. PIN 6 IS KEYING FEATURE ON 60A
 2. PIN 9 IS LOCKOUT FEATURE

MATERIAL THIS DRAWING AND ALL INFORMATION CONTAINED THEREON IS CONSIDERED PROPRIETARY AND MAY NOT BE USED FOR MANUFACTURING OR FABRICATION PURPOSES WITHOUT PERMISSION FROM HYPERTHERM, INC.	<p>Box 5010 Hanover, NH 03755-5010 603/643-3441</p>	<p>UNLESS OTHERWISE SPECIFIED: DIMENSIONS ARE IN INCHES 10 DECIMALS ARE: 2 PL. DECIMAL = .01 3 PL. DECIMAL = .005 FRACTIONS = 1/64 ANGULAR ±.5° PART MUST BE FREE OF BURRS AND SHARP EDGES. BREAK SHARP EDGES IF NECESSARY WITH CHAMFER OR RADIUS. .05 MAX.</p>	SCALE	SHEET
			1=1	1 OF 1