

35594 PDF

Practical Plumbing H A N D B O O K

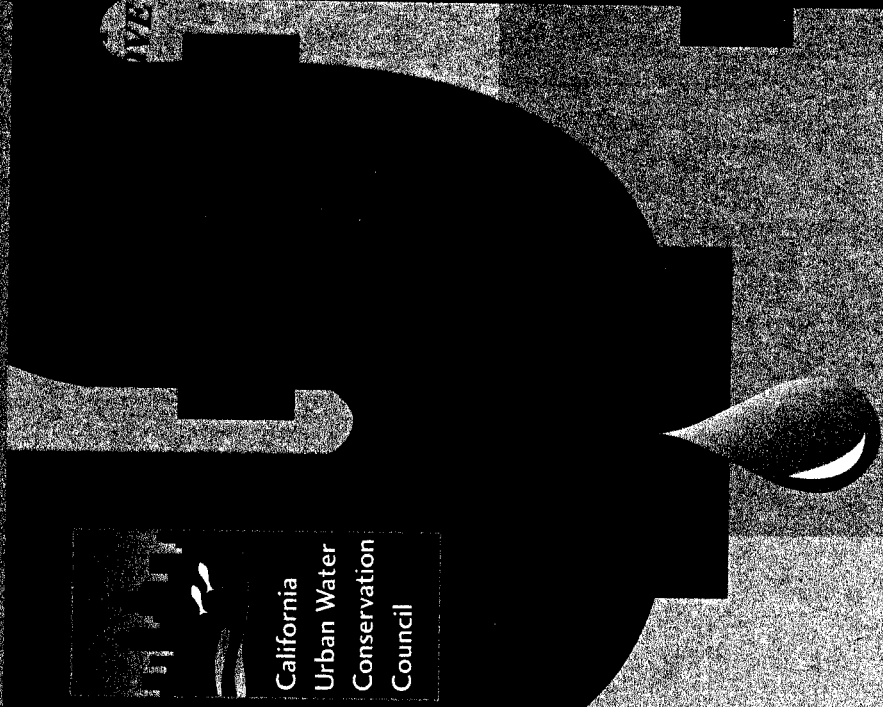

*Includes important
water-saving tips*



California
Urban Water
Conservation
Council

**Thank you so much for helping
us conserve our most valuable
resource: water.**

Many thanks to the following professionals
and organizations for generously sharing
their time and talents which made this
publication possible.

California Urban Water Conservation Council
Mary Ann Dickinson, Executive Director

Project Advisory Committee

Rose M. Smutko, Chair
San Diego County Water Authority

Kirk Brewer,
Southern California Water Company

Elena M. Layugan,
Upper San Gabriel Valley Municipal
Water District

Linden Skjeie, City of San Jose

Preventive Maintenance and Water Conservation are a Partnership

Implementing preventive maintenance measures in your home can save water and money. Whether you take pride in keeping the plumbing fixtures in your home polished and running efficiently, or you telephone a plumber at the first sign of a leak, a basic understanding of each plumbing fixture in your home is critical.

This booklet is not intended to fix major plumbing problems in your home. However, it is intended to provide an important overview of preventive maintenance as a tool for water conservation. Water conservation is not something that should be thought of only during a drought, but conservation should be a way of life. This booklet explains just a few of the ways that you can conserve water while keeping your home in tip-top condition.

contents

1. The ABCs of Plumbing

| | |
|-----------------------------------|----|
| Water Meters | 4 |
| Master Valves | 4 |
| Shutoff Valves | 5 |
| Water Pressure | 5 |
| Frozen Pipes | 6 |
| Preventing Frozen Pipes | 7 |
| Water Hammers | 8 |
| Leaks | 10 |
| Leaky Supply Tubing | 10 |
| Hot Water-Leaks from Valves | 11 |
| Low Pressure | 11 |
| High Pressure | 11 |
| Faucets..... | 12 |

2. Preventive Maintenance

| | |
|---|----|
| Aerators | 19 |
| Clothes Washers..... | 20 |
| Dishwashers | 21 |
| Hot Water Demand Recirculation Systems | 22 |
| Pressure Regulators | 23 |
| Refrigerators | 23 |
| Reverse Osmosis Units | 24 |
| Showerheads | 24 |
| Stuck Valves and Bolts | 25 |
| Toilets: Tune-Up Tips | 26 |
| Types of Toilets | 26 |
| Toilet Parts | 27 |
| Toilet Troubleshooting | 33 |
| Water Heaters | 42 |
| Water Softeners | 44 |
| Water Treatment Units | 45 |

3. Resources

Guides/Books 47

Website Information

Do-It-Yourself Information 47
Energy Information 47
Plumbing Information 48
Plumbing Codes and Standards 48
Toilet Information 48

Helpful Illustrations

Water meters 4
Leaky waste water and cost money 4
Kitchen faucets 13
Lavatory faucets 14
Shower fixtures 15
Typical valve breakdown 16
Valve stem for faucets 17
Replacing washers 18
Aerator installation 19
Toilet schematics 27
Tools 41

Helpful Charts

Clothes washer troubleshooting 20
Types of clothes washers 21
Dishwasher troubleshooting 23
Methods of washing dishes 27
Water heater troubleshooting 43
Daily water budget 46

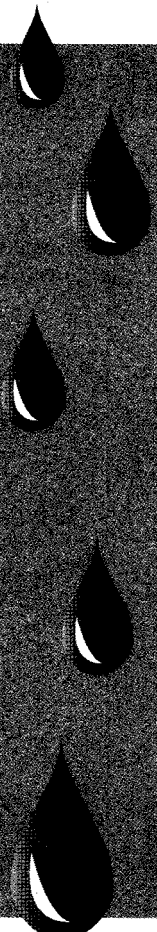

1.

The ABCs of Plumbing

Funny, It Didn't Look Broken

Water Meters

“Meter, meter wherefore art thou?”

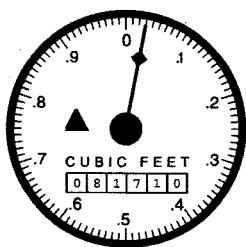

The two common meter types

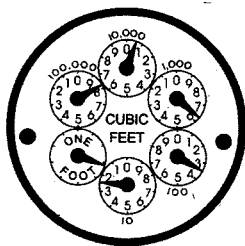

Your water meter keeps track of how much water your household uses. The meter is usually located along the sidewalk, in front of your home, inside a concrete box with a concrete cover marked “WATER METER.” In some homes the water meter is located in the basement. It may be a bit dark inside the meter box, so bring a flashlight along!

Meters measure water either in cubic feet or gallons. One cubic foot equals 7.48 gallons. For example, if your meter says you used 41 cubic feet in a day, you would multiply 41 by 7.48 to find out that over 306 gallons were used that day. Utilities with meters bill by the “unit,” normally, such units are measured as 100 cubic feet (748 gallons) or alternatively, 1,000 gallons.

You can check for leaks on individually metered residences by using your meter. Make certain that no water is being used on the property. Then open the cap of your water meter. Note the location of the dial test hand. Don't run water for 30 minutes. If the dial has moved, you've got a leak. Read on to determine the possible cause.

Master Valves

A master water supply valve controls the water supply coming into your home. Every home has a master valve that is most likely located near the water meter or where the water supply pipe enters your home.

Once you have found the master valve, paint or label it so it is easy to locate. Let everyone in the home know where to find the valve in case of an emergency. Make sure the master valve is accessible; if a pipe is broken and water is gushing out, you don't want to be climbing over a pile of boxes to be able to shut off the valve!

To shut off the water supply to your home, slowly turn the handle counter-clockwise. To turn your water back on, just reverse the above steps. Be certain to cover the meter box when you are finished. It's a good idea to place a few drops of oil around the handle, once a year or so, to prevent the valve from sticking or corroding.

Shutoff Valves — aka “ Angle Stops”

Most modern homes also have shutoff valves for the lines to individual fixtures. Shutoffs are under sinks on both hot and cold supply lines; just inside the house from an outdoor faucet; beneath a toilet tank; where hoses lead to a clothes washer; at the pipe leading into a water heater; or just upstream from bathtub faucets.

Check these valves annually to ensure they are not stuck in place or corroded. If other fixtures have water and a particular one does not, it is most likely the shutoff valve just upstream, which may be wholly or partially turned off. If no water is coming from a hot-water faucet and the angle stop is on, the inlet or outlet valve on the water heater is probably turned off.

Water Pressure

Even your pipes can get stressed!

Water should enter the house at about 45 to 60 pounds per square inch (psi). You can check your water pressure with a water pressure gauge. The gauge screws to a hose bibb. Water pressure over 60 psi can cause a strain on your plumbing fixtures or pipes and even cause bursts in the water line.

Possible causes of low or no water pressure:

- Bad diverter valve for a spray nozzle
- Clogged water filter attached to a faucet
- Clogged strainers just inside hose connections
- Clogged showerhead
- Frozen or freezing pipes

Faucet aerators often clog after work has been done on supply pipes because repair work often loosens rust inside the pipes. If you suspect a build up of sediment in a supply pipe, turn off the water supply, remove the angle stop and peer down the supply pipe. If the pipe is clogged, clear it with a snake. Reattach the angle stop. Turn on the water supply and, with a bucket to catch water, flush out the pipes before reattaching the valve to the supply tube.

Frozen Pipes

Blocked or restricted water flow is the first indication of a problem. If you don't act quickly your pipes will burst as the water expands. At the first sign of a blockage, open the faucet. Finding the blockage is critical. Trace the supply pipe to where it runs through exterior walls or other unheated parts of your house, such as the basement or crawl space. To melt the ice, use hot water, a heat gun, hair dryer or heating pad. It is far better to adopt the slower and more conservative procedure of melting ice by the use of a blow dryer or heat gun.

Shield flammable materials from the heat. While applying heat, leave the faucet open so water can drain. Once the ice melts and the pipes cool, prevent them from refreezing by jacketing them with foam insulation. Wrap all pipes that pass through unheated spaces. Pipes buried outdoors should run about 12 inches below the frost line and should be wrapped with foam insulation extending below frost line.

If you expect a freeze, leave exposed taps dripping to prevent frozen pipes.

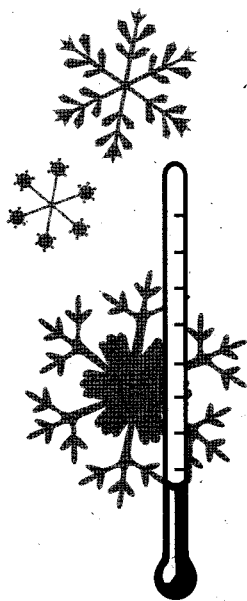

Preventing Frozen Pipes

Water pipes that are exposed to freezing temperatures or drafts should be covered with insulation. When pipes are laid underground they should be below the frost line to prevent freezing. Small water pipes will freeze quicker than waste or sewer pipes.

If there is plumbing in the garage, do not leave the garage door open during severely cold weather. The cold and draft can freeze water lines in minutes. Pipes located in unheated basements or garages should be insulated with a commercial covering.

Before the cold freezing weather sets in, disconnect all garden hoses outside your home; otherwise the hose and hose bib may freeze and be damaged. This is especially important with anti-freeze hydrants. If the hose is disconnected, the anti-freeze faucet can properly drain, and this will prevent freezing.

If your home is going to be unattended for a long period of time during cold weather and the heating system is turned off, follow the following precautions:

- Shut off the water supply at the master valve.
- Beginning with fixtures on the top floor, open all faucets and leave them open. When water stops running from these faucets, open the cap on the main shutoff valve and drain the remaining water into a pail or tub.
- Remember to close the cap after the faucets have run dry. Otherwise the house water supply will flow from this valve and flood the basement.
- Remove all water in the traps under sinks, toilets, bathtubs, and lavatories by opening the clean out plugs at the bottom of traps and draining them into a pail. If no plugs are provided, use a force pump or other method to siphon the water out.
- Sponge all the water out of the toilet bowl.
- Clean out all water in the flush tank.
- Fill all traps with a non-freezing solution such as mineral oil, windshield washing fluid or RV type anti-freeze.

- Drain all hot water tanks. Most tanks are equipped with a vented tube at the top, which lets air in and allows the water to drain out the faucet at the bottom.
- Make sure all horizontal pipes drain properly. Air pressure will get rid of trapped water in these pipes, but occasionally the piping may have to be disconnected and drained. To be safe, have your plumber check your entire plumbing system.
- If your house is heated by hot water or steam, drain the heating pipes and boiler before leaving.
- Burners and pilots should be completely out and the main water supply turned off.
- Drain off the water from the boiler by opening the draw-off valve at the lowest point in the system. Open the water supply valve to the boiler so no water will be trapped above it.
- If you have a hot water system, begin with the highest radiators and open the air valve on each as fast as the water lowers. Every radiator valve must be opened on a 1-inch pipe system to release condensation.

Water Hammers

Ever hear a slamming or banging noise in your water pipes when someone shuts off a faucet? That sound is called a water hammer. It is caused by the sudden change of water flow, with resulting pressure surges, which makes pipes vibrate.





Over time, recurring water hammers can loosen the mounting brackets that attach the pipes to the studs and joists in your home, leading to more movement and risk of leakage in joints and fittings. It can even cause a poorly soldered joint or fitting to completely break! To minimize water hammers, secure pipes to prevent movement and reduce sudden pressure variations. Various devices are available that reduce the abrupt changes in water pressure.

leaks

Leaks: Waste Water, Cost Money

Leaks: through an opening

pressure 60 lbs.

| <i>size</i> | | <i>gallons per month wasted</i> |
|--------------|---|---------------------------------|
| <i>1/4"</i> |  | <i>400,000</i> |
| <i>3/16"</i> |  | <i>225,000</i> |
| <i>1/8"</i> |  | <i>100,000</i> |
| <i>1/16"</i> |  | <i>25,000</i> |
| <i>1/32"</i> |  | <i>6,300</i> |

Leaks: drops



*60 drops per minute =
192 gallons per month*

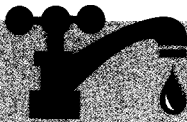

*90 drops per minute =
310 gallons per month*



*120 drops per minute =
429 gallons per month*

Leaks: smooth streams

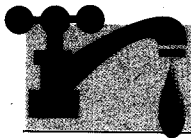

*3" stream =
1,095 gallons per month*

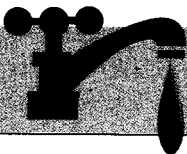

*6" stream =
2,190 gallons per month*

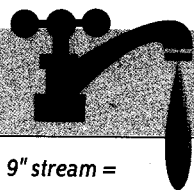

*9" stream =
3,290 gallons per month*

Leaks

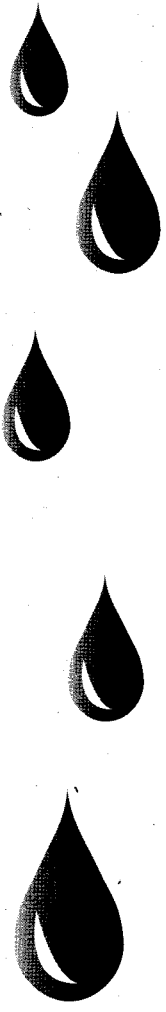

Leaks should be fixed immediately since they can quickly develop into a serious break. Temporary repairs are only temporary, and wrapping the pipe usually fails. If you find a fixture that is leaking, turn off the shutoff valve for that device. Then locate the leak. Try to tighten any fittings that leak. A quarter or half turn with a wrench might do the trick. Be careful not to over-tighten fittings. Another possible cause is that the pipes are undersized and the water velocity is too high.

Leaky Supply Tubing

When the line, or tubing, that supplies water to a faucet or toilet leaks, it's best to go ahead and replace the tubing.

Note: Make sure to get the right size fittings for each end of the tubing. The difference between one size/type and another is subtle. Take your old supply tube/fittings with you and ask a clerk to select a proper length replacement with compatible fittings.

Be prepared to replace the shutoff valve as well as the tubing. Old valves that no one has turned for years may spring a leak when suddenly turned. First, you'll have to shut off the main valve to your house. Then use a wrench or pliers to unscrew the old valve from the nipple in the wall. Place a bucket under the pipe and have someone turn the water on briefly to flush rust from the pipe. If the old nipple is damaged and recessed too far in the wall to get a pipe wrench on it, try an internal pipe wrench to save your plaster.

Buy a replacement valve with female thread to screw onto the nipple. Wrap the nipple with Teflon tape, and then screw on the new valve with an adjustable wrench. Be sure to point the valve outlet toward the fixture as you finish the last turn. Turn the main valve back on and test for leaks.

Hot Water-Leaks from Valves

If the water heater leaks from the drain valve, first tighten the valve. If that fails, you can install a brass hose cap with a hose washer inside. If you tighten the hose cap with pliers, it will stand up to typical water pressure. Check the current pressure with a water pressure gauge. If the reading is between 45 and 60 psi, the problem is probably the relief valve. Turn off water supply and the electricity or gas to the water heater. Partially drain the tank. If there is an overflow pipe, remove it. Unscrew the relief valve, and screw in a new one.

Low Pressure

Make sure all the valves are wide open. There could be blockage in the faucet or in the supply line to the hot water side. Turn off the hot water angle stop, then get a basin wrench and loosen the supply line where it meets the faucet. Then get a bucket and hold the supply line in it while turning on the angle stop. If you have good pressure there, then the blockage is in the faucet.

If you determine that it's in the faucet then: If it is the type that has a cartridge, change the cartridge. If it is the kind with stems, remove the hot water stem and check for particles or damage. If the faucet is the old washer style it will need to be disassembled, cleaned, oiled and rebuilt. If it's a newer style with cartridges or a ball valve, then the cartridge or ball and assorted seals will need to be replaced.

High Pressure

If your water pressure is high, installing a regulator and hot water expansion tank will allow excessive water pressure to expand back to the main water line when the pressure exceeds the incoming water pressure. These devices will help reduce wear and tear on pipes and the risk of a pipe or supply tube bursting.

faucets

Faucets

Faucets typically leak because of old gaskets or O-rings and corroded valve seats. The single most common mistake in faucet repair is not taking along the faucet/parts when buying the replacement parts.

Before working on any faucet turn the water off and open the lines to drain the water out. Cover the sink with a towel to protect it from tools that might drop and to prevent small parts from falling into the drain. Wrap the jaws of wrenches with tape to protect the finish of the faucet.

When you disassemble a faucet, pay close attention to the order of the parts, it's easy to forget the correct order. You might even sketch, or photograph the parts laying in sequence. Follow manufacturer directions for installing the new parts.

If you have less water flow when you turn the water back on after a plumbing repair, rust is probably clogging a valve. Old steel pipes (especially hot water lines) rust on the inside. When you turn the water back on, rust scales break loose and lodge in the valves. To clear them out, open them to full flow. Also unscrew the faucet aerators and rinse them clean.

Today, most faucets can be categorized as being "washerless" (port-type faucets), or compression (washer).

Note: A washerless faucet does not mean it will never leak!

Rather the parts will last longer since their design minimizes friction and wear. When repairing this type of faucet or requesting service on one, it is vital that you know the brand name, or have a sample of the part you require.

Kitchen Faucet

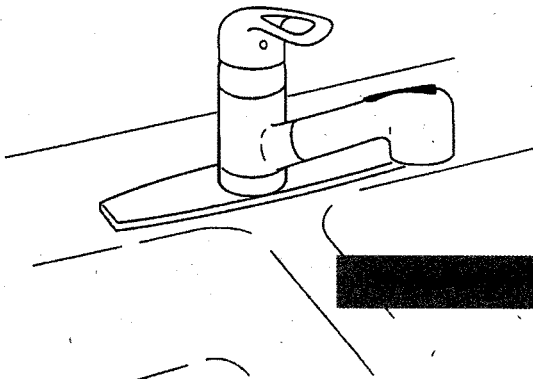
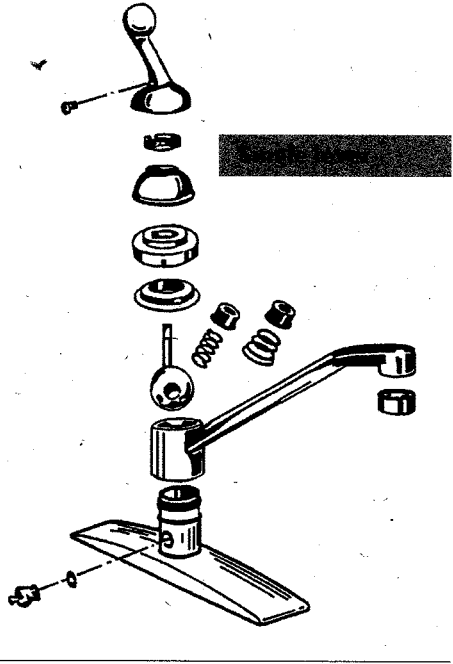
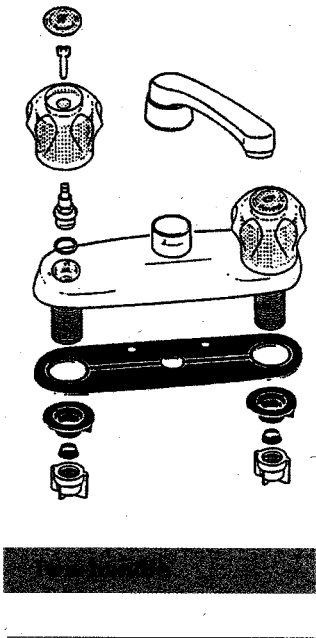

kitchen

shower

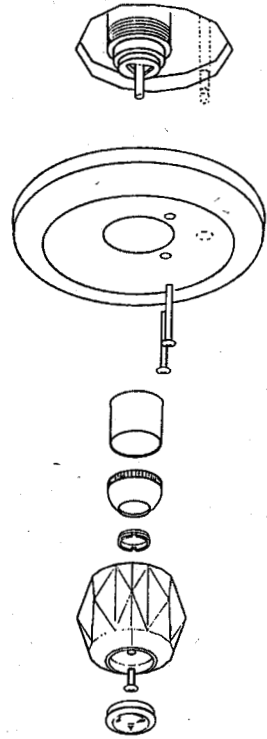
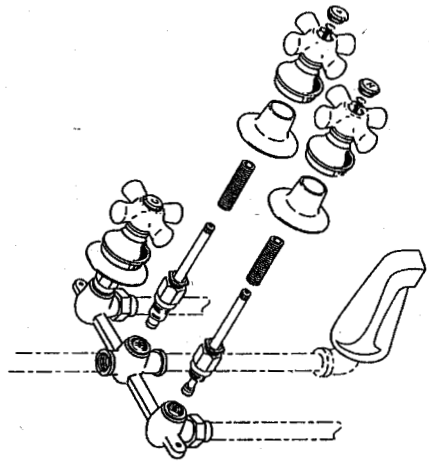
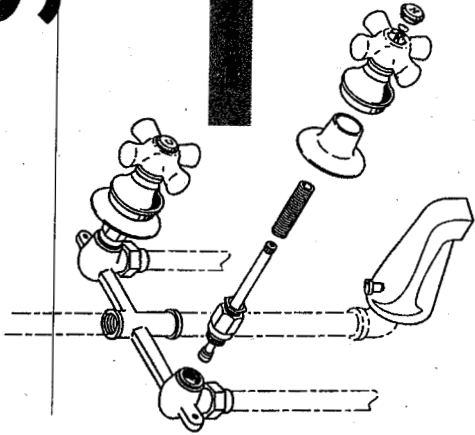

Typical Valve Breakouts

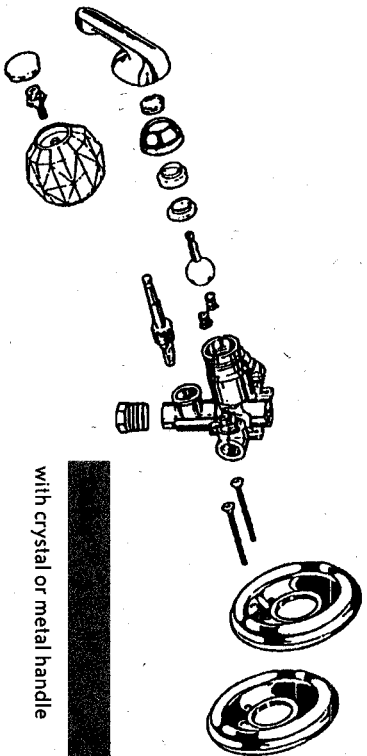

with crystal or metal handle

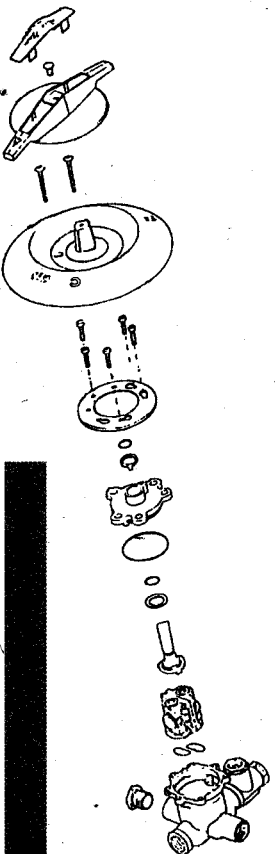
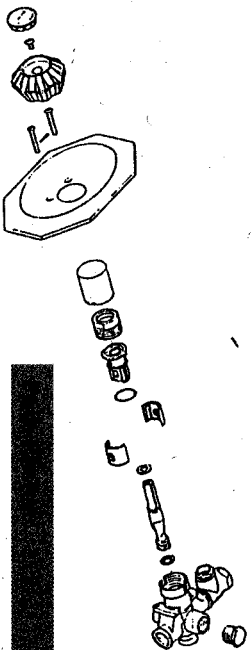
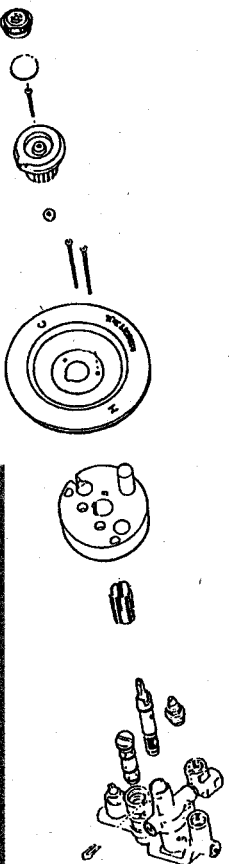

Valve Stems for Faucets

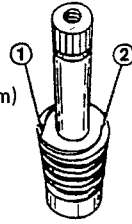
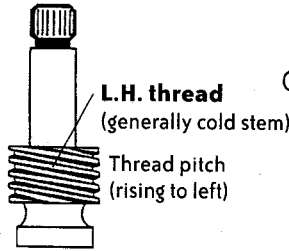
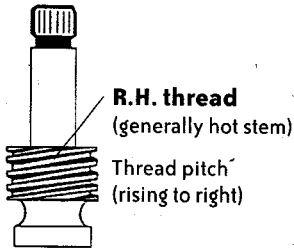

To determine Double Acme Thread, check to see if the thread originates in two places on top at Points 1 & 2

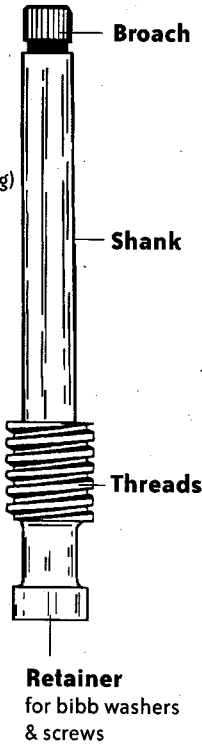
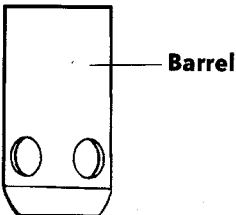
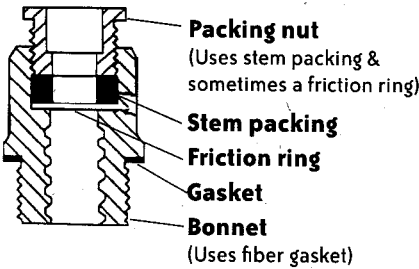
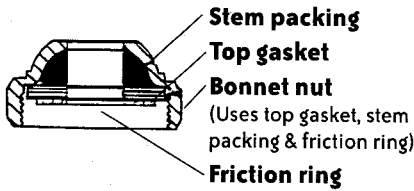

Old style stems
Threads directly
into valve body

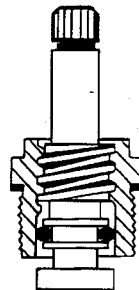

New style stem units
Threads into bonnet,
making a complete
replacement unit. The
bonnet threads into the
valve body.

It is recommended by many equipment manufacturers where a bonnet is employed with a stem that the entire unit be replaced.

stop the drip

To replace a washer, first turn off the water supply line. Next, take the faucet apart and throw away the old washer. The most important thing about the new washer is its size. The washer has to fit around the valve stem, spreading out to the edges, when it is screwed down. When you've got the right size washer, put it in the old washer's place and reassemble the faucet. If the drip is still there, something else might be wrong and you may need to contact a plumber.

If you own a faucet with a single lever, or joystick, the disassembly and repair is still relatively simple, but different from the valve stem and washer type. If you need help, a good hardware or plumbing supply store will have the necessary replacement parts and can probably direct you to a good instruction source.

If, after all this detective work, your water meter still indicates that you have a leak, (See *The ABCs of Plumbing, Water Meters*, page 4) the problem could be in underground pipes. You may need to call a plumber.

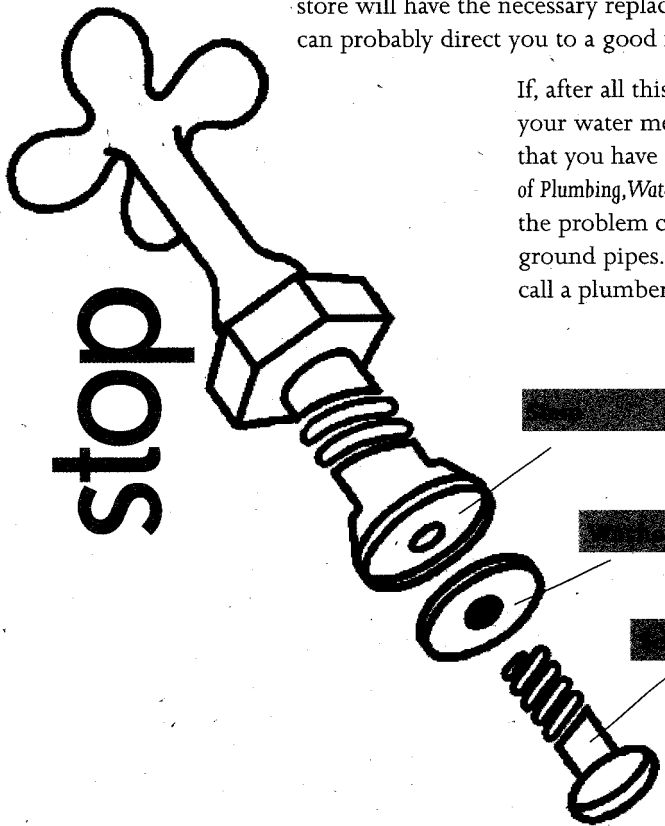

2 Preventive Maintenance

Aerators

Almost all faucets have an aerator at the tip of the faucet spout. An aerator mixes air and water for a smooth flow. You should clean aerators periodically, perhaps once a year, to remove mineral and debris buildup.

Unscrew the aerator, lay aerator parts on the counter in the order in which you removed them, or make a sketch of their order, so that you put them back correctly. Flush the parts with water and clean the screen holes with a toothbrush or toothpick.

Hard-water scale can be removed by soaking the parts in vinegar or lime dissolver. Flush all parts with water before putting them back together. If parts are worn, replace the worn parts or the entire aerator.

Aerator Installation

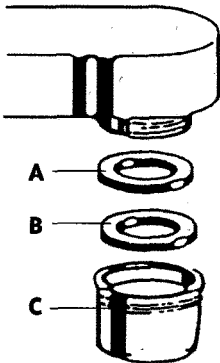

Remove old aerator.

Inside threaded faucets:

Place upper washer (A) on lower washer (B) in top of aerator (C).

Screw aerator into inside threads of faucet.

Outside threaded faucets:

Discard upper washer (A).

With lower washer (B) in top of aerator, screw aerator onto outside threads.

Clothes Washers

Clothes washer models vary, so the specific instructions that are available in the owner's manual are very important. Any devices made of rubber were never intended to last the lifetime of the appliance (remember the term "built-in obsolescence"?). Leaking or cracked valves and hoses need to be replaced immediately. Preventive maintenance not only saves valuable water but also could prevent a costly flood inside your home.

Clothes Washer Troubleshooting

Always turn off the power before working on an appliance!

| PROBLEM | POSSIBLE CAUSE | ACTION |
|---|--|---|
| Washing machine leaks while filling | Loose or cracked hose or inlet valve Water temperature may be greater than 170 degrees or the house may be too cold in the winter | Tighten or replace inlet hose or valve. Adjust water temperature if necessary. |
| Water drips down the outside of the machine | Cracked inlet nozzle or loose hose | Be certain that hose is tightly clamped. Replace if necessary. |
| Water leaks from pump | Pump malfunctioning | May need to tighten or replace clamps or replace pump. |

Water Conservation Tips for Clothes Washers

- Clothes washers account for approximately 28 percent of all indoor water usage. Installation of a high-efficiency clothes washer can save about 33 percent or 5,100 gallons of water per year.
- If you're buying a new washer, consider purchasing a high-efficiency washer. Some agencies have rebates available for water and energy saving clothes washers. Check with your salesperson, utility company, water agency and website (see page 47) before purchase.
- Be sure to run full loads of clothing. For smaller loads, match water level with the load size. (This is done automatically on the new high-efficiency washers).

Clothes washing machines Use the lowest water

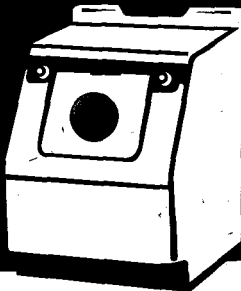

Water per load

40 - 50 gallons

30 gallons

20 - 25 gallons

Dishwashers

As with all appliances, the most thorough instructions are included in the owner's manual. However, the list below provides a short list of preventive maintenance. Visit your local library for a complete list of how-to manuals.

Check hoses on all home appliances routinely. Replace any worn hoses. This will prevent leaks or any unnecessary flooding in your home. Check the dishwasher sprayer and strainer periodically for food particles or mineral buildup.

Dishwasher Troubleshooting

Always turn off the power before working on an appliance!

| PROBLEM | POSSIBLE CAUSE | ACTION |
|---|--|--|
| Water leaks from door | Rubber gasket has become hard or cracked | Replace with new gasket if necessary |
| Dishwasher overfilled with water | Float switch malfunctioned | Be certain that the float is functioning |
| Water doesn't drain out of dishwasher | Pump may be clogged | Remove food particles from pump & impeller |
| Water doesn't enter tub | Pressure switch malfunction | Replace switch or timer |
| Water leaks from bottom during wash cycle | Gasket may be either flattened or torn near the bottom | Pull the old gasket out of the slot it sits in and replace with new gasket |

tips

Water Conservation Tips for Dishwashers

- If you use a dishwasher, it's important to maximize efficiency by running full loads, or use the appropriate setting for the load (small, medium, or large).
- You may wish to consider not rinsing your dishes before you put them in the dishwasher because in effect, you are washing dishes twice — once by hand and once by the dishwasher.
- The chart below should be decisive in ending the age-old argument between parents and children — hand washing dishes vs. the automatic dishwasher.

| Methods of washing dishes | Gallons per cycle | |
|---|-------------------|------------|
| | Short Cycle | Full Cycle |
| Non-conserving dishwasher | 8 – 13 | 14 – 15 |
| Water-efficient dishwasher | 9.5 | 12 |
| Manually washing with tap open | 30 gallons | |
| Manually washing with a full sink, then rinsing | 5 gallons | |

Hot Water Demand Recirculation Systems

Each year, California homeowners allow an estimated 120 billion gallons of water to run directly into their sewer lines while waiting for hot water to arrive at showers and sinks. Every gallon of water that enters your home requires energy and processing, and each gallon that goes through your water heater requires additional energy. This loss of water puts a burden not only on our natural resources, but also increases costs for consumers.

If your hot water source is far away from your showers and sinks, you may wish to look into a hot water demand recirculation system for your home. Studies

are currently in the preliminary stage, but will probably prove to be a promising method of conserving water in the near future.

Pressure Regulators

Pressure regulators are used to reduce the pressure of water provided by your water agency or municipality. Check with your local Building Inspection Department to see if a pressure regulator is required. Many homes do not have pressure regulators and do not seem to need them. However, a pressure regulator may be required if your water pressure is over 80 psi. A pressure regulator allows you to reduce the incoming pressure. (In the case of water delivered at a very low pressure, the regulator cannot increase the pressure).

Interior plumbing fixtures and water related appliances perform best at pressures between 40 to 60 psi. High water pressure causes fixtures to wear out sooner and may shorten the life of water heaters and tanks. Water fixtures such as showerheads are designed for a certain optimum pressure. At high pressures more water is used. At low pressures the water conserving showerhead and aerators do not perform adequately. If you want to determine the pressure at your residence, you can purchase a pressure gauge at most hardware stores for under \$10.

Refrigerators

Refrigerators with cold water dispensers and ice makers have water lines which are usually concealed from view. The water line is connected under the sink and may run under or behind kitchen cabinets, or behind a wall. It connects to the back of the refrigerator. Be certain that you regularly check for leaks. Because the water line to the refrigerator is concealed, any small leaks can go undetected until it becomes a big, expensive leak. This can also damage other appliances, cabinets, walls, and floors.

Reverse Osmosis Units

A reverse osmosis drinking water purification systems acts like a sieve to filter and extract substances from water. A reverse osmosis system may be mounted under a sink cabinet or set on the counter (usually in the kitchen), or it may be connected to the main water intake plumbing in your home.

A reverse osmosis system is water-intensive. It not only uses water, but in some cases, puts water into the sewer system without ever being consumed. Anytime the unit is filling the treated water tank, water can be wasted. Some under-sink models run a small amount of water into the drain constantly, even when the treated water tank is full and no drinking water is used. A reverse osmosis system can account for 7 to 8 percent of inside household water consumption. It is important that the system be equipped with an automatic shutoff device.

Showerheads

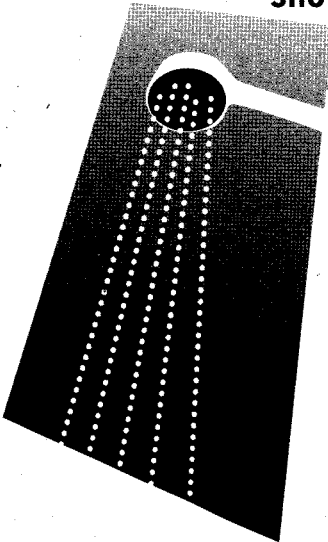

Showerheads normally connect to a 1/2-inch threaded shower pipe (or "arm" as it is often called). Many years ago there were pipes with a built-in ball end. Those pipes must be replaced with a threaded end. Sometimes they are difficult to remove. Most balls you see when removing the original head have been screwed on, even if they are very tight, to the shower pipe. If you see even one thread, the head is normal.

Once a year, remove and clean out the showerhead to prevent mineral deposits from building up in the showerhead and distorting the shower stream.

- Use masking tape on the chrome pipe to protect the finish from being scratched when using wrenches or pliers. Use vise grips and a pair of pliers, or a pipe wrench and pliers, to remove the old showerhead.

- Replace the Teflon tape on the end of shower pipe to prevent leaking.
- Either: Clean the showerhead, back surface and free holes with a needle. Re-install. Remove the masking tape.
Or: Put on the new head according to the manufacturer's instructions. Remove the masking tape.

Showerhead Replacement Tip:

Many years ago the 1/2-inch threaded shower pipe (or "arm" as it is called) often came with a "ball end" which was either fused or screwed on the end of the arm. Behind the ball end was a gland type nut. This nut embraced the back of the ball end and screwed to mating threads on the showerhead, the latter embraced the front side (or ball end) of the showerhead allowing it to swivel in all directions.

When such showerheads are replaced, it is necessary to replace the arm or obtain an adapter, either of which has a threaded end to mate with the configuration of most new showerheads. The removal of the old one-piece arms or screwed on ball end can be difficult.

tip

Stuck Valves and Bolts

Many people use WD-40 as penetrating oil to help loosen frozen bolts and valves. Use penetrating oil such as Liquid Wrench for loosening valves and bolts. WD-40 is not meant to be penetrating oil and will not work as effectively.

Once you get it loose enough to start wiggling, it should come off. Be careful not to put too much force on a valve or you may break the stem. If the handles are so corroded that they strip when you remove them, be sure to replace with new handles.

Toilet Tune-up Tips

Toilet problems are often summed up by comments like “it runs all the time,” “it only runs in the middle of the night,” “it takes forever to refill my toilet,” or “lately I have to flush it at least twice!”

In the past it was quite simple to “tune the toilet” and in most instances, it still is! The basic parts have not changed that much over the years. The descriptions provided on the following pages should help to guide you through the basics.

Types of Toilets

There are two basic types of toilets found in the home. By removing the lid from your tank you can quickly determine which type you have:

Gravity-Fed

The most common is the gravity-fed which relies on the weight of the water and head pressure (height of the water in your tank) to promote the flush. If you see freestanding water when peering down into the tank, your toilet is gravity fed.

Pressure-Assist

The pressure-assisted toilet relies on air pressure within a cylindrical tank (metal or plastic-like material) inside your toilet tank. Air inside the cylinder forces a vigorous and very rapid flush. The cylinder, along with the “roaring/whooshing” sound when you flush it, are sure signs of a pressure-assisted toilet. If you look inside your toilet tank, there should be no free-standing water visible.

The tuning of a pressure-assist mechanism is a task best left to a plumbing professional specifically trained in the service of these devices. There are horror stories out there about do-it-yourselfers who have tinkered with the adjustments on their pressure-assist toilets with nothing less than “shattering” results. Can you think of anything much worse than an exploding toilet? For this reason, all discussion below will be directed to the gravity-fed toilet.

Toilets usually consist of a tank and separate bowl, although there are one-piece toilets where the tank and bowl are an integral unit. The latter are usually of a lower profile design than a two-piece unit.

toilet parts

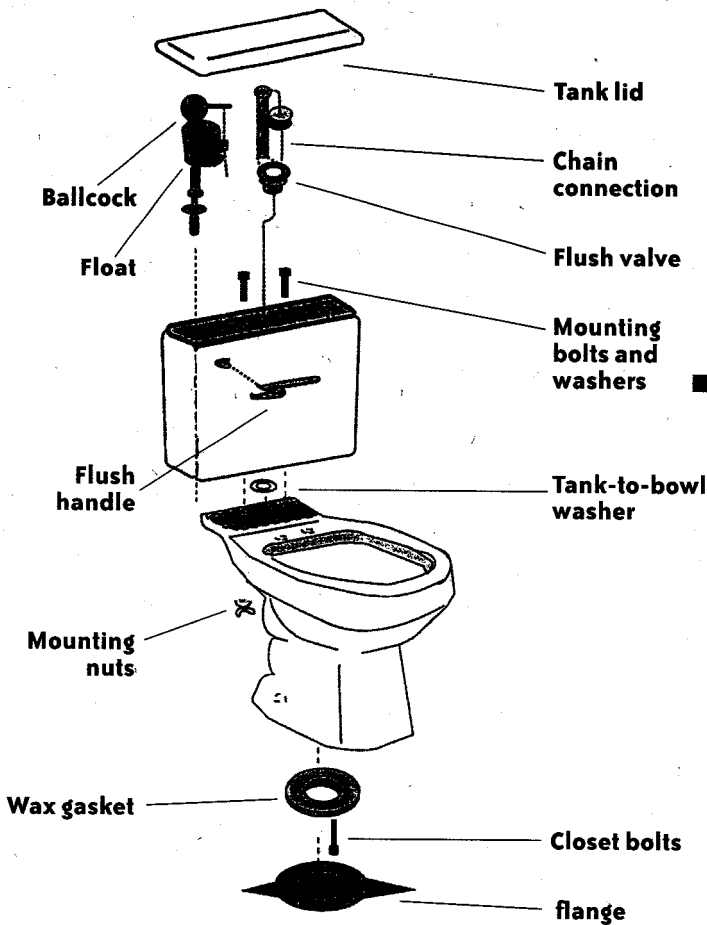

Important Note:

Dropping certain toilet bowl cleaners (usually in the form of large white tablets) into your toilet tank may result in damage to the parts within the tank, especially if you do not flush your toilet at least once a day. Some manufacturers may even void the warranty on those parts!

IF YOU USE THESE CLEANERS, remember to flush your toilet at least once per day.

Toilet Parts

Tank — The tank is the top portion which holds either the free-standing water to be flushed (gravity-fed) or the pressure-assist cylinder (pressure-assist). On a gravity-fed toilet the tank houses the fill valve (frequently called a “ballcock”), the flush valve (usually including an overflow tube with a flapper and flapper seat) and the flush or trip lever. These parts are called “trim.”

Tank Lid — It’s the top most part of your toilet tank and covers the mechanisms inside your tank.

Bowl — The bowl is the lower half of the toilet used to hold liquid and solid wastes prior to flushing.

Water Spot/Sanitary Seal — This is the water surface that you see inside the toilet bowl after the flush is completed. This water in the bowl assists with the movement of solids into the trapway and provides a liquid seal in the trapway so that sewer gasses don’t pass from the waste line into your home.

Evacuation — In toilet talk, this is the flushing process that removes liquids and solids from your bowl.

Tank to Bowl Seal — This is the round “donut-shaped” seal between the tank and bowl in a two-piece toilet. This seal provides a cushion upon which the tank rests and acts to prevent water leaks around the coupling between the tank and the bowl.

Shut-off/Supply Valve — The valve on your wall near the base of the toilet with a round or oval handle that allows you to shut your water off while servicing the toilet.

Supply Line — This is the solid or flexible line between the shut-off/supply valve and the connection on the bottom of your tank (fill valve fitting).

Billy Bolt Set — A package of “T” shaped bolts, flat and dome nuts, and round and/or oval washers used to connect the toilet bowl to the closet-ring.

Closet Ring — The metal or plastic flange that is permanently installed at the end of your waste line (at floor level) and has slots for the “T” Bolts / “Billy-Bolts.” The inside diameter is normally three to four inches. The closet ring mates with the outlet on the bottom of your bowl and provides the means for evacuation.

Wax Ring — The yellowish beeswax (or beeswax type material) ring between the bottom of your toilet bowl and the mating closet-ring (flange). It is “donut” shaped, about one inch thick. A seal is achieved when the wax ring is squeezed between the bottom of your toilet bowl and the top of the closet-ring.

Ballcock (Fill Valve) — You will only find this in a gravity-fed toilet. It is the tall mechanism you see inside your tank (left-hand side) with a float connected to it by means of a metal rod or plastic arm. Or, instead of a float mounted at the end of a rod, it can have the float sliding up and down the tube/barrel of the mechanism itself.

Float — The bulb-shaped sphere on the outer end of the float rod/arm OR the can-shaped float that slides up and down over the fill valve tube.

Float Arm — The metal rod or plastic arm that connects the ballcock’s float to the shut-off lever on the ballcock valve itself. On those fill valves without the float at the end of a rod or arm, a rod-like stiff-heavy wire link with an adjusting clip connects the shut-off lever to the float, performing the same shut-off function.

Float Arm Adjusting Screw — This screw is normally only found where the float is connected to the shut-off lever by means of the metal rod or plastic arm. When turned clockwise, this screw causes the water flowing into the tank to shut off earlier. The same effect is accomplished by moving the stiff wire link downward using the adjusting clip for the slide-type float mechanism.

Douglas Flush Valve — You will find this in most gravity-fed toilets. It is the mechanism you see directly in the center, inside your tank. On one side of it, you will see a hollow tube approximately one inch in diameter (the overflow tube). Connected to the tube by means of “trunion mounting ears,” is the flapper. The flapper regulates the amount of water that passes from the tank into your bowl during the flush cycle.

Refill Tube — This is the small plastic tube (approximately 1/8-inch in diameter) that is connected near the top

of the ballcock mechanism on one end and to the inside of the overflow tube on the other end. Water only flows through this tube during the flush cycle and is the water that replenishes the toilet's water spot/sanitary seal.

Overflow Tube — This is the approximately 1-inch diameter hollow tube to which the refill tube is connected. This is the passageway for the water making up the water spot/sanitary seal to enter the bowl. When the water level is adjusted too high, then water will flow from the inside of the tank into this tube and into the toilet bowl.

Trunion and Trunion-ring — Trunion "mounting ears" are the approximately $\frac{1}{8}$ -inch diameter by $\frac{3}{8}$ -inch long shafts protruding out from the overflow tube near its base. These are the "ears" to which the flapper connects. In some cases the overflow tube is void of these ears in which case, a "rubber" type round "trunion-ring" with two mounting ears slides down over the tube to provide the connecting points for the flapper.

Flapper — The flapper is the flush valve seal and serves to control the volume of water passing from the tank to the bowl during the flush cycle. It mates with the seat on the Douglas flush valve to complete the seal and prevent water leaking from the tank into the bowl between flushes.

Almost all flappers are shaped, in part, like a "flying saucer," that is, slight "dome" on top, flat like a "pancake" in the center and then (not like a flying saucer) a "funnel" or "bulb" shape on the bottom. This whole assembly is usually one molded part and is made of flexible rubber-like material. The center or pancake shaped mid-section is approximately 3 inches in diameter. Other flappers (or seals) are of a flat washer-like design.

There are four common types of flappers:

1. **Non-air bled** — Most always found in 3.5 gallon to 7 gallon toilets and occasionally in some ultra-low-flush toilets (ULFTs). The non-air bled or "standard" flapper has an air chamber in the

funnel shaped section. In the small end is an opening approximately $\frac{1}{2}$ -inch in diameter. This small end faces down and there is no way for the air caught inside to escape, therefore, it floats on top of the water in the tank until the force of the water going through the opening in the Douglas flush valve causes the flapper to close and seal.

- 2. Air bled with calibrated orifice** — Often called an “early closing” flapper. This flapper is sometimes used to achieve the 1.6 gallon flush volume in a number of ULFTs where tanks are much larger than 1.6 gallons in capacity. This flapper also has an air chamber, but in the upper portion of the funnel is a round “air-bleed” hole approximately $\frac{1}{4}$ -inch in diameter. In the small $\frac{1}{2}$ -inch section of the funnel is a snugly fit insert. In the middle of the insert is an orifice. There are a number of different size orifices to accommodate different toilet manufacturers’ requirements. (In some cases, the orifice size is adjusted through a “dial” type insert, thereby making it an “adjustable” flapper.) The size of the orifice determines how quickly water enters the funnel shaped chamber to displace the air that escapes through the $\frac{1}{4}$ -inch air-bleed hole near the top. When enough air is displaced with water, the flapper is no longer buoyant and sinks to seal off the escaping water long before all of the water can evacuate the tank; thus, the term “early closing.”
- 3. Air bled with float** — Also known as an “early closing” type and is used to achieve the 1.6 gallon flush volume in a number of ULFTs. It also has an air chamber with a round air-bleed hole approximately $\frac{1}{4}$ -inch in diameter in the upper portion of the funnel shaped chamber. There is no insert in the small $\frac{1}{2}$ -inch section of the funnel to regulate how quickly the water displaces the air in the chamber. Instead, a float is connected to the top of the flapper by means of a chain. The float remains on top of the water in the tank and the length of the chain connected to the flapper determines how quickly the flapper (which has quickly filled with water) will reach the flapper seat and shut off the flow of water between the tank and bowl.

4. **Flat seal** — A washer-like disk with a flat surface and a hole in the center. The flat seal is common to all toilets that use a piston-type flush valve (as opposed to the Douglas flush valve) as well as being used in some with unique flush valve designs. The flat seal is between 2¹/₂-inches and 3¹/₂-inches in diameter, of flexible rubber-like synthetic material, and is easily installed on the body of the flush valve.

Flapper Seat — The hard, round surface at the base (or seat) of the Douglas flush valve. The flapper rests on the seat when the valve is closed. The seat surrounds the 2-inch opening at the base of the Douglas flush valve, which is almost always made of PVC material although some older toilets were equipped with brass valves. All water used during the flush cycle passes through the valve.

Water Level — The water level inside the tank of a gravity-fed toilet. Some manufacturers cast a porcelain "fill-line" inside the tank, while other manufacturers put a fill mark on the overflow tube. In some cases, no fill line is indicated. In such circumstances, a good rule of thumb is to adjust the water level to one inch below the top of the overflow tube.

Flush or Trip Handle — This is the handle normally found on the upper left front of the tank or on the upper left side of the tank. It is the mechanism pushed or pulled to effect the flush.

Flush or Trip Lever Arm — This is the metal or plastic extension connected to the flush valve. It is on the inside of the tank and can be up to six inches long. It reaches from the handle directly to the flush valve or to a location over the top of the flapper.

Flush or Trip Lever Chain/Tail — This is the connecting link between the flush/trip lever arm and the flapper. When adjusted properly, this connecting link allows the arm to pull the flapper open to initiate the flush cycle.

"It runs all the time"

Even a silent toilet leak (that's one you normally can't hear) will waste from 30 to 50 gallons of water per day! The ones you can hear will waste much, much more. Such wastage can normally be attributed to a faulty water level adjustment or to a leaky flapper:

Water level adjustment

Even a new toilet needs its water level adjusted within 30 days of toilet installation. That is because there are rubber diaphragms in most ballcock mechanisms and those diaphragms stretch like a rubber band.

Also, an increase in water pressure (usually in early morning hours) can cause the water level inside the tank to rise. For example, a 15 to 20 pound pressure increase can cause the water level in your tank to rise by up to 1/2-inch, and it is not uncommon for your water pressure to rise that much during the very early morning hours.

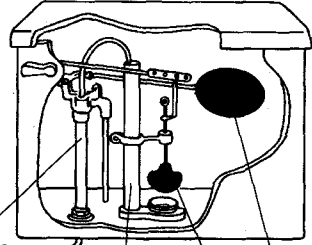
**Ball-cock assembly****Overflow pipe****Float ball****Tank ball**

To lower the water level in your tank, find the adjusting screw on the top of your fill valve. A screwdriver (or even a dime) will be all you need to turn the screw. If you want to lower the level, turn the screw clockwise on those ballcock-type mechanisms with floats hanging off the end of metal rods or plastic arms. If your fill valve has the float sliding up and down the barrel or shaft, then you will need to lower the stiff wire-like link using the "V" shaped clip. With either type, it might take you several tries to get the water to the level recommended by the manufacturer. On some toilets, the water level is shown as a line inscribed in the porcelain, others will have the line indicated on the overflow tube. If you are unable to find a water level mark then a good rule of thumb is to adjust the level to 1-inch below the top of the overflow tube and then check the level every three months.

In isolated cases the water will creep up on the overflow tube even though the adjustment is correct. If you find water is again escaping through the overflow tube, your ballcock diaphragm is likely the culprit. If you value your time, you are probably better off to replace the entire fill valve, instead of replacing just the diaphragm. The replacement of the fill valve is relatively simple. Turn the water off at the shut-off/supply valve, remove the supply line from the fill valve, remove the flange nut on the underside of the tank that anchors the fill valve, disconnect the refill tube and pull out the old valve. It's probably a good idea to take the old valve to the hardware store and once there, check with their resident plumbing specialist regarding the best choice. There are now replacement fill valves available that are a great improvement over the old dinosaur you have with you. Install your new model following the manufacturer's instructions.

Leaky flappers and the "dye test"

Most people will say their toilet *does not* leak. There is one sure way to find out. Put some food dye in the tank and then leave for 15 minutes. When you return, look into your bowl to see if there is now dye color in the water spot. If there is color, or if you already can hear and or see water running in your bowl, it's time for a new flapper!

The best bet is to remove your old flapper and take it with you to the hardware store. Removing the old flapper is easy but can be messy if it is partially disintegrated. A pair of cheap latex gloves and a small container to hold the old flapper will make your job less of a hardship. When removing your old flapper, you will first need to turn the water off at the shut-off/supply valve. Next, disconnect the chain or tail from the trip lever arm and then slip the ears of the flapper off of the trunion ears. You will need to select a new flapper that, as near as possible, matches your old one. If your flapper is one of the hard-to-find ones, you may even need to contact the manufacturer of your toilet for a recommendation, so if you only have one toilet,

It's a good idea to keep the old flapper handy until you've found a suitable replacement. While the flapper is out, take your finger and move it over the seating surface of the Douglas flush valve. If the surface is rough, get some 400 grit wet or dry sandpaper and lightly go over the entire surface. Repeat the process until the surface is smooth.

For toilets with a flat seal type of flapper, simply slip it off the piston or other holding device and replace it with a new one.

After installing the new flapper, run the dye test again to ensure you have no leak. If the leak persists (and every now and then it will), you are probably going to have to replace the entire flush valve. To do this, you will need to turn your water off and disconnect the supply line. Then loosen the bolts that hold the tank to the bowl, remove the tank to bowl seal and remove the flange nut on the bottom side of the tank which holds the flush valve in place. Next purchase a replacement valve assembly from your hardware store, but be sure that the new assembly has an overflow tube at least as tall as the old one. If the new one is taller, then note the correct height from the old one, mark that height on the new one and, using a hack saw, cut it to the proper length. Using new seals, reassemble in the reverse order as used in removing the old valve.

"It only runs in the middle of the night"



Many toilets really do run only at night; that's because people use much less water during those hours and in many municipal water systems, the water pressure rises considerably during this time. It is not uncommon for system water pressure to rise by 15 to 20 psi, and by as much as 30 psi in some situations. This rise in pressure could cause "water creep" inside your gravity-fed tank by one-half of an inch or more. That is why the manufacturers of toilets normally suggest that the water level to be set at approximately one inch below the top of the overflow tube.

It only runs in the middle of the night

Water level in the tank

If you only notice your toilet running in the middle of the night, there is a good chance that the water level in your tank is set too high. Remove your tank lid and observe the water level. If you are doing this in the middle of the night (which, by the way, would be the ideal time to check this out!), and the water is running over the top of the overflow tube, adjust it down using the adjusting screw on the top of the fill valve mechanism (turn clockwise) or the "V" shaped clip on the stiff wire link (slide it down) on the "sliding float" so it's not overflowing. Then, the following day, make another adjustment down to the 1-inch level.

Fill valve (ballcock) leaking

If, after making these adjustments, you find that the water still creeps up the overflow tube, or escapes through the refill tube, then it's time to repair or replace your fill valve. If you value your time, you are probably better off to replace the entire mechanism, rather than just replacing the diaphragm inside.

The replacement of the fill valve is relatively simple. Turn the water off at the shut-off/supply valve, remove the supply line from the ballcock, remove the fill valve flange nut on the underside of the tank, disconnect the refill tube and pull out the old valve. This is another situation which requires taking the old valve to the hardware store to find out which valve will be the best replacement choice. Replacement units are available that are great improvements over the outdated models. Install your new model following the manufacturer's instructions. Remember that a new fill valve is a small investment to pay for the water you will save and for a sound night's sleep!

Flapper leaking

If the water is not creeping up the overflow tube and you continue to hear the toilet cycling, perform the dye test (see page 34) to be sure there is not a flapper leak. If the dye test is positive, then complete the procedure for the replacement of the flapper as described next.

The best bet is to remove your old flapper and take it with you to your friendly hardware store. Removing the old flapper is easy, but can be messy if it's partially disintegrated. A pair of cheap latex gloves and a small container for the old flapper will make your job less of a hardship. When pulling your old flapper out, you will first need to turn the water off at the shut off/supply valve. Next, disconnect the chain or tail from the trip lever arm and then slip the ears of the flapper off of the trunion ears. You will need to select a new flapper that best matches your old one. If your flapper is one of the hard-to-find ones, you may even need to contact the manufacturer of your toilet for a recommendation. So, if you only have one toilet, it's a good idea to keep the old flapper handy until you've found a suitable replacement.

While the flapper is out, take your finger and move it over the seating surface of the Douglas valve. If the surface is rough, get some 400-grit wet or dry sandpaper and lightly go over the entire surface. Check to see if it is smooth. If not, repeat the process until the surface is smooth.

Douglas valve replacement

After installing the new flapper, run the dye test (see page 34) again to assure that you don't have a leak. If the leak still exists (and every now and again it will), you are probably going to have to replace the entire Douglas valve. To do this, you will need to turn your water off again, disconnect your supply line, loosen the bolts that hold the tank to the bowl, remove the tank, remove the tank to bowl seal, get a big pair of channel lock pliers and remove the flange nut on the bottom side of the tank which holds the Douglas valve in place. Next, you will need to get a new Douglas valve assembly from your hardware store. Be sure the new assembly has an overflow tube at least as tall as the old one. If the new one is taller, note the correct height from the old one, mark that height on the new one and using a hacksaw, cut to the proper length. Using new seals, reassemble in the reverse order as used in removing the old valve.

“It takes forever to refill my toilet”



If it is taking a long time for the water in your toilet tank to refill, chances are your supply line or the fill valve is partially blocked.

First turn the water off at the shut-off/supply valve. Disconnect the supply line and check it for blockage. If blocked, clean it out or replace it. If the problem is not the line, then it may be the fill valve mechanism. Some mechanisms have strainers in their inlets and if so, your job is probably simple: remove and clean the strainer. If there is no strainer, then remove the fill valve from the toilet, disassemble and clean it. If after all this you still have a slow filling problem, then replace your fill valve. See procedure in the last paragraph under “Water Level Adjustment” (page 33).

“Lately I have to flush it at least twice”



If, in the past, your toilet has only required double-flushing in rare circumstances, and now you have to double (or triple) flush it quite often, you may be experiencing one of two problems. The first is a low water level inside the tank and the second is a partially clogged waste line.

Low water level inside the tank

If you have a fill valve mechanism with the float on the end of the rod or arm, then get your screwdriver or trusty dime out and turn the adjustment screw located on top of the valve mechanism. Turn counterclockwise until you raise the water to the manufacturer's water level mark or, alternatively, to a point where the water level is 1-inch from the top of the overflow tube. If your valve has the slide-type float mechanism, the same task is accomplished by moving the stiff wire link upward using the adjusting clip. If this action solves your flushing problem, lady luck is with you. If you still must double flush, then try working a toilet bowl clean-out “snake” through the trapway from the inside of your bowl. If this fails, it's time to break out your work clothes and a few wrenches, or call a plumber.

Clogged waste line

This is a chore that only the more hearty and adventurous souls will want to tackle. First, clear everything that is on the bathroom floor out of your way. Have a few old bath or beach towels handy. Shut off the water at the shut-off/supply valve. Flush the toilet to remove as much water as possible. Remove the flex line from the fill valve. Remove the caps covering the “T” bolts that secure your toilet to the closet ring. Remove the nuts and washers from the “T” bolts and then remove the toilet from the closet ring. If you are doing this by yourself, you may want to separate the tank from the bowl, as the whole assembly is quite heavy. Clean the wax off the outlet on the underside of the base of your toilet. Look into the toilet outlet (ugh!) to see if you can observe any blockage that your toilet bowl snake might have missed. If all looks clear in the bowl outlet, it is now time to “snake out” your waste line.

Snaking out your waste line is hard, dirty work. You will now be looking down at your closet ring (the bomb-sight!), the round flange at floor level with the 4-inch hole in its center. It will have two “T” bolts, threaded-end up and a bunch more wax all around it. Play it safe and remove the “T” bolts before they drop down the waste line. In fact, chuck them out along with the nuts and washers you removed to free the toilet from the flange. Now use a putty knife and some paper towels to remove all of the remaining old wax.

Now you are ready for the fun part. This is where the towels (or even a sheet of plastic) are handy. Run your snake down the waste line until you clear the obstruction. If your snake is not long enough or, the obstruction won't clear, it's probably time (no, it's definitely time) to call out the professionals! Once you, or they, have finished the dirty work, its time to reinstall your toilet.

As the first part of your resetting project, make a trip to your hardware store and buy the best wax ring and solid brass billy bolt set that you can find. The best will only cost slightly more and the trouble you will save yourself is well worth it.

lately I have to flush it at least twice

First install the new “T” bolts in the slots on the closet ring and be careful to position them across from each and parallel to your back wall. Next place the oval shaped brass washer with the round hole in the center over the “T” bolts and positioning slots in the flange. Now use the brass “jam” nuts or thin spring steel fastener to secure the “T” bolts and oval washers in place.

Take extra care to center the new wax ring over the closet ring flange opening or alternatively, over the outlet on the underside of the bowl. Next, install the bowl (or the whole toilet, if you have left the bowl and tank assembled together). Be sure to get the bowl relatively level before tightening anything down. Use a two foot long “carpenters” level placed over the center of the bowl to see if it is level. If leveling is required, then pick up some plastic shims from your local hardware or building supply store. Taking care not to disturb the wax ring, insert shim material until you reach the required height. Once this is accomplished place the plastic “cap” washers (lip up!) over the “T” bolts taking care to cover as much of the oblong holes provided in the base of the toilet as possible. Next, place one round brass washer on top of the plastic washer and then use the “dome” nuts to snug down the bowl.

Next, see if your new plastic caps will snap in place over the “T” bolt assemblies. If you hear the “snap,” all is well and you are done. If not, take your trusty hacksaw and cut off the excess thread-end of the “T” bolt protruding from the dome nut and now snap your caps in place. The rest of your project will now be simple (and a lot less messy!). In completing the job, remember to caulk around the base of your toilet where it meets the floor.

If you are not too tired, take a moment to admire your handiwork and pat yourself on the back! You have just accomplished a big job that would otherwise have cost you big bucks!

tools

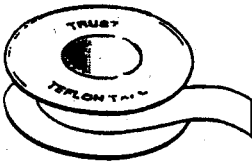

Teflon Tape

Makes a fluid and gas tight seam on any threaded connection

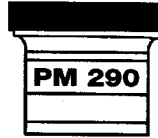

P&M 290

Water resistant lubricant

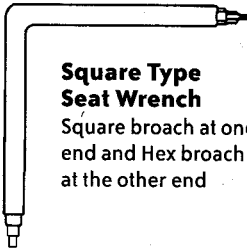

Square Type Seat Wrench

Square broach at one end and Hex broach at the other end



6 in 1 Screwdriver

Alloy steel bits and a shockproof plastic handle

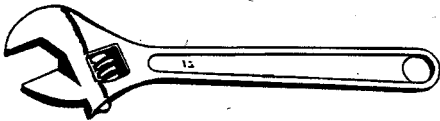

Adjustable Wrench

Comes in 6", 8", 10" or 12" lengths

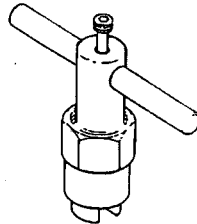

Moen Core Puller

For removing New Style cartridges from body

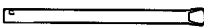
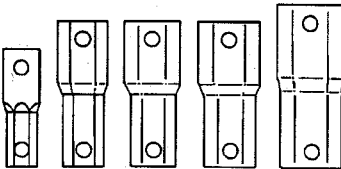
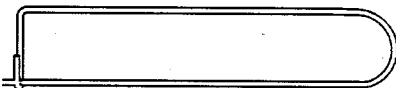

Plumbing Specialty Wrenches

Fits both bath and shower valves in the wall



Bonnet Slip Joint Nut Pliers

With serrated jaw. 10" length

Water Heaters

Most water heaters are little more than storage tanks for water with a heating element attached. It's impossible to predict how long a water heater will last. But check your warranty and realize that the average life expectancy is between 8 to 12 years. And remember that this fixture contains from 30 to 50 gallons of water. It is better to err on replacing the heater too soon than too late.

There are three types of water heaters commonly found in homes:

1. Electric water heaters

There are two types of electric water heaters:

- the large tank-type that heats and stores 30 to 50 gallons of water
- a small under-the-counter type that hold 1 to 3 gallons

Electric heaters do not require a vent to remove combustion gasses.

2. Natural gas and propane (bottled gas) water heaters

These are the large tank-type heaters that heat and store 30 to 50 gallons of water. This type of heater requires a metal pipe (3 to 4 inches in diameter) to vent gasses to the exterior. Combustion gasses contain large amounts of carbon monoxide and are very hot. If you suspect a problem with the heater vent, recommend that the customer call the gas supplier or a service technician.

3. Solar water heaters

Solar water heaters use the sun's energy to heat water. Many homes with solar heaters will also have a back-up gas or electric water heater for cloudy days. Identification of solar equipment usually is no problem. You may see one or two large tanks, pumps, valves, and solar collectors on the roof.

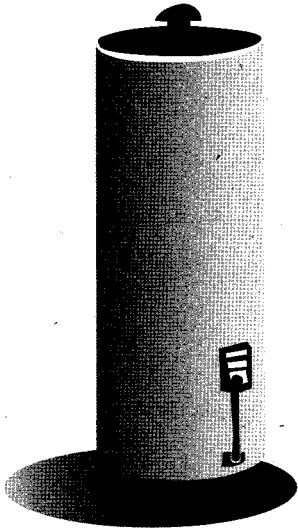

All domestic water heaters are required to be equipped with a relief valve as a safety feature to prevent damage from excessive pressure and temperature. There is always danger that this valve may become frozen or corroded from long disuse. Manually trip the lever of this valve every two or three months to be sure it will operate freely if an emergency arises. **Note:** The discharge will be hot water that will need to be contained in a pan or bucket or allowed to drain to a floor drain.

Water Heater Troubleshooting

Always turn off the power before working on an appliance!

| PROBLEM | ACTION: ELECTRIC WATER HEATER | ACTION: GAS WATER HEATER |
|-------------------------|--|---|
| No hot water | Check master switch, fuses or circuit breaker. Try pushing Reset Button. Call electrician if problem persists. | Check to see the pilot light is off. Follow instructions on unit. May have to re-light. Try pushing the Reset Button. Call utility person if necessary. |
| Insufficient hot water | Check thermostat setting and voltage. Repair any leaking faucets. | Same as electric. Make certain that burner flame is blue. If orange, clean out burner. Call utility person if necessary. |
| Water leaks from heater | Tighten heating element mounting bolts. Replace gasket if leak continues. Tighten pipefitting. Have plumber replace valve and heater if discharge is frequent. | Same as electric. |

Water Conservation Tip for Water Heaters

To spot leaks, start by looking at the base of the water heater. Look for signs of water or dampness below the heater base. Visually examine the heater from bottom to top as well as the pipes attached to the heater. On heaters with a pipe for venting combustion gasses (natural and propane), visually check the piping for a tight-looking connection.

Tip

Water Softeners



Rain is natural water in its purest form. As the water filters through the earth, it absorbs calcium, magnesium, and other minerals. When these materials are not dissolved in the water, but suspended in it, the water is called "hard." Hard water reduces the sudsing action of soap. A water softener removes calcium and magnesium and replaces them with sodium. People on low salt diets should not drink softened water.

There are four basic types of water softeners:

1. Manual water softeners

Manual units require the operator to initiate some or all of the steps in the softener operation.

2. Automatic water softeners (two types)

Semi-Automatic:

The operator initiates the regeneration cycle and the softener controls handle all the steps of regeneration and return to service.

Fully Automatic Softener:

A timer automatically initiates the regeneration cycle and every step in the regeneration process. The fully automatic version has an automatic time clock. It regenerates at preset times whether or not the resin needs it, and whether or not the water is used.

3. Demand initiated regeneration water softeners

If all operations are initiated and performed automatically in response to the demand for treated water it is called a demand style. This type measures gallons of water used, senses changes in water hardness, and measures changes in the electrical conductivity of the resin bed before initiating a regeneration cycle. This can be an efficient method of regeneration.

4. Portable exchange water softeners

Water softener tanks can be permanently installed units or portable exchange units. When the resin is exhausted in the portable exchange unit, the tank is removed and replaced with another containing regenerated resin. The exhausted tank is returned to a central location where it is regenerated.

Water Conservation Tips for Water Softeners

- The fully automatic softener can be very inefficient and water wasting.
- The Demand Initiated Regeneration type of water softener is very water efficient.
- No matter which type of water softener you buy, it is a good idea for all automatic water softener tanks to be equipped with on/off switches to prevent wasteful and costly regeneration when the units are not in use, such as during vacations.
- Check with a reputable plumbing service to find out whether water softeners should be used with your specific type of water.

tips

Water Treatment Units

People buy home water treatment units for many different reasons. After using a water treatment unit for a time, be aware of noticeable changes in sediment, water pressure, and taste in your water. Such changes as these may indicate that your filter should be replaced. Consult your manufacturer instructions to determine how often to clean and/or replace filters.

Daily Water Budget

Comparison of average daily, personal water use employing water conservation practices or fixtures vs. normal water use.

| BATHROOM | ACTIVITY | FREQUENCY | CIRCUMSTANCES | WATER USED | TOTAL |
|----------------|-----------|------------------------|---------------------------|-------------------------------|------------|
| | Toilet | 4 flushes/day | Ultra-low flush | 1.6 gpf | 6 gal.* |
| | | | Conventional | 3.5–7 gpf | 14–28 gal. |
| | | | | <i>gpf: gallons per flush</i> | |
| | Shower | Once/day for 5 minutes | Low-flow | 2.5 gal/min | 12 gal.* |
| | | | Conventional | 3–8 gal/min | 15–40 gal. |
| | Bath | Once/day | Tub 1/4 to 1/3 full | 9–12 gal. | 9–12 gal. |
| Full tub | | | 36 gal. | 36 gal. | |
| Shaving | Once/day | 1 full basin' | 1 gal. | 1 gal.* | |
| | | Open tap | 5–10 gal. | 5–10 gal. | |
| Brushing teeth | Twice/day | Brush & rinse | 1/4 – 1/2 gal. | 1/2–1 gal* | |
| | | Open tap | 2–5 gal. | 4–10 gal. | |
| Washing hands | Twice/day | 1 full basin | 1 gal. | 2 gal.* | |
| | | Open tap | 2 gal. | 4 gal. | |

| KITCHEN | Cooking ¹ | Washing produce | 1 full kitchen basin | 1–2 gal. | 1–2 gal.* | |
|----------------------|----------------------|----------------------------|----------------------------|-----------------|----------------------------------|-----------|
| | | | | Open tap | 5–10 gal. | 5–10 gal. |
| | Automatic dishwasher | Once/day Full Load | Short cycle | 8–13 gal. | 8–13 gal. | |
| | | | Standard cycle | 10–15 gal. | 10–15 gal. | |
| Manual dishwashing | Once/day | Full basins. | | | | |
| | | Wash & rinse | 5 gal. | 5 gal.* | | |
| | | Open tap | 30 gal. | 30 gal. | | |
| Laundry ² | 1/3 load/day | Portion of full load | | | 30–50 gal. (full) ... 10–15 gal. | |

| OUTDOORS | Lawn Trees & shrubs | Watering requirements vary with plant species, type of turf, season, region and soil type. Consult your local nursery or county horticulture agent. | | | |
|----------|---------------------|---|-----------------------------------|------------------------------|----------|
| | Car washing | Twice/month | • 5 full 2-gal. buckets .. | 20 gal/month | 1/3 gal. |
| | | | • Hose with shut-off nozzle | 100 gal/ month 3.5 gal. | |

* Total = about 40 gallons, plus 10 gallons for outdoor use = 50 gallons per day.

1 Real cooking figure will be higher to include boiling water, rinsing utensils and other uses.

2 Laundry figure is based on two full loads per person per week.

Numbers are based on approximate, average household use. Water use will vary with individual habits and lifestyles, differing water pressure and the age and model of appliances.

3. Resources

Guides/Books

Better Homes and Gardens Step-By-Step Plumbing

Meredith Corporation, Des Moines, Iowa. 1997

Black and Decker. The Complete Guide to Home Plumbing

Creative Publishing International, Inc. Minnetonka, Minnesota. 1998

Ortho's All About Plumbing Basics

Meredith Corporation, Des Moines, Iowa. 2000

Sunset Basic Plumbing

Sunset Publishing Corporation, Menlo Park, California. May 1998

Website Information

Do-it-yourself information

Today's Homeowner: Plumbing www.todayshomeowner.com/plumbing/index.html

The Natural Handyman www.naturalhandyman.com/iip/iip.shtml

Sierra Home: Home Design www.sierra.com/sierrahome/homedesign/howto/

Household Helper.Com www.household-helper.com/

Do-it-yourself: Plumbing <http://doityourself.com/plumbing/>

Energy information

Consortium for Energy Efficiency www.ceeformt.org/index.htm

EPA & USDOE Energy Star program www.energystar.gov/

Energy efficiency and renewable energy network www.eren.doe.gov/

websites continued on next page

Plumbing information

websites

| | |
|---|--|
| Basic faucet repairs and installation | www.sfsplumbing.com/frepair1.html |
| Lists of common mistakes made with other basic plumbing repairs | www.plumbingpal.com/archive/index.html |
| Plumbing Care and Repair Handbook | www.theplumber.com/handbook.html |
| Plumbing education and information-sharing website | www.plbg.com/ |
| Ask the Master Plumber | www.clickit.com/bizwiz/homepage/plumber.htm |

Plumbing codes and standards

| | |
|---|--|
| Ask the Inspector: questions answered about Uniform Plumbing Code | www.rogersnet.com/ |
| Help with building codes | www.codecheck.com/plumbing_links.htm |
| American National Standards Institute (ANSI): Administrator and coordinator of the US private sector voluntary standardization system | www.ansi.org/ |
| International Association of Plumbing and Mechanical Officials | www.iapmo.org/ |

Toilet information

Installation/Repairs/Maintenance/Advice

| | |
|--|--|
| Basic toilet repairs and installation information | www.sfsplumbing.com/trepair1.html |
| 10 mistakes people make when installing a toilet | www.plumbingpal.com/archive/Free_Report5.html |
| Toiletology 101: Toilet maintenance and repair information. Covers both tank and flush valve! | www.toiletology.com/index.shtml |
| The Toiletarium: Information about installing toilets (good illustrations) and discussion of the controversy over ULFTs and HR623 | www.kitchen-bath.com/hotstuff/titarium.htm |
| The Toilet Papers: Addresses common problems associated with toilets. Site includes link to page discussing the most popular types of toilet "guts." | http://members.home.com/doug.graham/toilet.htm |



California
Urban Water
Conservation
Council

*Check our website at
www.cuwcc.org for
more information.*

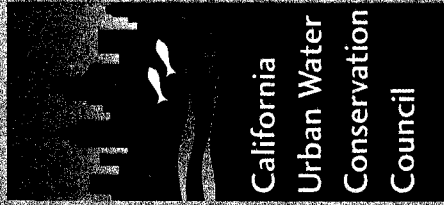

California
Urban Water
Conservation
Council

455 Capitol Mall
Suite 703
Sacramento, California
95814

916/552-5885

www.cuwcc.org



printed on:
recycled paper

