

National Aeronautics and Space Administration



EXPLORE

NASA SMALL SPACECRAFT

Strategic Plan

Preface: The 50th Anniversary of the Apollo Program and the Particles and Fields Subsatellites

Our nation is currently celebrating the 50th anniversary of the Apollo Program, and the Apollo 11 Moon landing. But a lesser known event associated with the Apollo Program is the deployment of small spacecraft during the Apollo 15 and Apollo 16 missions as the command module left lunar orbit. The Particles and Fields Subsatellite series, built by TRW, was designed to study the plasma, particle, and magnetic field environment of the Moon as well as to map the lunar gravity field. These units were the first small spacecraft released into space from a containerized deployment system.



Apollo 15 Astronauts David Scott, Alfred Worden, and James Irwin with the Particles and Fields Subsatellite deployed on August 4, 1971.

The Apollo 15 and Apollo 16 “subsatellites” were nearly identical, weighing 78.5 pounds and powered by six solar panels providing 24 watts of power with 11 silver-cadmium rechargeable batteries for nightside passes. The on-orbit average power produced was 14 watts. The spacecraft were 31 inches long with a 14-inch hexagonal-shaped diameter and communicated with a maximum data rate of 128 bits per second (a 49-kbit magnetic core memory stored data for later transmission). Each spacecraft was deployed from a spring-loaded dispenser/container that resembled a mailbox and imparted velocity at four feet per second while also spinning-up the satellite to 140 rpm. Once released, the spacecraft was spin-stabilized at a rate of roughly 12 rpm after the booms were deployed. The instruments consisted of a flux-gate magnetometer, charged particle detectors, and an S-band transponder. These three instruments were designed to measure the strength and direction of the interplanetary and terrestrial magnetic field, to detect variations in the lunar gravity field, and to measure proton and electric flux from the solar wind.

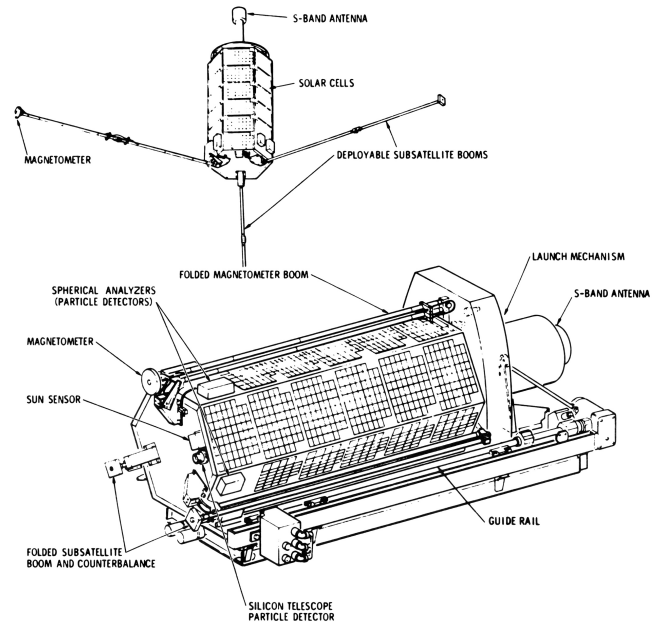

APOLLO SUBSATELLITE

Apollo subsatellite showing solar panels, instruments, deployment guide rails, and stowed deployable booms.

The Apollo 15 subsatellite, once released from the Command and

Service Module (CSM), orbited the Moon and flew into both interplanetary space and various parts of the Earth's magnetosphere. The mission operated for six months prior to an electronics failure that led to the end of orbital operations. All of the subsatellite mission objectives were nonetheless achieved, and the observations supported Explorer 35's finding that the Moon acts as a physical barrier to the solar wind creating a "hole" in the flow of charged particles. It is assumed that the orbit decayed and that the Apollo 15 subsatellite crashed into the moon, but the impact site is not currently known.

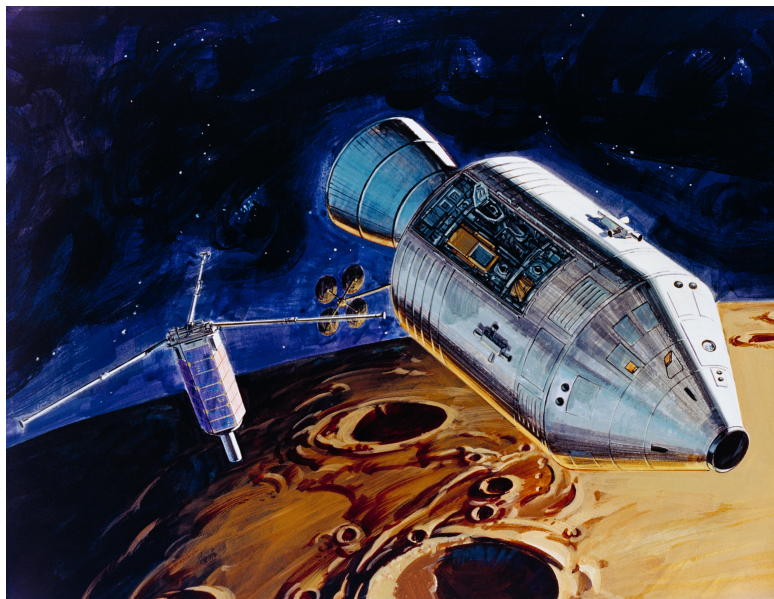

Artist's rendering of the subsatellite, post deployment, from the exposed scientific instrument module bay showing the open deployment door.

The Apollo 16 subsatellite was released by the CSM into a low lunar orbit and inclination, four hours prior to the trans-Earth injection burn, due to problems that occurred with the CSM main engine. Gravitational perturbations altered the orbit of the subsatellite causing it to crash into the lunar surface just 34 days into the mission, much earlier than planned. Nevertheless, 424 orbits around the Moon were completed and the satellite was successful in returning valuable low-altitude data as a result of the deployment.

The spirit of innovation and scientific discovery exemplified by the accomplishments of the Apollo Subsattelites 50 years ago is prevalent today within the small spacecraft community. Even then, as we reached for the Moon within the Apollo Program, it was understood that small spacecraft could provide an opportunity to fly multiple instruments on a containerized platform deployed from a host spacecraft to expand our knowledge of the cis-Lunar environment. Today, advances in space technology, platforms, instrumentation, and launch capability have inspired academia, industry, and government organizations to pursue new ambitious missions with such small spacecraft. Celebrating the Apollo subsattelites is a relevant reminder that the future potential for discovery with modern small spacecraft is as bright today as it was during the early days of human and robotic space exploration.

References:

- [1] Apollo 15 Press Kit
- [2] National Space Science Data Center
- [3] NASA SP-289 Apollo 15 Preliminary Science Report

Introduction

NASA's Science Mission Directorate (SMD), Space Technology Mission Directorate (STMD), and Human Exploration and Operations Mission Directorate (HEOMD) are actively engaged in the development of small spacecraft missions, capabilities, and space access to enable innovative science and exploration activities. NASA recognizes the potential of small spacecraft (from CubeSats to ESPA-class satellites) to enhance and enable Agency objectives. Indeed, NASA has supported small spacecraft mission development for more than a decade as small spacecraft capabilities have rapidly advanced with tangible results. There is a need, however, to improve coordination among the individual Mission Directorates (MDs) to place more emphasis on an overarching integrated strategy to advance overall Agency objectives. This document lays out a NASA Small Spacecraft Strategic Plan that supports the NASA 2018 Strategic Plan's four strategic goals of Discover, Explore, Develop, and Enable, while promoting a balanced portfolio of science, technology, and exploration missions. The strategies herein are also influenced by the National Academies of Science's *Achieving Science with CubeSats* report recommendations and add guidance to those recommendations to account for the future capability growth in launch systems and ESPA-class spacecraft.

Small Spacecraft Strategic Plan Priorities

The NASA Small Spacecraft Coordination Group (SSCG) has reviewed the Agency's strategic goals and determined that small spacecraft are responsive to all strategic objectives (except area 3.2: Transform Aviation Through Revolutionary Technology Research, Development, and Transfer). As a result, four cross-cutting themes have been identified: **High Priority Innovative Science**, **Support to Human Exploration**, **Disruptive Technology Innovation**, and **Regular Access to Space**. This plan outlines the strategies to advance these themes, along with an integrated implementation approach to achieve them. There will be other areas where the individual MDs have strategic goals where an integrated approach is not required; such instances are not explicitly identified here. This document only presents strategies to be pursued jointly by the MDs.



High Priority Science



Human Exploration

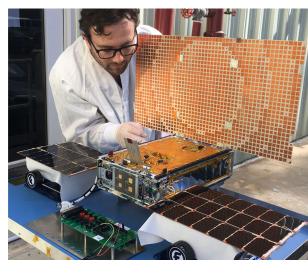

Disruptive Technology



Access to Space

SMD, STMD, and HEOMD have cooperated for many years on developing a role for small spacecraft within the Agency. The purpose of this document is to formalize the overarching integrated strategy and implementation approach.

Theme 1

High Priority Innovative Science

The MDs have identified three areas of strategic integration that support high priority innovative science: The first emphasizes mission portfolio balance among small, medium, and large missions for effective science return. The second, leveraging commercial industry for ground and flight system services, enabling multipoint spacecraft measurements and new mission architectures, broadening the design trade space between small satellite and traditional spacecraft systems. The third, developing products to educate the scientific community about capabilities supporting alternative science measurement techniques to achieve the National Academy of Science Decadal Survey recommendations, as well as opportunities offered by the Moon-to-Mars exploration initiative.

Strategy 1.1: Adopt small spacecraft as part of a balanced program of exploration, incorporating new technology, mission formulation, and launch capabilities to enable unique scientific observations.

Strategy 1.2: Actively partner on capabilities and services that enable multipoint measurements from distributed spacecraft systems.

Strategy 1.3: Educate the wider scientific community about mission formulation, technology, and launch service capabilities to enable decadal survey–class science and exploration initiatives.

SMD’s principal goal for small spacecraft is to enable new science measurements that are not attainable using traditional approaches. An additional goal for all MDs is to enable rapid and more affordable missions that utilize the latest available proven technologies. All of these objectives release the creativity of the diverse scientific and engineering community, leading to greater science return. The strategies identified below align with the SMD 2019 Science Plan cross-cutting foci of Exploration and Scientific Discovery, Innovation, Interconnectivity and Partnerships, and Inspiration.

STRATEGY 1.1

Adopt small spacecraft as part of a balanced program of exploration, incorporating new technology, mission formulation, and launch capabilities to enable unique scientific observations.

The ability of small spacecraft to advance and achieve NASA science objectives is highly dependent on the capability of the scientific and engineering community to identify creative and innovative ways for small spacecraft to enable new measurement approaches. To satisfy measurement requirements, mission design and development must be coordinated starting from early concept formulation through the

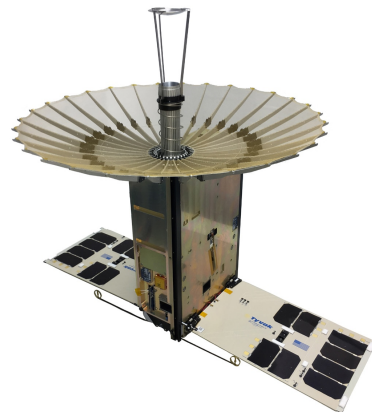

adoption of relevant, new, proven technologies for launch, operations, and science data return and analysis. The community has shown that publication-quality science can be achieved from the CubeSat platform (and that new hardware and software payload technologies can be matured and flight-proven). While CubeSats will continue to have a role, ambitions to achieve long-term, sustainable, continuous, science measurements have led NASA to augment its small spacecraft science mission planning to include larger ESPA-Class platforms that can achieve more complex science.

Under this strategy, NASA should place greater focus on development of scientific exploration opportunities where new technology, advanced launch capabilities, and innovative measurement concepts can resolve high-priority science questions through the relevant and appropriate use of small spacecraft. This strategy must be executed, however, using approaches that establish and preserve programmatic balance among all mission classes, from small to large. This will require examination of various mission architectures to weigh science return, development time, cost, and other key metrics against each other to effectively produce the best science.

Despite current successes, integrating smaller missions into a balanced portfolio of flight systems will require substantial improvements in flight system reliability. The capability and the reliability of the SmallSat spacecraft bus must match that of the science instruments. Technology programs that target spacecraft bus reliability, while continuing investments in miniaturized instrument development, are needed to fully realize the unique disruptive capabilities of small spacecraft. In concert with the rideshare community, NASA should develop and improve the standards, accommodation, and logistics for launch service capabilities to enable more flexible rideshare opportunities. This effort can include strategic partnerships with industry to leverage commercial advances, which will emphasize risk reduction and increase the diversity and rate at which new science can be produced.

STRATEGY 1.2

Actively partner on capabilities and services that enable multipoint measurements and distributed spacecraft missions.

Constellations that produce multipoint measurements are an emerging capability enabled by small spacecraft. Industry and other U.S. Government agencies are aggressively pursuing and developing large constellations of CubeSats and ESPA-class spacecraft for Earth observation, space situational awareness, and communications infrastructure. Academia, government, and industry are also actively engaged in both terrestrial applications of distributed small spacecraft missions and their potential scientific applications beyond Earth. In addition to large constellations for multipoint measurement of time variant phenomena, smaller more tightly controlled formations of small spacecraft may be well

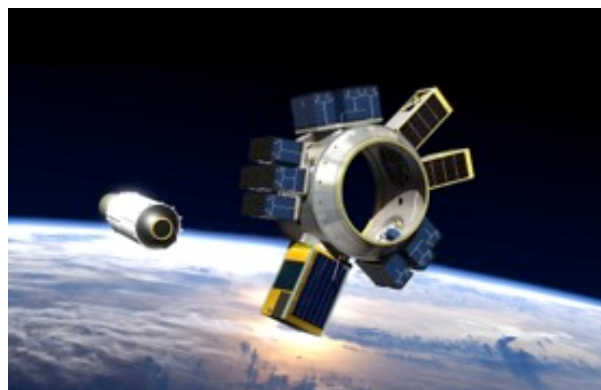

suites as platforms in areas such as Very-Long-Baseline Interferometry, synthetic aperture synthesis, and other precision collective measurements. These approaches, once proven, will offer new and more affordable mission architectures than traditional single spacecraft approaches. For missions beyond Earth, autonomous or semi-autonomous small spacecraft can provide off-axis observations in support of a larger spacecraft or allow a mission to visit multiple related targets. The science community has identified numerous new observations that can be enabled via strategic partnerships, as reflected in the National Academies report, *Achieving Science with CubeSats: Thinking Inside the Box*; as well as the Keck Institute for Space Studies report, *SmallSats: A Revolution in Space Science*; in addition to other publications and NASA-sponsored mission studies.

For missions in Earth orbit, NASA should work with industry and other U.S. Government agencies that are actively fielding or developing constellations. This collaborative effort should include spacecraft and ground system infrastructure capabilities where the MDs can partner to leverage industry advances to enable NASA missions. Other U.S. Government entities are also interested in distributed spacecraft mission capabilities, autonomous collaboration between space systems, and the ability for such spacecraft to operate without Earth-centric aids or ground based systems. NASA should work with those agencies and their commercial partners to enable distributed missions to operate near Earth, in cis-Lunar space, and beyond Earth, while collaborating with academia on new mission scientific objectives and applications.

STRATEGY 1.3

Educate the wider scientific community about mission formulation, technology and launch service capabilities to enable decadal survey-class science and exploration initiatives.

The capabilities demonstrated by small spacecraft—and their future potential—are still largely unknown to the broad science community. NASA should place specific emphasis on communicating the capabilities these systems can realistically support. This information will help investigators understand the benefits and tradeoffs among mission implementation approaches to achieve decadal survey and science-oriented exploration mission priorities. Missions such as the Cyclone Global Navigation Satellite System (CYGNSS) have shown how bold new approaches can lead to new measurement capabilities, establishing a path forward for others to follow. NASA should broaden existing opportunities for new investigators to engage with experienced principal investigators through focused community meetings, on-line resources, and other methods to grow a diverse community of current and future scientific leaders through the use of small spacecraft.

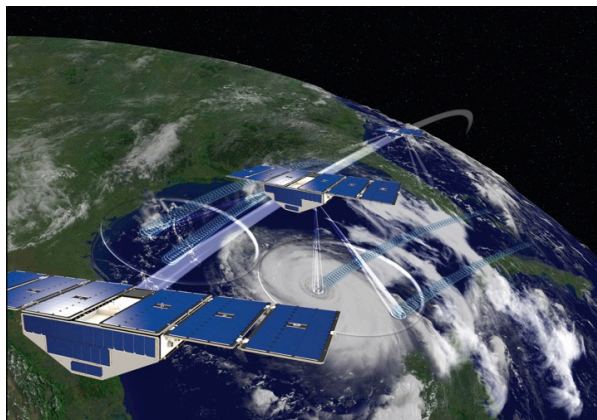

Theme 2

Support to Human Exploration

Sustainable human activity in deep space requires exploration capabilities that can be fielded faster and at lower cost. Small spacecraft afford an increasingly capable platform to precede and accompany human explorers to the Moon, Mars, and other destinations to scout terrain, characterize the environment, identify risks, and prospect for resources. Distributed systems of small spacecraft can responsively provide cost-effective communications, monitoring, and inspection of infrastructure for human exploration missions and cis-lunar commercial activity. Small spacecraft provide a rapid, affordable, and risk-tolerant way to address Strategic Knowledge Gaps (SKGs)¹ and test technologies that will permit sustainable human presence and exploration beyond Earth.

Given the scope of human exploration activities supporting NASA's Moon and Mars objectives, the MDs determined that leveraging industry developments will be essential to small spacecraft mission success.

Strategy 2.1: Actively partner with industry on capabilities and services for affordable small spacecraft missions to the Moon and Mars to support human exploration.

Strategy 2.2: Ensure that scientific and exploration activities in cis-lunar space involving humans and small spacecraft are coordinated, mutually beneficial, and complementary.

Guided by the need to address SKGs related to the larger human exploration goal, HEOMD will assess a variety of exploration objectives that could be addressed by sending small spacecraft beyond low Earth orbit (LEO) as both standalone precursor missions and technology demonstrations, or to support larger exploration missions.

STRATEGY 2.1

Actively partner with industry on capabilities and services for affordable small spacecraft missions to the Moon and Mars to support human exploration.

NASA's larger human exploration goal provides an overall strategic focus for a broad range of activities with the ultimate purpose of extending human presence into the solar system, from LEO to cis-lunar space, Mars, and beyond.

Objectives of interest at this time include understanding the lunar resource potential and the lunar environment and its effects on human life, as described in the set of lunar SKGs.



¹ <https://www.nasa.gov/exploration/library/skg.html>

Additionally, both NASA and industry are interested in using small spacecraft as a platform to provide rapid and affordable communications relays, navigational aids, and other support services for missions in cis-lunar space and to the lunar surface. To address NASA objectives as cost-effectively as possible, NASA should continue to partner with industry and leverage commercial advances and economic interests in cis-lunar space when planning development of reliable flight systems to enable NASA's exploration objectives.

STRATEGY 2.2

Ensure that scientific and exploration activities in cis-lunar space involving humans and small spacecraft are coordinated, mutually beneficial, and complementary.

Lunar activities in support of human exploration will utilize small spacecraft to directly support the closure of strategic knowledge gaps related to human exploration. These efforts also create a unique opportunity to pursue multiple science and technology maturation objectives on the lunar surface and in cis-Lunar space. Scientific and robotic exploration activities including surface exploration of lunar caves, analogous studies in planetary science, astrophysical observatories from the lunar surface and from radio quiet zones, development and test of communication relay systems, to name a few, can be performed in conjunction with missions supporting human exploration. One must ensure, however, that such activities are coordinated in such a way that no mission objectives are compromised. NASA should fully take advantage of this renewed and accelerated opportunity in returning to the Moon to also seek and engage in appropriate science and technology opportunities that can be performed in collaboration with human exploration objectives. Furthermore, science and technology activities that employ small spacecraft in this environment would pave the way for related work at other more distant exploration targets and destinations.

Theme 3

Disruptive Technology Innovation

The MDs have identified three areas of strategic integration that support disruptive technology innovation. The first involves collaborating directly with industry on risk reduction when innovative technologies are proposed for small spacecraft flight systems. The second, working directly with industry and academia on innovations that address specific NASA needs. The third, ensuring a culture of innovation and agility throughout the Agency by employing small spacecraft to enable NASA objectives.

Strategy 3.1: Collaborate on emerging commercial small spacecraft and systems to reduce risk on NASA missions.

Strategy 3.2: Partner with industry and academia to aggressively adapt innovative emerging technology capabilities to meet NASA's unique small spacecraft needs.

Strategy 3.3: Foster innovation, agile development practices, and embrace higher risk throughout the Agency through small spacecraft missions and flight demonstrations.

STMD's overarching goals for its engagement in the small spacecraft ecosystem are to enable rapid and more affordable exploration missions while facilitating the expansion of space commerce. All the MDs seek to leverage the risk-tolerant posture afforded by the faster timelines and lower costs of small spacecraft missions. Small spacecraft will enable MDs to incorporate technologies earlier and iterate through failures to create new capacities or recreate existing capabilities at a fraction of the cost of traditional systems.

STRATEGY 3.1

Collaborate on emerging commercial small spacecraft and systems to reduce risk on NASA missions.

At the end of 2018, NASA missions represented approximately 3% of the over 1,200 small spacecraft under 200kg launched. The overall market share for small spacecraft scientific missions worldwide is not anticipated to exceed 10% in the future. To implement truly affordable missions, NASA should embrace industry standardization and batch production. NASA needs to be an early adopter or fast follower for most small spacecraft technologies and make use of standardized spacecraft and spacecraft parts developed for commercial applications in place of mission-specific solutions where possible. The MDs should collaborate to identify emerging commercial capabilities that can enhance or enable NASA missions and exercise use of these capabilities in relevant environments to reduce the risk of incorporating them into future missions.

STRATEGY 3.2

Partner with industry and academia to aggressively adapt innovative emerging technology capabilities to meet NASA’s unique small spacecraft needs.

When NASA established its initial small spacecraft technology development and demonstration activities, broad investment was needed in compact and low-cost propulsion, power, communications, attitude determination and control, and other common spacecraft subsystems. While the small spacecraft community and industry have evolved since then, many advances are still needed. In the current environment, NASA can afford to focus on key areas for investment, rather than attempting to make advancements across the full spectrum of technology gaps. There is clear and growing



investment by the public and private sector in small spacecraft. This environment affords NASA the ability to target specific gaps that market forces will not otherwise fill. Achieving NASA strategic goals in novel and more affordable ways will require pushing technology boundaries beyond the capabilities currently sought by commercial and other U.S. Government agency applications. NASA is unique within the current market as some of its missions require expanding the capabilities of small spacecraft into challenging deep space environments. NASA should also recognize the growing role played by commercial entities outside of the aerospace realm—especially the consumer electronics market—in the advancement and proliferation of small spacecraft. These industries are heavily investing in compact electronics, battery technologies, materials technologies, sensors, and other components. NASA should take advantage of innovations developed by these industries and opportunistically adapt them for space applications. To support this, NASA should also develop innovative procurement mechanisms to support rapid and aggressive adoption of emerging technology.

STRATEGY 3.3

Foster innovation, agile development practices, and embrace higher risk throughout the Agency through small spacecraft missions and flight demonstrations.

For effective technology development, NASA must embrace agile aerospace practices from industry. NASA can work with industry and academia to apply the “80/20 rule” to small spacecraft missions and target an 80% solution for a capability at 20% of the traditional cost. Like the Air Force Research Laboratory, NASA can also use small spacecraft for missions that are largely driven by technical and non-technical constraints rather than mission requirements; the objective is to produce as much of the desired capability as possible within a fixed cost and time. By using lower cost small spacecraft in higher quantity, the MDs can help enable missions for exploration and discovery while supporting the development and retention of NASA workforce through a number of approaches. Small and agile teams can test commercial systems to facilitate NASA use.

NASA can partner with industry to modify commercial capabilities for NASA specific applications, and—when necessary—develop solutions to NASA-specific problems. NASA should accept 15% to 50% spacecraft failure rate, for technology-focused missions, at the portfolio level and plan the size, scope, and use of such small spacecraft missions accordingly. The MDs believe the path to higher reliability for small spacecraft is through mission- or portfolio-level redundancy. The success or failure of the overall mission extends beyond the success or failure of any one spacecraft or project. Costly efforts to eliminate uncertainty in technical risk jeopardize future opportunities for achieving the desired results. For technology demonstration missions, NASA should further accept that the majority of promising technologies will not always prove successful on the first attempt and a successful mission may be one that identifies a failure of the technology. Accordingly, NASA should structure demonstration mission opportunities to allow for iterative attempts.

Theme 4

Regular Access to Space

The MDs have identified three areas of strategic integration that support regular access to space. The first involves establishing a focal point for coordinating access-to-space opportunities in a cohesive manner, including providing clarity on launch vehicle capabilities and rideshare opportunity forecast for proposers to small spacecraft solicitations. The second, exploring new methods to increase the manifest options and expand potential destinations for small spacecraft, including those beyond LEO. The third is working directly with regulatory agencies to streamline and reduce the complexity of licensing that sometimes drives delivery issues affecting NASA partners.

Strategy 4.1: Coordinate access-to-space opportunities for NASA’s small spacecraft.

Strategy 4.2: Explore new methods to increase space access by providing flexibility in destinations, capability, and manifesting options, while preserving core capabilities.

Strategy 4.3: Identify and address regulatory roadblocks to streamline processes impacting space access for our NASA partners.

Capabilities that enable regular access to space are essential to the growth of small spacecraft missions; NASA continues to play a leading role via the CubeSat Launch Initiative (CSLI) and the direct manifest of other small payloads on a variety of launch vehicles. As NASA-sponsored payloads grow in complexity and diversity of destination, the strategies above will help sustain our current efforts and facilitate the utilization of new capabilities within government and the commercial sector to support future missions.

As launch remains a high-risk element affecting mission success, HEOMD’s principal objective will continue to be the successful launch of NASA’s primary missions. Therefore, HEOMD must work with payload-sponsoring MDs to assure all small spacecraft missions manifested as rideshare payloads understand and meet “do-no-harm” standards.

STRATEGY 4.1

Coordinate access-to-space opportunities for NASA’s small spacecraft.

HEOMD enables access to space for small spacecraft by facilitating rideshare opportunities on NASA primary missions, other U.S. Government primary missions, and commercial missions, as well as dedicated small spacecraft launch opportunities when appropriate. Finding and matching up rideshare payloads with launch opportunities could be better managed and coordinated across the Agency by establishing an Agency

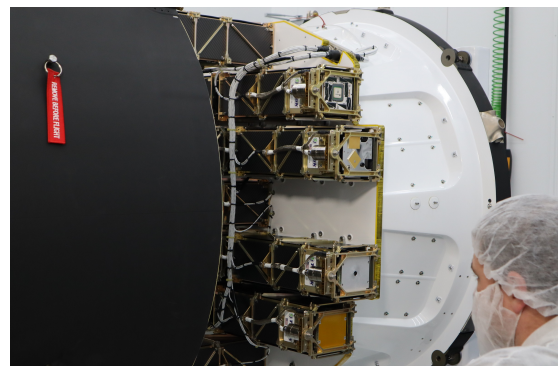

focal point to accomplish these activities. This entity could provide integrated compatibility assessments and priority recommendations to inform manifesting authorities such as the Agency Flight Planning Board.

Small spacecraft Mission-of-Opportunity solicitations sponsored by SMD are being issued to develop a pipeline of rideshare payloads that can support unique science observations and take advantage of excess ascent performance on SMD primary missions. However, rideshare-related documentation to support proposal development requires a central repository for public access and document maintenance. Processes related to evaluation of Mission-of-Opportunity proposals must be improved so that proposals are not unduly penalized for the uncertainty surrounding a launch opportunity.

STRATEGY 4.2

Explore new methods to increase space access by providing flexibility in destinations, capability, and manifesting options, while preserving core capabilities.

Frequent and flexible access to LEO has been a key driver in the rapid development of small spacecraft and proliferation of their application. Distributed spacecraft missions and expansion of small spacecraft beyond LEO will require new capabilities and processes that provide frequent and flexible access to those new architectures and destinations. The trend for NASA small spacecraft missions will be to support multiple observing systems within multiple orbital configurations in LEO, GEO, cis-lunar space, and eventually beyond the Earth-Moon system. The ability to responsibly and reliably deploy these systems will require direct efforts to promote a variety of launch capabilities and launch vehicle-to-spacecraft payload interfaces.



HEOMD provides access to space for the Agency—which includes access to the ISS, acquisition of commercial launch services for primary Agency missions, and access to cis-lunar space and beyond—via commercial and government systems including the Space Launch System. HEOMD also has mechanisms in place to manifest CubeSats on commercial launches and those procured by other U.S. Government entities. The Lunar Gateway, propulsive secondary payload adaptors or orbital maneuvering vehicles, and additional new commercial capabilities in development will add to existing capabilities in the near future. In addition, sometimes the smaller budgets typical of small spacecraft development result in manifest changes, requiring flexibility to take full advantage of valuable launch opportunities. NASA is also developing requirements and policies for rideshare payload delivery and integration that would enhance manifest flexibility.

STRATEGY 4.3

Identify and address regulatory roadblocks to streamline processes impacting space access for our NASA partners

Numerous small spacecraft missions from industry and academia that are NASA-sponsored, but not NASA-owned, have been negatively impacted by regulatory policies external to the Agency – adding risk to mission success. These include inconsistent interpretation or application of documented rules or guidelines and recommendations, including topics related to spectrum management and orbital debris mitigation. As the use of propulsion systems and pressure vessels becomes more ubiquitous, or as hazardous materials are introduced for spacecraft launched as rideshare payloads on dedicated small launch vehicles, it will be critical to understand the regulatory framework for such non-NASA missions. This will impact how NASA can work with the regulatory authorities, or exercise NASA's own processes and authorities, in support of contributions to NASA objectives through non-NASA missions.

Acronym List

Acronym	Definition
CSLI	CubeSat Launch Initiative
CSM	Command and Service Module
CYGNSS	Cyclone Global Navigation Satellite System
EELV	Evolved Expendable Launch Vehicle
ESPA	EELV Secondary Payload Adapter
FPB	Flight Planning Board
GEO	Geostationary Earth Orbit
HEO/AES	Human Exploration and Operations / Advanced Exploration Systems
HEO/LSO	Human Exploration and Operations / Launch Services Office
HEOMD	Human Exploration and Operations Mission Directorate
ISRU	In-Situ Resource Utilization
LEO	Low Earth Orbit
MD	Mission Directorate
SKG	Strategic Knowledge Gaps
SMD	Science Mission Directorate
SSCG	Small Spacecraft Coordination Group
STMD	Space Technology Mission Directorate