

GLAS

Installation Instructions

Preliminary - this information may change

Support

If at any point you need assistance, we're here to help.

Visit www.glas.johnsoncontrols.com/support for how-to videos and frequently asked questions.

Can't find what you're looking for? Give us a call at 1-833-297-4527(GLAS) and our technical team can walk you through it.

Before you start, download the GLAS app for easy installation.



Google Play and the Google Play Logo are marks and/or registered marks of Google LLC. Apple, the Apple Logo and App Store are marks and/or registered marks of Apple Inc.

Preliminary - this information may change

Included in the box



GLAS smart thermostat



Air seal



Wall plate



C-wire adapter



Quick start guide



2x 1-1/2" Pan-head Phillips screws



2x 1" Pan-head Phillips screws



2x 1" Flat-head Phillips screws



4x Drywall anchors



Wiring stickers

Tools required



Screwdriver



Drill with 1/4" bit



Level

Preliminary - this information may change

Compatibility

GLAS is compatible with most 24 VAC heating and cooling systems.

Use the compatibility checker to ensure your system will work with GLAS by going to www.glas.johnsoncontrols.com/compatibilitychecker.

Heating	One or two stages
Cooling	One or two stages
Heat Pump	One or two stages with one or two stages auxiliary heat
Fan	Single-speed fan
Auxiliary	Humidifier, dehumidifier, or ventilator (including HRV or ERV)

Preliminary - this information may change

Terminal descriptions

Note: If you have only one R wire, connect to RC.

Note: If you are removing an existing thermostat, remove any jumper wires between R and RH or RC and RH. You will not need these for GLAS.

Y1 First stage of cooling or first stage heat pump

Y2 Second stage of cooling or second stage heat pump

W1 First stage of conventional heating or first stage auxiliary heat for heat pump systems

W2 Second stage of conventional heating or second stage of auxiliary heat for heat pump systems

G Fan

Preliminary - this information may change

Terminal descriptions

- O/B Heat pump reversing valve (supports both O type and B type)
- AUX Auxiliary - humidifier, dehumidifier, or ventilator
- Rc 24 VAC Cool
- Rh 24 VAC Heat
- C 24 VAC Common

Preliminary - this information may change



IMPORTANT: If your thermostat is built into the wall and connected to thick wires with wire nuts, or if it is labeled 110, 120, or 240 volts, you have a high voltage system that is **not compatible** with the GLAS Thermostat. Do not connect your thermostat to these high voltage wires. GLAS is only compatible with 24 VAC systems.

Preliminary - this information may change

To begin installation, turn off system power

1. **Turn off all power** to your heating or cooling system at the HVAC unit's electrical switch or the breaker box for the building to avoid electrocution or shock.

Note: If you are not replacing an existing thermostat, skip to Step 6.

2. If you want to check your system power, adjust the temperature on your current thermostat and wait a few minutes to ensure that your heating or cooling does not power on.



WARNING: Risk of Electric Shock.

Turn off the power supply before making electrical connections. Contact with components carrying hazardous voltage can cause electric shock and may result in severe personal injury or death. If you have any doubts about properly installing the device, please contact a professional installer.

Preliminary - this information may change

Check old wiring

3. If you are replacing an existing thermostat, remove the front plate of your old thermostat and take a picture of the current wire colors and connections. This picture will come in handy when connecting your new thermostat.

Preliminary - this information may change

Removing your old thermostat

4. Before removing the wires from your thermostat terminals, use the included wiring stickers to label your wires.
5. Disconnect your old thermostat and remove the backplate.

Note: While disconnecting your old thermostat, use drywall-safe tape to secure the wires and keep them from falling back into the wall.

Preliminary - this information may change

Installing your GLAS

6. Remove the front plate by pulling the center of the silver cover toward you from the bottom.

Note: Do not pull on the black sensor bar while removing the front plate as this could damage the device.

7. Use a level and the included wall plate to mark the wall where you plan to hang the thermostat. Then drill the holes using the 1/4" drill bit and push in the drywall anchors.

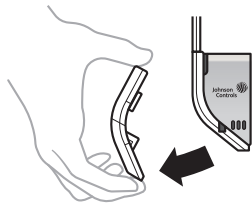
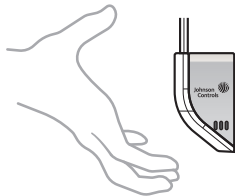

Preliminary - this information may change

Installing your GLAS

8. Remove the liner over the air seal adhesive and align the seal with the drill holes on the back side of the GLAS device. Lightly press to secure.

Note: If you are using the optional back plate, secure between the wall and the GLAS before screwing in the device.

9. Pull all of the wires through both the air seal and terminal opening in the GLAS smart thermostat. Press firmly on the wires to push them through the air seal.

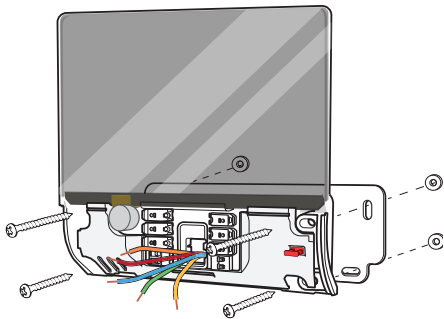

Preliminary - this information may change

Attaching your GLAS

10. Loosely attach your GLAS to the anchors installed in the wall using the included screws.
11. Use a level to straighten the thermostat and tighten the screws until snug. Do not overtighten.

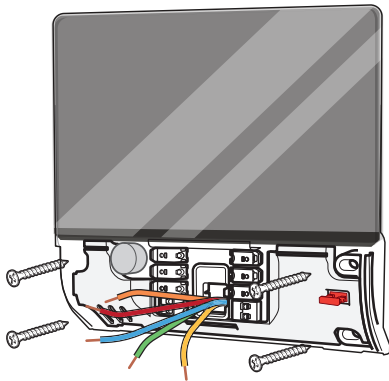

Preliminary - this information may change

Connect optional C-wire adapter

Note: If you have a C-wire at your thermostat, skip to Step 16. If you do not have a C-wire to power your thermostat, use the included C-wire adapter to provide power.

12. Remove the cover of your furnace or air handling unit to access the control board and take a picture of the current wiring for reference.
13. In your HVAC equipment, disconnect the **Y**, **W**, **R**, or **G** thermostat wires that are currently connected to the control board. Do not disconnect any of the other wires.

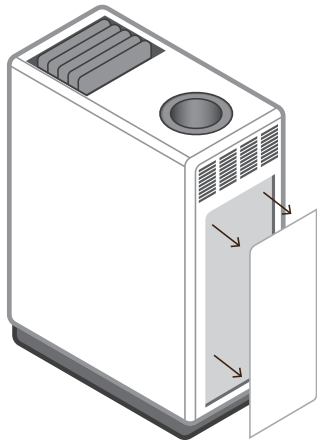

Preliminary - this information may change

Connect the C-wire adapter

14. Remove the adapter cover and connect the now disconnected **Y**, **W**, **R**, or **G** wires to the corresponding terminal on the C-wire adapter.
15. Connect the five labeled wires on the adapter to the corresponding terminals on the control board.

Note: See pages 20-22 for wiring configurations.

Note: Connections for the **G**, **Y**, and **R** wires are required to support the adapter.

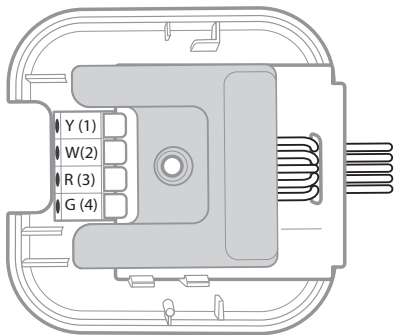

Preliminary - this information may change

Wiring your GLAS

16. Use the picture you took of your old wiring and the wiring stickers as a reference and connect the wires to the corresponding terminals on your new GLAS.
See pages 23-43 for wiring examples.

Note: Depending on the features of your furnace or air handler, you may not have a connection for every terminal.

Preliminary - this information may change

Attach the front plate

17. Before replacing the cover, remove the red tab to the right of the wiring terminals by pulling straight out. This will enable the backup battery in your device.
18. Make sure any excess wire is flush against the device and press the front plate until you hear a click.

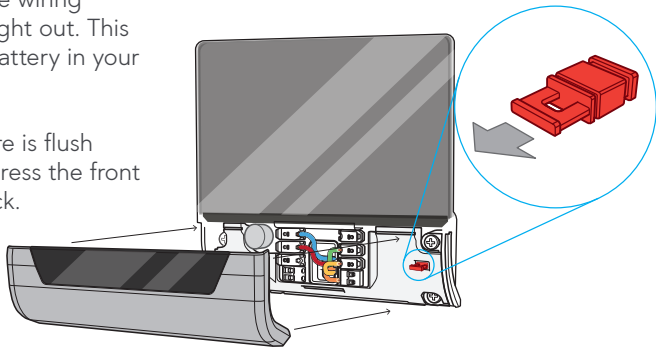

Preliminary - this information may change

Powering on your heating and cooling system

19. Return to your heating and cooling system switch or breaker box to turn the power back on.
20. Once power has been switched on, wait for the welcome screen with the GLAS logo and select **Tap to continue**. After continuing, you will be prompted to accept the End User License Agreement and then the Privacy Notice and Terms of Service to access Internet-enabled features.
21. You will be prompted to confirm your wiring. If any wires were incorrectly detected, tap to correct them.
22. Follow the instructions on the device screen to complete the setup for your heating and cooling system.

Preliminary - this information may change

WIRING DIAGRAMS

NOTE: Wire colors are for reference only. Not every installation will have wires of the same color. If you are unsure of how to properly install the unit, please contact a licensed electrician or a professional HVAC installer before attempting the installation.

Preliminary - this information may change

Preliminary - this information may change
Heating and Cooling without C-wire (Optional AUX)

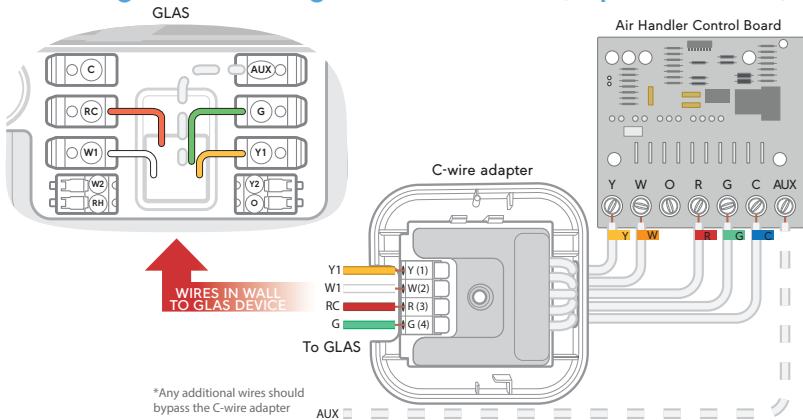

Preliminary - this information may change
Cooling Only without a C-wire (Optional AUX)

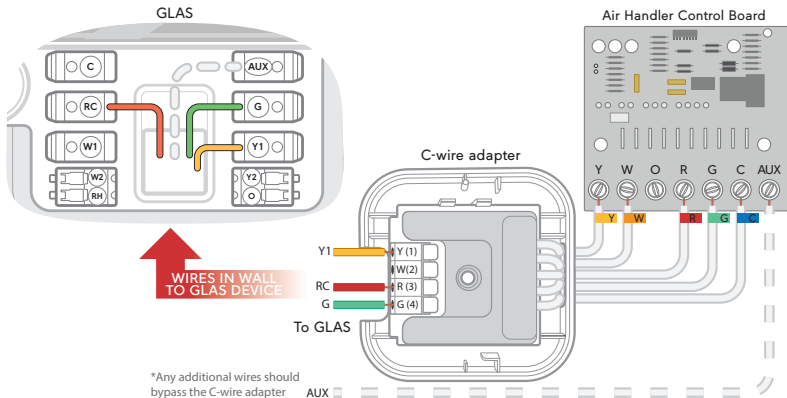

Preliminary - this information may change
Heat Pump with Auxiliary Heat without C-wire (Optional AUX)

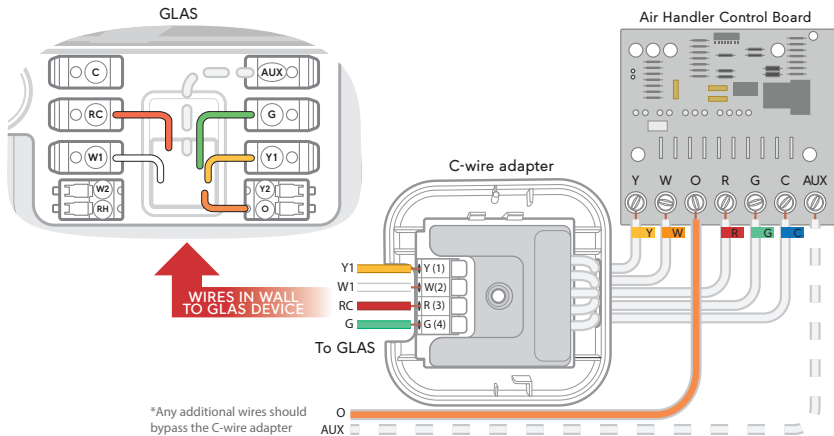

Preliminary - this information may change
Traditional AC and Heat

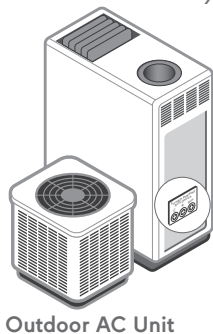

Furnace

Outdoor AC Unit

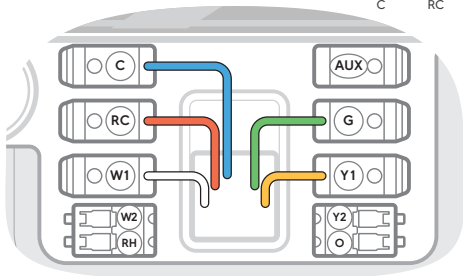
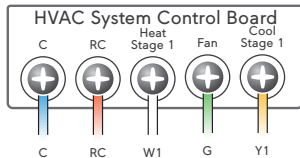

Preliminary - this information may change
Heat Pump

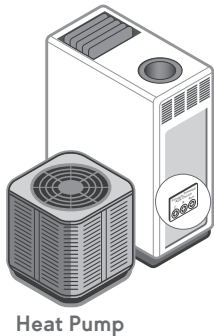

Heat Pump

Furnace

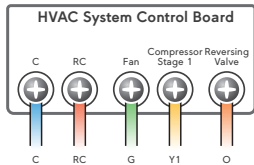
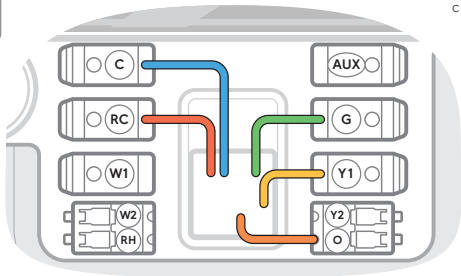

Preliminary - this information may change
One Stage Heat Pump with One Stage Auxiliary Heat

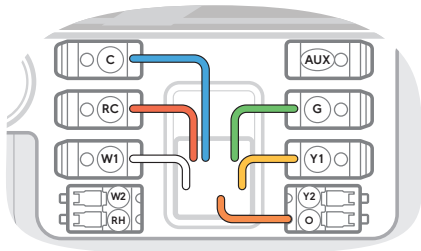
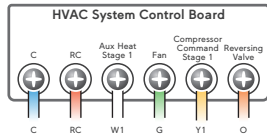
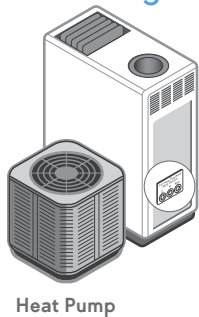

Preliminary - this information may change
Traditional Heat

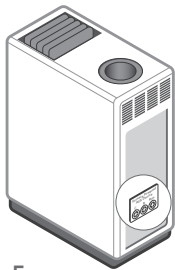

Furnace

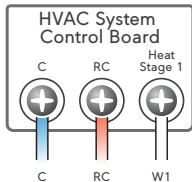
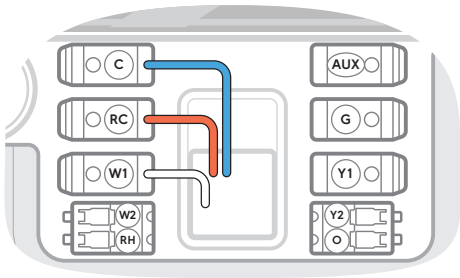

NOTE: When there is only one transformer, the RC terminal is used.

NOTE: Forced air heating systems often have a G wire to run the fan independently, but not all systems use a G wire.

Preliminary - this information may change
Traditional AC

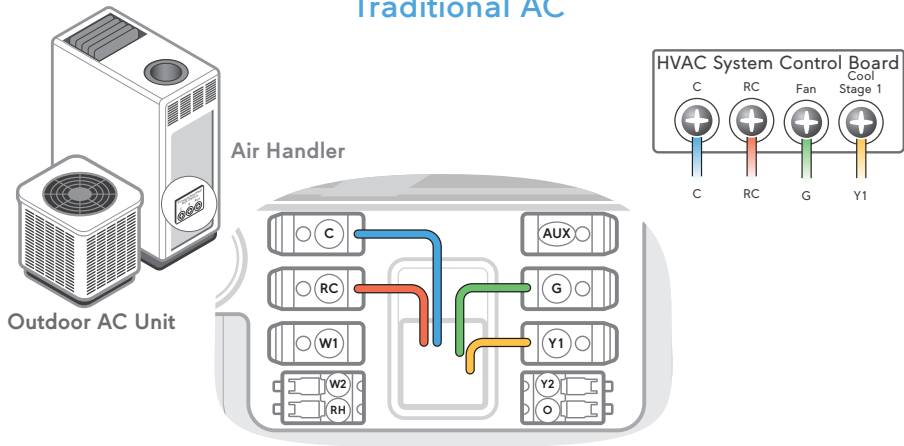

Preliminary - this information may change
Self-Powered Auxiliary Device

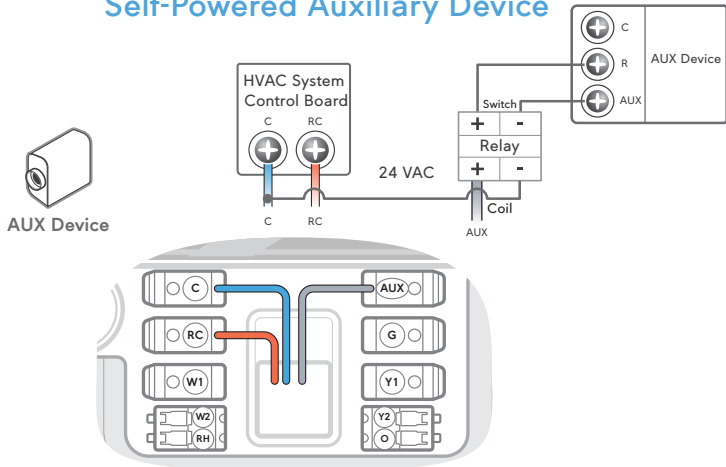

Preliminary - this information may change

Furnace-Powered Auxiliary Device

An integrated auxiliary system is built into a furnace or air handler that shares the same power supply as the rest of the system and only requires a single control wire.

Preliminary - this information may change
Furnace-Powered Auxiliary Device

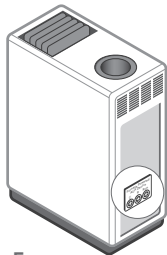

Furnace



AUX Device

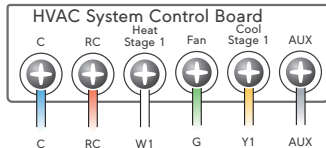
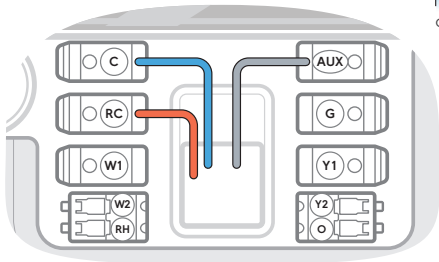

Preliminary - this information may change
Two Wire Auxiliary Device without C Terminal

An auxiliary device that has two terminals with the same label (HUM, DEHUM, or AUX) and no C terminal requires a relay pack for operation.

Note: For information on how to obtain a relay pack, contact the nearest Johnson Controls[®] representative.

1. Connect the relay pack coil between the auxiliary device and C terminal on your GLAS device.
2. Connect the switch side of the relay pack to the two terminals on the AUX device.

Preliminary - this information may change
Two Wire Auxiliary Device without C Terminal

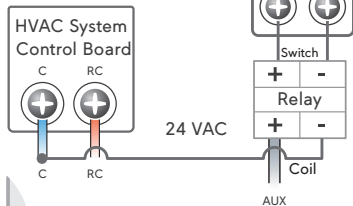
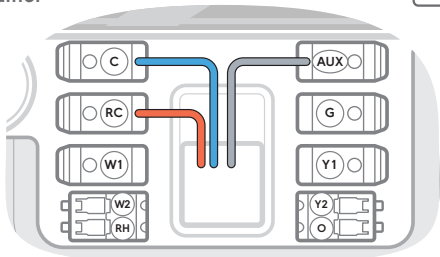

Preliminary - this information may change

Two Wire Auxiliary Device with C Terminal

An auxiliary device with one C terminal that does not require a relay pack for operation.

1. Connect the C terminal of the device to the C terminal on the furnace or air handler.
2. Connect the AUX terminal of your GLAS device to the control terminal on the auxiliary device.

Preliminary - this information may change
Two Wire Auxiliary Device with C Terminal



2-Wire AUX Device

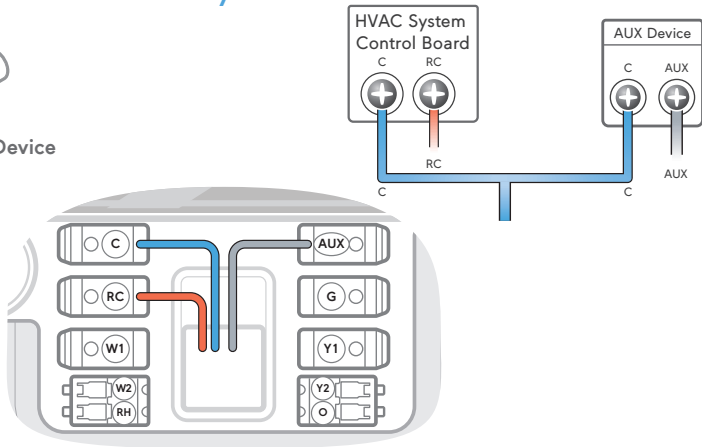

Preliminary - this information may change
Dual-Stage Heat

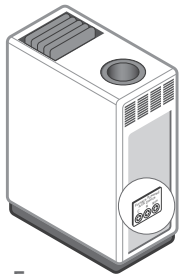

Furnace

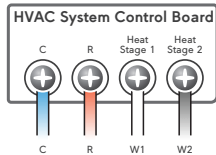
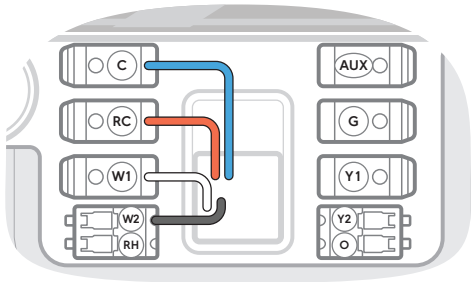

Preliminary - this information may change
Dual-Stage AC

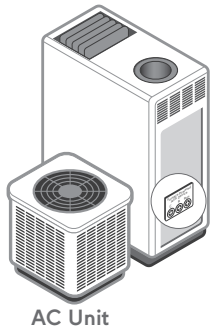

Air Handler

AC Unit

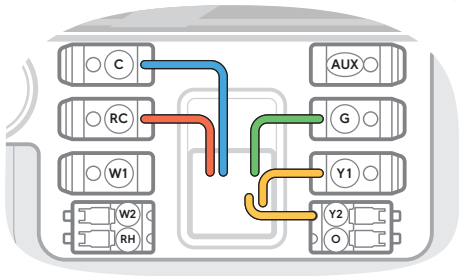
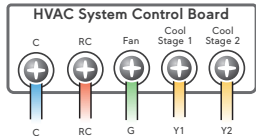

Preliminary - this information may change
Dual-Stage Heat and Traditional AC

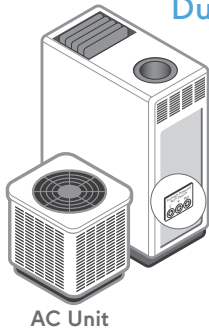

Furnace

AC Unit

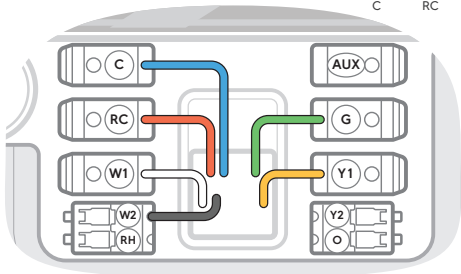
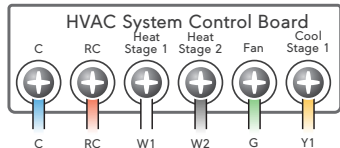

Preliminary - this information may change
Dual-Stage Heat and Dual-Stage AC

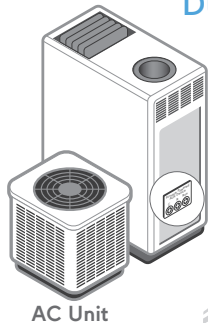

Furnace

AC Unit

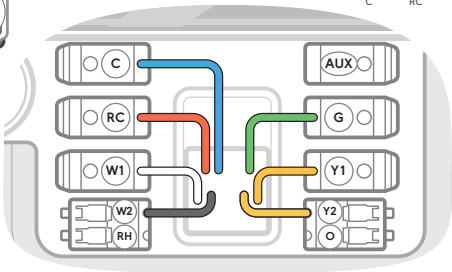
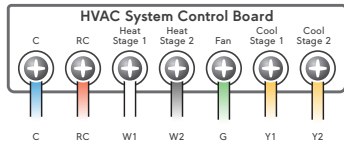

Preliminary - this information may change
Dual-Stage Heat Pump

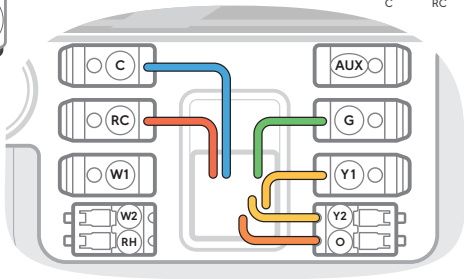
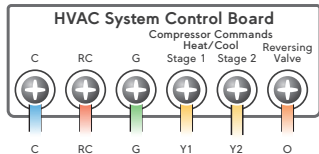
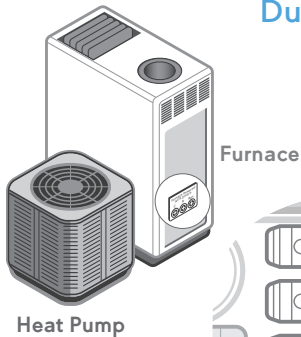

Preliminary - this information may change
Dual-Stage Heat Pump with Auxiliary Heat

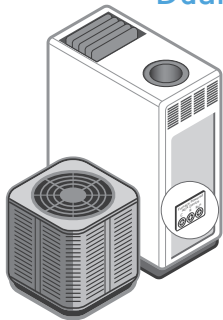

Heat Pump

Furnace

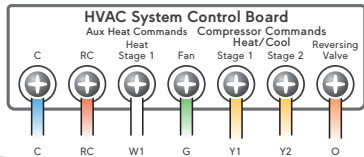
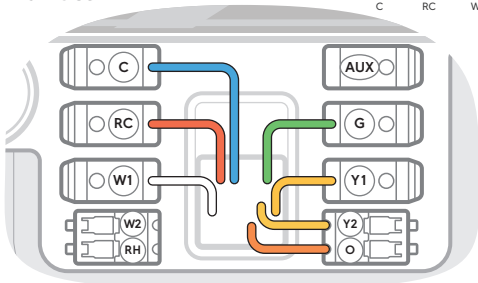

Preliminary - this information may change
Heat Pump with Dual-Stage Auxiliary Heat

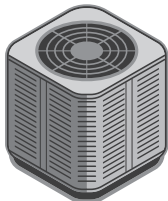

Heat Pump

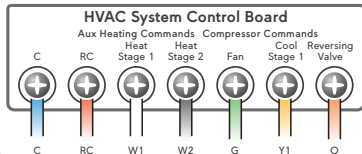
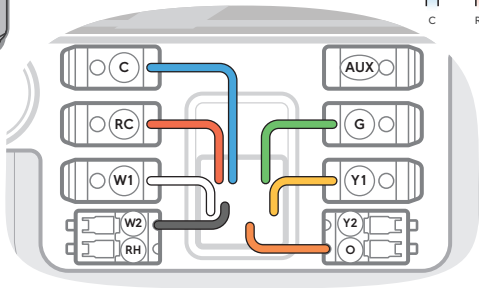

Preliminary - this information may change
Traditional Heat/AC with Dual Transformers

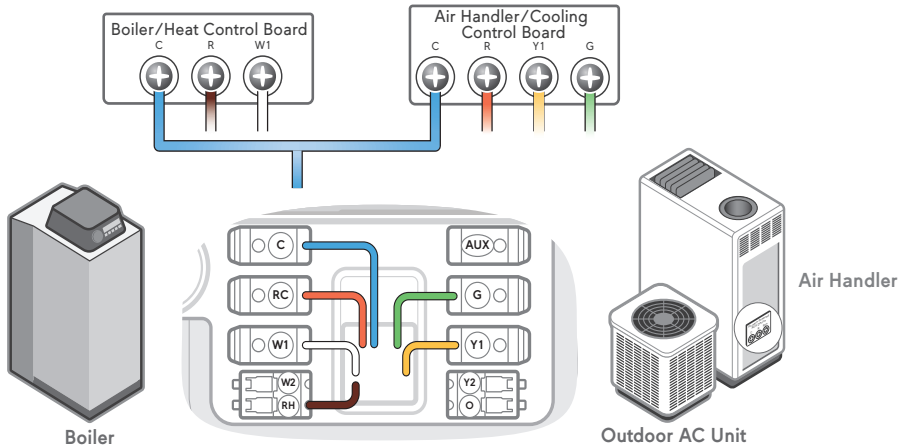

Preliminary - this information may change

Regulatory information to user

FCC Part 15C/Industry Canada Radio Equipment Standards

1. This device complies with part 15 of the FCC Rules. Operation is subject to the following two conditions: (1) This device may not cause harmful interference, and (2) this device must accept any interference received, including interference that may cause undesired operation.

2. This device complies with Industry Canada's license-exempt RSSs. Operation is subject to the following two conditions:

(1) This device may not cause interference; and

(2) This device must accept any interference, including interference that may cause undesired operation of the device.

Cet appareil est conforme aux flux RSS exemptés de licence d'Industrie Can-ada. L'opération est soumise aux deux conditions suivantes:

(1) Cet appareil ne doit pas provoquer d'interférence; et

(2) Cet appareil doit accepter toute interférence, y compris les interférences pouvant entraîner un fonctionnement indésirable de l'appareil.

CAN ICES-3 (B)/NMB-3(B)

RF Safety Statement

· This device complies with the RF safety requirements for Canada and the USA as per RSS-102 and FCC Part 1.1310, RF Exposure radiation limits for the General Population / Uncontrolled Exposure.

· This device shall be installed to maintain a separation distance of at least 20 cm (8 in) from the general population.

Changes or modifications not expressly approved by Johnson Controls will void your authority to operate this device. Warranty can be found at www.glas.johnsoncontrols.com/legal/warranty.

Preliminary - this information may change

Part No. 24-11158-00016, Rev. D

