

Print Head Installation Guide

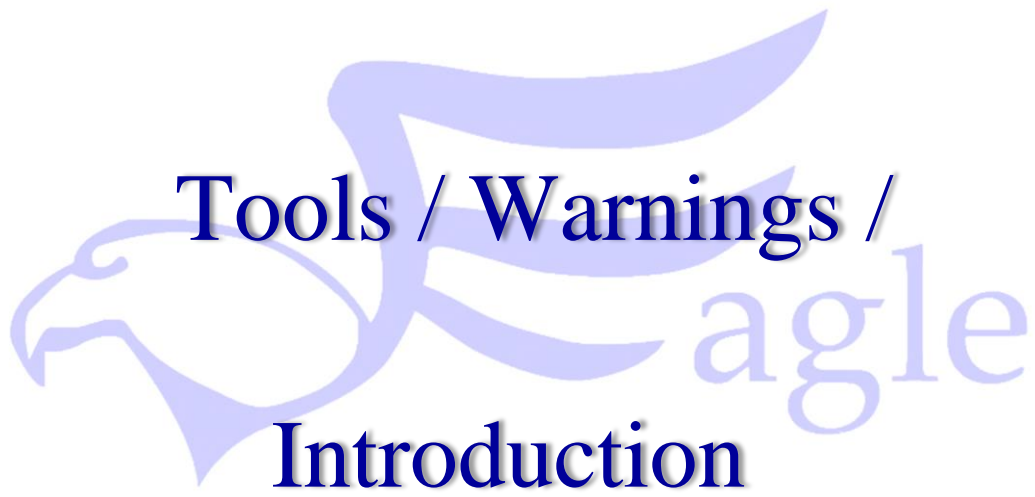

Contents

Tools.....	4
Warnings	4
Introduction	4
Section One	6
Pillar Installation	6
Section Two.....	12
Print Head Installation	12
Section Three	15
Ink Supply Controller Installation.....	15
Section Four	19
Pump Control Box Installation	19
Eagle Print Control Box Connections	20
Eagle Print Head Connections.....	21
Raptor Control Box Connections.....	22
Section Five	24
Print Head Height Setting & Alignment	24
Section 6.....	30
Sensor Installation.....	30
Section Seven	34
Installing the Light Tree.....	34
Setting Up the Light Tree	36
Section Eight.....	40
Purging and Priming the Eagle Print Head	40
Section Nine	51
Preparing the Print Head for Storage.....	51



Tools

Tools needed to install the MCS Eagle Print Head

- Screwdrivers
- Allen Wrench
- Measuring Tape
- Level
- Gloves

This manual details how to install the MCS Eagle Print head on either a 530 or 430 base. The 530 base includes space for a dryer and the 430 base only has room for the print head.

Warnings

- ▶ Do not touch the print head with your fingers.
- ▶ Use gloves when handling ink.
- ▶ Use only Think Ink approved gloves and wipes.

Introduction

This manual details how to install the MCS Eagle Print System on either a 530 or 430 base. The 530 base includes space for a dryer and the 430 base only has room for the print head.

Section One

Pillar Installation



Section One

Pillar Installation

Step 1

Install the pillars to the base in the following manner:

- A. Slide one of two T-Nuts into the middle back channel
- B. Insert one of two supplied hex head Allen screws into the through hole in the base of the pillar and start the threading it into the t-nut. (Note: Do not tighten at this time)
- C. Slide the pillar towards the front of the base to allow for the second of two t-nuts to be placed into the channel.
- D. Align the back through hole in the pillar with the t-nut and begin threading the second of two hex head Allen screws into the t-nut. (Note: Do not tighten at this time) refer to image 1-1
- E. To install the Front Pillar, perform steps "A" through "D" at the front middle channel position, see image 1-2

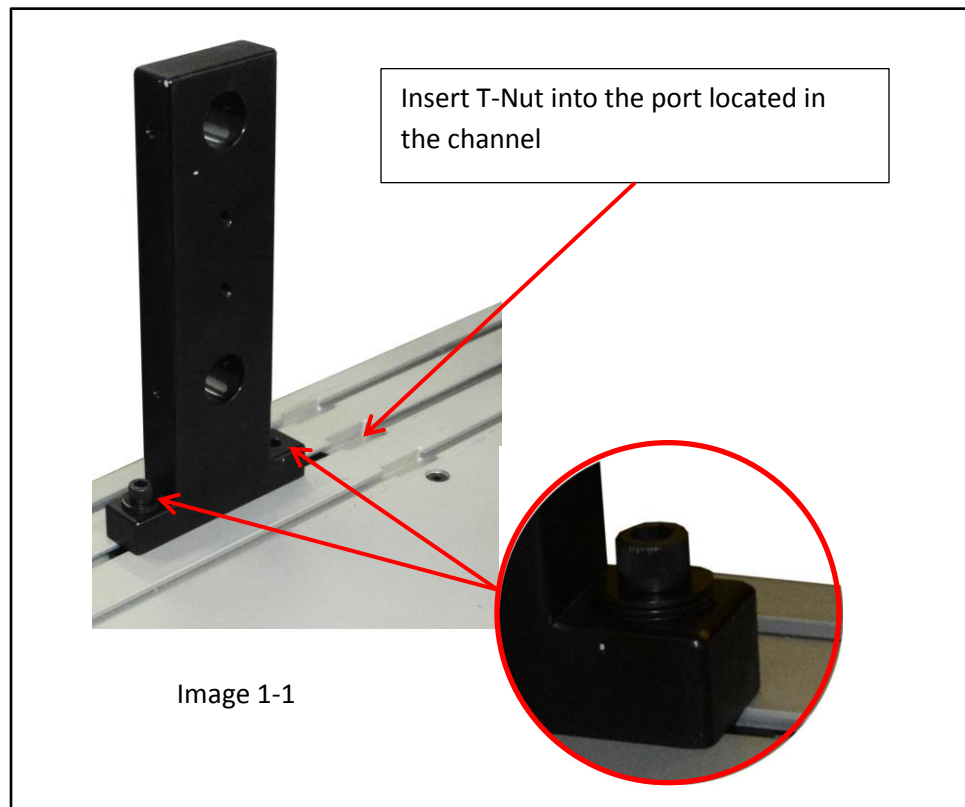

Step 2

Before the pillars have been tightened in their permanent position, install the shafts in the pillars by performing the following:

- A. Align one of two shafts with the bottom hole in one of the two pillars. (Note: it does not matter which of the two pillars you begin with)
- B. Slide the shaft through the hole starting from the back of the pillar
- C. Once the bottom shaft is approximately half way through the pillar, place the white nylon stop ring on the shaft. (Note: The white nylon stop ring has a set screw in it, make no attempt to tighten this set screw at this time)
- D. Align the second of two shafts with the top hole of the same pillar and slide it approximately half way through the hole.

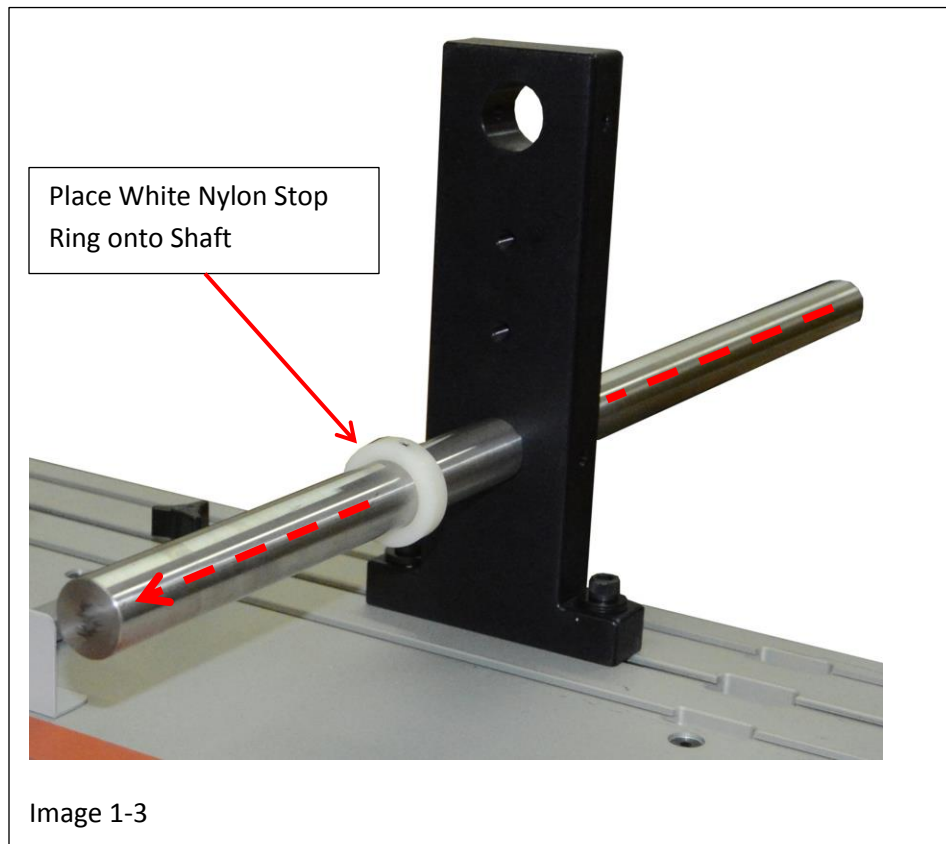

Step 3

Once both shafts have been set approximately half way into one of the pillars, install the Print Head Mount Module in the following manner:

- A. Make sure the all top guide wheels backed out enough to allow for the top shaft to pass through unobstructed in the top shaft channel, see image 1-4.
- B. Make sure the lower shaft channel is free of all other packing material and debris, see image 1-4
- C. Support the bottom of the module while sliding the bottom shaft through the Mount Module, see image 1-5
- D. Once the Mount Module is on the bottom shaft slide the top shaft through the module.
- E. Slide the second of two White Nylon Stop Rings onto the lower shaft, see image 1-5
(Note: Do not tighten the set screw at this time)

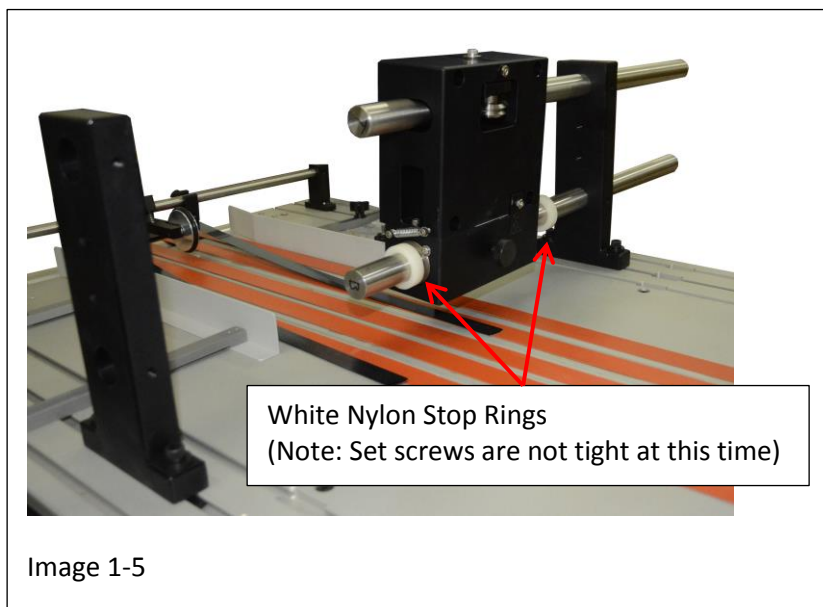
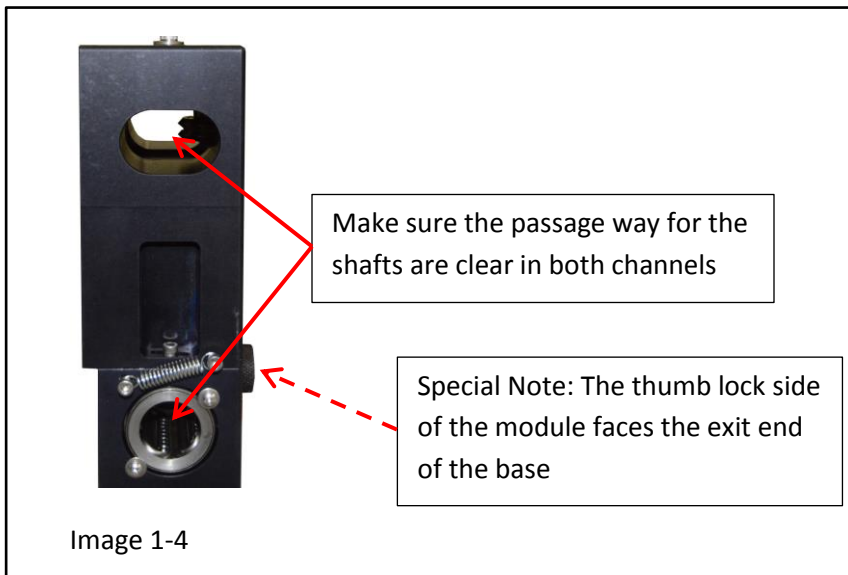

- F. Align the opposing pillar with the shafts coming through the Mount Module and slide both shafts through the pillar.
- G. Position the shafts in the Pillars so that both shafts are flush to the Pillar on the “Operator’s” side of the base leaving any excess length to protrude from the back Pillar.
- H. Lock the shafts into place using the supplied set screws. (Note: Place the set screws in the opposite side that the ink bottle upright will mount to)

Step 4

Install the Print Head Mount Plate to the Mount Module in the following manner:

- A. Position the Print Head Mount Plate on the side of the Mount Module facing the input end of the base, see image 1-6
- B. Insert the four (4) supplied hex head Allen screws (one at a time) into the through holes in the back of the Mount Module and start threading the screws into the Print Head Mount Plate, see image 1-7
- C. Once all the screws have been started tighten each one using firm to moderate force. (⚠ Caution: Do not over tighten these screws. Over tightening the screws may result in damage to the mount plate)

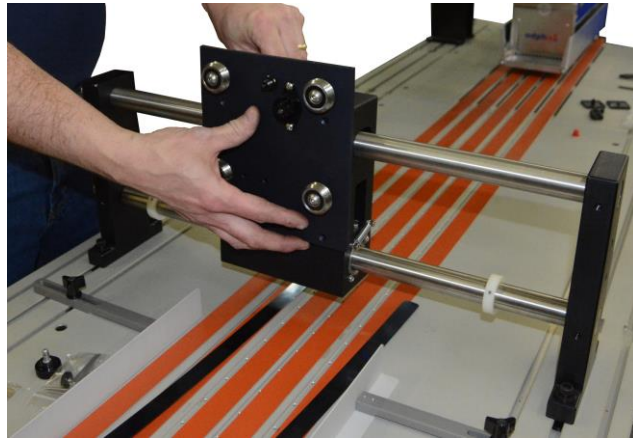

Image 1-6

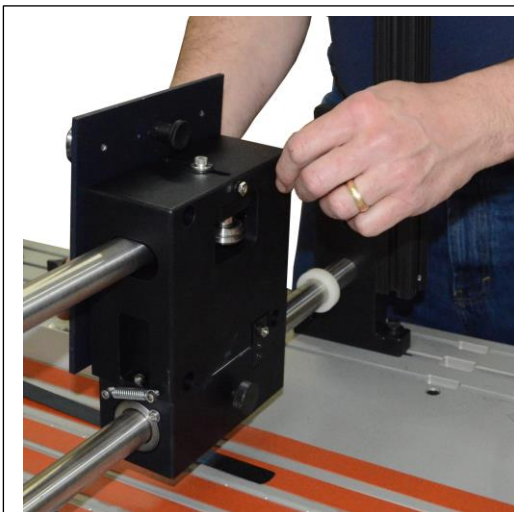
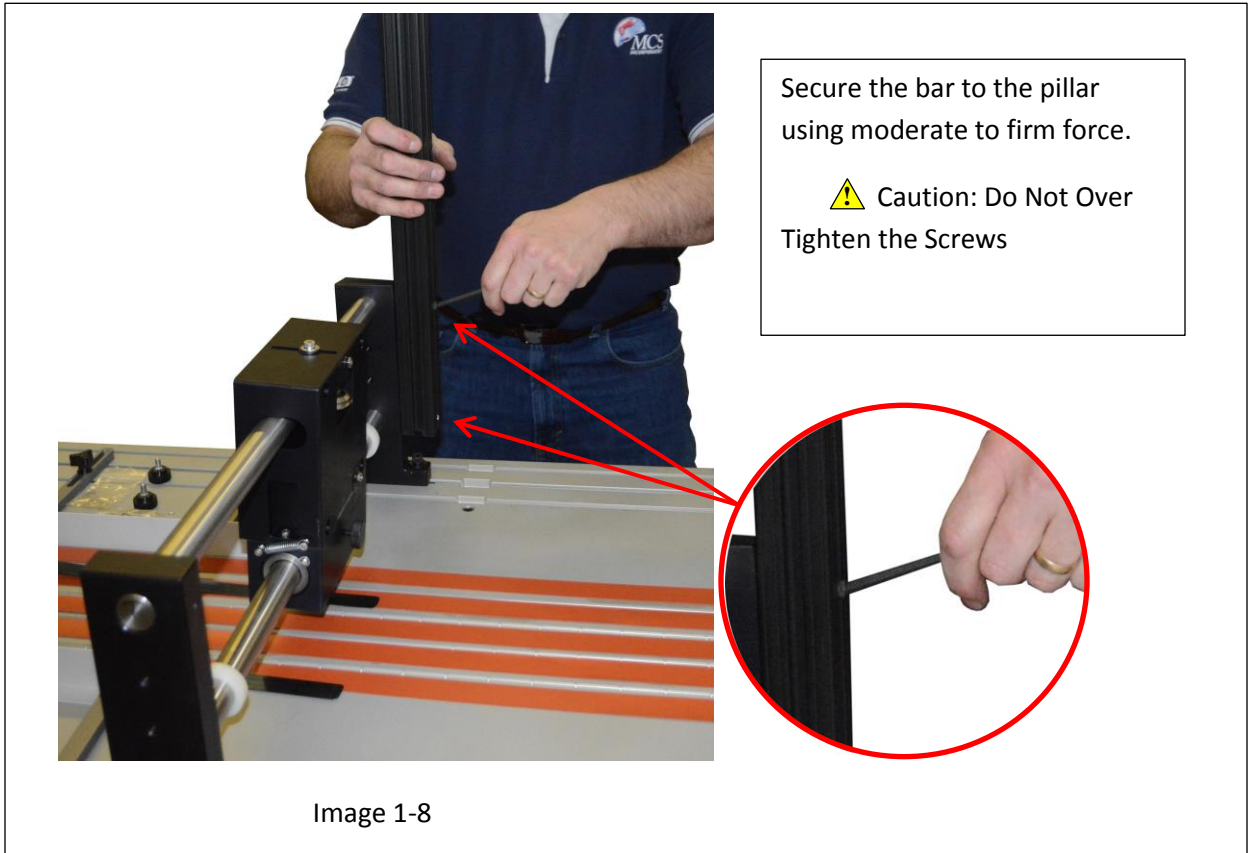

Image 1-7

Step 5

Install the Ink Bottle Mount Bar by performing the following:

- A. Place bar next to the back Mount Pillar to the opposite side from the shaft set screws installed in Step 3-H
- B. Align the through holes in the bar with the mount holes in the side of the back pillar, see image 1-8
- C. Using the supplied hex head Allen screws secure the bar to the pillar using moderate to firm force.
(⚠ Caution: Do not over tighten these screws. Over tightening the screws may result in damage to the mount pillar)



A large, light blue watermark of an eagle is centered on the page. The eagle is shown in profile, facing left, with its wings spread. The word "eagle" is written in a light blue, sans-serif font across the eagle's body.

Section Two

Print Head Installation

Section Two Print Head Installation

Step 1

Install the Print Head to the plate in the following manner:

- A. Using your right hand hold the Print head firmly at the top of the unit and support the bottom of the print head with your left hand, see image 2-1 and 2-2. (Note: Make sure the height adjustment strip aligns properly with the height adjustment gear)
- B. Gently align the Head Rails, located on the back surface of the print head with the track wheels on the mount plate, see image 2-2
- C. Slowly lower the Print Head onto the mount plate, once the top wheels have captured the rails, use your right hand to pull the position lock knob back, see image 2-3

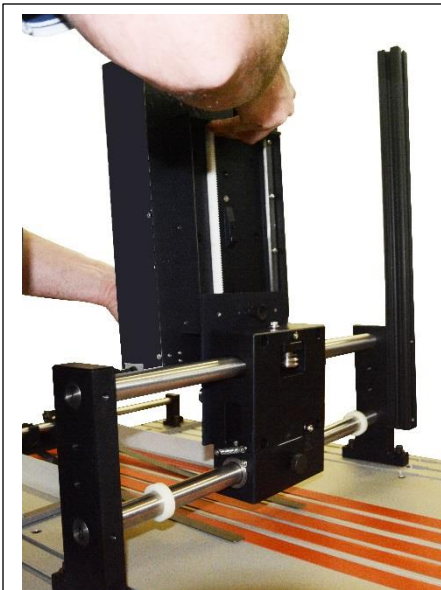

Image 2-1

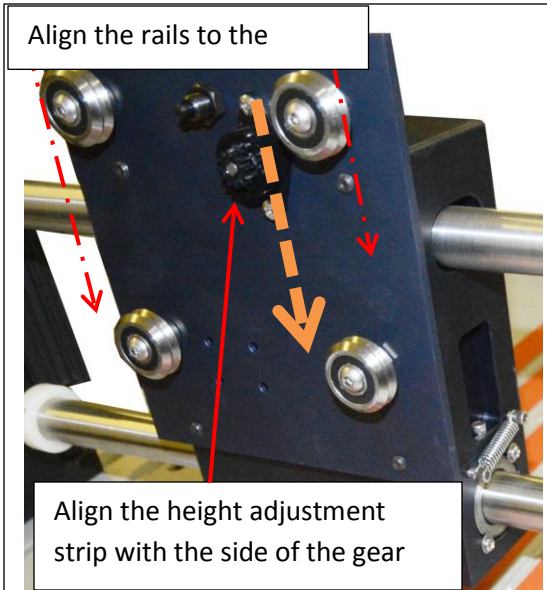

Image 2-2

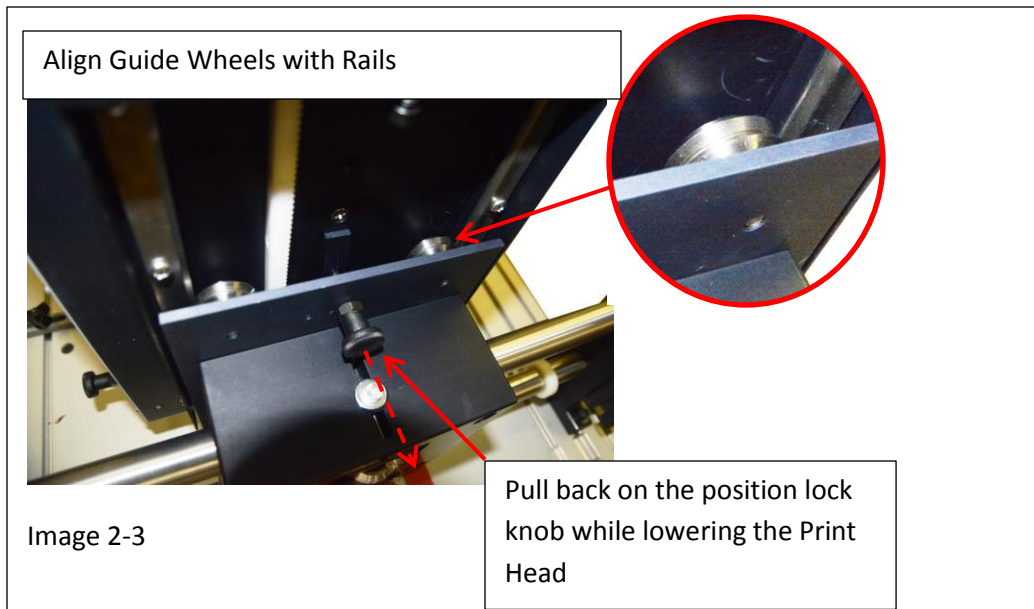
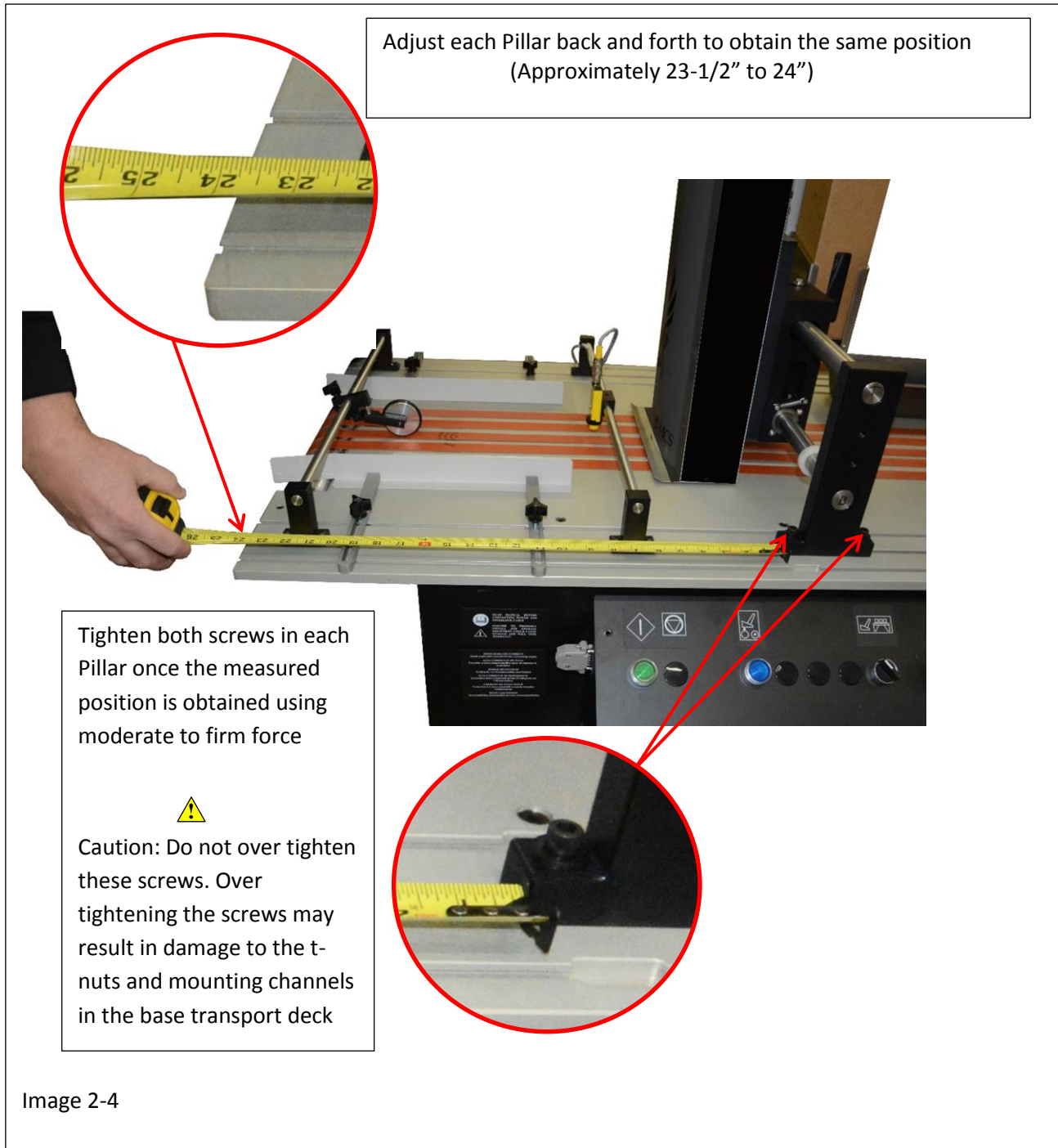

Image 2-3

Step 2

Set the position of the Print Head Mount Module Assembly to the base by performing the following:

- A. Using a tape measure place both Pillars at approximately 23-1/2" to 24" from the input side of the base,
see image 2-4
- B. Lock the pillars into position by tightening the hex head screws inserted into the pillars in step 1-B and 1-D using moderate to firm force. (⚠ Caution: Do not over tighten these screws. Over tightening the screws may result in damage to the t-nuts and mounting channels in the base transport deck)





Section Three

Ink Supply Controller Installation

Section Three

Ink Supply Controller Installation

Step 1

Install the Ink Supply Controller by performing the following:

Prepare the Ink Supply Controller for installation::

- A. Insert the supplied screws into the mount brackets located on the back on the Ink Supply Controller.
- B. Turn 3 to 4 of the screw thread the into the T-Nuts , see image 3-1. (Note: Leave the screws loose)

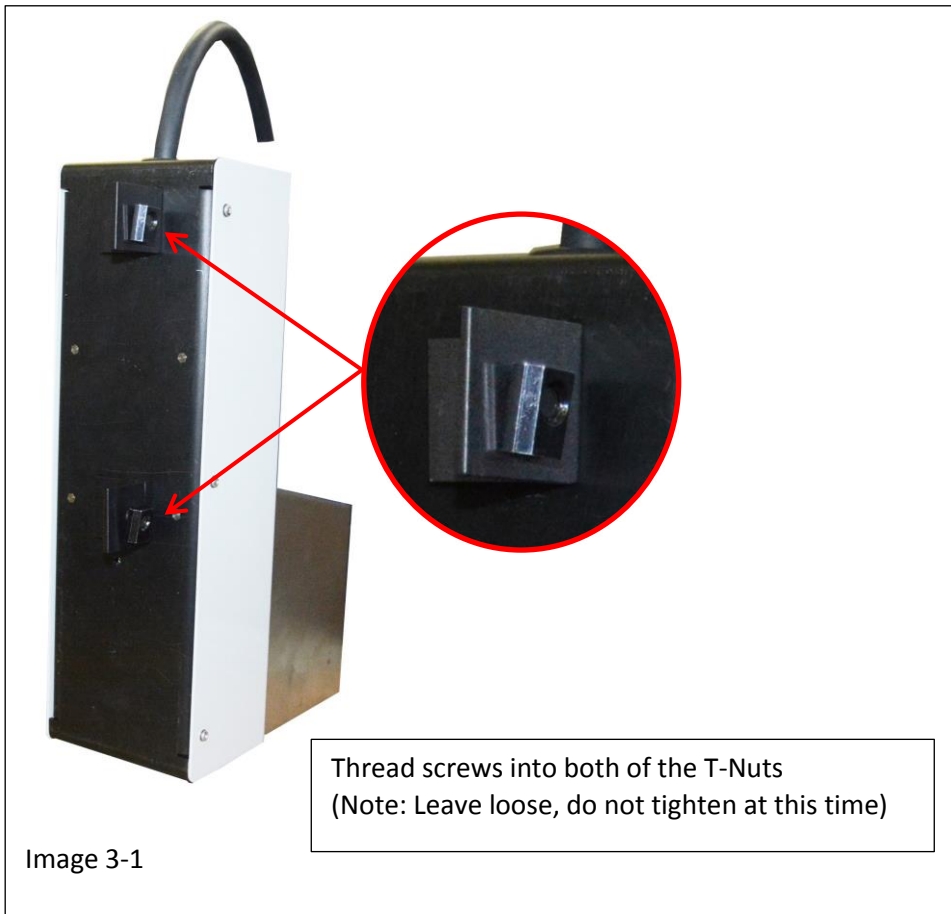

Step 2

Installing the Ink Supply Controller:

- A. Working from the back of the base, guide the T-Nuts into the Ink Supply Mount Bar channel from the top and lower to a comfortable level for operator access, see image 3-2
(⚠ Caution: Do not let the Ink Supply Controller drop or strike the transport deck. This could result in damage to the Controller)
- B. Tighten both screws using moderate to firm force to secure the Ink Supply Controller to the Mount Bar.
(⚠ Caution: Do not over tighten these screws. Over tightening the screws may result in damage to the t-nuts and mounting channels in the mount bar)

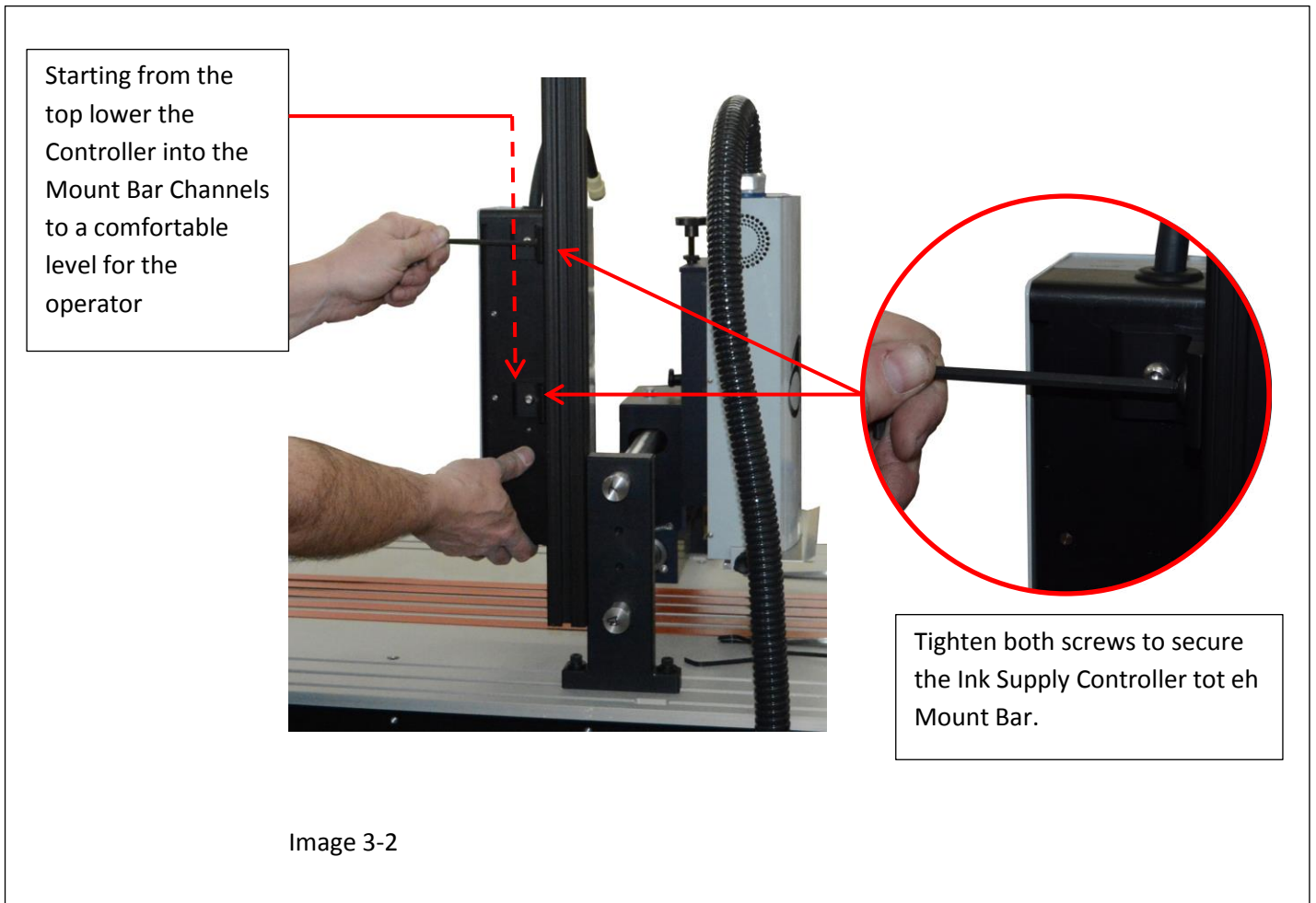

Step 3

- A. Place the Ink Bottle into the Supply Controller with the box window visible through the front of the holder as shown in image 3-3 (Note: there is an RFI tag imbedded in the bottom of the box. Make sure the box sits flat in the holder)
- B. Remove the cap from the bottle and snap the ink line to the bottle spout, see image 3-4.

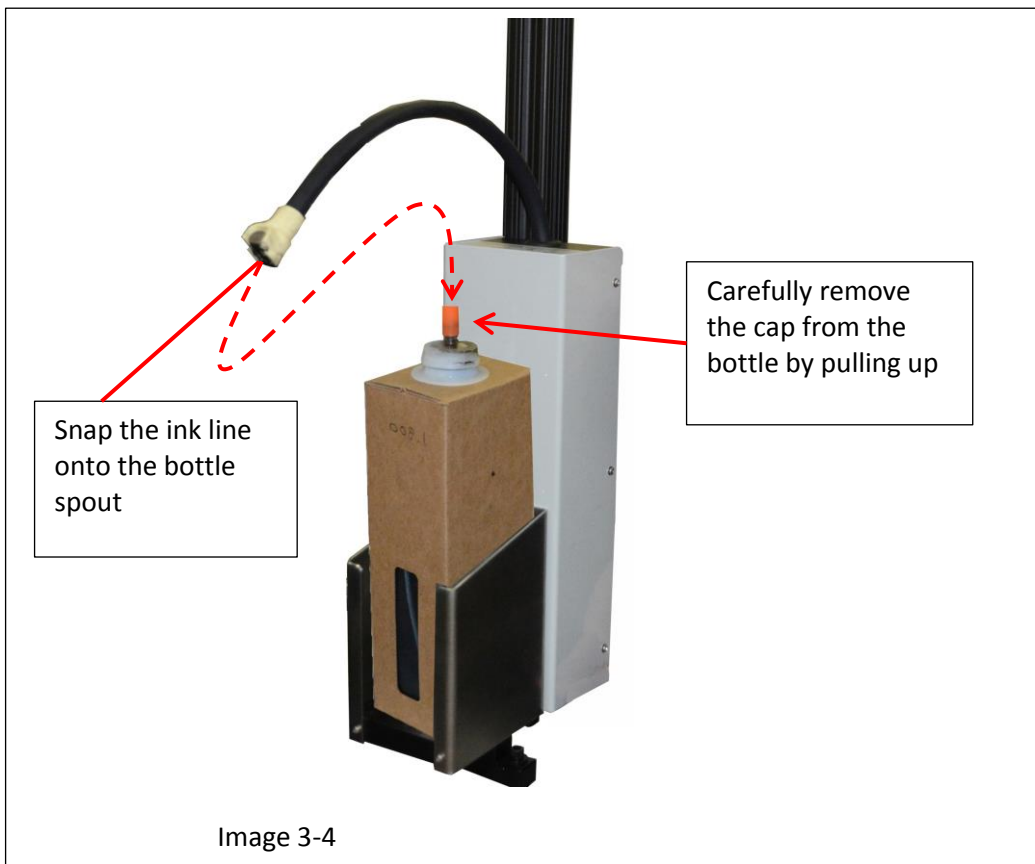
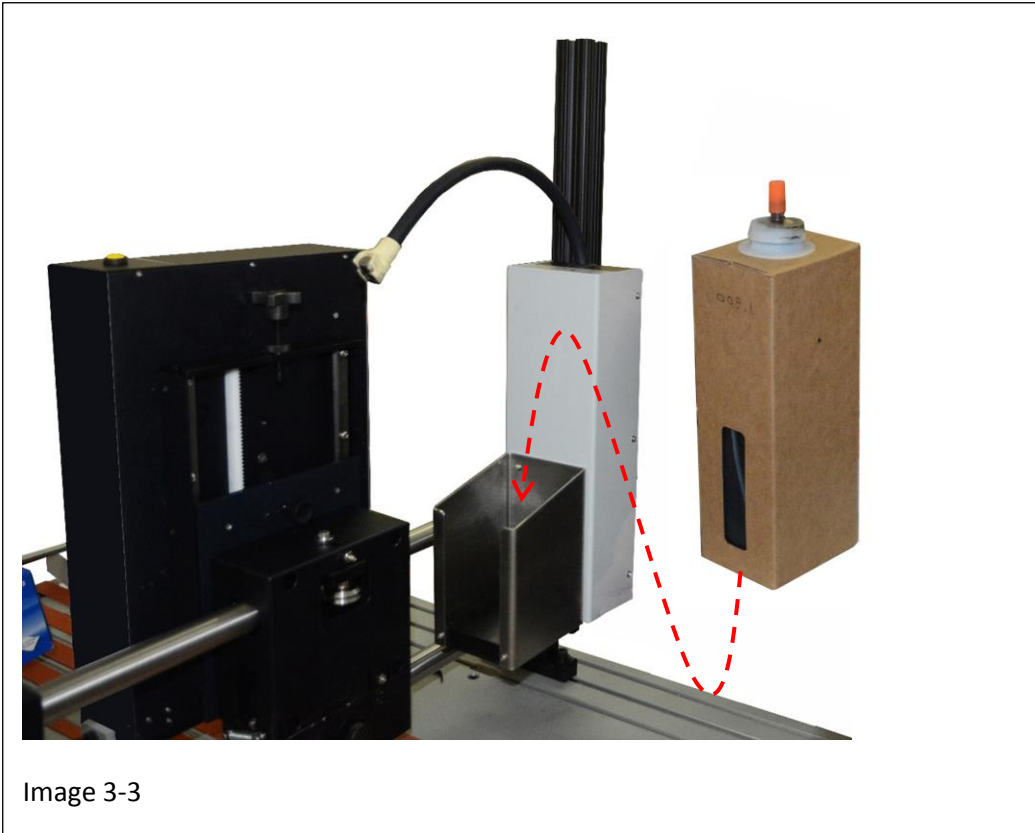



Section Four

Raptor & Print Control Box Installation

Section Four

Pump Control Box Installation

Step 1

Install the Raptor and Print Control Boxes inside the Ink Jet Base in the following manner:

- A. Place the Raptor and Print Control Boxes in the base away from the blower motor, see image 4-4
- B. When you are ready to power up the system and go on line, connect the 115 VAC power supply cables that came with the unit to the receptacle located at the lower left corner of the each Control Box.

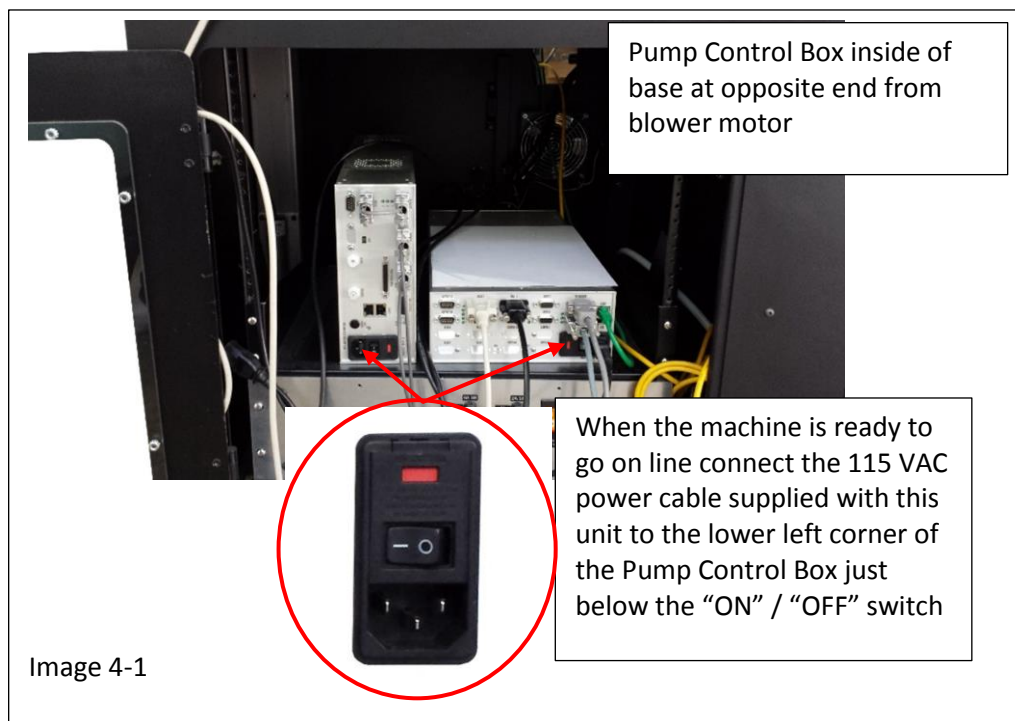

- C. Plug cables vacuum lines into the Print Control Box as indicated in image 4-2.
- D. Plug cables vacuum lines into the Eagle Print Head as indicated in image 4-3.
- E. Plug cables into the Raptor Control Box as indicated in image 4-4.

Eagle Print Control Box Connections

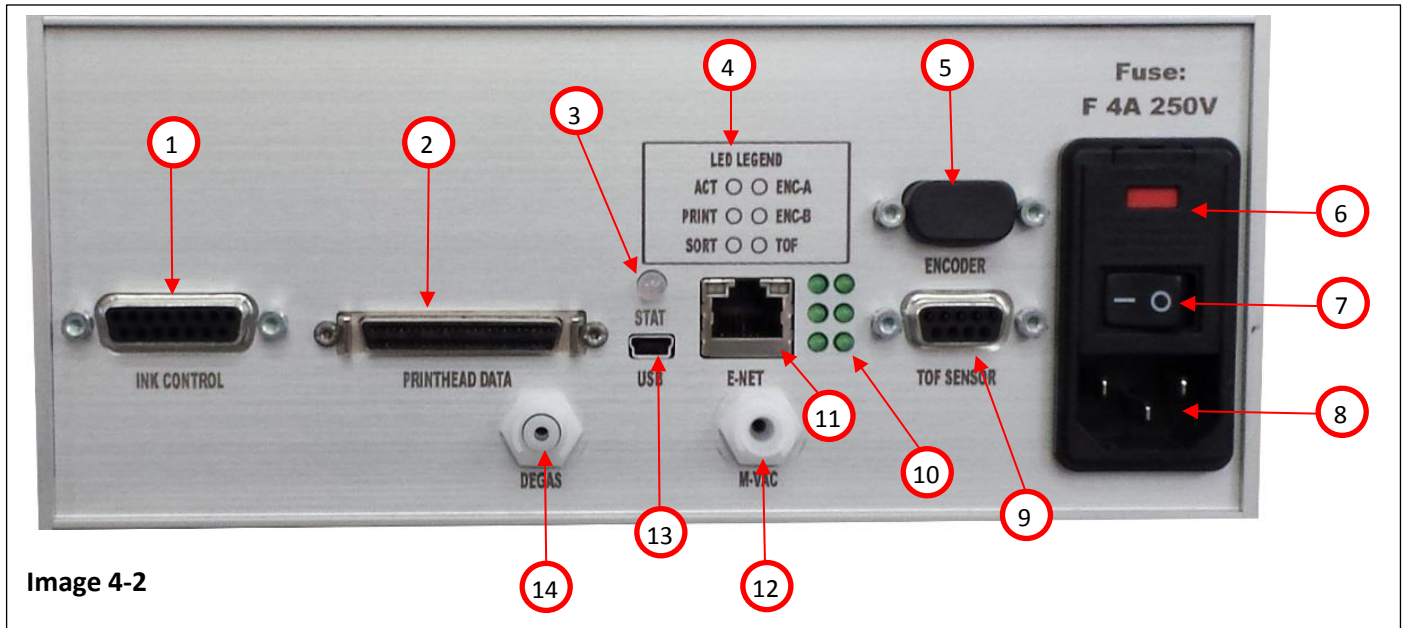
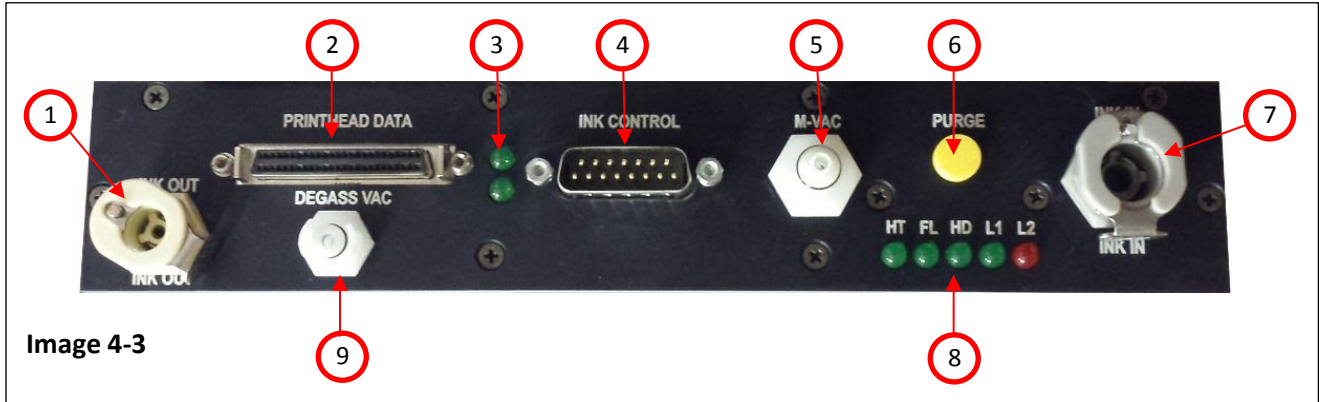

Image 4-2

Item #	Description
1	db 15 pin connection / Ink Control
2	Data Link connection / print head Data
3	Ethernet Status LED indicates Ethernet cable status. Fast Flashing Blue indicates No Cable Connected, Flashing Green indicates Cable Connected but NO PC Connected, Slow Pulse Green indicates Normal Operating (One Pulse per configured head)
4	LED Legend for Status lights (See item 10)
5	db 9 pin connection / Encoder (Typically not used on this control box)
6	Fuse holder for 4 AMP / 250V fuse
7	On / Off Switch
8	Power Receptacle / 115 VAC
9	db 9 pin connection / TOF (Top Of Form) Sensor
10	LED lights / Indicates Status
11	Ethernet Cable connection
12	Meniscus Vacuum Line connection
13	USB mini connection (Not used in this application)
14	Degas Vacuum Line connection

Eagle Print Head Connections



Item #	Description
1	Purge Ink Fitting connection to Purge Bottle
2	Data Link connection / Print head Data
3	LED Lights / Power indicator for Pin Heat and Pin Power
4	db 15 pin connection / Ink Control to Print Control Box
5	Meniscus Vacuum Line connection
6	Yellow Purge Button
7	Ink In Fitting to Ink Supply
8	Green LED lights / HT = Pin Heat On, FL = Fill Valve Open, HD = Head Valve Open for Purge, L1 = Head count for Active heads, Red LED light L2 = "Error" Ink Backed Up into Meniscus Line
9	Degas Vacuum Line connection

Raptor Control Box Connections

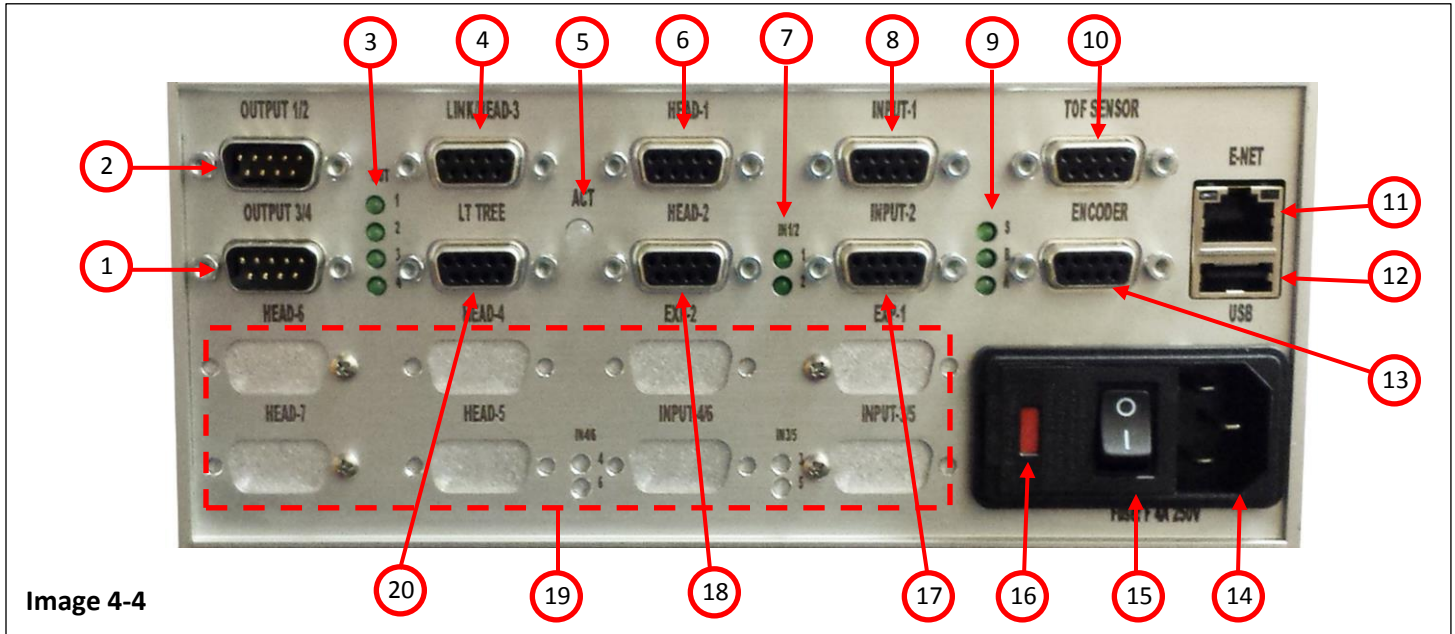

Image 4-4

Item	Description	Item	Description
1	db 9 pin male connector / Output Print Head 3 & 4	11	Ethernet Connection to Switch
2	db 9 pin male connector / Output Print Head 1 & 2	12	USB Port (Unused)
3	Led Indicator for Print Head Output 1-4	13	db 9 pin female connector to Encoder
4	db 9 pin female connector for Link / Head 3	14	Power Receptacle / 115 VAC
5	ACT LED indicates Ethernet cable status. Fast Flashing Blue indicates No Cable Connected, Flashing Green indicates Cable Connected but NO PC Connected, Slow Pulse Green indicates Normal Operating	15	On / Off Switch
6	db 9 pin female connector / Print Head 1	16	Fuse holder for 4 AMP / 250V fuse
7	Led Indicator for Input 1-2	17	db 9 pin female connector / Input 2
8	db 9 pin female connector / Input 1	18	db 9 pin female connector / Print Head 2
9	LED indicator for Encoder bands A, B, TOF Sensor	19	Open Ports to accommodate an Expansion Board. Expansion Board can support 4 more print heads and Inputs
10	db 9 pin female connector / TOF (Top Of Form) Sensor	20	db 9 pin female connector / Light Tree

Special Note: One of the Print Head db 9 connectors will be used for power to the ink supply



Section Five

**Print Head Height Setting
& Alignment Installation**

Section Five

Print Head Height Setting & Alignment

Before setting the height of the Eagle Print Head and adjusting the alignment, review the adjustment locations and their function by reviewing image 5-1

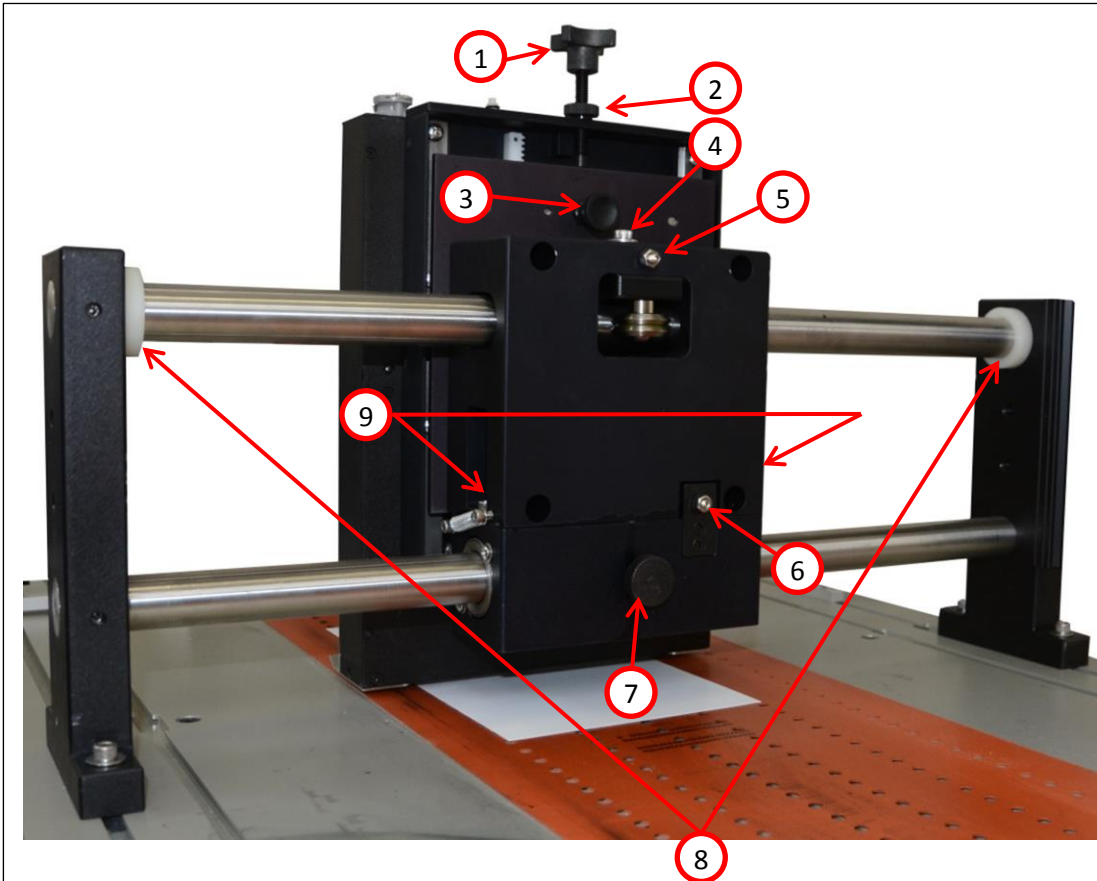

Legend

1. Print Head Height Adjustment Knob
2. Height Adjustment Lock Ring
3. Up / Down Position Slide Lock
4. Forward Tilt Retaining Screw
5. Forward Tilt Adjustment Screw w/ nut
6. Skew Adjustment Screw
7. Side / Side Position Lock Knob
8. Two, Slide Stop Ring
9. Skew Lock Screw (One at each side)

Image 5-1

Step 1

Adjust the height of the Eagle Print Head in the following manner:

- A. Place a sample of material you wish to print on under the Eagle Print Head.
- B. Pull and hold the Up / Down Position Slide Lock and lower the Print Head to the Down Position. Release the Lock once the head is down.
- C. Turn the Height Adjustment Lock Ring counter clockwise to loosen.
- D. Turn the Adjustment to raise or lower the print head until the skid plate of the head is theoretically 1 millimeter or 0.040 inches from the surface of the sample, see image 5-2. (Note: Just high enough for the paper to pass under the Print Head Ski without causing the paper to drag on the transport belts)
- E. Turn the Height Adjustment Lock Ring clockwise to tighten.

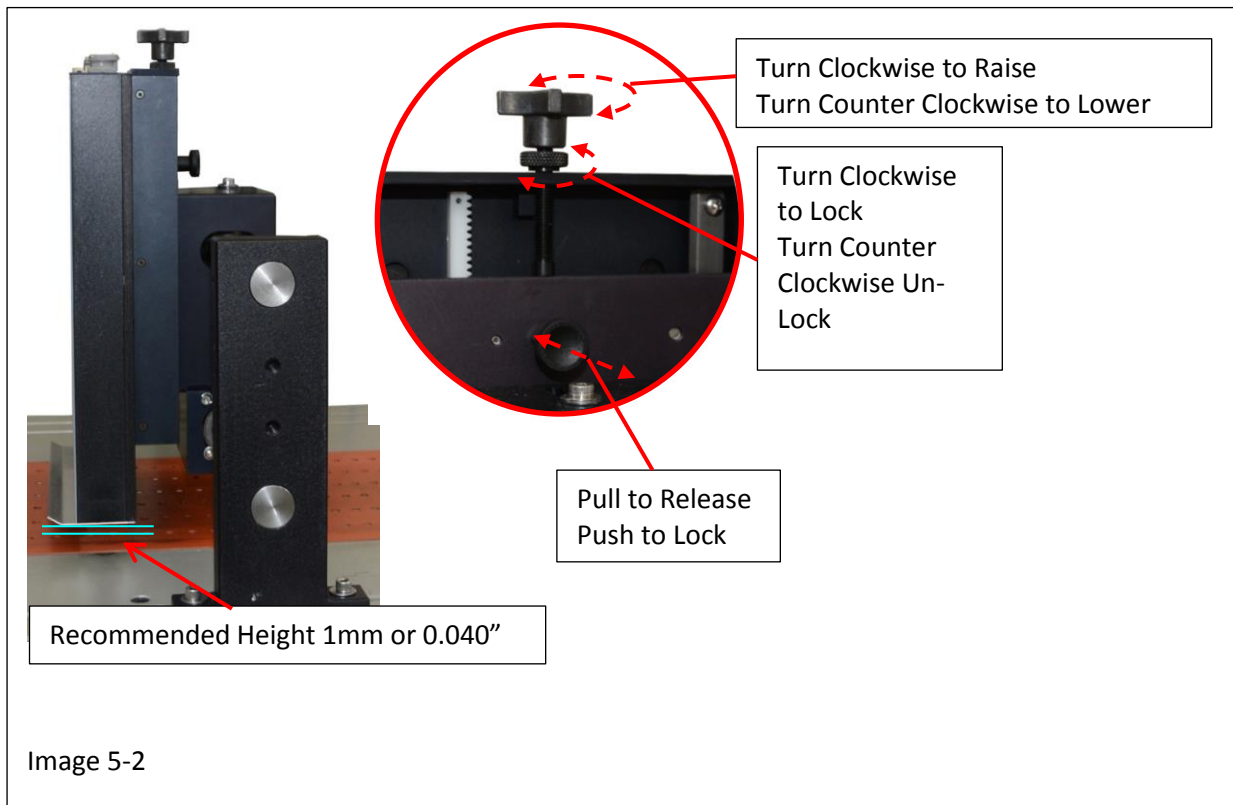

Step 2

It is important that the Eagle Print Head stay level to the deck. This can be accomplished by adjusting the forward / backward tilt of the Eagle Print Head in the following manner:

- A. Using an Allen wrench, loosen the lock screw located on the top of the Mount Module, see image 5-3
- B. Using an Allen wrench, adjust the forward or back tilt of the Eagle Print Head by turning the adjustment screw clock wise to tilt backwards, counter clockwise to tilt forward. (Note: it may be necessary to loosen and tighten the hex head nut associated with this screw)
- C. Tighten the lock screw by turning it clockwise with an Allen wrench.

(Special Note: If the ink jet base is level, then a level can be used to make this adjustment. If for some reason the base can't be leveled then make the Print Head level to the base by measuring front to back along the ski plate to level the head with the deck.)

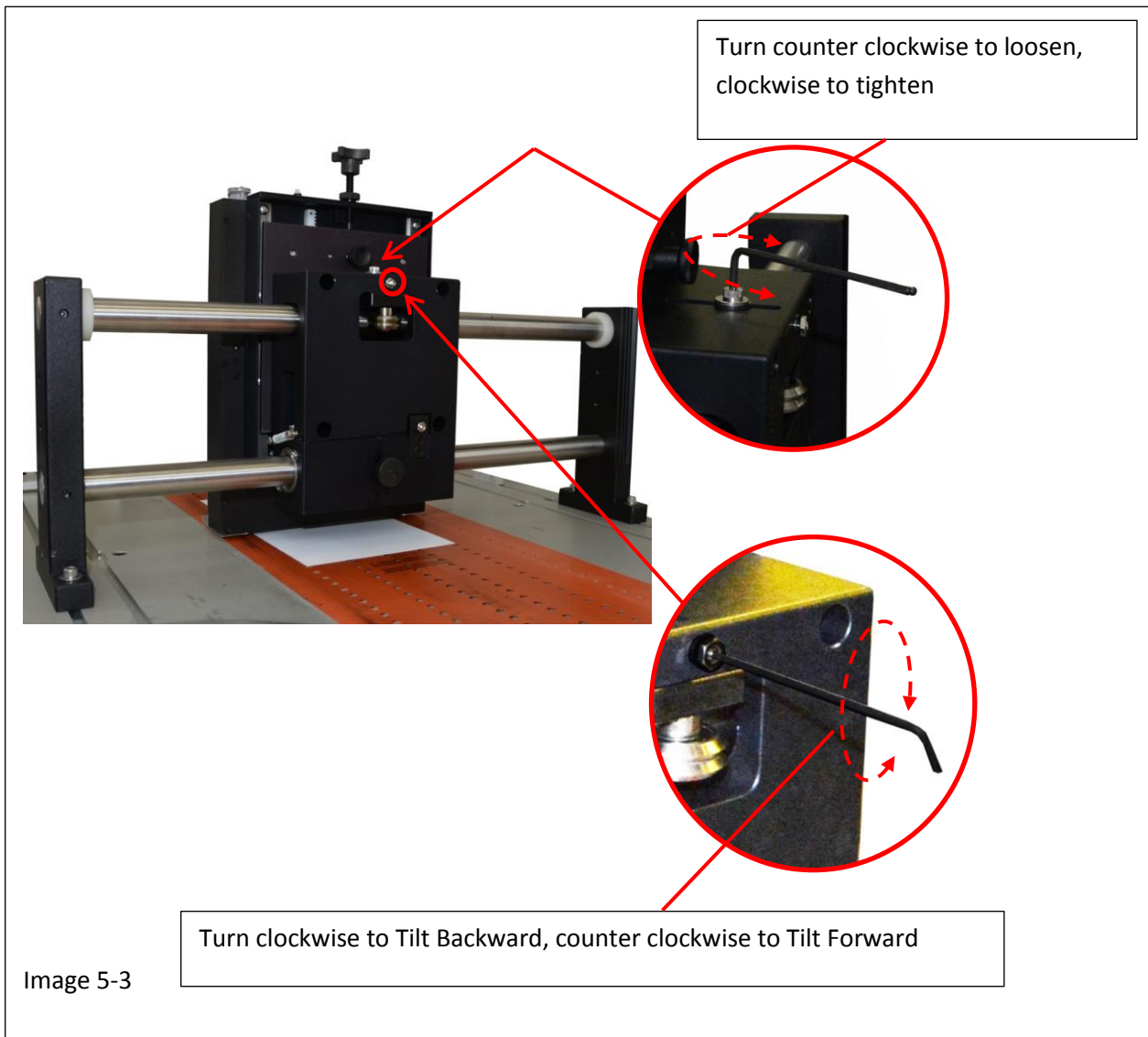

Step 3

Set the Slide Travel Stop Rings to limit the travel distance on the Eagle Print Head by performing the following:

- A. Manually position the Eagle Print Head in the center of the base, see image 5-4
- B. Measure out 5 to 6 inches from the "Back" side of the Print Head and lock the Stop Ring in place by tightening the set screw in the Stop Ring. (⚠ Caution: Do not over tighten these screws. Over tightening the screws may result in damage to the Stop Ring)
- C. Measure out 5 to 6 inches from the "Front" side of the Print Head and lock the Stop Ring in place by tightening the set screw in the Stop Ring. (⚠ Caution: Do not over tighten these screws. Over tightening the screws may result in damage to the Stop Ring)

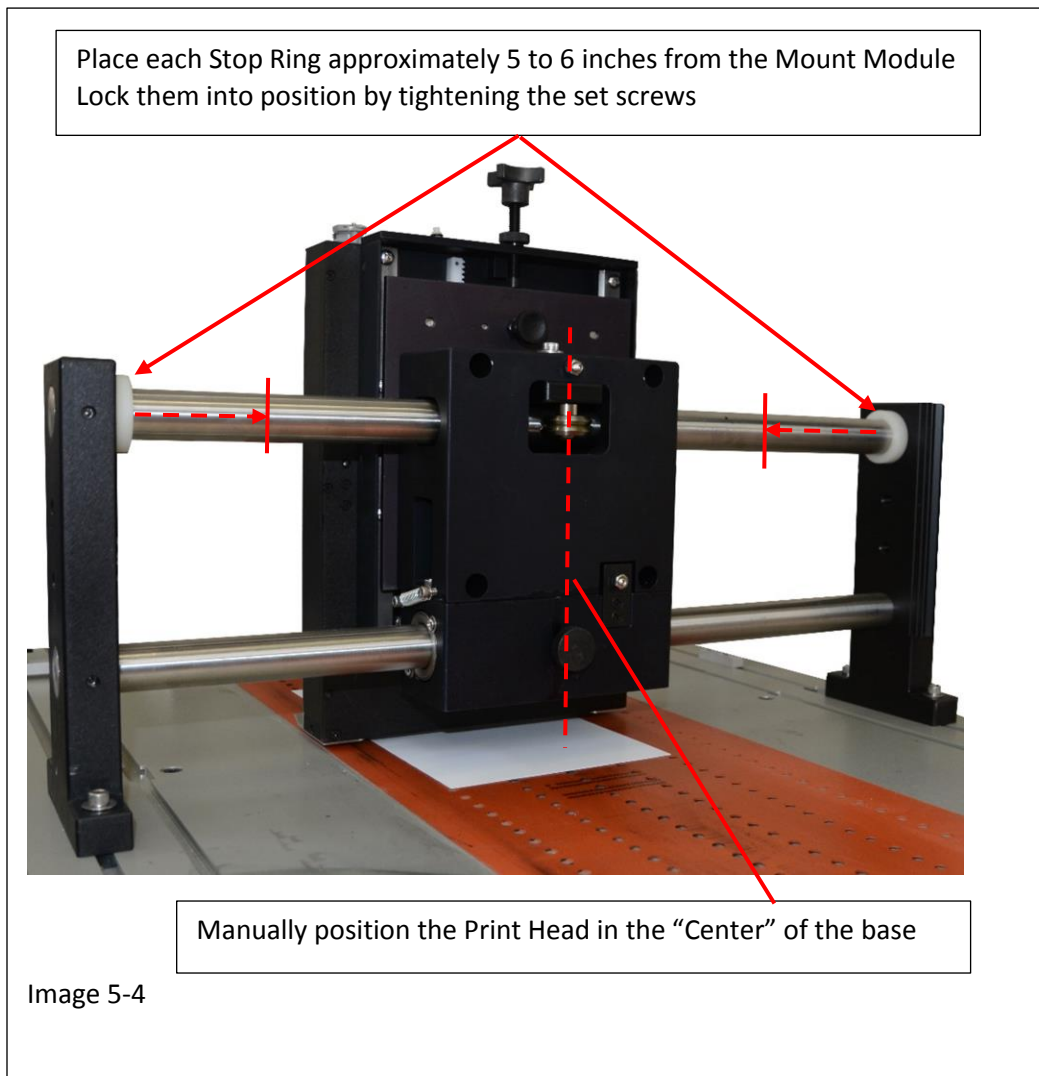

Step 4

Compensating for Print Image appearing skewed on the paper can be accomplished by performing the following:

- A. Loosen the Lock Screw at each side of the Mount Module
- B. Turn the Adjustment Screw clockwise to “Draw” the back side of the Print Head towards the Mount Shafts while pushing the front side away from the shafts. Turning the adjustment screw counter clockwise will have the opposite effect, see image 5-5.

(Special Note: Before making this adjustment make sure the skew problem is not feeder alignment with eth base or worn belts tracking erratically on the base)

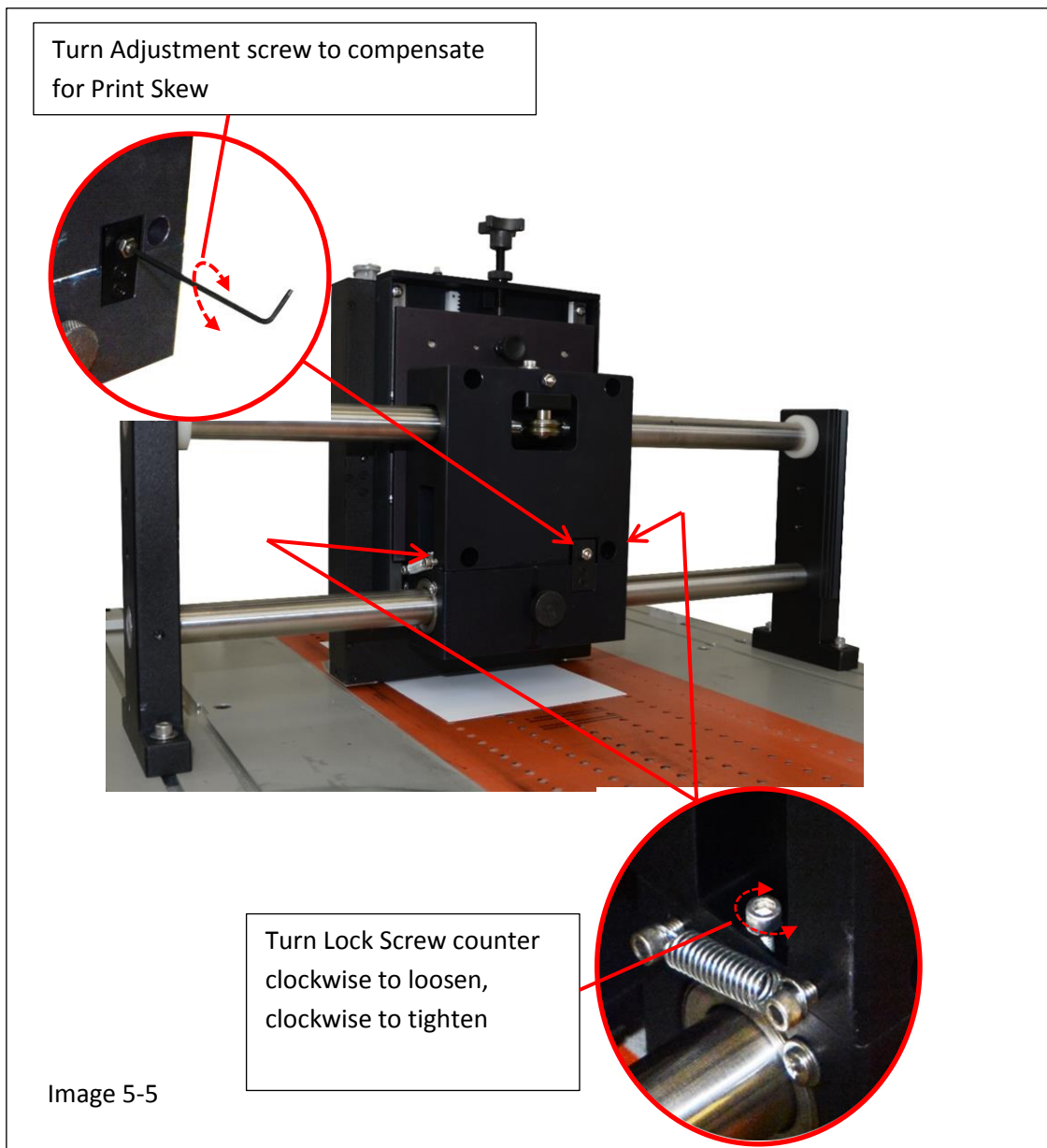

A large, light blue watermark of an eagle's head and neck is positioned behind the text. The eagle is facing left, with its beak slightly open. The word "Eagle" is written in a large, light blue, serif font, partially overlapping the eagle's neck and the text below.

Section Six
Sensor Installation

Section 6

Sensor Installation

Step 1

Install the sensor pillars to the base in the following manner:

- A. Slide one of two T-Nuts into the middle front channel, move it towards the input end of the base well ahead of the Print Head, see image 6-1.
- B. Insert one of two supplied hex head Allen screws into the through hole in the base of the pillar and start the threading it into the t-nut. (Note: Do not tighten at this time)
- C. Slide the pillar towards the input end of the base to allow for the second of two t-nuts to be placed into the channel.
- D. Align the back through hole in the pillar with the t-nut and begin threading the second of two hex head Allen screws into the t-nut. (Note: Do not tighten at this time) refer to image 6-1
- E. To install the back Pillar, perform steps “A” through “D” at the back middle channel position, see image 6-1

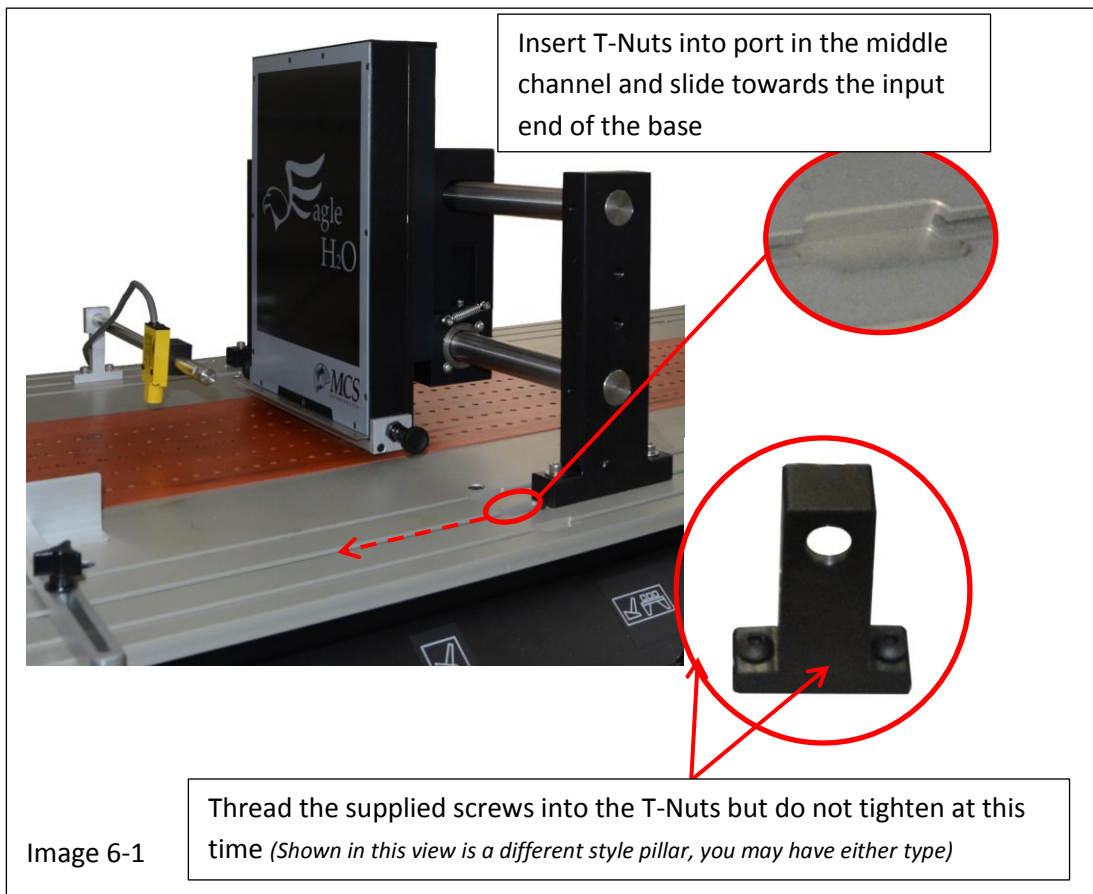

Step 2

Install the Sensor Shaft by:

- A. Slide the shaft through the back pillar until the shaft is approximately half way through the pillar, see image 6-2
- B. Affix Sensor to Mount Block and slide Sensor and Mount Block onto shaft, see image 6-2
- C. Align the front pillar with the shaft and slide shaft through the front pillar until the shaft end is flush with the front face of the pillar.
- D. Tighten set screws in top of pillar to secure sensor shaft.

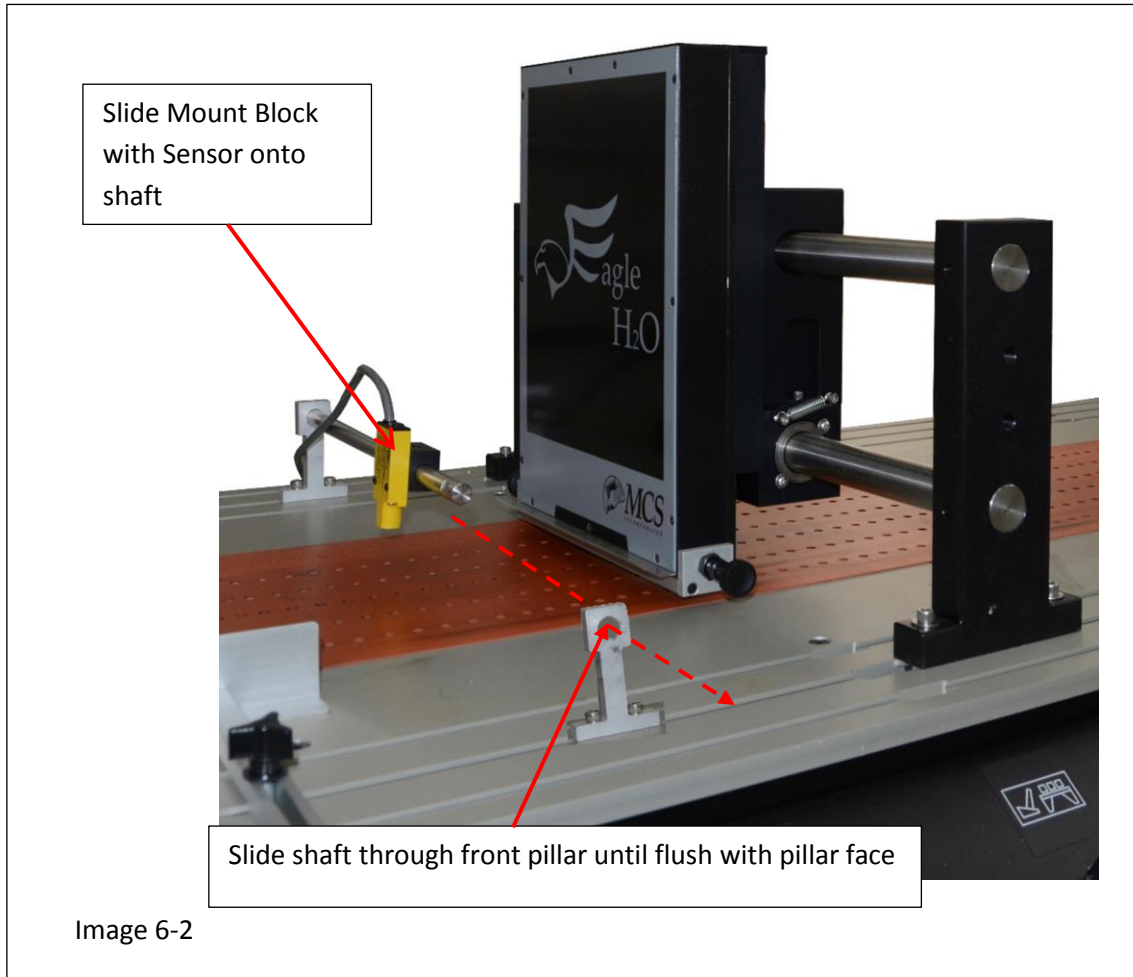

- E. Set the sensor position approximately 4 to 5 inches in front of the Print Head, see image 6-3
- F. Tighten the Pillar screws using moderate to firm force.
(⚠ Caution: Do not over tighten these screws. Over tightening the screws may result in damage to the t-nuts and mounting channels in the base transport deck)

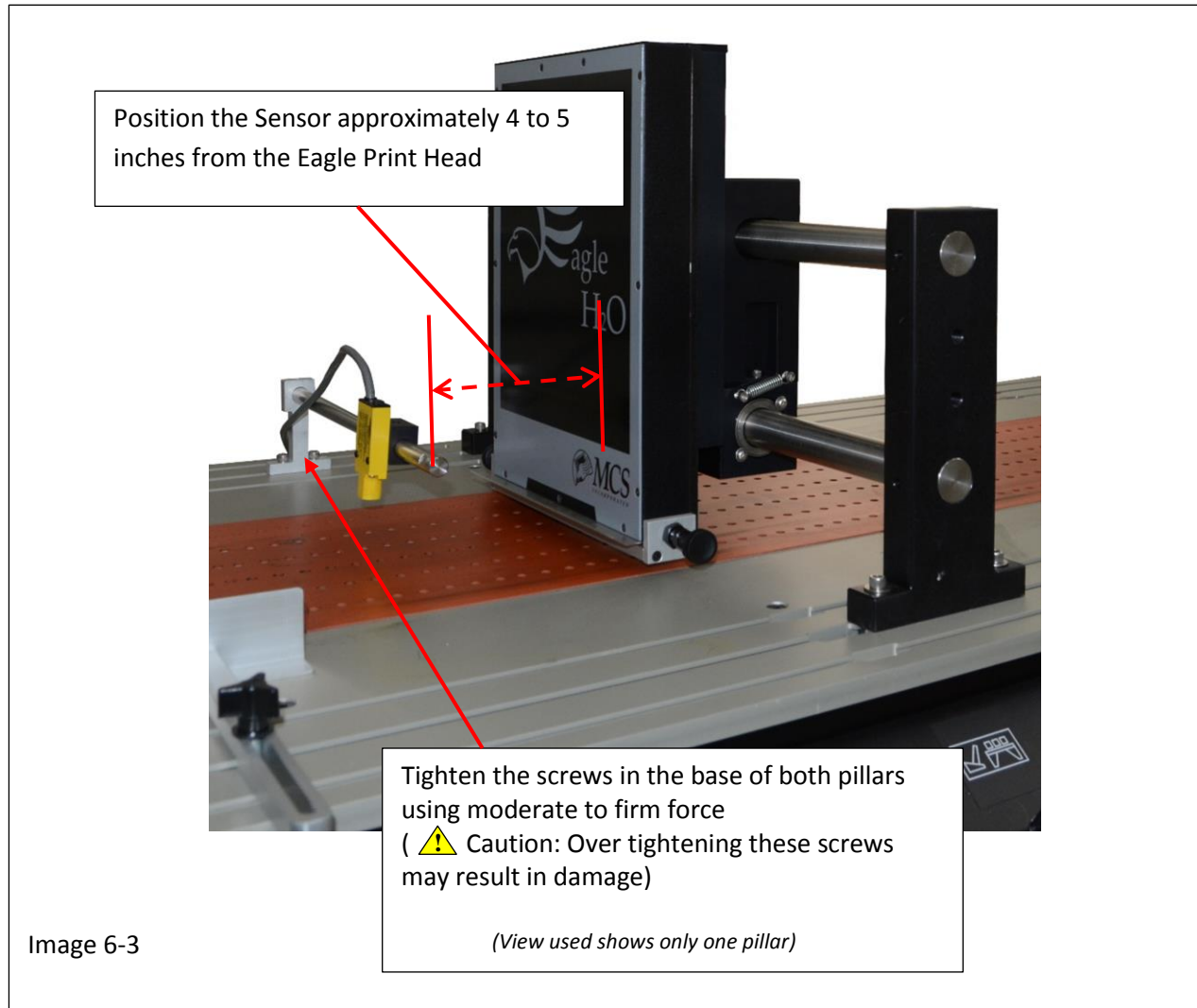



Section Seven
agle
Installing the Light Tree

Section Seven

Installing the Light Tree

A three color Light Tree comes with the Eagle Print System. The Light Tree can be set to display different color lights indicating the status of the machine while in operation. The actual color can be selected and saved as the system default.

Installing the Light Tree can be accomplished by performing the following:

Step 1

- A. Carefully cut the tie wrap holding the cable to the light post.
- B. Loosen the two button head Allen screws at the base of the Light Tree, see image 7-1. (Note: Do not remove the screws)
- C. Carefully slide the T-Nut, loosened in Step 1-B, into one of the open slots of the extruded aluminum frame adjacent to the Ink Supply Controller and tighten the button head screws.
(⚠ Caution: Do not over tighten the screws. Over tightening the screws may result in damage to the extruded aluminum frame.)
- D. Once the Light Tree is secure, route the cable along the frame and connect the plug to the receptacle marked "Light Tree" on the Raptor Control Box. (See Section 4, Item 20 of Image 4-4)

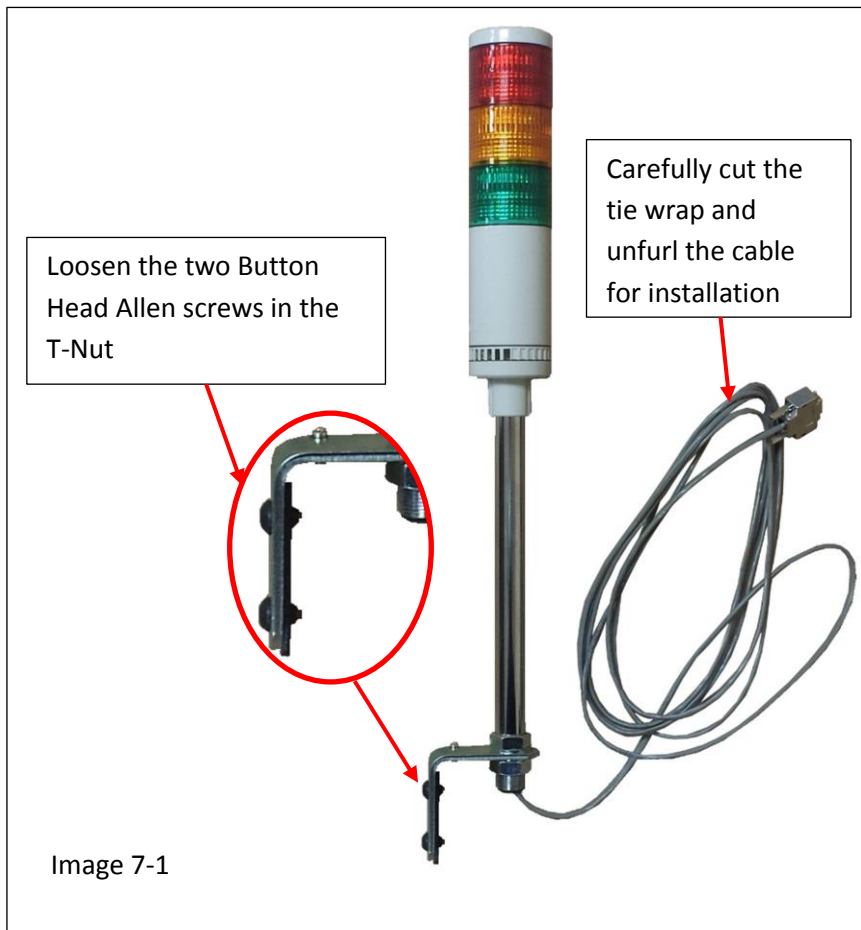

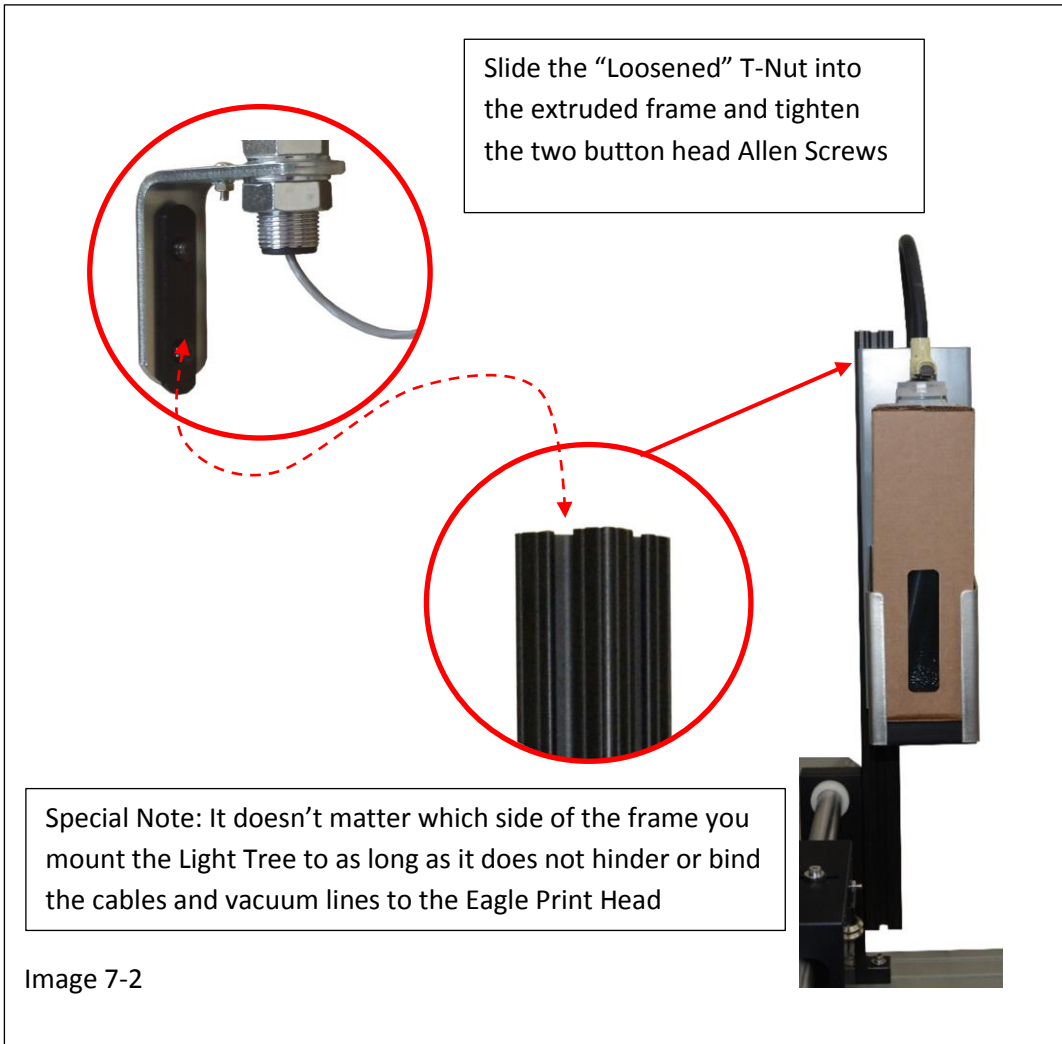

Setting Up the Light Tree

Setting the operating parameters for the Light Tree can be accomplished in the following manner:

Step 1

Once the system is on line, access the Light Tree Setup Menu by:

- A. In the Main screen go to File > System Setup
- B. In the System Setup menu press the "Light Tree Setup" button, see image 7-1

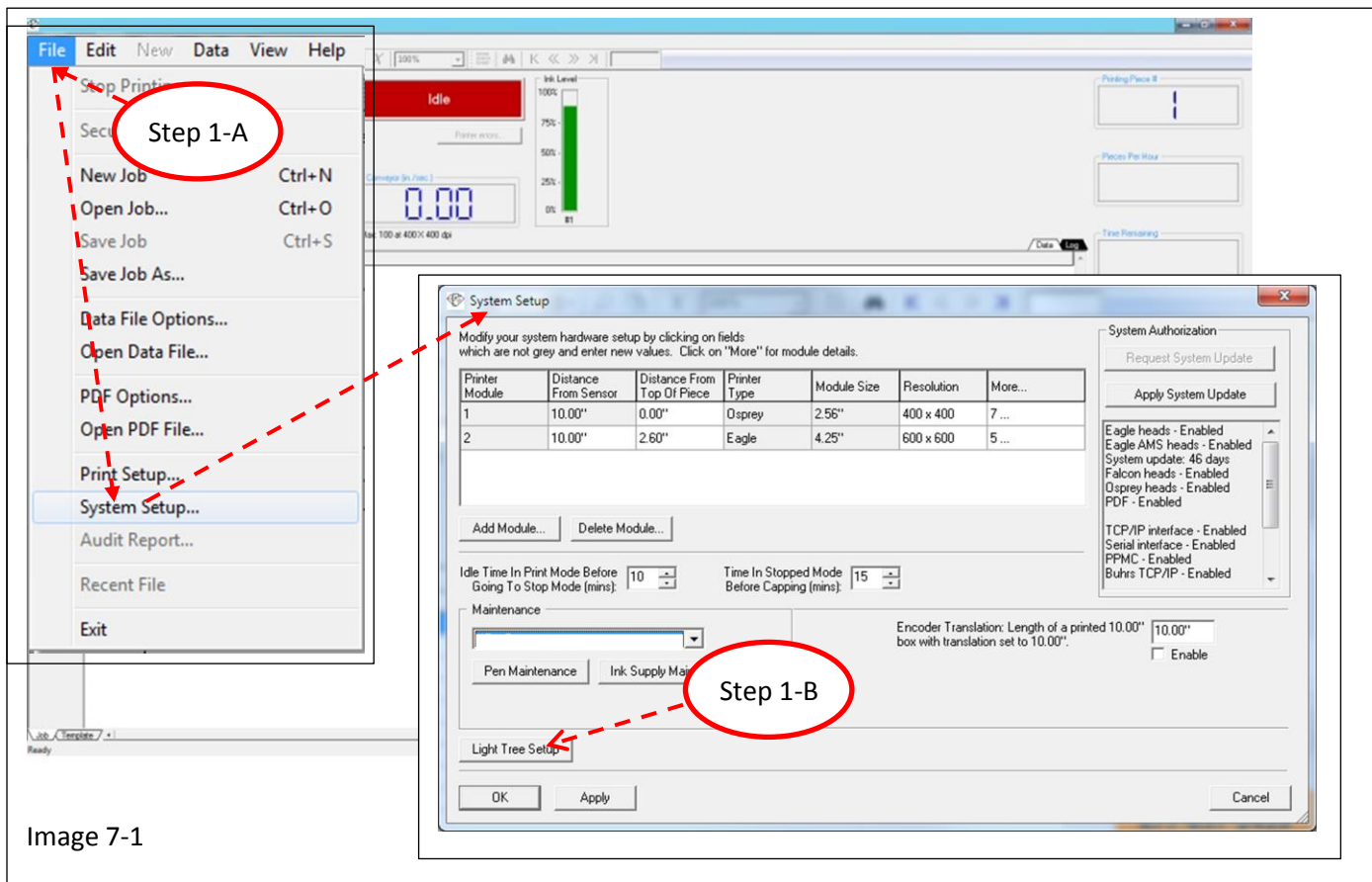

Image 7-1

The Light Tree Menu accommodates five (5) Machine functions, three (3) Print Features and six (6) Input Signal Verifications.

Step 2

To set up the Light Tree perform the following:

- Check the topic box to the left of the feature or function you want a light to signal for, see image 7-2.
- Select the color light you wish to set for the function or feature chosen, see image 7-2.
- Choose the state you want the light to appear for each feature of function selected, On, Off or Flashing. If Flashing is selected you must select the number of Flashes you want to occur for that feature, see image 7-2
- Press the "OK" button when finished to save your selections.

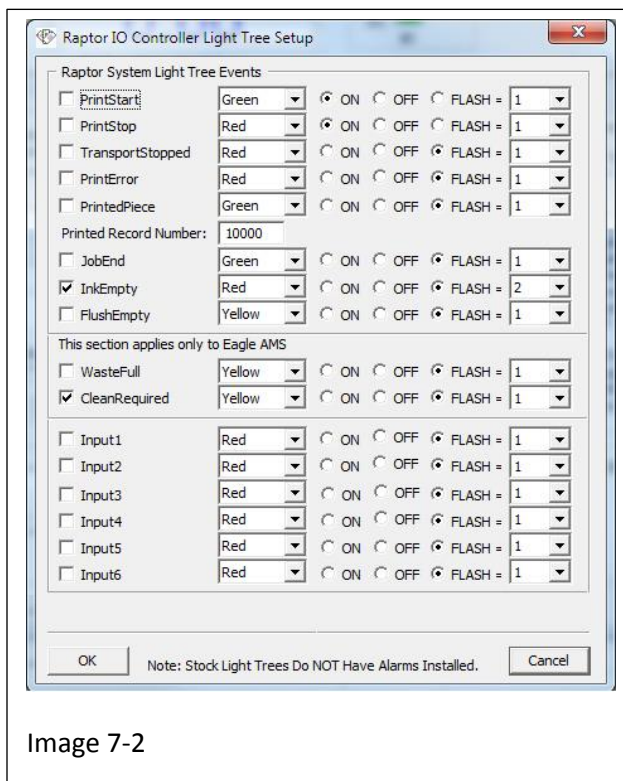

Image 7-2

Understanding the logic of the Light Tree Setup:

- Choosing the “On” light functions will produce a solid continuous light while the selected feature is engaged.
- Choosing the “Off” light functions will stop a solid continuous light while the selected feature occurs.
[Example: I have the selected the Green Light to come (On) at “Print Start” and also selected the Green Light to go (Off) at “Print Stop”]
- Choosing the Flash function will produce a light that flashes only the amount of times selected in the menu

Light Conflicts:

- In the event the same color light is selected for two different features the “Flashing Light” or the light set to the “Highest” number of flashes will prevail

[Example: I have selected the Red light to come (On) when the “Transporter is Stopped” and also selected the Red light to (Flash) 4 times for a “Print Error”. In the event the Transporter Stops at the same time a Print Error occurred, the Red light will Flash 4 times then go out. The transporter single will not come on.

- In the event of the same color light has been selected to “Flash” for two different features, the feature selected with the highest number of flashes will prevail.

[Example: I have selected the Red (Flash) 4 times when the “Job Ended” and also selected the Red light to (Flash) 9 times for “Ink Empty”. The Red light will simply flash for the feature set with the highest number of flashes.



Section Eight

Purging & Priming the Print Head

Section Eight

Purging and Priming the Eagle Print Head

The following is information specifically about the Eagle and Eagle AMS Print Head Pin Maintenance and Purging the Eagle and Eagle AMS Print Head.

With the system is powered up, it will be necessary to purge the Eagle Print Head by perform the following:

Step 1

Raise the Print Head and remove the cover in the following manner:

- A. Raise the Eagle Print head to its highest setting by pulling out the lock knob, manually lifting the Eagle Print Head and pushing the lock knob to its original position.
- B. Remove the cover on the bottom in the following manner:
 - B-a. Pull both retaining lock knobs out from the head at the same time
 - B-b. Once the locks are out of the head pull the cover down and away from the head and set the cover aside see image 8-1.
- C. Place a Purge Tray under the Eagle Print Head.

Special Note: If the Purge duration is set equal to or less than 3 seconds (refer to Step 2-E, setting the purge duration), use of a purge tray may not be necessary. Simply hold a Kimwipe under the pens (**Not Touching the Pens**) and press the yellow purge button on the print head

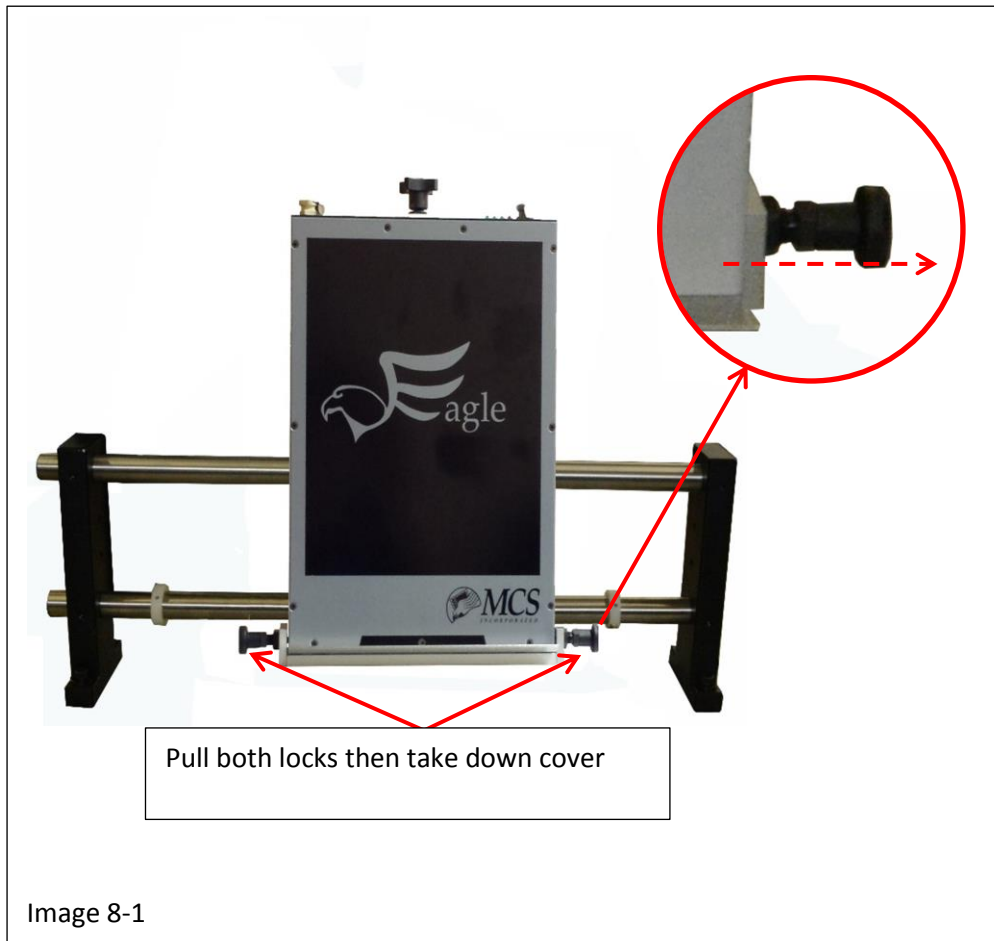

Step 2

Run the Raptor 6 Software and set the purge time by performing the following:

- Bring the Raptor 6 Software on line. (Purge time duration can be set for best performance in the “Eagle Pin Maintenance Menu”)
- In the Main Menu press File > System >> Setup, to open the System Setup Menu see image
- In the “Maintenance” section of the System Setup Menu, Select “Eagle” see image 8-2
- Press “Pen Maintenance” to open the menu shown in image 8-3.

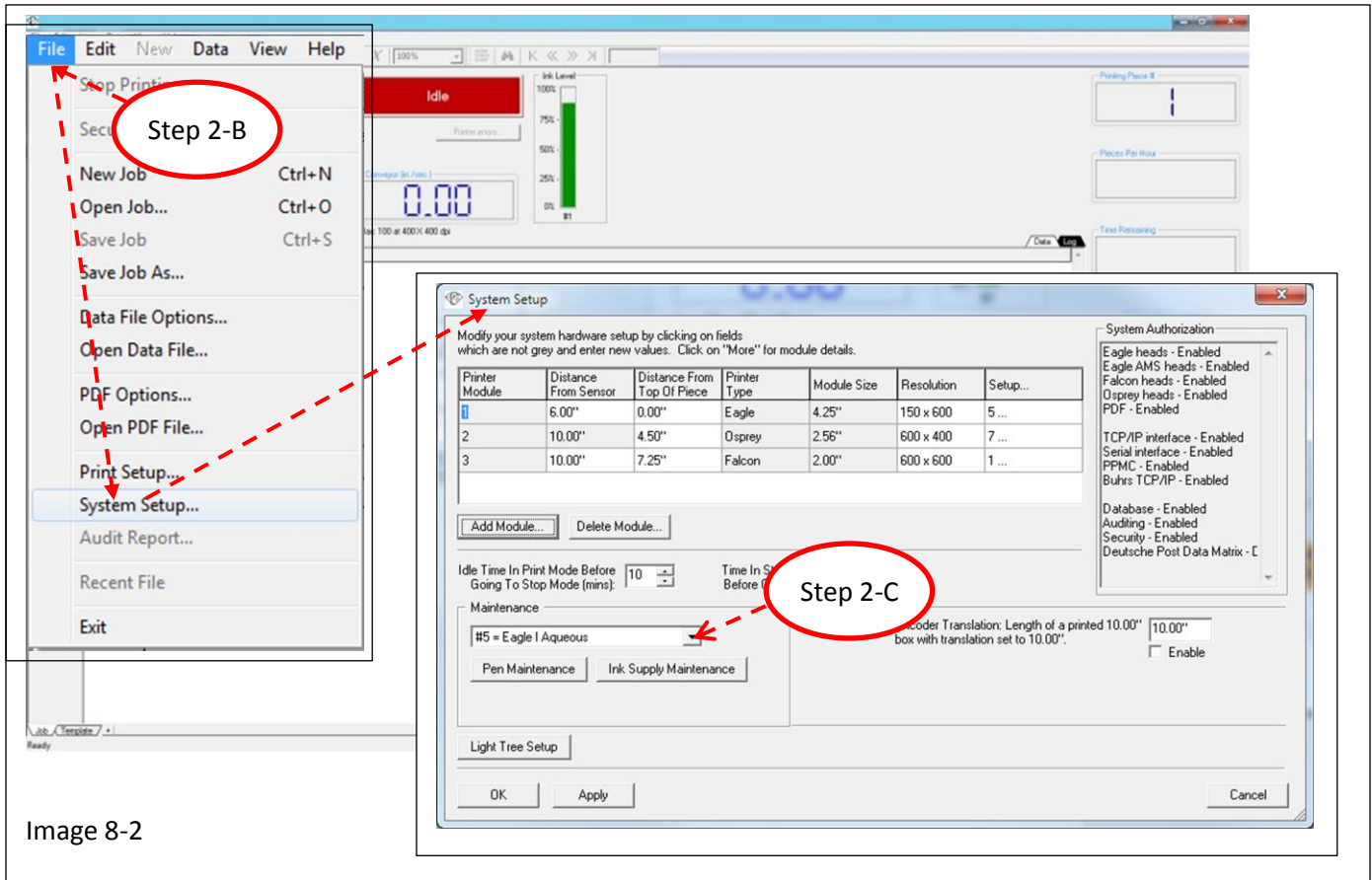
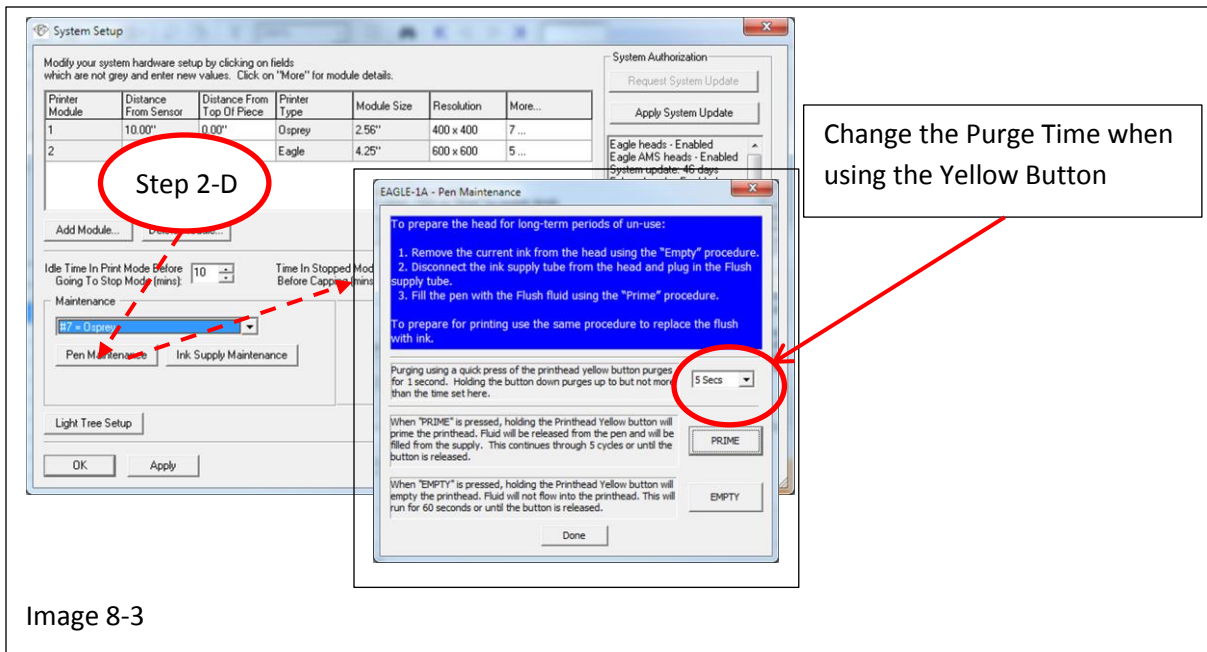

Image 8-2



- E. Once inside the Pin Maintenance menu, press scroll down arrow to select the purge duration time in seconds, see image 8-3. Once a selection has been made press the "Done" button to exit the menu and save the new setting. Now when the Yellow Purge button on the Eagle Print Head is pressed, the purge will last no longer the time set. (Note: Once this setting is made, it will become the default setting every time the Raptor Software runs)

Step 3

Purge the Print head by performing the following:

- Put an ink tray beneath the Eagle Print head before pressing the yellow purge button or if the purge duration is equal to or less than 3 seconds hold a Kimwipe under the pens (**Not Touching the Pens**) and press the yellow purge button on the print head.
- Press and hold the Yellow Purge Button down, for approximately one second, on the Eagle Print Head, a blue Dialog box will open on the monitor, see image 8-4. (Note: This will only appear on the screen for a brief moment while the system is actively purging)

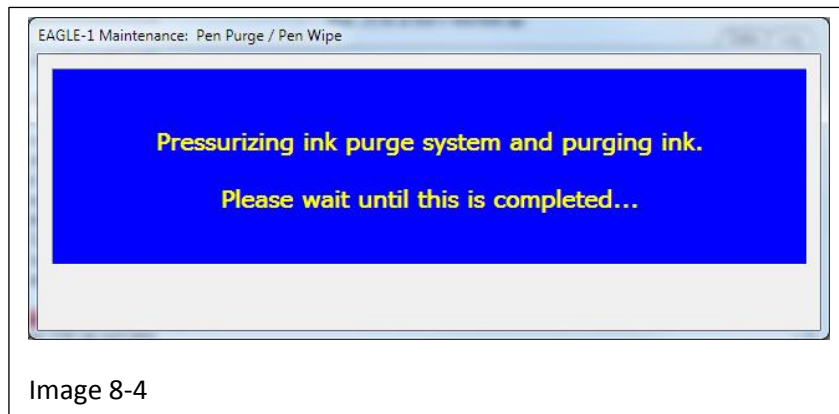

- C. Once the system has completed the purge a second dialog box will appear indicating to “gently wipe the pen’s nozzles using a new, clean Kimwipe”, see image 8-5. To close this dialog box you can either press the “Done” button located at the bottom of the box or simply start printing and the box will close automatically.

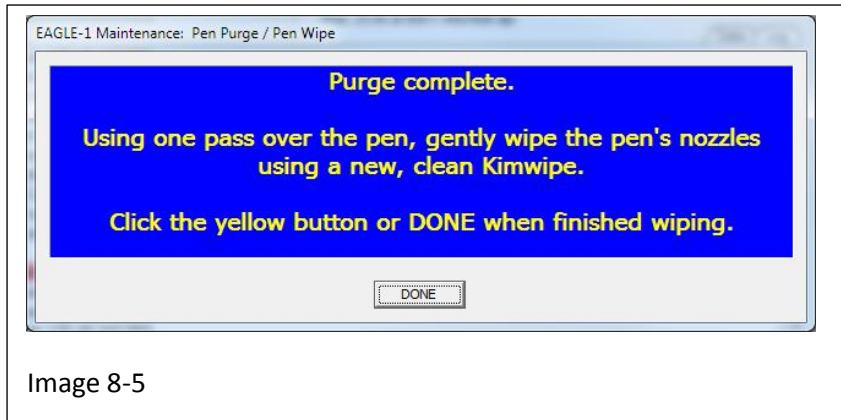

There are two other features found in the Pen Maintenance menu, “Prime” and “Empty”

1. When the Prime button is pressed, holding the Yellow Purge button on the Eagle Print Head will release fluid from the pen which will be filled from the supply (This continues through 5 cycles or until the yellow purge button is released) see image 8-6.
2. When the Empty button is pressed, holding the Yellow Purge button on the Eagle Print Head will empty the Print Head but the fluid will not be refilled. This feature will run for 60 seconds or until the yellow purge button is released, see image 8-6. (For details to Empty the Head for Storage see page 17)

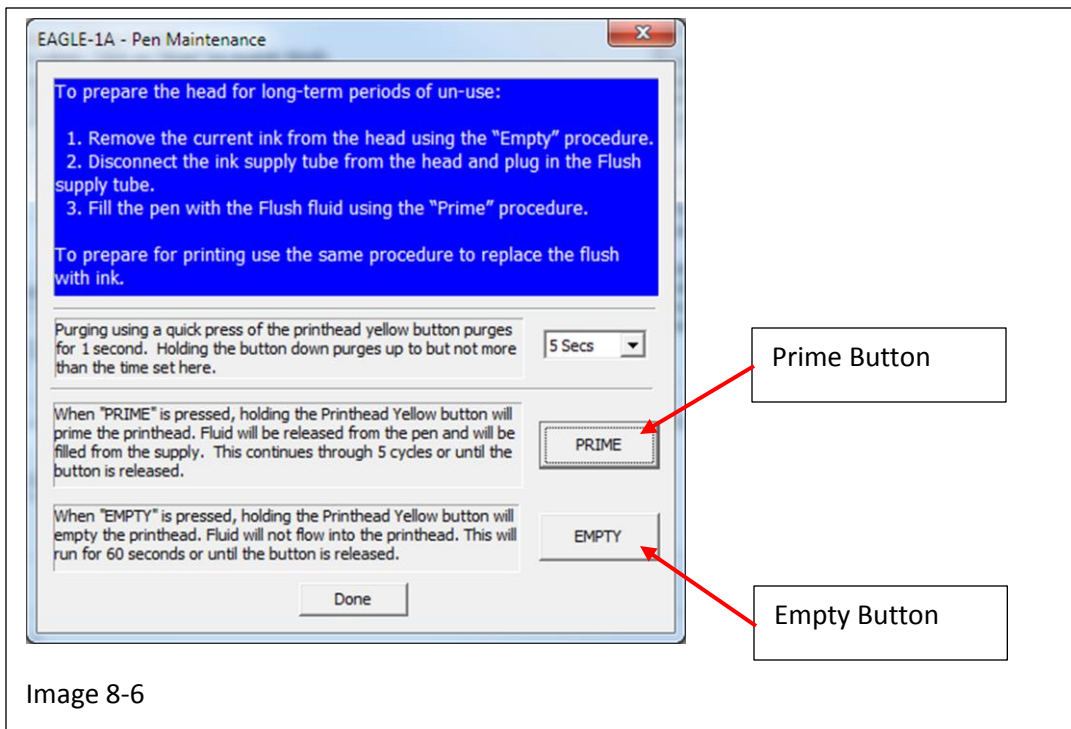

In the event air gets into the ink lines or ink foams from the pens during a purge, using the Prime feature will move greater volumes of ink through the system and clear the lines more efficiently than performing multiple purges.

To Prime the Print Head perform the following steps:

Step 1

Raise the Print Head and remove the cover in the following manner:

- A. Raise the Eagle Print head to its highest setting by pulling out the lock knob, manually lifting the Eagle Print Head and pushing the lock knob to its original position.
- B. Remove the cover on the bottom in the following manner:
 - B-a. Pull both retaining lock knobs out from the head at the same time
 - B-b. Once the locks are out of the head pull the cover down and away from the head and set the cover aside see image 8-7.
- C. Place a Purge Tray under the Eagle Print Head you intend to select as a precaution to guard against ink dripping onto the belts during this procedure.

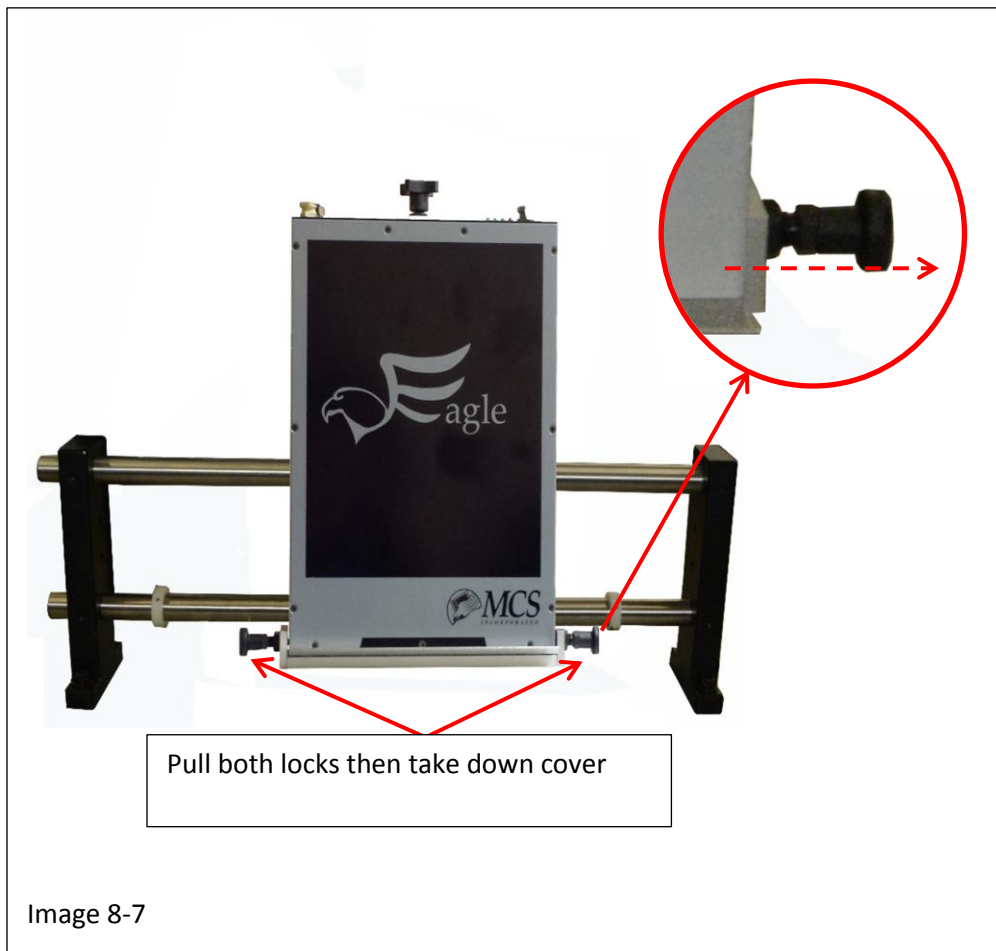

Step 2

Remove the “Ink Out” Fitting plug by:

- A. Press and hold the lock clip as shown in image 8-8
 - B. While the lock clip is depressed, lift out the fitting plug and set it aside, see image
- Note: Once the plug has been removed, the lock clip will remain open.

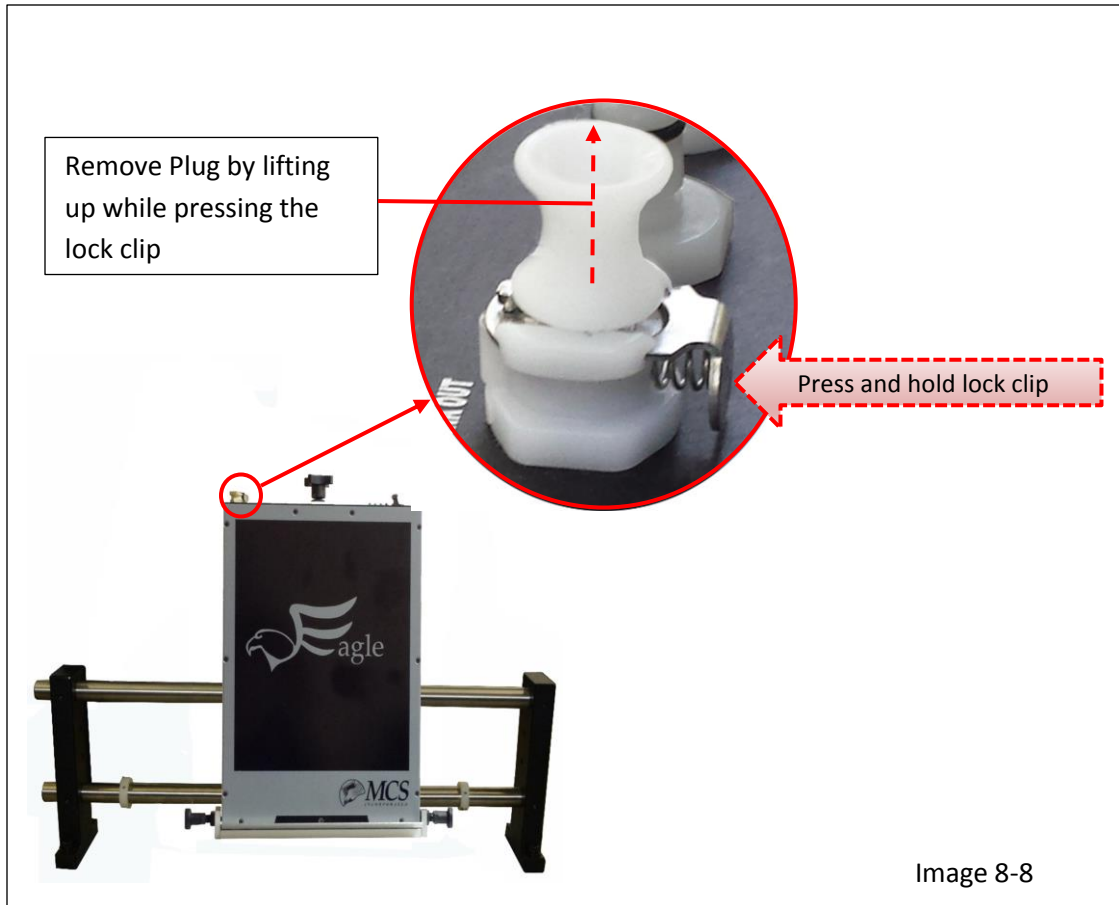

Step 3

Insert the Purge Bottle line fitting into the Eagle Print Head by pushing down firmly until the lock clip automatically closes, see image 8-9 and 8-10.

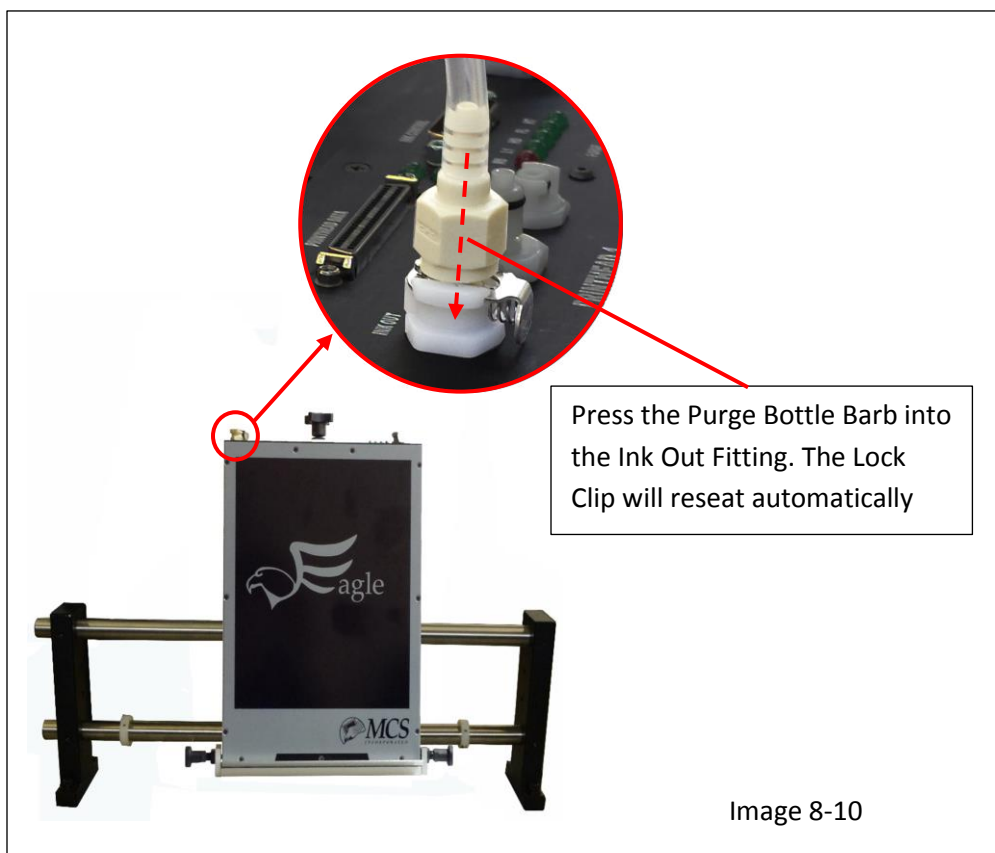
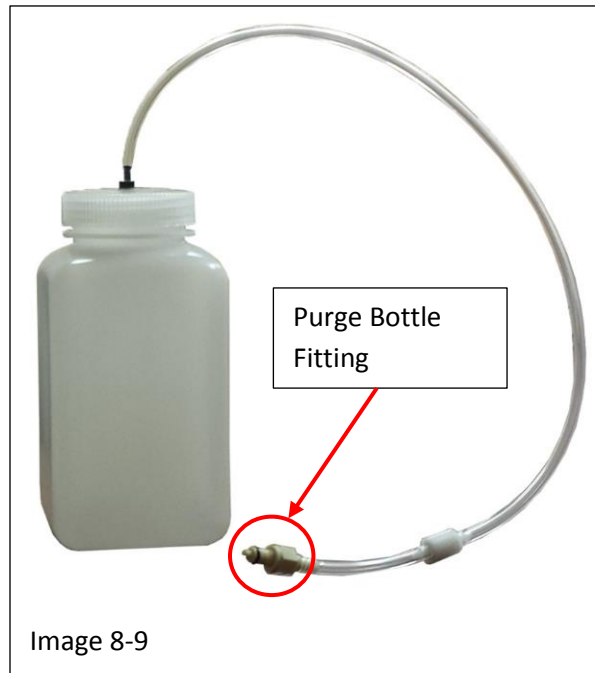

Step 4

Run the Raptor 6 Software and set the purge time by performing the following:

- Bring the Raptor 6 Software on line. (Purge time duration can be set for best performance in the “Eagle Pin Maintenance Menu”)
- In the Main Menu press File > System >> Setup, to open the System Setup Menu see image 8-11
- In the “Maintenance” section of the System Setup Menu and high light the “Eagle” Print Head you are purging, see image (⚠ **Warning:** Make sure the purge tray is under the print head selected)

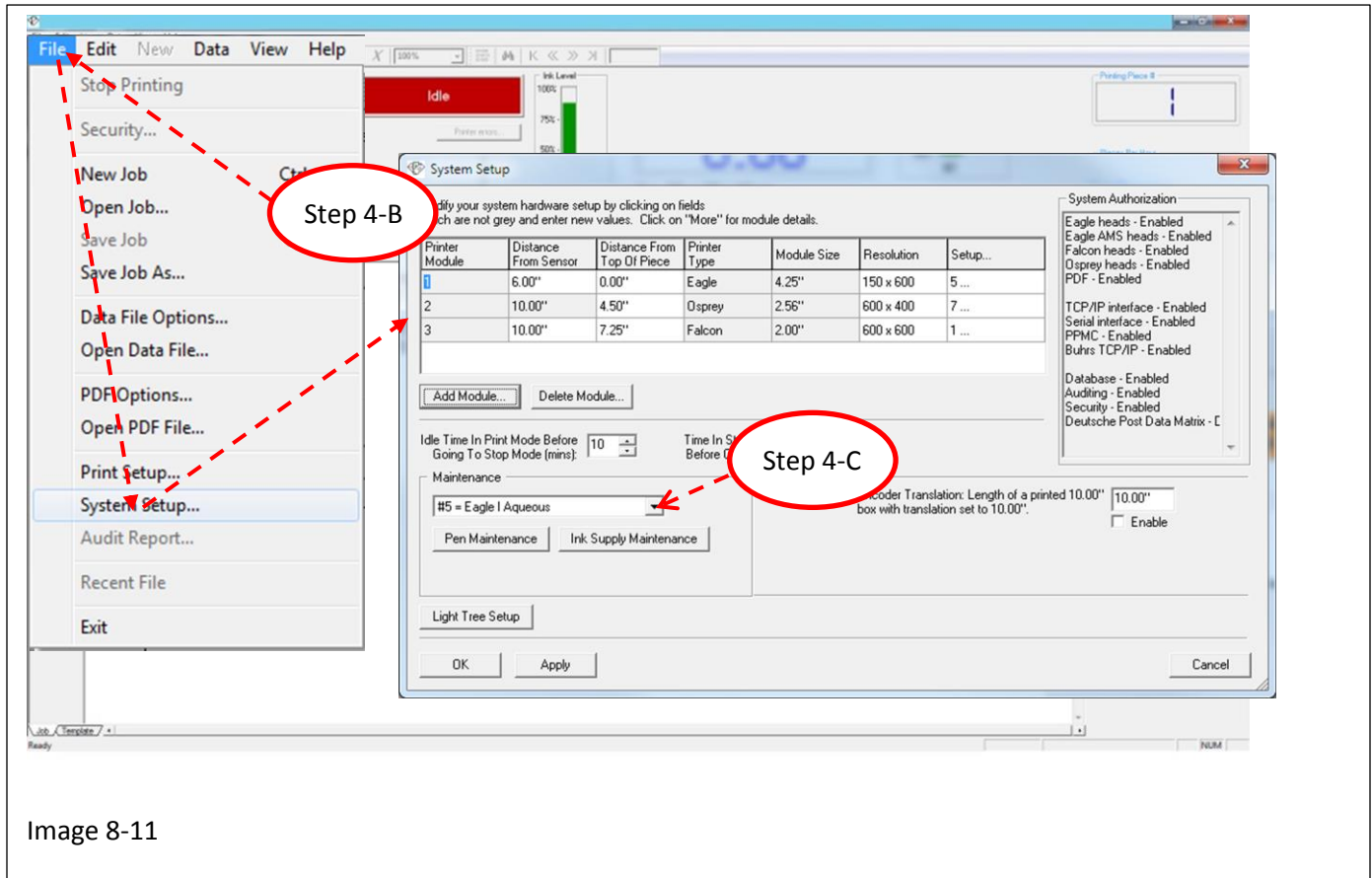

- Once in the Set Up Menu, press the “Pen Maintenance” button to open the Maintenance Menu, see image 8-12
- Press the Prime button, see image 8-12. (⚠ **Warning:** Make sure the purge tray is under the print head selected)

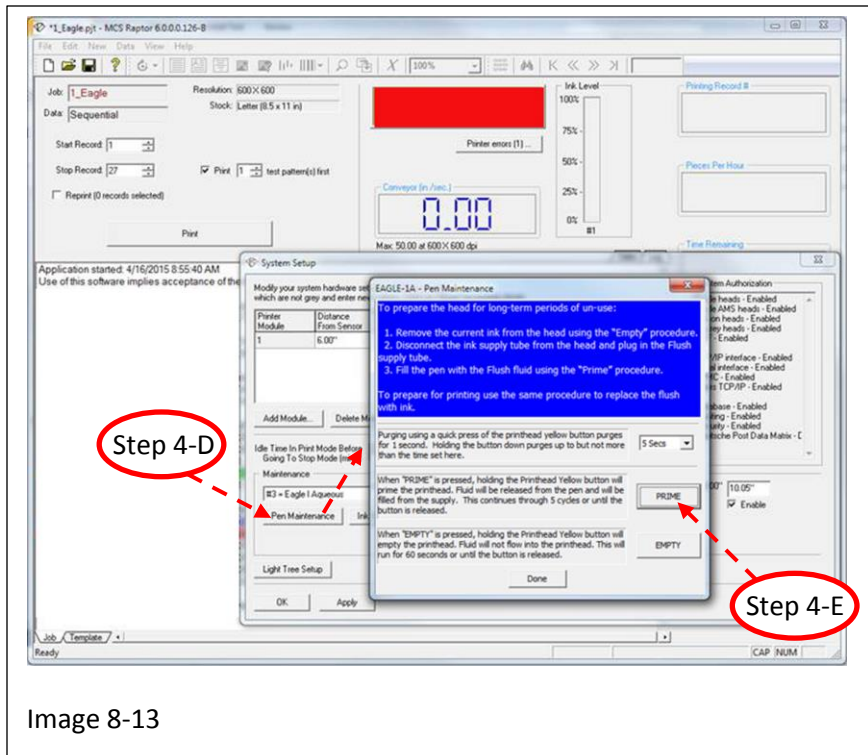

Image 8-13

- F. Press the Yellow Purge button to initiate the Prime function.
- G. Remove the Purge Bottle by pressing the locking clip of the “Ink Out” fitting, then lifting the purge bottle barb out of the fitting
- H. Insert the plug (removed in Step 2) back into the “Ink Out” fitting.

It should be noted that the appearance of the buttons in Maintenance Menu will change during the performance of Steps 4-E through 4-G, see image 8-14

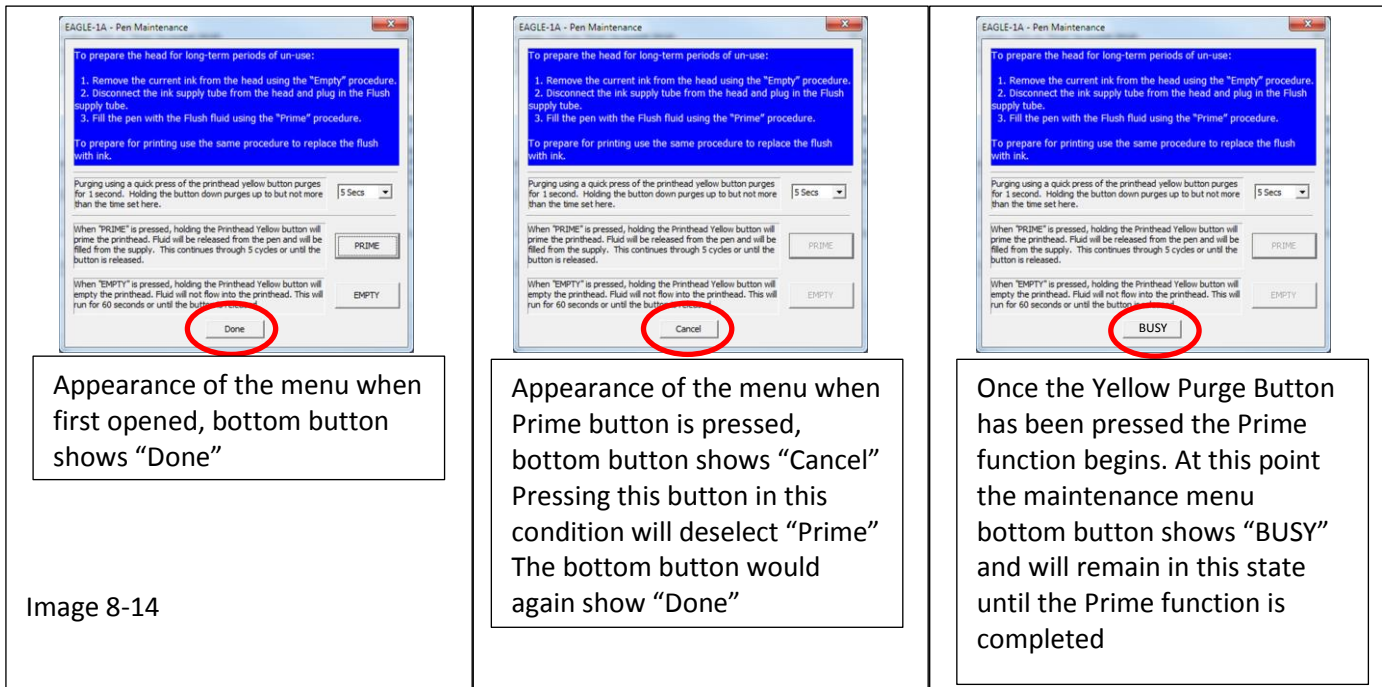

Image 8-14

⚠ Special Warning: If you have **not properly selected** the actual Print Head in Step 4-C you will effectively complete a simple Purge and never see the Pen Maintenance Menu go to the “BUSY” state. Instead you will see a Purge Complete appear over the Maintenance Menu as shown in image 8-15. This will be your only indicator that you have not performed the “Prim” Function.

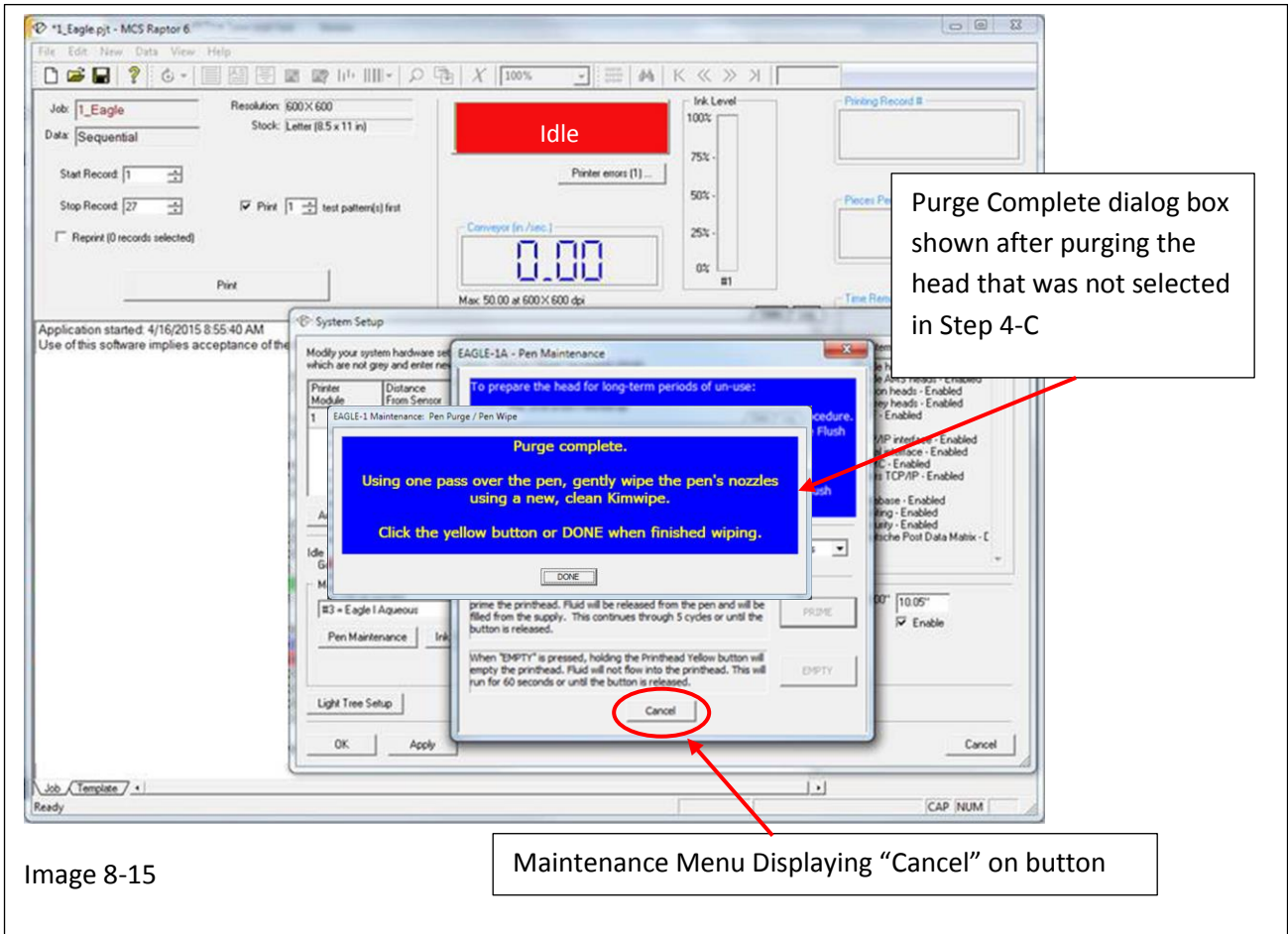

Image 8-15

Maintenance Menu Displaying “Cancel” on button

Section Nine

Preparing the Print Head for Storage

Section Nine

Preparing the Print Head for Storage

In the event your machine will be disconnected from power for a 90 day time period or more or you plan to ship the machine to another location it should be prepared for storage.

To prepare the Eagle Print Head for storage, perform the following:

Step 1

Raise the Print Head and remove the cover in the following manner:

- D. Raise the Eagle Print head to its highest setting by pulling out the lock knob, manually lifting the Eagle Print Head and pushing the lock knob to its original position.
- E. If the print head is covered, remove the cover on the bottom in the following manner:
 - E-1. Pull both retaining lock knobs out from the head at the same time
 - E-2. Once the locks are out of the head pull the cover down and away from the head and set the cover aside see image 9-1.
- F. Place a Purge Tray under the Eagle Print Head you intend to select as a precaution to guard against ink dripping onto the belts during this procedure.

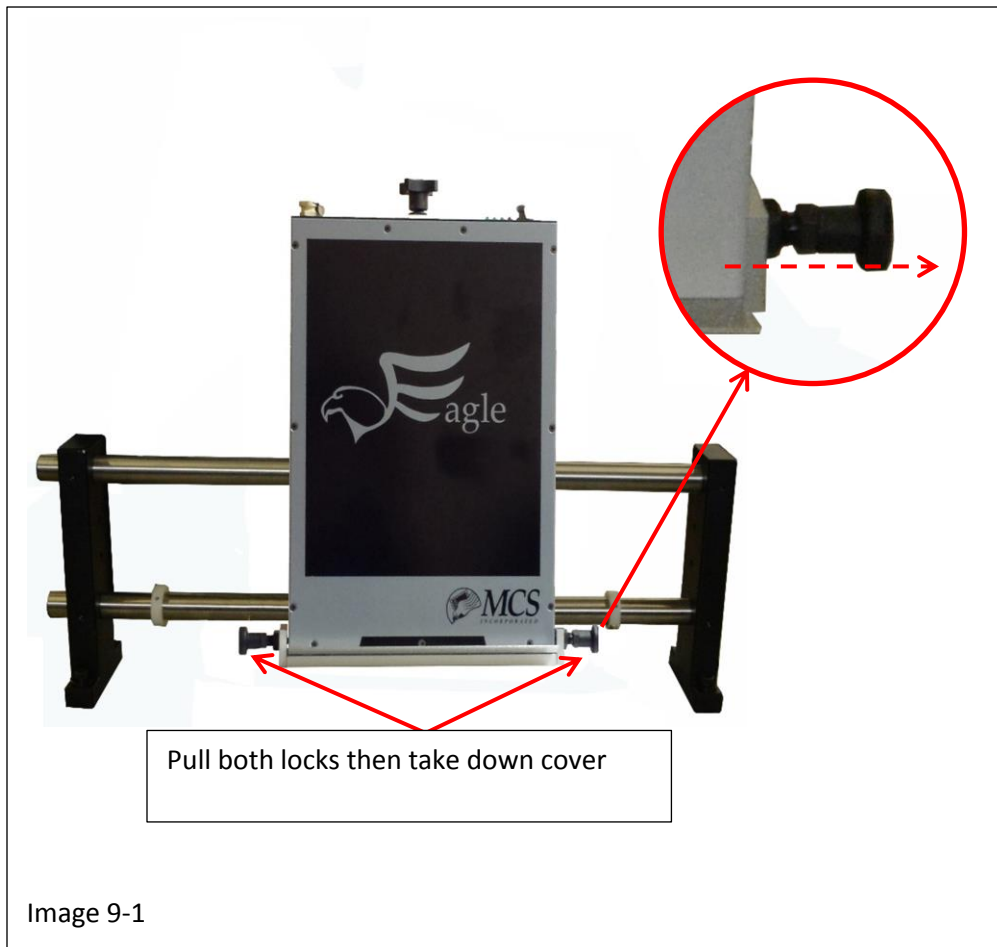

Step 2

Remove the “Ink Out” Fitting plug by:

- C. Press and hold the lock clip as shown in image 9-2
- D. While the lock clip is depressed, lift out the fitting plug and set it aside, see image 9-2

Note: Once the plug has been removed, the lock clip will remain open.

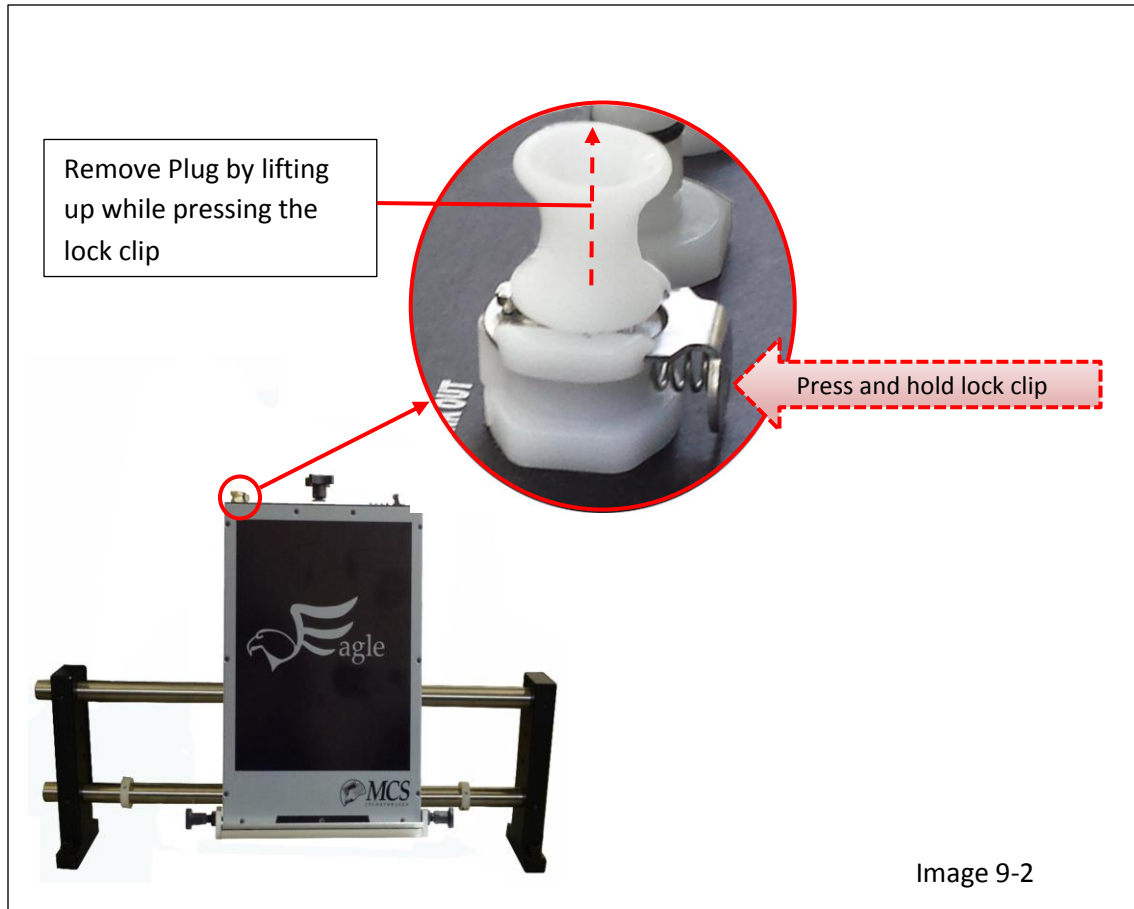

Step 3

Insert the Purge Bottle line fitting into the Eagle Print Head by pushing down firmly until the lock clip automatically closes, see image 9-3 and 9-4.

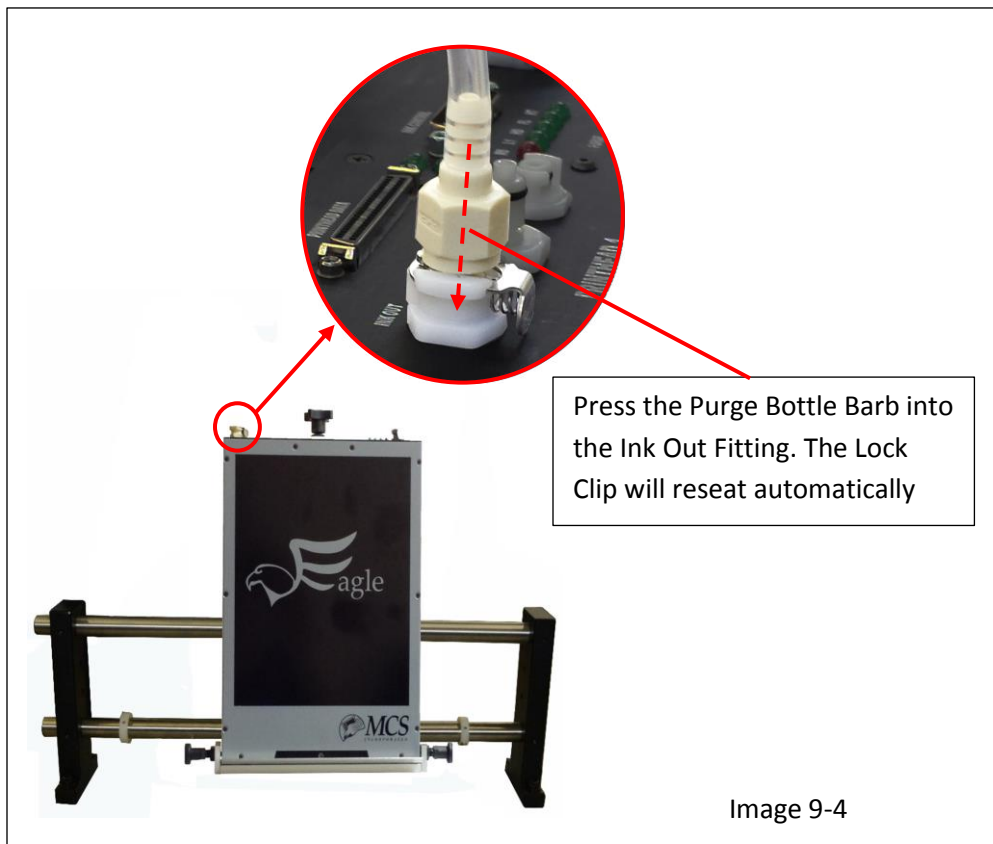

Step 4

Run the Raptor 6 Software and set the purge time by performing the following:

- Bring the Raptor 6 Software on line.
- In the Main Menu press File > System >> Setup, to open the System Setup Menu see image 9-5
- Go to the "Maintenance" section of the System Setup Menu and high light the "Eagle" Print Head you are emptying, see image 9-5. Note: This step will have to be repeated for each individual print head you wish to empty. There is no command to empty all the print heads at one time.
(**⚠ Warning:** Make sure the purge tray is under the print head selected)

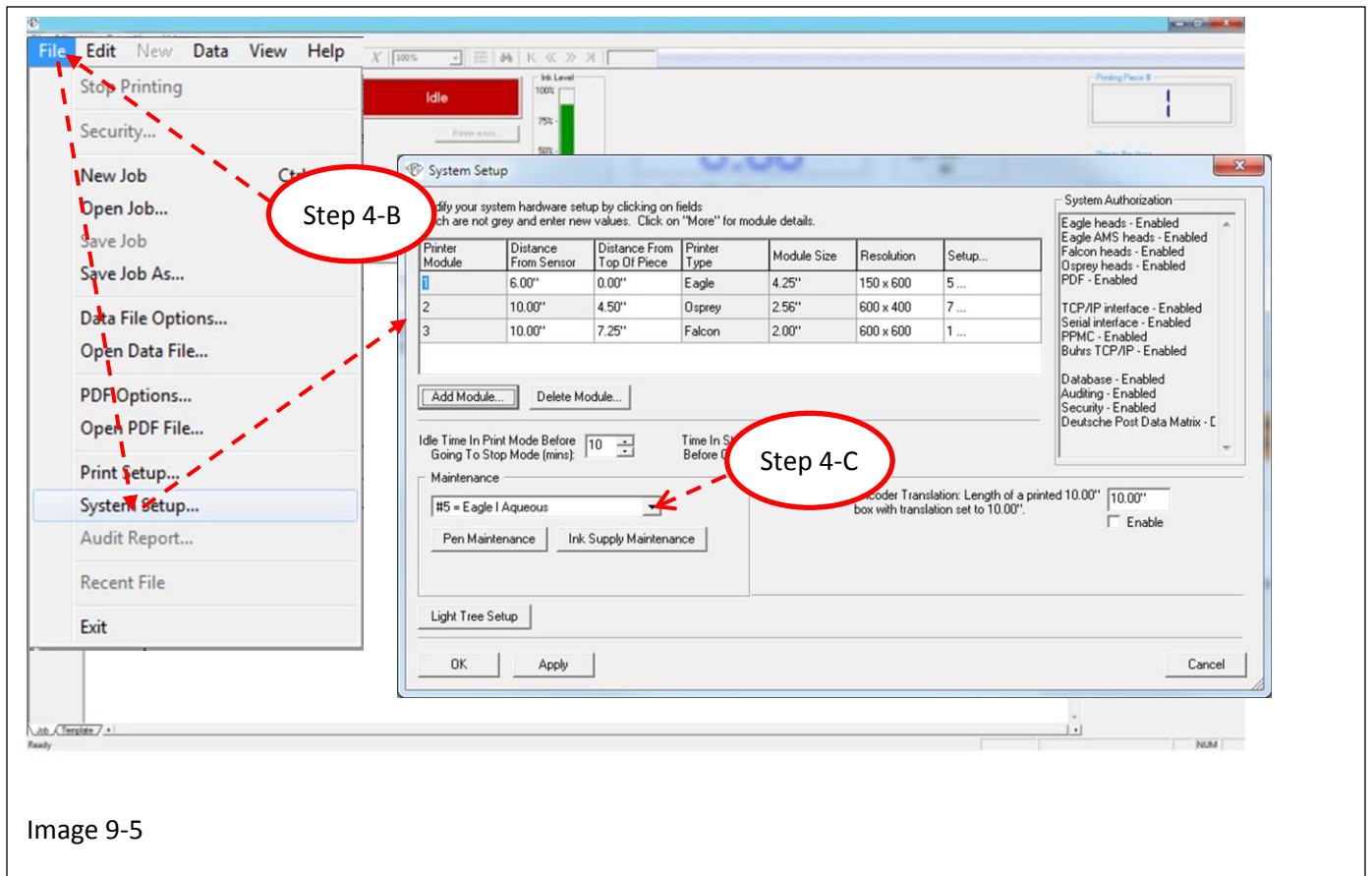



Image 9-5

- D. Once in the Set Up Menu, press the “Pen Maintenance” button to open the Maintenance Menu, see image 9-6
- E. Press the Prime button, see image 9-6. ( **Warning:** Make sure the purge tray is under the selected print head)

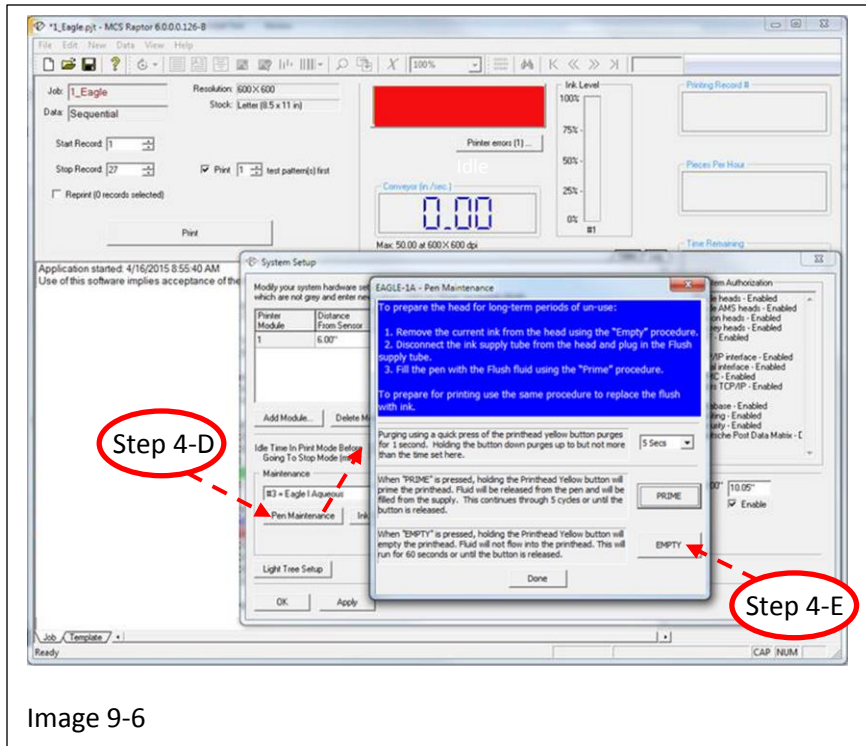

Image 9-6

- F. Press the Yellow Purge button to initiate the “Empty” function.
- G. Remove the Purge Bottle by pressing the locking clip of the “Ink Out” fitting, then lifting the purge bottle barb out of the fitting.

Step 5

Remove the Ink Bottle from the Ink Supply in the following manner:

- A. Press and hold the retaining clip on the ink supply box, see image 9-7.
- B. Lift the line off and away from the ink bottle.
- C. Remove the ink supply box from the Ink Supply Controller, see image 9-7.
(Note: Cap the Ink Box once it has been removed)

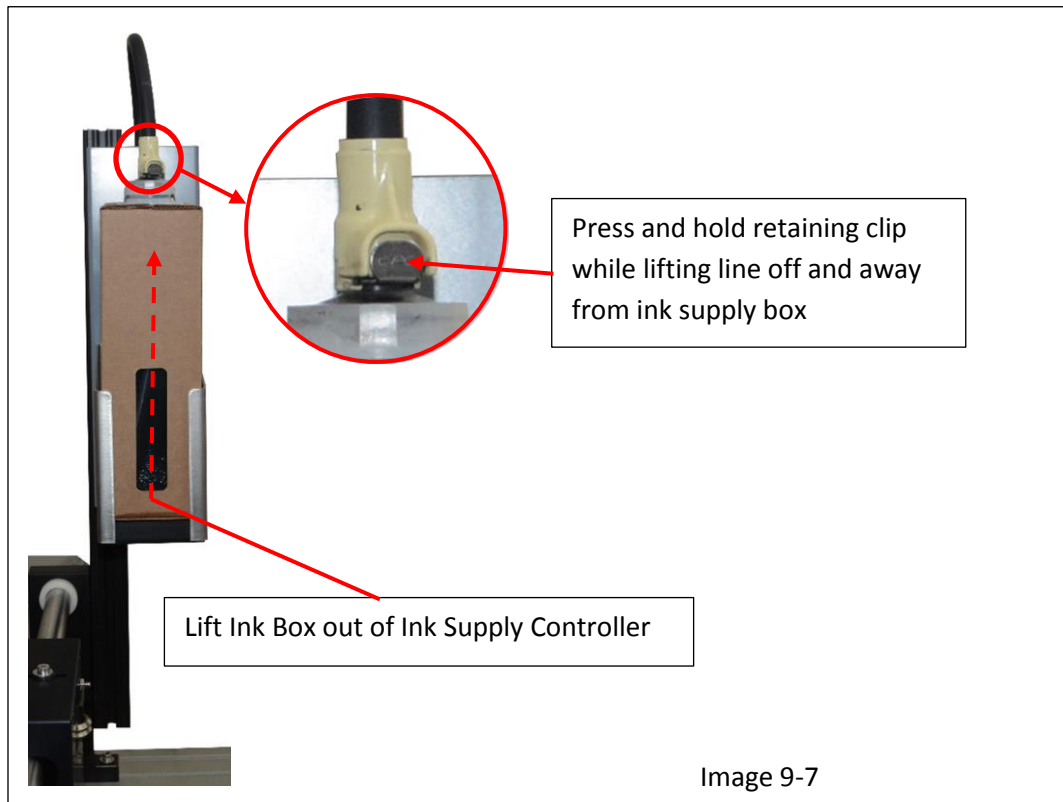

Step 6

Install a box of “Flush” solution into the Ink Supply Controller

- A. Place the Flush box into the ink Supply Controller with the view window face out
- B. Remove the cap from the barb at the top of the box
- C. Press the supply line fitting on the box barb firmly until the retaining clip locks.

Repeat the “Prime” procedure as stated in Step 4 on pages 47 through 48 to flush the Eagle Print Head.

(Note: It may be necessary to empty the Purge Bottle before priming the head with Flush)

The flush box can be left in the Ink Supply Controller for storage. When putting the system back on line after it has been inactive, prime the system with Flush, then install a New Box of Ink and prime the system.



End