



Looking for an ST 2110 waveform monitor, a 4K waveform monitor or an 8K waveform monitor?

Welcome to the PRISM family of waveform monitors, the only solution you need...

In the competitive media and entertainment industry, success relies on superior content and quality delivery. The PRISM family helps ensure both, through tools that meet the required diagnostic and analysis needs. Whether you need an instrument for engineering, the creative team, or both. PRISM delivers:

- SD, HD, 1080P, 2K, 4K, 8K resolutions/formats. [Learn more.](#)
- Four (4) simultaneous SDI inputs, up to 12G
- Two (2) IP video ports up to 25G supporting ST 2110, ST 2022-7, ST 2022-6 and PTP
- Audio Metering up to 32 channels/program
- Dolby ED2/E/D/D+ audio via SDI and ST2110-30/31
- Objective HDR measurements with integrated HLG, PQ, Slog2/3, and Log-C gamma curves
- Wide Color Gamut measurement and error detection for Rec.709, DCI-P3, and Rec.2020 color spaces

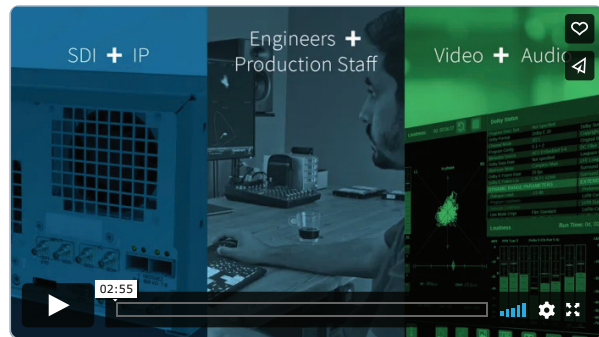

All in a compact package with no compromise on flexibility or performance.

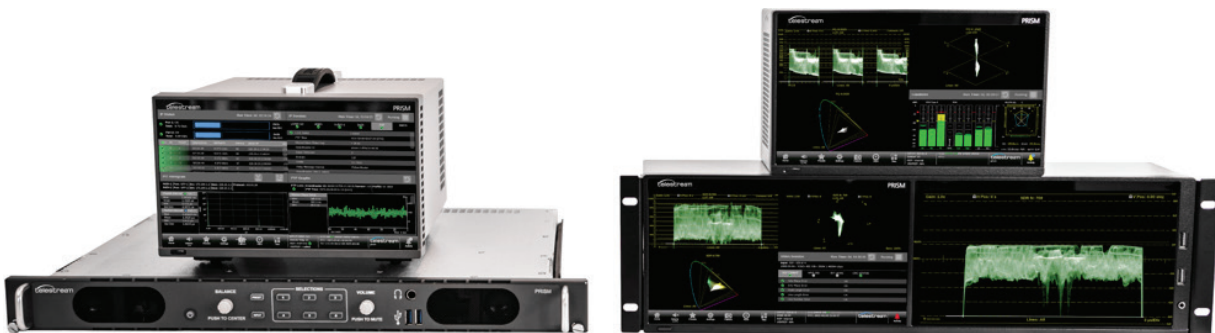

Which Form Factor Fits Your Application?

Simply select the form factor and connectivity you need. The PRISM software does the rest.



PRISM MPI2

- Integrated Touchscreen
- 3RU height, Half Rack width, 10.5" depth
- SDI and IP connectivity as Standard
- Optional Eye Board
- Can be racked with WFM series



PRISM MPX2

- External Display
- 1RU height, Full Rack width, 16.5" depth
- SDI and IP connectivity as Standard
- Optional Eye Board
- Optional Integrated Speakers



PRISM MPS Series

- Integrated Touchscreen
- 3RU height, Half Rack width, 5" depth
- MPS-100 SDI connectivity
- MPS-200 SDI and IP connectivity
- MPS-300 SDI, IP connectivity with SDI Eye/Jitter measurements

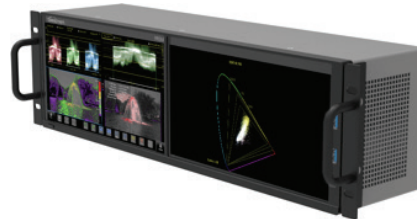

PRISM MPD Series

- Dual Integrated Touchscreen
- 3RU height, Full Rack width, 5" depth
- MPD-100 SDI connectivity
- MPD-200 SDI and IP connectivity
- MPD-300 SDI, IP connectivity with SDI Eye/Jitter measurements

Standard Apps

The base model is equipped with a rich set of standard applications.

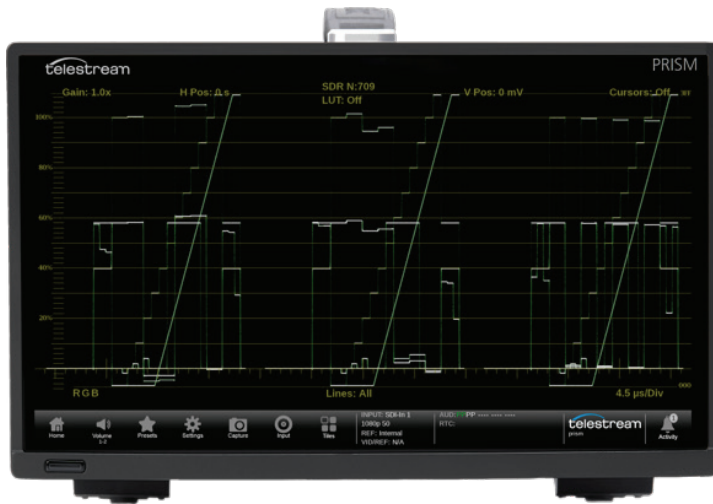

Waveform Display

Provides an array of configurations for various display of YPbPr, YRGB or RGB with a variety of Gain, Sweep, Mag and Line Select functions and the ability to add cursors for precise measurement within the trace.

[Learn more](#)

Optional Apps

Expands the standard capabilities to unlock a wide range of measurement to address your specific application.

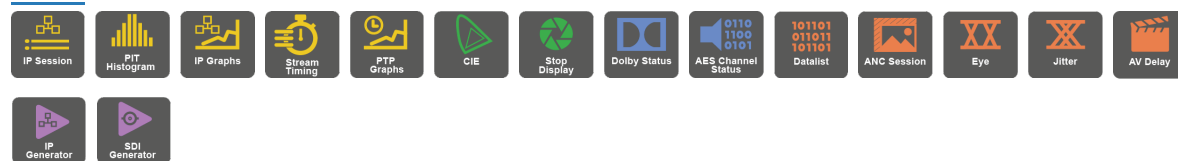

IP Session

IP Session provides a summary of information for the decoded stream. With information on Layer 1 and 2. Along with syntax information on the video, audio and data streams. Summary information is provided on PTP and NMOS applications to assist the user in diagnosing problems. Requires option IP-MEAS to be installed in the instrument.

[Learn more](#)

Customization and Personalization

PRISM is designed to be used in multiple applications from HD-SDI Live Acquisition to 25G ST 2110 IP Engineering and diagnostics. Software modules Options can be added any time to customize the instrument to meet the needs of job at hand.

The software based UI can then be personalized to meet the needs of the individuals on the team and how they like to work. These configurations can be stored as presets for quick instrument setup when needed.

With multiple ways to mount and install the instrument and multiple ways to interact with, and control the instrument, PRISM fits comfortably into any environment.

[Learn more](#)



Flexible Display Configurations

Single Display

Flexible tile configurations provide full screen, two, three and four tile layouts giving flexibility in selecting a variety of software apps for your specific application while still allow easy viewing of each display. Each layout can be customized for each user and assigned as a preset.

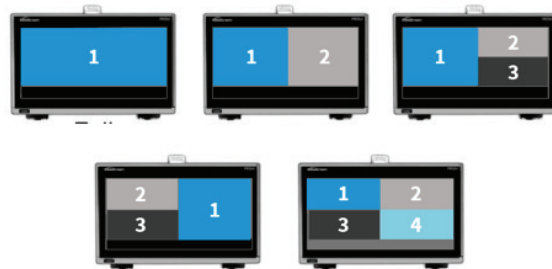

Dual Display

With Dual screen displays each display can be configured the same way you can configure a single screen instrument providing an abundance of ways to personalize the user experience. Your layout can go from two full tiles to a total of eight quarter tile display applications and anything in between.



Multi-Input Monitoring

With the MULTI option operators can easily compare different input channels and use the wide variety of Apps within PRISM that can be tailored to meet your applications. These various configurations can be saved as presets for easy recall and gives operators and engineers the ability to customize the inputs and applications to suit their needs from camera shading to color correcting with HDR and SDR content.

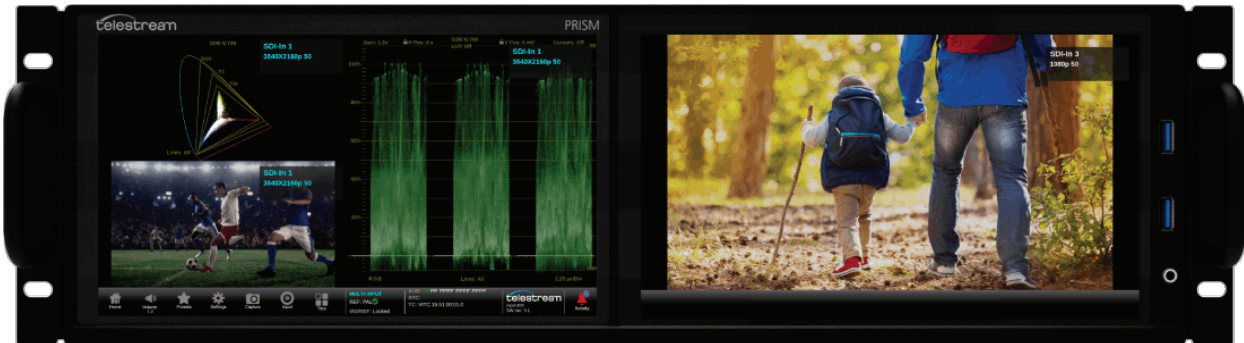

Remote Connectivity

Engineering and production staff increasingly need to work remotely, and PRISM can be controlled via noVNC using the same UI that can be accessed from the front panel. Providing the user with fully featured access to the monitoring and measurement applications available within PRISM.

Remotely configure and export presets, download the event log and use Syslog for remote analysis of events and alarms.

High Dynamic Range Exposure Measurement

Managing exposure is key to the creation of great content. PRISM provides a mix of traditional and new tools such as False Color Displays, STOP waveform, Lightmeter and internal LUTs for managing S-Log 2, S-Log 3, Log-C, HLG and PQ gamma curves to enable objective level and luminance area measurements to ensure consistency.

[Learn more](#)

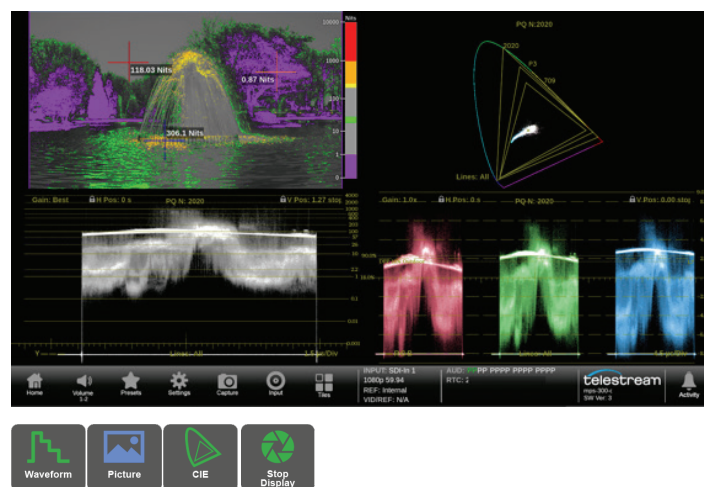



Wide Color Gamut and Color Management

The combination of high resolution, wide color gamut and high dynamic range can bring the image to life.

PRISM provides all the tools needed to balance your camera, check color consistency and master in multiple color spaces. The Vector and CIE chart displays provides adjustment of color for Rec. 709 and 2020 color spaces. The Teletream Diamond display simplifies adjustment of the R/G/B components.

The CIE charts ensure compliance for Rec. 709, 2020 and DCI P3 with False Color Gamut overlays in the picture display make it easy to identify colors that are outside the DCI-P3 or Rec.709 color space.

[Learn more](#)

Audio Monitoring

PRISM provides a set of audio monitoring tools for embedded audio and ST2110-30 or -31. Including configurable audio bars, Loudness measurement, Surround Sound, Lissajous phase, and Audio Session displays, for monitoring multi-channel 5.1, 7.1 and 7.1.4 mixes with Dolby Digital and E decoding. Dolby ED2 is supported for Metadata display in Dolby Status. Decoding up to 32 Channels of audio for 8K productions.

Listen to the selected audio channels or downmixed stereo channels via headphones or through optional integrated speakers on the MPX2.



MPX2

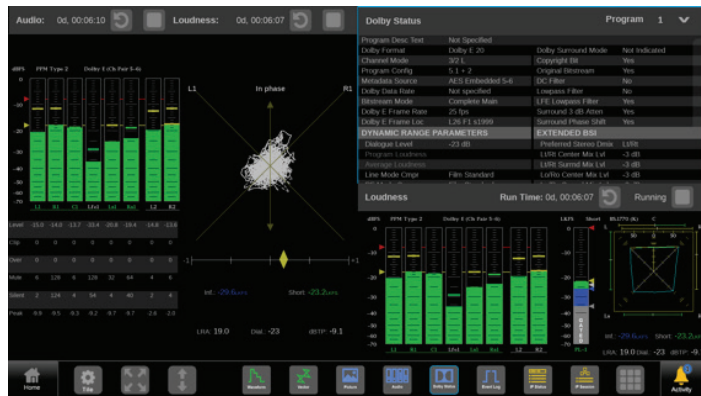

IP Facility Design, Commissioning and Maintenance

The transition to IP needs a comprehensive tool set to provide visibility of your Audio, Video and Data streams throughout the network.

PRISM provides 10GE support for ST2022-6, ST2022-7 and ST2110 as standard with simple software upgrade to 25GE connectivity. Straightforward monitoring of IP streams with measurement applications to help characterize network performance and troubleshoot issues.

[Learn more](#)



SDI Engineering and Maintenance

Ensuring continued operation of equipment within the facility or network is critical to maintaining a high quality. The Telestream PRISM provides an extensive set of tools to aid in troubleshooting problems and diagnosing issues. For SDI a 12G Eye display can be used to check on the health of transmission of the signal.

With the Datalist and ANC Session allowing investigation of metadata issues to ensure SCTE104, Closed Captions and AFD are present within the signal and being decoded correctly.

For validation of Lip Sync issues AV Delay measures the timing difference between audio to video using a simple flash pop sequence generated by the Telestream SPG and provides a measurement of advance or delay for up to 16 channels.



See the bigger picture...

See what is happening on the whole network 24/7 and respond to issues quickly and decisively. PRISM and the Telestream Inspect 2110 probe work in conjunction to provide large scale monitoring by exception, network visibility and deep content and stream diagnostics at the click of a button. The complete Engineering and Operations solution all from one company that can grow as your network grows.

[Learn more about Inspect 2110](#)

Live Production

Live production is a high pressure environment for Video Shaders and the Engineer in Charge. They need the right tools to help them setup the OB Truck quickly and reliably. Once the event starts the Shaders need easy to use instruments and easy to understand displays to allow them to make camera adjustment decisions quickly and accurately regardless of whether it is an HDR or an SDR production.

Customizable UI's, managed presets and specialist tools for exposure and color makes PRISM the ideal tool for this environment. Manage exposure multiple ways using the waveform, false color picture display, Stop display and Lightmeters. Manage color using the vector display, diamond display, CIE chart, and false color picture display for gamut. With MULTI options users can monitor up to four SDI inputs simultaneously to make comparisons of multiple cameras or compare SDR to HDR content.

All the tools that the Shading team would expect and more.





Post Production

Quickly delivering high-quality content is critical to success as a Post Production professional. Editors and colorists need trusted, easy-to-use, tools to help accurately adjust exposure levels, manage looks, match color and exposure between scenes, and much more.

PRISM provides an array of both unique and traditional tools to manage exposure and color. These include Stop displays for easily measuring signal levels on the same scale you manage light levels; CIE charts with easy-to-read Rec.709, DCI P3, and Rec.2020 limit indicators; customizable false color image overlays to easily identify exposure and color gamut anomalies; and colored RGB Parade display, and traditional waveform and vector displays. These tools are wrapped in a proven UI, with usability features like a large floating timecode display and easy-to-read AFD / safe area / center graticules, that can be personalized to let you work the way your team and workflows need it to work.

For applications beyond the needs of broadcast television, PRISM supports DCI 2048x1080, 4096x2160 4K sources. The growing list of formats includes 10 or 12bit RGB via SDI at frame rates of 23, 24, 25, 29, and 30p; and 10bit YCbCr via ST 2110-20 at 23, 24, 25, 29, 30, 50, 59, and 60p, among others.

The PRISM preset system; event log; and audio, video, and data toolsets make technical QC and mastering a structured and repeatable process. Get it done right, first time, every time.

Regulatory Compliance

Broadcasters are responsible for ensuring that their content meets regulatory compliance requirements. PRISM provides a complete toolset for Technical QC and compliance checking.

Closed Captions support for CEA-608/708 ARIB STD-B37 and World Standard Teletext (WST) with decode of subtitle pages using OP47/ST2031 Ancillary data SCTE104 data can be monitored in ANC Session and logged in Event Log. Adjust Test level and Program peak level in Audio bar display to monitor audio level with facility standard.

Loudness monitoring that supports EBU R128:2014, ATSC A/85:2013 and BS.1770-2.

Gamut monitoring that supports EBU R103-3 (2020).

[Learn more](#)





PRISM Apps

All Apps

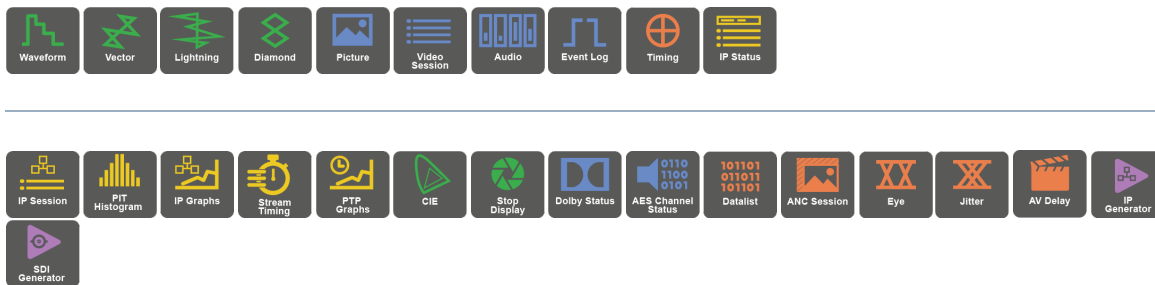

Waveform Monitor

A full-featured waveform display with impeccable trace quality and dimension that allows users to pick out detail important to the job. Customize the measurements quickly and easily for NITs, 5X magnification, or line select.

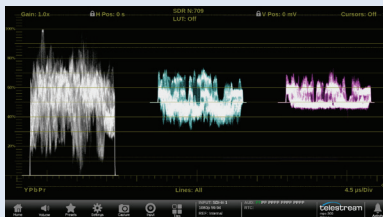

YPbPr waveform display to isolate difference between luma and color components. Color trace can be selected in application menu.



Precise adjustment using Line Select to isolate individual lines within the image.

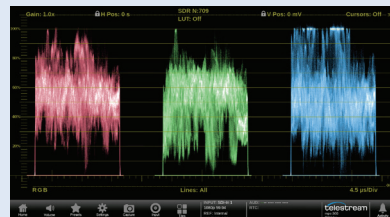

RGB or YRGB waveform display for camera shaders and colorists to make fine adjustments of the image.

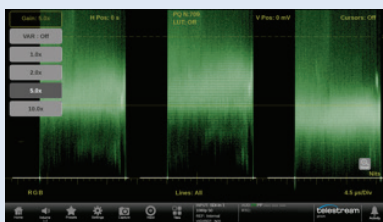

Gain adjustment for fine adjustment of black or white levels.

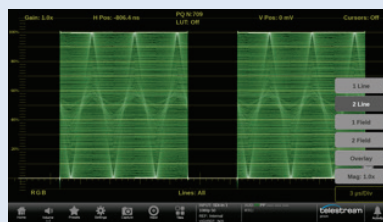

Sweep and Magnification to analyze lines and fields of the waveform with precise magnification.

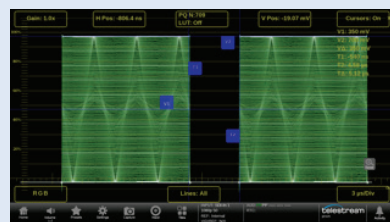

Cursors to measure voltage and time with selectable values of millivolts, percentage, code value and Nits/Stops.



Vector

Allows the user to adjust the Saturation and Hue of the color components with adjustment of Gain, Line Select or bar format (100% / 75%).

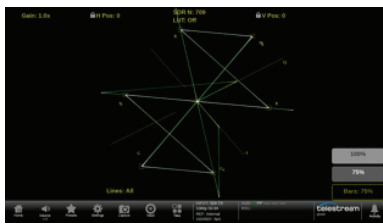

Selectable Bar Format for 75% and 100% Graticules with input selection for chromaticity of 709 or 2020.

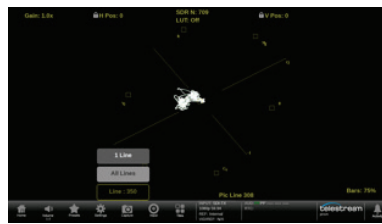

Precise adjustment using Line Select to isolate individual lines within the image

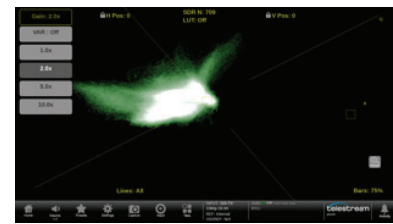

Gain adjustment for adjustment of color offset in center of trace with IQ axis enabled for adjustment of flesh tones.



Lightning

Telestream's Lightning display provides an intuitive X-Y plot of the YPbPr component signal with Y versus Pb in the upper half of the display and -Y versus Pr in the lower half of the display.



Using a simple color bar test pattern 75% or 100% should align within the appropriate graticule boxes.

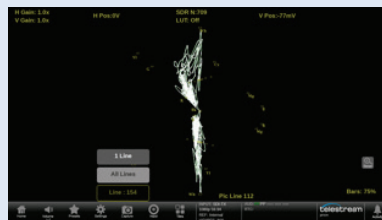

Use Line Select to isolate and individual line within the image.

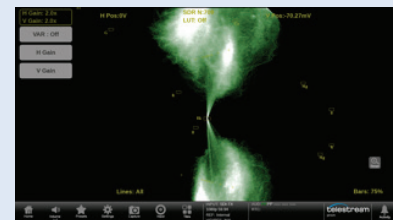

Gain and MAG adjustment allow for adjustment of color offset in the blacks at the center of trace.

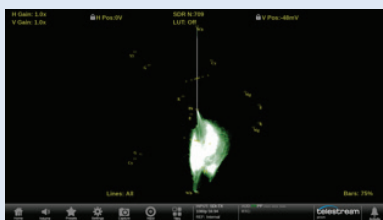

Easily identify the color component with Pb in the upper half and Pr in lower half. With luma in the vertical axis and chroma in the horizontal axis. In this case the Pb component is missing.



Using color bars a bending of the Green Magenta transition can indicate an inter-channel timing error within a specific component of the signal.

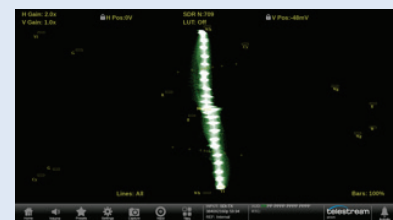

With a camera grey scale chart a deviation in the lower half of the display shows a red offset in the image.



Diamond

Telestream's Diamond display provides an intuitive X-Y plot of the RGB component signal with G versus B in the upper half of the display and -G versus R in the lower half of the display.



Diamond display for monitoring of RGB component signal for Camera Shading and Editors/Colorist with 100% color bars applied

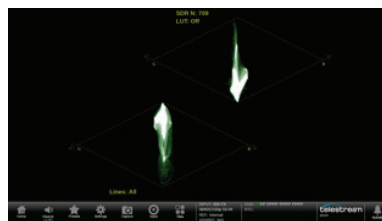

Split Diamond display that allows the user to see the offset in the black of the RGB color components.

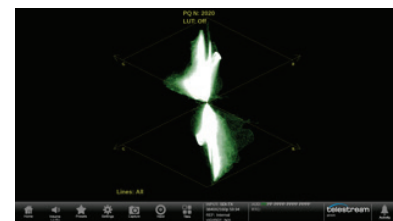

Diamond display for monitoring of RGB component signal for Camera Shading and Editors/Colorist using a live signal.

Picture

Available software options can be used within the picture display to provide overlays for false color, HDR Area, Gamut, Lightmeter or closed caption/subtitles.



Full screen picture display showing currently selected input signal. In this case, this is camera RAW footage and so it appears to be low contrast and desaturated. For camera RAW and HDR inputs a gamma-transfer function and color space conversion can be applied with option PROD.



Closed Captions or subtitles can be decoded and displayed in CEA 608/708 or OP47/ST2031 with the ENG-QC option.

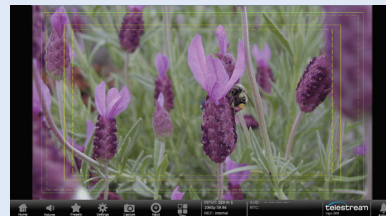

AFD information and graticule can be overlaid within the picture display. Additionally, the user can configure safe area graticules along with a center marker that can be used to help operators compose the image.



For HDR the False Color overlay can be used to identify the luma level of the signal with user defined limits for each color overlay with option PROD.

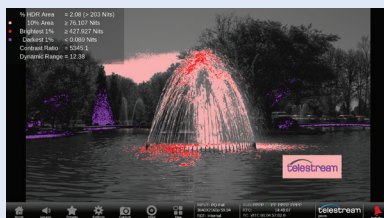

For HDR application determine the Area above the reference white threshold is critical with user thresholds and simple color overlays available in option PROD.



Lightmeter provides relative exposure values in Stops or Nits with up to five cursors that can be position within the image available with option PROD.

Video Session

Video Session provides format information for an SDI input the display shows SDI Format, SMPTE 352 Video Payload ID, Bit Level monitoring and CRC Status.

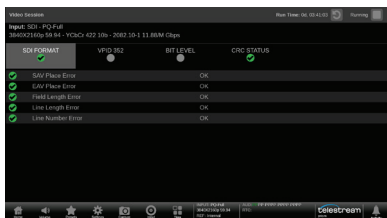

Check for format issues in the SDI Format page with indication of errors for SAV/EAV placement, Field Length, Line Length and Line Number.

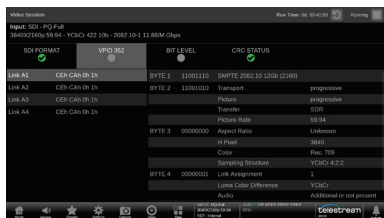

VPID 352 page provides interpretation of the format of the signal such as transport, picture rate, aspect ratio, color, sampling structure and bit depth.

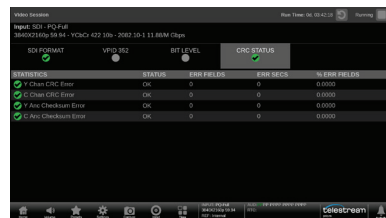

Bit Level page can be used to identify stuck bits within the signal or help determine 8-bit or 10-bit format. While the CRC Status provides checksum indication for Luma Chroma and ANC.



Audio Display

The Audio Display provides an array of tools to monitor audio levels, audio session with Lissajous, Loudness and RTW Surround displays. Audio bars are part of the standard applications. Requires option AUD to enable Phase display, Session and Loudness measurements, and requires option SRND to enable surround display



The audio display can be configured for a variety of audio bars (up to 32 channels for 8K formats and 16 channels for IP and other SDI formats). The audio session display provides information on a variety of parameters for audio level, clips, mute, silence and peaks.

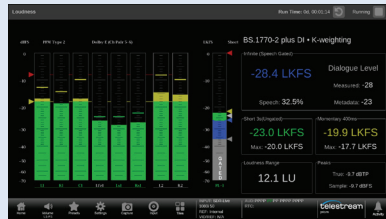

The Loudness measurement can sum a number of audio bars to produce the overall short and Infinite loudness values. Configurations are available for EBU R128 or ATSC A/85 with or without Dialog Intelligence. Option DLBY is required to decode Dolby E and D/D+ formats.



The RTW Surround sound display is available with option SRND. This display provides level and phase information for the interaction of multi-channel audio for Left, Right, Center, Left and Right Surround channels.



Event Log

Event Log shows a list of information related to Alarm events or status information that can be logged relative to Timecode or Precision Time Protocol (PTP).

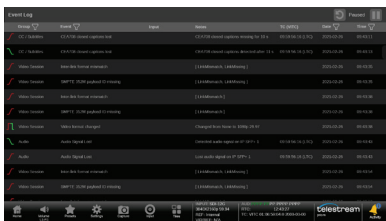

General list of events related to timecode. The Activity icon provides a Dashboard of Alarms with simple green, yellow and red indicators to show the current status of these values.

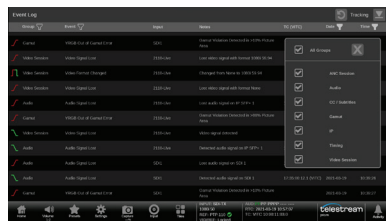

Ability to sort this list relative to Groups or Events that allows the user to specify an alarm of interest and determine when they occurred.

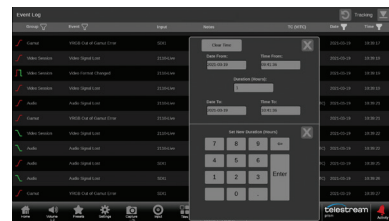

Ability to sort the list over a duration of time so the user can look at the last hour of events.



Timing Display

The Timing Display provides an intuitive way to monitor the currently selected input video timing against a reference signal either Black Burst or Tri-level Sync or Precision Time Protocol (PTP).

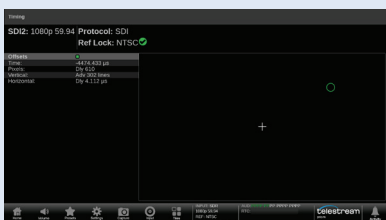

The Timing rectangle window represent the video frame. The Crosshairs shows the timing Center and the circle shows the offset timing of the input signal relative to the reference that is selectable between Black Burst, Tri-Level Sync or Precision Time Protocol (PTP).



With Quad input the Inter-Channel Timing can be shown for the reference signal A against the other inputs B,C and D.



The Timing display can show the offset between the input signal and the reference. In this case we have IP input with a Precision Timing Protocol reference showing Domain and Grandmaster ID.



IP Status

IP Status display provides a simple monitoring of the IP streams present on SFP port 1 & 2 of PRISM and provides useful information on the type of streams present.

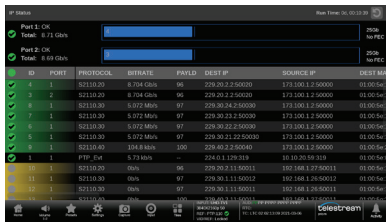

The IP Status provides indication of the amount of data used on each SFP Port 1 & 2. Simple Green, Yellow and Red indicators can alert the user to issues with a stream.

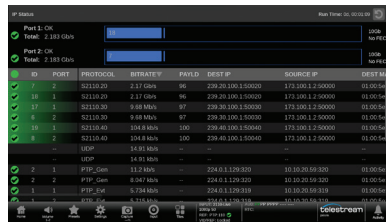

The IP Status provides information on Protocol, Bitrate, Payload Type, IP and MAC Addresses.

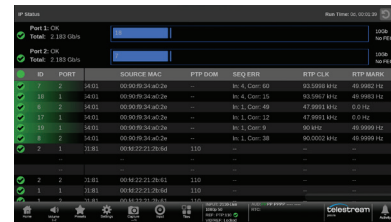

Scrolling to the right of the IP Status window shows PTP domain, RTP marker frequency.



IP Session

IP Session shows information for Layer 1 & 2, Video, Audio, Data, PTP and NMOS. The user can verify data streams and check syntax information. Requires option IP-MEAS to be installed in the instrument.

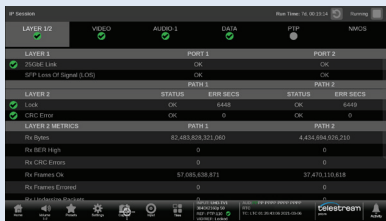

The Layer 1 & 2 show link status along with Layer 2 Metrics for Received Bytes, CRC Errors or Frames Errors and indication of Undersized Packets.

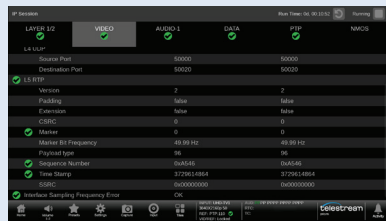

The Video tab shows IP address, port number and RTP Layer 5 information such as Marker, Payload Type, Sequence Number and Timestamp.



The Audio tab shows shows IP address, port number and RTP Layer 5 information such as Marker, Payload Type, Sequence Number and Timestamp.



The Data tab shows shows IP address, port number and RTP Layer 5 information such as Marker, Payload Type, Sequence Number and Timestamp.

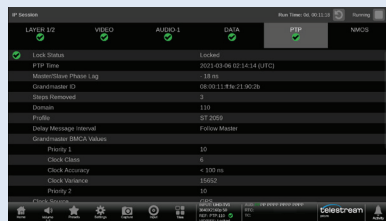

This display provides PTP syntax information including Grandmaster ID, Domain, Clock Class/Accuracy/Variance. Priority 1 & 2 values along with message rates.

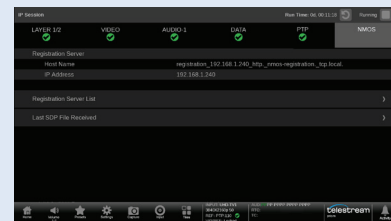

NMOS information is displayed showing NMOS server address and last SDP file sent.



PIT Histogram

Packet Interval Time Histogram shows a distribution of how the packets have arrived at the input to PRISM. Certain types of senders will have a characteristic distribution of the packets that can be helpful in diagnosing issues with streams. Requires option IP-MEAS to be installed in the instrument.

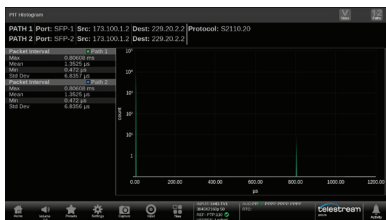

The PIT Histogram can be configured to show Video, Audio or Data streams for ST2110. Here a characteristic PIT Histogram of a ST2110-20 Gapped sender is shown for Path 1-2.

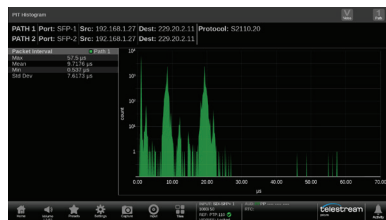

This PIT Histogram shows the characteristics of a Linear Wide Sender that has wide distribution of packets shown by the Min and Max values.

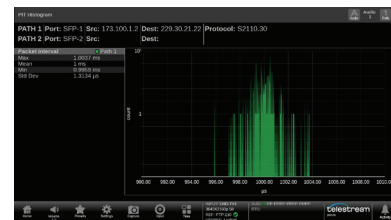

This image shows the PIT Histogram of an Audio Sender being received by PRISM. In this case the Mean packet distribution is 1ms giving an indication of the type of audio being sent.



IP Graphs

IP Graphs allows for metrics of the IP stream to be plotted from 60 seconds to 24 hours. This allows the user to track the health of the stream over time and identify possible errors with the signal. IP graphs provide information on Total Bitrate, Session Bitrate, PIT, RTP Sequence Error and other graphs dependent on the type of stream being decoded. Requires option IP-MEAS to be installed in the instrument.

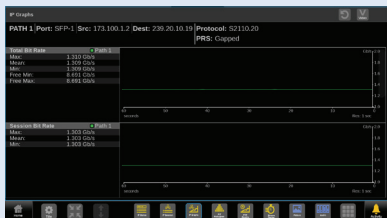

The Total and Session Bit Rate provide indication of the Total bit rate of streams present on the SFP ports of Prism and indicates the decode streams bit rate that can be monitored for up to 24 hours.

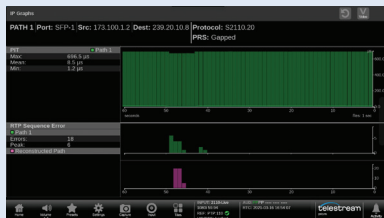

The PIT graphs plots the Packet Interval Time and can show variations within the network. The RTP Sequence Errors shows packet that arrive out of order and whether they can be corrected by the buffer within PRISM.

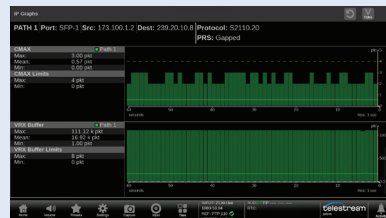

For ST 2110-20 video streams CMAX and VRX Buffer can be plotted over time as specified in ST2110-21.



Stream Timing

Stream Timing can be used to track the timing of the input signal to the PTP reference to ensure that the Sender of the stream is locked to PTP and to track the variations across the network of the stream by PRISM for video, audio and data. Requires option IP-MEAS to be installed in the instrument.



The Video tab shows the Video-PTP offset which is a graphical plot of the Timing displays variation. The Video-RTP offset shows timing of the received signal relative to the embedded RTP time stamp.

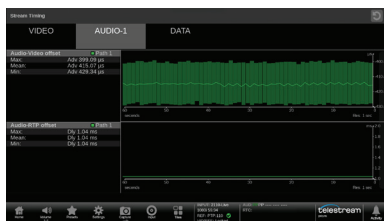

The Audio tab shows the Aud-Video offset that can indicate the amount of delay that must be applied to realign the signals. The Aud-RTP offset shows the timing of the audio stream relative to the embedded RTP time stamps.

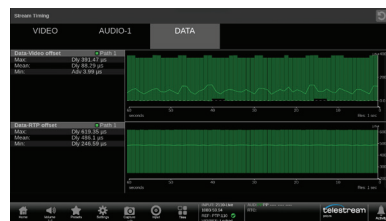

The Data tab shows the Data-Vid offset indicating the relative delay between the data and video stream. In order to realign the signals the delay amount should be applied.



PTP Graphs

PTP Graphs provide a plot of the forward and reverse paths of the PTP messages across the network. The user can select a window between 60 seconds to twenty four hours to monitor the variations over time. Requires option IP-MEAS to be installed in the instrument.

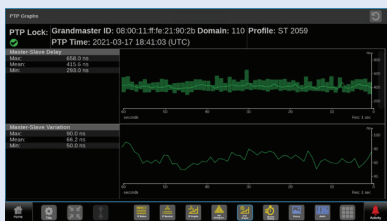

The PTP Graphs shows that PTP is locked on PRISM and shows the Grandmaster ID and the Domain being used. The Master to Slave graphs shows Delay and Variations plotted over the last 60 seconds of the forward path.

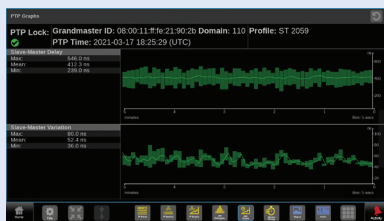

Slave-Master Delay and Variation show the reverse path of PTP messages. This graph was configured to plot over the last 5 minutes. This can be used to observe variation in network traffic that could delay PTP messages in the reverse path.

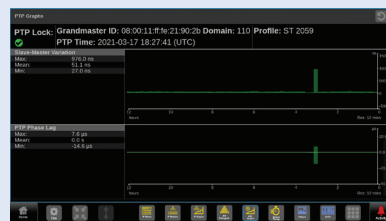

Phase Lag is the phase error of the phase-locked loop that controls the slave clock. This graphs was plotted over the last 12 hours and shows a disturbance about three hours ago.



CIE Display

The CIE display shows the video input plotted as a 1931 or 1976 CIE diagram. This display is used to check the chromaticity of the video signal and determine compliance to the standard color Gamut limits. Requires option PROD to be installed in the instrument

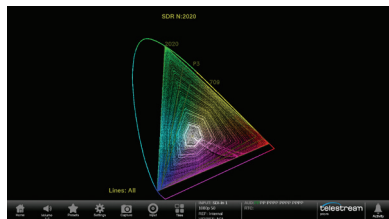

A Rainbow test pattern was applied to the input that contains all the RGB values. The input was configured for 2020 colorspace and the signal fills the 2020 graticule triangle.

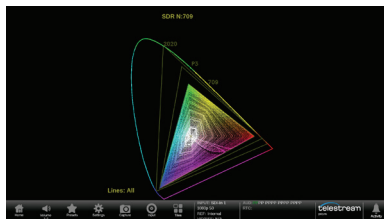

The input was configured for 709 colorspace and a Rainbow test signal was applied containing all the RGB values. You can see the 709 triangle is filled with all the possible colors.

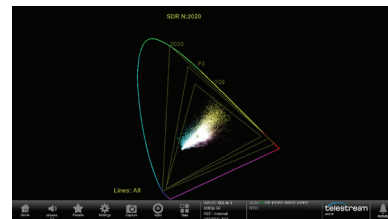

This CIE display is configured for 2020 colorspace with a 12G UHD SDI signal that has been constrained into a P3 colorspace.



Stop Display

The Telestream Stop Display provides a tool to monitor the video signal with a variety of transfer function in a consistent manner. Requires option PROD to be installed in the instrument.

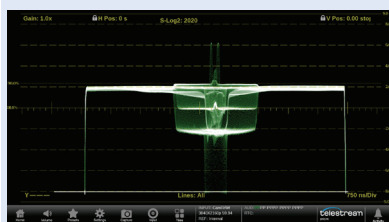

The Stop display is a logarithmic scale based on the input gamma transfer function that is configured. In this case S-Log 2 is setup as the gamma function and the Camera output was adjusted so that the 90% reflectance white and 18% grey levels were setup appropriately on the scale.

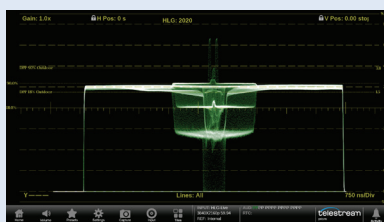

The gamma function on the input was configured for Hybrid Log Gamma (HLG) The input was then adjusted so that the 90% reflectance white and 18% grey level of the test scene were set at the appropriate levels.



In this case the PQ-Narrow gamma curve was used for a live signal. Two tile mode was selected to show NITS scale in 10,000 NITS (left) and Best View (right) that is maximized to a 1,000 NITS scale.



Dolby Status

Dolby Status display decodes the Dolby metadata present within a Dolby ED2, E, D or D+ signal. The AUD option is required and if the user want to decode the Dolby signal option DLBY is required.

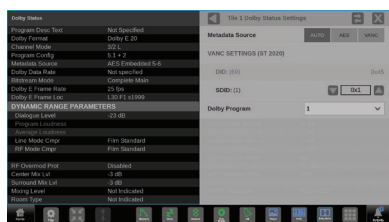

Dolby Status display is available for Dolby metadata present in ANC or within the Dolby signal.

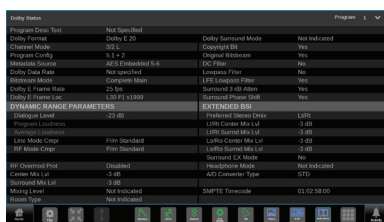

When Dolby E metadata is decoded the Dolby E Frame Location (Guardband) for the start of the metadata is shown within the display. The metadata shows the Dialnorm, Dynamic Range and Downmix parameters of the signal.



When Dolby Digital or Digital Plus is decode information on the Data Rate, Channel & Bitstream Modes are displayed. Along with the metadata parameters for Dialogue Level, Dynamic Range and Downmix.

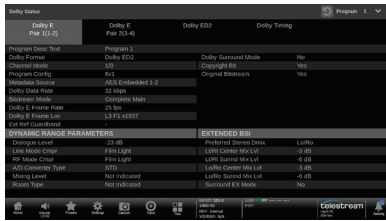

When Dolby ED2 stream is received, Dolby E metadata in pair 1 and pair 2 are displayed in two tabs in Dolby Status display.

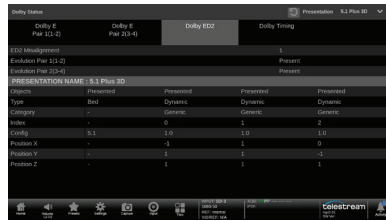

Dolby ED2 tab shows Dolby ED2 metadata including Objects in each Presentation with type and X/Y/Z location information.

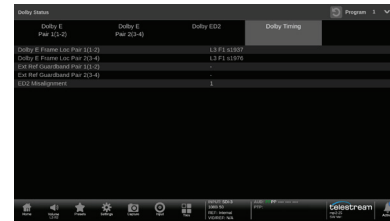

Dolby Timing tab shows Dolby E preamble location in SDI stream and location against house reference signal, BB or PTP.



AES Channel Status

AES Channel Status is available for SDI Embedded audio and provides decoding of the channel status syntax information.

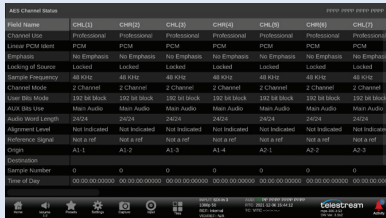

When the Channel Use mode of Professional is used the instrument automatically decodes the syntax as shown above

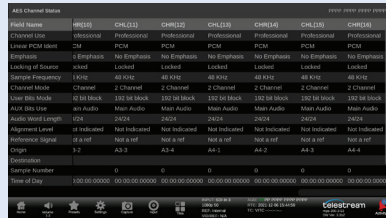

Scrolling horizontally allows the user to see and compare the various embedded audio groups for each of the audio signals present. AES Channel status provides syntax information for parameters such as Emphasis, Locking of Source, Sampling Frequency, Channel Mode and Audio Word Length.

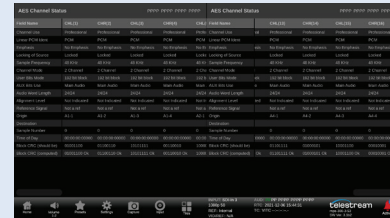

Using the flexible display configurations within PRISM a two-tile display each configured with AES Channel Status displays allows the user to scroll through the syntax information group by group. Allowing the user to easily compare AES Channel Status information for each group that can aid in troubleshooting issues.



Datalist

Datalist display can be used to view the samples of the SDI signals. The user can search through the data for Start of Active Video (SAV) or End of Active Video (EAV) or the next ANC Data packet. Option QC or ENG is required for this application.



Selecting the question mark within the Datalist display shows the color code legend used to identify certain types of data. For instance the switching line is indicated in brown.



The user can search through the data by line and sample location or use the Find function to search for EAV, SAV or ANC within the signal. Simple pressing the sample will provide a tooltip interpretation of the data.

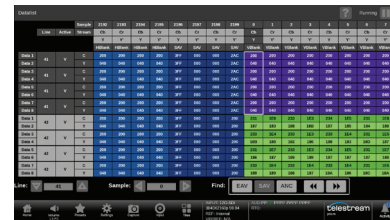

In this case a 12G signal has been applied to PRISM and shows each of the eight virtual streams. Line 41 was selected, and a search was performed to find the Start of Active Video (SAV).



ANC Session

ANC Session provides a Watchlist of the available Ancillary Data types present within the signal. Option QC or ENG is required for this application.

NAME	DID	SDID	LINK	LOCATION(S)	OCCURRENCE	NOTE
SDI2M_VPD	41	1	C	Line 10 Sample 1928	Field	89:48:00:01
SDI2M_VPD	41	1	Y	Line 10 Sample 1928	Field	89:48:00:01
SDI2M_SCTE_104	41	1	Y	Line 9 Sample 1928	Field	89:48:00:01
SDI2M_Anc_TC	60	60	Y	Line 10 Sample 1936	Field	14:16:20:14
SDI2M_VPD	41	1	C	Line 10 Sample 1928	Field	89:48:00:01
SDI2M_VPD	41	1	Y	Line 10 Sample 1928	Field	89:48:00:01
SDI2M_Anc_TC	60	60	Y	Line 9 Sample 1987	Field	15:45:40:04
SDI2M_VPD	41	1	Y	Line 9 Sample 1989	Field	89:48:00:01
SDI2M_VPD	41	1	Y	Line 9 Sample 1992	Field	89:48:00:01
SDI2M_VPD	41	1	Y	Line 9 Sample 1995	Field	89:48:00:01

NAME	DID	SDID	LINK	LOCATION(S)	OCCURRENCE	NOTE
SDI2M_VPD	41	1	Y	Line 10 Sample 1987	2021-03-18 15:53:55	48kHz PPPF Fm 1
SDI2M_VPD	41	1	Y	Line 9 Sample 1995	Field	48kHz PPPF Fm 1
SDI2M_VPD	41	1	Y	Line 9 Sample 1998	Field	48kHz PPPF Fm 1
SDI2M_VPD	41	1	Y	Line 9 Sample 2001	Field	48kHz PPPF Fm 1
SDI2M_VPD	41	1	Y	Line 9 Sample 2004	Field	48kHz PPPF Fm 1
SDI2M_VPD	41	1	Y	Line 9 Sample 2007	Field	48kHz PPPF Fm 1
SDI2M_VPD	41	1	Y	Line 9 Sample 2010	Field	48kHz PPPF Fm 1
SDI2M_VPD	41	1	Y	Line 9 Sample 2013	Field	48kHz PPPF Fm 1
SDI2M_VPD	41	1	Y	Line 9 Sample 2016	Field	48kHz PPPF Fm 1
SDI2M_VPD	41	1	Y	Line 9 Sample 2019	Field	48kHz PPPF Fm 1

NAME	START	END	STATUS
SDI2M_VPD	89:48:00:01	89:48:00:01	Running
SDI2M_VPD	89:48:00:01	89:48:00:01	Running
SDI2M_VPD	89:48:00:01	89:48:00:01	Running
SDI2M_VPD	89:48:00:01	89:48:00:01	Running
SDI2M_VPD	89:48:00:01	89:48:00:01	Running
SDI2M_VPD	89:48:00:01	89:48:00:01	Running
SDI2M_VPD	89:48:00:01	89:48:00:01	Running
SDI2M_VPD	89:48:00:01	89:48:00:01	Running
SDI2M_VPD	89:48:00:01	89:48:00:01	Running
SDI2M_VPD	89:48:00:01	89:48:00:01	Running

The ANC Session Watchlist provide a list of the ANC data packets that are present within the signal showing the DID, SDID, Location and Occurrence within the frame or field. Notes provides additional information on the syntax of the packet.

Simple indicators (Red, Yellow, Green) can be used to identify issues within the ANC packets. Green indicates ANC packet is present and valid. Yellow indicates that the ANC packet was present and shows the last occurrence. Red indicates an error.

SCTE 104 messaging provides a method to indicate when a splice point should occur within the program. This information is carried within an ANC packet with DID 41 & SDID 07. The SCTE 104 tab shows interpretation of the User Data Words.



Eye Display

The Eye Display provides a measurement of the SDI physical layer for Timing and Alignment with automated measurements. The Eye Display feature is available in MPS300 and MPD300 as standard and Requires option PHY for SD/HD/3G SDI for MPD2-25 and MPX2-25. Option FMT-4K to enable the support for 6G and 12G SDI.

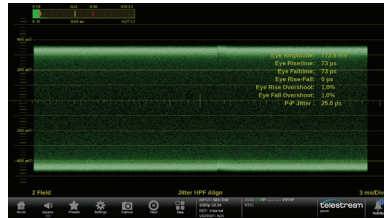
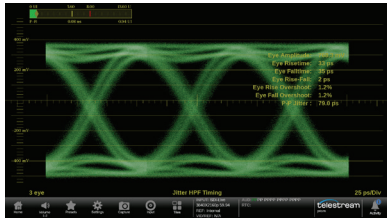
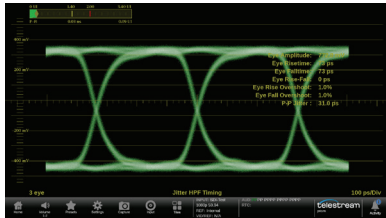

A 3G SDI eye display with a 3G SDI test signal applied to PRISM. With Automated Eye measurements of eye amplitude, rise/fall time and overshoot. The peak to peak jitter measurement is also show with a simple Jitter meter display.

A 3G SDI eye display with a 12G SDI signal from a router output to Prism. The engineer can selectively choose a filter from 10Hz to 100kHz. In this case a 10Hz (Timing) filter has been applied to the signal.

A 3G SDI Pathological signal has been applied to the system and PRISM shows a two field sweep of the eye pattern for this signal.



Jitter Display

The Jitter Display can be used in conjunction with the Eye display to measure the physical layer of the SDI signal. The Jitter Display feature is available in MPS300 and MPD300 as standard and Requires option PHY for SD/HD/3G SDI for MPD2-25 and MPX2-25. Option FMT-4K to enable the support for 6G and 12G SDI.

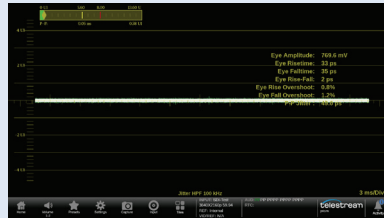
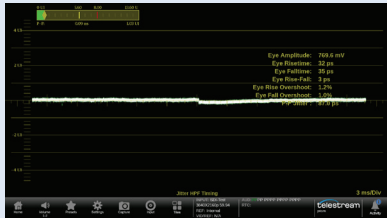
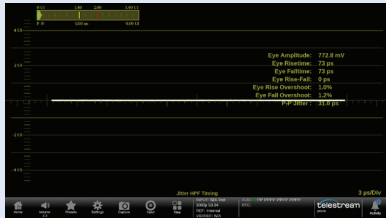

A 3G SDI signal has been applied to PRISM from a test signal source and the resulting 2 line jitter display is shown. The 10Hz Timing filter has been applied and the resulting automated peak to peak jitter is shown.

Various filters can be applied from 10Hz to 100kHz to assess which bandwidths the jitter is present within. Timing jitter uses the 10Hz filter while Alignment jitter uses the 100kHz filter. In this case the Timing jitter filter is applied and the peak to peak jitter value can be measured.

In this case the 100kHz Alignment filter has been applied to the same 12G SDI signal and the resulting peak to peak jitter measurement can be obtained.



AV Delay

AV Delay measurement measures the presentation time difference of audio and video with AV Timing mode test signal (Flash & Pop) generated by Telestream Sync Pulse Generator products. The user can measure lip sync timing of PCM / Dolby over SDI, ST2110 and ST2022-6 signals. Option QC or ENG is required for this application.



AV Delay measures the time difference of 16 channel audio against video simultaneously. Negative number means audio advance and positive number means audio delay.

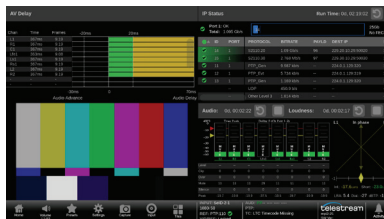

Dolby stream over SDI, ST2022-6, ST2110-30/31 will be internally decoded and measured against video. The labeling for each channel is automatically assigned from Dolby metadata.

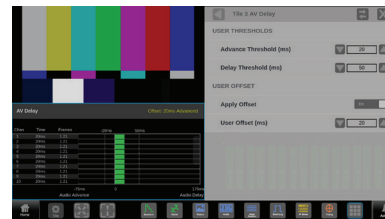

User threshold allows user to set warning level suitable for application. User can also manually add offset for relative measurement between signal paths or system configurations.



IP Generator

IP Generator provides a simple test pattern generator for ST2110 for color bars and audio tones. Requires GEN option.

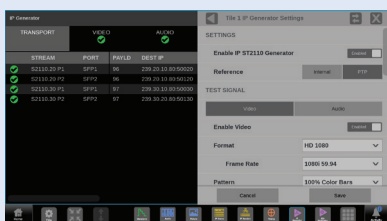

The ST2110 IP Generator can be configured with a 100% color bar test signal in a variety of video formats. The user can enable one or both SFP port to generate the signal with user configured IP address and Payload Type as a Gapped or Narrow sender.

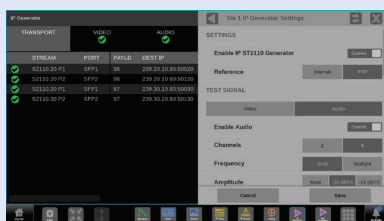

The audio tone generator can produce a 1kHz tone at -18 or -20dBFS or multiple frequency tone and at various levels. The packet time can be varied between 125 µs or 1ms with user configured IP address and Payload Type.

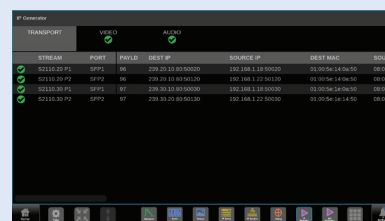

The IP Generator display shows the status of the configuration for the Transport, Video and Audio. The test signal can either be static or scroll horizontally.



SDI Generator

SDI Generator provides a simple test pattern generator with color bar test signal. Requires GEN option.

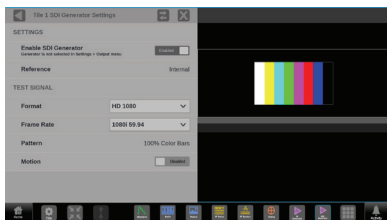

The user can configure a 100% Color Bar test signal to be generated in a variety of video formats from the SDI AUX output. Make sure to enable the Generator in the Output settings.

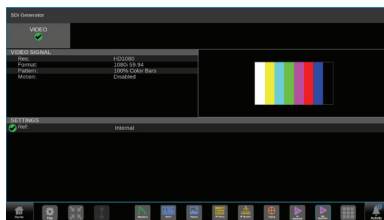

The SDI Generator Status display shows the configuration of the Test signal generator and a green tick indicator shows that the signal is enabled.

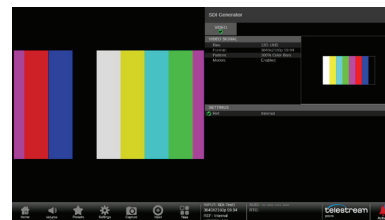

Motion can be enabled for the Test signal generator which will produce a horizontal scroll of the test pattern, to check that the device is processing the signal correctly.

PRISM

Family Tech Specs



The PRISM Family



MPI Model



MPX Model



MPS Model



MPD Model

Model	Form Factor	Depth	Interface	SDI Inputs Capability (4 x 12G SDI)*	IP Inputs Capability (2 x 10G/25G)*	Eye Measurement capability (12G SDI)*	Format Support (SD,HD,3G,4K,8K)*	Power Input
MPI2-25	3RU,Half-Rack	10.5"	1920 x 1080 9" Touchscreen x 1	Standard	Standard	Option	Standard	AC
MPX2-25	1RU, Full-rack	16.5"	External Monitor	Standard	Standard	Option	Standard	AC
MPS-100	3RU, Half-rack	5"	1920 x 1080 9" Touchscreen x 1	Standard	X	X	Standard	AC/DC
MPS-200	3RU, Half-rack	5"	1920 x 1080 9" Touchscreen x 1	Standard	Standard	X	Standard	AC/DC
MPS-300	3RU, Half-rack	5"	1920 x 1080 9" Touchscreen x 1	Standard	Standard	Standard	Standard	AC/DC
MPD-100	3RU, Full-rack	5"	1920 x 1080 9" Touchscreen x 2	Standard	X	X	Standard	AC
MPD-200	3RU, Full-rack	5"	1920 x 1080 9" Touchscreen x 2	Standard	Standard	X	Standard	AC
MPD-300	3RU, Full-rack	5"	1920 x 1080 9" Touchscreen x 1	Standard	Standard	Standard	Standard	AC

* May require options to enable higher resolutions and bandwidths

Video Format Support

Supported SDI video formats

Link	Format	Sample Structure	Bits	Frame/field rate	Audio	Option
SD-SDI	525i	4:2:2 YCbCr	10b	59.94i	16ch	Standard
	625i	4:2:2 YCbCr	10b	50i	16ch	Standard
HD-SDI	1280x720	4:2:2 YCbCr	10b	23.98/24/25/29.97/30/50/59.94/60p	16ch	Standard
	1920x1080	4:2:2 YCbCr	10b	50/59.94/60i, 23.98/24/25/29.97/30p, and psF	16ch	Standard
	2048x1080	4:2:2 YCbCr	10b	29.97/30p, and psF	8ch	Standard
	2048x1080	4:2:2 YCbCr	10b	23.98/24/25p, and psF	16ch	Standard
3G SDI Level A	1920x1080	4:2:2 YCbCr	10b	50/59.94/60p	16ch	Standard
	2048x1080	4:2:2 YCbCr	10b	47.95/48/50/59.94/60p	16ch	Standard
	1920x1080	4:4:4 RGB	10/12b	23.98/24/25/29.97/30p	16ch	PROD*
3G SDI Level B	2048x1080	4:4:4 RGB	10/12b	23.98/24/25/29.97/30p	16ch	PROD*
	1920x1080	4:2:2 YCbCr	10b	50/59.94/60p	16ch	Standard
	2048x1080	4:2:2 YCbCr	10b	59.94/60p	8ch	Standard
	2048x1080	4:2:2 YCbCr	10b	47.95/48/50p	16ch	Standard
	1920x1080	4:4:4 RGB	10/12b	23.98/24/25/29.97/30p	16ch	PROD*
Quad Link HD-SDI Square Division	2048x1080	4:4:4 RGB	10/12b	29.97/30p	8ch	PROD*
	2048x1080	4:4:4 RGB	10/12b	23.98/24/25p	16ch	PROD*
	3840x2160	4:2:2 YCbCr	10b	23.98/24/25/29.97/30p, and psF	16ch from Link A	FMT-4K*
	4096x2160	4:2:2 YCbCr	10b	23.98/24/25p, and psF	16ch from Link A	FMT-4K*
Quad Link 3G-SDI Level A, Square Division	4096x2160	4:2:2 YCbCr	10b	29.97/30p, and psF	8ch from Link A	FMT-4K*
	3840x2160	4:2:2 YCbCr	10b	50/59.94/60p	16ch from Link A	FMT-4K*
	4096x2160	4:2:2 YCbCr	10b	47.95/48/50/59.94/60p	8ch from Link A	FMT-4K*
	3840x2160	4:4:4 RGB	10/12b	23.98/24/25/29.97/30p	16ch from Link A	FMT-4K* and PROD*
Quad Link 3G-SDI Level B, Square Division	4096x2160	4:4:4 RGB	10/12b	23.98/24/25/29.97/30p	16ch from Link A	FMT-4K* and PROD*
	3840x2160	4:2:2 YCbCr	10b	50/59.94/60p	16ch from Link A	FMT-4K*
	4096x2160	4:2:2 YCbCr	10b	47.95/48/50/59.94/60p	8ch from Link A	FMT-4K*
Quad Link 3G-SDI Level A, Two Sample Interleave	3840x2160	4:4:4 RGB	10/12b	23.98/24/25/29.97/30p	16ch from Link A	FMT-4K* and PROD*
	4096x2160	4:4:4 RGB	10/12b	23.98/24/25/29.97/30p	16ch from Link A	FMT-4K* and PROD*
	3840x2160	4:2:2 YCbCr	10b	50/59.94/60p	16ch from Link A	FMT-4K*
	4096x2160	4:2:2 YCbCr	10b	47.95/48/50/59.94/60p	8ch from Link A	FMT-4K*
Quad Link 3G-SDI Level B, Two Sample Interleave	3840x2160	4:4:4 RGB	10/12b	23.98/24/25/29.97/30p	16ch from Link A	FMT-4K* and PROD*
	4096x2160	4:4:4 RGB	10/12b	23.98/24/25/29.97/30p	16ch from Link A	FMT-4K* and PROD*
	3840x2160	4:2:2 YCbCr	10b	23.98/24/25/29.97/30p	16ch	FMT-4K*
6G-SDI	4096x2160	4:2:2 YCbCr	10b	23.98/24/25p	16ch	FMT-4K*
	4096x2160	4:2:2 YCbCr	10b	29.97/30p	8ch	FMT-4K*
	3840x2160	4:2:2 YCbCr	10b	50/59.94/60p	16ch	FMT-4K*
12G-SDI	4096x2160	4:2:2 YCbCr	10b	47.95/48/50/59.94/60p	16ch	FMT-4K*
	3840x2160	4:4:4 RGB	10/12b	23.98/24/25/29.97/30p	16ch	FMT-4K* and PROD*
	4096x2160	4:4:4 RGB	10/12b	23.98/24/25p	16ch	FMT-4K* and PROD*
	4096x2160	4:4:4 RGB	10/12b	29.97/30p	8ch	FMT-4K* and PROD*
Quad Link 12G-SDI, Two Sample Interleave	7680x4320	4:2:2 YCbCr	10b	50/59.94/60p	32ch from Link A/B	FMT-8K*

* When ordering MPI2-25 and MPX2-25 add a prefix MP2- for the specific option for example FMT-4K would be MP2-FMT-4K. When ordering MPS Series or MPD series add a prefix MPSDP- for the specific option for example FMT-4K would be MPSDP-FMT-4K.

Supported video formats in SMPTE 2022-6 Streams

Link	Format	Sample Structure	Bits	Frame/field rate	Option
SD-SDI	525i	4:2:2 YCbCr	10b	59.94i	Standard
	625i	4:2:2 YCbCr	10b	50i	Standard
HD-SDI	1920x1080	4:2:2 YCbCr	10b	50/59.94/60i, 23.98/24/25/29.97/30p, and psF	Standard
	1280x720	4:2:2 YCbCr	10b	23.98/24/25/29.97/30/50/59.94/60p	Standard
3G SDI Level A	1920x1080	4:2:2 YCbCr	10b	50/59.94/60p	Standard
3G SDI Level B	1920x1080	4:2:2 YCbCr	10b	50/59.94/60p	Standard

Not available for MPS-100 and MPD-100

Supported ST2110-20 video formats

Link	Format	Sample Structure	Bits	Frame/field rate	Option
ST2110-20	525i	4:2:2 YCbCr	10b	59.94i	Standard
	625i	4:2:2 YCbCr	10b	50i	Standard
	1280x720	4:2:2 YCbCr	10b	23.98/24/25/29.97/30p	Standard
	1280x720	4:2:2 YCbCr	10b	50/59.94/60p	Standard
	1920x1080	4:2:2 YCbCr	10b	23.98/24/25/29.97/30p, and psF, 50/59.94/60i, 50/59.94/60p	Standard
	2048x1080	4:2:2 YCbCr	10b	23.98/24/25/29.97/30/50/59.94/60p	Standard
	3840x2160	4:2:2 YCbCr	10b	50p	FMT-4K*
	3840x2160	4:2:2 YCbCr	10b	59.94/60p	FMT-4K* and *-25GE
	4096x2160	4:2:2 YCbCr	10b	23.98/24/25/29.97/30/50/59.94/60p	FMT-4K*
	4096x2160	4:2:2 YCbCr	10b	59.94/60p	FMT-4K* and *-25GE

Not available for MPS-100 and MPD-100

* When ordering MPI2-25 and MPX2-25 add a prefix MP2- for the specific option for example FMT-4K would be MP2-FMT-4K. When ordering MPS Series or MPD series add a prefix MPSDP- for the specific option for example FMT-4K would be MPSDP-FMT-4K.

SMPTE 2110-30/31 Streams

Conformance level	Description
Conformance level A	Reception of 48 kHz streams with from 1 to 8 channels at packet times of 1 ms
Conformance level B	Reception of 48kHz streams with 1 to 8 channels at packet times of 1 ms or 1 to 8 channels at packet times of 125 μs

Reception of 48kHz streams with 16 channels at packet times of 125 μs

Not available for MPS-100 and MPD-100

PRISM instruments with 25GE module have up to four ST2110 30 streams of reception with up to 16 audio channels total. One of four streams can be replaced with ST2110-31.

SMPTE 2110-40 Stream

PRISM supports one ST2110-40 stream with multiple ANC packets.

Not available for MPS-100 and MPD-100

Connectivity and Instrument Dimensions

MPI2-25 Connectivity

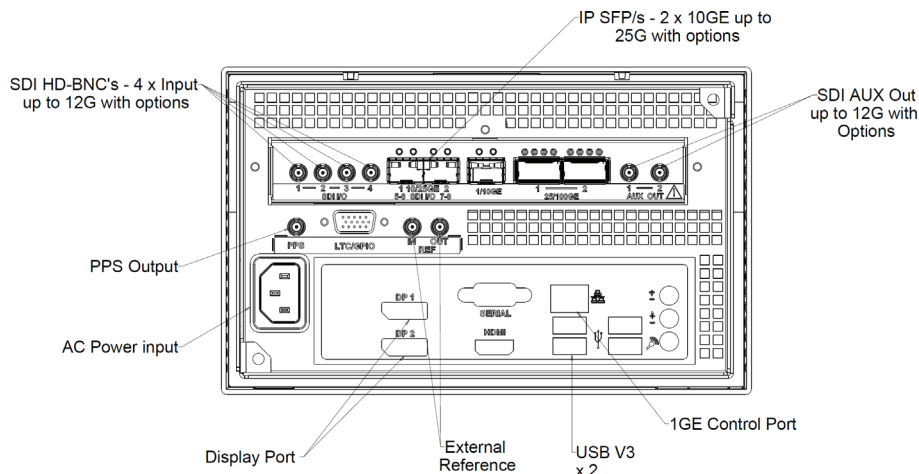

MPI2-25 Physical Data

Dimensions

Height (includes Bezel)	13.64 cm (5.37 in.)
Width (includes Bezel)	22.10 cm (8.70 in.)
Depth	29.82 cm (11.74 in.)
Weight	3.40 Kg (7.45 lbs)

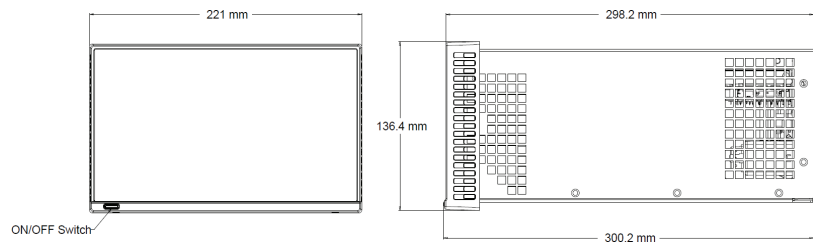

MPX2-25 Connectivity

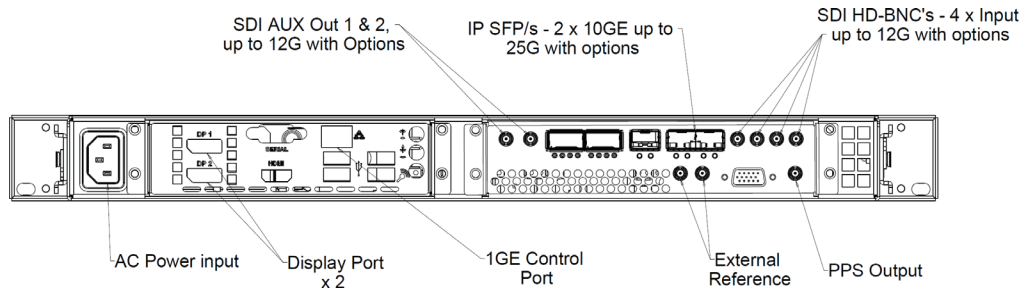

MPX2-25 Physical Data

Dimensions

Height	04.45 cm (1.75 in.)
Width	48.26 cm (19.00 in.)
Depth	42.14 cm (16.59 in.)
Weight	3.90 Kg (8.7 lbs.)

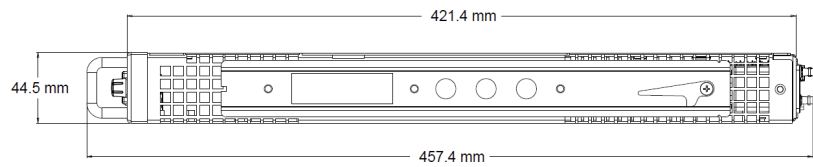

MPS-100 Connectivity

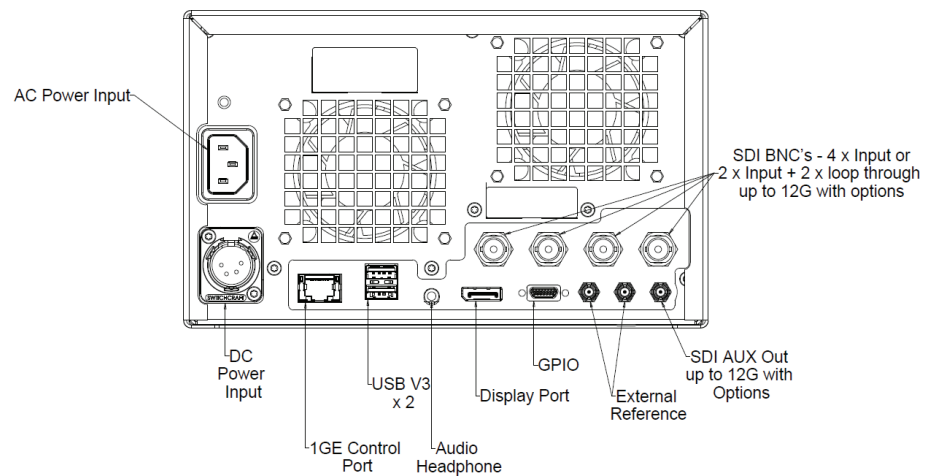

MPS-100 Physical Data

Dimensions

Height	13.30 cm (5.24 in.)
Width	22.00 cm (8.66 in.)
Depth (inc. Connectors)	13.07 cm (5.15 in.)
Weight	2.77 Kg (6.1 lbs.)

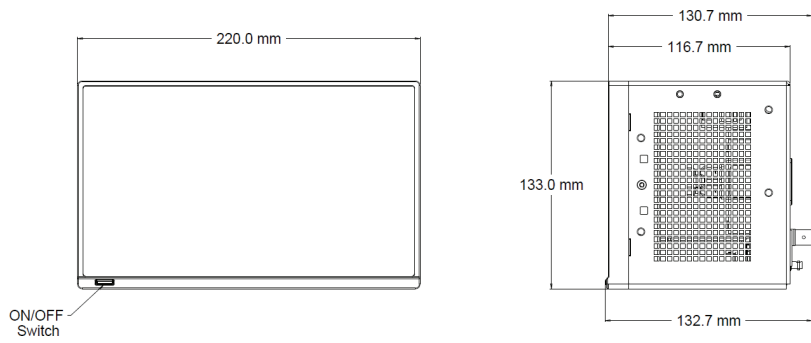

MPS-200/300 Connectivity

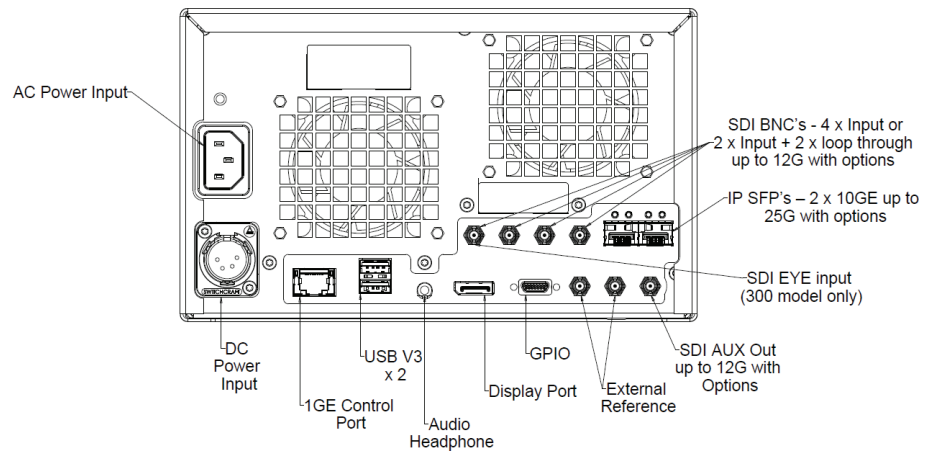

MPS-200/300 Physical Data

Dimensions

Height	13.30 cm (5.24 in.)
Width	22.00 cm (8.66 in.)
Depth (inc. Connectors)	12.46 cm (4.91 in.)
Weight	2.77 Kg (6.1 lbs.)

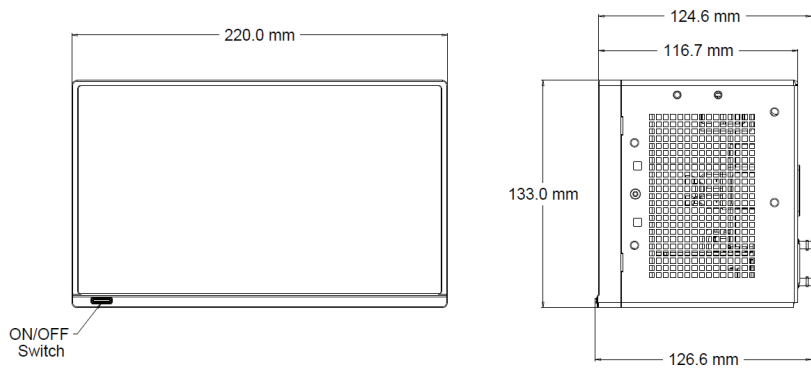

MPD-100
Connectivity

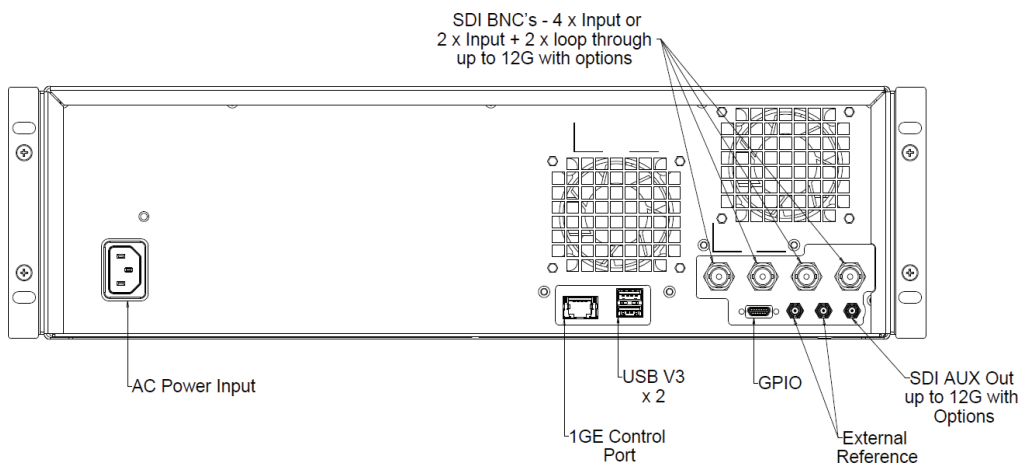

MPD-100 Physical Data

Dimensions

Height	13.30 cm (5.24 in.)
Width	44.50 cm (17.52 in.)
Depth (inc. Connectors)	13.07cm (5.15 in.)
Weight	3.95 Kg (8.7 lbs.)

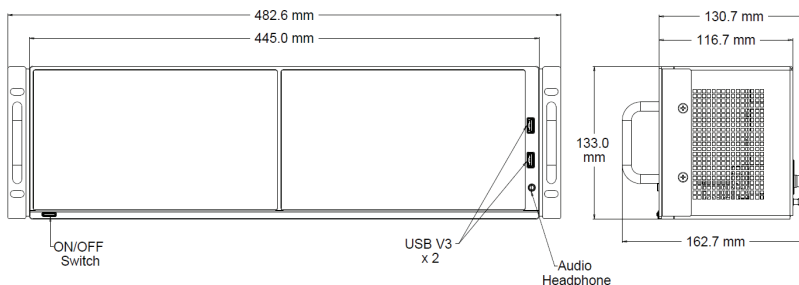

MPD-200/300
Connectivity

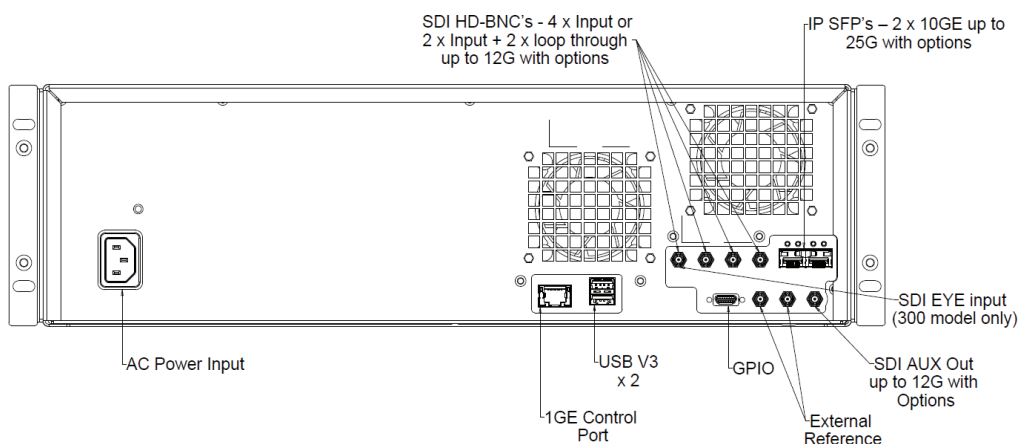

MPD-200/300 Physical Data

Dimensions

Height	13.30 cm (5.24 in.)
Width	44.50 cm (17.52 in.)
Depth (inc. Connectors)	12.46cm (4.91 in.)
Weight	3.95 Kg (8.7 lbs.)

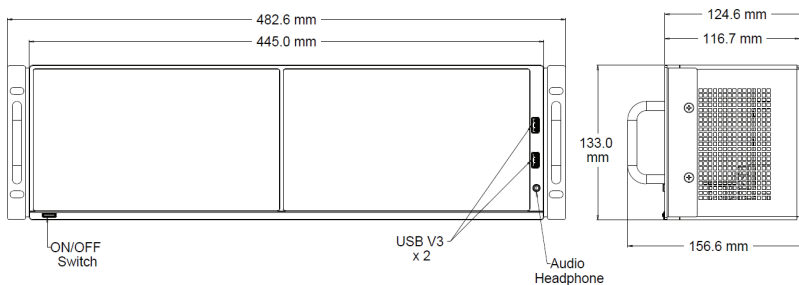

Power Characteristics

MPI2-25

Power Consumption

Typical	100 W
Maximum	180 W
Voltage Range	100 to 240 VAC +/- 10%, 50/60 Hz

MPX2-25

Power Consumption

Typical	100 W
Maximum	180 W
Voltage Range	100 to 240 VAC +/- 10%, 50/60 Hz

MPS-100/200/300

Power Consumption

Typical	95 W/100 W/105 W
Maximum	160 W
Voltage Range	100 to 240 VAC +/- 10%, 50/60 Hz

MPD-100/200/300

Power Consumption

Typical	105 W/110 W/115 W
Maximum	160 W
Voltage Range	100 to 240 VAC +/- 10%, 50/60 Hz

AUX SDI Output Characteristics (Generator Mode)

Output Level

800 mV +/- 10% into 75 Ω Load

Weight and Packaging Dimensions

MPI2-25 Packaging Data

Dimensions

Height	41.91 cm (16.50 in.)
Width	45.09 cm (17.75 in.)
Depth	50.17 cm (19.75 in.)
Weight	7.00 Kg (15.43 lbs)

MPX2-25 Packaging Data

Dimensions

Height	29.21 cm (11.50 in.)
Width	64.14 cm (25.25 in.)
Depth	73.03 cm (28.75 in.)
Weight	9.30 Kg (20.50 lbs)

MPS-100/200/300 Packaging Data

Dimensions

Height	30.5 cm (12.0 in.)
Width	38.1 cm (15.0 in.)
Depth	27.9 cm (11.0 in.)
Weight	4.2 Kg (9.2 lbs)

Subject to change

MPD-100/200/300 Packaging Data

Dimensions

Height	30.5 cm (12.0 in.)
Width	61.0 cm (24.0 in.)
Depth	27.9 cm (11.0 in.)
Weight	6.0 Kg (13.2 lbs)



























Subject to change

Ordering Information - Options and Applications









Base Model Selection



Model	Notes
MPI2-25	PRISM, MPI2-25; 3RU half rack; 4 SDI Inputs; 2 SFP+ for 10GE. 25GE support requires MP2 25GE license.
MPX2-25	PRISM, MPX2-25; 1RU full rack; 4 SDI Inputs; 2 SFP+ for 10GE. 25GE support requires MP2 25GE license.
MPS-100	PRISM, MPS-100; 3RU half rack, short depth, SDI Waveform Monitor base unit with integrated touchscreen
MPS-200	PRISM, MPS-200; 3RU half rack, short depth, SDI and IP Waveform Monitor base unit with integrated touchscreen
MPS-300	PRISM, MPS-300; 3RU half rack, short depth, SDI and IP Waveform Monitor with SDI EYE base unit with integrated touchscreen
MPD-100	PRISM, MPD-100; 3RU full rack, short depth, SDI Waveform Monitor base unit with dual integrated touchscreens
MPD-200	PRISM, MPD-200; 3RU full rack, short depth, SDI and IP Waveform Monitor base unit with dual integrated touchscreens
MPD-300	PRISM, MPD-300; 3RU full rack, short depth, SDI and IP Waveform Monitor with SDI EYE base unit with dual integrated touchscreens

Application Summary

Notes	Applications
Standard Applications (All Models)	       
Optional Applications (All Models)	          
Optional Applications for MPS/MPD-200/300, MPI2-25 and MPX2-25	     
Physical Layer Applications. Standard on-MPS/MPD 300. Optional on MPI2-25 and MPX2-25	 

Software Options

PRISM Options	Description	Applications Enabled
AUD*	License; PRISM, MPI2, MPX2, MPS and MPD Models, Add Software license for enhanced Audio feature sets: includes Phase, Session, Correlation, Loudness, AES Channel Status, Loudness, Dolby E and D metadata display	  
SRND*	License; PRISM, MPI2, MPX2, MPS and MPD Models, Add software license for Audio Surround Sound Displays (Must have Option AUD installed)	
DLBY*	License; PRISM, MPI2, MPX2, MPS and MPD Models, Add Software license for Dolby E and Dolby D decoding.	
ENG-QC**	License; For PRISM, MPI2, MPX2, MPS and MPD Models add this software license to enable the Engineering and QC feature sets. These include: Datalist, Closed Captions (ARIB B-37, CEA608/CEA708) / Teletext decode (OP47/ST2031), ANC Session, AV Delay and EBU R103 Gamut monitoring.	  
GEN*	License; PRISM, MPI2, MPX2, MPS and MPD Models, Add Software license for SDI/IP signal generator; includes IP/SDI Generator application.	 





PROD*	License; PRISM, MPI2, MPX2, MPS and MPD Models, Add Software license for Production feature sets: includes Stop display, Light meter, HDR/WCG Conversion, CIE chart, False color and HDR measurement	 
-------	--	--

MULTI*	License; PRISM, MPI2, MPX2, MPS and MPD Models, Add software license for multi-channel input support
EXTNDSP*	License; PRISM, MPI2, MPX2, and MPS Models, Add software license for enabling extended desktop.

* Requires prefix of either MP2- or MPSDP- for ordering



** For ENG-QC option use MPSDP-ENG-QC for MPS/MPD models and MP2-ENG for MPI2/MPX2 models

IP Measurement Options

Option	Description	Applications Enabled
IP-MEAS*	Add Software license for IP Measurement feature sets: includes IP/PTP Graph, IP/PTP Session, PIT Histogram, Timing, Stream Timing and Stream capture applications.	    

* Requires prefix of either MP2- or MPSDP- for ordering

Physical Layer Measurement Options

Option	Description	Applications Enabled
PHY*	SDI Physical Layer Measurement Package (incl. automated measurement of 12G/6G/3G/HD/SDI Eye pattern parameters and jitter parameters; jitter waveform display). FMT-4K license required for 12G/6G-SDI support	 

* Standard on-MPS/MPD 300. Optional on MPI2-25 and MPX2-25

Speaker Options (MPX2-25 Only)

MPX2-25	Description
MPX2-25 SPKR	Adds integrated stereo speaker set, no field upgrade kit is available

Format Support Options

Option	Description
FMT-4K*	License; PRISM, MPI2, MPX2, MPS and MPD Models, Add Software license for 4K formats and enable 6G/12G SDI.
FMT-8K*	License; PRISM, MPI2, MPX2, MPS and MPD Models, Add Software license for 8K formats in Quad 12G SDI
25GE*	License; PRISM, MPI2, MPX2, MPS and MPD Models, Add Software license for 25GE support

* Requires prefix of either MP2- or MPSDP- for ordering

Racks Mount Kits and Accessories

**MPS-100/200/300
Options**

Option	Description
MPS-PTBL	PRISM MPS model, Portable Accessory kit includes handle, feet, protective front cover, tripod mount bracket and bracket for battery mount plate (battery, battery mount plate and tripod not included)
MPS-RACK	PRISM MPS model, Rack mounting kit with USB cables (not for use with MPD Models)

MPS-PTBL - Portable Accessory Kit (Instrument not incl.)

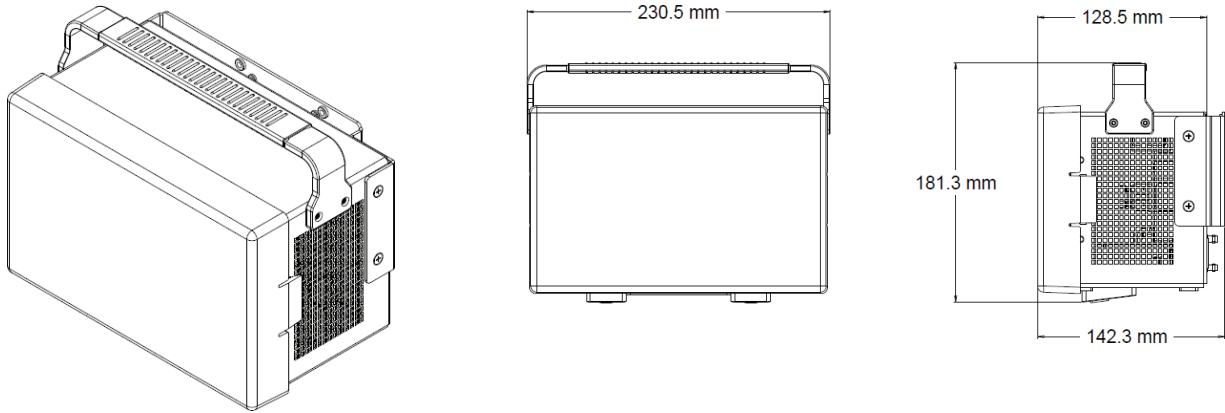

MPS-RACK - Accessories for mounting a single MPS (Instrument not incl.)

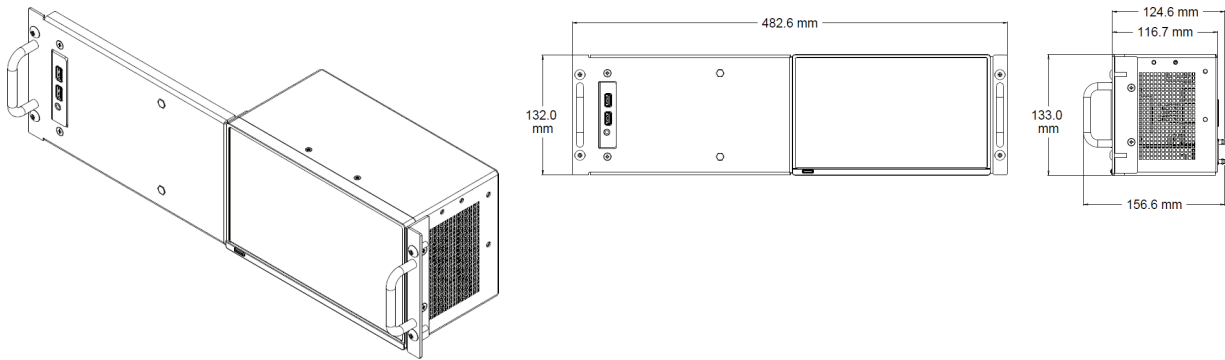

MPS-RACK - Accessories for mounting two MPS units (Instrument not incl.)

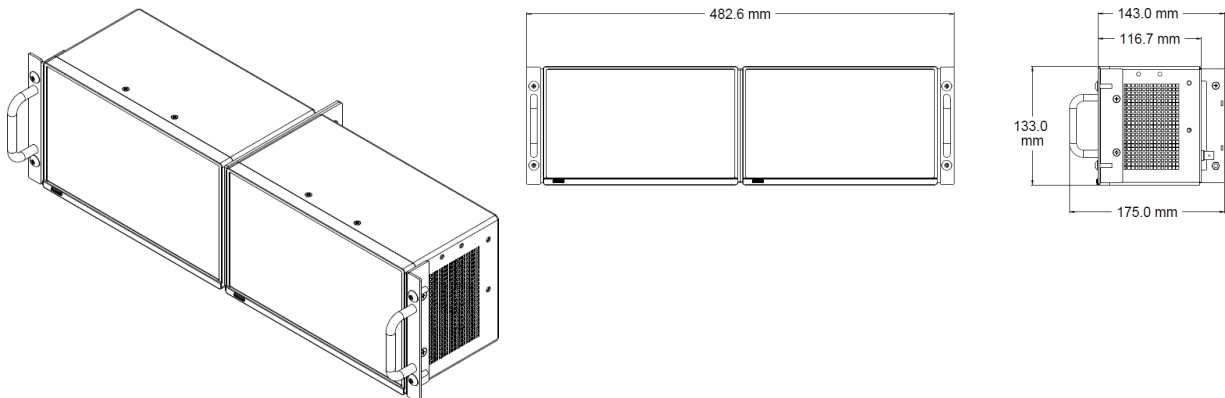

**MPD-100/200/300
Rack Options**

Option	Description
Standard	PRISM MPD model, Rack Mounting ears provided as standard with the instrument.

MPI2-25 Options

Option	Description
MPI2-PTBL	PRISM MPI2, Portable cabinet with handle, feet, Tile bail and protective front cover
MPI-RACK-MM	19 inch, 3RU dual rack cabinet for one MPI unit or two MPI units in a side by side installation, includes front panel USB/headphone connectors for each MPI unit
MPI-RACK-MW	19 inch, 3RU dual rack cabinet for one MPI unit or one MPI unit in a side by side installation with a WFM52x0, WFM7200, WFM8x00 instrument, includes front panel USB/headphone connectors for one MPI unit

MPI2-PTBL

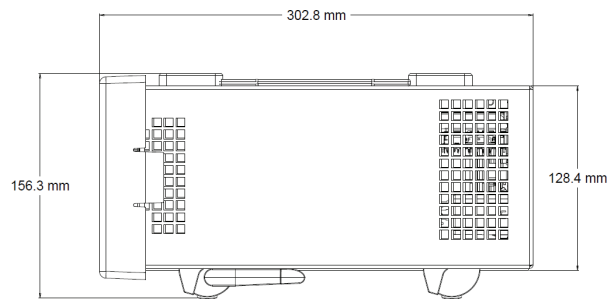
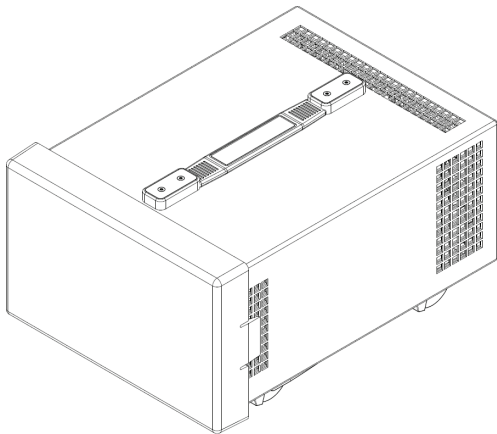

MPI-RACK-MM

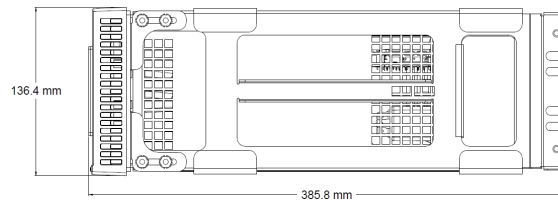
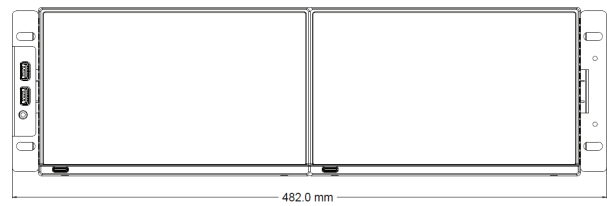
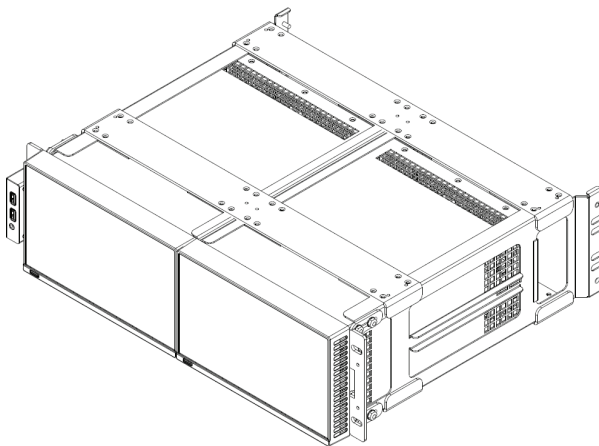

MPI-RACK-MW

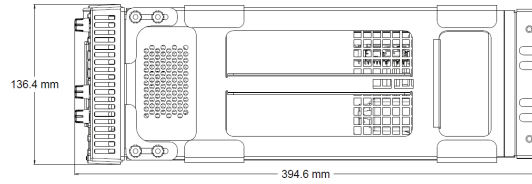
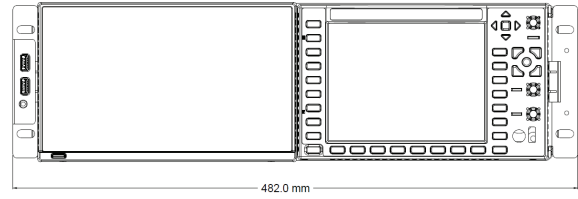
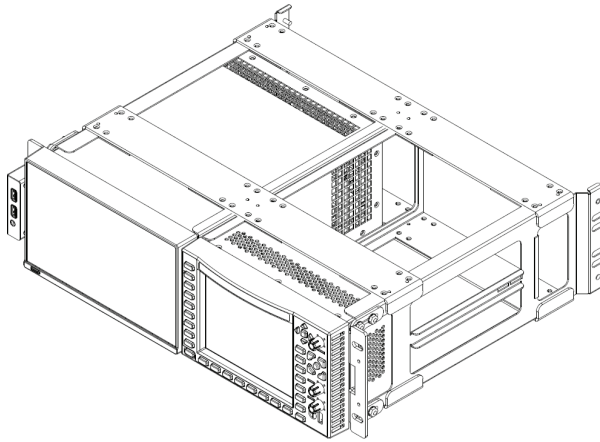

MPX2-25 Rack Options

Option	Description
MPX2-25 RACK	PRISM MPX2-25, Rackmount slides and rails kit for MPX2

MPX2-25 RACK

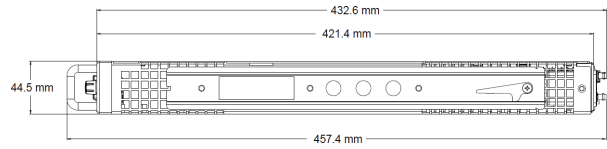
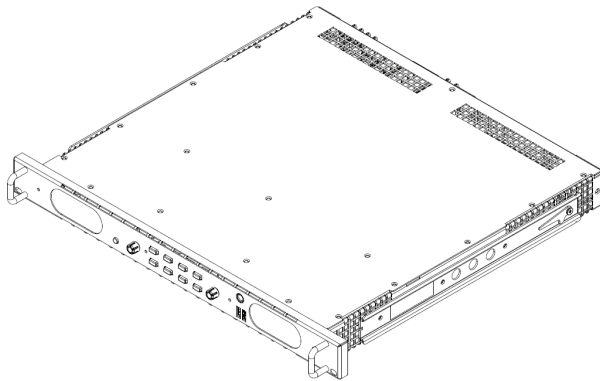

Cable Options

Cable Options	Option	Description
	MP-CBL DUALDSP	PRISM A cable kit for MPX2 DUALDSP, Two sets of 2 M DisplayPort male to DisplayPort male cable and 2 M USB 3.0 A male to B male cable
	MP-CBL HDBNC-BNC	PRISM Coaxial adapter cables from high density male BNC connector to standard female BNC connector (a set of 3 cables, 75 Ω, 0.5 M long)

Power Cord for MPS/MPD models	Model	Description
	PWR CORD NA S15	North America Power Cord, Straight 15A
	PWR CORD NA R15	North America Power Cord, Right Angle 15A
	PWR CORD NA S20	North America Power Cord, Straight 20A
	PWR CORD EURO	Universal EURO Power Cord
	PWR CORD CHN	China Power Cord
	PWR CORD IN	India Power Cord
	PWR CORD UK	United Kingdom Power Cord
	PWR CORD BRZ	Brazil Power Cord
	PWR CORD AUS	Australia Power Cord
	PWR CORD CHE	Switzerland Power Cord
	PWR CORD JPN	Japan Power Cord
	PWR CORD NONE	No Power Cord or AC Adapter

Power cord for MPI2-25 / MPX2-25	Model	Description
	A0	North America Power Cord
	A1	Universal EURO
	A2	United Kingdom Power Cord
	A3	Australia Power Cord
	A6	Japan Power Cord
	A10	China Power Cord
	A11	India Power Cord
	A12	Brazil Power Cord
	A99	No Power Cord or AC Adapter

Dual Display

MPI2 and MPX2 Dual Display Options	Option	Description
	MPI2-RACK-MD	PRISM MPI2, 19 inch, 3RU Rack Cabinet with display and touch panel, USB/HEADPHONE connector on rack ear
	MPX2-DUALDSP	19 inch, 3RU Dual display unit with touch panel, USB/Headphone connector on rack ear

MPI2-RACK-MD

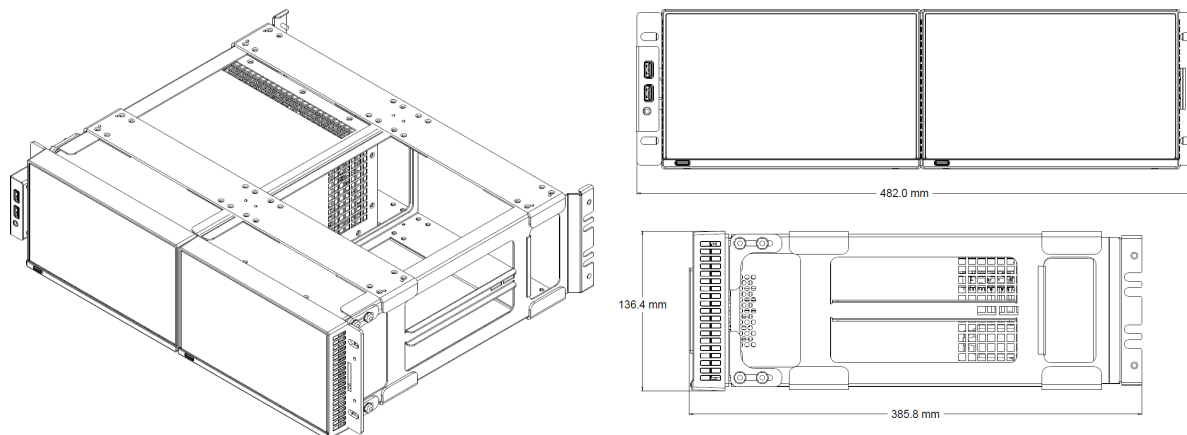

MPX2-DUALDSP

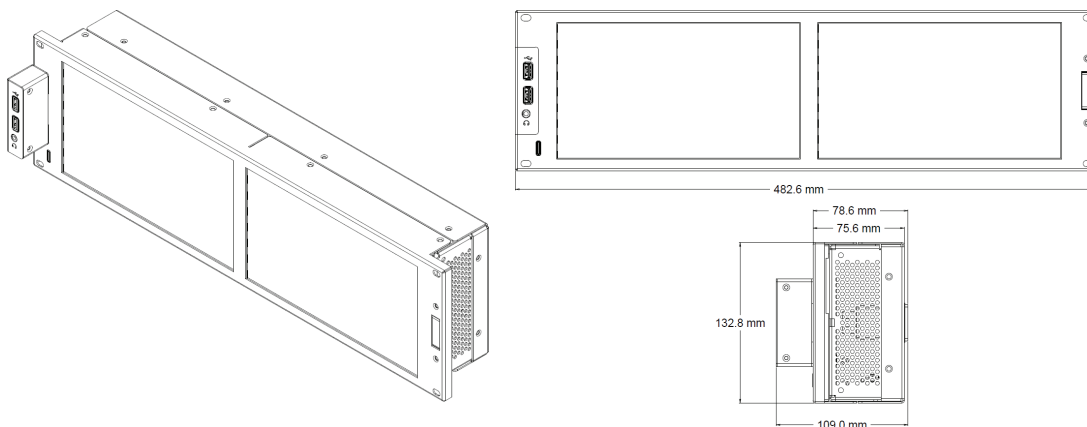

SFP Modules for IP Instruments

MPS/MPD 200/300,
MPI2 25, MPX2 25

Option	Description
MP-SFP 10GELR	A 10G Ethernet long range 1310 nm transceiver module for SFP+ C/D socket (MPI IP STD is required)
MP-SFP 10GESR	A 10G Ethernet short range 850 nm transceiver module for SFP+ C/D socket (MPI IP STD is required)
MP-SFP 25GELR	PRISM A 25G Ethernet long range 1310 nm transceiver module.
MP-SFP 25GESR	PRISM A 25G Ethernet short range 850 nm transceiver module.

Service, Support

MPI2-25 Model
Service Options

Option	Description
MPI2-25 FC3	Calibration service 3 years. Includes calibration or functional verification where applicable, for recommended calibrations. Coverage includes the initial calibration plus 2 years calibration coverage.
MPI2-25 FC5	Calibration service 5 years. Includes calibration or functional verification where applicable, for recommended calibrations. Coverage includes the initial calibration plus 4 years calibration coverage.
MPI2-25 FD3	Calibration Data Report 3 Years (with Option FC3)
MPI2-25 FD5	Calibration Data Report 5 Years (with Option FC5)
MPI2-25 R3	Standard Warranty Extended to 3 Years. Covers parts, labor and 2 day shipping within country. Guarantees faster repair time than without coverage. All repairs include calibration and updates. Hassle free a single call starts the process
MPI2-25 R5	Standard Warranty Extended to 5 Years. Covers parts, labor and 2 day shipping within country. Guarantees faster repair time than without coverage. All repairs include calibration and updates. Hassle free a single call starts the process

MPX2-25 Model
Service Options

Option	Description
MPX2-25 FC3	Calibration service 3 years. Includes calibration or functional verification where applicable, for recommended calibrations. Coverage includes the initial calibration plus 2 years calibration coverage.
MPX2-25 FC5	Calibration service 5 years. Includes calibration or functional verification where applicable, for recommended calibrations. Coverage includes the initial calibration plus 4 years calibration coverage.
MPX2-25 FD3	Calibration Data Report 3 Years (with Option FC3)
MPX2-25 FD5	Calibration Data Report 5 Years (with Option FC5)
MPX2-25 R3	Standard Warranty Extended to 3 Years. Covers parts, labor and 2 day shipping within country. Guarantees faster repair time than without coverage. All repairs include calibration and updates. Hassle free a single call starts the process
MPX2-25 R5	Standard Warranty Extended to 5 Years. Covers parts, labor and 2 day shipping within country. Guarantees faster repair time than without coverage. All repairs include calibration and updates. Hassle free a single call starts the process

MPS Model Service Options

Option Description

MPS FC3	Calibration service 3 years. Includes calibration or functional verification where applicable, for recommended calibrations. Coverage includes the initial calibration plus 2 years calibration coverage.
MPS FC5	Calibration service 5 years. Includes calibration or functional verification where applicable, for recommended calibrations. Coverage includes the initial calibration plus 4 years calibration coverage.
MPS FD3	Calibration Data Report 3 Years (requires purchase of FC3)
MPS FD5	Calibration Data Report 5 Years (requires purchase of FC5)
MPS R3	Standard Warranty Extended to 3 Years. Covers parts, labor and 2-day shipping within country. Guarantees faster repair time than without coverage. All repairs include calibration and updates. Hassle free -a single call starts the process
MPS R5	Standard Warranty Extended to 5 Years. Covers parts, labor and 2-day shipping within country. Guarantees faster repair time than without coverage. All repairs include calibration and updates. Hassle free -a single call starts the process

MPD Model Service Options

Option Description

MPD FC3	Calibration service 3 years. Includes calibration or functional verification where applicable, for recommended calibrations. Coverage includes the initial calibration plus 2 years calibration coverage.
MPD FC5	Calibration service 5 years. Includes calibration or functional verification where applicable, for recommended calibrations. Coverage includes the initial calibration plus 4 years calibration coverage.
MPD FD3	Calibration Data Report 3 Years (requires purchase of FC3)
MPD FD5	Calibration Data Report 5 Years (requires purchase of FC5)
MPD R3	Standard Warranty Extended to 3 Years. Covers parts, labor and 2-day shipping within country. Guarantees faster repair time than without coverage. All repairs include calibration and updates. Hassle free -a single call starts the process
MPD R5	Standard Warranty Extended to 5 Years. Covers parts, labor and 2-day shipping within country. Guarantees faster repair time than without coverage. All repairs include calibration and updates. Hassle free -a single call starts the process

Post Purchase Upgrade Options

MPI2-25 Model

Option Description

MPI2-25 UP PHY	Add SDI Physical Layer Measurement Package (incl. automated measurement of 12G/6G/3G/HD/SDI Eye pattern parameters and jitter parameters; jitter waveform display). MP2 FMT 4K license required for 12G/6G SDI support
----------------	--

MPX2-25 Model

Option Description

MPX2-25 UP PHY	Add SDI Physical Layer Measurement Package (incl. automated measurement of 12G/6G/3G/HD/SDI Eye pattern parameters and jitter parameters; jitter waveform display). MP2 FMT 4K license required for 12G/6G SDI support
----------------	--

[Post Purchase Upgrade Options for MPI2-10 and MPX2-10](#)

[Post Purchase Upgrade Options for MPI and MPX](#)

