



# Private Mobile Radios

European Edition



**iDAS**<sup>TM</sup>  
ICOM DIGITAL ADVANCED SYSTEM



**NXDN**<sup>TM</sup> **dPMR**<sup>TM</sup> **6.25 kHz FDMA**  
True RF Efficiency

# Company Profile

Icom Inc. is a wireless communications equipment manufacturer located in Osaka, Japan. Since Icom's establishment in 1954, the company have had a long record as a trusted manufacturer of land mobile radios, amateur radios, marine radios, navigation products, aviation radios and communication receivers.

## Icom quality and reliability

Over 50 years of engineering and production excellence is a part of every Icom product. Using the latest manufacturing technology, Icom radios are tested to pass rigorous in-house tests as well as environmental tests to the US Military standard 810 specifications. Icom's products also comply with the European RoHS directive and intrinsic safety standards.



## Made in Japan

Icom is a rare example of a Japanese equipment manufacturer that has not shifted production abroad, but has kept its production base in Japan. The Wakayama Icom plants have advanced production systems to produce small or large volume/multi-model wireless communication products.



## Icom, a global brand name

Icom is recognised as a leading 2-way radio global brand name around the world. Our land mobile radios are used by many professional organizations all over the world, including public safety, security and humanitarian organizations.

## Icom's worldwide network

Icom products are sold across the globe. Icom has an international sales and service network, including sales subsidiaries in the U.S., Canada, Australia, Germany and Spain. Icom is there to support and service your communication needs.

# INDEX

### Handheld Transceivers

									
IC-F3400DT/DS/D IC-F4400DT/DS/D » P.3	IC-F3262DT/DS IC-F4262DT/DS » P.3	IC-F52D IC-F62D » P.4	IC-F1100DT/DS/D IC-F2100DT/DS/D » P.4	IC-F3202DEX IC-F4202DEX » P.5	IC-F51ATEX IC-F61ATEX » P.5	IC-F1000T/S IC-F2000T/S » P.5	IC-F1000 IC-F2000 » P.6	Digital dPMR 446/ Analogue PMR 446 IC-F29DR IC-F29DR2 » P.6	Analogue PMR 446 IC-F29SR IC-F29SR2 » P.6



### Mobile / Data Transceivers

					
IC-F5400D/DS IC-F6400D/DS » P.7	IC-F5062D IC-F6062D » P.7	IC-F5122D IC-F6122D » P.8	IC-F5022 IC-F6022 » P.8	IC-F5012 » P.8	Data Transceiver IC-F5122DD IC-F6122DD » P.8

### Repeater / Controller / Manager Software

				
IC-FR5100 IC-FR6100 » P.9	NXDN Type-D System Manager RS-MGR1 » P.9	OTAP Manager CS-OTPM1 » P.9	dPMR Mode 3 Controller IC-FC5000E » P.10	dPMR Mode 3 System Manager RS-MGR2 » P.10

### IP ADVANCED RADIO SYSTEM

			
IP501H » P.11	IP100H » P.12	IP100FS » P.12	IP1000C » P.12

### RoIP Gateway/ Remote Communicator

	
RoIP Gateway VE-PG4 » P.13	Remote Communicator RC-FS10 » P.13

IDAS is Icom's digital land mobile radio system using the NXDN™ or dPMR™ common air interface. IDAS offers a complete system of handheld radios, mobile radios, repeaters, network interface/trunking controllers, remote communicator, system manager software and various accessories. IDAS is a proven total digital solution that system owners or operators can grow into as their time and budgets allow.

## Multiple-site Configurations

IDAS systems can cover various digital radio communication needs from simple peer to peer operation between two radios, up to multi-site wide area networks. Further coverage is enhanced with IP interconnection.



## Digital Clarity

By adopting the industry standard AMBE+2™ Vocoder and advanced FEC (Forward Error Correction) coding, improved communication quality, clarity and reliability are a hallmark of IDAS systems.



## Effective System Management

Simple and efficient management is critical for systems of any size. IDAS provides effective system management with such features as OTAP and administration applications.



### Multi-site Conventional

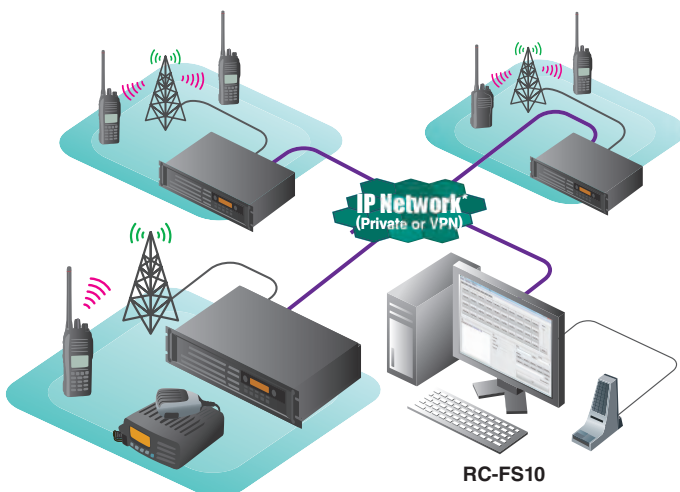

- NXDN™/dPMR™ protocol choice. Both protocols are open digital radio standards using FDMA narrowband technology
- 6.25 kHz digital migration at your own pace and needs, while running your existing analogue system
- Up to 16 IDAS repeater sites connection over an IP network
- RC-FS10, remote communicator

### NXDN™ Type-D Multi-site Trunking

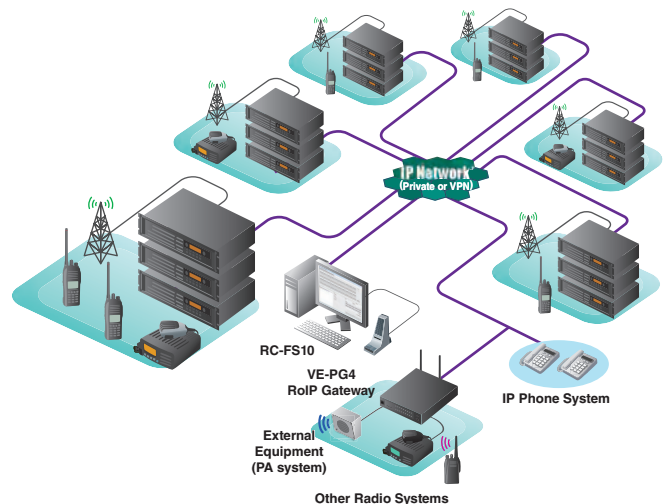

- Distributed channel system which does not use a dedicated control channel
- Up to 30 channels per site and up to 48 sites connection over an IP network
- Up to 60,000 individual IDs and 60,000 group IDs with fleet management
- Automatic site roaming
- ESN authentication
- RS-MGR1, system manager
- RC-FS10, remote communicator
- Telephone interconnection

**dPMR™ Mode 3 Trunking (See Page 10 for details)**



# Digital Handheld Radios

**IDAS™**  
ICOM DIGITAL ADVANCED SYSTEM

**IDAS™**  
ICOM DIGITAL ADVANCED SYSTEM



VHF DIGITAL TRANSCEIVERS

**IC-F3400DT/DS/D** (5 W)

UHF DIGITAL TRANSCEIVERS

**IC-F4400DT/DS/D** (5 W)

**IDAS™ Takes You to  
a New Level of “Smart”**



\*1 A microSD card is required.  
\*2 Optional UT-134 required for 64-key DES. Optional UT-134 and a ISL-AKAES licence key is required for AES.

## FEATURES

- Individual and group call • PTT ID and ANI • Status and message • Remote Kill, Stun and Revive
- Remote monitor/Ambience listening • Emergency • OAA (Over-the-Air-Alias) • Digital voice scrambler
- OTAR (Over-The-Air-Rekeying) (\* Optional CS-OTAR1 software required.) • Voting scan • Transparent data
- Digital/analogue mixed mode operation • Built-in 5-Tone, 2-Tone, CTCSS and DTCS • DTMF autodial and decoder
- MDC 1200 compatible\* (\* Depending on the version) • BIIS 1200 functions • Basic LTR™ trunking\* (\* Depending on the version) • USB port for PC connection • AquaQuake™ function • Audio equalizer
- Active noise canceller • Digital voice recording to a microSD card • Menu and function item localization
- Internal clock • Optional BC-225 intelligent charger and RS-BC225 reader software • 136–174 and 380–470 MHz, 5 W versions • 1024 memory channels with 128 zones (IC-F3400D/F4400D: 32 memory channels)
- 4000 memory channels with optional ISL-CHEX licence key. • 1300 mW loud audio output power (internal speaker) with improved audio clarity • IC-F3400DPT/DPS/DP, IC-F4400DPT/DPS/DP for dPMR protocol.

### Supplied Accessories

- BP-283, Battery pack • MB-133, Belt clip

VHF DIGITAL TRANSCEIVERS

**IC-F3262DT/DS** (5 W)

UHF DIGITAL TRANSCEIVERS

**IC-F4262DT/DS** (5 W)

**Advanced Digital Radio with  
Built-in GPS Receiver\*1**



\*1 Functions may not be installed, depending on the transceiver version.

## FEATURES

- Individual and group call • PTT ID and ANI • Status and short data message (SDM) • Kill, Stun and Revive • Remote monitor/Ambience listening
- Emergency • Digital voice scrambler • Voting scan • Transparent data\* (\* Depending on the version) • Digital/analogue mixed mode operation
- DTMF autodial and decoder • Built-in 5-Tone, 2-Tone, CTCSS and DTCS • MDC 1200 compatible\* (\* Depending on the version) • BIIS 1200 functions\* (\* Depending on the version) • Basic LTR™ trunking\* (\* Depending on the version)
- Inversion voice scrambler (analogue) • 136–174, and 400–470 MHz, 5 W • 512 memory channels with 128 zones • 800 mW (typ.) loud audio • Audio compander for analogue

### Supplied Accessories

- BP-232WP, Battery pack • MB-94R, Belt clip • Antenna



VHF DIGITAL TRANSCEIVER  
**IC-F52D** (5 W)  
 UHF DIGITAL TRANSCEIVER  
**IC-F62D** (5 W)

**5 W Power Pack  
 Super Compact Body**

<b>IDAS™</b> CONVENTIONAL	<b>Type-D TRUNKING</b> (ISL-UGMTR required)	<b>MODE 3 TRUNKING</b> (ISL-UGMD3 required)	<b>IP67</b> WATERPROOF & DUST-TIGHT	<b>MIL-STD 810</b>	<b>13 HOURS</b> BATTERY LIFE (with BP-290)	<b>MOTION/STATIONARY SENSOR</b>
<b>MAN DOWN, LONE WORKER</b>	<b>CHANNEL ANNOUNCEMENT</b>	<b>VIBRATION ALERT</b>	<b>VOICE RECORDING</b>	<b>OTAP (OVER-THE-AIR PROGRAMMING)</b> (CS-OTPM1 required)	<b>OAA (OVER-THE-AIR ALIAS)</b>	<b>BLUETOOTH®</b>

**FEATURES**

- Individual and group call • PTT ID and ANI • Status and message • Remote Kill, Stun and Revive (RX) • Remote monitor/Ambience listening • Emergency • OAA (Over-the-Air-Alias)
- Digital voice scrambler • Voting scan • Transparent data • Digital/analogue mixed mode operation
- DTMF autodial and decoder • BISS 1200 functions • MDC 1200 compatible\* (\* Depending on the version) • Basic LTR™ trunking\* (\* Depending on the version) • Built-in 5-Tone, 2-Tone, CTCSS and DTCS • Optional HM-233GP GPS speaker-microphone • Inversion voice scrambler (analogue) • Audio equalizer • Active noise canceller • Voice recording and playback (Up to 8 minutes)
- Programmable functions and menu items in a language other than English • Optional BC-225 intelligent charger and RS-BC225 reader software • 136–174 and 400–470 MHz, 5 W versions
- 512 memory channels with 128 zones • 1300 mW audio output (internal speaker)

**Supplied Accessories**

- BP-290, Battery pack • MBB-3, Belt clip

VHF DIGITAL TRANSCEIVERS  
**IC-F1100DT/DS/D** (5 W)  
 UHF DIGITAL TRANSCEIVERS  
**IC-F2100DT/DS/D** (4 W)

**Compact, Waterproof  
 and Improved Audio Clarity**

<b>IDAS™</b> CONVENTIONAL	<b>Type-D TRUNKING</b> SINGLE-SITE	<b>IP67</b> WATERPROOF & DUST-TIGHT	<b>MIL-STD 810</b>	<b>18 HOURS</b> BATTERY LIFE (with BP-280)
<b>MOTION/STATIONARY SENSOR</b>	<b>MAN DOWN, LONE WORKER</b>	<b>CHANNEL ANNOUNCEMENT</b>	<b>OAA (OVER-THE-AIR ALIAS)</b>	<b>1.5 W</b> AUDIO OUTPUT



Icom's custom made speaker

**FEATURES**

- Individual and group call • PTT ID and ANI • Status and message • Radio Kill, Stun and Revive (RX) • Remote monitor/Ambience listening (RX) • Emergency • OAA (Over-the-Air-Alias)\* (\* IC-F1100DT/DS, IC-F2100DT/DS only.) • Digital voice scrambler • Voting scan • Digital/analogue mixed mode operation • DTMF autodial • Built-in 2-Tone, 5-Tone, CTCSS and DTCS • MDC 1200 (limited functions)\* (\* Depending on the version) • BISS 1200 (limited functions)\* (\* Depending on the version) • GPS position data with optional HM-171GPW • 1.5 W loud audio output power (internal speaker) with improved audio clarity • AquaQuake™ function
- 136–174 MHz, 5 W • 400–470 MHz, 4 W • 128 memory channels with 8 zones (IC-F1100D/ F2100D: 16 memory channels)

**Supplied Accessories**

- BP-280, Battery pack • MB-133, Belt clip • Antenna
- BC-213\*, Desktop charger • BC-123SE\*, AC adapter
- \* May differ or not supplied, depending on the transceiver version.



# Intrinsically Safe Radios / Analogue Radios



**IDAS™**  
ICOM DIGITAL ADVANCED SYSTEM

IC-F3202DEX

IC-F4202DEX



IC-F51ATEX

IC-F61ATEX



IC-F1000T

IC-F2000S



Icom's custom made speaker

VHF DIGITAL TRANSCEIVER

**IC-F3202DEX** (1 W)

UHF DIGITAL TRANSCEIVER

**IC-F4202DEX** (1 W)

**IECEX/ATEX Intrinsically Safe Digital Radio**



## FEATURES

- **ATEX Certifications**  
Mining: I M2 Ex ib I Mb  
Gas: II 2G Ex ib IIC T4 Gb  
Dust: II 2D Ex ib IIIC T110°C Db  
-20°C ≤ Ta ≤ +55°C
- **IEC Certifications**  
Ex ib I Mb  
Ex ib IIC T4 Gb  
Ex ib IIIC T110°C Db  
-20°C ≤ Ta ≤ +55°C
- Individual and group call • PTT ID (TX) • Power ON/OFF status call (TX) • Radio Kill, Stun and Revive (RX) • Remote monitor/Ambience listening (RX) • Emergency (TX) • Digital voice scrambler • Voting scan • Digital/analogue mixed mode operation • Built-in 2-Tone, 5-Tone, CTCSS and DTCS • DTMF autodial • MDC 1200 (limited functions)\* (\* Depending on the version) • BIIS 1200 (limited functions)\* (\* Depending on the version) • Optional HM-203EX speaker-microphone • 136-174 and 400-470 MHz, 1 W • 16 memory channels

### Supplied Accessories

- BP-277EX, Battery pack • BC-212EX, Desktop charger
- BC-123SE/SUK\*, AC adapter • MB-94EX, Belt clip • Antenna
- \* May differ depending on the transceiver version.

DO NOT use the transceiver with any other equipment not specified in the option list (Pages 14-17). Please ask your dealer to ensure the ATEX and IECEX ratings are acceptable for the intended place of use.

VHF TRANSCEIVER

**IC-F51** ATEX (1 W)

UHF TRANSCEIVER

**IC-F61** ATEX (1 W)

**ATEX Intrinsically Safe Radio**



## FEATURES

- **ATEX Certifications**  
Gas: II 2G Ex ib IIA T3 Gb  
Dust: II 2D Ex ib IIIC T160°C Db IP67  
(Tamb=-20°C to +55°C)
- Lone Worker function • Built-in 2-Tone, 5-Tone, CTCSS and DTCS • BIIS 1200 capability • MDC 1200 compatibility • Eight DTMF autodial memories • Mode dependent scan • Compact body; 56 (W) × 97 (H) × 36.4 (D) mm • Optional speaker-microphone, HM-138 • 136-174 and 400-470 MHz, 1 W

### Supplied Accessories

- BP-227AXD, Battery pack • MB-98, Belt clip • Antenna

VHF TRANSCEIVERS

**IC-F1000T/S** (5 W)

UHF TRANSCEIVERS

**IC-F2000T/S** (4 W)

**Slim, Compact Dimensions with IP67 Waterproofing**



## FEATURES

- Compact and slim body (24.5 mm depth) • Easy to hear in noisy environments • DTMF autodial • Built-in 5-Tone, 2-Tone, CTCSS and DTCS • MDC 1200 PTT ID, Emergency and other limited functions • BIIS PTT ID and emergency call • 16 codes inversion voice scrambler • Surveillance function • Escalating alarm • "Shift key" function • 136-174 MHz, 5 W • 400-470 MHz, 4 W • 128 memory channels with 8 zones • 1.5 W loud audio output power (internal speaker) with improved audio clarity

### Supplied Accessories

- BP-279, Battery pack • BC-213, Desktop charger
- BC-123SE/SUK\*, AC adapter • MB-133, Belt clip • Antenna
- \* May differ or not supplied, depending on the transceiver version.



# dPMR™ 446 Digital Radios / PMR 446 Radios



Icom's custom made speaker

IC-F1000

IC-F2000



IC-F29DR



Icom's custom made speaker



IC-F29SR

## VHF TRANSCEIVER

# IC-F1000 (5 W)

## UHF TRANSCEIVER

# IC-F2000 (4 W)

### Simple, Basic Model with IP67 Waterproofing

<b>5-TONE</b> CTCSS / DTCS	<b>IP67</b> WATERPROOF & DUST-TIGHT	<b>Rugged MIL-STD-810</b>	<b>14 HOURS</b> BATTERY LIFE (with BP-279)
<b>1.5 W</b> AUDIO OUTPUT	<b>MOTION/STATIONARY SENSOR</b>	<b>MAN DOWN, LONE WORKER</b>	<b>CHANNEL ANNOUNCEMENT</b>

#### FEATURES

- Compact and slim body (24.5 mm depth)
- Easy to hear in noisy environments
- DTMF autodial
- Built-in 5-Tone, 2-Tone, CTCSS and DTCS
- MDC 1200 PTT ID, Emergency and other limited functions
- BIIS PTT ID and emergency call
- 16 codes inversion voice scrambler
- Surveillance function
- Escalating alarm
- "Shift key" function
- 136–174 MHz, 5 W
- 400–470 MHz, 4 W
- 16 memory channels
- 1.5 W loud audio output power (internal speaker) with improved audio clarity

#### Supplied Accessories

- BP-279, Battery pack
- BC-213, Desktop charger
- BC-123SE/SUK\*, AC adapter
- MB-133, Belt clip
- Antenna

\* May differ or not supplied, depending on the transceiver version.

## dPMR™ 446/PMR 446 TRANSCEIVERS

# IC-F29DR (500 mW ERP)

# IC-F29DR2 (500 mW ERP)

### Professional Digital Licence-Free Radio

<b>dPMR 446</b> LICENCE-FREE DIGITAL	<b>PMR 446</b> LICENCE-FREE ANALOGUE	<b>CTCSS DTCS</b> FOR ANALOGUE	<b>IP67</b> WATERPROOF & DUST-TIGHT
<b>Rugged MIL-STD-810</b>	<b>26 HOURS</b> BATTERY LIFE (with BP-280)	<b>CHANNEL ANNOUNCEMENT</b>	<b>11 km</b> COVERAGE*

#### FEATURES

- Digital: improved resistance to interference
- No licence is required to use this radio
- IC-F29DR2: Digital 32 channels, Analogue 16 channels
- IC-F29DR: Digital 16 channels, Analogue 8 channels
- Outstanding audio quality
- 16-position rotary channel knob with voice announcement function
- Call ring tone function
- Operating channels are programmable in the field
- PC programmable
- Digital common ID, CTCSS and DTCS codes for group call
- Power on scan

\* Wide open space. Communication range will vary, depending on terrain and conditions.

#### Supplied Accessories

- BP-280, Battery pack
- BC-213, Desktop charger
- BC-123SE/SUK\*, AC adapter
- MB-133, Belt clip

\* May differ or not supplied, depending on the transceiver version.

## PMR 446 TRANSCEIVERS

# IC-F29SR (500 mW ERP)

# IC-F29SR2 (500 mW ERP)

### Slim, Waterproof PMR 446 Licence-Free Radio

<b>PMR 446</b> LICENCE-FREE ANALOGUE	<b>CTCSS DTCS</b> FOR ANALOGUE	<b>IP67</b> WATERPROOF & DUST-TIGHT	<b>Rugged MIL-STD-810</b>
<b>21 HOURS</b> BATTERY LIFE (with BP-279)	<b>1.5 W</b> AUDIO OUTPUT	<b>CHANNEL ANNOUNCEMENT</b>	<b>8 km</b> COVERAGE*

#### FEATURES

- Licence-free analogue PMR 446
- No licence is required to use this radio
- Compact and slim body (24.5 mm depth)
- IC-F29SR2: Analogue 16 channels
- IC-F29SR: Analogue 8 channels
- Easy to use and easy to hear
- 16-position rotary channel knob programmable operating channel and group code
- Call ring tone function
- Answer back call function
- PC programmable
- Built-in voice scrambler for private conversation
- CTCSS and DTCS codes for group call

\* Wide open space. Communication range will vary, depending on terrain and conditions.

#### Supplied Accessories

- BP-279, Battery pack
- BC-213, Desktop charger
- BC-123SE/SUK\*, AC adapter
- MB-133, Belt clip

\* May differ or not supplied, depending on the transceiver version.



# Digital Mobile Radios

VHF DIGITAL TRANSCEIVER  
**IC-F5400D**  
(25 W, Colour LCD)

UHF DIGITAL TRANSCEIVER  
**IC-F6400D**  
(25 W, Colour LCD)



IC-F5400D/F6400D

VHF DIGITAL TRANSCEIVER  
**IC-F5400DS**  
(25 W, Segment LCD)

UHF DIGITAL TRANSCEIVER  
**IC-F6400DS**  
(25 W, Segment LCD)



IC-F5400DS/F6400DS

## Superb Performance and a Comprehensive Range of Features



\*1 IC-F5400D/F6400D only. \*2 A microSD card is required.  
\*3 Optional UT-134 required for 64-key DES. Optional UT-134 and a ISL-AKAES licence key is required for AES.

## FEATURES

• Individual and group call • PTT ID and ANI • Status and message • Remote Kill, Stun and Revive • Remote monitor/Ambience listening • Emergency • Power OFF emergency • OAA (Over-the-Air-Alias) • Digital voice scrambler • OTAR (Over-The-Air-Rekeying)\* (\*Optional CS-OTAR1 software required.) • Voting scan • DTMF autodial and decoder • Built-in 5-Tone, 2-Tone, CTCSS and DTCS • Transparent data • MDC 1200 compatible\* (\* Depending on the version) • BISS 1200 functions • Basic LTR™ trunking\* (\* Depending on the version) • Digital voice recording to a microSD card • USB port for PC connection • Ignition line • D-SUB 25-pin ACC connector • 20 W audio amplifier • Audio Equalizer • Active Noise Canceller • Menu and function item localization • Internal clock • Public address and RX speaker functions • Built-in GPS receiver (UX-241 GPS antenna required separately) • Optional detached controller, dual head or COMMANDMIC™ configurations • 136–174 and 380–470 MHz, 25 W version • 1024 memory channels with 128 zones (IC-F5400DS/F6400DS: 99 memory channels selectable) • 4000 memory channels with optional ISL-CHEX licence key.

\* IC-F5400DP/DPS, IC-F6400DP/DPS for dPMR protocol.

## Supplied Accessories

• HM-221, Hand microphone • DC power cable • Mounting bracket kit • Microphone hanger



## Multiple Controller Configurations\*

With a combination with optional separation kits, COMMANDMIC™ and separation cables, three types of controller configurations are available to suit almost any application or installation that may be required.

\* Multiple controller configurations are for only the IC-F5400D/DP/IC-F6400D/DP.



Dual head controller configuration

COMMANDMIC™ and detached controller configuration

VHF DIGITAL TRANSCEIVER  
**IC-F5062D** (25 W)

UHF DIGITAL TRANSCEIVER  
**IC-F6062D** (25 W)



## Versatile, Multi-Function Mobile Series



IC-F5062D/F6062D

## FEATURES

• Individual and group call • PTT ID and ANI • Status and short data message (SDM) • Remote Kill, Stun and Revive • Remote monitor/Ambience listening • Emergency • Digital voice scrambler • Voting scan • Transparent data\* (\* Depending on the version) • Digital/analogue mixed mode operation • DTMF autodial and decoder • Built-in 5-Tone, 2-Tone, CTCSS and DTCS • MDC 1200 compatible\* (\* Depending on the version) • BISS 1200 functions\* (\* Depending on the version) • Basic LTR™ trunking\* (\* Depending on the version) • Inversion voice scrambler (analogue) • Ignition line • D-SUB 25-pin ACC connector • Optional HM-211 active noise canceling microphone • Optional detachable controller • 136–174 and 400–470 MHz, 25 W versions • 512 memory channels with 128 zones

## Supplied Accessories

• HM-152, Hand microphone • DC power cable • Microphone hanger • Mounting bracket kit

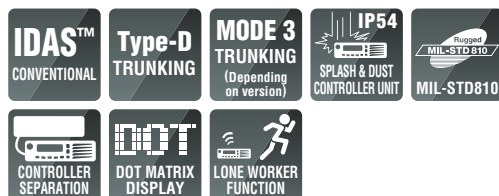





# Digital Radios / Analogue Radios

VHF DIGITAL TRANSCEIVER

**IC-F5122D** (25 W)

UHF DIGITAL TRANSCEIVER

**IC-F6122D** (25 W)

## Digital Standard Mobile Radio



**IDAS™**  
ICOM DIGITAL ADVANCED SYSTEM

IC-F5122D/F6122D



### FEATURES

- Individual and group call • PTT ID and ANI • Status and short data message (SDM) • Radio Kill, Stun and Revive (RX)
- Remote monitor/Ambient listening (RX) • Emergency • Digital voice scrambler • Voting scan • Transparent data call (Xon/Xoff)\*
- (\* Depending on the version) • Digital/analogue mixed mode operation • DTMF autodial • Built-in 5-Tone, 2-Tone, CTCSS and DTCS
- BISS 1200 functions\* (\* Depending on the version) • GPS receiver connection with optional ACC cable • 8-character alphanumeric display • 4 W (typical) front mounted speaker • Optional HM-211 active noise canceling microphone • 136–174 and 400–470 MHz, 25 W versions • 128 memory channels with 8 zones • Surveillance function

### Supplied Accessories

- HM-152, Hand microphone • DC power cable • Mounting bracket kit • Microphone hanger

VHF MOBILE TRANSCEIVER

**IC-F5022**

(25 W, 128 Ch with LCD)

UHF MOBILE TRANSCEIVER

**IC-F6022**

(25 W, 128 Ch with LCD)



IC-F5022/F6022

VHF MOBILE TRANSCEIVER

**IC-F5012**

(25 W, 8 Ch without LCD)



IC-F5012

## Hardworking Mobile Radios



### FEATURES

- DTMF autodial • Built-in 5-Tone, 2-Tone, CTCSS and DTCS • BISS 1200 functions (limited functions)\* (\* Depending on the version) • MDC 1200 compatible (limited functions)\* (\* Depending on the version)
- External memory channel control, external device connection with optional ACC cable • 8-character alphanumeric display (IC-F5022/F6022 only) • 4 W (typical) front mounted speaker • 136–174 and 400–470 MHz, 25 W versions • 128 memory channels with 8 zones (IC-F5022/F6022 only) • 8 memory channels and LED lighting (IC-F5012 only)

### Supplied Accessories

- HM-152, Hand microphone • DC power cable • Mounting bracket kit • Microphone hanger



# Data Radios



RS-232 + Ethernet version



RS-232 version

VHF DATA TRANSCEIVER

**IC-F5122DD**

UHF DATA TRANSCEIVER

**IC-F6122DD**

## General Purpose Transparent Data Modem



### FEATURES

- 9600 bps (at 12.5 kHz) and 4800 bps (at 6.25 kHz) data mode
- 25 W, 10 W and 6 W three-step RF output power
- TCP/IP protocol (IPv4) support for Ethernet
- Meets EN 300 113/EN 300 279 standards
- Fast data transfer using 4-level FSK modulation

### Supplied Accessories

- DC power cable • Mounting bracket kit



# Digital Repeaters / System Manager / OTAP Manager



IC-FR5100/FR6100

## VHF REPEATER IC-FR5100 (25 W, 100% duty)

## UHF REPEATER IC-FR6100 (25 W, 100% duty)



### Value, Performance and Flexibility



\*1 Optional UC-FR5000 and CF-FR5000MC required for NXDN™ multi-site conventional. Optional UC-FR5000 (#12) required for dPMR™ Mode 2 multi-site.

\*2 Optional UC-FR5000 required for single-site trunking. Optional UC-FR5000 and CF-FR5000MT required for multi-site trunking.

### FEATURES

- Two RF modules in one unit\* (\* Optional UR-FR5100 or UR-FR6100 required.)
- 25 W at 100% duty operation (Ambient temperature: 25°C)
- Optional UR-PA5000 or UR-PA6000 power amplifier provides 50 W at 100% duty operation\* (Ambient temperature: 25°C)
- Base station operation for Analogue and IDAS conventional mode operation
- dPMR™ Mode 3 repeater for use with IC-FC5000E controller\* (\* UC-FR5000SE required.)
- PC programmable via IP network\* (\* UC-FR5000 required.)
- D-SUB 25-pin accessory connector
- CW-ID transmission
- Built-in 5-tone, CTCSS and DTCS
- DTMF encode and decode
- 32 memory channels capacity
- 2U height rack mount design
- Digital voice scrambler
- Inversion voice scrambler for analogue
- IDAS conventional/FM mixed mode operation
- Built-in audio Compressor for analogue
- 136–174 and 400–470 MHz, 25 W
- IC-FR5100H/FR6100H: high power, UR-PA5000 or UR-PA6000 installed version
- IC-FR5200H/FR6200H: high power, full duty repeater with heatsink chassis version (Export version)

### Supplied Accessories

- DC power cable
- Key assign stickers

## SYSTEM MANAGER (For NXDN™ Type-D Multi-Site Trunking) RS-MGR1

### Enhance System Management for NXDN™ Type-D Trunking Systems



### FEATURES

#### • Provides real-time monitoring, system alerts and log search functions

- Repeater properties show condition summary, system information, interface (traffic statistics), repeater condition details and ping status of each repeater
- Registration log, communication log, traffic log and search log can be searched and downloaded with extensive filter settings
- Repeater site icons laid out on an image file such as a map or network diagram
- E-mail alert notification can be sent to the administrator, if an alarm or disconnect occurs or clears
- The "Mesh ping status" shows the connectivity by sending ping commands in all combinations of repeater sites
- The "Version list" shows the repeaters firmware revision list

### Supplied Accessories

- USB flash drive (Software and hardware key protection)

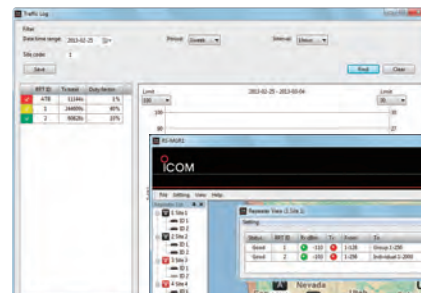

Traffic Log

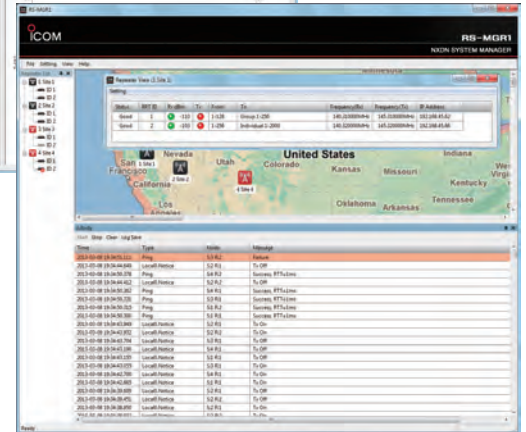

## OTAP MANAGER CS-OTPM1

### Easily Reconfigure Radios with Over-The-Air Programming



### FEATURES

#### • Remotely reconfigure radios while in the field

- Radios can be reconfigured in a short period of time by transmitting only the updates.
- Single programming data can transmit to a whole fleet with only one click
- Up to 10,000 sessions are logged for review and rescheduling
- Both original and new data can be kept in the radios until the OTAP process is completed
- System operator can change language setting of CS-OTPM1
- Manages up to 100,000 radios

### Supplied Accessories

- USB dongle supplied with the software

### Compatible models

- IC-F3400D series
- IC-F4400D series
- IC-F5400D series
- IC-F6400D series
- IC-F52D
- IC-F62D

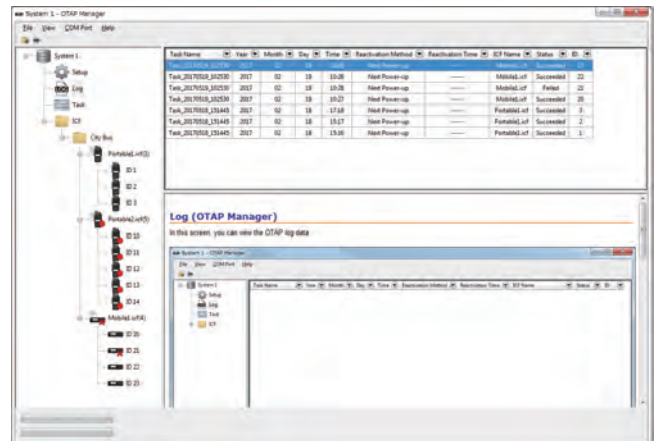

# dPMR™ Mode 3 Controller / System Manager

## dPMR™ Mode 3 Trunking

In a dPMR Mode 3 digital trunking system, when a user requests a call through a dedicated control channel, the trunking controller automatically allocates one of the traffic channels and sets up the call. The system can accommodate a large number of users on a limited number of repeater channels with high efficiency. The System Control Software can interconnect multiple trunking controllers over an IP network, so the system can be expanded from a single site system to multiple sites and increased coverage.

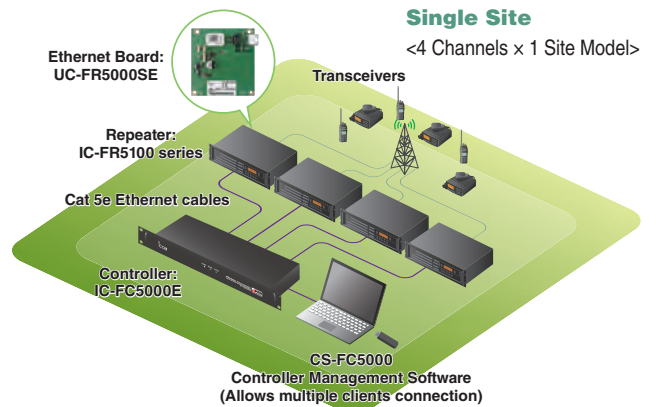

## Multi-Site

<6 Channels x 3 Sites Model>

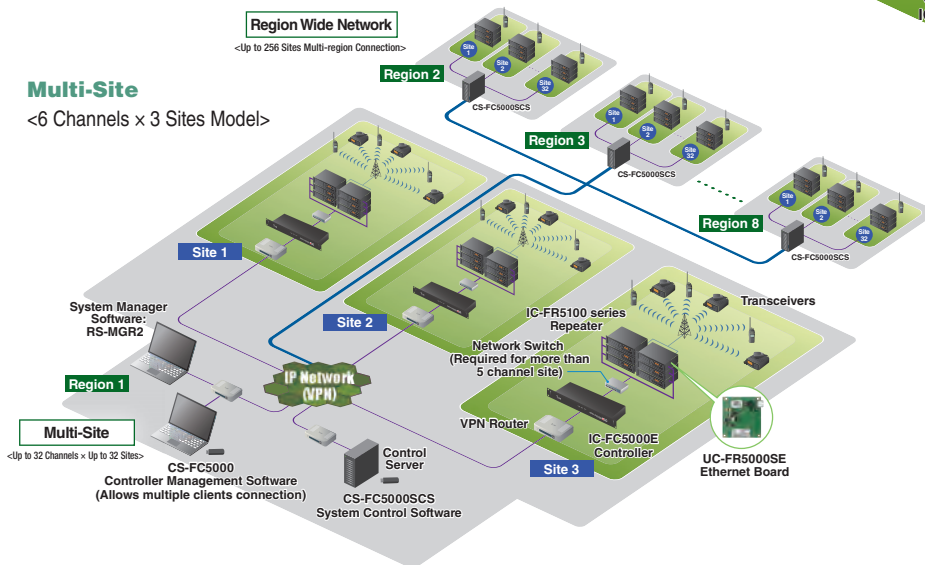

- Up to 32 channels per site
- Up to 32 site multi-site trunking with CS-FC5000SCS System Control Software  
\* Up to 256 site multi-region connection (8 region x 32 sites for example)
- Channel licence system. Four channel activation key is supplied with the IC-FC5000E  
For additional channels/sites, an activation key is required.
- CS-FC5000 web based management software allows you to connect multiple clients
- Individual and group calls, including broadcast
- Status call • Short data message
- Call Queuing
- Emergency Call with Pre-emption

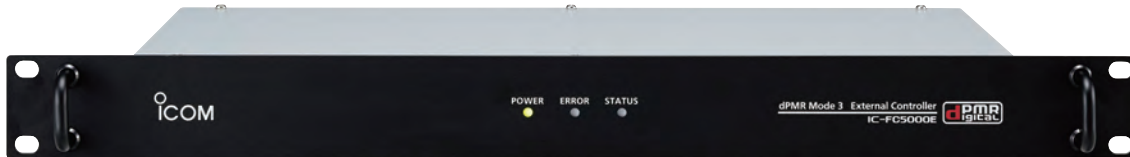

IC-FC5000E

## dPMR™ MODE 3 EXTERNAL CONTROLLER IC-FC5000E

### dPMR™ Mode 3 Trunking Controller



## FEATURES

- Spectrum efficient centralized control channel trunking
- Up to 32 channels per site (One control channel, up to 31 traffic channels)
- Up to 32 site multi-site trunking with CS-FC5000SCS system control software
- Up to 256 site multi-region connection
- Call queuing and emergency call with pre-emption
- CS-FC5000 web based management software
- Firmware update over an IP network
- Remote reboot of the trunking controller over an IP network
- Repeater anomaly detection and alert
- A traffic channel can be configured as a secondary control channel
- 1U (44mm) rack mount

## Supplied Accessories

- DC power cable

## dPMR™ MODE 3 SYSTEM MANAGER RS-MGR2

### Enhance System Management for dPMR™ Mode 3 Systems



## FEATURES

### • Provides real-time monitoring, system alerts and log search functions for a dPMR™ Mode 3 system

- Real-time monitoring includes repeater view, repeater status, repeater condition, active screen and system connection
- Registration log, communication log, traffic log and search log can be searched and downloaded with extensive filter settings
- Repeater site icons laid out on an image file such as a map or network diagram
- Up to 20 user accounts with three types of access rights and e-mail alert setting





# IP ADVANCED RADIO SYSTEM (Over LTE (4G) and 3G Network)

## Instant Nationwide Coverage Over a LTE (4G) and 3G Network Multiple User Communications with Telephone Style Conversation

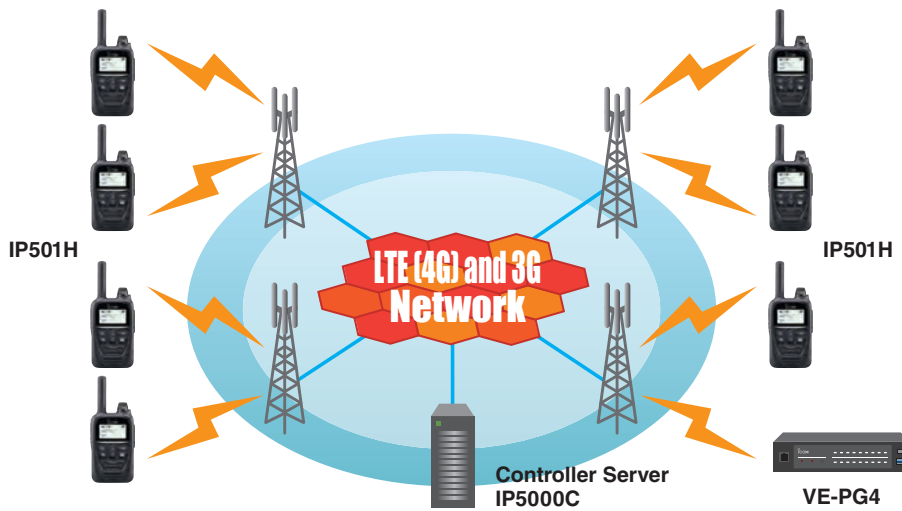

### FEATURES

#### Push-to-Talk Communication over an LTE (4G) and 3G Network\*

The IP501H uses a dedicated hardware in a closed network to provide stable and secure connections. The IP501H does not require its own repeaters or IP network, which reduces the cost of building and maintaining a wide area radio network.

\* Service availability depends on the country. Network coverage provided by a custom SIM card.

#### Full-Duplex Communication

The IP501H enables use of full-duplex communication, which provides smooth telephone style conversations. The IP501H users can talk and receive at the same time.

#### Multiple User Communication

Multiple users in the call groups can initiate calls instantaneously, eliminating the need to wait for available channels to communicate. If two or more users talk at the same time, their voices are mixed and delivered to the call group.

#### Priority Interrupt Calling

The IP501H supports group calls with three or more people. In case of an emergency, you can break into an on-going call to transmit an important message.

#### Interconnect between IDAS™ and IP100H Systems

With the VE-PG4, RoIP gateway, the IP501H system provides interoperability with IP phones, analogue transceivers, IDAS™ digital transceivers and an IP100H wireless LAN IP Advanced Radio System. In addition, the VE-PG4 can obtain GPS position data from the IP501H transceiver.

### LTE TRANSCIVER

## IP501H



### FEATURES

- Short-delay, high quality audio with wideband, near lossless G.726 vocoder
- IP67 waterproof and dust-tight (1 m depth water for 30 minutes)
- Lone Worker and Man Down functions
- Compact 59 × 95 × 32 mm and lightweight 240 g (approximate) body
- Vibration Alert function notifies of incoming calls
- Built-in Bluetooth® and GPS\*

- Optional BC-218 charger cradle and HM-215 speaker-microphone with a Bluetooth® function that enables you to wirelessly use the speaker-microphone connected to the charger
  - Text message reception and preprogrammed message transmission
  - Up to 500 memories (including group, individual, talk group and telephone)
  - Full duplex communication without a headset
  - Full dot-matrix display
- \* GPS mapping software required for GPS data (future).

#### Supplied Accessories

- BP-272, Battery pack
- MB-135, Belt clip
- Antenna
- Hand strap



# IP ADVANCED RADIO SYSTEM (Wireless LAN)

## Full-Duplex Communication that Works Over a Wireless IP Network

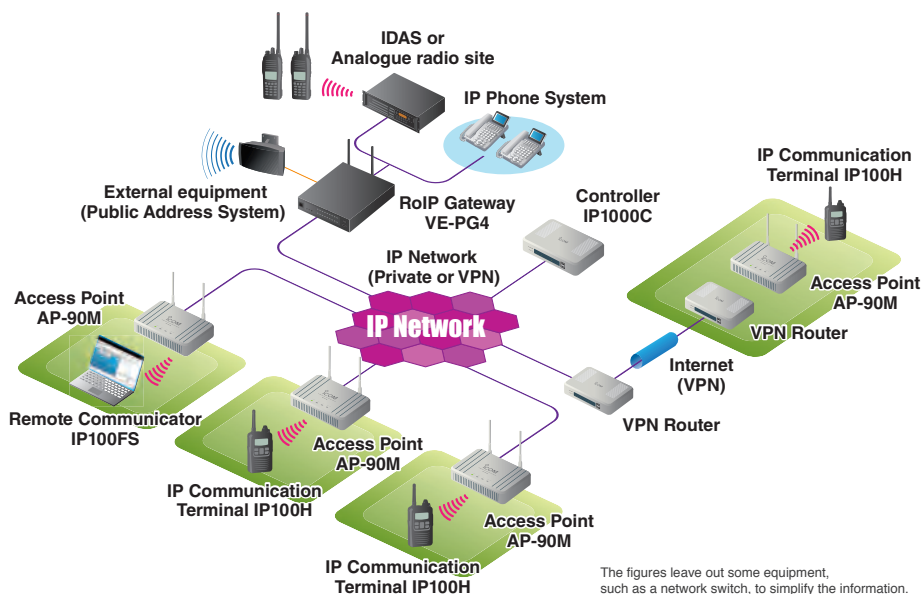

\* The IP100H can be used with an internal antenna. (Communication range will decrease to half from/to access points.)



### FEATURES

#### Wireless Communication System

By deploying access points along the existing IP network, the IP advanced radio system can communicate from anywhere in the facility. The IP100H can access the nearest access point, and can roam between access points.

#### Individual, Group, All or Area Communication

Staff spread across multiple rooms can communicate seamlessly. The IP communication terminal can receive Short Data Messages with a vibration alert from a PC installed with IP100FS.

#### Hands-free, Full-duplex Communication

With an optional earphone-microphone or headset\*, the IP100H user can simultaneously talk and receive like a phone call. Hands-free operation allows your staff to carry out other tasks at the same time.

\* For full-duplex operation, please use either HM-153LS, HM-166LS, HS-102 with OPC-2359 or HS-85 with OPC-2144 for full-duplex operation.

#### Interconnect between IDAS™ and IP Phone Systems

With the VE-PG4 RoIP gateway, the IP advanced radio system can interconnect with IP phone systems, analogue transceivers and IDAS™ conventional and NXDN™ Type-D trunking transceivers.

#### WIRELESS LAN ACCESS POINT

### AP-90M

- IEEE 802.11 a/b/g/n/ac compliant (2.4 GHz and 5 GHz\*)
- PoE (Power over Ethernet) capability
- Optional RS-AP3, Access point management software

\* Authorized frequency range and channels may differ depending on the country.



AP-90M

#### REMOTE COMMUNICATOR

### IP100FS

- The IP100FS can communicate with IP communication terminals from a PC
- The IP100FS can obtain location information of each IP100H based on using access points, when used with the AP-90M
- Can be installed on a Windows®-based tablet PC as well as laptop PC
- Supplied with a USB flash drive for use as a USB hardware key



IP100FS

#### CONTROLLER

### IP1000C

- The IP1000C controls all terminal configurations over the air
- Capable of controlling up to 100 terminals (including IP100FS)



IP1000C

### IP COMMUNICATION TERMINAL IP100H



### FEATURES

- Licence-free wireless LAN communication terminal using IEEE 802.11 a/b/g/n standards (2.4 GHz and 5 GHz\*)
- WPA-PSK/WPA2-PSK (TKIP/AES) authentication
- IPX7 waterproof (1m depth water for 30 minutes)
- MIL-STD 810 G rugged construction
- Compact 58 × 95 × 26.4 mm and lightweight 205 g (approximate) body
- Vibration alert function announces incoming calls

\* Authorized frequency range and channels may differ, depending on the country.

- Text message reception and pre-programmed message transmission
- Status messages
- Emergency call function
- Full dot-matrix display

#### Supplied Accessories

- BP-271, Battery pack
- MB-127, Belt clip
- Antenna
- Hand strap



# RoIP Gateway / Remote Communicator

## RoIP GATEWAY VE-PG4



**Versatile Radio Over IP Gateway Linking Various Radio Systems and Protocols with LTE and IP Networks**



VE-PG4



### FEATURES

- VE-PG4 multiple-site connection through LAN or LTE (4G) and 3G network\* (\* Service availability depends on the country. Network coverage provided by a custom SIM card.)
- Wireless LAN transceiver controller (Equivalent to IP1000C function) built-in, capable of controlling up to 50 IP communication terminals
- IP phone system connection with SIP server function • IDAS™ Conventional and NXDN™ Type-D multi-site trunking connection
- Analogue radio system connection • Base station operation with optional microphone • External equipment, sensor connection
- Voice recording function to a USB drive\* (\*A USB drive required separately.) • Half-width 1U form design

### Supplied Accessories

- BC-236, AC adapter • Spare quick connectors • Antennas • Antenna bases with 1.5 m coaxial cable • Magnets and cushion sheets

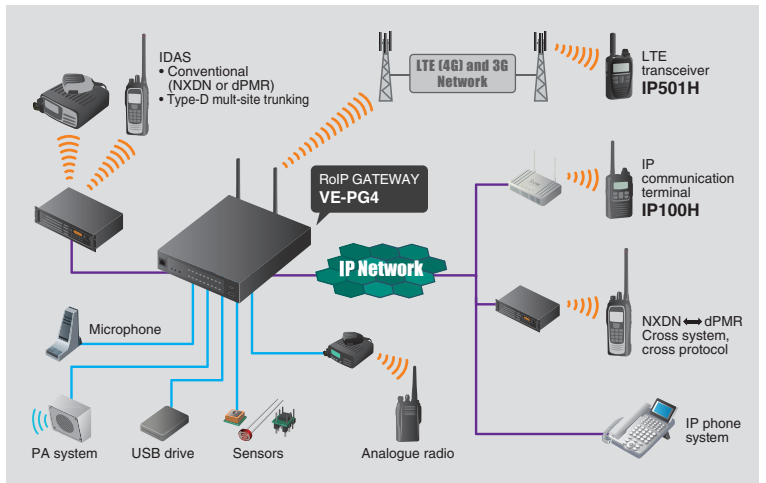
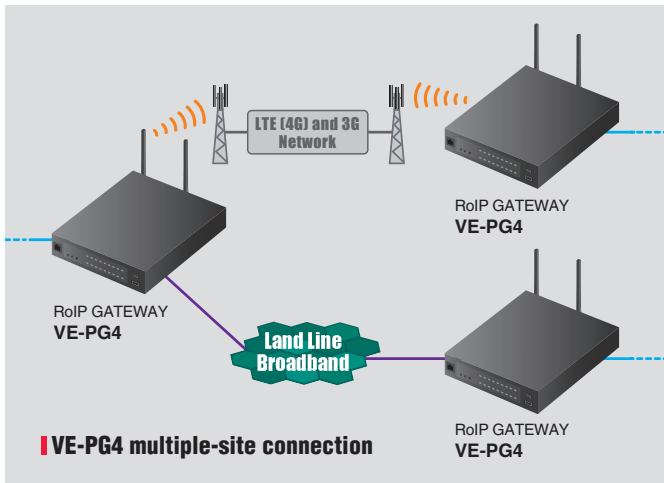

## REMOTE COMMUNICATOR RC-FS10



**Virtual Radio/PC Dispatch**



### FEATURES

- **PC remote communicator for IDAS™ conventional, NXDN™ Type-D multi-site trunking and analogue radio systems** (VE-PG4 is required for analogue radio systems.)









- Up to eight different IDAS and analogue radio systems can be programmed • Up to 40 programmable buttons. Short data message, status and DTMF can be sent • Caller ID, called ID, name and call type information are displayed • Communication log is displayed and can be stored • Optional HM-154 or SM-26 microphone can be used with the RC-FS10 (\*Optional CT-23 PTT microphone adapter is required.) • The CT-24 digital voice converter is supplied with RC-FS10 which converts microphone audio to the AMBE+2™ codec for the IDAS radio system.

### Supplied Accessories

- Installation CD • USB cable • CT-24, Digital converter











# OPTIONS FOR HANDHELD TRANSCEIVERS

MODEL NAME	BATTERY PACKS								
	BP-277EX (Li-ion) For intrinsically safe radios 7.4 V/1800 mAh (min.) 1900 mAh (typ.) 	BP-227AXD (Li-ion) For intrinsically safe radios 7.4 V/1850 mAh (min.) 1950 mAh (typ.) 	BP-284 (Li-ion) 7.2 V/3070 mAh (min.) 3210 mAh (typ.) 	BP-283 (Li-ion) 7.2 V/ 1910 mAh (min.) 2010 mAh (typ.) 	BP-232WP (Li-ion) 7.4 V/2200 mAh (min.) 2350 mAh (typ.) 	BP-294 (Li-ion) 7.2 V/3050 mAh (min.) 3150 mAh (typ.) 	BP-290 (Li-ion) 7.2 V/1910 mAh (min.) 2010 mAh (typ.) 	BP-280 (Li-ion) 7.2 V/2280 mAh (min.) 2400 mAh (typ.) 	BP-279 (Li-ion) 7.2 V/1485 mAh (min.) 1570 mAh (typ.) 
IC-F3400DT/DS/D IC-F4400DT/DS/D			✓	✓					
IC-F3262DT/DS IC-F4262DT/DS					✓				
IC-F52D IC-F62D						✓	✓		
IC-F1100DT/DS/D IC-F2100DT/DS/D								✓	✓
IC-F3202DEX IC-F4202DEX	✓								
IC-F51 ATEX IC-F61 ATEX		✓							
IC-F1000/T/S IC-F2000/T/S								✓	✓
IC-F29DR IC-F29DR2								✓	✓
IC-F29SR IC-F29SR2								✓	✓

MODEL NAME	BATTERY PACKS	BATTERY CASES				DESKTOP CHARGERS				
	BP-278 (Li-ion) 7.2 V/1130 mAh (min.) 1190 mAh (typ.) 	BP-240 LR03 (AAA) x6 cells 	BP-261 LR6 (AA) x6 cells 	BP-291 LR6 (AA) x5 cells 	BC-212EX*1 Rapid charger for intrinsically safe radios 	BC-219N Rapid charger 	BC-225 Intelligent charger 	BC-226 Connectable type. Connects up to six BC-226 units. 	BC-227 Compact rapid charger 	
IC-F3400DT/DS/D IC-F4400DT/DS/D						✓	✓	✓	✓	
IC-F3262DT/DS IC-F4262DT/DS		✓	✓							
IC-F52D IC-F62D				✓		✓	✓	✓	✓	
IC-F1100DT/DS/D IC-F2100DT/DS/D	✓									
IC-F3202DEX IC-F4202DEX					✓					
IC-F51 ATEX IC-F61 ATEX										
IC-F1000/T/S IC-F2000/T/S	✓									
IC-F29DR IC-F29DR2	✓									
IC-F29SR IC-F29SR2	✓									

\*1 The battery charger, BC-212EX must not be used in an explosive atmosphere.

MODEL NAME	DESKTOP CHARGERS					MULTI-CHARGERS		
	BC-160 Rapid charger 	BC-171 Regular charger 	BC-213 Rapid charger 	BC-119N Rapid charger 	BC-152N Regular charger 	BC-214*2 Rapid multi- charger 	BC-197*3 Rapid multi- charger 	BC-121N Rapid multi- charger 
IC-F3400DT/DS/D IC-F4400DT/DS/D						✓ (Use #23, AD-132N installed)		
IC-F3262DT/DS IC-F4262DT/DS	✓	✓					✓ (Use #23, AD-122 installed)	
IC-F52D IC-F62D						✓ (Use #23, AD-132N installed)		
IC-F1100DT/DS/D IC-F2100DT/DS/D			✓			✓ (Use #03, AD-130 installed)		
IC-F3202DEX IC-F4202DEX								
IC-F51 ATEX IC-F61 ATEX				✓ (AD-100 is required)	✓			✓ (Use with AD-100)
IC-F1000/T/S IC-F2000/T/S			✓			✓ (Use #03, AD-130 installed)		
IC-F29DR IC-F29DR2			✓			✓ (Use #03, AD-130 installed)		
IC-F29SR IC-F29SR2			✓			✓ (Use #03, AD-130 installed)		

\*2 Either AD-130 or AD-132N is supplied with the BC-214, depending on version. \*3 AD-122 is supplied with the BC-197, depending on version. The IC-F3202DEX/F4202DEX and IC-F51/F61 ATEX intrinsically models should only be used with the specified intrinsically safe approved options.

✓ : Applicable    □ : Not applicable

# OPTIONS FOR HANDHELD TRANSCEIVERS

MODEL NAME	CHARGER ADAPTERS				AC ADAPTERS				
	AD-132N*2 For BP-283, BP-284, BP-294 or BP-290	AD-122*3 For BP-232WP	AD-130*2 For BP-278, BP-279 or BP-280	AD-100 For BP-227AXD	BC-123S*4 12 V/1 A	BC-145S*4 16 V/0.93 A	BC-147S*4 12 V/0.33 A	BC-157S 12 V/7.5 A	BC-228 15 V/4 A
IC-F3400DT/DS/D IC-F4400DT/DS/D	✓ (Use with BC-214)				✓ (Use with BC-219N, BC-225 or BC-227)			✓ (Use with BC-214)	✓ (Use with BC-226)
IC-F3262DT/DS IC-F4262DT/DS		✓ (Use with BC-197)			✓ (Use with BC-160)		✓ (Use with BC-171)	✓ (Use with BC-197)	
IC-F52D IC-F62D	✓ (Use with BC-214)				✓ (Use with BC-219N, BC-225 or BC-227)			✓ (Use with BC-214)	✓ (Use with BC-226)
IC-F1100DT/DS/D IC-F2100DT/DS/D			✓ (Use with BC-214)		✓ (Use with BC-213)			✓ (Use with BC-214)	
IC-F3202DEX IC-F4202DEX					✓ (Use with BC-212EX)				
IC-F51 ATEX IC-F61 ATEX				✓ (Use with BC-119N or BC-121N)		✓ (Use with BC-119N)	✓ (Use with BC-152N)	✓ (Use with BC-121N)	
IC-F1000T/S IC-F2000T/S			✓ (Use with BC-214)		✓ (Use with BC-213)			✓ (Use with BC-214)	
IC-F29DR IC-F29DR2			✓ (Use with BC-214)		✓ (Use with BC-213)			✓ (Use with BC-214)	
IC-F29SR IC-F29SR2			✓ (Use with BC-214)		✓ (Use with BC-213)			✓ (Use with BC-214)	

\*4 BC-123SA/BC-145SA/BC-147SA for US plug, SE for EURO plug, SV for Australia plug, BC-123SUK/BC-145SUK for UK plug.

MODEL NAME	CHARGER BRACKET	CIGARETTE LIGHTER CABLE	DC POWER CABLES		READER SOFTWARE	SPEAKER-MICROPHONES			
	MB-130	CP-23L	OPC-656	OPC-515L	RS-BC225	HM-203EX For intrinsically safe radios IP67	HM-222 IP68	HM-184/H IP67	HM-233GP GPS IP67
IC-F3400DT/DS/D IC-F4400DT/DS/D		✓ (Use with BC-219N or BC-227)	✓ (Use with BC-214)	✓ (Use with BC-219N, BC-225 or BC-227)	✓ (Use with BC-225)		✓		
IC-F3262DT/DS IC-F4262DT/DS	✓ (Use with BC-160)	✓ (Use with BC-160)	✓ (Use with BC-197)					✓	
IC-F52D IC-F62D		✓ (Use with BC-219N or BC-227)	✓ (Use with BC-214)	✓ (Use with BC-219N, BC-225 or BC-227)	✓ (Use with BC-225)		✓		✓
IC-F1100DT/DS/D IC-F2100DT/DS/D	✓ (Use with BC-213)	✓ (Use with BC-213)	✓ (Use with BC-214)						
IC-F3202DEX IC-F4202DEX						✓			
IC-F51 ATEX IC-F61 ATEX									
IC-F1000T/S IC-F2000T/S	✓ (Use with BC-213)	✓ (Use with BC-213)	✓ (Use with BC-214)						
IC-F29DR IC-F29DR2	✓ (Use with BC-213)	✓ (Use with BC-213)	✓ (Use with BC-214)						
IC-F29SR IC-F29SR2	✓ (Use with BC-213)	✓ (Use with BC-213)	✓ (Use with BC-214)						

MODEL NAME	SPEAKER-MICROPHONES					TIE-CLIP MICROPHONE	EARPHONE-MICROPHONES		HEADSETS
	HM-168LWP IP67	HM-158LA	HM-159LA	HM-171GPW GPS IP67	HM-138 IPX7	HM-163MC	HM-153LA	HM-166LA	V5-3 Bluetooth® headset
IC-F3400DT/DS/D IC-F4400DT/DS/D									
IC-F3262DT/DS IC-F4262DT/DS									
IC-F52D IC-F62D						✓			✓
IC-F1100DT/DS/D IC-F2100DT/DS/D	✓	✓	✓	✓			✓	✓	
IC-F3202DEX IC-F4202DEX									
IC-F51 ATEX IC-F61 ATEX					✓				
IC-F1000T/S IC-F2000T/S	✓	✓	✓				✓	✓	
IC-F29DR IC-F29DR2	✓	✓	✓				✓	✓	
IC-F29SR IC-F29SR2	✓	✓	✓				✓	✓	



# OPTIONS FOR HANDHELD TRANSCEIVERS

MODEL NAME	HEADSETS					EARPHONES			
	HS-94 Earhook type with boom microphone	HS-94LWP Earhook type with waterproof connector	HS-95 Behind-the-head type	HS-95LWP Behind-the-head type with waterproof connector	HS-97 Throat microphone type	EH-15B	SP-26 Tube earphone	SP-27 Tube earphone	SP-28
IC-F3400DT/DS/D IC-F4400DT/DS/D	✓ (Use with VS-4MC)		✓ (Use with VS-4MC)		✓ (Use with VS-4MC)				
IC-F3262DT/DS IC-F4262DT/DS	✓ (Use with VS-4MC)		✓ (Use with VS-4MC)		✓ (Use with VS-4MC)				
IC-F52D IC-F62D	✓ (Use with VS-5MC)		✓ (Use with VS-5MC)		✓ (Use with VS-5MC)	✓ (Use with HM-163MC)	✓ (Use with HM-163MC)	✓ (Use with HM-222 or AD-135)	✓ (Use with HM-163MC)
IC-F1100DT/DS/D IC-F2100DT/DS/D	✓ (Use with VS-4LA or OPC-2004LA)	✓	✓ (Use with VS-4LA or OPC-2004LA)	✓	✓ (Use with VS-4LA or OPC-2004LA)				
IC-F3202DEX IC-F4202DEX									
IC-F51 ATEX IC-F61 ATEX									
IC-F1000T/S IC-F2000T/S	✓ (Use with VS-4LA or OPC-2004LA)	✓	✓ (Use with VS-4LA or OPC-2004LA)	✓	✓ (Use with VS-4LA or OPC-2004LA)				
IC-F29DR IC-F29DR2	✓ (Use with VS-4LA or OPC-2004LA)	✓	✓ (Use with VS-4LA or OPC-2004LA)	✓	✓ (Use with VS-4LA or OPC-2004LA)				
IC-F29SR IC-F29SR2	✓ (Use with VS-4LA or OPC-2004LA)	✓	✓ (Use with VS-4LA or OPC-2004LA)	✓	✓ (Use with VS-4LA or OPC-2004LA)				

MODEL NAME	EARPHONES			PLUG ADAPTER CABLE	PTT SWITCH CABLES			ACC ADAPTERS	
	SP-29	SP-32 Tube earphone adapter	SP-40	OPC-2004LA VOX operation	VS-5MC Manual PTT/VOX operation	VS-4MC Manual PTT operation	VS-4LA Manual PTT operation	AD-118 Allows you to use 6-pin Hirose plug accessories	AD-135 3.5 mm jack earphone adapter
IC-F3400DT/DS/D IC-F4400DT/DS/D							✓	✓	
IC-F3262DT/DS IC-F4262DT/DS							✓	✓	
IC-F52D IC-F62D	✓ (Use with HM-222 or AD-135)	✓ (Use with EH-15B)	✓ (Use with HM-222 or AD-135)		✓			✓	✓
IC-F1100DT/DS/D IC-F2100DT/DS/D				✓			✓		
IC-F3202DEX IC-F4202DEX									
IC-F51 ATEX IC-F61 ATEX									
IC-F1000T/S IC-F2000T/S				✓			✓		
IC-F29DR IC-F29DR2				✓			✓		
IC-F29SR IC-F29SR2				✓			✓		

MODEL NAME	BELT CLIPS			BELT HANGERS			CARRYING CASES		
	MB-94EX For intrinsically safe radios	MB-136 MB-93 MB-86 Swivel type	MB-133 MB-98 MB-94/R MBB-3 Alligator type	MB-96N	MB-96F	MB-96FL	LC-184 For IC-F3400DT/DS, F4400DT/DS	LC-186 For IC-F3400D, F4400D	LC-187*5 For use with BP-290
IC-F3400DT/DS/D IC-F4400DT/DS/D		✓ (Use MB-136)	✓ (Use MB-133)	✓	✓	✓	✓	✓	
IC-F3262DT/DS IC-F4262DT/DS		✓ (Use MB-93)	✓ (Use MB-94/R)	✓	✓	✓			
IC-F52D IC-F62D		✓ (Use MB-136)	✓ (Use MBB-3)	✓	✓	✓			✓
IC-F1100DT/DS/D IC-F2100DT/DS/D			✓ (Use MB-133)						
IC-F3202DEX IC-F4202DEX	✓								
IC-F51 ATEX IC-F61 ATEX		✓ (Use MB-86)	✓ (Use MB-98)		✓				
IC-F1000T/S IC-F2000T/S			✓ (Use MB-133)						
IC-F29DR IC-F29DR2			✓ (Use MB-133)						
IC-F29SR IC-F29SR2			✓ (Use MB-133)						

\*5 Charging is possible while the case is attached.  
Some options may not be available in some countries. Please ask your dealer for details.

✓ : Applicable    □ : Not applicable

# OPTIONS FOR HANDHELD TRANSCEIVERS

MODEL NAME	CARRYING CASES		ANTENNAS				CUT ANTENNAS		HIGH GAIN ANTENNAS
	LC-188 For use with BP-290	LC-190*5 For use with BP-294	FA-S81V 136-150 MHz FA-S82V 148-162 MHz FA-S83V 160-174 MHz FA-S81U 380-430 MHz FA-S82U 430-480 MHz	FA-SC25V 136-150 MHz FA-SC55V 150-174 MHz FA-SC25U 400-430 MHz FA-SC57U 430-470 MHz	FA-SC25V 136-150 MHz FA-SC28V 148-162 MHz FA-SC29V 160-174 MHz FA-SC25U 400-430 MHz FA-SC57U 430-470 MHz	FA-S24V 136-150 MHz FA-S59V 150-174 MHz FA-S27U 400-470 MHz FA-S56U 450-520 MHz	FA-S67VC 136-174 MHz FA-S76UC 380-520 MHz	FA-SC61VC 136-174 MHz FA-SC61UC 380-520 MHz	FA-SC62V 150-160 MHz FA-SC63V 155-165 MHz
IC-F3400DT/DS/D IC-F4400DT/DS/D			✓				✓		
IC-F3262DT/DS IC-F4262DT/DS				✓				✓	✓
IC-F52D IC-F62D	✓	✓			✓			✓	✓
IC-F1100DT/DS/D IC-F2100DT/DS/D				✓				✓	✓
IC-F3202DEX IC-F4202DEX				✓					
IC-F51 ATEX IC-F61 ATEX						✓			
IC-F1000T/S IC-F2000T/S				✓				✓	✓
IC-F29DR IC-F29DR2									
IC-F29SR IC-F29SR2									

\*5 Charging is possible while the case is attached.

MODEL NAME	STUBBY ANTENNAS		
	FA-S81VS 136-150 MHz FA-S82VS 150-160 MHz FA-S83VS 160-174 MHz FA-S81US 400-450 MHz FA-S82US 450-490 MHz	FA-SC26VS 136-144 MHz FA-SC27VS 142-150 MHz FA-SC56VS 150-162 MHz FA-SC57VS 160-174 MHz FA-SC26US 400-450 MHz FA-SC73US 450-490 MHz	FA-S62VS 150-162 MHz FA-S63VS 160-174 MHz FA-S57US 450-490 MHz
IC-F3400DT/DS/D IC-F4400DT/DS/D	✓		
IC-F3262DT/DS IC-F4262DT/DS		✓	
IC-F52D IC-F62D		✓	
IC-F1100DT/DS/D IC-F2100DT/DS/D		✓	
IC-F3202DEX IC-F4202DEX			
IC-F51 ATEX IC-F61 ATEX			✓
IC-F1000T/S IC-F2000T/S		✓	
IC-F29DR IC-F29DR2			
IC-F29SR IC-F29SR2			

## Intelligent Battery Management

The intelligent battery charger software checks the battery health, battery age and battery cycle count whenever a battery is inserted into an intelligent charger. The Eco Mode stops charging at approximately 80-90% to extend the battery's life. The batteries can be optimally maintained, and an indication of timing for battery replacement is given.

• BC-225 intelligent charger and RS-BC225 reader software for IC-F3400D/F4400D and IC-F52D/F62D series.

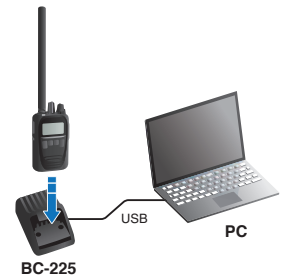

RS-BC225										
File View Charger Help										
RS-BC225										
Charger List										
Battery List										
No.	Battery Name	Charge Status	Eco Mode	Charge [%]	Volt. [V]	Temp. [°C]	Health [%]	Cycle Count	Age [day]	
1	Serial 3085	Charging	OFF	31	7.27	30.8	99	0	0	
2	Serial 3106			40	7.36	30.1	99	0	0	
3	Serial 1472			99	8.32	22.8	100	4	0	

MODEL NAME	LICENCE KEYS				
	ISL-UGMTR NXDN™ Type-D trunking upgrade key (for NXDN™ protocol)	ISL-UGMD3 dPMR™ Mode 3 trunking upgrade key (for dPMR™ protocol)	ISL-AKAES AES encryption activation key	ISL-CHEX Channel expansion key increases channel number up to 4000	ISL-AKSTM Dealer set mode activation key
IC-F3400DT/DS/D IC-F4400DT/DS/D	✓	✓	✓	✓	✓
IC-F52D IC-F62D	✓	✓			
IC-F5400D/DS IC-F6400D/DS	✓	✓	✓	✓	✓

Some options may not be available in some countries. Please ask your dealer for details.

# SPECIFICATIONS FOR HANDHELD TRANSCEIVERS

	IC-F3400D, IC-F4400D series	IC-F3262D, IC-F4262D series	IC-F52D IC-F62D	IC-F1100D, IC-F2100D series	IC-F3202DEX IC-F4202DEX	IC-F51 ATEX IC-F61 ATEX	IC-F1000, IC-F2000 series	IC-F29DR IC-F29DR2	IC-F29SR IC-F29SR2
Frequency coverage	136–174 MHz	136–174 MHz	136–174 MHz	136–174 MHz	136–174 MHz	136–174 MHz	136–174 MHz	IC-F29DR (A): 446.0–446.1 MHz*1 (D): 446.1–446.2 MHz*1	IC-F29SR (Analogue): 446.0–446.1 MHz*1
	380–470 MHz	400–470 MHz	400–470 MHz	400–470 MHz	400–470 MHz	400–470 MHz	400–470 MHz	IC-F29DR2 (A): 446.0–446.2 MHz*1 (D): 446.0–446.2 MHz*1	IC-F29SR2 (Analogue): 446.0–446.2 MHz*1
Number of channels	4000/1024 channels*2 128 zones	512 channels 128 zones	512 channels 128 zones	128 ch (DT, DS) 16 ch *3 (D)	16 channels	128 channels 8 zones	128 ch (T, S) 16 ch *3 (Non-LCD)	IC-F29DR: (A) 8 ch, (D) 16 ch IC-F29DR2: (A) 16 ch, (D) 32 ch	IC-F29SR: (Analogue) 8 ch IC-F29SR2: (Analogue) 16 ch
Channel spacing	6.25, 12.5, 20, 25 kHz	6.25, 12.5, 20, 25 kHz	6.25, 12.5, 20, 25 kHz	6.25, 12.5, 20, 25 kHz	6.25, 12.5, 20, 25 kHz	12.5, 20, 25 kHz	12.5, 20, 25 kHz	6.25, 12.5 kHz	12.5 kHz
Dimensions (W × H × D; Projections are not included)	53.6 × 123.5 × 29.3 mm (with BP-283)	53.5 × 142.7 × 39.5 mm (with BP-232WP)	56 × 91.5 × 29 mm (with BP-290)	52.2 × 111.8 × 29.4 mm (with BP-280) (DS, D) 52.2 × 111.8 × 34.1 mm (with BP-280) (DT)	63 × 144 × 50 mm (with BP-277EX)	56 × 97 × 36.4 mm (with BP-227AXD)	52.2 × 111.8 × 24.5 mm (with BP-279)	52.2 × 186.1 × 30.3 mm (with BP-280)	52.2 × 186.1 × 24.5 mm (with BP-279)
Weight (approx.)	305 g (VHF) 300 g (UHF) (with BP-283, belt clip & ant.)	410 g (VHF) 400 g (UHF) (with BP-232WP, belt clip & ant.)	230 g (With BP-290 & belt clip)	260 g (D), 270 g (DS), 280 g (DT) (With BP-280 & belt clip)	466 g (VHF) 460 g (UHF) (with BP-277EX, belt clip & ant.)	295 g (with BP-227AXD)	240 g (with BP-279)	270 g (With BP-280 and belt clip)	240 g (With BP-279)
RF output power (High)	5 W (VHF/UHF)	5 W (VHF/UHF)	5 W (VHF/UHF)	5 W (VHF) 4 W (UHF)	1 W (VHF/UHF)	1 W (VHF/UHF)	5 W (VHF) 4 W (UHF)	500 mW ERP	500 mW ERP
Sensitivity	(Analogue, W/M/N) -5.5/-5.5/-2.5 dBµV typ. (VHF) -5.0/-5.0/-2.0 dBµV typ. (UHF) (emf, at 20 dB SINAD)	-4 dBµV typ. (emf, at 20 dB SINAD)	-4/-4/-1.4 dBµV typ. (VHF) -4/-4/-1.1 dBµV typ. (UHF) (emf, at 20 dB SINAD)	-5/-5/-2 dBµV typ. (UHF) (emf, at 20 dB SINAD)	-4 dBµV typ. (emf, at 20 dB SINAD)	-4 dBµV typ. (emf, at 20 dB SINAD)	-4 dBµV typ. (emf, at 20 dB SINAD)	26.5 dBµV/m (emf, at 20 dB SINAD)	26.5 dBµV/m (emf, at 20 dB SINAD)
	(Digital) -5.5 dBµV typ. (VHF) -4 dBµV typ. (UHF) (emf, at 1% BER)	-8 dBµV typ. (emf, at 5% BER)	-5 dBµV typ. (VHF) -4 dBµV typ. (UHF) (emf, at 1% BER)	-8 dBµV typ. (emf, at 5% BER)	-8 dBµV typ. (emf, at 5% BER)	-8 dBµV typ. (emf, at 5% BER)	-	-8 dBµV typ. (emf, at 5% BER)	-
Intermodulation	(Analogue) 67 dB typ. (VHF) 68 dB typ. (UHF)	67 dB typ.	68 dB typ.	69 dB typ. (VHF) 70 dB typ. (UHF)	67 dB typ.	67 dB typ.	68 dB typ. (VHF) 67 dB typ. (UHF)	86.29 dBµV/m	86.29 dBµV/m
	(Digital, emf) 72 dBµV typ. (VHF) 73 dBµV typ. (UHF)	73 dBµV typ.	73 dBµV typ.	74 dBµV typ.	73 dBµV typ.	-	-	74 dBµV typ.	-
AF output power	Internal SP 1300 mW typ.	800 mW typ.	1300 mW typ.	1500 mW typ.	800 mW (typ. 32Ω)	-	1500 mW typ.	800 mW typ.	1500 mW typ.
	External SP 1000 mW typ.	1000 mW typ.	1000 mW typ.	400 mW typ.	400 mW (typ. 32Ω)	500 mW typ.	400 mW typ.	400 mW typ.	400 mW typ.

\*1 We suggest you confirm the PMR 446 frequency allocation status in your country before use.

\*2 Upgrade licence(ISL-CHEX) required to enable 4000 channel capacity. IC-F3400D/DP/F4400D/DP (Non-LCD type): Up to 32 selected channels out of 1024 can be allocated to the channel knob.

\*3 IC-F1100D/F2100D/IC-F1000/F2000 (Non-LCD type): Up to 16 selected channels out of 128 can be allocated to the channel knob.

	IC-F3400D, IC-F4400D series	IC-F3262D, IC-F4262D series	IC-F52D IC-F62D	IC-F1100D, IC-F2100D series	IC-F3202DEX IC-F4202DEX	IC-F51 ATEX IC-F61 ATEX	IC-F1000, IC-F2000 series	IC-F29DR IC-F29DR2	IC-F29SR IC-F29SR2
NXDN™*4	Conventional	✓	✓	✓	✓	-	-	-	-
	Multi-site conventional	✓	✓	✓	✓	-	-	-	-
	Type-D Trunking	✓ (With ISL-UGMTR)	✓	✓ (With ISL-UGMTR)	✓ (Single-site)	✓ (Single-site)	-	-	-
dPMR™*4	Mode 1/ Mode 2	✓	✓	✓	✓	-	-	-	-
	Mode 2 Multi-site	✓	✓	✓	✓	-	-	-	-
	Mode 3 Trunking	✓ (With ISL-UGMD3)	✓	✓ (With ISL-UGMD3)	-	-	-	-	-
dPMR™ 446 (Licence-free)	-	-	-	-	-	-	✓	-	-
Encryption	DES (4-key)	✓	-	-	-	-	-	-	-
	DES (64-key)	✓ (With UT-134)	-	-	-	-	-	-	-
	AES	✓ (With UT-134, ISL-AKAES)	-	-	-	-	-	-	-
Voice Scrambler (Digital)	✓	✓	✓	✓	✓	-	-	-	-
Voice Scrambler (Analogue)*5	✓ (Inversion)	✓ (Inversion)	✓ (Inversion)	-	-	✓ (Inversion/rolling)	✓ (Inversion)	-	✓ (Inversion)
OTAP (Over-the-Air Programming)	✓ (With CS-OTPM1)	-	✓ (With CS-OTPM1)	-	-	-	-	-	-
CTCSS/DTCS	encoder/decoder	✓	✓	✓	✓	✓	✓	✓	✓
2-Tone	encoder/decoder	✓	✓	✓	✓	✓	✓	-	-
5-Tone	encoder/decoder	✓	✓	✓	✓	✓	✓	-	-
DTMF autodial	✓	✓	✓	✓	✓	✓	✓	-	-
DTMF decoder	✓*7	✓*7	-	-	-	-	-	-	-
BIIS 1200	✓	✓	✓	✓*8	✓*9	✓	✓*8	-	-
MDC 1200	✓	-	✓	-	-	✓	✓*10	-	-
Man Down function	✓	✓*11	✓	✓	-	-	✓	-	-
Motion detection sensor	✓	-	✓	✓	-	-	✓	-	-
Intrinsically safe	-	-	-	-	✓	✓	-	-	-
Channel announcement	✓	-	✓	✓	✓	-	✓	✓	✓
Vibration alert	✓	-	✓	-	-	-	-	-	-
Voice recorder	✓	-	✓	-	-	-	-	-	-
Bluetooth®	✓	-	✓	-	-	-	-	-	-
GPS receiver	✓	✓*11	HM-233GP	HM-171GPW	-	-	-	-	-
Operating time*6	10 hours with BP-283 16 hours with BP-284	12/10.5 hours*12 with BP-232WP	13 hours with BP-290 18.5 hours with BP-294	18 hours with BP-280 12 hours with BP-279	21.5/19 hours with BP-277EX (VHF/UHF)	16.5 hours with BP-227AXD	20 hours with BP-280 14 hours with BP-279	26 hours with BP-280 17 hours with BP-279	33 hours with BP-280 21 hours with BP-279
IP rating	IP68 (1 m depth 1 hour)	IP67	IP67/66/55/54	IP67	IP67	IP67	IP67	IP67	IP67
MIL-STD requirements	MIL-810 G	MIL-810 G	MIL-810 G	MIL-810 G	MIL-810 G	MIL-810 F	MIL-810 G	MIL-810 G	MIL-810 G

\*4 IDAS radios are shipped with either the NXDN or dPMR firmware. Change of digital protocol may be performed by the dealer or distributor.

\*5 Inversion type voice scrambler is not compatible with UT-109R/UT-110R voice scrambler.

\*6 Conventional mode. 5:5:90 duty cycle, power save ON. \*7 Possible as a kind of 5-Tone format.

\*8 PTT ID and emergency call. \*9 PTT ID only. \*10 Limited functions. \*11 Depending on version. \*12 Non GPS/GPS type.

✓ : Available - : Not available

# OPTIONS FOR MOBILE TRANSCEIVERS AND REPEATERS

MODEL NAME	HAND MICROPHONES								
	HM-221 IP55	HM-211T with DTMF keypad IP55	HM-220 Heavy-duty type IP54	HM-220T Heavy duty type with DTMF keypad IP54	HM-211 Noise Canceling Mic	HM-152	HM-152T with DTMF keypad IP54	HM-148G Heavy-duty type	HM-148T Heavy duty type with DTMF keypad
IC-F5400D, IC-F6400D	✓	✓	✓	✓					
IC-F5400DS, IC-F6400DS	✓	✓	✓	✓					
IC-F5062D, IC-F6062D					✓	✓	✓	✓	✓
IC-F5122D, IC-F6122D					✓	✓	✓	✓	✓
IC-F5022, IC-F6022						✓	✓	✓	✓
IC-F5012						✓	✓	✓	✓
IC-FR5100, IC-FR6100						✓			

MODEL NAME	DESKTOP MICROPHONES		EXTERNAL SPEAKERS		SEPARATION KITS			COMMANDMIC™	SEPARATION CABLES
	SM-29	SM-26	SP-30	SP-35 2 m cable SP-35L 6 m cable	RMK-5	RMK-7 Dual head	RMK-3	HM-218 Secondary controller for use with RMK-5 IP55	OPC-2364 (1.9 m) OPC-2365 (3 m) OPC-2366 (5 m) OPC-2367 (8 m) For use with RMK-5 or RMK-7
IC-F5400D, IC-F6400D	✓		✓	✓	✓ (Separation cable is required)	✓ (Separation cable is required)	✓ (Separation cable is required)	✓	
IC-F5400DS, IC-F6400DS	✓		✓	✓					
IC-F5062D, IC-F6062D		✓	✓	✓			✓ (OPC-609 is required)		
IC-F5122D, IC-F6122D		✓	✓	✓					
IC-F5022, IC-F6022		✓	✓	✓					
IC-F5012		✓	✓	✓					
IC-FR5100, IC-FR6100		✓	✓	✓					

MODEL NAME	SEPARATION CABLES		GPS ANTENNA	ACC CABLES		CHANNEL MODULES	POWER AMPLIFIERS	NETWORK CONTROLLER	ETHERNET BOARD
	OPC-2373 (1.9 m) OPC-2374 (8 m) For use with HM-218, COMMANDMIC	OPC-609 (1.9 m) for use with RMK-3	UX-241	OPC-1939 (15-pin) OPC-2078 (25-pin) <small>(Photo shows OPC-1939)</small>	OPC-2202 UR-PA5000/PA6000 connection cable	UR-FR5100 136–174 MHz, 25 W UR-FR6100 400–470 MHz, 25 W	UR-PA5100 136–174 MHz, 50 W 100% duty UR-PA6100 400–470 MHz, 50 W 100% duty	UC-FR5000 For IDAS™ multi- site networking	UC-FR5000SE For connection with IC-FC5000E
IC-F5400D, IC-F6400D	✓		✓						
IC-F5400DS, IC-F6400DS			✓						
IC-F5062D, IC-F6062D		✓							
IC-F5122D, IC-F6122D				✓*					
IC-F5022, IC-F6022				✓					
IC-F5012				✓					
IC-FR5100, IC-FR6100					✓	✓	✓	✓	✓

\* No digital modulation "IN" using accessory cables.

Some options may not be available in some countries. Please ask your dealer for details.

# SPECIFICATIONS FOR MOBILE TRANSCEIVERS AND REPEATERS

	IC-F5400D, IC-F6400D Series	IC-F5062D IC-F6062D	IC-F5122D IC-F6122D	IC-F5122DD IC-F6122DD	IC-F5022 IC-F6022	IC-F5012	IC-FR5100 IC-FR6100	
<b>Frequency coverage</b>	136–174 MHz 380–470 MHz	136–174 MHz 400–470 MHz	136–174 MHz 400–470 MHz	136–174 MHz 400–470 MHz	136–174 MHz 400–470 MHz	136–174 MHz —	136–174 MHz 400–470 MHz	
<b>Number of channels</b>	4000/1024 channels <sup>*1</sup> 128 zones	512 channels 128 zones	128 channels 128 zones	128 channels	128 channels 8 zones	8 channels	32 channels	
<b>Channel spacing</b>	6.25, 12.5, 20, 25 kHz	6.25, 12.5, 20, 25 kHz	6.25, 12.5, 20, 25 kHz	6.25, 12.5 kHz	12.5, 20, 25 kHz	12.5, 20, 25 kHz	6.25, 12.5, 20, 25 kHz	
<b>Power supply requirements</b>	13.2 V DC	13.2 V DC	13.2 V DC	13.2 V DC	13.2 V DC	13.2 V DC	13.2 V DC	
<b>Dimensions</b> (W × H × D; Projections are not included)	174 × 55 × 150 mm	160 × 45 × 150 mm	150 × 40 × 117.5 mm	150 × 40 × 134.7 mm	150 × 40 × 117.5 mm	150 × 40 × 117.5 mm	483 × 88 × 260 mm	
<b>Weight (approx.)</b>	1.5 kg	1.3 kg	800 g	900 g	800 g	800 g	5.6 kg	
<b>RF output power (High)</b>	25 W	25 W	25 W	25 W	25 W	25 W	25 W	
<b>Sensitivity:</b>	(Analogue)	–4 dBµV typ. (emf, at 20 dB SINAD)	–4 dBµV typ. (emf, at 20 dB SINAD)	–4 dBµV typ. (emf, at 20 dB SINAD)	–	–4 dBµV typ. (emf, at 20 dB SINAD)	–4 dBµV typ. (emf, at 20 dB SINAD)	0 dBµV (min.) (emf, at 20 dB SINAD)
	(Digital)	–6 dBµV typ. (emf, at 1% BER)	–8 dBµV typ. (emf, at 5% BER)	–8 dBµV typ. (emf, at 5% BER)	–4/–5 dBµV typ. (DN/DVN) (emf, at 1% BER)	–	–	0 dBµV typ. (emf, at 1% BER)
<b>Intermodulation rejection</b>	(Analogue)	70 dB typ.	70 dB typ.	67 dB typ.	–	67 dB typ.	67 dB typ.	72 dB typ.
	(Digital, emf)	70 dB typ.	–	–	68/66dB typ. (DN/DVN)	–	–	76 dBµV typ. (VHF) 74 dBµV typ. (UHF)
<b>AF output power (Internal SP)</b>	4 W typ.	4 W typ.	4 W typ.	–	4 W typ.	4 W typ.	3.5 W	

DN (Digital Narrow): 12.5 kHz. DVN (Digital Very Narrow): 6.25 kHz

\*1 Upgrade licence (ISL-CHEX) required to enable 4000 channel capacity. IC-F5400DS/DPS/F6400DS/DPS (Segment type display): Channel indication is possible for up to 99 selected channels out of 1024.

	IC-FC5000E
<b>Power supply requirements</b>	12 V DC
<b>Dimensions</b> (W × H × D; Projections are not included)	483 × 44 × 219 mm
<b>Weight (approx.)</b>	2.25 kg
<b>LAN</b>	RJ-45 connector × 4 (100BASE-TX)
<b>WAN</b>	RJ-45 connector × 1 (100BASE-TX)
<b>LED</b>	Power, Error, Status
<b>Conformity standard</b>	ETSI TS 102 658

		IC-F5400D IC-F6400D Series	IC-F5062D IC-F6062D	IC-F5122D IC-F6122D	IC-F5022 IC-F6022	IC-F5012	IC-FR5100 IC-FR6100
<b>NXDN™<sup>*2</sup></b>	Conventional	✓	✓	✓	–	–	✓
	Multi-site conventional	✓	✓	✓	–	–	UC-FR5000 + CF-FR5000MC
	Type-D Trunking	✓ (With ISL-UGMTR)	✓	✓ (Single-site)	–	–	UC-FR5000 + CF-FR5000MT
<b>dPMR™<sup>*2</sup></b>	Mode 1/ Mode 2	✓	✓	✓	–	–	✓
	Mode 2 Multi-site	✓	✓	✓	–	–	UC-FR5000 (#12 required)
	Mode 3 Trunking	✓ (With ISL-UGMD3)	✓ <sup>*4</sup>	–	–	–	UC-FR5000SE <sup>*8</sup>
<b>Encryption</b>	DES (4-key)	✓	–	–	–	–	–
	DES (64-key)	✓ (With UT-134)	–	–	–	–	–
	AES	✓ (With UT-134, ISL-AKAES)	–	–	–	–	–
<b>Voice Scrambler (Digital)</b>	✓	✓	✓	–	–	–	✓
<b>Voice Scrambler (Analogue)<sup>*3</sup></b>	✓ (Inversion)	✓ (Inversion)	–	–	–	–	✓ (Inversion)
<b>OTAP (Over-the-Air Programming) function</b>	✓ (With CS-OTPM1)	–	–	–	–	–	–
<b>CTCSS/DTCS</b>	encoder/decoder	✓	✓	✓	✓	✓	✓
<b>2-Tone</b>	encoder/decoder	✓	✓	✓	✓	✓	–
<b>5-Tone</b>	encoder/decoder	✓	✓	✓	✓	✓	✓
<b>DTMF autodial</b>	✓	✓	✓	✓	✓	✓	✓
<b>DTMF decoder</b>	✓ <sup>*5</sup>	✓ <sup>*5</sup>	–	–	–	–	–
<b>BISS 1200</b>	✓	✓	–	✓ <sup>*6</sup>	✓ <sup>*6</sup>	✓ <sup>*6</sup>	–
<b>MDC 1200</b>	✓	–	–	–	✓	✓	–
<b>Lone Worker function</b>	✓	✓	✓	✓	✓	✓	–
<b>Channel announcement</b>	✓	–	–	–	–	–	–
<b>Voice recorder</b>	✓	–	–	–	–	–	–
<b>Bluetooth®</b>	✓	–	–	–	–	–	–
<b>GPS receiver</b>	Built-in (UX-241 antenna required)	–	–	–	–	–	–
<b>IP rating</b>	IP55	IP55 <sup>*7</sup>	–	–	–	–	–
<b>MIL-STD requirements</b>	MIL-810 G	MIL-810 F	MIL-810 F	MIL-810 F	MIL-810 F	MIL-810 F	MIL-810 F

\*2 IDAS radios are shipped with either the NXDN or dPMR firmware. Change of digital protocol may be performed by the dealer or distributor.

\*3 Inversion type voice scrambler is not compatible with UT-109R/UT-110R voice scrambler.









\*4 Depending on version. \*5 Possible as a kind of 5-Tone format. \*6 PTT ID only.

\*7 IP dust and water tests were performed on the controller and RMK-3 only.









\*8 IC-FC5000E dPMR Mode 3 Trunking Controller required.

✓ : Available    – : Not available









# OPTIONS FOR IP ADVANCED RADIO SYSTEM

	BATTERY PACKS		BATTERY CASE	DESKTOP CHARGERS			MULTI-CHARGER	AC ADAPTERS	
MODEL NAME	<b>BP-272</b> (Li-ion) 7.4 V/1880 mAh (min.) 2000 mAh (typ.) 	<b>BP-271</b> (Li-ion) 7.4 V/1150 mAh (min.) 1200 mAh (typ.) 	<b>BP-273</b> LR6 (AA) x3 cells 	<b>BC-202</b> Rapid charger 	<b>BC-202IP2</b> Rapid charger with smart charging function 	<b>BC-218</b> Rapid charger cradle with Bluetooth® 	<b>BC-211</b> Rapid multi-charger 	<b>BC-123S</b> *1 12 V/1 A 	<b>BC-157S</b> 12 V/7.5 A 
IP501H	✓	✓			✓	✓	✓	✓ (Use with BC-202IP2)	✓ (Use with BC-211)
IP100H	✓	✓	✓	✓			✓	✓ (Use with BC-202)	✓ (Use with BC-211)

\*1 BC-123SA for US plug, SE for Europe plug, SUK for UK plug, SV for Australia plug.

	AC ADAPTERS	CIGARETTE LIGHTER CABLES	SPEAKER-MICROPHONES			EARPHONE-MICROPHONES	HEADSETS		
MODEL NAME	<b>BC-207S</b> 12 V/4.2 A 	<b>CP-22</b> With DC-DC converter 	<b>CP-23L</b> 	<b>HM-183LS</b> IPX7 	<b>HM-186LS</b> 	<b>HM-215</b> 	<b>HM-153LS</b> 	<b>HM-166LS</b> 	<b>VS-3</b> Bluetooth® headset 
IP501H	✓ (Use with BC-218)	✓ (Use with BC-218)	✓ (Use with BC-218)	✓	✓	✓ (Use with BC-218)	✓	✓	✓
IP100H				✓	✓		✓*2	✓*2	

\*2 Full-duplex operation can be possible with either HS-102 with OPC-2359, HM-153LS or HM-166LS.

	HEADSETS				PLUG ADAPTER CABLE	PTT SWITCH CABLES	BELT CLIPS	CARRYING CASES	
MODEL NAME	<b>HS-94</b> Earhook type with boom microphone 	<b>HS-95</b> Behind-the-head type 	<b>HS-97</b> Throat microphone type 	<b>HS-102</b> Earphone type 	<b>OPC-2006LS</b> VOX operation 	<b>OPC-2328</b> 	<b>OPC-2359</b> 	<b>MB-127</b> <b>MB-135</b> Alligator type 	<b>LC-183</b> For use BP-271 
IP501H	✓*3 (Use with OPC-2006LS or OPC-2328)	✓*3 (Use with OPC-2006LS or OPC-2328)	✓*3 (Use with OPC-2006LS or OPC-2328)	✓ (Use with OPC-2359)	✓	✓	✓	✓ (Use MB-135)	✓
IP100H	✓*3 (Use with OPC-2006LS or OPC-2328)	✓*3 (Use with OPC-2006LS or OPC-2328)	✓*3 (Use with OPC-2006LS or OPC-2328)	✓*2 (Use with OPC-2359)	✓	✓	✓	✓ (Use MB-127)	

\*2 Full-duplex operation can be possible with either HS-102 with OPC-2359, HM-153LS or HM-166LS.

\*3 HS-94, HS-95 and HS-97 headsets are simplex operation only.

	CARRYING CASES	MOUNT BASE	BRACKET ADAPTER
MODEL NAME	<b>LC-185</b> For use BP-272 	<b>MBF-1</b> For use with BC-218 	<b>MBA-7</b> For use with BC-218 
IP501H	✓	✓ (Use with MBA-7)	✓ (Use with MBF-1)
IP100H			

# OPTIONS FOR IP ADVANCED RADIO SYSTEM & RoIP GATEWAY

MODEL NAME	AC ADAPTERS			AUDIO/DATA CONNECTION CABLES					SPEAKER-MICROPHONE
	BC-236 12 V / 8.3 A	BC-2075 12 V / 4.2 A	BC-1475*4 12 V/0.33 A	OPC-2273 For VHF marine transceiver 5 m	OPC-2275 For mobile transceiver 5 m	OPC-2276 For HM-152 or SM-26 5 m	OPC-2389 For RS-232 serial connection 5 m	OPC-2390 For IC-FR5100 series 5 m	
VE-PG4	✓			✓	✓	✓	✓	✓	✓
AP-90M		✓							
IP100FS			✓ (Use with CT-23)						
RC-FS10			✓ (Use with CT-23)						

\*4 BC-1475A for US plug, SE for EURO plug, SV for Australia plug.

MODEL NAME	HAND MICROPHONES			DESKTOP MICROPHONE	MICROPHONE ADAPTER	ACCESS POINT MANAGER
	HM-152	HM-152T DTMF keypad type	HM-216 Short cable*6	SM-26	CT-23	RS-AP3
VE-PG4	✓*5	✓*5	✓*5	✓*5		
AP-90M						✓
IP100FS	✓ (Use with CT-23 and BC-1475)			✓ (Use with CT-23 and BC-1475)	✓	
RC-FS10	✓ (Use with CT-23 and BC-1475)			✓ (Use with CT-23 and BC-1475)	✓	

\*5 The HM-152, HM-152T, HM-216 and SM-26 has no speaker function. An external speaker is required to be connected to the VE-PG4 to hear received audio with these options.

\*6 The HM-216 has a total of 490 mm cable length including a 300 mm curl code, while the HM-152 has a total of 900 mm cable length. Some options may not be available in some countries. Please ask your dealer for details.

# SPECIFICATIONS FOR RoIP GATEWAY

		VE-PG4
Power supply		100–240 V AC 12 V DC, 4 A maximum (with supplied AC adapter)
Dimensions (W × H × D; projections not included)		213 × 36.8 × 270 mm
Weight (approx.)		1.8 kg
Regulatory compliance		FCC Part 15 Class B/ ICES003, Part22, Part24, Part27, EN301 489-1, EN301 489-19, EN301 489-52, EN301 908-1, EN301 908-2, EN301 908-13, EN303 413, EN62479 EN62311, EN62368-1
LAN/WAN		RJ-45 connector × 1 10BASE-T/100BASE-TX/1000BASE-T (AUTO MDI/MDI-X)
LAN		RJ-45 connector × 1 10BASE-T/100BASE-TX/1000BASE-T (AUTO MDI/MDI-X)
EXT 1–4 port	Audio input	–10 dBs/–40 dBs selectable, 10 kΩ impedance
	Audio output	0 dBs/–20 dBs selectable, 600 Ω load / 8 Ω 1 W speaker
	Control input	Low voltage contacts (3.3 V DC/ 1 mA)/ Voltage input (3–16 V)
	Control output	No voltage contacts (30 V/ 500 mA)/ Open collector (3–16 V/ 10 mA)
	Connectors	2.54 mm (0.1 in) pitch quick connector (4 terminals ×3) ×4
Network	4G bands:	LTE B1, B3, B7, B8, B20 (EUR) LTE B2, B4, B12 (FCC)
	3G bands:	W-CDMA B1, B8 (EUR) W-CDMA B2, B5 (FCC)
USB		USB 3.0 Standard A receptacles ×3 (host interface) USB 2.0 mini B receptacles ×1 (console interface)
Internet protocol		IPv4
Supported protocol		SIP
Codec		G.711 μ-law, AMBE+2™

# SPECIFICATIONS FOR IP ADVANCED RADIO SYSTEM

		IP501H
Network	4G bands:	LTE 1, 3, 7, 8, 20 (EXP) LTE 2, 4, 5, 17 (USA)
	3G bands:	W-CDMA 1, 8 (EXP) W-CDMA 2, 5 (USA)
Dimensions (W × H × D; projections not included)		59 × 95 × 32 mm (with BP-272)
Weight (approx.)		240 g (with BP-272 and antenna)
Voice Codec		G.726 (32 kbps)
AF output power	Internal SP	400 mW (16 Ω at 10% distortion)
	External SP	200 mW (8 Ω at 10% distortion)
Operating time (5:5:90 duty cycle.)		More than 17 hours (with BP-272)
Bluetooth®		Ver 2.1 +EDR
GPS		Built-in

		IP100H
Wireless standards		IEEE 802.11 a/b/g/n
Frequency coverage*1		2.4–2.4835 GHz, 5.15–5.35, 5.47–5.85 GHz
Dimensions (W × H × D; projections not included)		58 × 95 × 26.4 mm (with BP-271)
Weight (approx.)		205 g (with BP-271 and antenna)
RF output power		Less than 10 mW/MHz
Voice Codec		G.711μ-law (64 kbps)
AF output power	Internal SP	400 mW (typ., 16 Ω at 10% distortion)
	External SP	200 mW (typ., 8 Ω at 10% distortion)
Security		WEP(64/128-bit), WPA-PSK(TKIP/AES), WPA2-PSK(TKIP/AES)
Operating time (1:1:8 duty cycle.)		More than 20 hours (with BP-271)

\*1 Authorized frequency range and channels may differ depending on country.

		IP1000C
Power supply		100–240 V AC (with supplied AC adapter)
Dimensions (W × H × D; projections not included)		232 × 38 × 168 mm
Weight (approx.)		750 g (Main unit only)
LAN		RJ-45 connector × 4 1000BASE-T/100BASE-TX/ 10BASE-T (AUTO MDI/MDI-X)
USB		Standard A receptacles ×2
Maintenance console		RS-232C (RJ-11) connector

		AP-90M
Wireless LAN		IEEE 802.11 a/b/g/n/ac
Frequency coverage*2		2.4–2.4835 GHz, 5.15–5.35, 5.47–5.85 GHz
Power supply		12 V DC or PoE (IEEE802.3af compatible)
Dimensions (W × H × D; projections not included)		120 × 29 × 103 mm
Weight (approx.)		300 g (Main unit only)
Cable LAN		RJ-45 connector × 1 1000BASE-T/100BASE-TX/ 10BASE-T (Auto MDI/MDI-X)
Data rates (theoretical value)		11 Mbps, 54 Mbps, 300 Mbps, 866.7 Mbps
Security		WEP (64/128/152-bit), WPA, WPA2, WPA-PSK, WPA2-PSK

\*2 Authorized frequency range and channels may differ depending on country.

All stated specifications are subject to change without notice or obligation. Read all instructions enclosed with the transceiver carefully and completely before using the transceiver.

Icom, Icom Inc. and the Icom logo are registered trademarks of Icom Incorporated (Japan) in Japan, the United States, the United Kingdom, Germany, France, Spain, Russia, Australia, New Zealand and/or other countries. IDAS, IDAS logo, COMMANDMIC and AQUAQUAKE are trademarks of Icom Incorporated. dPMR and the dPMR logo are trademarks of the dPMR MoU Association. NXDN is a trademark of Icom Incorporated and JVC KENWOOD Corporation. Windows is either a registered trademark or a trademark of Microsoft Corporation in the United States and/or other countries. AMBE+2 is a trademark and property of Digital Voice System Inc. The Bluetooth® word mark and logos are registered trademarks owned by Bluetooth SIG, Inc. and any use of such marks by Icom Inc. is under license. LTR is a trademark of E.F. Johnson Technologies Inc. All other trademarks are the properties of their respective holders.

**Icom Inc.** 1-1-32, Kamiminami, Hirano-Ku, Osaka 547-0003, Japan Phone: +81 (06) 6793 5302 Fax: +81 (06) 6793 0013

[www.icom.co.jp/world](http://www.icom.co.jp/world)

**Count on us!**

**Icom America Inc.**  
[www.icomamerica.com](http://www.icomamerica.com)

**Icom (Europe) GmbH**  
[www.icomeurope.com](http://www.icomeurope.com)

**Icom (Australia) Pty. Ltd.**  
[www.icom.net.au](http://www.icom.net.au)

Your local distributor/dealer:

**Icom Canada**  
[www.icomcanada.com](http://www.icomcanada.com)

**Icom Spain S.L.**  
[www.icomspain.com](http://www.icomspain.com)

**Shanghai Icom Ltd.**  
[www.bjicom.com](http://www.bjicom.com)

**Icom Brazil**  
E-mail: [sales@icombrasil.com](mailto:sales@icombrasil.com)

**Icom (UK) Ltd.**  
[www.icomuk.co.uk](http://www.icomuk.co.uk)

**Icom France s.a.s.**  
[www.icom-france.com](http://www.icom-france.com)