

PRODUCT CATALOG 2020



SETTING
NEW
STANDARDS

WHO ARE WE AND WHAT DO WE DO?

Technology leader

IHSE is a world leading manufacturer of flexible and highly secure KVM (keyboard, video, mouse) extension and switching solutions for collaboration, resource and access management.

Made in Germany

IHSE has over 35 years advanced in-house system design and manufacturing experience. Our ISO-certified and award-winning products are renowned for their outstanding manufacturing quality, 24/7 operation, high security and flexibility.

Technology for tomorrow

Our mission-critical solutions are future-proof, modular and provide security of investment. They can be configured from a range of hundreds of flexible modules to meet specific individual requirements and budgets. Installations can be easily upgraded with new features and interface standards without having to replace existing systems.

IP connectivity NEW

IHSE technology enables location-independent access over IP with supreme system security. Using sophisticated secure-core technology, we isolate the IP protocol from the matrix. While providing flexibility and secure access to mission-critical installations, the system keeps the requirements on IP networks as low as possible. There is no need for complex IGMP multicast configuration or high bandwidth.

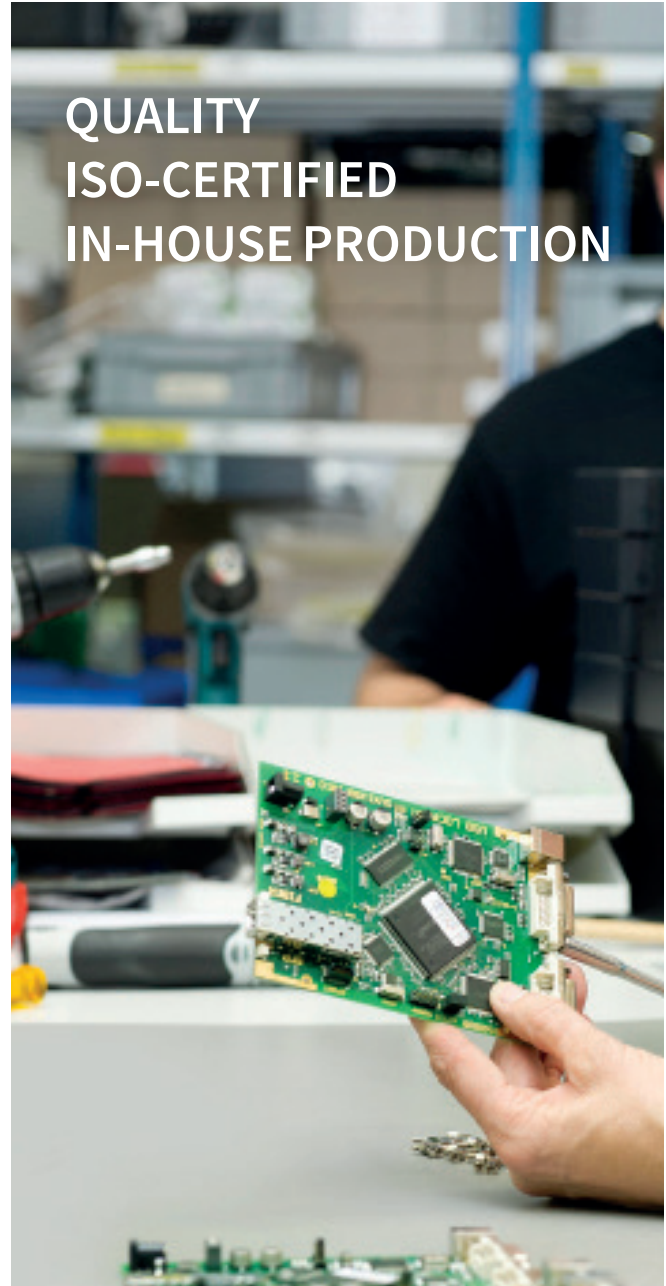

Global market presence

With our headquarters based near Lake Constance, we have IHSE-owned subsidiaries in New Jersey and Singapore with independent, authorized sales partners all over the world. This creates a comprehensive global sales network with round-the-clock support. Renowned international institutions rely on IHSE solutions in mission-critical operations in many application sectors, including Broadcast, ProAV, Esports, Banking, Healthcare, Maritime, Air Traffic Control and Government.



WHAT IS KVM?

KVM stands for Keyboard-Video-Mouse, referring to the familiar workplace computer input and output devices.

Our mission-critical system solutions extend the distance between the computer and peripheral devices (keyboard, screen, mouse). Allowing users to select between different source devices to create more comfortable and efficient working environments and streamlined workflows. We offer KVM products for the switching, sharing, extension and conversion of all types of computer signals, including analog and digital video and audio, USB and SDI video; applicable to all markets. Long distances are bridged by Cat X, fiber or mixed cabling, depending on requirements and applications.

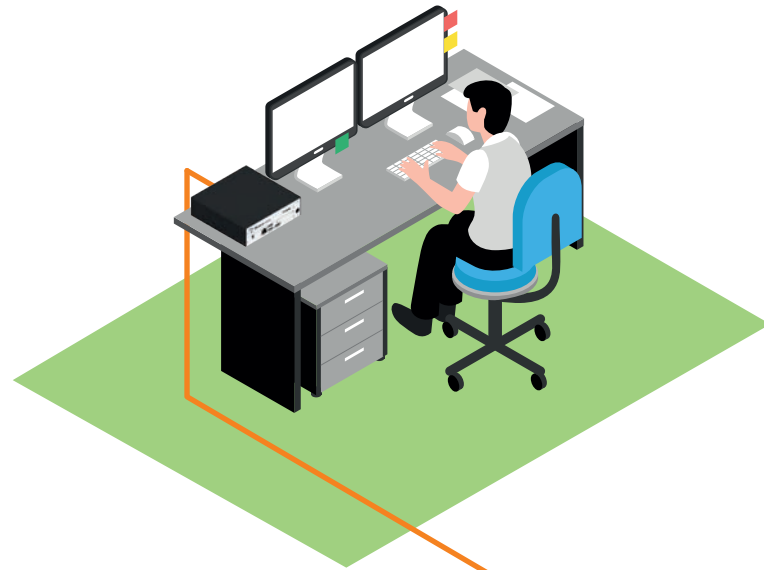

HOW DO COMPANIES BENEFIT FROM KVM?

KVM enhances the workplace

- **Relocation of computers**
Reduction of bulky computer hardware, noise and heat in the user environment.
- **Reducing workplace clutter**
Operation of several computers and monitors by a single set of keyboard and mouse.
- **Easy access of resources**
Convenient and instant access to a large number of connected sources.

KVM increases IT security

- **Access control**
Limits access of source computers to authorized users.
- **Restricted internal access**
Prevents unauthorized removal of data and injection of malware.
- **Prevention of unauthorized external access**
The KVM system includes integral isolation against unauthorized network access or attack and guards against electronic eavesdropping.

KVM saves costs

- **Increasing the lifespan of computers and equipment**
Locating sensitive computer equipment in secure and environmentally-controlled server rooms allows them to be maintained and managed in the best possible conditions.
- **Reducing hardware and software overheads**
Users from different areas and workstations can access and share computers and licensed software tools at different times.
- **Efficient use of space and technical resources**
Workstations can be flexibly reconfigured for various tasks and applications at the push of a button. Simultaneous access to content enables collaboration and cooperation between remote teams.

KVM Extenders

KVM extenders enable computer access from remotely-located workstations. This makes it easy to protect critical CPUs and servers from heat, dirt, moisture and unauthorized access.

Removing noisy, bulky, heat-producing computers from the operator workplace creates a more pleasant, less-cluttered, working environment. Users' desks simply require basic peripheral devices: monitors, keyboards and pointing devices.

KVM extenders provide great benefit in applications like data centers, hospitals, financial floors, post production suites and in extremely space-restricted environments on ships or in ATC towers.



KVM Matrix Switches

A KVM matrix switch enables access to, and management of, any size of computer installation. Sources can be accessed, switched and shared instantly by users. Any connected user console, consisting of keyboard, mouse, monitor or other peripherals, can access any computer within the network. Expensive equipment and software licenses can be shared between multiple users accessing the same computers from their individual workstations in real time.

The system supports all relevant computer video formats up to 8K and higher resolutions as well as SDI and USB 3.0. Switches include comprehensive features such as multi-screen control and cross-conversion between AV signals and transmission media (Cat X and fiber).

A secure IP interface provides remote users with seamless, location-independent IP access via browser or client. For maximum security, the core matrix is completely shielded from the TCP/IP network.



Why are our systems modular?

Individual KVM modules can be integrated together to meet specific requirements. Enabling **tailor-made solutions** for every individual project. Standardized modules facilitate installation in common 19-inch chassis or rack cabinets found in server rooms.

Modularity offers a high level of investment security. Whenever new video standards are added or additional interfaces are required, the system can easily be expanded with additional modules. This **saves time-consuming and cost-intensive system replacements**.

ICON GLOSSARY

 4K resolution @ 30 Hz (4096 x 2160)	 Integrated local video in/out	 DisplayPort 1.1
 4K resolution @ 60 Hz (4096 x 2160)	 KVM switch functionality	 DisplayPort 1.2
 One Dual Link monitor	 DVI-D	 SDI
 Two Single Link monitors	 HDMI	 VGA
 Cat X	 USB 2.0 (36 Mbit/s)	 Internet Protocol (VDI/SSH)
 Cat X XV	 USB 2.0 (50/100 Mbit/s)	 RS232
 Single-mode Fiber	 USB 2.0 Hi-Speed (480 Mbit/s)	 RS422
 Multi-mode Fiber	 USB 3.0	 Analog audio bidirectional
 Fiber XV	 USB 3.1	 Digital audio unidirectional
 Micro-BNC	 USB-HID	 Digital audio bidirectional
 Redundant signal transmission	 PS/2 interface	 Balanced audio

DESIGN YOUR OWN DEVICE - DRACO SYSTEM DESIGNER

IHSE offers a configurator for all Draco products. Check out our product site at ihse.com/configurator and select your preferred solution. Equip it with your required modules and simulate your fully loaded frame.

The configurator features all regular Draco switches, Draco vario chassis, main modules, add-on modules, USB 2.0 and 3.0 modules and accessories.



- Step 1: Chassis**
 - > Select a Frame Type
 - > Chassis Accessories

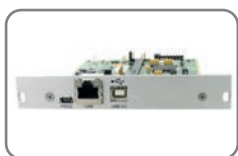

- Step 2: Modules**
 - > Basic Modules
 - > Add-On Modules



- Step 3: Export**
 - > Parts List
 - > Print Out or CSV
 - > Direct Order Placement

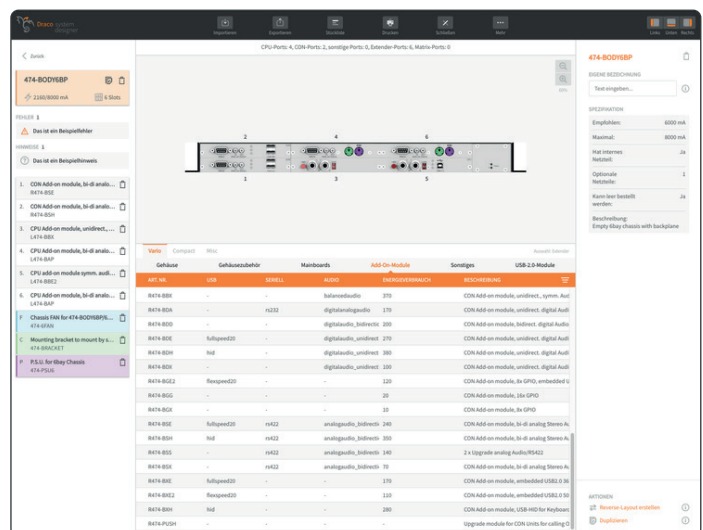

DIGITAL KVM EXTENDERS	SERIES	FROM PAGE	9
Draco compact (pre-configured complete device)	477		10
Draco vario for customized configuration			12
<i>Classic Series</i>			14
Draco vario DVI-I & DVI-D	474		14
Draco vario HDMI	481		16
Draco vario Dual-Head/Dual Link	482		18
Draco vario DisplayPort 1.1	483		20
Draco vario SDI	486		22
Draco vario Remote IP CPU	488		24
Draco vario Secure IP Remote Access Gateway	488		26
<i>Ultra Series</i>			28
Draco vario ultra DVI-I	494		30
Draco vario ultra HDMI 1.3	491		32
Draco vario ultra HDMI 2.0	495		34
Draco vario ultra Dual Link	492		36
Draco vario ultra DisplayPort 1.1	493		38
Draco vario ultra DisplayPort 1.2	490		40
Add-on Modules			42
Chassis & Accessories			46-48
Configuration of Order Numbers			49
Draco OPS (2K60) & Draco ultra OPS (4K60)	482/490		50
KVM MATRIX SWITCHES	SERIES	FROM PAGE	53
Features and Functions	480 / 480c		54
KVM Matrix Grid	480 / 480c		56
Draco tera enterprise	480		58
Draco tera compact	480c		62
Tera Viewer	480-VIEW		66
Draco CPU Switch	484		68
Draco U-Switch	476		70
Programmable Keyboard / Keypad	444		72
Draco TFT Admin Console	477		74
CONVERTERS, REPEATERS, CWDM, USB	SERIES	FROM PAGE	75
Draco vario Media Converters / Repeaters	485		76
Draco CWDM	470		78
Draco Video Converters	238		80
DVI / VGA Converter	469		82
2 x DVI Splitter Cable	445		83
PS/2 to USB and USB to PS/2 Converters	436		84
ICRON USB 3-2-1 Raven™ 3104, 3124	417		85
ICRON USB 2.0 Ranger® 2304	417		86
KVM meets IP			87
Technology Partners			88
Industry Organizations and Associations			89
Security in KVM Systems			90
Terms and Conditions			92
Contact			93

SERIES	PRODUCT NAME	DESCRIPTION	PAGE
Series 238	Draco Video Converter	Analog video to DVI converter	80
Series 417	ICRON USB 3-2-1 Raven™ 3104, 3124	USB 3.1 extender	85
Series 417	ICRON USB 2.0 Ranger® 2304	USB 2.0 extender	86
Series 436	USB to PS/2 and PS/2 to USB Converter	USB - PS/2 converter	84
Series 444	Programmable Keyboard / Keypad	Individual printing of keypad keys	72
Series 445	2x DVI Splitter Cable	Input and output DVI-D splitter cable	83
Series 469	DVI / VGA Converter	DVI to VGA converter	82
Series 470	Draco CWDM	CWDM-MUX/DEMUX	78
Series 474	Draco vario DVI	DVI KVM extender	14
Series 476	Draco U-Switch	USB KVM switch	70
Series 477	Draco compact	DVI KVM extender in compact chassis	10
Series 477	Draco TFT Admin Console	For installation in racks or computer cabinets	74
Series 480	Draco tera enterprise	KVM matrix switch with up to 576 ports	58
Series 480c	Draco tera compact	Compact KVM matrix switch	62
Series 480-VIEW	Tera Viewer	IP-based monitoring and switching	66
Series 481	Draco vario HDMI	HDMI KVM extender	16
Series 482	Draco vario Dual-Head/Dual Link	Dual-Head/Dual Link DVI KVM extender	18
Series 482	Draco OPS (2K60)	KVM extension to any OPS equipped display	50
Series 483	Draco vario DP 1.1	DisplayPort KVM extender	20
Series 484	Draco CPU Switch	8:1 VGA switch	68
Series 485	Draco vario Repeater	Extension and format conversion of signals	76
Series 486	Draco vario SDI	Extension and conversion of SDI signals	22
Series 488	Draco vario Remote IP CPU	VDI integration into KVM systems	24
Series 488	Draco vario Secure IP Remote Access Gateway	IP Access from various locations	26
Series 490	Draco vario ultra DP 1.2	4K@60 Hz DisplayPort KVM extender	40
Series 490	Draco ultra OPS (4K60)	KVM extension to any OPS equipped display	50
Series 491	Draco vario ultra HDMI 1.3	Modular KVM extender for HDMI interfaces	32
Series 492	Draco vario ultra Dual Link	Dual Link DVI KVM extender	36
Series 493	Draco vario ultra DP 1.1	4K@30 Hz DisplayPort KVM extender	38
Series 494	Draco vario ultra DVI-I	DVI-I (VGA) Single Link KVM extender	30
Series 495	Draco vario ultra HDMI 2.0	4K@60 Hz HDMI 2.0 KVM extender	34

LONG DISTANCE TRANSMISSION OF VIDEO, USB, RS232 AND PS/2 SIGNALS UP TO 10 KM



The Draco vario product family is a modular approach to extenders that allow customization for nearly any application. Each extender option can be installed in one of the unique frame assemblies. Four frame types are available - 2, 4, 6, or 21 cards per frame. All variants can be flexibly assembled as Multi-Head models.

DIGITAL KVM EXTENDERS	SERIES	FROM PAGE	9
Draco compact (pre-configured complete device)	477		10
Draco vario for customized configuration			12
<i>Classic Series</i>			14
Draco vario DVI-I & DVI-D	474		14
Draco vario HDMI	481		16
Draco vario Dual-Head/Dual Link	482		18
Draco vario DisplayPort 1.1	483		20
Draco vario SDI	486		22
Draco vario Remote IP CPU	488		24
Draco vario Secure IP Remote Access Gateway	488		26
<i>Ultra Series</i>			28
Draco vario ultra DVI-I	494		30
Draco vario ultra HDMI 1.3	491		32
Draco vario ultra HDMI 2.0	495		34
Draco vario ultra Dual Link	492		36
Draco vario ultra DisplayPort 1.1	493		38
Draco vario ultra DisplayPort 1.2	490		40
Add-on Modules			42
Chassis & Accessories			46-48
Configuration of Order Numbers			49
Draco OPS (2K60) & Draco ultra OPS (4K60)	482/490		50



- Resolutions up to 1920 x 1200
- Available with analog or digital audio
- Easy EDID transmission
- Single sided connectivity
- Compact size

Product Information

Draco compact extenders are housed in compact units. The small and space-saving chassis of the Draco compact are available in six standard versions, allowing the extension of

high-res DVI signals as well as USB 2.0, USB-HID, VGA, analog and digital audio. Due to its compact size, the Draco compact can be located in small spaces. All connectors are on

the same face for ease of installation, making it ideal for many demanding applications.

Product Features

- Excellent image quality in all resolutions
- Single- and Dual-Head device models
- Wide range of additional options:
 - Two USB ports for HID devices (keyboard & mouse)
 - USB 2.0 embedded
 - Serial interface (RS232)
 - Analog audio
 - Digital audio
- All connections on one side for an easy installation
- Simple keyboard commands (hot keys) for transmission of remotely connected monitors' EDID information
- 19" rack mount kit available - up to four units fit in one RU
- External power supply or optional tray mounted power supply for one RU frame
- DVI-D fiber devices are available as XV models for premium image transmission in all cases
- VESA mounting plate (optional)
- Ideal for space-saving installation at operator desk

TECHNICAL DATA	
Power Supply (internal)	90-240VAC / 1 A / 50-60 Hz, 5VDC
Serial RS232/RS422	up to 115,200 baud
Analog audio	Bidirectional stereo audio connections, 38.4 kHz
Digital audio	Compatible with AES/EBU, S/PDIF, Dolby Digital, DTS, PCM, 32-96 kHz
Max. Resolution	1920 x 1200 @ 60 Hz
Color Depth	8 bit / True Color
Maximum Cable Distance	Cat X 140 m Multi-mode 1 km Single-mode 10 km
Dimensions with one board	103 x 143 x 29 mm (4.06 x 5.63 x 1.14 inch)
with two boards	103 x 14.3 x 42 mm (4.06 x 5.63 x 1.65 inch)

Functional Diagram

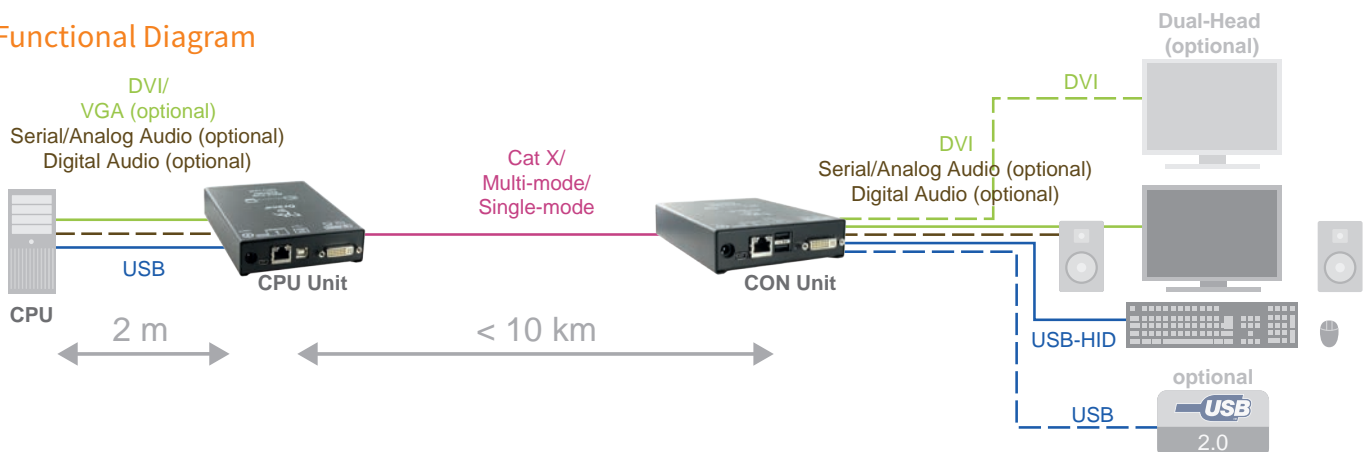

















Application

The Draco compact is ideally suited for smaller applications that do not need the full flexibility and modularity of the Draco vario system. It offers a cost-effective solution of delay-free extension and switching of keyboard, video and mouse signals at the highest levels of image quality.

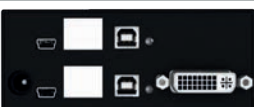
The compact size allows unobtrusive location of devices in the workplace, e.g. mounting under the user's desk. The versatile Draco compact KVM extender series is ideal for industrial and financial applications, education facilities and for maritime, air traffic control and other mission-critical installations that require maximum reliability and security.

Order Numbers

FUNCTIONS	CPU UNIT (LOCAL)	PART NO.	CON UNIT (REMOTE)	PART NO.
		L477-1SHC L477-1SHS L477-1SHX		R477-1SHC R477-1SHS R477-1SHX
		L477-1SHCV L477-1SHSV		
		L477-1S4CA L477-1S4SA L477-1S4XA		R477-1S4CA R477-1S4SA R477-1S4XA
		L477-1SECA L477-1SESA L477-1SEXA		R477-1SECA R477-1SESA R477-1SEXA
		L477-1SUC L477-1SUS L477-1SUX		R477-1SUC R477-1SUS R477-1SUX
		L477-2S4C L477-2S4S L477-2S4X		R477-2S4C R477-2S4S R477-2S4X

RACK MOUNT HARDWARE AND MOUNTING PLATES	PART NO.
19" rack mount kit for 1-4 Single-Head devices without additional modules	455-4G
19" rack mount kit for 1-4 devices, for all other Draco compact extenders	455-8G
19" power supply for up to 3 devices	455-PS
Mounting plate to mount by screws	455-4K
Mounting plate to mount by snap-on	455-5K

CABLES AND OPTIONAL ACCESSORIES	PART NO.
VESA mounting plate to mount by screws	477-VESA
International power supply 100 - 240VAC/5VDC (spare part for KVM units)	260-5G

Draco vario extenders let you place a keyboard, monitor, mouse, speakers and USB 2.0 devices long distances from your computer(s) or IHSE KVM matrix.

- Multiple product variants
- Four chassis sizes
- Redundant power supply
- Free customization
- Integrated switch and extender

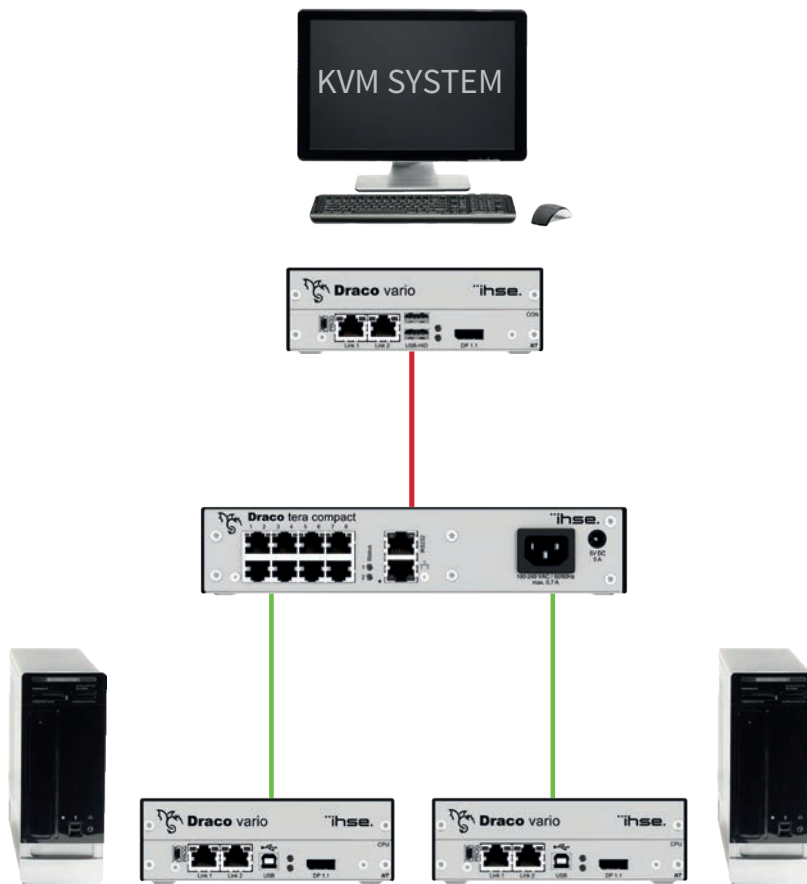

Product Information

IHSE offers a wide range of pre-configured models for the vario line of extenders.

Start with the basic 2-bay enclosure, select a part number corresponding to the video format requirement (DVI, HDMI, DisplayPort, DVI-I/VGA), with or without options. Each unit includes USB-HID for keyboard and mouse operations.

Options include analog audio, digital audio, RS232, RS422 and USB 2.0. All units are available in either twisted pair (Cat X) or fiber optic interconnects. Units include an external or internal power supply.

The Draco vario extender family is designed around a modular concept that lets you build an extender system to fit your specific needs. Enclosure frames are available in 2 bay, 4 bay, 6 bay and 21 bay units. Frame options include redundant power and rack mount kits. All Draco vario (474, 481, 482, 483, 486, 488) and Draco vario ultra (490, 491, 492, 493, 494, 495) models can be fitted to these frame styles. Main board options include DVI-D, DVI-I (VGA), HDMI, DisplayPort as well as Dual-Head or Dual Link DVI. Add-on modules include a wide range of features and flexibility to

support practically any combination of video and data transports.

Select add-on modules to support USB 2.0, digital audio, analog audio, RS232 or RS422. IHSE offers the Design Your Own Device (DYOD) configuration software to make it easy to build the system you need. All main modules support USB-HID for keyboard and mouse operations and are available in either Cat X or fiber option interconnects. Simple keyboard commands (hot keys) for transmission of remotely connected monitors' EDID information.



Why does it make sense to remotely locate a CPU?

- Protection against dust, moisture and vibrations
- Prevention of theft and unauthorized CPU access
- Simplified maintenance, configuration and administration of multiple user computers at a central point
- Centralized installation of software updates (particularly simple in combination with a KVM switch)
- Air conditioning of CPUs increases life cycles and ensures constant performance
- Pleasant working environment by enhancing space and reducing noise and heat pollution caused by powerful computers
- Reduction of energy consumption

Modular Units

Custom built assemblies

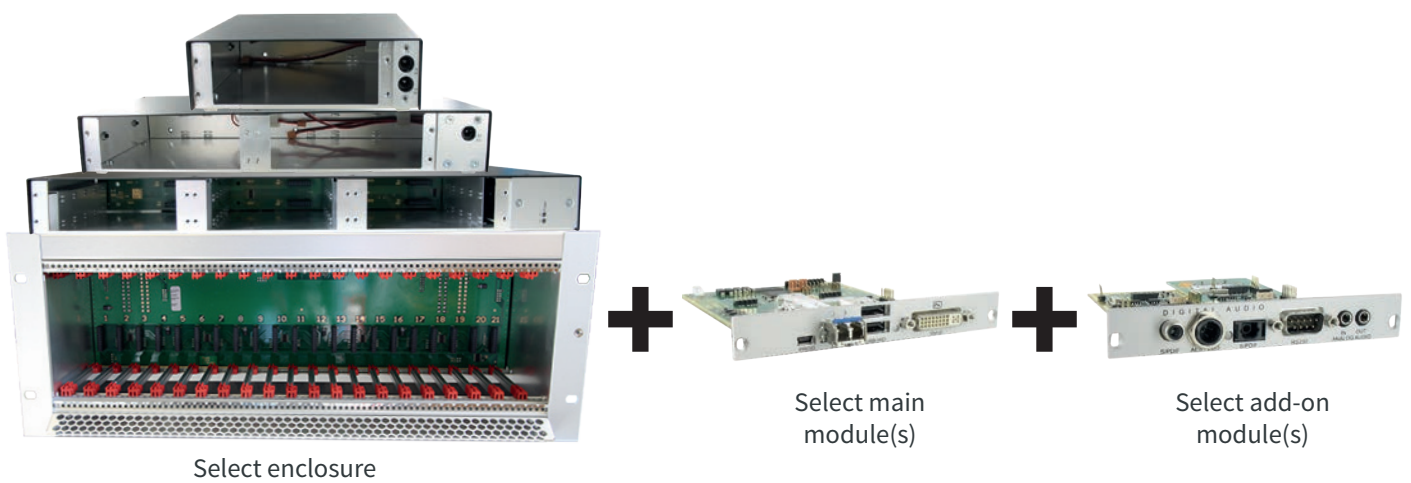

Base Units

Standard part numbers





- Multiple product variants
- Various chassis sizes
- Redundant power supply
- Single sided connectivity
- Easy to expand or to add features

Product Information

DVI and VGA extension

Draco vario DVI extenders enable long-distance extension of DVI computer video, together with USB-HID connection for keyboard, mouse and other compatible interface devices. Providing interconnection between user workstations and remote source computers. Connection between CPU Units (source) and CON Units (user workstation) is realized by single Cat X or fiber (single- or multi-mode), enabling connection at distances up to 140 m and 10 km.

Wide range of options

The Draco tera 474 series supports a wide range of input and output options to provide flexibility and extend the scope of integration. Including: redundant data transmission, USB2.0, RS232 and RS484, integral upscaling, analog and digital audio and more. All Draco vario modules are compatible with the Draco tera series providing a wide range of installation options and customized system configuration capability.

XV eXtreme Velocity

For the highest possible image quality, Draco vario fiber XV versions handle extremely high quality video at Full-HD resolutions.

Integration in Draco tera KVM matrix switch installations

Draco vario CPU and CON Units may be combined with Draco tera KVM matrix switches to create KVM matrix switching systems of almost unlimited size and capability.

Product Features

- Superior image quality in all resolutions
- Single- and Multi-Head devices are available (please note that the number of monitors per PC is limited by the number of slots)
- DVI-I / VGA devices available
- Wide range of additional options:
 - Two USB ports for HID devices (keyboard & mouse)
 - USB 2.0 embedded
 - Serial interface (RS232 or RS422)
 - Analog audio
 - Digital audio
- Redundant data link (optional)
- 19" rack mount kit (optional)
- Power supply included
- All devices with optional redundant power supply (load sharing)
- DVI-D fiber devices are available as XV models. Due to the increased data transmission rate, a loss-free image transmission is possible in virtually all cases

TECHNICAL DATA	
Input	DVI-D (DVI-I/VGA model available)
Output	DVI-D (DVI-I/VGA model available)
Serial RS232 / RS422	Up to 115,200 baud
Analog audio	Bidirectional stereo audio connection, 24 bit, 38.4 kHz
Digital audio	Compatible with AES/EBU, S/PDIF, Dolby Digital, DTS, PCM, 32-96 kHz
USB Data	USB-HID (for keyboard and mouse) USB 2.0 embedded up to 50 Mbit/s USB 2.0 Hi-Speed up to 480 Mbit/s
Maximum Resolution	1920 x 1200 @ 60 Hz
Color Depth	8 bit / True Color
Maximum Cable Distance	Cat X 140 m Multi-mode 1 km Single-mode 10 km

Functional Diagram

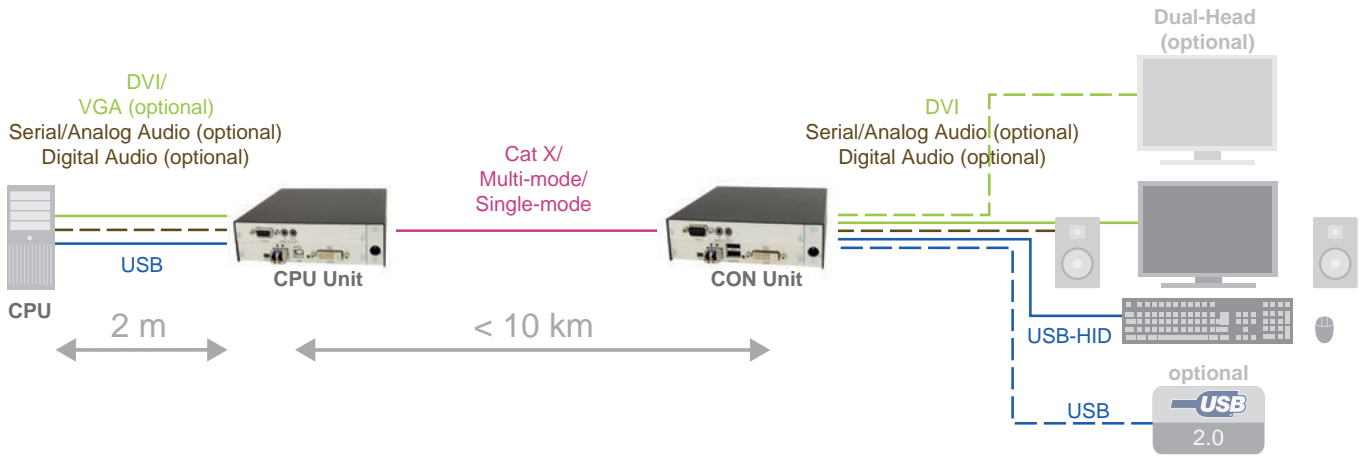

Order Numbers

FUNCTIONS	CPU UNIT (LOCAL)	PART NO.	CON UNIT (REMOTE)	PART NO.
		L474-BSHC L474-BSHS L474-BSHX		R474-BSHC R474-BSHS R474-BSHX
	<p>Standard conversion VGA to DVI</p>	L474-BVHC L474-BVHS	<p>VGA and DVI-D output</p>	R474-BVHC R474-BVHS
	<p>VGA to DVI conversion with scaling</p>	L474-BSHCV L474-BSHSV		
		L474-BSHCR L474-BSHSR		R474-BSHCR R474-BSHSR
	<p>Standard conversion VGA to DVI</p>	L474-BVHCR L474-BVHSR	<p>VGA and DVI-D output</p>	R474-BVHCR R474-BVHSR



- HDMI 1.3 interface
- Perfect digital video quality
- Embedded digital audio
- Compatible with all Draco devices
- Optional local output in CPU Unit
- Optional local KVM switch in CON Unit

Product Information

The Draco vario HDMI is the perfect extender for high resolution HDMI video signals of superior quality, including 3D formats and digital audio. Multi-Head applications are

achieved using an optional module. The Draco vario HDMI extender is ideal for broadcast applications as well as professional audio and video editing. Use the Draco vario HDMI

extender to transmit your audio and video data to the highest resolutions, including Full HD and 2K.

Product Features

- Lockable HDMI port
- High resolution video can be transmitted via HDMI interface
- The interface is compatible with 3D technology. Side-by-Side and Top-and-Bottom formats can be transmitted
- The standard version allows operation of a remote workstation with a HDMI/DVI-D monitor and two USB-HID devices (such as a keyboard and mouse)
- Compatible with all major operating systems
- Compatible with all IHSE Draco KVM switches, Draco vario and compact extenders, Draco vario chassis and modules
- HDMI embedded audio is cross compatible with digital audio add-on modules
- Redundant data link
- Fits into one 19"/1U rack

TECHNICAL DATA	
Input	HDMI 1.3 with embedded audio
Output	HDMI 1.3 with embedded audio
Serial RS232/RS422	Up to 115,200 baud
Analog audio	Bidirectional stereo audio connection, 24 bit, 38.4 kHz
Digital audio	Compatible with AES/EBU, S/PDIF, Dolby Digital, DTS, PCM, 32-96 kHz
USB Data	USB-HID (for keyboard and mouse) USB 2.0 embedded up to 50 Mbit/s USB 2.0 Hi-Speed up to 480 Mbit/s
Maximum Resolution	1920 x 1200 @ 60 Hz
Color Depth	8 bit / True Color
Maximum Cable Distance	Cat X 140 m Multi-mode 1 km Single-mode 10 km

i Additional Options

- CPU Unit with local output for connecting an HDMI monitor (Local Access)
- CON Unit with switchable HDMI and USB-HID inputs (local KVM switch) for a local source (computer, CPU)
- Optional bidirectional analog audio and RS232, RS422 support or digital audio with cinch/TOSLINK/mini-XLR connectors for professional audio applications
- Transparent USB 2.0 support for USB devices including printers, scanners, hard drives, memory sticks, audio devices, etc.

Functional Diagram

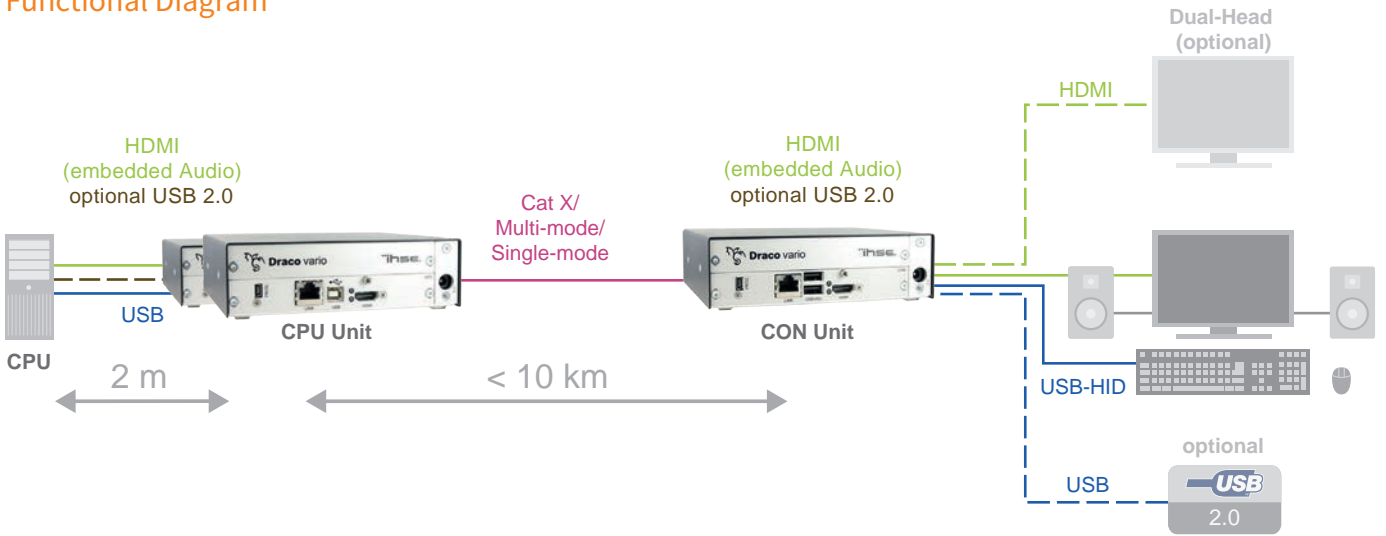

Order Numbers

FUNCTIONS	CPU UNIT (LOCAL)	PART NO.	CON UNIT (REMOTE)	PART NO.
HDMI, USB HID		L481-BHHC L481-BHHS		R481-BHHC R481-BHHS
HDMI, USB HID, Redundant		L481-BHHCR L481-BHHSR		R481-BHHCR R481-BHHSR
HDMI, Local Video, USB HID	 With integrated Local-Video-Access	L481-BHHCL L481-BHHS�		
HDMI, Local Video, USB HID, Redundant	 With integrated Local-Video-Access	L481-BHHCLR L481-BHHS�R		
HDMI, KVM Switch, USB HID			 KVM switch functionality included	R481-BHHCW R481-BHHSW
HDMI, KVM Switch, USB HID, Redundant			 KVM switch functionality included	R481-BHHCWR R481-BHHSWR
HDMI		L481-BHXC L481-BHXS		R481-BHXC R481-BHXS

These modules cannot be combined with add-on modules. No USB-HID support available.



- Resolutions up to 2560 x 2048 and 4K@30Hz
- DMS-59 adapter included
- Dual-Head for 2 DVI Single Link monitors
- Option for redundant path interconnects
- Data transmission via Cat X or fiber

Product Information

The Draco vario Dual-Head KVM extender enables the connection of two DVI monitors over a single Cat X or fiber cable, saving the expense of a second extender and reducing cabling cost and installation effort. When used in conjunction with KVM matrix systems, the Draco vario Dual-Head KVM extender saves valuable matrix ports.

It's sister product, the Draco vario Dual Link KVM extender, enables the transmission of DVI signals to one single monitor up to 4K@30Hz resolution. Extension of signals requires a single data cable. The extenders are compatible with regular Single-Head/Single Link extenders: Consoles can access Single-Head/Single Link

CPU Units instantaneously. In this situation, signals from Single-Head/Single Link sources are embedded within the Dual Link signal format and can be switched with no discernible switching delay. Single-Head/Single Link images are displayed at their own native resolution within a blanked frame.

Product Features





















- Excellent image quality at all resolutions
- Compatible with all major operating systems
- Compatible with all IHSE Draco KVM switches
- Only one KVM matrix port per unit required
- Wide range of additional options:
 - Two USB ports for HID devices
 - USB 2.0 embedded
 - Serial interface (RS232 or RS422)
 - Analog audio
 - Digital audio
 - DVI-D
- Redundant interconnect link
- 19" rack mount kit available
- All devices with redundant power supply (load-sharing) available

TECHNICAL DATA	
Input	DMS-59 (DVI-D Dual-Head/Single Link adapter) DMS-59 (DVI-D Dual Link adapter)
Output	DMS-59 (DVI-D Dual-Head/Single Link adapter) DMS-59 (DVI-D Dual Link adapter)
Data rates (max.)	2 x 165 MPixel/s (Dual-Head) 330 MPixel/s (Dual Link)
Maximum Resolution	Draco vario Dual-Head: 2 x 1920 x 1200 @ 60 Hz Draco vario Dual Link: 2560 x 2048 @ 60 Hz 4096 x 2160 @ 30 Hz (4K30)
Color Depth	8 bit / True Color
Maximum Cable Distance	Cat X 140 m Single-mode XV (9 μ) 5 km Single-mode (9 μ) 10 km
Optional Interfaces	USB 2.0, analog audio with RS232, digital audio, PS/2, etc.
Keyboard/Mouse	USB-HID

Draco vario Dual Link Main Modules

- DMS-59 port for 1 x DVI-D Dual Link
- Resolutions up to 4096 x 2160 (4K30)

Order Numbers

FUNCTIONS	CPU UNIT (LOCAL)	PART NO.	CON UNIT (REMOTE)	PART NO.
 		 L482-BDHC  L482-BDHS  L482-BDHX		 R482-BDHC  R482-BDHS  R482-BDHX
  		 L482-BDHCRC  L482-BDHSR  L482-BDHXR		 R482-BDHCRC  R482-BDHSR  R482-BDHXR

Functional Diagram





















Optional cable:
DMS-59 > DVI-D Dual Link
(see accessories on page 48)

Draco vario Dual-Head Main Modules

- DMS-59 port for 2 x DVI-D Single Link
- Resolutions up to 2 x 1920 x 1200

Order Numbers

FUNCTIONS	CPU UNIT (LOCAL)	PART NO.	CON UNIT (REMOTE)	PART NO.
		 L482-B2HC  L482-B2HS  L482-B2HX		 R482-B2HC  R482-B2HS  R482-B2HX
 		 L482-B2HCRC  L482-B2HSR  L482-B2HXR		 R482-B2HCRC  R482-B2HSR  R482-B2HXR

Functional Diagram



Optional cable:
DMS-59 > DVI-D 2x
(see accessories on page 48)



- Resolutions up to 2560 x 2048 and 4K@30Hz
- Compatible with all Draco devices
- Combined video and audio transmission
- Data transmission via Cat X, fiber or fiber XV
- Redundant power supply

Product Information

The Draco vario DisplayPort enables the transmission of high definition video and audio data over the cutting-edge DisplayPort interface. They are compatible with Draco tera KVM matrix switches and cross-compatible with the DVI and HDMI extender series for video and USB-

HID extension. Transmission of fully-digital video signals (including 3D video in full-HD) is supported in 4K resolutions up to 4096 x 2160 and 3840 x 2160. The DisplayPort extender supports all common digital audio standards. This eliminates the need for additional audio modules,

enabling playback of the audio signal through monitors with integrated loudspeakers. Integration of optional add-on modules for digital audio input and output is also possible. The DisplayPort extenders are available in single and redundant interconnection variants.

Product Features

- Compatible with all chassis and modules of the Draco vario extenders
- Transmission of fully-digital video signals up to 4K30 (4096 x 2160)
- The audio format PCM can be transferred with a sample rate up to 96 kHz via the DisplayPort interface
- Other audio formats are available via a firmware update
- The standard version allows operation of a remote workstation with a DisplayPort monitor and USB-HID devices (such as a keyboard and mouse)
- Compatible with all major operating systems
- Compatible with all IHSE Draco KVM switches as well as Draco vario models and chassis, and Draco compact extenders
- Redundant data link (optional)
- 1U (19") rack kits (optional)

TECHNICAL DATA	
Input	DisplayPort 1.1
Output	DisplayPort 1.1
Maximum Resolution	2560 x 2048 @ 60 Hz 4096 x 2160 @ 30 Hz
Color Depth	8 bit / True Color
Maximum Cable Distance	Cat X 140 m Single-mode XV (9 μ) 5 km Single-mode (9 μ) 10 km
Optional Interfaces	USB 2.0, analog audio with RS232, digital audio, PS/2, etc.
Keyboard/Mouse	USB-HID



- Modules also available as Mix & Match fiber versions (single-mode) and high speed XV fiber versions
- Upgrades available for USB 2.0, RS232, RS422, analog audio, digital audio, PS/2

Functional Diagram

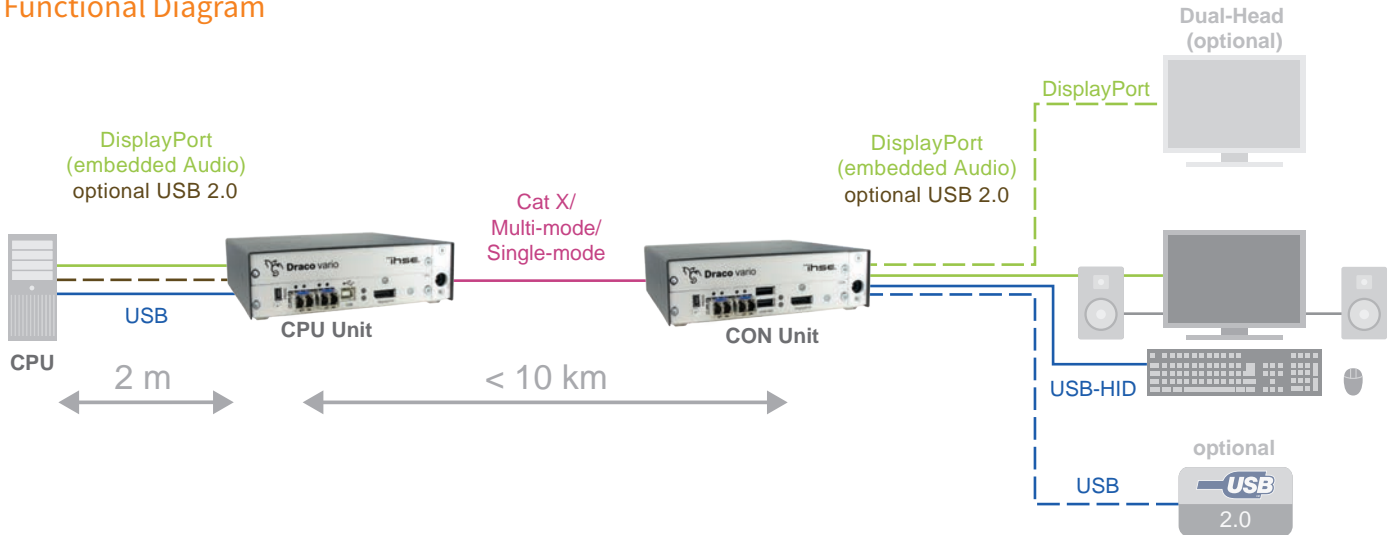

Order Numbers

FUNCTIONS	CPU UNIT (LOCAL)	PART NO.	CON UNIT (REMOTE)	PART NO.
DisplayPort 1.1 4K 30Hz ULTRAHD USB HID		L483-BPHC L483-BPHS L483-BPHX		R483-BPHC R483-BPHS R483-BPHX
DisplayPort 1.1 4K 30Hz ULTRAHD USB HID Redundant		L483-BPHCR L483-BPHSR L483-BPHXR		R483-BPHCR R483-BPHSR R483-BPHXR

Functional Diagram

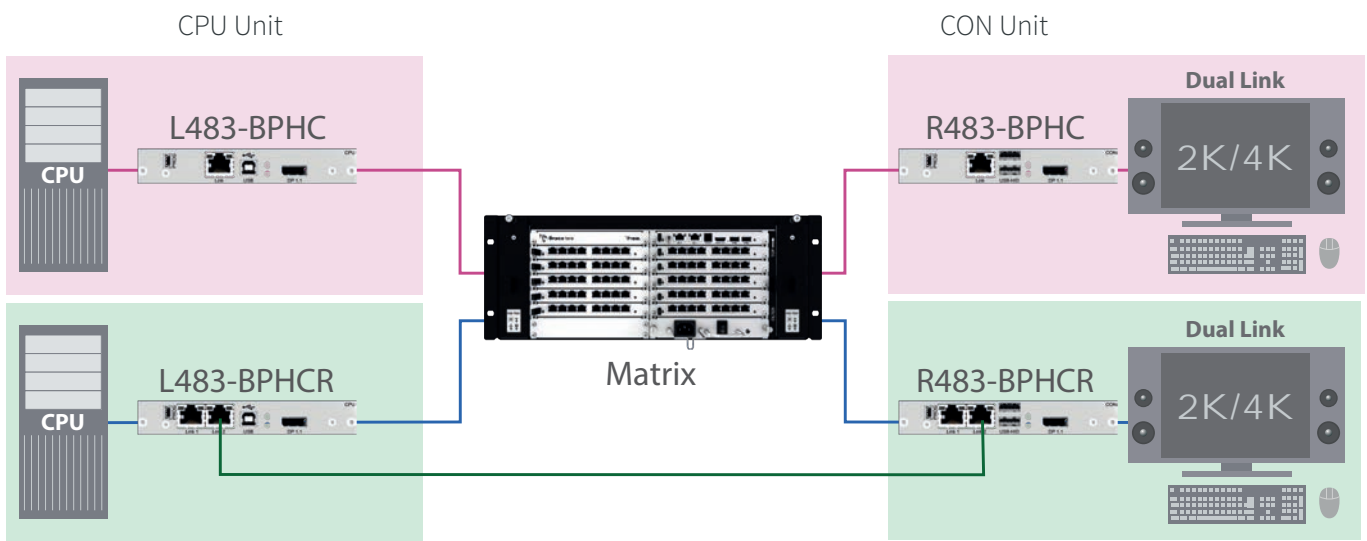



- Connection of SDI to the KVM world
- Conversion SDI to DVI/HDMI/DP & vice versa
- Integrated scaler (CON and CPU)
- Compatible to Draco tera matrices
- Fits into Draco vario chassis family
- Variable 2-channel selection for PCM audio

Product Information

With the introduction of the Draco SDI extender, it is now possible to combine and convert between SDI video and digital video signals. SDI video signals (up to 3G-SDI) input into an SDI CPU extender are made available to KVM CON units, directly or through a Draco tera KVM matrix switch, for connection to DVI, HDMI or DisplayPort monitors. An SDI CON unit is also able to convert digital

video signals for display on an SDI monitor. Video scaling and deinterlacing is included in the SDI extender, enabling conversion as required, between 720p50/60 or 1080i50/60 SDI video streams and digital formats, including 1080p, 1600x900 or 1920x1200. This ensures that the appropriate video resolution is available to suit the connected monitor. For greatest flexibility in

application, the SDI extender module can be equipped with two coax SFP modules, each with two channels. SFP modules are available to suit dual input and dual output configurations. An additional loopback enables an SDI signal to be passed on to additional SDI devices, whilst being input into the extender for KVM distribution.

Product Features

- 2-port architecture (e.g. for Dual-Head)
- HD-, 3GA-, 3GB-SDI input resolutions (720p50/60, 1080i50/60, 1080p50/60, further resolutions on request)
- Integrated scaler (CON and CPU)
- Scalable output resolutions (e.g. 720p, 1600 x 900 or 1080p)
- Integrated interlacing/deinterlacing
- Conversion from SDI to DVI/HDMI/DisplayPort and vice versa
- Passive loopback
- SDI audio embedding and de-embedding
- Compatible with all Draco tera matrices
- Extensive redundancy options
- Redundant interconnect link (optional)
- Compatible with Draco vario chassis family

TECHNICAL DATA	
Video Interface	Micro-BNC connector
Maximum supported SDI Resolution	1920 x 1080 @ 60 Hz
Signal Format	Level A (3GA), Level B (3GB)
Color Depth	SDI 4 : 2 : 2 (10 bit) KVM 4 : 4 : 4 (8 bit / True Color)
Audio	2-channel audio (selectable)
SFPs	Dual input SFP module (Micro-BNC) Dual output SFP module (Micro-BNC) Input/output SFP module (Micro-BNC)
Maximum Cable Distance	Cat X 140 m Multi-mode 1 km (OM3) Single-mode (9µ) 10 km
Power Consumption	Max. 1,500 mA per unit

i The standard scope of delivery for SDI modules includes one mini-coax SFP.

Functional Diagram

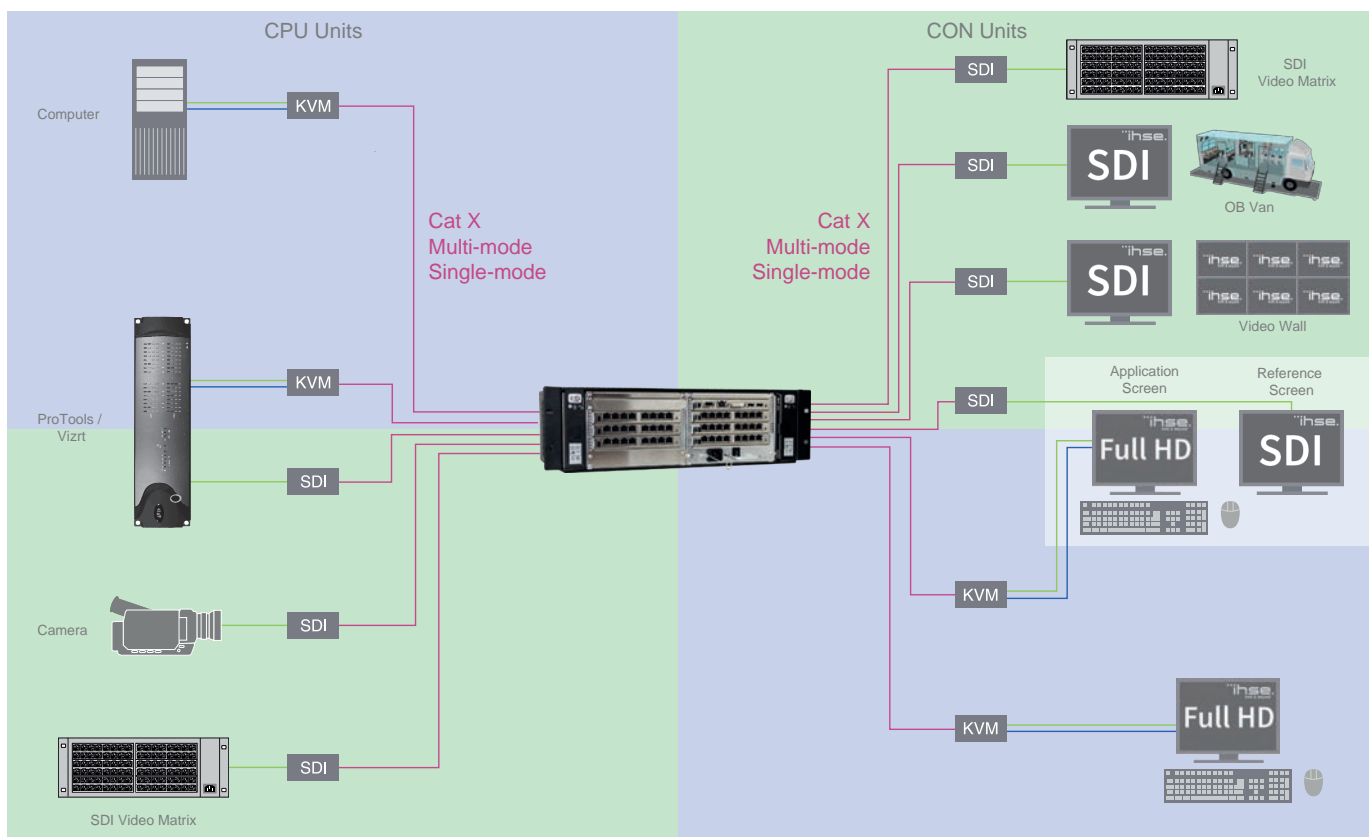

Order Numbers

FUNCTIONS	CPU UNIT (LOCAL)	PART NO.	CON UNIT (REMOTE)	PART NO.
		L486-BSDC L486-BSDS upon request		R486-BSDC R486-BSDS upon request
 		L486-BSDCR L486-BSDSR upon request		R486-BSDCR R486-BSDSR upon request

ACCESSORIES	DATA TRANSMISSION	PART NO.
SFP SDI, 3G/HD/SD Video, Micro-BNC to BNC, non-MSA, with passive loopback, reclocked, long reach, for CPU module		459-PLB
SFP SDI, 3G/HD/SD Video, Micro-BNC to BNC, non-MSA, with dual transmitter, reclocked, long reach, for CON module		459-DTX
▶ Adapter cable coax, Micro-BNC to BNC		459-BMB



- KVM access to virtual machines via RDP
- Allows sharing of RDP sessions via KVM
- Routes RDP KVM, audio and USB 2.0
- RemoteFX, VNC and SSH connectivity
- Combines KVM and VDI seamlessly
- Up to 8 simultaneous sessions
- Kiosk Mode (HTML 5 browser)

Product Information

Concept

The Draco vario Remote IP CPU combines the functionality of a Thin Client and a KVM extender (transmitter). This space-saving solution is fully compatible with the Draco vario extender and the Draco enterprise and compact matrix switch series.

Function

The IP module provides seamless KVM connectivity to an IP infrastructure. It supports RDP, RemoteFX, SSH and VNC protocols. Further remote protocols will be incorporated in future and can be made available on demand. A single Remote IP CPU can host up to 8 simultaneous sessions.

KVM meets VDI

Using RDP or RemoteFX protocols the Remote IP CPU provides KVM access from individual workstations to virtual machines in the same manner as accessing real PCs. Remote maintenance and installing updates are also possible. Besides keyboard, video and mouse signals, audio and transparent USB data can also be routed through the device.

RDP and the benefits of KVM

The KVM infrastructure adds extensive flexibility to an RDP session. RDP sessions can now be shared amongst multiple users, delivering better collaboration and control room solutions.

Immediate access

Immediate access to real PCs and virtual machines is achieved through permanent connection. Switching between the two types occurs instantaneously, with no disruption or inconvenience to the users.

Single Sign On

For ease of operation, the system can be configured to support SSO. Single stage user identification is all that is required, either locally or via AD. User credentials are stored for future connection setup.

Product Features







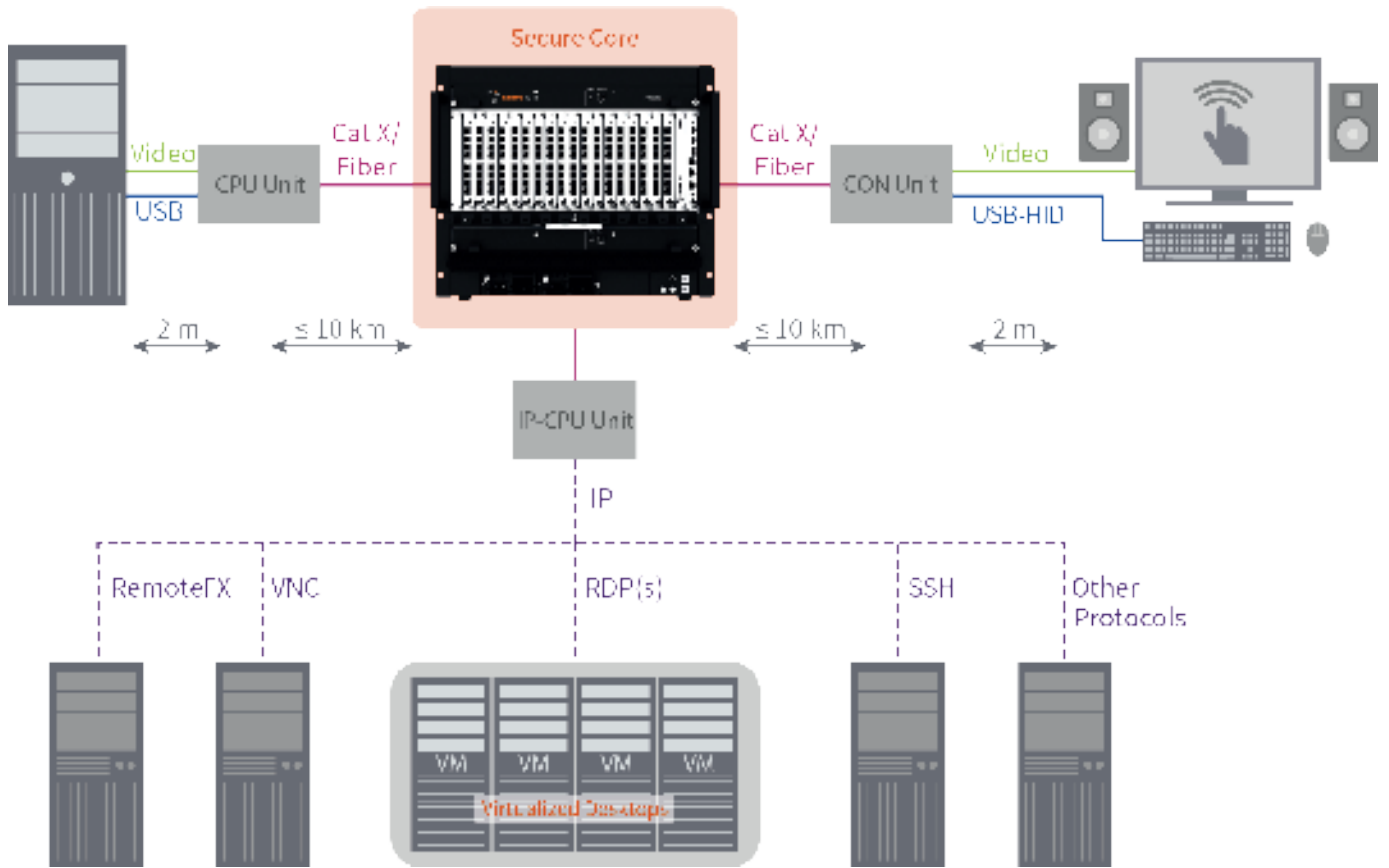



- Integrates with IP infrastructure without compromising security
- Link redundancy for fail-safe operation in mission critical applications
- Homogeneous integration into traditional high-performance Draco KVM systems
- Compatible with all Draco vario chassis allowing power redundancy and dense mounting
- Keeps individual VDI infrastructure isolated from each other while still granting secure access to operators via Draco tera matrices

TECHNICAL DATA	
Power Supply	5VDC (via Draco vario chassis)
Link Interface	RJ-45 or LC Duplex (Single-mode)
Input Interface	RJ-45 (TCP/IP)
Service Interface	Mini-USB (F)
Supported Protocols	RDP, RemoteFX, SSH, VNC (Client)
Supported Signals	Video: up to 1920x1080, Audio: 2-channel PCM embedded, USB-HID, USB 2.0 (embedded)
Maximum Resolution	1920 x 1080 @ 60 Hz
Color Depth	8 bit / True Color
Maximum Cable Distance	Cat X 140 m Multi-mode 1 km Single-mode 10 km

Functional Diagram



Order Numbers

FUNCTIONS	CPU UNIT (LOCAL)	PART NO.
 		 L488-BIPEC  L488-BIPES
  		 L488-BIPECR  L488-BIPESR



- Remote access gateway via WAN
- Real-time access via LAN
- HTML 5.0 Browser based access
- Seamless integration into Draco switches
- IP isolation from Secure Core Matrix
- High performance based Win/Linux Client

Product Information

Fully flexible - fully secure

The new Secure IP Remote Access Gateway adds more flexibility to the Draco tera matrix series without sacrificing the philosophy of securely isolating the core matrix and signal management from TCP/IP. Encrypted signal transmission via IP ensures protection of intellectual property while still offering most flexible access to matrix connected target devices from remote locations via private or public networks.

Video resolutions up to 4K

HTML 5 based browser access offers highest flexibility even from mobile devices for remote administration. The Windows® or Linux based client software adds more performance and features while still offering a high level of flexibility. Best performance and feature set is brought by using the Draco user station IP with 1080p60 video signal at 8 bit color depth and full 60 fps or even 4k30.

Highly compatible

Physically, the Secure IP Access Gateway is compatible with the Draco vario extender series fitting in Draco vario chassis. It occupies two slots and is recommended to be mounted into chassis with backplane such as the 2-slot (474-BODY2BPF) the 6-slot (474-BODY6BP/F) or 21-slot (474-BODY21/4U). Besides the remote access option, it offers HDMI and USB interfaces for local access at the rack level.

Product Features

- WAN optimized
- LAN optimized
- Up to 4K30, 8-bit 4:4:4 color depth
- User station, browser, software client-based access options
- One and the same technology for remote service access and high-performance applications!
- Link encryption
- High performance based Win/Linux Client access via Notebook, Desktop PC or Secure Remote Access User Station
- Multiple simultaneous shared sessions

TECHNICAL DATA	
Power Supply	5VDC (via Draco vario chassis)
Link Interface	RJ-45 or Duplex LC (single-mode)
Output Interface	RJ-45 (TCP/IP)
Service Interface	1x HDMI1.4 (F)
2x USB Type A (F) K/M and service	Mini-USB (F)
Supported Protocols	TCP/IP
Supported Signals	Video: up to 3840 x 2160 @ 30 Hz, Audio: 2-channel PCM embed- ded, USB-HID
Encryption	AES (up to 256 bit)
Maximum Resolution	3840 x 2160 @ 30 Hz
Color Depth	8 bit / True Color
Maximum Cable Distance	Cat X 140 m Multi-mode 1 km Single-mode 10 km

Draco Secure Remote Access User Station



IP Access from various locations – User Station Access.







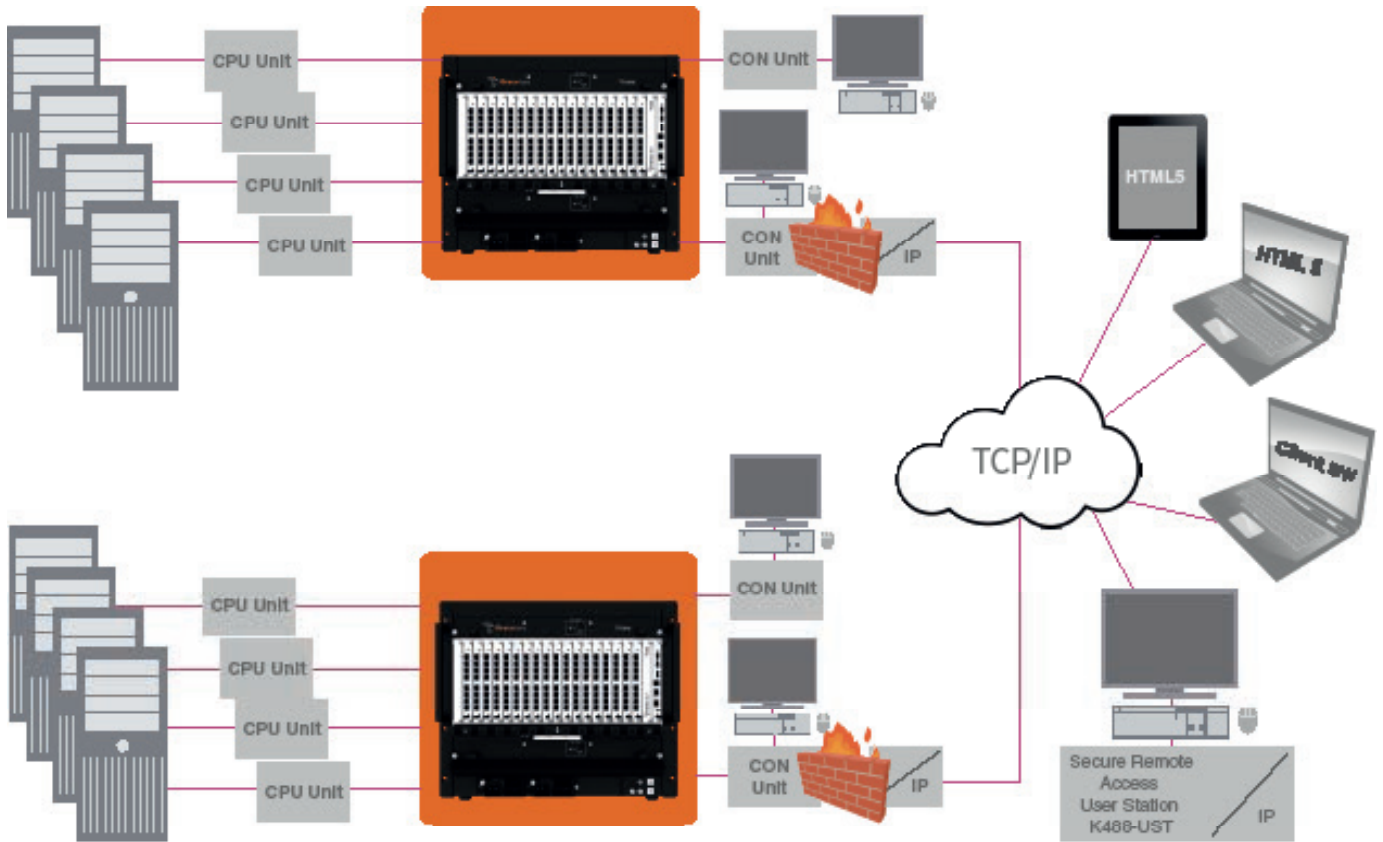



TECHNICAL DATA (K488-UST)	
Power Supply	1x Barrel 19VDC/4.74A, max. 90W
Video	2x DP, 1x HDMI
USB	Type A 8x (4x front, 4x rear)
Audio	2x 3.5mm jacks
RS-232	2x SUB-D9 (M)
LAN	2x RJ45
SD-Slot	1x
Dimensions	165 x 43 x 195mm

Functional Diagram

IP Access from various locations - Browser / Client or Appliance based



Order Numbers

FUNCTIONS	CON UNIT (LOCAL)	PART NO.
  		 R488-BIPC  R488-BIPS
  		 R488-BIPCR  R488-BIPSR

Alternative module for point-to-point connections

For installations that do not require full matrix switching capability, IHSE offers an IP module for direct computer connection. In this configuration, individual computers can be accessed and operated remotely via IP networks. Additional local outputs (signal feed-through) allow users to access the local computer at the same time.



R488-BIPHHL
Draco vario Secure IP Access Gateway,
Standalone

NEW TECHNOLOGY OF DRACO VARIO ULTRA

Next generation KVM extenders with integrated Fraunhofer IIS's lightweight coding technology



Gefördert durch:



Bundesministerium
für Wirtschaft
und Energie

aufgrund eines Beschlusses
des Deutschen Bundestages



The Draco vario ultra is the first ever KVM extender that uses the Lightweight Image Coding technology Lici® and has been developed in partnership with the Fraunhofer Institute for Integrated Circuits. The innovative codec enables the transmission of high resolution video streams within the available infrastructure and bandwidth capacity at very low latency, without sacrificing either image quality or dynamic range.

Lici® (Lightweight Image Coding technology)

- Mezzanine compression up to mathematically lossless
- Low latency
- No frame drops
- RGB/YCbCr or raw data compression
- 2K/4K/8K possible or higher frame rates
- Genlock / Source synchronous transmission

Hong Kong Harbour Vessel Tracking Center

Draco ultra extenders transmit 4K UHD signals at 60 Hz resolution to ensure the safe and secure movement of 200,000 ships every year that pass through the congested harbour waters.

“ Users switch between sources instantly and view information at 4k60Hz resolution, giving them a highly flexible integrated solution that combines several functions into one system.

Wim van de Gein, Project Manager

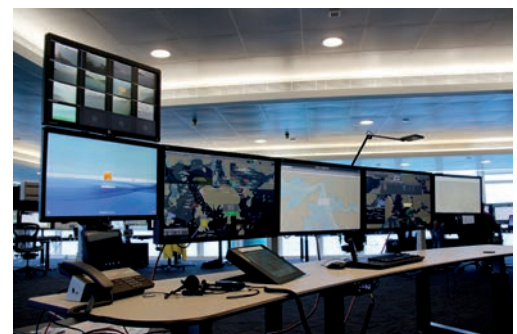

DRACO VARIO CLASSIC

(Series 47x/48x)

Video Formats

- VGA
- DVI, DVI DH / DL
- HDMI 1.3
- DisplayPort 1.1 (4K30)
- SDI

DRACO VARIO ULTRA

(Series 49x)

Video Formats

- DVI DH / DL
- HDMI 1.3
- DisplayPort 1.1 (4K30)
- SDI coming soon!

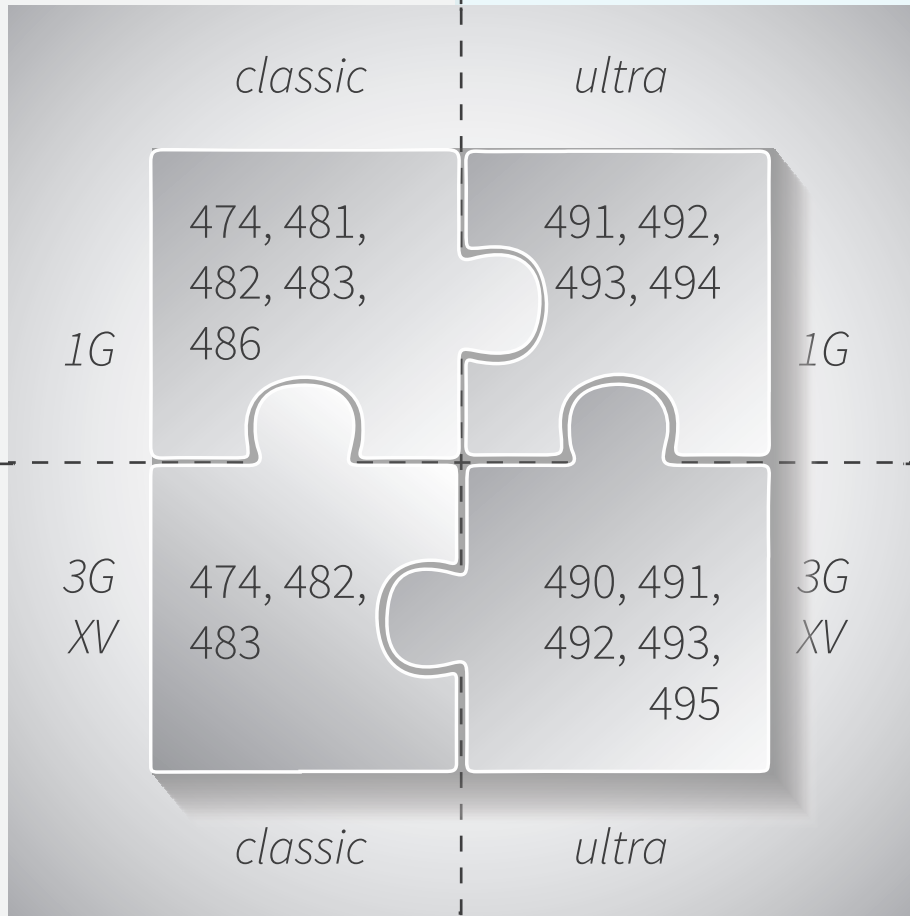

DRACO VARIO CLASSIC XV

Video Formats

- VGA
- DVI, DVI DH / DL
- DisplayPort 1.1 (4K30)

DRACO VARIO ULTRA XV

Video Formats

- DVI DH / DL
- HDMI 1.3
- HDMI 2.0
- DisplayPort 1.1 (4K30)
- DisplayPort 1.2 (4K60)
- SDI coming soon!



i NO VIDEO TRANSMISSION BETWEEN CLASSIC AND ULTRA!



- Optional input: DVI-D or VGA
- Integrated OSD for easy configuration
- Scaling option
- Increase of signal flexibility
- Lici® (Lightweight Image Coding technology)

Product Information

Integration of analog servers

The DVI-I CPU Unit is designed for a maximum of signal flexibility at video sources such as computers or servers. Both DVI-D and VGA signals are supported at the input. This ensures the proper usage of e.g. old VGA servers or modern computers with a digital DVI-D interface.

Scalable to DVI standard

As VGA based video applications very often come along with smaller resolutions, the device enables upscaling to 1080p or 1920x1200 that is naturally supported by most DVI-D monitors. The configuration of the device in order to meet any specific applications can be easily done via integrated OSD menu using the keyboard for control.

Full compatibility

With respect to compatibility, the device can be used with any kind of Draco ultra extenders and add-on modules, including DisplayPort and HDMI devices. The DVI-I CPU Unit is also suitable for the use with Draco tera matrix switches.

Product Features

- Input of DVI-D and VGA signals, depending on the application
- Extended configuration options via OSD
- Integrated scaler (1080p, 1920x1200)
- Variety of supported Single Link input resolutions
- Lici® (Lightweight Image Coding technology)
- Superior image quality in all resolutions
- Redundant data link (optional)
- 19" rack mount kit (optional)
- Power supply included
- Compatible* with all:
 - major operating systems
 - chassis of the Draco vario series
 - IHSE Draco KVM matrix switches with XV interfaces
 - other main modules of Draco vario ultra extenders
 - Draco vario add-on modules for audio and data signals such as USB 2.0, balanced audio or RS232

TECHNICAL DATA	
Input	DVI-I (VGA & DVI-D)
Maximum Resolution	1920 x 1200 @ 60 Hz
Color Depth	8 bit / True Color
Maximum Cable Distance	Cat X 140 m Single-mode (9 μ) 10 km
Optional Interfaces	USB 2.0 embedded, analog audio with RS232 or RS422, digital audio, PS/2, balanced audio
Keyboard/ Mouse	USB-HID



*Video Transmission of the Draco vario ultra extenders (series 49x) is not compatible with the main modules of Draco vario Classic (series 47x/48x) and the Draco compact extenders (series 477) .

Functional Diagram

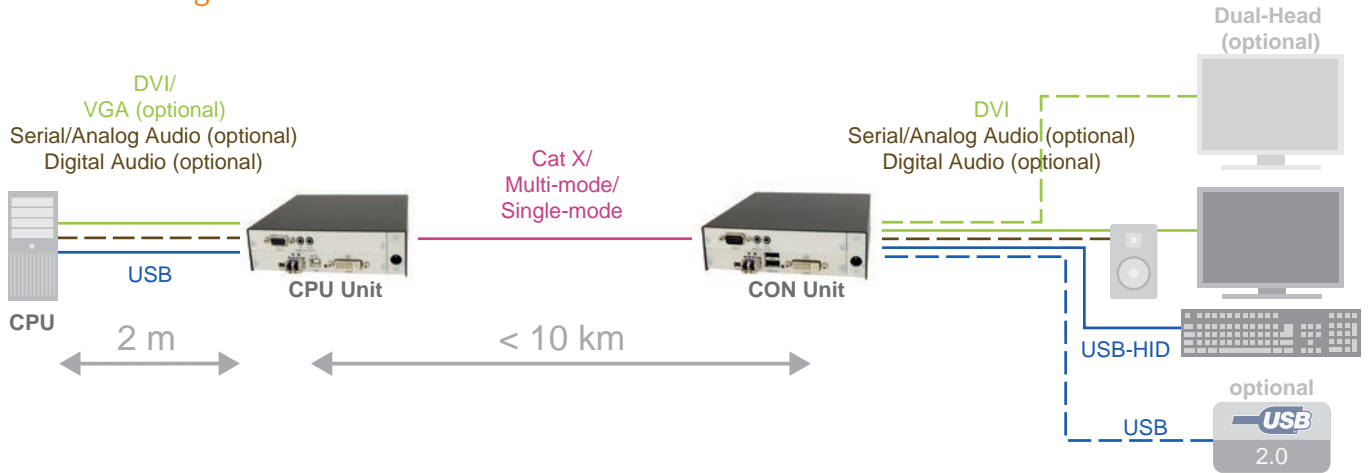

Order Numbers

FUNCTIONS	CPU UNIT (LOCAL)	PART NO.
		L494-BVHC L494-BVHS
		L494-BVHCR L494-BVHSR



- HDMI 1.3 Interface
- Optional: Local HDMI-Access
- Optional: KVM Switch in CON Unit
- Compatible with all Draco devices
- Fraunhofer IIS' Lici® codec included

Product Information

Use the Draco vario HDMI Extender to extend video signals without entailing any loss of quality up to 10 km. Pictures are displayed without delay, brilliantly clear and in highest resolutions, including full HD and 2K.

Support of 3D and audio

Even 3D formats can be transmitted fast and without difficulty. Experience excellent sound data with finest details by digital audio transmission via HDMI. Take advantage of highest flexibility: For interconnections both Cat X and fiber can be used.

Various add-ons available

In case you do not need USB transmission we optionally offer a less expensive, half-sided HDMI extra module. This module can be used for video extension as well as for realization of multi head applications. Furthermore, we offer an optional CPU unit with local access to connect an HDMI monitor as well as a CON Unit with switchable HDMI input for local sources, e.g. computers.

Product Features

- The standard version allows operation of a remote workstation with a HDMI/DVI-D monitor and two USB-HID devices (keyboard and mouse)
- High resolution video via HDMI interface
- Lockable HDMI port
- The interface is compatible with 3D technology. Side-by-Side and Top-and-Bottom formats can be transmitted
- Compatible with all major operating systems
- Compatible with IHSE Draco KVM switches and Draco vario ultra extenders (add-on modules included)*
- HDMI embedded audio is cross compatible with digital audio add-on modules
- Redundant data link (optional)
- Fits into one 19"/1U rack (19" rack mount kit and brackets available)

TECHNICAL DATA	
Power Supply	International power supply unit (90-240V Input)
Input	HDMI 1.3
Output	HDMI 1.3
Maximum Resolution	1920 x 1200 @ 60 Hz 2048 x 1152 @ 60 Hz
Color Depth	8 bit / True Color
Maximum Cable Distance	Cat X 140 m Single-mode (9 μ) 10 km
Optional Interfaces	USB 2.0 embedded, analog audio with RS232 or RS422, digital audio, PS/2, balanced audio
Keyboard/Mouse	USB-HID (support of keyboard/mouse)
Update	Onboard Flash



*Video Transmission of the Draco vario ultra extenders (series 49x) is not compatible with the main modules of Draco vario Classic (series 47x/48x) and the Draco compact extenders (series 477) .

Functional Diagram

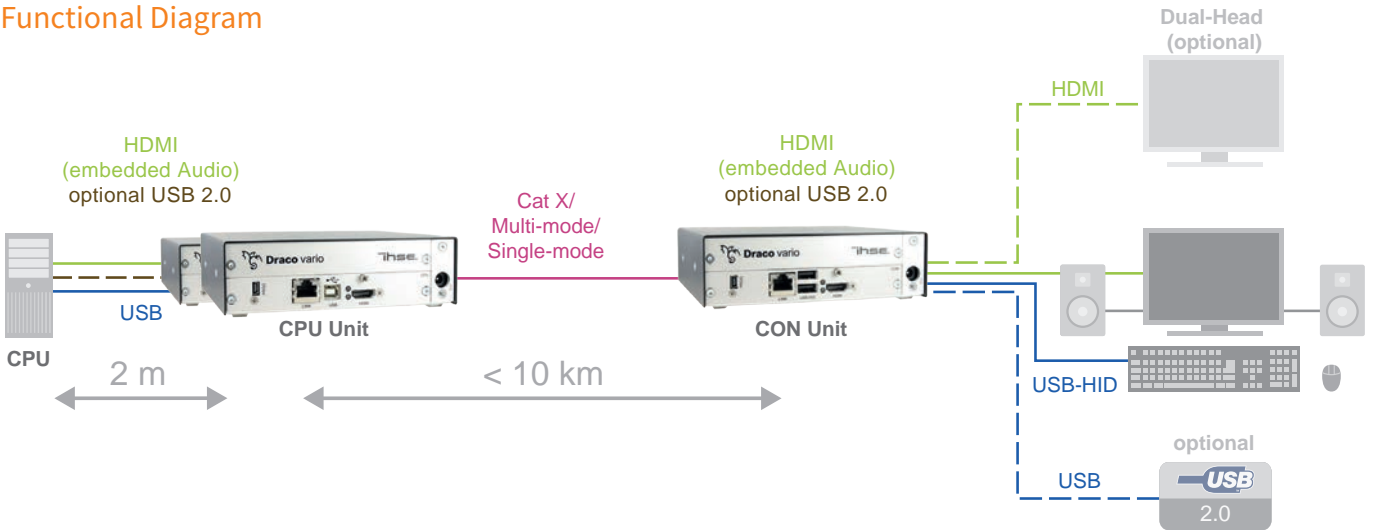

Order Numbers

FUNCTIONS	CPU UNIT (LOCAL)	PART NO.	CON UNIT (REMOTE)	PART NO.
HDMI, USB HID		L491-BHHC L491-BHHS		R491-BHHC R491-BHHS
HDMI, USB HID, Redundant		L491-BHHCR L491-BHHSR		R491-BHHCR R491-BHHSR
HDMI, Local Video, USB HID	 With integrated Local-Video-Access	L491-BHHCL L491-BHHSCL		
HDMI, Local Video, USB HID, Redundant	 With integrated Local-Video-Access	L491-BHHCLR L491-BHHSCLR		
HDMI, KVM Switch, USB HID			 KVM switch functionality included	R491-BHHCW R491-BHHSW
HDMI, KVM Switch, USB HID, Redundant			 KVM switch functionality included	R491-BHHCWR R491-BHHSWR



- The HDMI extender is fully compatible to monitors and computers with DVI-D or DisplayPort interfaces by just using a passive adapter cable
- Using the balanced or digital audio add-on module on the HDMI CON Unit allows the parallel audio output at both the add-on module and HDMI interface



- Resolutions up to 4096 x 2160 @ 60 Hz
- 30 bit (Deep Color), 4:2:2, no frame drops
- Mix & Match HDMI 2.0 with DP 1.2 input/output
- Combined video and audio transmission
- Local output on CPU Unit
- Local input on CON Unit

Product Information

The Draco vario ultra HDMI 2.0 extender enables the operation of CPUs from a remotely located workstation including HDMI monitor, keyboard and pointing device over a duplex LC fiber connection. Transfer of fully-digital video is supported in 4K resolutions up to 4096 x 2160 and

3840x2160 at a real 60-Hz refresh rate and color depth (24 bit, 4:4:4 or 30 bit, 4:2:2). The KVM extender also supports audio transmission via the HDMI interface. Integration of optional Draco vario add-on modules for digital audio input and output as well as data signals, such as

USB 2.0 and RS232 is also possible. For a direct video access in the server room, the CPU Unit includes a local output to connect a control monitor. At the same time there is a local input on the CON Unit to connect a locally connected source (switchable).

Product Features

- Operation of CPUs from a remote workstation with a HDMI 2.0 monitor and USB-HID devices
- Transmission of fully-digital video signals up to 4K DCI (4096 x 2160) and UHD (3840 x 2160)
- New lossless video codec (visually), no frame drops, 30 bit (Deep Color) 4:2:2
- PCM audio format can be transferred via the HDMI interface (up to 96 kHz)
- Local output on CPU Unit (Micro HDMI)
- Local input on CON Unit (Micro HDMI)
- Optional: Redundant data link for 24/7 availability
- Compatible* with all:
 - major operating systems
 - chassis of the Draco vario series
 - IHSE Draco tera KVM matrix switches with XV interfaces
 - other main modules of Draco vario ultra extenders (49x series)
 - Draco vario add-on modules for audio and data signals such as USB 2.0, balanced audio or RS232

TECHNICAL DATA	
Power Supply	International power supply unit (90-240V Input)
Input	HDMI 2.0
Output	HDMI 2.0
Maximum Resolution	1920 x 1080 @ 240 Hz 1920 x 1200 @ 60 Hz 2048 x 2048 @ 60 Hz 2560 x 2048 @ 60 Hz 3840 x 2160 @ 60 Hz (30 bit, 4:2:2 or 24 bit, 4:4:4) - UHD 4096 x 2160 @ 60 Hz (30 bit, 4:2:2 or 24 bit, 4:4:4) - 4K DCI
Color Depth	10 bit / Deep Color
Maximum Cable Distance	Cat X XV (3G) 100 m Single-mode XV (9 μ) 5 km
Optional Interfaces	USB 2.0 embedded, analog audio with RS232 or RS422, digital audio, PS/2, balanced audio
Keyboard/Mouse	USB-HID
Audio	Standards: Stereo Linear Pulse Code Modulation (LPCM)
	Bit Depth: 16 – 24 bit
	Sample Rate: 32 – 192 kHz



*Video Transmission of the Draco vario ultra extenders (series 49x) is not compatible with the main modules of Draco vario Classic (series 47x/48x) and the Draco compact extenders (series 477) .

Functional Diagram

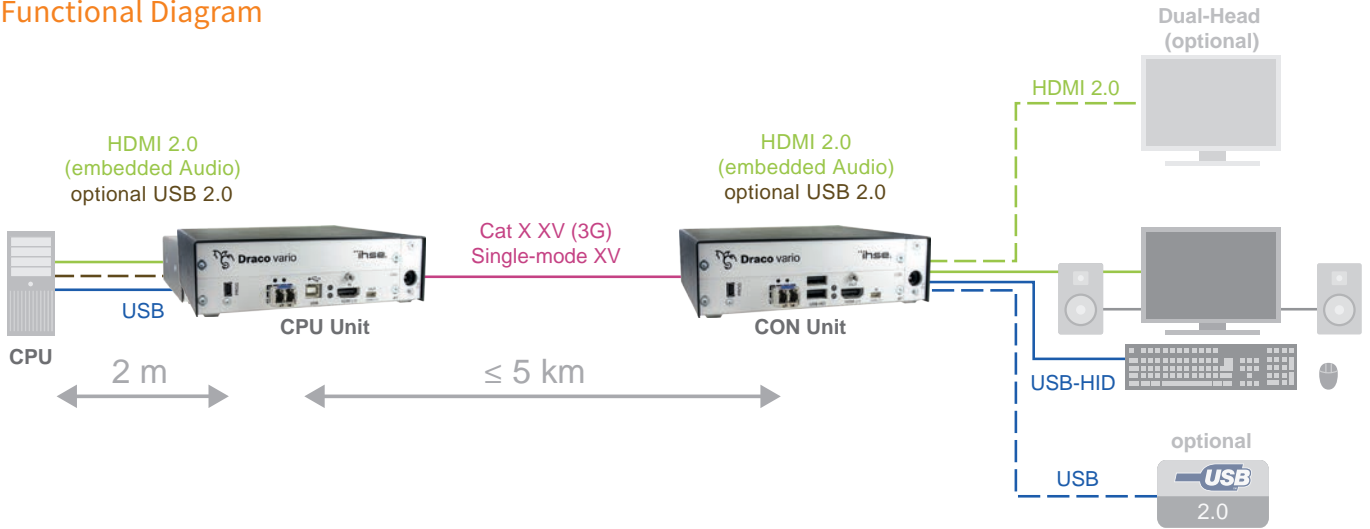

Order Numbers

FUNCTIONS	CPU UNIT (LOCAL)	PART NO.	CON UNIT (REMOTE)	PART NO.
		L495-BHHCXL L495-BHHXL		R495-BHHCXL R495-BHHXL
		L495-BHHCXLR L495-BHHXLR		R495-BHHCXLR R495-BHHXLR



- The HDMI extender is fully compatible to monitors and computers with DVI-D or DisplayPort interfaces by just using a passive adapter cable.
- Using any balanced or digital audio add-on module on the HDMI CON Unit allows the parallel audio output at both the add-on module and HDMI interface.



- Resolutions up to 4096 x 2160 (4K)
- DMS-59 adapter included
- Data transmission via Cat X or fiber
- Redundant interconnect option
- DMS-59 port for 1 x DVI-D Dual Link

Product Information

When used in conjunction with KVM matrix systems, the Draco vario ultra Dual-Head KVM extender saves valuable matrix ports. Its sister product, the Draco vario ultra Dual Link KVM extender, enables the transmission of DVI signals to one single monitor up to 4K resolution. Extension of signals requires a single data cable. The extenders

are compatible with regular Single-Head/Single extenders: Consoles can access Single-Head/Single Link CPU Units instantaneously. In this case, signals from Single-Head/Single Link sources are embedded within the Dual Link signal format and can be switched with no discernible switching delay. Single-Head/Single Link images are displayed at their

own native resolution within a blanked area on-screen.

Product Features





















- Excellent image quality at all resolutions
- Only one KVM matrix port per unit required
- Wide range of additional options:
 - Two USB ports for HID devices
 - USB 2.0 embedded
 - Serial interface (RS232 or RS422)
 - Analog audio
 - Digital audio
- Redundant data link
- 19" rack mount kit available
- Redundant power (load-sharing) optional
- Compatible* with all:
 - major operating systems
 - chassis of the Draco vario series
 - IHSE Draco KVM matrix switches
 - other main modules of Draco vario ultra extenders (49x series)
 - Draco vario add-on modules for audio and data signals such as USB 2.0, balanced audio or RS232

TECHNICAL DATA	
Input	DMS-59 (DVI-D Dual Link adapter)
Output	DMS-59 (DVI-D Dual Link adapter)
Data rates (max.)	330 MPixel/s (Dual Link)
Maximum Resolution	Draco vario ultra Dual Link: 2560 x 2048 @ 60 Hz 4096 x 2160 @ 30 Hz
Color Depth	8 bit / True Color
Maximum Cable Distance	Cat X 140 m Multi-mode 1 km Single-mode XV (9 μ) 5 km Single-mode (9 μ) 10 km
Optional Interfaces	USB 2.0, analog audio with RS232, RS422, digital audio, PS/2, etc.
Keyboard/Mouse	2 x USB-HID



*Video Transmission of the Draco vario ultra extenders (series 49x) is not compatible with the main modules of Draco vario Classic (series 47x/48x) and the Draco compact extenders (series 477) .

Order Numbers

FUNCTIONS	CPU UNIT (LOCAL)	PART NO.	CON UNIT (REMOTE)	PART NO.
 		 L492-BDHC  L492-BDHS  L492-BDHX		 R492-BDHC  R492-BDHS  R492-BDHX
  		 L492-BDHCR  L492-BDHSR  L492-BDHXR		 R492-BDHCR  R492-BDHSR  R492-BDHXR

Functional Diagram

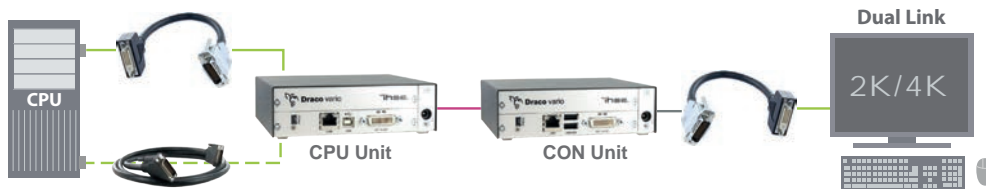

Optional cable:
 DMS-59 > DVI-D Dual Link
 (see accessories on page 44)



- Resolutions up to 4096 x 2160 @ 30 Hz
- 8 bit (True Color), 4:4:4
- Lossless transmission
- Transmission of all frames at 30 Hz
- Data transmission via fiber/Cat X
- Combined video and audio transmission
- Single sided connectivity
- Redundant power supply

Product Information

The Draco vario ultra DisplayPort extender enables the operation of CPUs from a remotely located workstation including DisplayPort monitor, keyboard and pointing device over a single fiber connection.

Transfer of fully-digital video is supported in 4K resolutions up to 4096 x 2160 and 3840 x 2160 at a real 30 Hz refresh rate and full color depth (8 bit, 4:4:4). The KVM extender also supports audio transmission via the

DisplayPort interface. Integration of optional Draco vario add-on modules for digital audio input and output as well as data signals, such as USB 2.0 and RS232 is also possible.

Product Features

- Operation of CPUs from a remote workstation with a DisplayPort monitor and USB-HID devices
- Transmission of fully-digital video signals up to 4K DCI (4096 x 2160) and UHD (3840 x 2160)
- New lossless video codec (visually), no frame drops, full color depth, 8 bit (True Color) 4:4:4
- PCM audio format can be transferred via the DisplayPort interface (up to 96 kHz)
- Embedded mode for lower video resolutions allows instant switching via Draco tera
- Optional: Redundant data link for 24/7 availability
- Compatible* with all:
 - major operating systems
 - chassis of the Draco vario series
 - IHSE Draco KVM matrix switches with XV interfaces
 - other main modules of Draco vario ultra extenders (49x series)
 - Draco vario add-on modules for audio and data signals such as USB 2.0, balanced audio or RS232

TECHNICAL DATA	
Input	DisplayPort 1.1
Output	DisplayPort 1.1
Maximum Resolution	2560 x 2048 @ 60 Hz 4096 x 2160 @ 30 Hz
Color Depth	8 bit / True Color
Maximum Cable Distance	Cat X 140 m Multi-mode 1 km Single-mode XV (9 μ) 5 km Single-mode (9 μ) 10 km
Optional Interfaces	USB 2.0 embedded, analog audio with RS232 or RS422, digital audio, PS/2, balanced audio
Keyboard/Mouse	USB-HID



*Video Transmission of the Draco vario ultra extenders (series 49x) is not compatible with the main modules of Draco vario Classic (series 47x/48x) and the Draco compact extenders (series 477) .

Functional Diagram

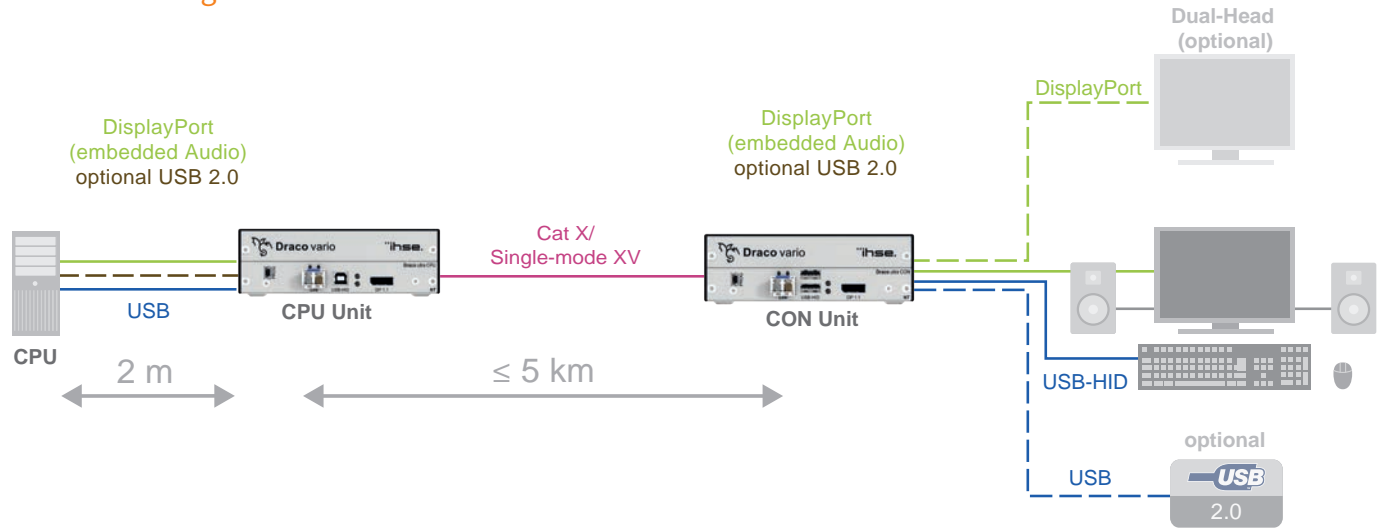

Order Numbers

FUNCTIONS	CPU UNIT (LOCAL)	PART NO.	CON UNIT (REMOTE)	PART NO.
		L493-BPHC L493-BPHS L493-BPHX		R493-BPHC R493-BPHS R493-BPHX
		L493-BPHCR L493-BPHSR L493-BPHXR		R493-BPHCR R493-BPHSR R493-BPHXR



- Resolutions up to 4096 x 2160 @ 60 Hz
- 10 bit (Deep Color), 4:4:4
- Lossless transmission
- Transmission of all frames at 60 Hz
- Data transmission via single fiber
- Combined video and audio transmission
- Single sided connectivity
- Redundant power supply
- Support for 1080p240

Product Information

The Draco vario ultra DP extender enables the operation of CPUs from a remotely located workstation including DisplayPort monitor, keyboard and pointing device over a single fiber connection. Transfer

of fully-digital video is supported in 4K resolutions up to 4096 x 2160 and 3840x2160 at a real 60-Hz refresh rate and full color depth (30 bit, 4:4:4). The KVM extender also supports audio transmission via the DisplayPort

interface. Integration of optional Draco vario upgrade modules for digital audio input and output as well as data signals, such as USB 2.0 and RS232 is also possible.

Product Features

- Operation of CPUs from a remote workstation with a DisplayPort monitor and USB-HID devices
- Transmission of fully-digital video signals up to 4K DCI (4096 x 2160) and UHD (3840 x 2160)
- New lossless video codec (visually), no frame drops, full color depth
- PCM audio format can be transferred via the DisplayPort interface (up to 96 kHz)
- Transmission of monitor EDID information by hotkey; including permanent storage in the CPU Unit
- Embedded mode for lower video resolutions allows instant switching via Draco tera
- Optional: Redundant data link for 24/7 availability
- Local DP1.2 feedthrough and Remote DP1.2 switch
- Compatible* with all:
 - major operating systems
 - chassis of the Draco vario series
 - IHSE Draco KVM matrix switches with XV interfaces
 - other main modules of Draco vario ultra extenders (49x series)
 - Draco vario add-on modules for audio and data signals such as USB 2.0, balanced audio or RS232

TECHNICAL DATA	
Input	DisplayPort 1.2
Output	DisplayPort 1.2
Maximum Resolution	1920 x 1080 @ 240 Hz 1920 x 1200 @ 60 Hz 2048 x 2048 @ 60 Hz 2560 x 2048 @ 60 Hz 3840 x 2160 @ 60 Hz (30 bit) - UHD 4096 x 2160 @ 60 Hz (30 bit) - 4K DCI
Color Depth	10 bit / Deep Color 4:4:4
Maximum Cable Distance	Cat X XV (3G) 100 m Single-mode XV (9 μ) 5 km
Optional Interfaces	USB 2.0 (high speed or full speed), analog audio with RS232 or RS422, digital audio, PS/2, USB embedded, balanced audio
Keyboard/Mouse	USB-HID
Audio	Standards: Stereo Linear Pulse Code Modulation (LPCM) Bit Depth: 16 – 24 bit Sample Rate: 32 – 192 kHz

 *Video Transmission of the Draco vario ultra extenders (series 49x) is not compatible with the main modules of Draco vario Classic (series 47x/48x) and the Draco compact extenders (series 477) .

Functional Diagram

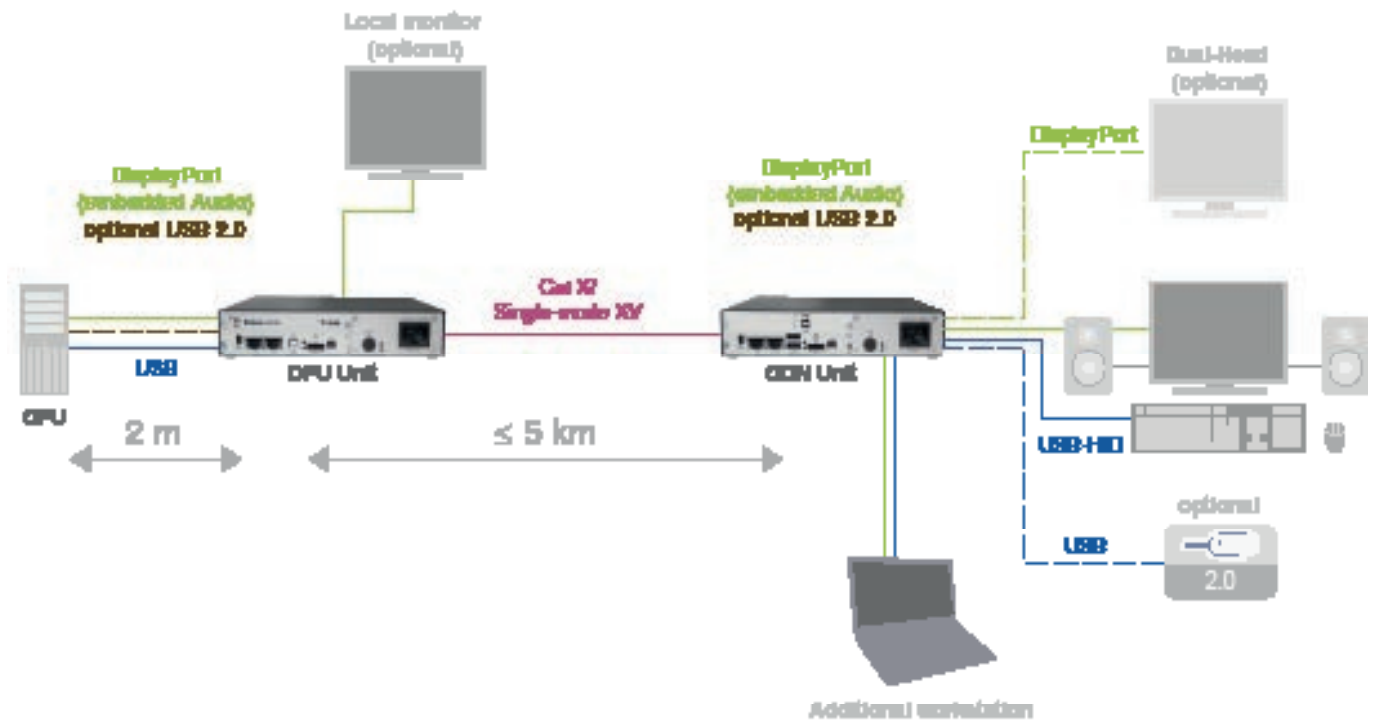













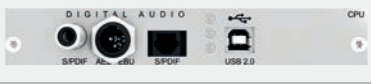









Order Numbers

FUNCTIONS	CPU UNIT (LOCAL)	PART NO.	CON UNIT (REMOTE)	PART NO.
DisplayPort 1.2 4K 60Hz ULTRAHD USB HID		L490-BPHC L490-BPHX		L490-BPHC R490-BPHX
DisplayPort 1.2 4K 60Hz ULTRAHD USB HID	(local out)	L490-BPHCXL L490-BPHXL		R490-BPHCXL R490-BPHXL
DisplayPort 1.2 4K 60Hz ULTRAHD USB HID Redundant	(local out)	L490-BPHCXL R L490-BPHXL R		R490-BPHCXL R R490-BPHXL R

Order Numbers of Add-on Modules

FUNCTIONS	CPU UNIT (LOCAL)	PART NO.	CON UNIT (REMOTE)	PART NO.
USB 2.0 embedded CPU and CON add-on modules for transmission of USB 2.0 embedded up to 36 Mbit/s. All relevant USB devices are supported, including storage media and audio. Transmission within the data stream of the main module.		L474-BXE		R474-BXE
USB 2.0 embedded flex speed CPU and CON add-on modules for transmission of USB 2.0 embedded flex speed (50/100 Mbit/s). Transmission within the data stream of the main module.		L474-BXE2		R474-BXE2
USB-HID CPU and CON add-on modules for transmission of two additional USB-HID devices. Most USB-HID devices are supported, e.g. keyboards, mice, graphic tablets and many touch screens. Transmission within the data stream of the main module.		L474-BXH		R474-BXH
RS232, analog audio CPU and CON add-on modules for transmission of RS232 (up to 115.2 kBaud with hardware handshake) and analog, bidirectional stereo audio for loudspeakers and microphone input with line level. Transmission within the data stream of the main module.		L474-BAX		R474-BAX
RS422, analog audio CPU and CON add-on modules for transmission of RS422 (up to 115.2 kBaud with hardware handshake) and analog, bidirectional stereo audio for loudspeakers and microphone input with line level. Transmission within the data stream of the main module.		L474-BSX		R474-BSX
RS422, 2x analog audio CPU and CON add-on modules for transmission of bidirectional RS422. Transmission within the data stream of the main module.		L474-BSS		R474-BSS
RS232, analog audio, PS/2 CPU and CON combined add-on modules for transmission of RS232, analog audio and PS/2 keyboard/mouse. Transmission within the data stream of the main module.		L474-BAP		R474-BAP
Digital audio CPU and CON add-on modules for transmission of digital, unidirectional audio via coaxial, mini-XLR or optical connector. Compatible to AES/EBU, S/PDIF, EIAJ CP1201, IEC 60958. Transmission of 32-96 kHz @ 24 bit. Transmission within the data stream of the main module. Compatible to HDMI / DisplayPort embedded audio.		L474-BDX		R474-BDX
Balanced audio CPU and CON add-on modules for transmission of unidirectional 2-channel-mono or 1-channel-stereo audio with 2x 6.35 jack sockets. The modules support 48V phantom power and pre-amplification up to 65 dB. Compatible to digital audio add-on modules and HDMI / DisplayPort embedded audio.		L474-BBX		R474-BBX

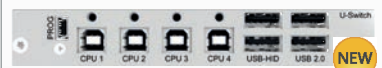

FUNCTIONS	CPU UNIT (LOCAL)	PART NO.	CON UNIT (REMOTE)	PART NO.
<p>Balanced audio, USB 2.0 embedded flex speed CPU and CON add-on modules for transmission of unidirectional 2-channel-mono or 1-channel-stereo audio with 2x 6.35 jack sockets and USB 2.0 embedded flex speed (50/100 Mbit/s). The modules support 48V phantom power and pre-amplification up to 65 dB. Transmission within the data stream of the main module. Compatible to digital audio add-on modules and HDMI / DisplayPort embedded audio.</p>		L474-BBE2		R474-BBE2
<p>USB-HID, RS232, analog audio CPU and CON combined add-on modules for transmission of RS232, analog audio and USB-HID. Transmission within the data stream of the main module.</p>		L474-BAH		R474-BAH
<p>USB-HID, RS422, analog audio CPU and CON combined add-on modules for transmission of RS422, analog audio and USB-HID. Transmission within the data stream of the main module.</p>		L474-BSH		R474-BSH
<p>USB-HID, digital audio CPU and CON combined add-on modules for transmission of digital audio and USB-HID. Transmission within the data stream of the main module.</p>		L474-BDH		R474-BDH
<p>USB 2.0 embedded, digital audio CPU and CON combined add-on modules for transmission of digital audio and USB 2.0 embedded up to 36 Mbit/s. Transmission within the data stream of the main module.</p>		L474-BDE		R474-BDE
<p>USB 2.0 embedded flex speed, digital audio CPU and CON combined add-on modules for transmission of digital audio and USB 2.0 embedded flex speed (50/100 Mbit/s). Transmission within the data stream of the main module.</p>		L474-BDE2		R474-BDE2
<p>USB 2.0 embedded, RS232, analog audio CPU and CON combined add-on modules for transmission of RS232, analog audio and USB 2.0 embedded up to 36 Mbit/s. Transmission within the data stream of the main module.</p>		L474-BAE		R474-BAE
<p>USB 2.0 embedded flex speed, RS232, analog audio CPU and CON combined add-on modules for transmission of RS232, analog audio and USB 2.0 flex speed (up to 50/100 Mbit/s). Transmission within the data stream of the main module.</p>		L474-BAE2		R474-BAE2
<p>USB 2.0 embedded, RS422, analog audio CPU and CON combined add-on modules for transmission of RS422, analog audio and USB 2.0 embedded up to 36 Mbit/s. Transmission within the data stream of the main module.</p>		L474-BSE		R474-BSE

FUNCTIONS	CPU UNIT (LOCAL)	PART NO.	CON UNIT (REMOTE)	PART NO.
USB 2.0 embedded flex speed, RS422, analog audio CPU and CON combined add-on modules for transmission of RS422, analog audio and USB 2.0 flex speed (up to 50/100 Mbit/s). Transmission within the data stream of the main module.		L474-BSE2		R474-BSE2
Digital audio bidirectional CPU and CON combined add-on modules for transmission of digital bidirectional audio. Transmission within the data stream of the main module.		L474-BDD		R474-BDD
RS232, analog audio, digital audio CPU and CON combined add-on modules for transmission of digital audio and RS232, analog audio. Transmission within the data stream of the main module.		L474-BDA		R474-BDA
Push button Add-on module for CON Units for calling OSD when keyboard is not available.				R474-PUSH
8 x GPIO Add-on module for CON Units configurable for up to 8 in-/outputs.				R474-BGX
8 x GPIO, embedded USB 2.0, 50/100 Mbit/s FDX Add-on module for CON Units configurable for up to 8 in-/outputs. Embedded USB 2.0, 50/100 Mbit/s FDX.				R474-BGE2
Draco U-Switch Module (for mounting in Draco vario chassis), 4 port USB-Switch (2x USB-HID and 2x USB 2.0 devices supported)				B476-4U4T

SNMP MONITORING MODULE

FUNCTIONS	CON UNIT (REMOTE)	PART NO.
Monitoring module with SNMP (TCP/IP + RS232) (chassis configuration, add-on module suitable for 474-BODY6BP/BPF and 474-BODY21/4U)		474-SNMP

USB 2.0 MODULES (STANDALONE)

FUNCTIONS	CPU UNIT (LOCAL)	PART NO.	CON UNIT (REMOTE)	PART NO.
USB 2.0 high speed CPU and CON add-on modules for transmission of USB 2.0 high speed (up to 480 Mbit/s). All relevant USB devices are supported, including storage media and audio. Transmission according to the model via Cat X or fiber.		L474-BXUC L474-BXUS		R474-BXUC R474-BXUS

Advanced options for audio conversion

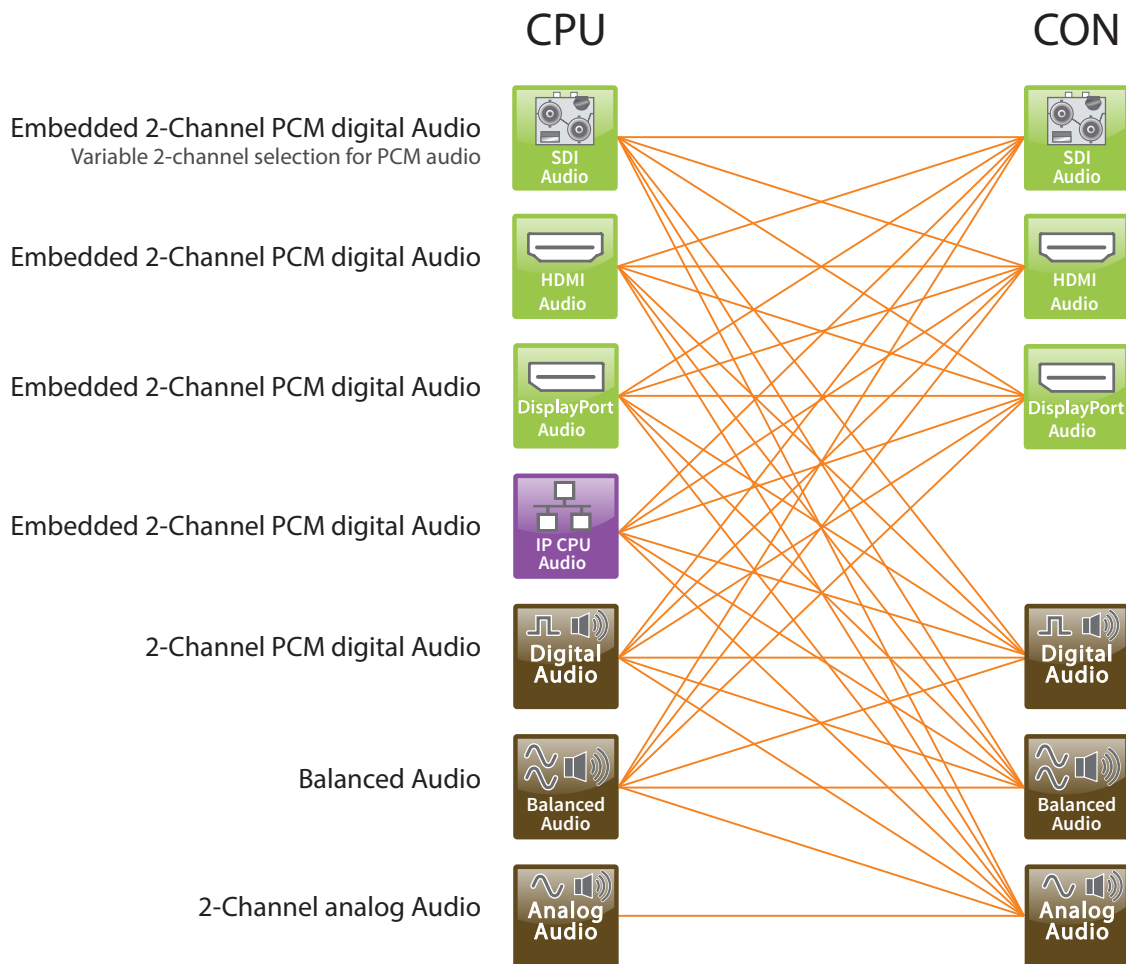

Draco vario extender series enables cross-audio conversion between analog, digital and video-embedded audio signals.







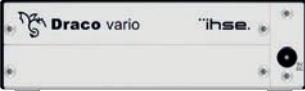
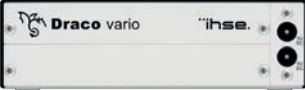

Maximum speed, minimum cabling - perfect USB 2.0 extension

The compact, half-width, architecture of Draco vario USB 2.0 add-on modules are supplied as an upgrade to the Draco vario and Draco ultra KVM extender series and offer an integrated 2-/4-port USB 2.0 hub with a bandwidth of up to 480 Mbit/s.

Using a sophisticated data protocol, the extenders achieves data rates six times higher than conventional USB 2.0 modules: the fastest data transmission in the KVM industry.

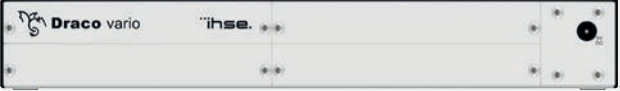
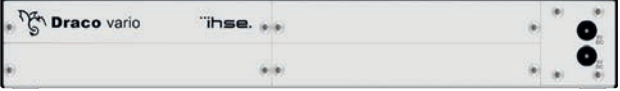
- 
USB 2.0 embedded (36 Mbit/s)
- 
USB 2.0 flex speed (50/100 Mbit/s)
- 
USB 2.0 Hi-Speed (480 Mbit/s)

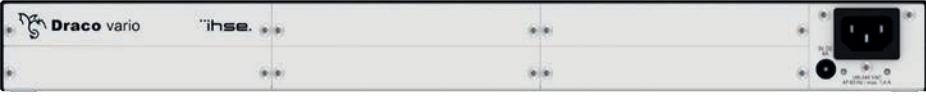
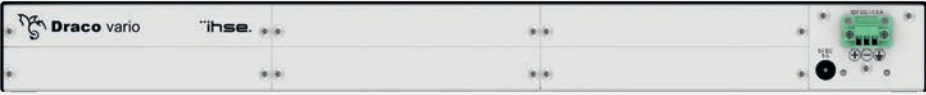
CHASSIS FOR FREE CONFIGURATION	PART NO.
<p>Chassis for 2 modules, external power supply</p>  <p>145 x 147 x 44 mm (5.7 x 5.8 x 1.7 inch)</p>	<p>474-BODY2 <i>1U rack kit: 474-2RMK</i></p>
<p>Chassis for 2 modules, external power supply, setup for redundant power supply</p>  <p>145 x 147 x 44 mm (5.7 x 5.8 x 1.7 inch)</p>	<p>474-BODY2R <i>1U rack kit: 474-2RMK</i></p>
<p>Chassis for 2 modules, integrated power supply, setup for redundant power supply</p>  <p>221 x 147 x 44 mm (8.7 x 5.8 x 1.7 inch)</p>	<p>474-BODY2N <i>1U rack kit: 474-2NRMK</i></p>
<p>Chassis for 2 modules, with integrated backplane and power supply, setup for redundant external power supply (lockable)</p>  <p>221 x 181 x 44 mm (8.7 x 7.1 x 1.7 inch)</p>	<p>474-BODY2BPF <i>1U rack kit: 474-2NRMK</i></p>
<p>Chassis for 2 modules, integrated 12V/24V/48V DC power supply, setup for redundant power supply</p>  <p>221 x 147 x 44 mm (8.7 x 5.8 x 1.7 inch)</p>	<p>474-BODY2DC-12 474-BODY2DC-24 474-BODY2DC-48 <i>1U rack kit: 474-2NRMK</i></p>
<p>Chassis for 4 modules, external power supply</p>  <p>239 x 147 x 44 mm (11.5 x 5.8 x 1.7 inch)</p>	<p>474-BODY4 <i>1U rack kit: 474-4RMK</i></p>
<p>Chassis for 4 modules, external power supply, setup for redundant power supply</p>  <p>239 x 147 x 44 mm (11.5 x 5.8 x 1.7 inch)</p>	<p>474-BODY4R <i>1U rack kit: 474-4RMK</i></p>

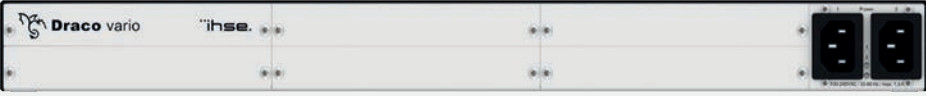
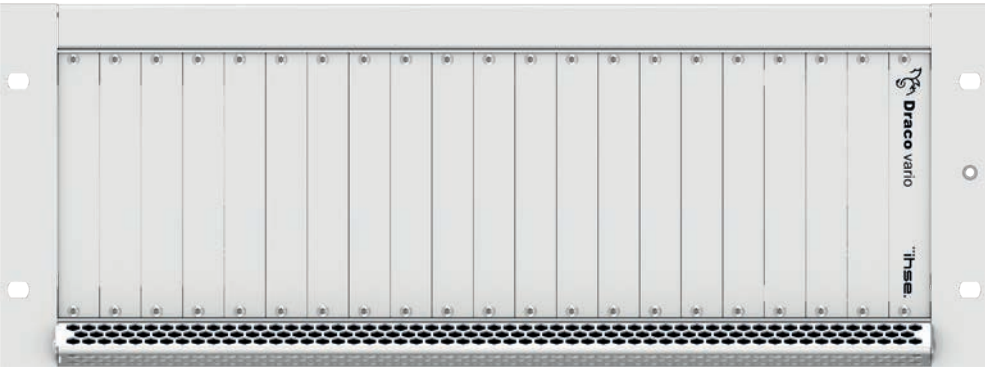
CHASSIS FOR FREE CONFIGURATION	PART NO.
<p>Chassis for 6 modules, integrated power supply, setup for redundant power supply</p>  <p>442 x 147 x 44 mm (17.4 x 5.8 x 1.7 inch)</p>	<p>474-BODY6R-R1 <i>1U rack kit: 474-6RMK</i></p>
<p>Chassis for 6 modules, integrated 12V/24V/48V DC power supply, setup for redundant power supply</p>  <p>442 x 147 x 44 mm (17.4 x 5.8 x 1.7 inch)</p>	<p>474-BODY6DC-12 474-BODY6DC-24 474-BODY6DC-48 <i>1U rack kit: 474-6RMK</i></p>
<p>Chassis for 6 modules, backplane with 2 integrated power supply units on back side, <i>hot swappable extender modules</i></p>  <p>442 x 250 x 44 mm (17.4 x 9.8 x 1.7 inch)</p>	<p>474-BODY6BP Optional: Chassis fan 474-6FAN <i>1U rack kit: 474-6RMK</i></p>
<p>Chassis for 6 modules, backplane with 2 integrated power supply units on front side, <i>hot swappable extender modules</i></p>  <p>442 x 250 x 44 mm (17.4 x 9.8 x 1.7 inch)</p>	<p>474-BODY6BPF Optional: Chassis fan 474-6FAN <i>1U rack kit: 474-6RMK</i></p>
<p>4 RU / 19" rack chassis for 21 modules, integrated power supply, setup for redundant power supply, <i>hot swappable extender modules</i></p>  <p>482 x 462 x 176 mm (19 x 18.2 x 6.9 inch)</p>	<p>474-BODY21/4U <i>4U frame</i></p>



Order Numbers

RACK MOUNT HARDWARE AND POWER SUPPLIES	PART NO.
VESA mounting plate to mount by screws	477-VESA
Blind plate for all chassis models	474-BLND1
Fastening strips for screw-on mounting	474-VPLATE
Fastening strips for snap-on mounting	474-VSNAP
19"/1 RU rack mount kit for 2 and 4 bay chassis	474-VRMK
Mounting bracket for 2/4/6 bay chassis (L-brackets with screw slots)	474-BRACKET
Rack mount kit for 2 bay vario chassis with internal PSU	474-2NRMK
Rack mount kit for 2 bay vario chassis	474-2RMK
Rack mount kit for 4 bay vario chassis	474-4RMK
Rack mount kit for 6 bay vario chassis	474-6RMK
Power supply for 2 bay chassis (spare part or redundancy)	474-PSU2
Power supply (lockable) for 2 bay chassis with integrated backplane (spare part or redundancy)	474-PSU2BPF
Power supply for 4 bay chassis (spare part or redundancy)	474-PSU4
Power supply for 6 bay chassis (spare part or redundancy)	474-PSU6
Power supply for 19" rack (spare part or redundancy)	474-PSU21
Chassis fan for 474-BODY6BP and 474-BODY6BPF	474-6FAN
Fan cartridge module for Draco vario chassis (retrofitable for all Draco vario chassis)	474-MODFAN
DMS-59 > DMS-59 cable Dual Link	436-DL59
DMS-59 > DMS-59 cable DVI-D 2x	436-DH59
DMS-59 > DMS-59 connector, 100 cm, Dual-Head / Dual Link	436-DMS1
DMS-59 > DMS-59 connector, 180 cm, Dual-Head / Dual Link	436-DMS2

CONFIGURATION OF ORDER NUMBERS OF DRACO VARIO & DRACO VARIO ULTRA

Reference only – not all combinations available.

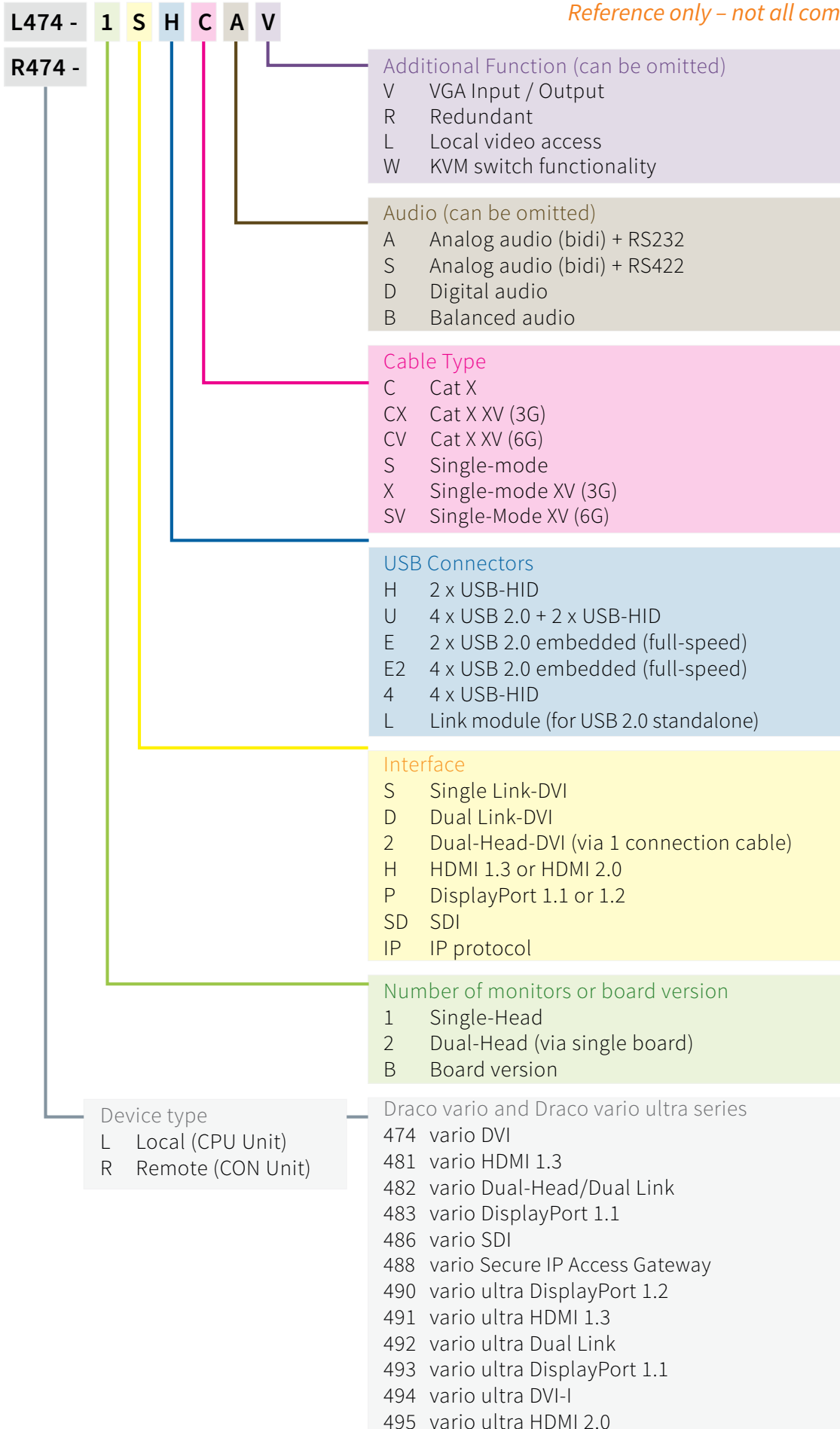



Intel® Digital Signage Open Pluggable Specification (OPS) compliant IHSE Draco KVM extender

- Single wire connection to displays
- Industry-wide display compatibility
- Enabling GPU workstation performance
- Highest performing graphics (fanless)
- Fraunhofer IIS' Lici® codec included
- Enhanced maintainability

Product Information

The Draco OPS 2K60 and the Draco ultra OPS 4K60 KVM extender simplify the installation, operation and management of remote displays in retail signage, airports, train stations, medical, industrial, education and other applications. A single module inserted into a standard OPS socket delivers Full HD video or 4K60 video and

analog audio connectivity, with full interactivity. Single wire (Cat X or fiber) enables remote connection to displays up to 140 m/10 km from the media source. USB-HID is being fully supported, mouse and keyboard are connected to the HID ports. USB 2.0 embedded support ensures the use of the monitor's touch screen function, if included by the monitor.

For hard-to-access, highly secure installations and better system management the Draco OPS KVM extender delivers the ideal solution. The device is fully compatible to the extenders of the Draco vario series and the signals can be distributed via Draco tera matrices.

Product Features

- Supports Intel® OPS standard
- Compatible with any display having an OPS slot
- Allows the displays to be located anywhere, with single cable connection and no additional power or network cables
- Source switching: any source to any display due to full Draco tera KVM matrix compatibility
- Signal distribution via matrix allows a single source to be shared across multiple displays
- Reliability and continuous operation via redundant link
- Provides workstation video power in a standardized, small formfactor (OPS) without noise (no fan)

TECHNICAL DATA		
Draco OPS series	482	490
Maximum Resolution	4096x2160 @ 30Hz	4096x2160 @ 60 Hz (4K DCI)
Color Depth	8 bit / True Color	10 bit / Deep Color
Audio	Stereo Linear Pulse Code Modulation (LPCM), 2-channel PCM	
		2-channel analog stereo audio
Power	+ 12-19V @ max. 8A (via JAE 80 - Pin)	
Link Interface	2x RJ45 or 2x LC Duplex (Single-mode)	
Output Interface (plug socket)	JAE 80 - Pin (TX25 Plug Connector)	
Service Interface	Mini-USB (F)	
USB	2x USB-HID Type A	2x USB-HID Type A
		USB 2.0 (embedded V2)
Maximum Cable Distance	Cat X 1G 140 m	Cat X 3G (XV) 100 m
	Single-mode 1G 10 km	Single-mode 3G (XV) 5 cm

Functional Diagram

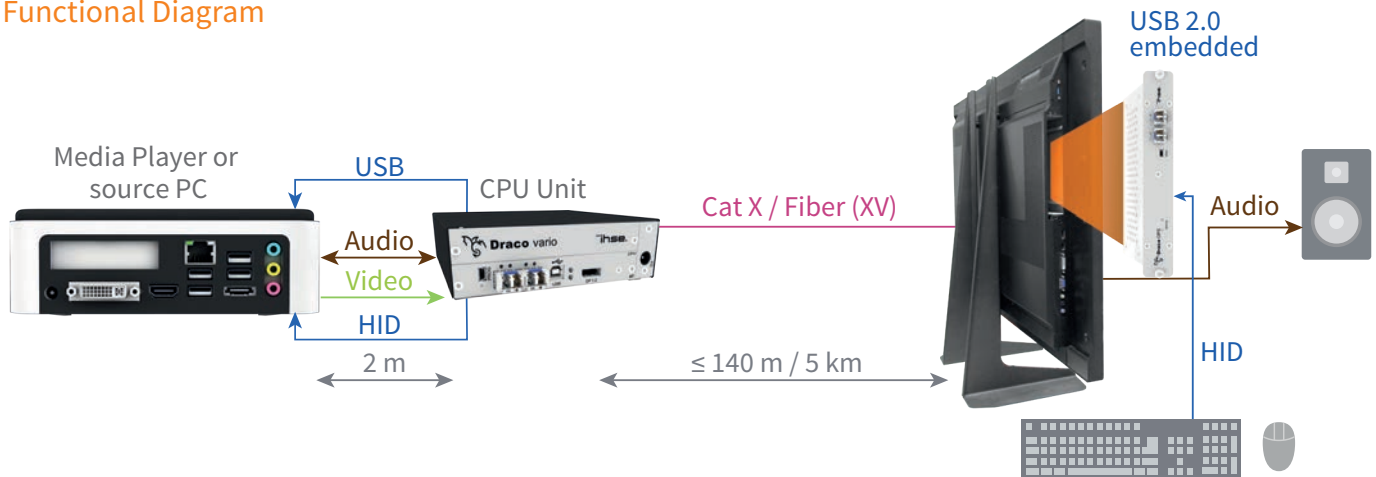

Source switching:
any source to any display

A KVM matrix switch enables simple connection of any source, of any signal type to any display; ensuring the right content is seen on every screen, whenever it is needed and wherever it is. Through a convenient user control interface or bespoke controller.

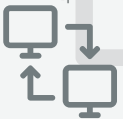

Reliability and
continuous operation

By centrally locating source computers, system maintenance and up-time is improved. Controlled switching and enhanced monitoring from a central point raises confidence in the operational integrity of the display network.



Security in Operation

KVM extenders greatly enhance security by restricting physical access and preventing electrical intrusion. With controlled access to computers and secured access rights, only authorized personnel can reach sensitive and critical source devices.



Order Numbers

DRACO OPS (2K60)	CON UNIT (LOCAL)	PART NO.
DRACO ULTRA OPS (4K60)	CON UNIT (LOCAL)	PART NO.

FULLY REDUNDANT KVM SYSTEM ARCHITECTURE

Redundancy in KVM extenders enable extender connections between computers and remote user workstations to continue over a secondary link, in case the primary link fails.

IHSE offers the most comprehensive range of redundant KVM systems. Extenders are available with redundancy at the source end (CPU), workstation end (CON) or both. In the case of an interconnection failure the redundant link ensures continuous and uninterrupted communication between the CON Unit and CPU Unit: transmission faults are automatically detected and indicated. Data flow is instantly switched to the secondary transmission link.

Fully redundant matrix operation

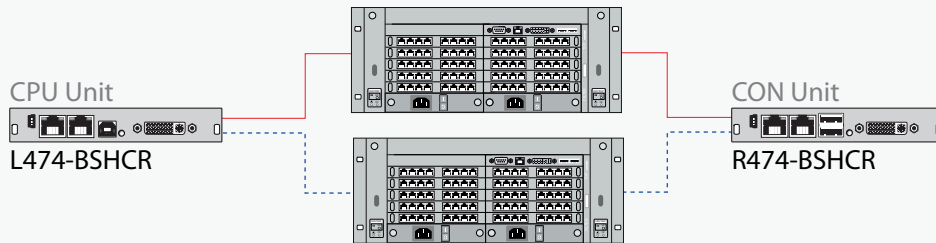

All user stations with redundant CON Units can still reach all redundant CPU Units even if one matrix fails.

Semi redundant matrix operation

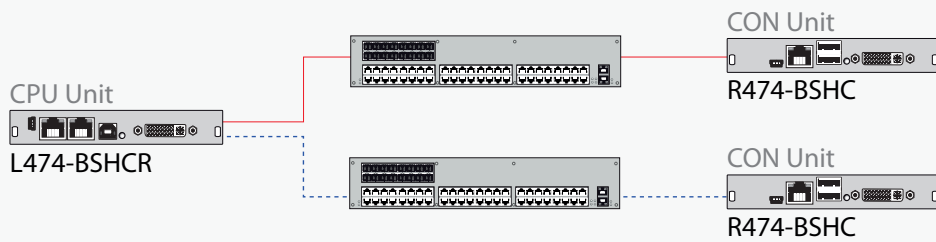

Half of the user stations can still reach all redundant CPU Units even if one matrix fails.

Fallback Scenario

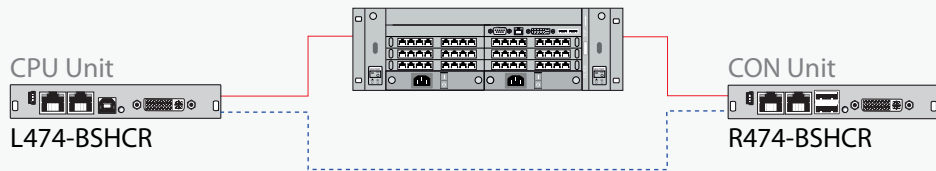

If the matrix fails, all user stations with redundant CON Units are automatically connected point-to-point to a CPU for an emergency setup.

Semi redundant single operation

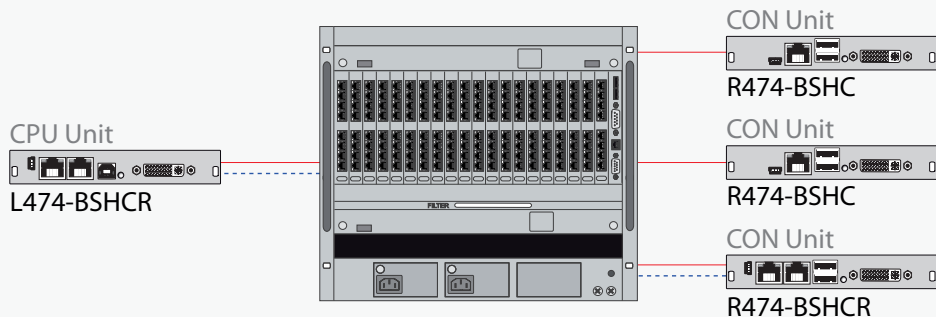

Both non-redundant and redundant CON Units can access redundant CPU Units. The redundant CON Units can still access the COU Units even in case losing the primary link.

Fully redundant point-to-point extender operation

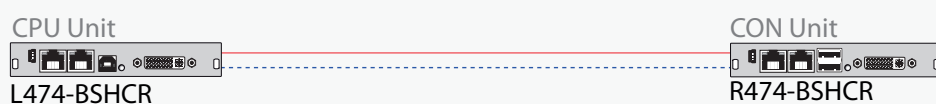

If one link is lost, the redundant link will ensure continuous access from CON Unit to CPU Unit.

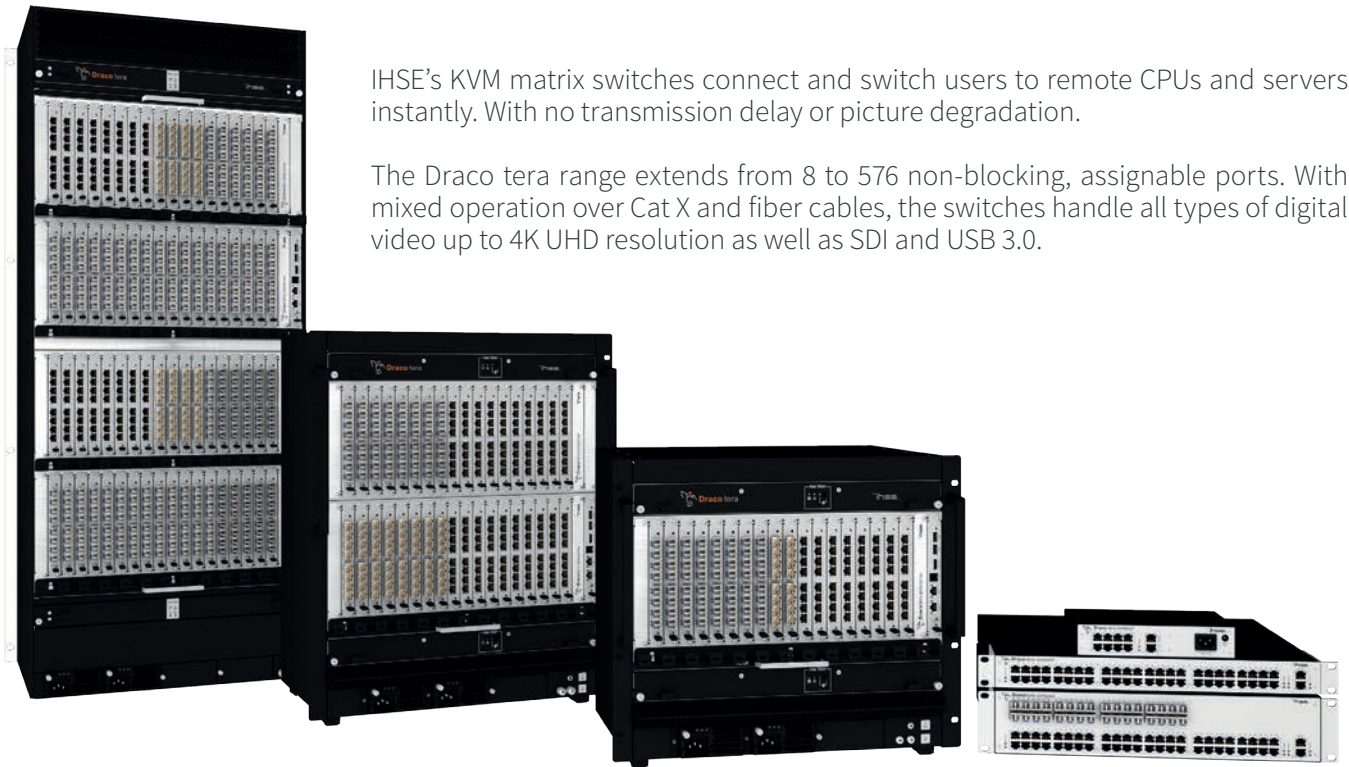

IHSE's KVM matrix switches connect and switch users to remote CPUs and servers instantly. With no transmission delay or picture degradation.

The Draco tera range extends from 8 to 576 non-blocking, assignable ports. With mixed operation over Cat X and fiber cables, the switches handle all types of digital video up to 4K UHD resolution as well as SDI and USB 3.0.

Draco tera KVM matrix switches are used throughout the world to provide uncorrupted access to critical control systems. Operators can instantly switch between sources to meet the demands of changing conditions, without loss of signal, allowing them to stay on top of any situation. At all times.

KVM MATRIX SWITCHES	SERIES	FROM PAGE	53
Features and Functions	480 / 480c		54
KVM Matrix Grid	480 / 480c		56
Draco tera enterprise	480		58
Draco tera compact	480c		62
Tera Viewer	480-VIEW		66
Draco CPU Switch	484		68
Draco U-Switch	476		70
Programmable Keyboard / Keypad	444		72
Draco TFT Admin Console	477		74



Instant Switching

The Draco tera offers Instant Switching between CPUs. In contrast to IP based solutions that have switching times of up to 10-15 seconds, the Draco tera switches within milliseconds.



Flex-Port Technology

Flex-Port technology offers a totally flexible configuration of all ports. Each port can be used as either a CPU port (connection to a computer) or as a CON port (connection to a console) and it can be switched according to the requirements.

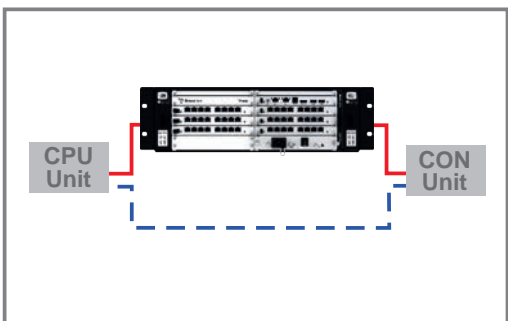

System redundancy

IHSE offers an exceptional fully-redundant KVM system architecture, including redundant interconnections from the CPU (source end) to the matrix switch to the redundant CON Unit (workstation end). In the case of an interconnection failure the redundant link ensures continuous and uninterrupted communication between the CON Unit and CPU Unit: transmission faults are automatically detected and indicated. Data flow is instantly switched to the secondary transmission link.

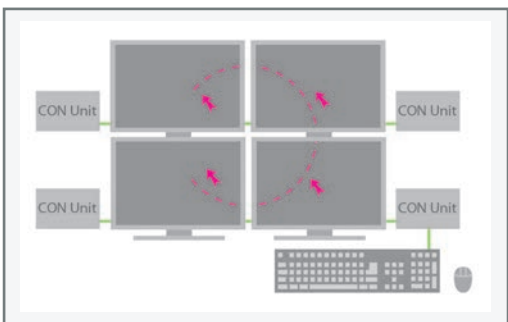

Multi-Screen control

Multi-screen control allows several computers and monitors to be controlled using a single keyboard and mouse. Computers with multi-head outputs can also be included. A new upgrade enables the simultaneous operation of up to eight screens/sources via two keyboard and mouse sets. This allows for two users to work simultaneously on a multi-monitor workspace and access all connected sources.

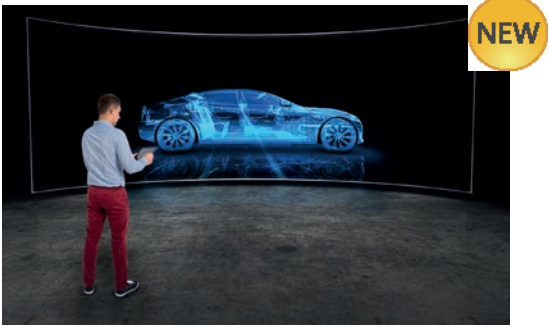

Infinite resolutions for life-size projection (4K, 5K, 8K)
Create virtual representations in life-size. Brilliant image quality in infinite resolutions (8K60 and beyond) and Deep Color (10 bit) with 4:4:4 sampling.

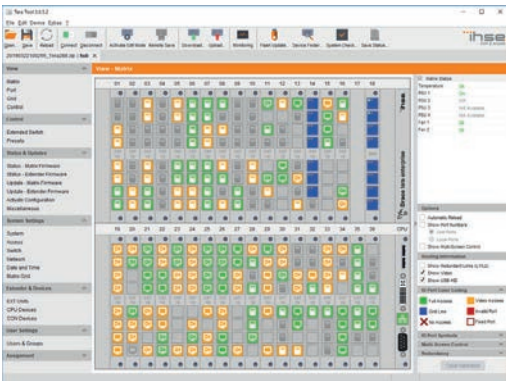

Comprehensive Control Features
An OSD (On Screen Display), accessible via simple keyboard commands, can be viewed directly from any workstation console. The Draco Tera tool is a powerful Java-based software for configuration, control, update and maintenance of a complete Draco Tera system. It can be used for system analysis and system status reporting. The Draco Tera can also be controlled via an external media controller, such as VSM, KSC or AMX control interface.

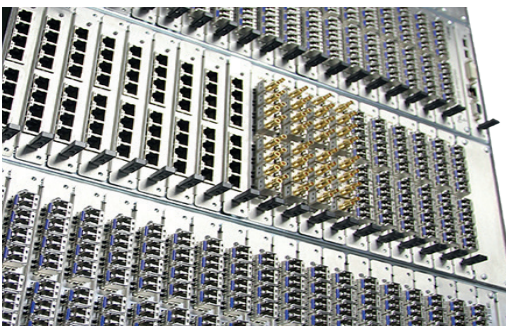

Mix & Match technology
The Draco Tera's Mix & Match technology allows switching between Cat X and fiber optic ports. This enables the free combination of Cat X and fiber optic devices – offering proper signal transmission at any time. In addition, the universal I/O module supports SDI with fiber or coax and USB 3.0 with fiber.



Full line of modular extenders
Draco Tera extenders combine multiple video encoding technologies, to deliver the very best picture quality, while a pixel mapping ratio of 1:1 ensures authentic display of the source video. In addition, USB-HID, High Speed USB 2.0, analog or digital audio and serial data signals can be extended to distances up to 10 km. Computer resolutions up to 1920x1200@60Hz, 4096x2160 for 4K/UHD + DCI and video resolutions for SD/HD/3G-SDI up to 1080p60 are supported.

MATRIX GRID PORT EXPANSION

Matrix Grid allows up to 24 individual matrix switches to be managed under a single control management system. Matrix Grid is an interconnection method and firmware application that transparently connects multiple matrices together to form a single super matrix. It automatically and seamlessly manages the interconnections between CONs and CPUs across multiple locations.

Connecting Draco tera KVM Matrices

- Matrix Grid consisting of up to 24 matrices in one LAN including one grid master matrix
- Interconnection management by grid master, local switching remains within each matrix
- One grid line per KVM connection
- Single distributed grid configuration (contains all CPUs, CONs, Users, etc.)
- Bidirectional grid lines (Smart Connect) support video sharing for superior efficiency

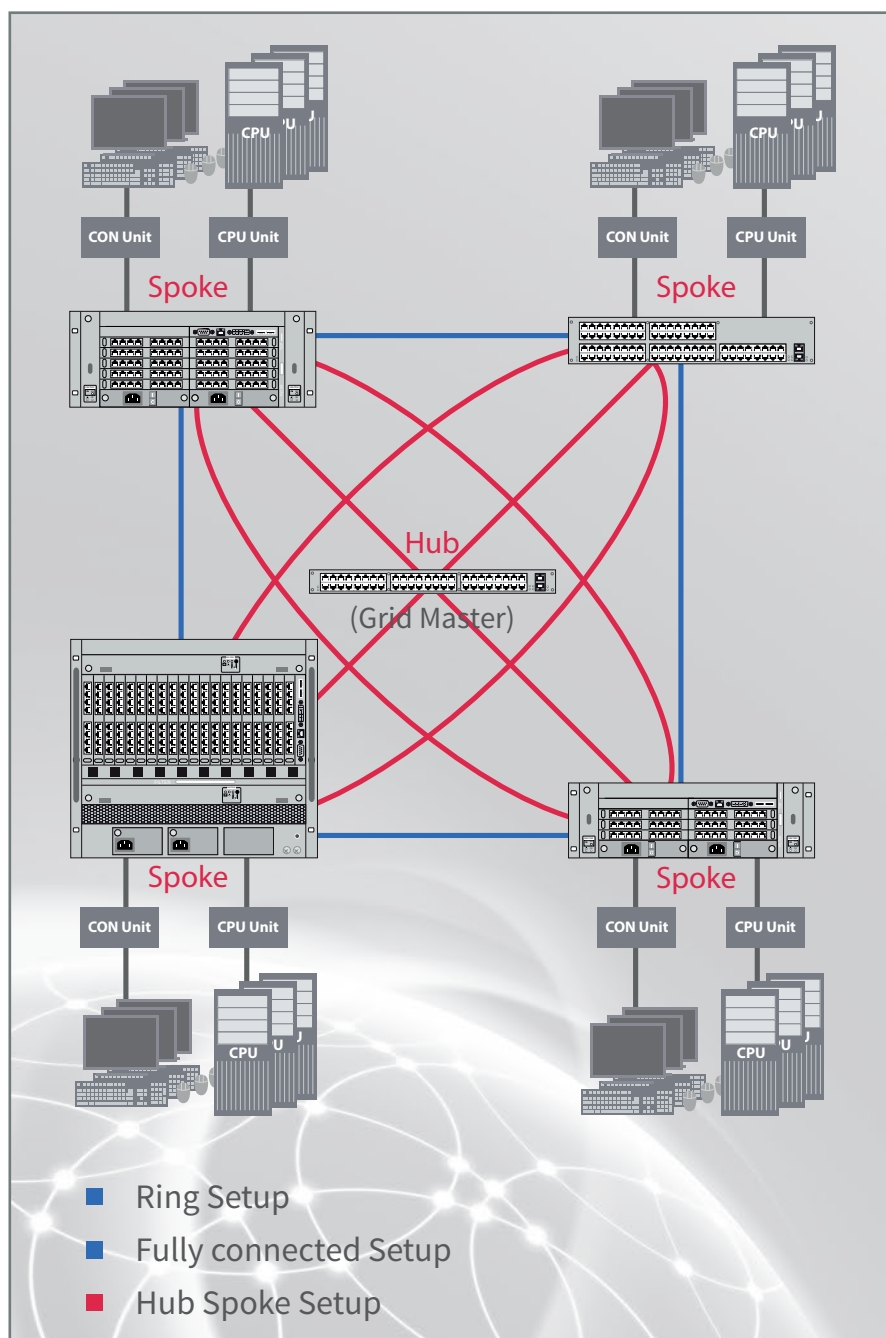

FUNCTIONAL DIAGRAMS OF SELECTED INSTALLATIONS

KVM IN BROADCAST

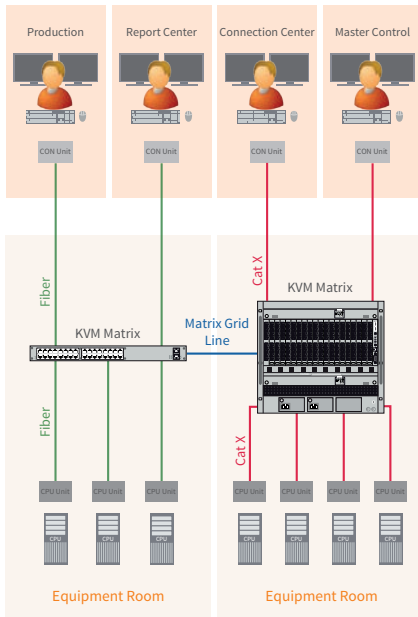

In operation at Chukyo TV
(national Japanese broadcaster)

KVM IN POST PRODUCTION

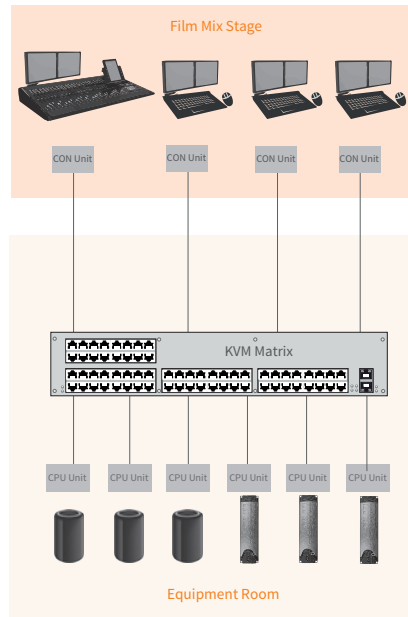

Abbey Road Studio's Dolby Atmos
Mix Stage; London

KVM IN CONTROL CENTERS

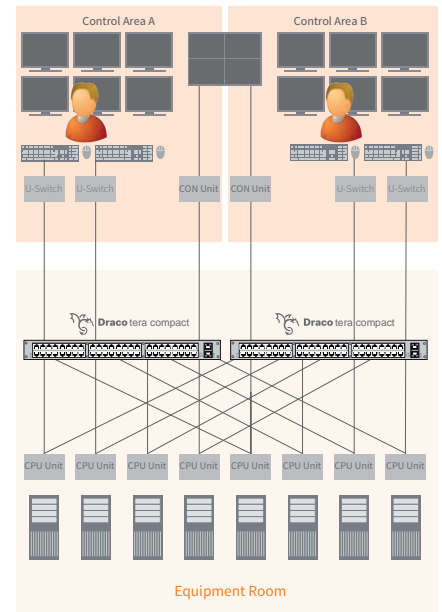

Eiffage Energie's high-speed rail
link maintenance, France

KVM IN RESEARCH VESSELS

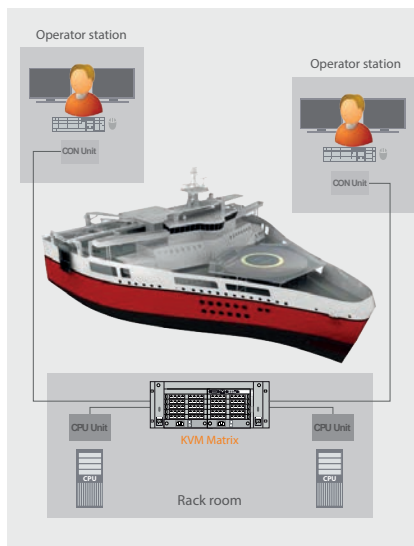

In operation at Petroleum
Geo-Services (PGS), Norway

KVM IN MARITIME CONTROL

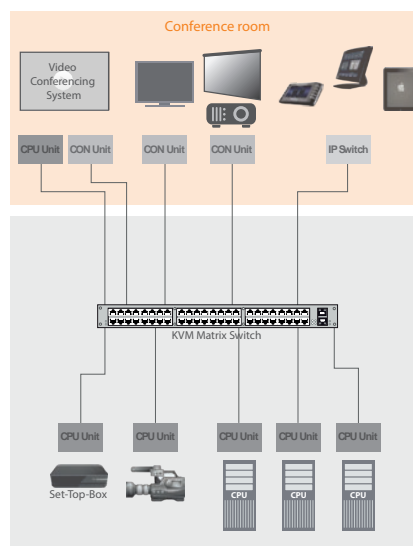

In operation at Haifa RCC, Israel

KVM IN AIR TRAFFIC CONTROL

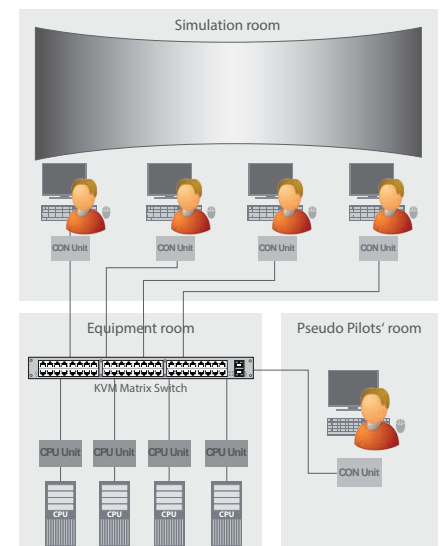

In operation at Frankfurt Airport



Read more at ihse.com/casestudies



- 48, 80, 152, 160, 288 or 576 ports
- Instant switching
- Mix & Match (Cat X & fiber)
- Matrix Grid (interconnection of matrices)
- Modular architecture

- DVI
- Dual Link DVI
- HDMI
- DisplayPort
- VGA
- SDI
- USB-HID
- USB 2.0 / 3.1
- Digital audio
- Analog audio
- Balanced audio
- RS232
- RS422

Product Information

The Draco tera enterprise is the perfect high performance, modular enterprise routing system for complete in-band signal distribution of high definition video, audio, and data over Cat X, multi-mode or single-mode fiber optic cable supporting up to 576 I/O ports in a single frame. Designed with performance and flexibility in mind, Draco tera enterprise offers tremendous scalability with cost effective features.

Each port can be user configured as an input or an output scalable from one CPU to multiple workstations or with multiple CPUs managed by a single workstation console. For mission-critical installations Draco tera matrix switches are ideal. The multi-level redundancy concept of the Draco tera enterprise offers the highest level of reliability for 24/7 operation. Each Draco tera enterprise chassis supports fully

redundant power and hot swappable modules for full service and field upgrades without interrupting signal flow. Furthermore, the devices of the enterprise series are compatible with Draco compact, vario and ultra extenders. The controller board (480-CTRL2) features additional redundant network connectivity including auto failover for Draco tera enterprise 48, 80, 152 (equivalent to 160) and 288 KVM switches.

Product Features

- Scalable and flexible architecture
- Critical components hotswappable
- Instant switching
- Latency-free video transmission
- Flex-Port technology for dynamic port assignment
- Mix & Match (fiber ports can be switched to Cat-X ports and vice versa)
- Matrix Grid option allows multi-matrix connections through Grid lines
- Multi-signal support: KVM, USB 2.0/3.0, SDI (SD/HD/3G)
- Remote extenders can be updated through the matrix
- API Service for connection with media controls
- Multi-Screen Control (new firmware up to 8 ports)
- LDAP user management
- SNMP & Syslog monitoring
- Redundant power supply
- Support of full or partial matrix redundancy
- Redundant controller board option for Draco tera enterprise 48, 80, 152 (equivalent to 160) and 288

Operation via

- Keyboard for operation (in-band)
- OSD (On Screen Display) for configuration and operation (in-band)
- Draco tera tool for configuration, operation and maintenance (TCP/IP)
- TCP/IP interface for operation (API)
- Serial interface for operation (API)

TECHNICAL DATA											
Input Interface	Cat X or fiber (any combination)										
Output Interface	Cat X or fiber (any combination)										
Distance per connection (max.)	<table border="1"> <tr> <td>Cat X (1G)</td> <td>140 m</td> </tr> <tr> <td>Cat X XV (3G)</td> <td>100 m</td> </tr> <tr> <td>Multi-Mode (6G)</td> <td>1,000 m</td> </tr> <tr> <td>Single-Mode (9µ) (3G)</td> <td>10,000 m (up to 160 km with special SFP's)</td> </tr> <tr> <td>Coaxial (3G)</td> <td>100 m (RG 59 B/U)</td> </tr> </table>	Cat X (1G)	140 m	Cat X XV (3G)	100 m	Multi-Mode (6G)	1,000 m	Single-Mode (9µ) (3G)	10,000 m (up to 160 km with special SFP's)	Coaxial (3G)	100 m (RG 59 B/U)
Cat X (1G)	140 m										
Cat X XV (3G)	100 m										
Multi-Mode (6G)	1,000 m										
Single-Mode (9µ) (3G)	10,000 m (up to 160 km with special SFP's)										
Coaxial (3G)	100 m (RG 59 B/U)										
Optional Interfaces	DVI-D, DVI-I (VGA), HDMI, DisplayPort 1.1 (30 Hz) and 1.2 (60 Hz), USB-HID, USB 2.0, USB 3.0, SDI, analog audio, digital audio and RS232 / RS422 options, PS/2 (interfaces depend on the used CPU/CON unit)										
Control	OSD (On Screen Display) on each console, Draco tera Tool, API										

CHASSIS DATA					
Ports	48 ports (3 RU)	80 ports (4 RU)	152/160 ports (9 RU)	288 ports (13 RU)	576 ports (25 RU)
Power Supply (max./per unit)	5 A, 100-240 VAC, 50/60 Hz	5 A, 100-240 VAC, 50/60 Hz	9 A, 100-240 VAC, 50/60 Hz	12 A, 100-240 VAC, 50/60 Hz	20 A, 100-240 VAC, 50/60 Hz
Number of Power Supplies	1 (+ 1 redundant possible)	1 (+ 1 redundant possible)	2 (+ 1 redundant possible)	2 (+ 1 redundant possible)	2 (+ 2 redundant possible)
Dimensions	483 x 133 x 230 mm (19.0 x 5.3 x 9.1 inch)	483 x 178 x 230 mm (19.0 x 7.0 x 9.1 inch)	483 x 400 x 330 mm (19.0 x 15.8 x 12.0 inch)	483 x 578 x 330 mm (19.0 x 22.8 x 12.0 inch)	483 x 1108 x 435 mm (19.0 x 43.6 x 17.1 inch)

Draco tera I/O card options

The Draco tera enterprise matrix switch can accommodate a wide range of signal formats. I/O cards can be mixed in the same frame allowing maximum flexibility for any switch and routing application.





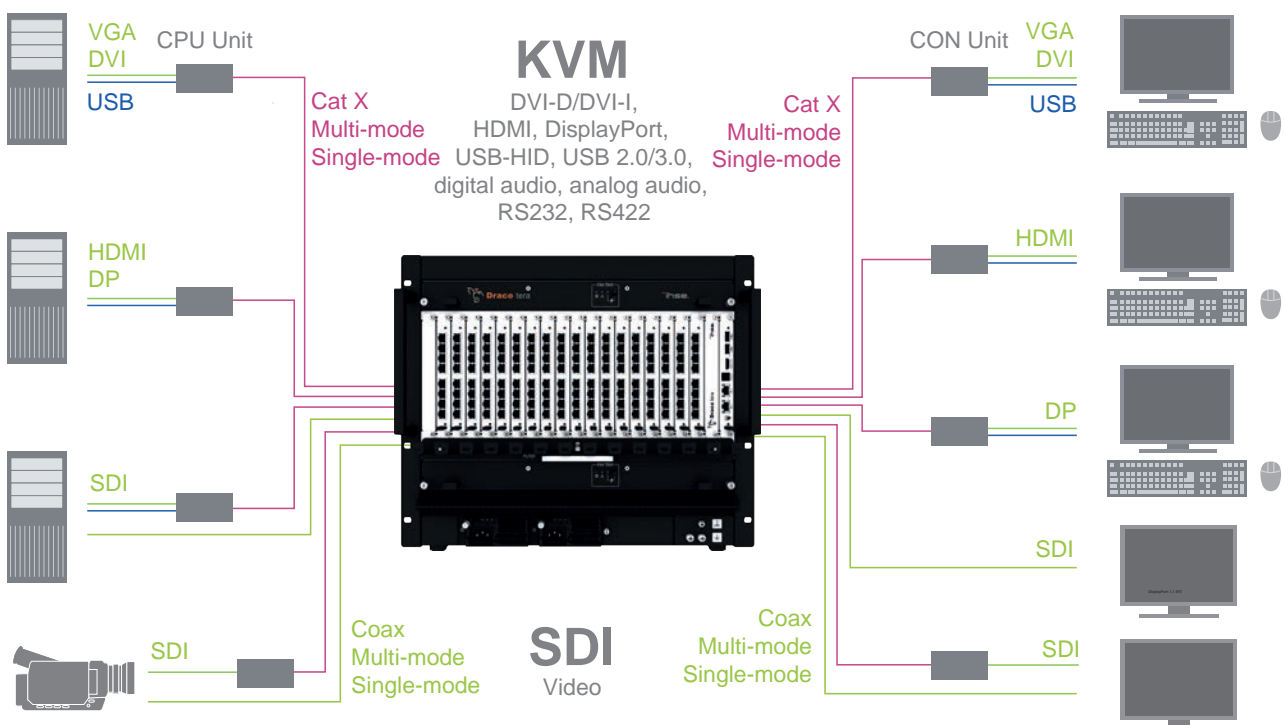











Functional Diagram



Order Numbers

DEVICES	PART NO.
Draco tera enterprise with 48 ports (base unit with controller module and 1x power supply unit), 3 RU, free configuration	K480-048-R1
Draco tera enterprise with 80 ports (base unit with controller module and 1x power supply unit), 4 RU, free configuration	K480-080-R1
Draco tera enterprise with 152 ports (base unit with controller module and redundant option, 2x power supply units), 9 RU, free configuration. Secondary controller module for redundancy/auto failover as an option.	 K480-152-R1
Draco tera enterprise with 160 ports (base unit with controller module and 2x power supply units), 9 RU, free configuration	K480-160-R1
Draco tera enterprise with 288 ports (base unit with controller module and 2x power supply units), 13 RU, free configuration	K480-288-R1
Draco tera enterprise with 576 ports (base unit with 2x controller modules and 2x power supply units), 25 RU, free configuration	K480-576-R1
Draco tera enterprise with 576 ports symmetric (base unit 2 x 288 ports (288 inputs / 288 outputs) with 2x controller modules and 2x power supply units), 25 RU, free configuration	K480-576S-R1

 The Draco tera base unit includes at least one CPU module, fan trays, an exchangeable filter pad and one or two power supply units depending on the model. Choose I/O modules and other accessories according to your requirements.

I/O MODULES AND SFPS	DATA TRANSMISSION	PART NO.
Draco tera enterprise Cat X I/O module (8 ports), Multi-Screen with 8 monitors		480-C8-R1
Draco tera enterprise Cat X I/O module (8 Ports), Cat X (1G) with 3G matrix PCB communication		480-C8BDG
Draco tera enterprise Cat X I/O module (8 ports), Cat XXV (3G)		480-C8X
Draco tera enterprise fiber, I/O module (8 ports) incl. 8 x 459-1S, Multi-Screen with 8 monitors		480-S8-R1
Draco tera enterprise fiber, I/O module (8 ports) fiber (1G) with 3G matrix PCB communication		480-S8BDG
Draco tera enterprise fiber, I/O module (8 ports) incl. 8 x 459-1S (3G)		480-S8X
➤ SFP, single-mode, LC duplex, bidirectional, 1G, MSA		459-1S
➤ SFP single-mode, LC duplex, bidirectional, 3G XV, MSA		459-1V
Draco tera enterprise universal I/O module (8 ports) for USB 3.0 and SDI, empty, free configuration		480-UNI16
➤ SFP multi-mode, LC duplex, bidirectional, for USB 3.0, 6G, MSA		459-6M
➤ SFP single-mode, LC duplex, bidirectional, 3G-SDI, MSA		459-3FX
➤ SFP SDI, 3G/HD/SD video, Micro-BNC to BNC, MSA		459-3BX
➤ Adapter cable coax, Micro-BNC to BNC (suitable for 459-3BX)		459-BMB
Draco tera enterprise Grid, 8 to 1 port I/O module, fiber (up to 1.4 km, 10 km upon request), 10G, incl. 1x 459-10S10		480-GRD-S8-R1
➤ SFP single-mode, LC duplex, bidirectional, 10G, MSA, 10 km		459-10S10

ACCESSORIES	PART NO.
Draco tera enterprise controller module incl. Dual TCP/IP, HDMI, USB-HID, RS232 and Genlock	480-CTRL2
Fan tray for Draco tera enterprise with 48 ports (spare part)	480-FAN-048
Fan tray for Draco tera enterprise with 80 ports (spare part)	480-FAN-080
Fan tray for Draco tera enterprise with 160 ports (spare part)	480-FAN-160
Fan tray for Draco tera enterprise with 288 ports (spare part)	480-FAN-288
Fan tray for Draco tera enterprise with 576 ports (spare part)	480-FAN-576
Filter pads as consumable supply for Draco tera enterprise with 48 ports (spare part)	480-FLTR-048
Filter pads as consumable supply for Draco tera enterprise with 80 ports (spare part)	480-FLTR-080
Filter pads as consumable supply for Draco tera enterprise with 160 ports (spare part)	480-FLTR-160
Filter pads as consumable supply for Draco tera enterprise with 288 ports (spare part)	480-FLTR-288
Filter pads as consumable supply for Draco tera enterprise with 576 ports (spare part)	480-FLTR-576
Plug-in power supply unit for Draco tera enterprise with 48 ports (spare part or redundancy)	480-RED-048
Plug-in power supply unit for Draco tera enterprise with 80 ports (spare part or redundancy)	480-RED-080
Plug-in power supply unit for Draco tera enterprise with 160 ports (spare part or redundancy)	480-RED-160
Plug-in power supply unit for Draco tera enterprise with 288 ports (spare part or redundancy)	480-RED-288
Plug-in power supply unit for Draco tera enterprise with 576 ports (spare part or redundancy)	480-RED-576



SFP modules (small form-factor pluggable) are compact, hot-pluggable connection plugs, serving as optical (fiber) and electronic (coax) transceivers for rapid signal transmission. Depending on the specification of the implemented SFP, IHSE devices allow signal extension up to 160 km over single-mode fiber cables. Standard fiber SFPs have a maximum extension of 10 km. Draco tera enterprise KVM matrix switches and Draco tera compact fiber and UNI versions can be individually customized with the appropriate SFP modules according to the application and distance required.



All digital KVM extenders of the Draco vario and Draco compact series are designed to operate with the Draco tera enterprise KVM matrix switches or as individual CON/CPU extenders. Contact our expert team of consultants who will be happy to assist you with any configuration or technical questions.



- 8, 16, 32, 48, 64 or 80 Ports
- Compact size with 19" / 1 RU / 2 RU
- Instant switching
- Flex-Port technology
- Up to 6G bandwidth

- DVI
- Dual Link DVI
- HDMI
- DisplayPort
- VGA
- SDI
- USB-HID
- USB 2.0 / 3.1
- Digital audio
- Analog audio
- Balanced audio
- RS232
- RS422

Product Information

The Draco tera compact switch with its form factor of max. two 19" rack units is specifically designed for smaller and mid-sized KVM requirements using the same technology found in the larger Draco tera enterprise matrix systems. Based on a small footprint package, the cost-effective frame can be used with all of the Draco extender modules creating the world's widest selection of KVM solutions. It is a simple operation to set up and configure the matrix with the On-Screen Display (OSD) or through the feature-enhanced Draco tera

Tool. Extenders can accommodate a variety of signal formats and the Draco tera compact auto-senses the individual units through any available port on the chassis. By simply connecting the extender to the chassis, the internal firmware will recognize and auto-configure the port as a CPU or console device. This Flex-Port technology provides a huge time saving for system installers who normally have to pre-configure ports to specific I/O requirements. The system includes instant switching technology for all the popular formats up to 4K resolutions at 60 Hz and 10

bit color depth (4:4:4). With incredible speed, switching between sources is glitch-free and instantaneous thus reducing eye strain and annoying video tearing found with other systems. With the small footprint and ruggedized chassis design, the Draco tera compact is the perfect KVM space-saving solution where centralized switching of KVM is necessary. It is especially suited for factory floor automation control systems, production studios, OB Vans, and command and control environments.

Product Features

- Compact size 1 RU or 2 RU
- Port connections for Cat X, fiber, coaxial
- Instant switching
- Latency-free video transmission
- Flex-Port technology for dynamic port assignment
- Mix & Match (fiber ports can be switched to Cat X ports and vice versa)
- Matrix Grid option allows multi-matrix connections through Grid lines
- Java based tera tool for configuration, operation and maintenance
- Multi signal support: KVM, USB 2.0/3.0, SDI (SD/HD/3G)
- Remote extenders can be updated through the matrix
- API Service for connection with media controllers
- Multi-Screen Control (new firmware up to 8 ports)
- LDAP user management
- SNMP & Syslog monitoring
- Redundant power supply
- Support of fully or partly matrix redundancy

Operation via

- Keyboard for operation (in-band)
- OSD (On Screen Display) for configuration and operation (in-band)
- Draco tera tool for configuration, operation and maintenance (TCP/IP)
- TCP/IP- interface for operation (API)
- Serial interface for operation (API)

TECHNICAL DATA	KVM				Universal (KVM / SDI)	
Input / Output	Cat X	Cat XXV	Fiber	Fiber XV	Multi-mode Fiber	Coax
Distance	140 m	100 m	10 km	5 km	100 m	
Bandwidth	1G	3G	1G	3G	6G	
Supported Signals	DisplayPort, HDMI, DVI-D, DVI-I, USB 2.0, USB-HID, RS232, RS422, analog / digital or balanced audio				USB 3.1	SDI

CHASSIS DATA			
Ports	8 ports (1 RU)	16, 32 and 48 ports (1 RU)	64 and 80 ports (2 RU)
Power Supply (max./per unit)	0.7 A, 100-240 VAC, 50/60 Hz	1.4 A, 100-240 VAC, 50/60 Hz	2.3 A, 100-240 VAC, 50/60 Hz
Number of Power Supplies	1	2	2
Dimensions	220 x 146 x 45 mm (8.7 x 5.7 x 1.8 inch)	443 x 435 x 45 mm (17.4 x 17.1 x 1.8 inch)	443 x 435 x 90 mm (17.4 x 17.1 x 3.5 inch)





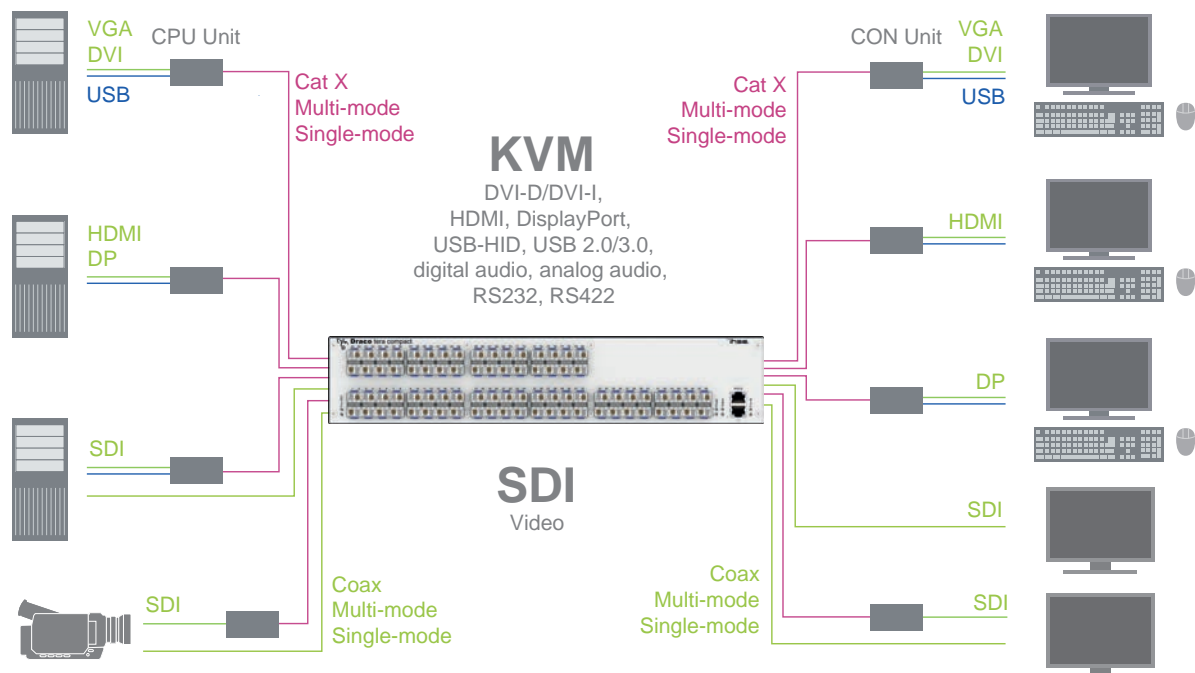

Sized for all applications

















Functional Diagram







Order Numbers

CAT X DEVICE MODELS	DATA TRANSMISSION	PART NO.
Draco tera compact 8 ports, Cat X (module version for mounting in Draco vario chassis)		B480-08C
Draco tera compact 8 ports, Cat X (chassis version with integrated power supply)		K480-08C
Draco tera compact 16 ports, Cat X		K480-16C
Draco tera compact 32 ports, Cat X		K480-32C
Draco tera compact 48 ports, Cat X		K480-48C
Draco tera compact 64 ports, Cat X		K480-64C
Draco tera compact 80 ports, Cat X		K480-80C

FIBER DEVICE MODELS	DATA TRANSMISSION	PART NO.
Draco tera compact 8 ports, fiber (module version for mounting in Draco vario chassis), (incl. 8 x SFPs, single-mode, 459-1S)		B480-08F
Draco tera compact 8 ports, fiber (chassis version with integrated power supply), (incl. 8 x SFPs, single-mode, 459-1S)		K480-08F
Draco tera compact 16 ports, fiber (incl. 16 x SFPs, single-mode, 459-1S)		K480-16F
Draco tera compact 32 ports, fiber (incl. 32 x SFPs, single-mode, 459-1S)		K480-32F
Draco tera compact 48 ports, fiber (incl. 48 x SFPs, single-mode, 459-1S)		K480-48F
Draco tera compact 64 ports, fiber (incl. 64 x SFPs, single-mode, 459-1S)		K480-64F
Draco tera compact 80 ports, fiber (incl. 80 x SFPs, single-mode, 459-1S)		K480-80F

FIBER XV DEVICE MODELS	DATA TRANSMISSION	PART NO.
Draco tera compact 8 ports, fiber XV (module version for mounting in Draco vario chassis), (incl. 8 x SFPs, single-mode XV, 459-1V)		B480-08X
Draco tera compact 8 ports, fiber XV (chassis version with integrated power supply), (incl. 8 x SFPs, single-mode XV, 459-1V)		K480-08X
Draco tera compact 16 ports, fiber XV (incl. 16 x SFPs, single-mode XV, 459-1V)		K480-16X
Draco tera compact 32 ports, fiber XV (incl. 32 x SFPs, single-mode XV, 459-1V)		K480-32X
Draco tera compact 48 ports, fiber XV (incl. 48 x SFPs, single-mode XV, 459-1V)		K480-48X
Draco tera compact 64 ports, fiber XV (incl. 64 x SFPs, single-mode XV, 459-1V)		K480-64X
Draco tera compact 80 ports, fiber XV (incl. 80 x SFPs, single-mode XV, 459-1V)		K480-80X

UNIVERSAL DEVICE MODELS	DATA TRANSMISSION	PART NO.
Draco tera compact 8 ports, universal (module version for mounting in Draco vario chassis)		B480-08U
Draco tera compact 8 ports, universal (chassis version with integrated power supply)		K480-08U
Draco tera compact 16 ports, universal		K480-16U
Draco tera compact 32 ports, universal		K480-32U
Draco tera compact 48 ports, universal		K480-48U

DRACO TERA COMPACT HYBRID VERSIONS

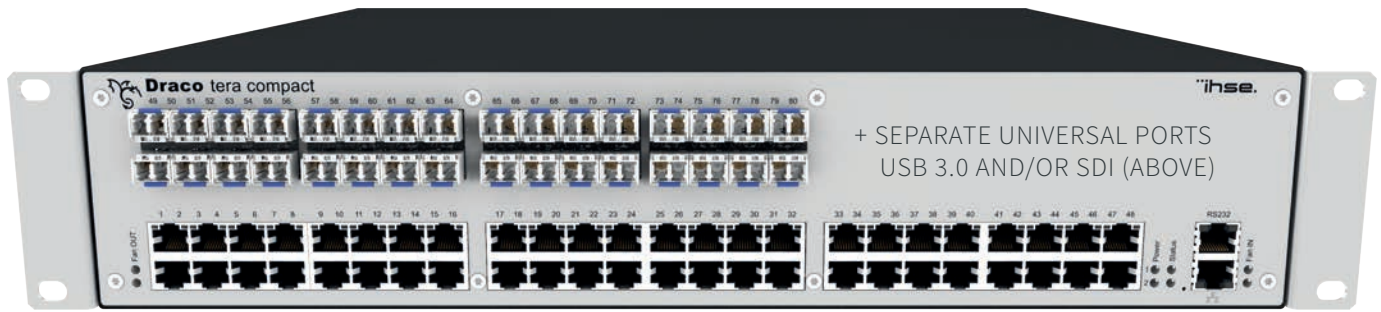

48 KVM PORTS (BELOW)

HYBRID DEVICE MODELS	DATA TRANSMISSION	PART NO.
Draco tera compact 64 ports (48 Cat X, 16 fiber), (incl. 16 x SFPs, single-mode, 459-1S)		K480-48C16F
Draco tera compact 80 ports (48 Cat X, 32 fiber), (incl. 32 x SFPs, single-mode XV, 459-1S)		K480-48C32F
Draco tera compact 64 ports (48 Cat X, 16 fiber XV), (incl. 16 x SFPs, single-mode XV, 459-1V)		K480-48C16X
Draco tera compact 80 ports (48 Cat X, 32 fiber XV), (incl. 32 x SFPs, single-mode, 459-1V)		K480-48C32X
Draco tera compact 64 ports (48 Cat X, 16 universal)		K480-48C16U
Draco tera compact 80 ports (48 Cat X, 32 universal)		K480-48C32U
Draco tera compact 64 ports (48 fiber, 16 universal), (incl. 48 x SFPs, single-mode, 459-1S)		K480-48F16U
Draco tera compact 80 ports (48 fiber, 32 universal), (incl. 48 x SFPs, single-mode, 459-1S)		K480-48F32U

ACCESSORIES	DATA TRANSMISSION	PART NO.
SFP, single-mode, LC duplex, bidirectional, 1G, MSA		459-1S
SFP single-mode, LC duplex, bidirectional, 3G XV, MSA		459-1V
SFP multi-mode, LC duplex, bidirectional, for USB 3.0, 6G, MSA		459-6M
SFP single-mode, LC duplex, bidirectional, 3G-SDI, MSA		459-3FX
SFP SDI, 3G/HD/SD video, Micro-BNC to BNC, non-MSA		459-3BX
➤ Adapter cable coax, Micro-BNC to BNC (suitable for 459-3BX)		459-BMB



All digital KVM extenders of the Draco vario, Draco vario ultra and Draco compact series are designed to operate with the Draco tera compact KVM matrix switches or as individual CON/CPU extenders. Contact our expert team of consultants who will be happy to assist you with any configuration or technical questions.



- Monitoring & extended switching via IP
- Double signal transmission per device
- Screen layout individually configurable
- Live thumbnail
- Switching via drag and drop
- Resolutions up to max. 1080p

Product Information

Tera Viewer software

The Tera Viewer software provides IP-based preview of video signals passing through Draco tera KVM matrix systems. It is a convenient method of checking and monitoring images, as often required in control and monitoring applications. Live image previews are presented on a separate screen layout which can be configured through the Tera Viewer software as required. Switching of data paths in the KVM switch can also be achieved by means of a drag-and-drop feature of the Tera Viewer software package.

Transmission via IP encoder

Video previews are generated by an efficient Teracue H.264 IP encoder. The encoder is directly connected to dedicated ports on the KVM matrix switch through individual CON Units (481 Series) and follow the input and output video.

Protection against unauthorized access

To ensure maximum security and prevent unauthorised access to data streams and switching functionality, the Tera Viewer includes an unidirectional connection.

Simple use from everywhere

Live monitoring and switching are available to system administrators wherever a high-performance IP connection is available; independent of physical location and proximity to the Draco tera KVM matrix switch itself.

System requirements

For a specifically use of the Tera Viewer package, two Draco vario HDMI CON Units (for connecting the IP encoder) are required. For the Tera Viewer, a PC with Intel Core i5 processor, or better, is recommended.

Product Features

- The video signal is converted into IP by the encoder
- The system allows free arrangement of monitors and selection of computers
- Images displayed on the monitors on the Tera Viewer screen are automatically updated
- Layouts can be saved on the Tera Viewer. A default layout can also be saved on the matrix and will be loaded automatically when opening. Any number of other layouts can be saved locally
- Extended switching can be operated using a touch screen input (e.g. tablet). The operating system must support Java
- Fields of application are mainly control and monitoring scenarios for maintenance and support

TECHNICAL DATA	
Power Supply (internal)	12 VDC
Power consumption	< 5 W per device
Manufacturer IP encoder hardware	Teracue
Input	HDMI (2x)
Output	10/100/1000 TX Ethernet, RJ45
Video codec	H.264
Control	Tera Viewer software
System Requirements Tera Viewer software	Windows 7, Windows 8, Windows 8.1, Windows 10 OS X 10.7 (Lion) and higher Java 1.7, Update 76, www.java.com 1 GB RAM+ Intel Core i5 processor recommended
Dimensions	30 x 105 x 170 mm (1.1 x 4.1 x 6.7 inch)

Functional Diagram

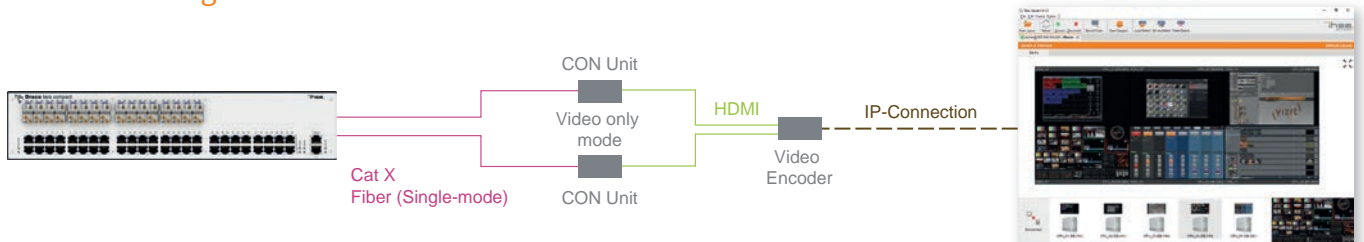

DOWNLOAD TERA VIEWER SOFTWARE
www.ihse.de/download/software.html

PRODUCT	PART NO.
Teracue H.264 IP-Encoder (IHSE version) Tera Viewer software	480-VIEW (package)

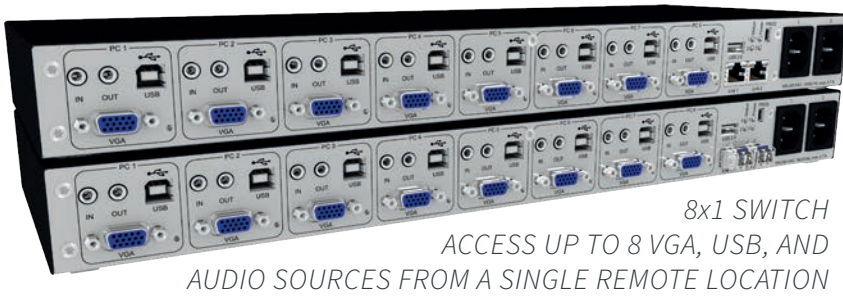

- Replaces 8 CPU extender units
- VGA/DVI-D conversion
- Version with redundant data links
- Optimized for the use in data centers

Product Information

The Draco CPU switch allows switching between eight VGA computers together with the respective audio and USB signals. The Draco CPU switch replaces eight traditional KVM extenders: Eight computers are connected by VGA cables to the CPU Unit which is further connected to a user workstation by one interconnect cable. The operator can access any of the eight connected sources from

the console. The extender operates as an 8-input, 1-output KVM switch and includes front-panel LEDs to indicate the active computer. Analog VGA signals are converted to DVI-D within the extender and scaled using Draco vario image scaling which is ideal for modern, high-resolution monitors. In addition, the Draco CPU switch comprises eight USB-HID/USB 2.0 embedded (36 Mbit/s) ports, as well as eight bidirectional analog

audio ports. A further USB 2.0 port (480 Mbit/s) on the extender allows storage devices to be connected locally. An attached USB device is logged into the active computer making it possible to transmit data (e.g. important system updates) from a single USB device to all computers under control of the workstation.

Product Features

- Includes 8 input ports for VGA, USB and audio
- Output connections to DVI extender or matrix switch port
- Integrated scaler
- Redundant power supply
- Rack mountable in 1 RU
- Switching via hot key commands
- Local USB port selectable to any input source
- Perfect for efficient management of legacy VGA sources
- Ideal for centralized management of host computers integrated to digital KVM matrix systems

TECHNICAL DATA	
Power Supply (internal)	90-240 VAC / 0.7 A / 50/60 Hz
Input	8x VGA, USB-HID, analog audio, 8x USB 2.0 embedded, local USB 2.0 (high speed)
Output	Cat X, single-mode fiber
Maximum Resolutions	1920 x 1200 @ 60 Hz
Color Depth	8 bit / True Color
Maximum Cable Distance	Cat X 140 m Single-mode 9µ 10 km
Dimensions	444 x 143 x 43 mm (17.5 x 5.6 x 1.7 inch)

Functional Diagram

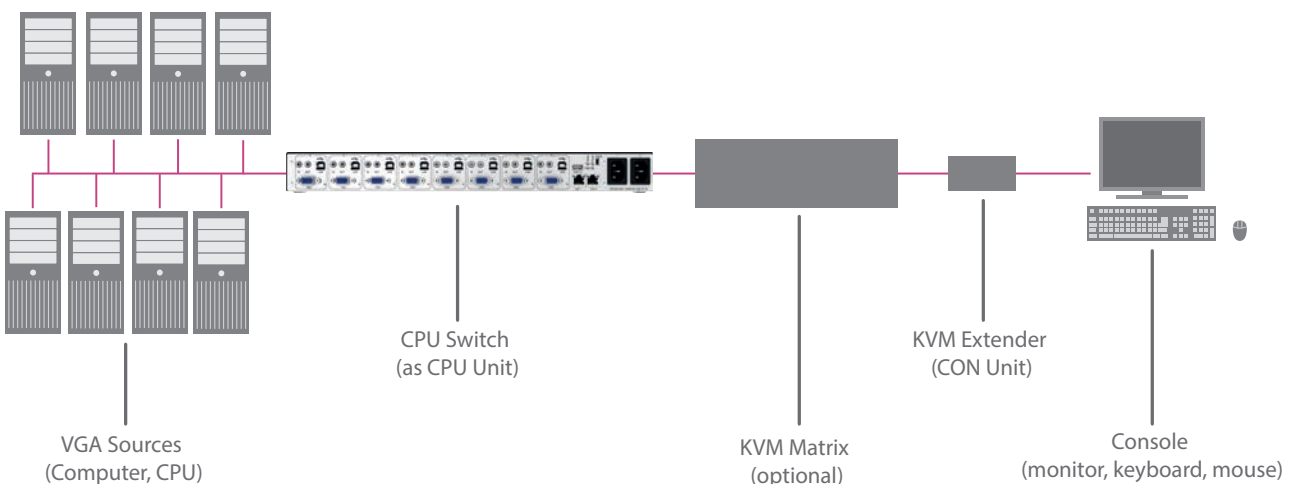

Applications







Many control rooms and data centers still operate older servers with VGA graphics cards and need to continue to do so for financial and functional reasons. It is convenient for system administrators to be able to access these older devices through the KVM system.

The Draco CPU switch is a useful and cost-effective solution to this requirement, permitting the connection and selection of eight VGA sources to a single operator workstation over Cat X or optical fiber cables.

It can be integrated into a KVM matrix system to enable access from different user consoles. An integrated media conversion and scaler provides compatibility with video formats such as DVI, HDMI or DisplayPort.

The Draco CPU switch offers investment security and cost saving with flexibility and high accessibility of end devices. It can be combined with redundant power supplies and data link for the highest level of operational reliability.

Order Numbers

DEVICES	DATA TRANSMISSION	PART NO.
 <p>Draco CPU switch, 8x VGA, 2x HID, analog audio bidirectional, 2x USB 2.0 embedded, Cat X, redundant data link, redundant power supply</p>		L484-8VECWR
 <p>Draco CPU switch, 8x VGA, 2x HID, analog audio bidirectional, 2x USB 2.0 embedded, fiber, redundant data link, redundant power supply</p>		L484-8VESWR
 <p>Draco CPU switch, 8x VGA, 2x HID, analog audio bidirectional, 2x USB 2.0 embedded, fiber XV, redundant data link, redundant power supply</p>		L484-8VEXWR

ACCESSORIES	PART NO.
VGA cable 2.0 m (VGA male to VGA male)	261-6J
USB cable 1.8 m (type A to B)	247-U1
Stereo jack cable 1.6 m (3.5 mm stereo)	455-CK
IEC connection cable for power supply, lockable	474-IECLOCK
19"/1U rack mount kit for Draco CPU switch	474-6RMK



Module for mounting in Draco vario chassis

- Freely configurable Multi-Screen Control
- Quick and instant switching
- Switching via keyboard
- Optional push-buttons
- Individual screen arrangements

Product Information

Operators working on several independent CPUs and monitors concurrently benefit greatly from the ability to use a single mouse and keyboard across them all, without having to select a different one as they change screens. In the financial sector, in command and control rooms and in other mission-critical

applications, users need fast and accurate action across multiple screens. IHSE's Draco U-Switch is ideal for these situations, enabling operation of up to eight displays with a single keyboard and mouse set. Screens can be oriented in linear horizontal and vertical

configurations. Block layout of screens is also possible. The Draco tera Tool also offers customized configuration of monitors. This enables screen arrangements comprising different screen sizes and orientations.

Product Features

- Instant switching of CPUs for multi-monitor workstations
- Option for the parallel switching of transparent USB 2.0 data and USB-HID
- Switching via keyboard or optional push buttons
- Multi-Screen Control (switching via mouse movement)
- Flexible Multi-Screen Control configuration via Draco tera tool
- Compatible with all Draco products
- Compatible with all USB-HID devices
- Rack mountable, up to 2 U-Switches can be installed in 1 RU of rack space

TECHNICAL DATA	
Power Supply (internal)	90-240 VAC / 0,5 A / 47-63 Hz 5VDC
Input	USB-HID (USB-B)
Output	USB-HID (USB-A)
Ports	4-/8-Port Switch
Dimensions	221 x 146.7 x 43 mm (8.7 x 5.8 x 1.7 inch)

Order Numbers

DEVICES		PART NO.
	Draco U-Switch, 4 port USB-Switch (2 USB-HID devices supported)	K476-4U
	Draco U-Switch, 4 port USB-Switch (4 USB-HID devices supported)	K476-4U2
	Draco U-Switch, 8 port USB-Switch (2 USB-HID devices supported)	K476-8U
	Draco U-Switch, 4 port USB-Switch (2 USB-HID and 2 USB 2.0 devices supported) with USB 2.0 switching on the upper board	K476-4U4T
	Draco U-Switch Module (for mounting in Draco vario chassis), 4 port USB-Switch (2 USB-HID and 2 USB 2.0 devices supported)	B476-4U4T

ACCESSORIES	PART NO.
Rack mount kit for 2 bay vario chassis with internal PSU	474-2NRMK
Mounting bracket for 2/4/6 bay chassis (L-brackets with screw slots)	474-BRACKET
19"/1 RU rack mount kit for 2 and 4 bay chassis	474-VRMK
Switch unit for switching of 4 port U-Switch devices via push button, 4x LEDs	476-CTRL4
Switch unit for switching of 8 port U-Switch devices via push button, 8x LEDs	476-CTRL8

Functional Diagram

Up to 8 CPUs

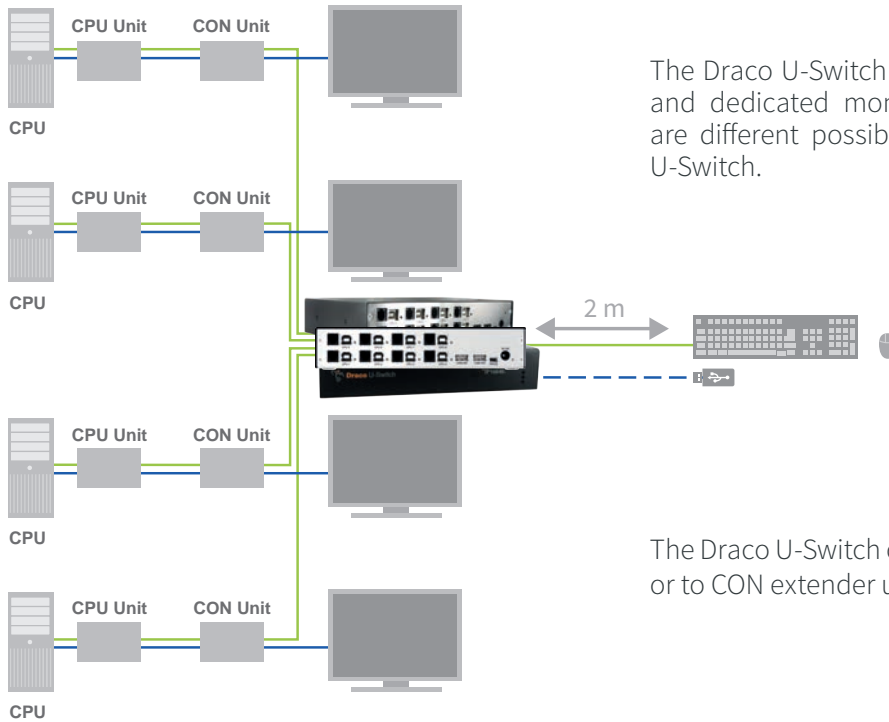

The Draco U-Switch enables operating multiple computers and dedicated monitors with one single console. There are different possibilities for the input connection of the U-Switch.

The Draco U-Switch can be connected directly to computers or to CON extender units.

Free configuration of multi-screen monitors

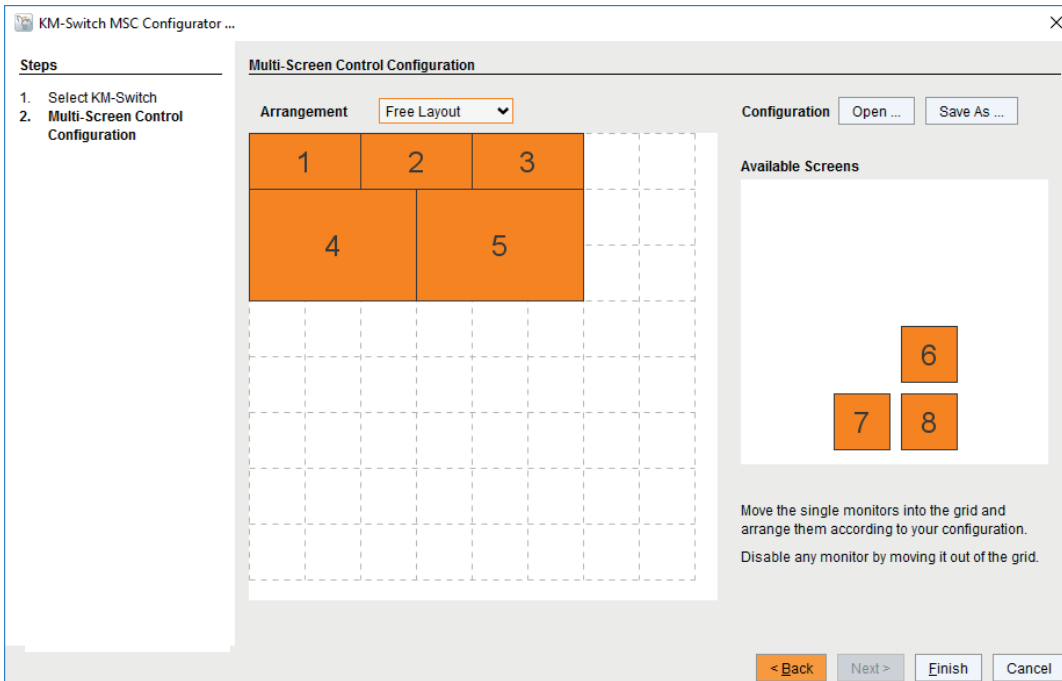



- Individual printing of keypad keys
- Expandable by 50 function keys
- Comfortable operation, Plug & Play
- Premium aluminium housing
- Extremely durable key legends
- Adjustable tilt angle (3 levels)

Product Information

With the new freely programmable IHSE keyboard, a keyboard, mouse and keypad can be connected as a single HID device to a KVM system through a single USB port without

the need for an additional HID extension. The remaining USB port on the extender CON Unit allows simultaneous connection of another USB-HID device. The mechanical and ergono-

mic keyboard is designed for high demands and heavy duty with up to 50 million keystrokes.

Comfortable operation

The high-quality workmanship with anodized aluminum housing, adjustable tilt angle, abrasion-resistant key lettering, precise attachment points and excellent haptics with optional damping element provides a very pleasant writing experience.

Practical extension

The keyboard can be expanded by up to two matching 25-keypads (part no. 444-K25) for freely programmable function keys or macros (2 layers = 50 strings). Thanks to the simple cordless connection, the workplace remains neat and free of unnecessary cabling. The keypads can also be connected to the KVM system apart from the IHSE keyboard.

Individual printing of keypad keys

Support of customer-specific printing and assignment of the keypad keys (part no. 444-K25P).

For safety-critical applications

The IHSE keyboard facilitates black-red separation of security zones, as operated in military and secure government facilities.

Product Features

- Extremely durable key legends (double-shot keycaps)
- Adjustable tilt angle (3 different levels), including the option of a negative angle
- Rugged design guarantees good desk contact to prevent slipping
- Long travel keys with precise switching point
- Concave shaped keycaps for supporting the positioning of the fingertips
- Function keys for an easy control of music and media apps
- USB-mouse port for connecting wired/wireless mice directly to the keyboard
- Expansion option for additional programmable keypads
- Configurable expert features for further adjustments (macros, key scan, color and brightness of the status LEDs, disabling of the windows key)

TECHNICAL DATA	
Type of Buttons	QWERTY and QWERTZ key buttons
Power	USB 2.0
Cables	1.5 m USB cable included
Package	Keyboard, USB cable, rubber feet, multitool
Keypad	25 keypad - with locking tabs to mount on keyboard
Dimensions	465 x 155 x 29 mm (18.3 x 6.1 x 1.1 inch)
Weight	1.40 kg

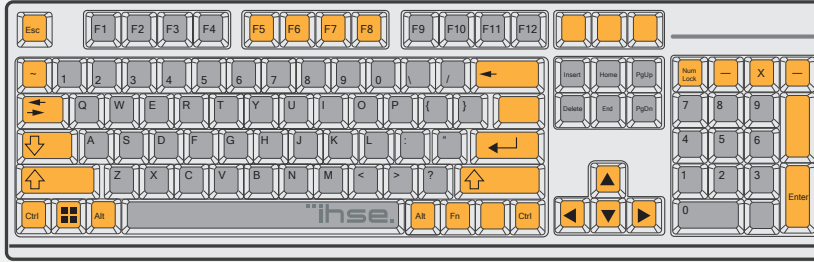

Custom IHSE keyboard for KVM applications

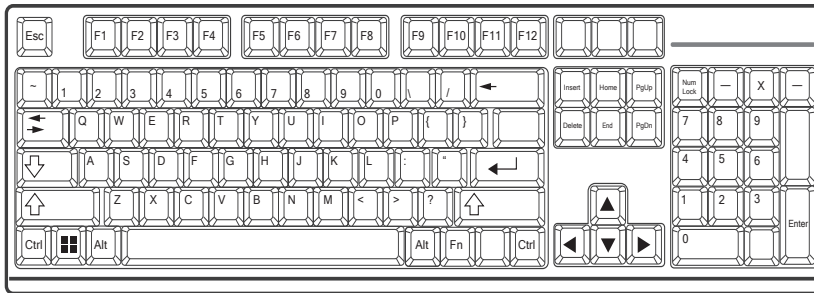

Keyboard only

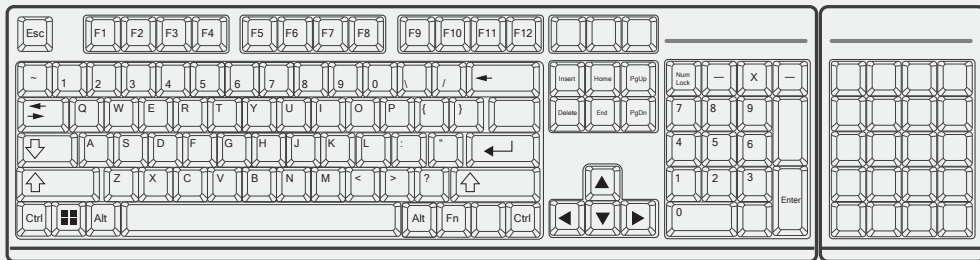

Keyboard with one keypad (25/50 macro keys)

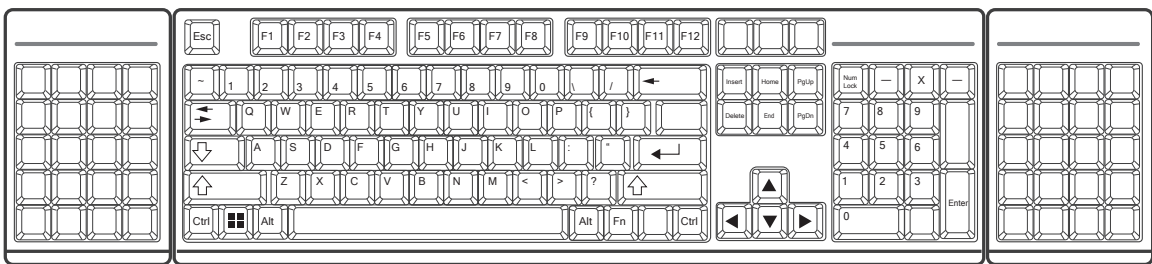

Keyboard with two keypads (50/100 macro keys)

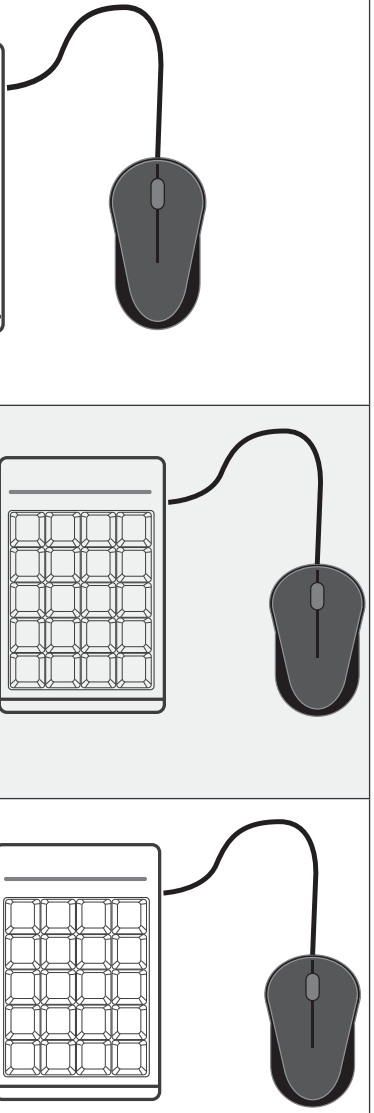

PRODUCT	PART NO.
IHSE Keyboard, 105 keys, German layout	444-KDE
IHSE Keyboard, 105 keys, US layout	444-KUS
IHSE Programmable Keypad 25, 25 keys, no print layout	444-K25
IHSE Programmable Keypad 25 custom pad printing, customizable key cap printing	444-K25P



- For configuration of Draco tera switches
- 17" wide LCD Display (up to 1920x1200)
- USB-HID version
- Keyboard with touchpad
- Country-specific keyboard (optional)
- KVM unit (optional)

Product Information

The Draco TFT Admin Console is an integrated KVM console unit with monitor, keyboard and touchpad for installation in server racks or computer cabinets. It provides convenient access to the Draco tera enterprise KVM matrix for

supervisory management and control. For administration tasks no matrix data port is required. System checks and troubleshooting can be performed locally without the need of connecting and cabling hardware. On top of supervisory management

and control. The console may optionally be connected through an extender allowing real-time access to all connected servers for system administrators.

Product Features

- 1 RU monitor keyboard drawer for 19" rack mounting
- Native resolution 1920 x 1200 pixels (WUXGA)
- 17.1" screen diagonal
- LED backlight
- Interchangeable compact keyboard with touchpad
- Integrated wide-range power supply (100-240 VAC) with IEC 320 plug
- High quality torque hinges keep the monitor in any position
- USB connection for keyboard and mouse
- DVI-I (DVI and VGA) and DisplayPort
- Picture-in-Picture presentation
- Country-specific keyboard for an additional charge
- Front USB

DRACO TFT CONSOLE	ADMIN	REMOTE ADMIN	REMOTE ADMIN +
Part No.	477-KVM-R1	R477-KVSHC-R1	R477-KVSEC-R1
17" TFT Wide LCD Display	✓	✓	✓
Resolution 1920 x 1200 (WUXGA)	✓	✓	✓
Brightness typ. 400cd/m ²	✓	✓	✓
Contrast ratio typ. 600:1	✓	✓	✓
On-Screen Menu	✓	✓	✓
Authorizations: CE, FCC, EN 60950-1:2006	✓	✓	✓
KVM Unit (CON Unit)	-	DVI, 2 x HID, Cat X, 1 monitor, S-Link	DVI, 2 x HID, Cat X, 1 monitor, S-Link + transparent USB 2.0 interface on front panel
Operation with Draco tera compact	-	✓	✓
Operation with Draco tera enterprise	✓	✓	✓

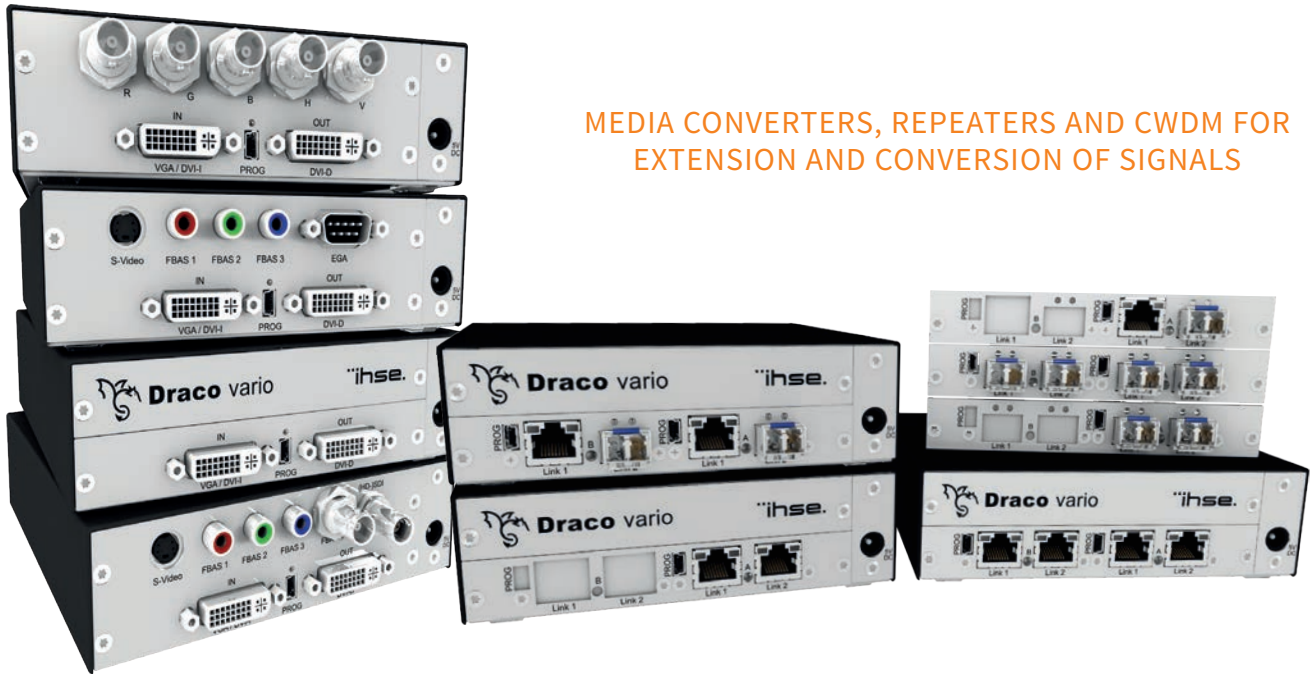

MEDIA CONVERTERS, REPEATERS AND CWDM FOR EXTENSION AND CONVERSION OF SIGNALS

CONVERTERS, REPEATERS, CWDM, USB

	SERIES	FROM PAGE	75
Draco vario Media Converters / Repeaters	485		76
Draco CWDM	470		78
Draco Video Converters	238		80
DVI / VGA Converter	469		82
2 x DVI Splitter Cable	445		83
PS/2 to USB and USB to PS/2 Converters	436		84
ICRON USB 3-2-1 Raven™ 3104, 3124	417		85
ICRON USB 2.0 Ranger® 2304	417		86
KVM meets IP			88
Technology Partners			89
Industry Organizations and Associations			90
Security in KVM Systems			92
Terms and Conditions			93
Contact			94



- Doubling of cable length
- Electrical/optical conversion
- Bidirectional data ports
- No configuration needed
- Compatible with all Draco products

Product Information

The installation of repeaters at intervals within a signal path extends the distance the signal can be transmitted to further distance via Cat X and fiber cable. The Draco vario repeater also offers cross-conversion between Cat X and fiber cables. Signals available on a Cat X network may be converted to fiber for transmission

and converted back to Cat X at the receiver (or vice-versa). High-quality signal processing and integral amplification ensure no signal degradation or transmission artifacts. Both device options can be deployed between extenders and between extender and matrix. The devices support our Flex-Port technology. Cat X and fiber

ports will automatically configure as input or output according to the connected devices. No additional configuration is required. Please note that the scope of delivery includes only a module (without chassis). Single- and dual-repeater module versions are available for installation in Draco vario frame chassis.

Product Features

- Doubling of cable length
- Electrical/optical conversion
- Bidirectional data ports
- No configuration needed
- Compatible with all Draco KVM products
- Scope of delivery: Module (for mounting in Draco vario chassis)

TECHNICAL DATA	
Input	Cat X, single-mode fiber
Output	Cat X, single-mode fiber
Maximum Cable Distance	max. 2 x 140 m Cat X max. 2 x 10 km single-mode fiber (9µ)

Functional Diagram

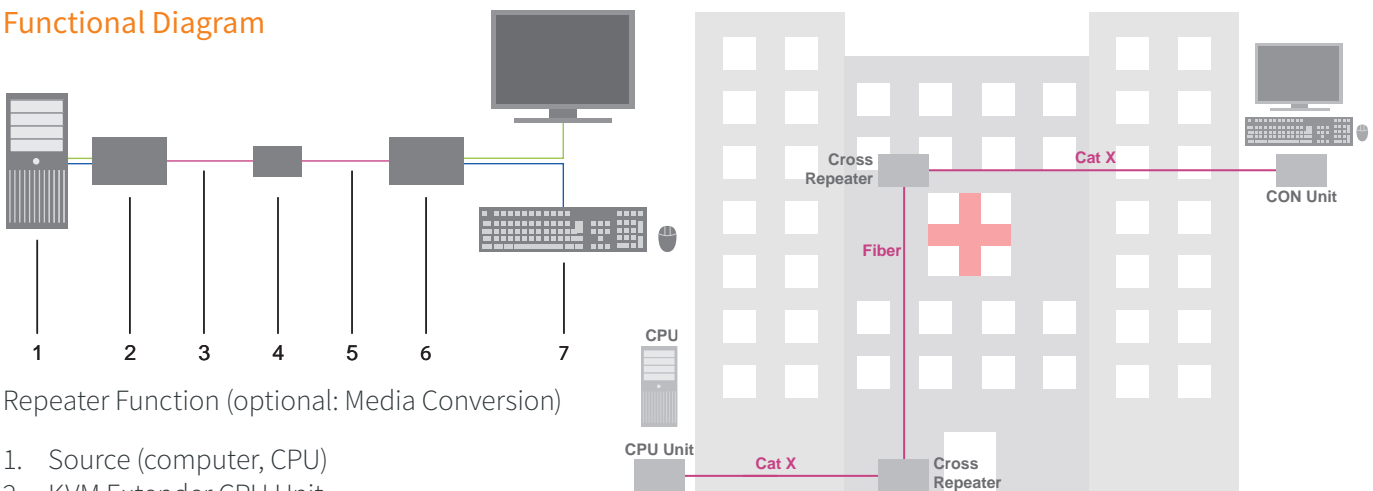







Repeater Function (optional: Media Conversion)

1. Source (computer, CPU)
2. KVM Extender CPU Unit
3. Interconnect cable (Cat X)
4. Draco vario (Cross) Repeater
5. Interconnect cable (Cat X / fiber)
6. KVM Extender CON Unit
7. Console (monitor, keyboard, mouse)

Application: In many large buildings the horizontal cabling is done with Cat X cables and the vertical cabling with fiber cables. If you use Cross Repeaters, this application will be handled perfectly. The Cross Repeater is also very suitable for the connection between two buildings.

Order Numbers of Repeater Modules

PRODUCT		PART NO.
Repeater module Cat X		485-BC
Dual repeater module Cat X		485-BCC
Repeater module fiber		485-BS
Dual repeater module fiber		485-BSS
Repeater module Cat X/fiber		485-BX
Dual repeater module Cat X/fiber		485-BXX

The cross repeater works with Draco vario extenders with the redundant option. The cross repeater is installed in a secondary path to provide backup to the primary KVM matrix switch. In the event of failure, signals are transmitted from the transmitter to the receiver through the cross repeater, bypassing the matrix.

The Draco vario Repeater family features bidirectional data ports: Cat X and fiber ports are individually usable as inputs or outputs. No additional configuration is required. Single- and dual-repeater module versions are available for installation in Draco vario frame chassis.

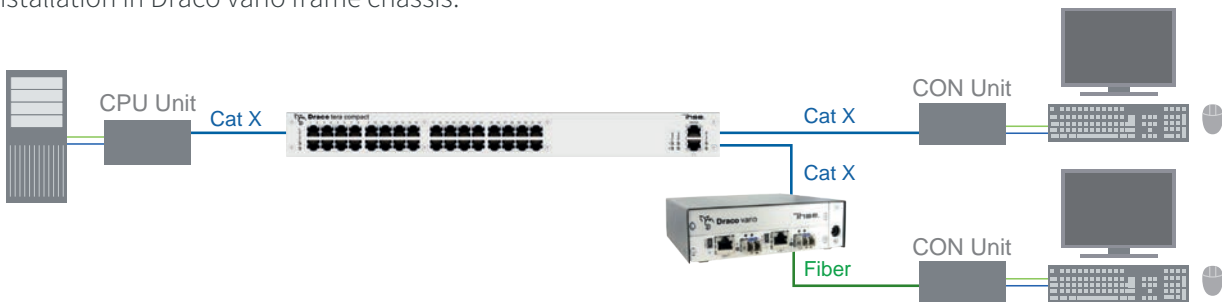

The cross repeater allows the inter-connection of single fiber consoles to plain Cat X switching systems by cross-conversion between Cat X and fiber signals. This is beneficial in Cat X switching environments in which a small number of workstations need to be connected via fiber cables to achieve long distance capability.

Redundancy Concept

Fallback Scenario Cross Repeater

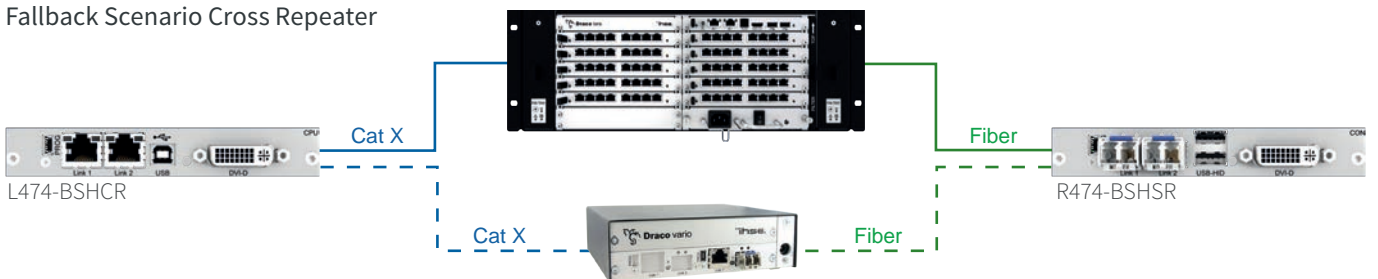

The cross repeater works with Draco vario extenders with the redundant option. The cross repeater is installed in a secondary path to provide backup to the primary KVM matrix switch. In the event of failure, signals are transmitted from the transmitter to the receiver through the cross repeater, bypassing the matrix.



Please find suitable chassis and Draco add-on modules for free configuration from page 42 and mounting accessories on page 48.



- 4, 8 or 16 channels over a single fiber connection
- Passive unit requires no power supply
- No power supply required
- Signal type agnostic
- Update for Draco extenders and Draco switches



SFP modules are available in various wavelengths upon request

Product Information

Draco CWDM multiplexers minimize the total number of long interconnection cables and cabling effort. CWDM (Coarse Wavelength-Division Multiplexing) is a technology which multiplexes a number of optical fiber signals onto a single optical fiber by using different wavelengths. Using specific SFP modules (small form-

factor pluggable) the bidirectional passive optical pair of multiplexer and demultiplexer allows up to 4, 8 or 16 different wavelengths to pass through a single optical single-mode fiber channel. The Draco CWDM multiplexer/demultiplexer kit can be installed in several types of Draco vario chassis and is designed

to integrate seamlessly with Draco vario extenders and Draco tera matrix switches. The Draco CWDM is completely agnostic to the signal type being transmitted, allowing DVI, HDMI, DisplayPort, USB, audio and RS232 signals from 4, 8 or 16 different sources to travel up to 10 km over a single transceiver connection.

Product Features

- Compatible with Draco extenders and Draco switches
- Multiplex 4, 8 or 16 extender signals over a single CWDM fiber channel
- Various types of signals supported such as DVI, HDMI, DisplayPort, USB, audio and RS232/RS422
- Passive Draco CWDM optical design in one package
- Minimize cabling cost
- Completely passive – no power supply required
- Scope of supply: Draco CWDM (transmitter and receiver) without SFPs

TECHNICAL DATA	
Maximum Distance	Up to 10 km (based on SFP type used)
Wavelengths 4 port	1531, 1551, 1571, 1591 nm
Wavelengths 8 port	1471, 1491, 1511, 1531, 1551, 1571, 1591, 1611 nm
Wavelengths 16 port	1311, 1331, 1351, 1371, 1391, 1411, 1431, 1451, 1471, 1491, 1511, 1531, 1551, 1571, 1591, 1611 nm
Dimensions	4/8 CH 145 x 147 x 41 mm (5.7 x 5.8 x 1.6 inch)
	16 CH 295.5 x 146.7 x 43.0 mm (116.3 x 57.8 x 1.7 inch)

Order Numbers

PRODUCT	PART NO.
4CH Draco CWDM Multiplexer/Demultiplexer Kit pair of devices, with SFP modules 1531...1591 nm, up to 4 data links via 1 pair of fibers	K470-4CW-SFP
8CH Draco CWDM Multiplexer/Demultiplexer Kit pair of devices, with SFP modules 1471...1611 nm, up to 8 data links via 1 pair of fibers	K470-8CW-SFP
18CH Draco CWDM Multiplexer/Demultiplexer Kit pair of devices, with SFP modules 1311...1611 nm, up to 18 data links via 1 pair of fibers	K470-18CW-SFP
4CH Draco CWDM Multiplexer/Demultiplexer Module Version pair of devices, with SFP modules 1531...1591 nm, up to 4 data links via 1 pair of fibers	B470-4CW-SFP
8CH Draco CWDM Multiplexer/Demultiplexer Module Version pair of devices, with SFP modules 1471...1611 nm, up to 8 data links via 1 pair of fibers	B470-8CW-SFP

SPARE PARTS	PART NO.
4CH Draco CWDM Multiplexer/Demultiplexer for Draco Extender devices - single device, without SFP modules - up to 4 data links via 1 pair of fiber	470-4CW
8CH Draco CWDM Multiplexer/Demultiplexer for Draco Extender devices - single device, without SFP modules - up to 8 data links via 1 pair of fibers	470-8CW
18CH Draco CWDM Multiplexer/Demultiplexer for Draco Extender devices - single device, without SFP modules - up to 18 data links via 1 pair of fiber	470-18CW

RACK MOUNT HARDWARE	PART NO.
19" rack mount kit (1 RU, for 2 or 4 bay Draco vario chassis), for 1-2 Draco CWDM devices	474-VRMK
19" rack mount kit (1 RU, for 2 bay chassis) for 1 Draco CWDM device (4/8CH)	474-2RMK
19" rack mount kit (1 RU, for 4 bay chassis) for 1 Draco CWDM device (18CH)	474-4RMK
Mounting bracket to mount by screws	474-BRACKET

Functional Diagram

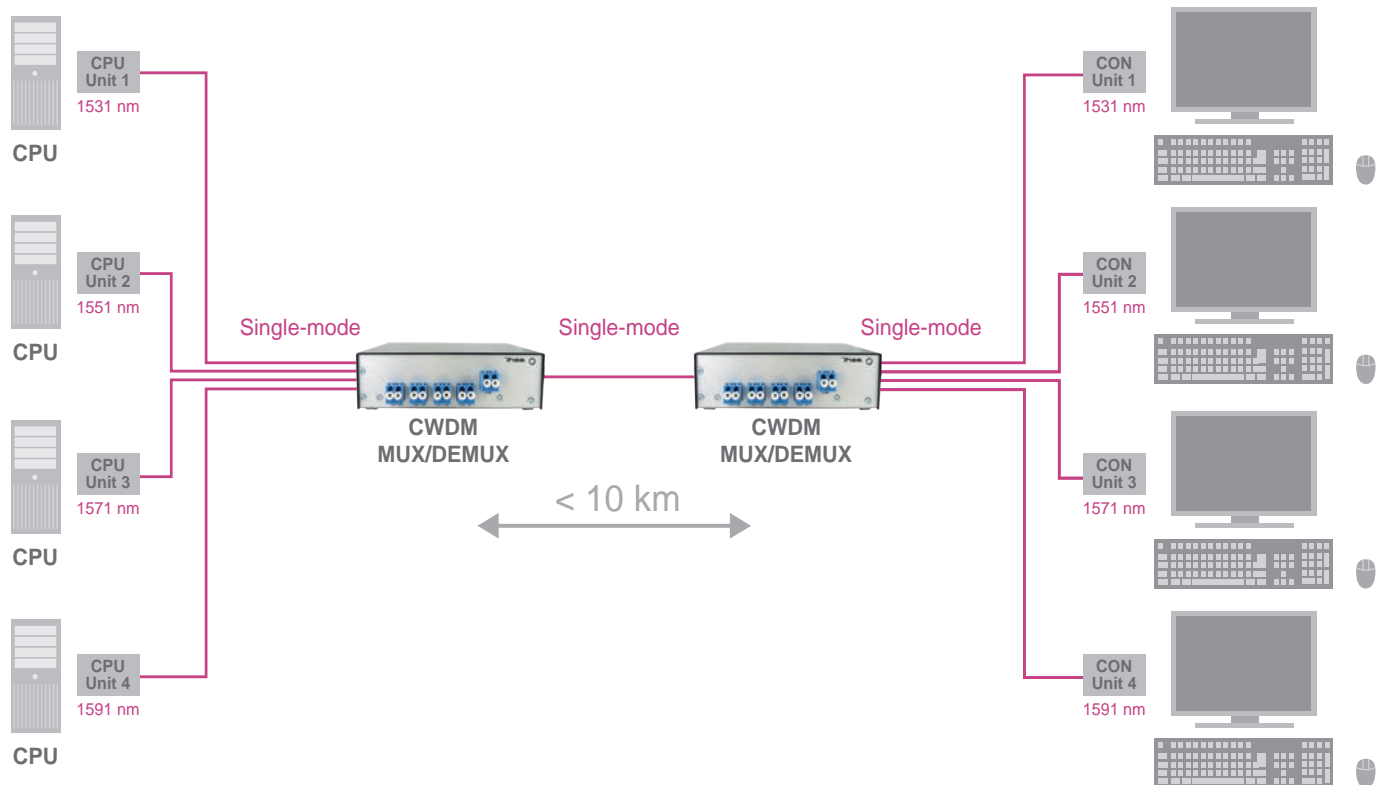

Please find suitable chassis and Draco vario modules for free configuration from page 42 and mounting accessories on page 48.



- S-Video, Component-Video, FBAS
- CGA, EGA, MDA, VGA
- SDI, HD-SDI, DVI
- RGB, RGBS, RGBHV
- 160 preinstalled video modes
- Integrated scaler

Product Information

The Draco Video Converter series allows the continued use of legacy equipment through the conversion of RGB/VGA/Media signals to digital DVI signals. Modern digital displays can be connected to analog VGA sources.





The converter automatically recognizes all legacy VGA resolutions up to 1920 x 1200. An internal scaler rescales incoming video to a suitable resolution. The Draco Video Converter reduces time and installation costs by allowing existing analog computers to be operated with digital displays.





Product Features

- Converting many common and the most special video signals into DVI-D
- User-friendly OSD
- Multiple input formats such as S-Video, Component, Composite, VGA, SDI, HD-SDI, DVI RGB, MDA, CGA, EGA
- Optional: S-Video, Component-Video, MDA, CGA, EGA
- Optional: S-Video, Component-Video, SDI or HD-SDI
- 160 preinstalled video modes
- Integrated scaler
- Scaling options up to 1920x1080 or 1920x1200
- Package contents according to device type:
 - Draco Video Converter
 - EGA connection cable
 - VGA connection cable
 - Component Video connection cable
 - S-Video connection cable
 - SDI connection cable
 - IR remote control
 - External power supply unit
- Combinable with extenders and chassis of the Draco vario series

TECHNICAL DATA	
Power Supply (external)	90-240VAC / 0.5 A / 47-63 Hz, 5VDC
Maximum Resolution (output)	DVI-D 1920 x 1200 @ 60Hz
Video frequency for K238-5FBNC (input)	15-80 kHz horizontal 50-80 Hz vertical
Dimensions	103 x 143 x 42 mm (4.1 x 5.6 x 1.7 inch)

Order Numbers

COMPLETE DEVICES	FUNCTIONS	CPU UNIT (LOCAL)	PART NO.
Draco Video Converter VGA-DVI	Converts VGA into DVI		K238-5V
Draco Video Converter Video	Converts VGA, FBAS, Y/C, MDA, CGA or EGA into DVI		K238-5VE
Draco Video Converter SDI	Converts VGA, FBAS, Y/C or (HD-) SDI into DVI		K238-5VS
Draco Video Converter RGB-DVI	Converts VGA or RGB into DVI		K238-5FBNC

MODULE VERSIONS	FUNCTIONS	CPU UNIT (LOCAL)	PART NO.
Draco Video Converter module VGA-DVI	Converts VGA into DVI		C474-BVGA
Draco Video Converter module Video	Converts VGA, FBAS, Y/C, MDA, CGA or EGA into DVI		C474-BVID
Draco Video Converter module SDI	Converts VGA, FBAS, Y/C or (HD-) SDI into DVI		C474-BSDI
Draco Video Converter module RGB-DVI	Converts VGA or RGB into DVI		C474-BBNC

ACCESSORIES	PART NO.
VGA connection cable 1.8 m (VGA to DVI-I)	436-AA
RGB connection cable 2.0 m (5 bay BNC connector)	238-BNC
EGA connection cable 1.8 m (D-Sub 9 socket to D-Sub 9 connector)	238-EGA
Component Video connection cable 1.5 m (3 bay RCA connector)	238-RCA
S-Video connection cable 3.0 m (Mini DIN connector, 4-pole)	238-SV
SDI connection cable 2.0 m (BNC connector to BNC connector)	238-SDI
International power supply 100-240VAC/5VDC (spare part)	260-5G



Please find suitable chassis and Draco vario modules for free configuration from page 42 and mounting accessories on page 48.

DVI TO VGA CONVERTER



- Easy installation
- Converts DVI-D into VGA
- DVI Single Link
- Max. 1920 x 1200 / 60 Hz

Product Information

This device converts DVI signals to VGA format. The DVI/VGA Converter can be used with a VGA/KVM switch or to convert a DVI source for a

high quality VGA device such as a projector. Received DVI signals are converted 1:1 without modifying the resolution or signal frequency.

The receiving device must be able to display the generated signals, e.g. 60 Hz or “reduced blanking” at highest resolutions of up to 1920 x 1200.

Product Features

- Supported input signals:
DVI-D up to 1920 x 1200 @ 60 Hz
- Shipping includes:
 - DVI to VGA converter
 - DVI cable to connect to CPU
 - International PSU
- Power supply included as external power supply units

TECHNICAL DATA	
Power Supply (external)	90-240VAC / 0.5 A / 47-63 Hz, 5VDC
Data rates (input)	22-95 kHz horizontal 48-90 Hz vertical Video range: 170 MHz
Maximum Resolution (output)	VGA input resolutions/ frequencies
Dimensions	51 x 74 x 26 mm (2.0 x 2.9 x 1.0 inch)

Order Number

PRODUCT	PART NO.
DVI to VGA Converter	K469-DV

2-PORT DVI SPLITTER CABLE



- Easy Installation
- Input / output: DVI-D
- Power supply via USB
- Connections for 2 DVI monitors

Product Features

- DVI signal output for two display units
- Transmission of the EDID information
- Determine which EDID information is transmitted by pressing a button
- DVI connecting cable is fixed / included
- Power supply via USB connection

TECHNICAL DATA	
Maximum Resolution	DVI Single Link 1920 x 1200 @ 60 Hz
Color Depth	8 bit / True Color
Dimensions	100 x 49 x 23 mm (3.9 x 1.9 x 0.9 inch)
Cable length	0.2 / 1.8 m

Functional Diagram

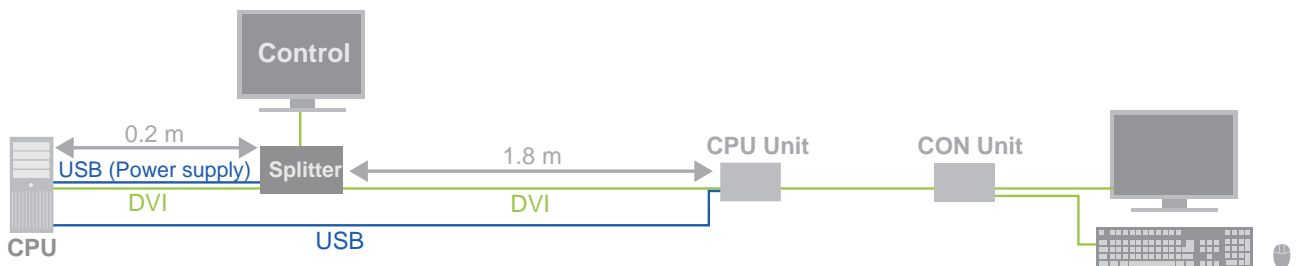

Order Number

PRODUCT	PART NO.
2 x DVI splitter cable	445-2H



PS/2 TO USB



USB TO PS/2

- Plug-and-Play (without drivers)
- No external power supply required

Product Information

This devices convert USB into PS/2 signals or PS/2 into USB signals. PS/2 keyboards and mice can be connected to CPUs without PS2 ports or to connect a PS/2 keyboard/mouse to

a USB-KVM extender. Also USB keyboards and mice can be connected to CPUs without USB ports or to connect USB keyboards and mice to a PS/2-KVM extender. This converters

do not require any power supply. Please note: it contains components that actively generate the signals.

Order Numbers

PRODUCT	PART NO.
USB to PS/2 Converter	436-UP
PS/2 to USB Converter	436-PU



- USB 3.1 Gen 1 data rate up to 5 Gbit/s
- Supporting all USB 3.1, 2.0, 1.1 devices
- Up to 1.2 A (6W) per USB port
- 100/1000 Mbps Ethernet channel; LAN pass-through
- Point-to-point connection

Product Information

The Icron USB 3-2-1 Raven™ is the world's first and only USB 3.1 extender allowing users to extend all USB 3.1 Gen 1 (5 Gbit/s) device types as well as USB 2.0 and 1.1 devices across a point-to-point connection up to 100 m over a single Cat 6a/7 cable. This is an ideal USB 3.1 extender solution for conference rooms using USB 3.1 conference cameras. The Raven has been successfully tested

with most major USB 3.1 conference cameras in conjunction with major web conferencing applications. This 4-port USB 3.1 extender supports data rates at up to 5 Gbit/s and is plug and play – no software drivers required – for all major operating systems: Windows®, macOS™, Linux® and Chrome OS™. Additionally, this ExtremeUSB-C™ based USB 3.1 extender system is FCC/CE Class B

certified and, being backward compatible, is ideal for use with all USB peripherals in addition to USB 3.1 conference cameras including: flash drives, hard drives, keyboards, mice, interactive white boards, touchscreens, docking stations, USB to video converters, audio devices, and any other USB 3, 2 and 1 device.

Applications

- Remote Storage
- Security & Monitoring
- Video Matrix Systems
- Conferencing Cameras
- Medical Device Connectivity

TECHNICAL DATA	
USB Speed	USB 3.1: up to 5 Gbit/s USB 2.0: up to 480 Mbit/s USB 1.1: up to 12 Mbit/s
Maximum Cable Distance	Cat X up to 100 m Multi-mode fiber up to 200 m
Enclosure Material	Silver anodized aluminium
Dimensions	137.3 x 232.1 x 33.0 mm (5.4 x 9.1 x 1.3 inch)

Functional Diagram

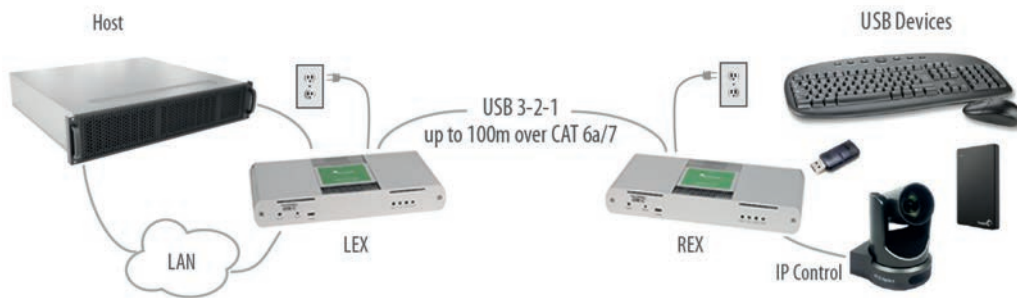

Order Numbers

PRODUCT		DATA TRANSMISSION	PART NO.
ICRON USB 3-2-1 Raven 3104 USB 3.1 extender, Cat X			K417-7C
ICRON USB 3-2-1 Raven 3124 USB 3.1 extender, multi-mode fiber			K417-7M



- Extends USB 2.0 up to 100 m at 480 Mbit/s
- Supports up to 31 devices and hubs
- Uses a Cat X cable for easy installation
- Includes the Extreme USB® suite of features

Product Information

The USB 2.0 Ranger® 2304 provides true USB 2.0 extension at up to 480 Mbit/s over Cat X cabling, without the need of additional software drivers. A true plug-and-play solution, the

Ranger 2304 is compatible with all leading operating systems and supports all USB 3.0, 2.0 and 1.1 peripherals such as flash drives, keyboards, mice, webcams and

interactive whiteboards across a dedicated Cat X connection. An integrated four port hub allows for extension of up to four USB devices without the need for an additional hub.

Product Features

- Extends USB 3.0, 2.0 and 1.1 devices up to 100 m at 480 Mbit/s
- Operates with USB 3.0, 2.0, and 1.1 hosts
- Supports up to 31 devices and hubs
- Uses a standard Cat X cable for easy installation
- Number of devices can be increased using additional USB hubs
- FCC Class B
- Rugged metal enclosure
- ExtremeUSB® suite of features:
 - Transparent USB extension
 - True plug and play, no software drivers required
 - Works with all operating systems: Microsoft®, Mac OS X® and Linux®

TECHNICAL DATA	
Power Supply for the CON Unit	110/240 VAC, 0.5 A, 50/60 Hz 24VDC
USB Speed	High speed (480 Mbit/s) (USB 2.0, 3.0) Full speed (12 Mbit/s) (USB 2.0 & 1.1) Low speed (1.5 Mbit/s) (USB 2.0 & 1.1)
Maximum Cable Distance	100 m (Cat X)
Dimensions	100 mm x 76 mm x 26 mm (3.9 x 3.0 x 1.0 inch)

Functional Diagram

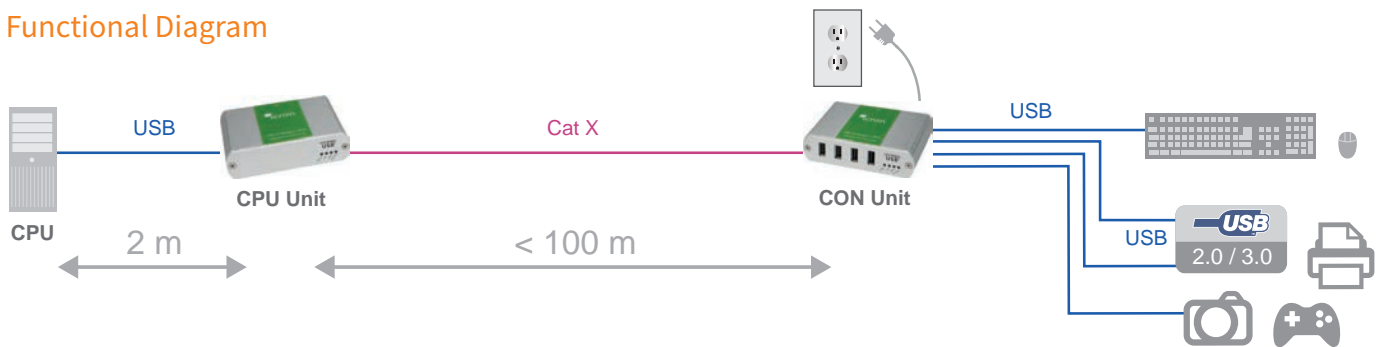

Order Number

PRODUCT	USB	DATA TRANSMISSION	PART NO.
Icron Ranger® 2304 (USB cable 1.8 m included)	2.0 / 1.1		K417-6D

How is IHSE addressing the trend towards IP?

KVM technology is an established out-of-band solution for managing IT assets such as servers, PCs and workstations efficiently and ergonomically. Access to IT assets is essential for servicing and maintaining them but also for the continuous operation of controlling processes or simply for the execution of tasks.

IHSE's IP gateways are designed to secure the core matrix systems uptime and immunity by physical separation between KVM and IP networks. In this way, IHSE's industry-first solution enables IP connectivity while maintaining an outstandingly reliable and secure system.

The **directly connected KVM system is isolated and independent of the IP network.** Every dedicated individual gateway acts as an isolator. Network errors do not cause harm to the entire system. IHSE Secure Core KVM networks are immune to network jamming or cyber attacks.



Seamless VDI integration – Remote IP CPU

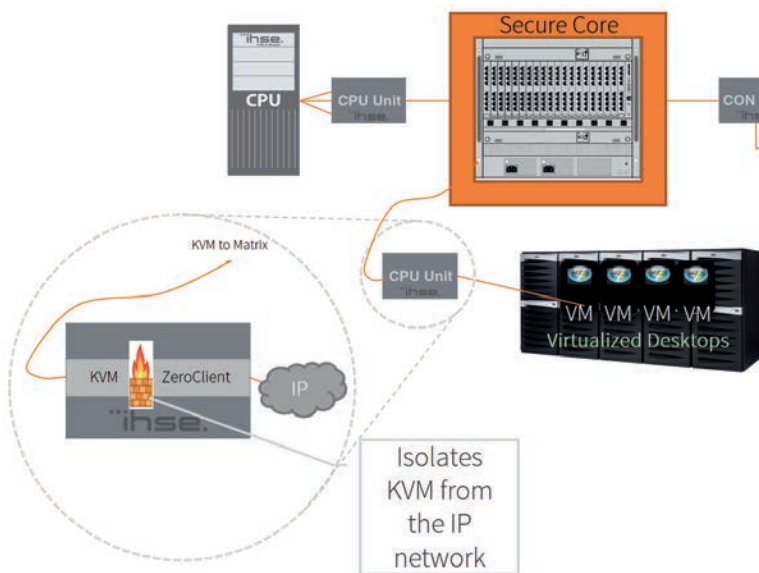

- Remote IP CPU Unit acts as a zero client
- Single session/multi session (8) support to VMs and SSH
- Zero client connects to the matrix via native KVM interfaces only, isolating the IP network from KVM Secure Core



Please find more product information about Draco vario Remote IP CPU for VDI Integration into KVM Systems on page 24.



TECHNOLOGY PARTNERS



IHSE supports industry organizations and associations

IHSE is committed to maintaining a leading edge on the markets we serve and we are proud members of the following organizations and associations who lead in their industry segments.





All business, government and military organisations have a duty to ensure that data they hold and manage is kept secure. The loss of sensitive commercial information can adversely affect the performance of a commercial corporation, whilst leaking of personal information and military intelligence may lead to increased criminal activity or threats to personal or national security.

It is a priority of system managers to ensure that the operational systems they are responsible for are protected to the very highest level against external threats. These may appear from a number of different directions, emanating from both internal and external sources. IHSE products are engineered with security foremost, to maintain complete data integrity and reduce unauthorised access.

Hardware and physical design

The role of a KVM matrix switch is to transmit data and commands over significant distances, often over relatively insecure buildings or terrain. The electronic equipment and signal transmission networks need to be resilient to external, unauthorised access. These include:

- **Physical attack - including signal interception and eavesdropping:** Attempts to intercept or access data carried on a KVM system are defended through the use of proprietary hardware devices and by preventing access to signals carried on the host network. Fiber connections are superior to copper as they do not radiate electromagnetic fields and require physical interruption in order to break into the signal being carried.
- **RF emanation and signal crosstalk:** IHSE devices are designed to prevent signal detection from RF emissions. A range of products is available with Tempest Level B compliance for the highest level of security. Circuit design eliminates crosstalk between I/O ports and pulses on power lines enabling complete separation of signals and enabling split Red/Black security systems to be built with single switches.

Access security

IHSE KVM systems contain extensive features to prevent access to sensitive data by unauthorised users. Measures are also available to prevent mass copying and injection of data. These include:

- **User access controls:** Multiple system parameters are available to control the access of individual users to sources. Settings are managed at the software level by the system administrator or at a firmware level, as is required for Red/Black installations. Access control lists limit users and workstations to specific CPUs and levels. In addition, IHSE provides monitoring options in case of rights violations.
- **Restricted USB access:** An HID interface provides hardware protection against mass data copy onto remote storage devices and prevents unauthorised and potentially harmful data being injected into the system.
- **Network separation:** Whenever KVM data is transmitted over an IP network, security is severely compromised. Almost any firewall can be overcome by hackers who then get access to both KVM system control and data. A secure KVM architecture should be built on a separate network for signal transmission. Dedicated networks used for IHSE Draco matrix switches are inherently more secure than open data networks of the type used for KVM-over-IP systems. In this case, the advantages of an IP-based KVM solution are largely negated.
- **In-band and out-of-band control:** For greatest security, IHSE systems offer in-band control (where switching operations are controlled by keyboard commands and an on-screen selection menu). This eliminates the need for external access and a potential risk from external threats. In situations in which out-of-band control is necessary, the system should be configured so that operations are dynamically controlled or even performed by a central management function using the external switch control.



TEMPEST-certified IHSE systems meet the criteria of NATO SDIP-27 Level B and Level C / NATO Zone 1+2 in accordance with the Zone short measurement. These systems provide a high level of security, including Access Control Lists (e.g. Red/Black separation for security level environment). The new Draco vario Secure Extender (487 series) include certified components, providing future compatibility with NIAP PP 4.0 protection standard. Isolation at all endpoints completely prevents data leakage or eaves dropping. Further information regarding the Tempest and Secure Extenders is available on request.

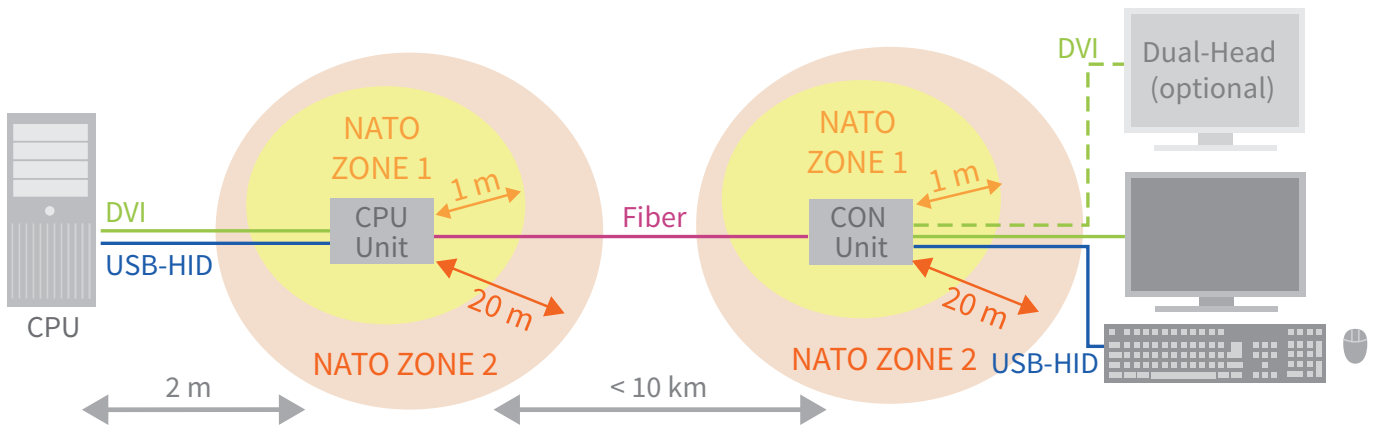

How do our systems provide maximum security?

- Physical attack → Restrict physical access to hardware
- Signal interception → Protect signal transmission against interception
- Signal leakage → Protect on-board signals against crosstalk
- Human error → Restrict user access to the „Need to know“ level
- Hardware failure → Provide redundant system architecture
Provide resilient system components
- IP-based systems → Provide IP connectivity with secure separation of core matrix and TCP/IP networks as an effective countermeasure to potential cyber attacks
- External control (API) → In-band Control vs. Out-of-band control

TERMS AND CONDITIONS

Please note our general terms and conditions available on WWW.IHSE.COM/GTC. In addition to your statutory warranty rights according to our general terms and conditions, we offer for IHSE products a free of charge extended warranty of 24 months from our shipment date. Additional annual warranty extensions are available thereafter. Please contact your sales representative for further details.

TERMS OF DELIVERY

We supply exclusively according to our terms of delivery and payment to industrial, business and commercial clients.

All deliveries are Ex-Works (Incoterms 2010) - usually from our factory in Oberteuringen, Germany. The customer is responsible for payment of all transportation and insurance costs. Shipment is done by our logistics partners. Shipping costs will be determined on the day of dispatch.

Standard parcel service: UPS
Standard freight forwarding: DACHSER

Lead time

The delivery period for standard products is normally ten working days after receipt of the purchase order. For volume and special orders the delivery period is around four weeks.

TERMS OF PAYMENT

All prices in Euro, Ex Works (EXW), plus VAT.

Payment: Advance payment against proforma invoice (invoice for registered customers)
Accounting currency: € (Euro)

HEADQUARTERS AND OFFICES

Please contact us for information about our company, events, products or partners. We look forward to hearing from you!

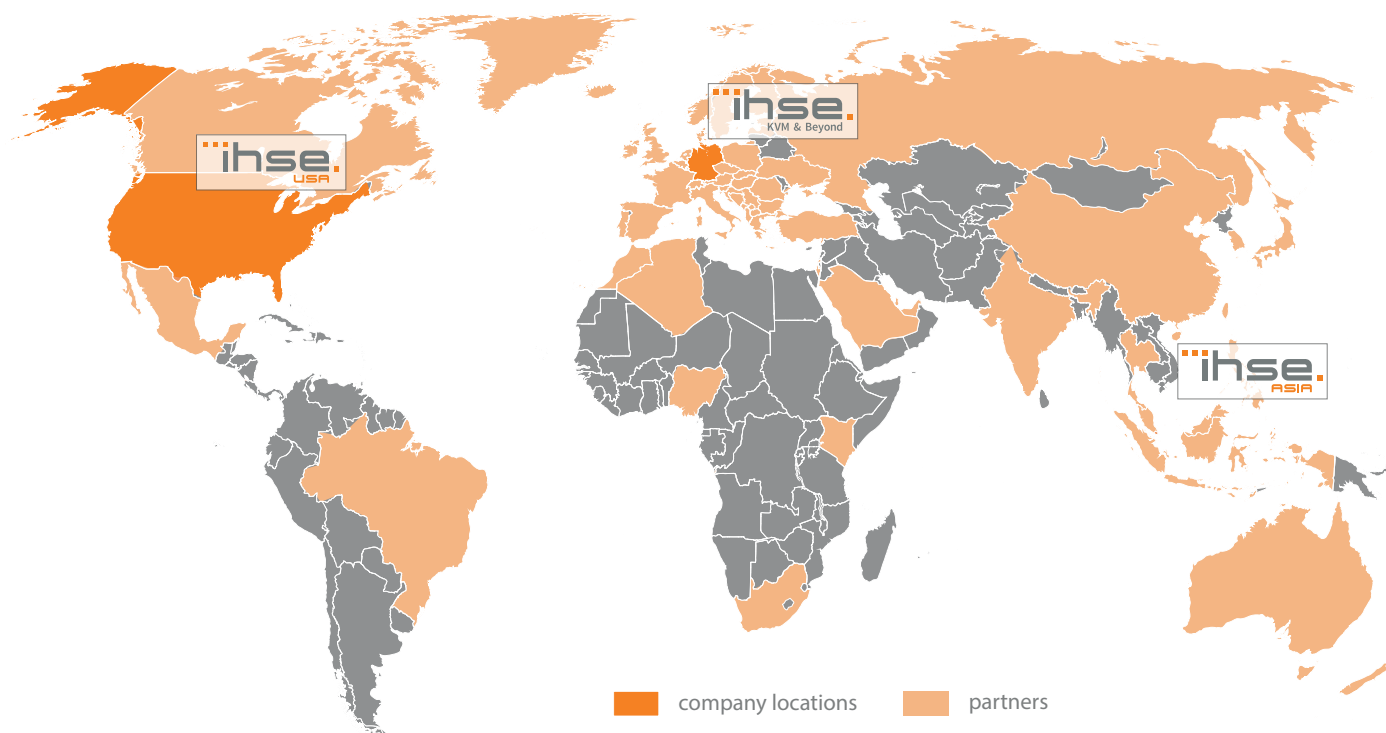

Subsidiary USA

IHSE USA LLC
1 Corporate Drive, Suite F
Cranbury, NJ 08512
USA

Tel: +1 (732) 738 8780
Toll Free: +1 (866) 721 0744
Fax: +1 (732) 631 0121
info@ihseusa.com

Tech Support

Tel: +1 (732) 738 8780
Fax: +1 (732) 631 0121
support@ihseusa.com

Office hours: (UTC -5)
Monday-Friday: 8:30 - 17:30

Regional Office France

Paris
France

Tel: +33 (678) 478 822
info@ihse.com

Headquarters Germany

IHSE GmbH
Benzstr. 1
88094 Oberteuringen
Germany

Tel: +49 (7546) 9248-0
Fax: +49 (7546) 9248-48
info@ihse.de

Tech Support

Tel: +49 (7546) 9248-43
techsupport@ihse.de

Office hours: (UTC +1)
Monday-Thursday: 8:00 - 16:30
Friday: 8:00 - 15:00

Sales

Tel: +49 (7546) 9248-42
sales@ihse.de

Register court:

Local court Freiburg, HRB 580617
VAT-No: DE 146 965 085
WEEE: DE 39 900 275
DUNS-No: 31-801-4289

Subsidiary Singapore

IHSE GmbH Asia Pacific Pte
Ltd
158 Kallang Way, #07-13A
Singapore 349245

Tel: +65 (6841) 4707
info-apac@ihse.com
sales-apac@ihse.com

Tech Support

Tel: +65 (6841) 4707
techsupport-apac@ihse.com

Office hours: (UTC +8)
Monday-Friday: 9:00 - 18:00

Regional Office Israel

Shoham
Israel

Tel/Fax: +972 (3) 9721 853
info@ihse.com



IHSE GmbH
Benzstr. 1
88094 Oberteuringen
Germany
Tel: +49 (7546) 9248-0
info@ihse.de

IHSE USA LLC
1 Corporate Drive
Cranbury, NJ 08512
USA
Tel: +1 (732) 738 8780
info@ihseusa.com

**IHSE GmbH Asia Pacific
Pte Ltd**
158 Kallang Way, #07-13A
Singapore 349245
Tel: +65 (6841) 4707
info-apac@ihse.com