

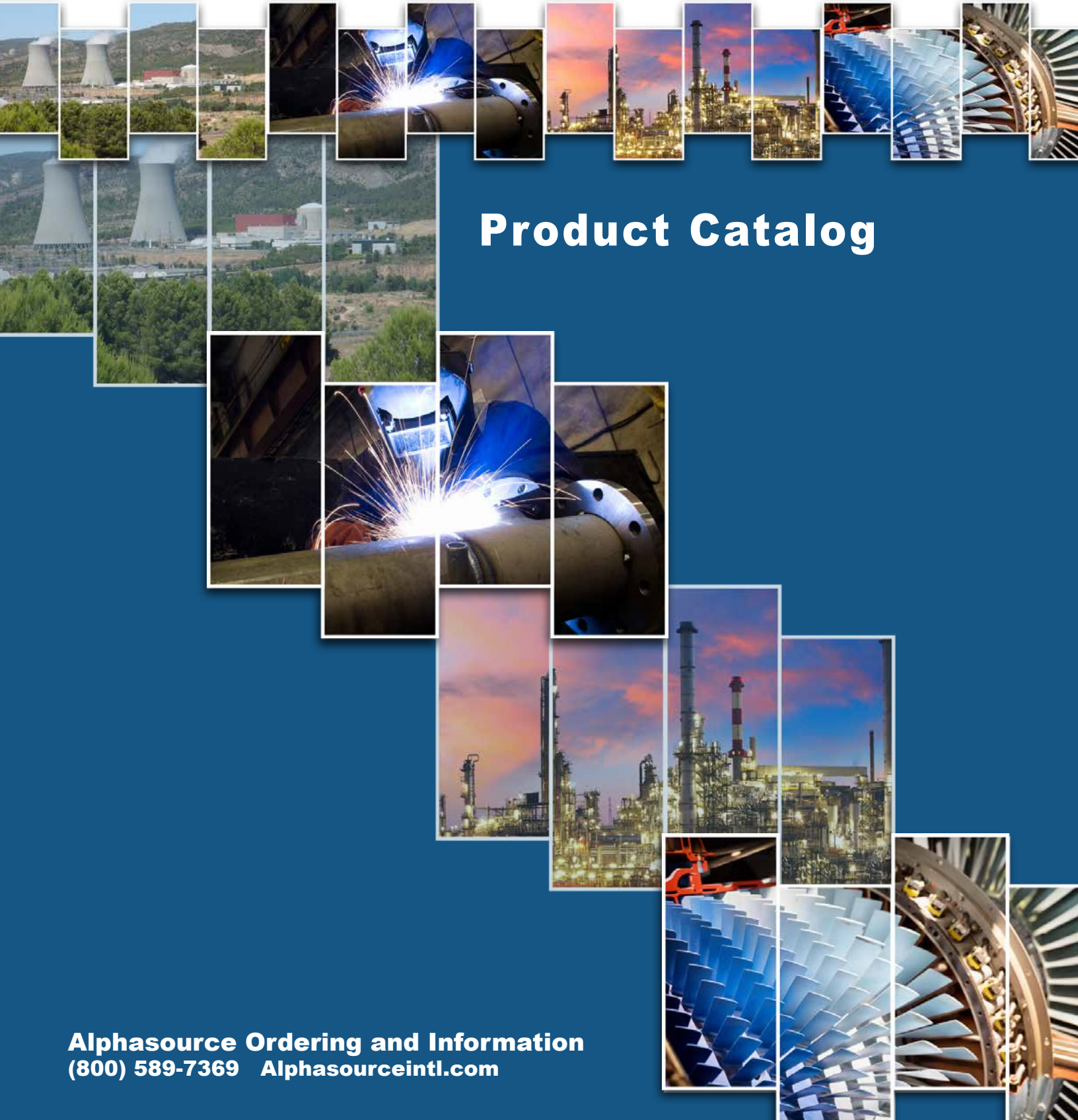

Alphasource®

Your First Source for: FME, RFID, Drop Prevention & Innovative Safety Supplies



Product Catalog

Alphasource Ordering and Information
(800) 589-7369 Alphasourceintl.com

Alphasource®

Quality

Founded in Philadelphia, PA, Alphasource® has been in continuous operation since 1908. Alphasource® is a progressive and innovative manufacturer and distributor with an extensive offering of industrial, maintenance, repair and operating (MRO), safety products and RFID/Barcode inventory control solutions. We are a company of procurement specialists, helping customers lower supply chain costs, and increase efficiency through value creation and sustainability initiatives.

Quality

Spanning over one hundred years of service and with the benefit of knowledge and experience in many cross-functional disciplines, we transform useful ideas into innovative solutions. We work with experienced industry leaders, and only the finest and most dependable material suppliers to consistently produce and deliver the highest quality products. Less time and money spent replacing lower quality products means getting a product that works right the first time.

Proudly Made in the U.S.A.

Since 1908, we have been making and sourcing our own products here in the U.S.A. We maintain the highest level of quality, provide quick turnaround for stock and custom manufactured products, and ensure that all of your products are delivered in a timely fashion.

Inventory

Need a product today or tomorrow? Not a problem! Most products are secured on site in our 67,000 square foot distribution center.

With a huge inventory, combined with the ability to anticipate your current and future needs, you can rest assured that we are ready when you are.

Product Specialist On-Hand

At Alphasource® we go the extra measure to have product

specialists on staff to service your business. We have machinery, material handling, RFID/Barcode integration, chemical, custodial and safety specialists on-hand and available to recommend the right solution for your particular application.

To Our Customers

Trust is earned and we are dedicated to the industries in which we serve. We pledge to engage you in value-added partnerships, cognizant always of the need to understand your business requirements, to design innovative solutions, and to meet our commitments to you 100% of the time.

Rest Easy...

New NFPA 805 Requirements are satisfied using Alphasource® 200 denier, 400 denier, 1000 Denier and mesh advanced FME Fabrics. All of our fabrics are certified to meet NFPA 701 Test Method 2. At Alphasource®, all of our fabrics are fully tested by an independent and nationally recognized ISO 17025 certified testing laboratory to perform and conform to the latest industry guidelines. If you are currently using Alphasource® FME supplies, manufactured with our Advanced fabrics, there will be no need to discard your current inventory from Alphasource®. Please feel free to contact one of our FME specialists if you have any questions regarding these new guidelines or any other special projects you may be working on.



Contents

Featured Products	4	FME 4 Cabinet	42	Comfort Flow	83
Drop prevention	5	FME 5 Cabinet	42	Stanchions	84
Small Portable Kits	6	FME 6 Cabinet	42	Wall Mount Stanchions	85
Large Mobile Kits	6	FME Controls	43	Stanchion Belt Ends	86
Hard Hat Lanyard	6	Custom FME Controls	44	Stanchion Pack	86
Premium Wrist Lanyard -The Toolsaver®	6	FME Covers	46	Retracta-Cone	87
Economy Wrist Lanyard	7	FME Mesh Nylon Cover with Pocket	46	The Retracta-Cade Crowd Control Barrier	87
Cold Shrink Tool Wraps	7	FME Mesh Covers	47	Retracta-Cade Light Kits	87
FME Neck Lanyards	8	FME Disposable Bags	47	FME Vests	88
Rubber Neck Lanyard	9	FME Outdoor Storage/Warehouse Covers	48	FME Armbands	88
Neck Lanyard for Smart Cards	9	FME Hi-Temp Silicone Covers	49	FME Culture Awareness	89
Fits All Phone Retention	9	FME Tarps	49	Posters	90
Fire Retardant Chinstraps	10	FME Mesh & Magnetic Tarps	50	FOSAR	91
Safe Box Cutter	10	FME Magnetic Round Covers	51	iShot® PTZ-550 Camera System	92
Floating Lanyard	10	FME Mesh Magnetic Round Covers	51	iShot® Retrieval Kit	92
Fishing Lanyard	10	Diesel Covers	52	iShot® 7mm OD Color Micro Camera	93
Glove Guard® Clips	11	High Temperature Fabrics	52	Micro CA-300 Explorer	93
Utility Bags	12	Welding Blankets and Curtains	53	The Micro CA-100	93
Parts Pouches	12	Welding Screens	53	Ridgid® Seesnake Accessories	93
Tech Cases	12	Insulated Welding Pads	53	Hawkeye® Articulating Borescope	94
Latitude Case	13	Catchment Tarps	54	Magnetic Trays	94
Eye Protection	13	Magnetic Mesh LP Blade Cover	54	Drill Magnet	94
Shield Goggle Protection	13	Versatarps	54	Magnetic Ruler	95
Cat Crap Optical Wear Care Kits	14	Leak Diverter	54	Magnetic Accessories	95
Chums® Eyeglass Retainers	14	Fire Retardant Debris Netting Roll Goods	55	Magnetic Pickup Tools	95
Classic Cotton	14	Fire Retardant Mesh Rolls	56	RFID	96
Floating Eyeglass Retainers	15	Cover Guard® Diamond Plate Floor Cover	56	Housekeeping	101
Camo Eyeglass Retainers	16	Hi-Temp Magnetic Covers	57	EZ-Wipes	102
Eyewear Cases	16	Stock Magnetic Drain Covers	57	Microfiber	102
Visor Clips	17	Griffolyn®	57	Nuclear Grade Wiping Cloth	103
Earplugs	17	Caps and Plugs Kits	58	HERMITEX® Nuclear Grade Wipers	103
Python Safety™	18	Pipe Plug Kit	58	The Multiple Applications Wipers	103
D-Rings	19	Inflatable Plugs	59	Low TiO2 Wiper	103
Quick Wrap Tape	20	Plug Accessories	60	F-AlphaWipe®	104
Tool Cinch Attachments	21	High Temp Hose and Bladder Protectors	60	Laundry Cart	104
Heat Shrink	22	Flow Stoppers	61	Tinted Tacky Mats	104
D-Ring Cord	22	Nylon Expansion Plugs	61	Tinted Plastics	105
Quick Spins	23	Cast Aluminum Expansion Plugs	62	Tinted Stretch and Shrink Wrap	106
Micro D-Ring Cord	23	Safe-T Sponge®	63	Color Tinted Stretch Wrap	106
Quick Rings	23	High Temperature Caps and Plugs	64	Color Tinted Easy Wrap	106
Bungee Tethers	24	FME Area & Zone Control	76	Shrink Wrap	106
Coil Tethers	25	FME Signs	77	Heavy Duty Handwrapper	107
Trigger2Trigger Lanyards	26	Magnetic FME Signs	77	VCI Anti-Rust Poly Sheeting	107
Heavy & Medium-Duty Tool Lanyards	26	Magnetic Signs	77	Tinted Document Covers and Binders	107
Holsters	27	Low Chloride Metal Markers	78	Document Pouches	108
Comfort Tool Belt	31	Stop Tags	78	Tinted PVC Tubing	108
Utility Tool Belt	31	Banners	78	Tinted Sleeving/ Lay Flat Tubing	108
Belt Loops	31	FME Magnetic Sheets	79	Welding	110
Small Parts Pouches	32	Nuclear Grade Duct Tape	79	Welding Fabrics	110
Tool Pouches	33	Barrier Tape	79	FME Brushes	110
Safe Buckets	35	FME Adhesive Floor Tape	80	Bristle Disc	111
Hard-Body Safe Bucket Insert	36	Pennant Lines	80		
Long Safe Buckets	36	Labels	80		
Wristbands	37	Hard Hat Labels	81		
FME Cabinets	38	Floating Cable Ties / Tie Wraps	81		
FME Alpha Double Decker	40	Speedwraps	81		
FME AlphaGrande Cabinet	40	Custom Printed Mats	82		
FME 1 Plus Cabinet	40	Hog Heaven II Modular	83		
FME 1 Cabinet	41	Comfort Tile	83		
FME 2 Cabinet	41	Comfort Tile with Grit	83		
FME 3 Drop Prevention Cabinet	41	Kneeling Comfort	83		

Culture Change

Change your culture with custom gear and safety mats! Call us to talk with one of our in-house designers.



F.O.S.A.R -Foreign Object Search and Retrieval

- Grasp objects inaccessible to human reach.
- All custom kits include a quick deployment case.



Part No.	Description
FME-EM14533	Catseye 6000 Video Fiberscope
FME-EM14540	Catseye Probe Assembly
FME-EM9063A	iSHOT® Catseye V-Probe Reel
FME-EM13987	iShot® iGrab™ RT-750 Complete ElectroMechanical Retrieval Tool Kit
FME-EM13988	iShot® iGrab™ RT-1000 FOSAR Complete ElectroMechanical Retrieval Tool Kit

NEW Python Safety® Products!

Part No.	Description
FL-HOL-BATTERY-LG	Python Battery Sleeve Holster Size: large
FL-VR-2ATTCHHD	Python VRing Dual Attachment Tool Cinch Heavy Duty. Load Rating 80lb (36.3kg) Patent Pending



Pennant Lines

- Pennant size is 12in. x 9in.
- Length of the pennant line is 60ft.
- We have many other tapes in stock. Call us for a Quote!

Part No.	Description
FME-TAPE-PEN5	Caution
FME-TAPE-PEN31	Black/Yellow Stripes
FME-TAPE-PEN49	Danger
FME-TAPE-PEN55	Danger Keep Out



DROP PREVENTION



Large Mobile Kits	6
Hard Hat Lanyard	6
Premium Wrist Lanyard	6
Economy Wrist Lanyard	7
Cold Shrink Tool Wraps	7
FME Neck Lanyards	8
Rubber Neck Lanyard	9
Neck Lanyard for Smart Cards	9
Fits All Phone Retention	9
Fire Retardant Chinstraps	10
Safe Box Cutter	10
Floating Lanyard	10
Fishing Lanyard	10
Glove Guard® Clips	11
Utility Bags	12
Parts Pouches	12
Tech Cases	12
Latitude Case	13
Eye Protection	13
Shield Goggle Protection	13
Cat Crap Optical Wear Care Kits	14
Chums® Eyeglass Retainers	14
Classic Cotton	14
Floating Eyeglass Retainers	15
Camo Eyeglass Retainers	16
Eyewear Cases	16
Visor Clips	17
Earplugs	17



Toolsaver® Drop Prevention Solutions

We custom design our FME kits and cabinets from craft feedback. Includes: Drop Prevention Lanyards and specific specialty FME tools. Call us let our expert team design a kit for you!

Small Portable Kits

Part No.	Description
FME-KIT-DP-ELEC	Electrician's Drop Prevention Kit
FME-KIT-FIELD2GO2	Field Drop Prevention Kit-2-Go
FME-KIT-MNTR2GO	FME Monitor Kit



Large Mobile Kits

Part No.	Description
FME-KIT-DP-TURB	Drop Prevention Turbine Kit
FME-KIT-DP-REF3	FME Drop Prevention Kit-2-Go for Refuel Floor
FME-KIT-MEC-2GO	Mechanical Workshop Drop Prevention Kit



Toolsaver® Lanyards

Hard Hat Lanyard

- Adjustable Non-conductive Hard Hat Lanyard
- Easily attaches and disengages from Hard Hats
- Holds eyeglasses, neck lanyards and ear plugs in place
- Plastic Glove Guard® safety clip securely attaches to clothing
- Built in elastic absorbs shock if hard hat is displaced
- Colors: Orange
- *Patent Pending



Part No.	Description	Qty.
*FME-LAN4INI-25PK	Hard Hat Lanyard	25 Pack
*FME-LAN4INI-100PK		100 Pack

Premium Wrist Lanyard -The Toolsaver®

Wrist lanyard with retractable Kevlar® cord, trigger, plastic grommet, and adjustable Velcro® comfort strap

Max Load: 2.9lb (1.32kg)

Part No.	Description
F-SSTOOLSVR-T	Premium Wrist Lanyardwith Trigger



Economy Wrist Lanyard

- Economy wrist lanyards feature non-conductive Velcro® straps and soft cords
- Different end options include: Clip, D-Ring, or Barrel Lock for light weight tools
- A floating version is also available for tethering cameras, EZ Wipes® and other wiping rags
- Max Load: 2lb (0.9kg)



	Part No.	Description	Qty.
A	FME-WRIST14C-10PK	Wrist Lanyard with cord and Clip	10 Pack
	FME-WRIST14C-25PK		25 Pack
B	FME-WRIST14BL-10PK	Wrist Lanyard with cord and Barrel Lock	10 Pack
	FME-WRIST14BL-25PK		25 Pack
C	FME-WRIST-D-10PK	Wrist Lanyard with D-Ring	10 Pack
	FME-WRIST-D-25PK		25 Pack
D	FME-WRIST-FLT-10PK	Floating Wrist Lanyard	10 Pack
	FME-WRIST-FLT-25PK		25 Pack

Cold Shrink Tool Wraps

- No heat source required to ensure a secure connection
- EPDM rubber resists acids, alkalis, and extreme temperatures
- Quick and easy way to create a strong attachment point

Part No.	Description
F-32TN19	Fits Shaft Dia. 3/4 to 1-1/2" (19x38mm)
F-32TN20	Fits Shaft Dia. 1-1/4 to 1-3/4" (32x44mm)
F-32TN21	Fits Shaft Dia. 1-3/4 to 2-1/2" (44x64mm)



FME Neck Lanyards

- Safety neck lanyards are non-conductive
- End options including: built in breakaway feature with basic, staggered, retractable, or rubber
- SP and Retractable Neck Lanyards are available in extra large sizes.
- EK Patent #D382,503
- Colors: Black, Royal Blue, Orange, Red
- *Badge Retractors contain conductive material*



End Part No.	Description	Qty.
A FME-LAN-EKSP-SE	14in(36cm) Nylon 5mm Lanyard with 1 Soft End	Each
B FME-LAN-EKSP-2SE	14in(36cm) Nylon 5MM Lanyard, with 2 Soft Nylon Cord Ends	Each
B FME-LAN-EKSP-2SE-XL	XL 17in(43cm) Nylon 5MM Lanyard with 2 Soft Nylon Cord Ends	Each
C FME-LAN-EKSP-2SSE	14in(36cm) Nylon 5MM Lanyard, with 2 Soft Nylon Cord Ends. Staggered Lengths	Each
C FME-LAN-EKSP-2SE/BR	14in(36cm) Nylon 5MM Lanyard, with 2 Ends, 1 Soft End & 1 Badge Retractor**	Each
D FME-LAN-EKSP-2SSE/BR	14in(36cm) Nylon 5MM Lanyard, with 2 Staggered Ends, 1 Soft End & 1 Badge Retractor**	Each
E FME-LAN-ACC-BR	Retractor Badge Lanyard Attachment** MINIMUM 250 pieces for custom printing	Each
F FME-LAN-EKSP-XTRA-SE	Extra Soft End that can be attached to lanyard	Each

Rubber Neck Lanyard

- Made from quality materials that are non-absorbent and dielectric
- Product is durable and easy to decontaminate
- Colors: Black

Part No.	Description
FME-LAN-RUB-BDG	Alphasource® Rubber Lanyard with breakaway badge retention loop



Neck Lanyard for Smart Cards

Part No.	Description
FME-LAN-EKPAT1	EK Patriot Breakaway neck lanyard with 1 detachable smart card holder
FME-LAN-EKPAT2	EK Patriot Breakaway neck lanyard with 2 detachable smart card holders



Alphasource® Badge Secure Lanyard for ED, TLD or Dosimeter

- Our Toolsaver® secondary attachment keeps badges and dosimeters in place
- Available in two designs: Badge Secure Lanyard and Badge Secure Lanyard with Clip
- Completely metal free components for decontamination
- Colors: Orange



B



	Part No.	Description	Qty.
A	FME-BDG-SEC1-OR-25PK	Badge Secure Lanyard	25 Pack
B	FME-BDG-SEC2-OR-25PK	Badge Secure Lanyard with Clip	25 Pack

Fits All Phone Retention

- Three option universal Phone Retention System
- Options include Neck Lanyard, Visor Clip/Belt clip, and Easel Stand
- The adhesive mount attaches to any device
- Made in the USA

Part No.	Description
FME-LAN-CELL-KIT	3 option universal Phone retention System



Fire Retardant Chinstraps for MSA Helmets

- Comfortable and adjustable chinstraps
- Keeps MSA helmets in their place
- Available in two styles: suspension-attached and shell-attached



Part No.	Description
FME-LAN-HH-CSTRP	Shell-attached Chinstraps for MSA helmets, 2-point Fire Retardant Nomex® webbing.
FME-LAN-HH-CSTRP3	Suspension-attached Chinstraps for MSA Vanguard helmets 3-point, 3/4in/19mm nylon webbing

Safe Box Cutter

- A recessed blade prevents contact with fingers
- Dual hook design lasts twice as long as single blade cutters
- Provides protection and durability
- Hi-Vis Colors: Orange, Red, and Yellow



Part No.	Description	Qty.
F-CUTSAFE-12PK	Safe Cutter	12 Pack
F-CUTSAFE-KR-12PK	Safe Cutter with Key ring	12 Pack

Floating Sports Lanyards

Floating Lanyards

- Built with bright red foam and TPU construction
- Keychain will float 1oz (28g) or about 2 keys



Part No.	Description	Qty.
F-CHUMS-FLT-KEY-10PK	Floating Keychain	10 Pack

Fishing Lanyard

Multiple clips and a retractor keep your most used tools handy so you don't have to fumble looking for your nippers. The retractor clips to your shirt or vest so it stays in place and doesn't dangle in your way. Foam padding helps dissipate the load around your neck.



Part No.	Description	Qty.
F-CHUMS-LAN-FISH-10PK	Fishing Neck Lanyard	10 Pack

Glove Guard® Clips



Glove Clip

- Glove Clip® has a proven record of reducing injuries and glove loss
- In stock Colors: Red, Orange, and Pink. Other colors available.

Part No.	Description	Qty.
F-PPECLIP-25PK	Glove Guard® Handi Clip Glove Holder	25 Pack
F-PPECLIP-100PK	Glove Guard® Handi Clip Glove Holder	100 Pack



Handi Klip®

- Utilizes a ball and socket joint that has a higher breakaway point
- Features oversized jaws to fit even the largest of gloves

Part No.	Description	Qty.
F-PPECLIP-XL-10PK	Handi Klip for Extra Large Gloves	25 Pack



Utility Guard®

- Innovative design uses the same clip as the Glove Guard® but includes a belt clip attachment
- In stock Colors: Orange
- Available Colors: Black, Blue, Green, Red, Off-white, and Yellow

Part No.	Description	Qty.
F-PPECLIP-UG-10PK	Utility Guard® Glove Clip	25 Pack



Utility Catcher®

- Keeps hard hats, extension cords, earmuffs, and much more nearby!
- Best Use: wear on a belt, hang on a wall or slide on a grid wall
- Colors: Black, Blue, Green, Red, Orange, Off-white and Yellow

Part No.	Description	Qty.
F-PPECLIP-UC-10PK	Utility Catcher Clip	25 Pack



Utility Bags

- Tote has an open weave design and a Velcro hook and loop closure
- Maximum visibility and breathability
- Perfect for gas monitors and hand tools
- Colors: Hi-Vis Orange

Part No.	Description
A F-UBMG7X10	Mesh Bag 7in x 10in
B F-UBMG5X8	Mesh Bag 5in x 8in
C F-UBMG3X5	Mesh Bag 3in x 5in

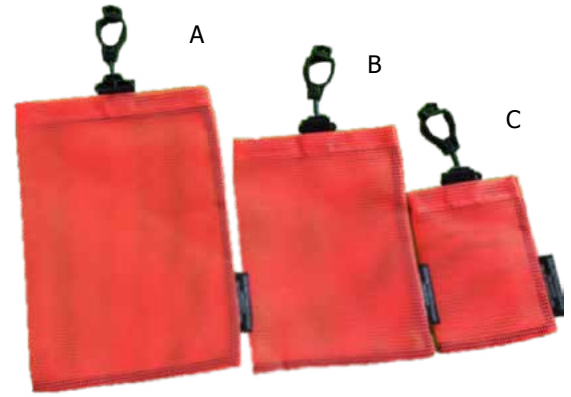

Parts Pouches

- Custom tools & parts pouches to prevent FME issues
- All pouches 400 Denier
- Custom printing and document pockets available
- Colors: Green and Yellow

Part No.	Description
F-PBXXS-GN	2in Diameter x 6in Depth Parts Bag
F-PBXS-GN	4in Diameter x 8in Depth Parts Bag
F-PBS-GN	6in Diameter x 10in Depth Parts Bag
F-PBM-GN	8in Diameter x 12in Depth Parts Bag
F-PBL-GN	12in Diameter x 18in Depth Parts Bag
F-PBXL-GN	18in Diameter x 24in Depth Parts Bag



Tech Cases



Part No.	Description	Size
A FME-CHUMS-PED-TAB	Tablet Case PED Case	8.75in x 11.25in x 1in
B FME-CHUMS-PED	Tech Case PED Case	5.75in x 3.75in x 1.5in
C FME-CHUMS-PED-PHON	Holster PED Case	5.25in x 3in x 1.25in
D FME-CHUMS-STRM-VB	Storm Series Voyager Bag	4.75in x 8in x 2.5in

Latitude Case



	Part No.	Size
A	FME-CHUMS-LAT-S	The Latitude5 Small Dimensions: 3.5in x 5.25in x 2in
B	FME-CHUMS-LAT-M	The Latitude7 Medium Dimensions: 4.5in x 7.25in x 2in
C	FME-CHUMS-LAT-L	The Latitude9 Large Dimensions: 5.5in x 9.25in x 2in

Eye Protection

- Removable Foam Lined Gasket.
- Polycarbonate lenses absorb 99.9% of UVA and UVB.
- Meets Requirements of CSA Z94.3-2007 and ANSI Z8.1-2010.



Part No.	Description
F-11872	Virtua™ CCS Protective Eyewear w/Foam Gasket, Clear Anti-Fog Lens 1
F-11874	CCS Safety Glasses With Blue And Clear Polycarbonate Frame, Silver Mirror Indoor/Outdoor Anti-Fog Lens And Foam Gasket Attachment

- Soft adjustable nosepads.
- Polycarbonate lenses absorb 99.9% of UVA and UVB.
- Meets Requirements of ANSI Z8.1-2010.



Part No.	Description
3MSF401AF	400 Series Protective Eyewear

Shield Goggle Protection

- Protection Impact
- Can be worn over most prescription eyeglasses
- Meets ANSI Z87.1+ Standards
- Materials: Polycarbonate lens, PVC frame, Neoprene headband, Polycarbonate shield



Part No.	Description
F-FS18629	Shield Goggle Protection

Cat Crap Optical Wear Care Kits

- Easy to use
- Ideal for cleaning and maintaining any optical wear

	Part No.	Description	Qty.
A	FME-EK-CATCARE1-12PK	Spray on Cat Crap, micro fiber cloth, and an optic screwdriver	12 Pack
	FME-EK-CATCARE1		Each
B	FME-EK-CATCARE2-12PK	Cat Crap lens cleaner/anti-fog balm, micro fiber cloth, and an optic screwdriver	12 Pack
	FME-EK-CATCARE2		Each



Chums® Eyeglass Retainers



Classic Cotton

- Original Standard style: 100% cotton
- Standard Text: "FME Starts with Me!" or "Tenacious FME Defense"
- Customizable with a minimum order of 100 units
- In Stock Colors: Orange, Pink, Red, and Blue
- Other colors: Camouflage REALTREE®, Mossy Oak Brands®, and Neoprene styles also available



Part No.	Description	Qty.
FME-CHUMS-25PK	"FME Starts With Me".	25 Pack
F-PPE-LAN-25PK	"FME Tenacious Defense"	25 Pack
FME-CHUMS-CSTM	Custom Text	

Floating Eyeglass Retainers

Floating Halfpipe

- High-visibility colors make these retainers easy to spot in water

Part No.	Description	Qty.
FME-CHUMS-FLT	Halfpipe light floats frames up to .17oz / 4.8g	Each
FME-CHUMS-FLTHPX	Halfpipe floats frames up to 1.1 oz / 32g	Each



Universal Fit Floating

- Sturdy nylon rope construction
- The closed-cell foam floater will float frames up to .7 oz. / 20 g.

Part No.	Description	Qty.
FME-CHUMS-FLT-XL	Universal Fit Floating, Nylon	Each
FME-CHUMS-FLT-XL2	Universal Fit Floating, Cotton	Each



Glassfloat Classic

- Fits most frames and will float up to 45g (1.5oz.)
- Perfect for all but the heaviest glasses
- The foam-filled woven poly is quick-drying and comfortable on the skin

Part No.	Description
FME-CHUMS-FLT-GF	Glassfloat Classic will float up to 45g (1.5oz.)



Neo Megafloat

- Increased temple size is designed for larger frames
- Filled with closed cell foam
- The lock-stitched ends give a tighter fit on your frames
- Will float up to 85 grams (3oz.)
- Colors: Yellow, Red, and Blue

Part No.	Description
FME-CHUMS-FLT-NEO-MGA	Float up to 85g (3oz.)



Camo Eyeglass Retainers



Part No.	Description
A	FME-CHUMS-OC-MO Mossy Oak® Pattern Universal Fit Singles
B	FME-CHUMS-OC-RT Original cotton with Realtree® Camo Pattern
C	FME-CHUMS-UF-RT Realtree® Universal Fit
D	FME-CHUMS-SF-RT Realtree® Slip Fit
E	FME-CHUMS-NEO-RT Realtree® Neoprene
F	FME-CHUMS-NEO-MO Neoprene Classic Mossy Oak®
G	FME-CHUMS-NEO-LE-RT Realtree® Pattern Neoprene Large End
H	FME-CHUMS-NEO-LE-MO Mossy Oak® Pattern Neoprene Large End

Eyewear Cases



Part No.	Description
A	FME-CHUMS-GOGGCSE Goggle Case
B	F-UBZU-EYEZIP Eyeglass Pouch
C	FME-CHUMS-TEC-MO Rigid Transporter Eyewear Case - Mossy Oak® pattern
D	FME-CHUMS-TEC-RT Rigid Transporter Eyewear Case - Realtree® pattern
E	FME-CHUMS-SHDE-MO Neoprene eyewear case Shade Shelter Mossy Oak® pattern
F	FME-CHUMS-SHDE-RT Neoprene eyewear case Shade Shelter Realtree® pattern

Visor Clips

	Part No.	Description
A	FME-CHUMS-GH-RT	Realtree® Glasshopper
B	FME-CHUMS-VC-MO	ChumBug Visor Clip



Earplugs

Molded Corded Earplugs With Blue Nylon Cord

Patented Conforming Material Technology™ adapts to the shape of the surrounding ear canal when in your ear, and returns the earplug to its original shape when removed. A single product can fit almost every wearer. Blue color provides high visibility in detection, metal ring on stem detectable by automated equipment [SmartFit Detectable only].

Part No.	Description	Qty.
HOWFHR12937-AC	Molded Corded Earplugs With Blue Nylon Cord	100 Pair/ Box



Polyurethane Foam Corded Earplugs With Metal Detectable Vinyl Cord

100% PVC-Free®, Highest independently tested NRR 33.

Extra-soft, low pressure foam for comfort and fit, tapered shape for easy insertion and removal

Non-irritating smooth surface.

Part No.	Description	Qty.
MOLW8264893-AC	Polyurethane Foam Corded Earplugs With Metal Detectable Vinyl Cord	100 Pair/ Box



D-Rings	19
Quick Wrap Tape	20
Tool Cinch Attachments	21
Heat Shrink	22
D-Ring Cord	22
Quick Spins	23
Micro D-Ring Cord	23
Quick Rings	23
Bungee Tethers	24
Coil Tethers	25
Trigger2Trigger Lanyards	26
Heavy & Medium-Duty Tool Lanyards	26
Holsters	27
Comfort Tool Belt	31
Utility Tool Belt	31
Belt Loops	31
Small Parts Pouches	32
Tool Pouches	33
Safe Buckets	35
Hard-Body Safe Bucket Insert	36
Long Safe Buckets	36
Wristbands	37



D-Rings

- D-rings can be attached to virtually any tool under 5 lbs. or 2 lbs. using our Quick-Wrap Tape.
- Creates an attachment point in less than a minute.
- Dual D-rings allow for 100% tool tie-off during tool transfers.

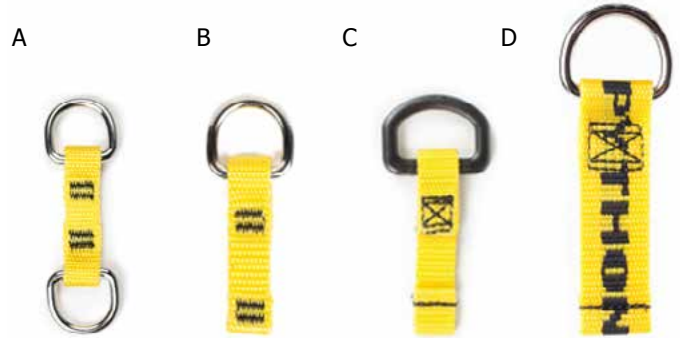

	Part No.	Dimensions	Load Rating	Qty.
A	FL-DDR-SMALL-10PK	0.5" x 2.25" (12.70 mm x 57.15 mm)	2 lbs. (0.9 kg)	10 Pack
	FL-DDR-SMALL-100PK			100 Pack
	FL-DR-0.5X2.25			Each
B	FL-DR-0.5X2.25-10PK	0.5" x 2.25" (12.70 mm x 57.15 mm)	2 lbs. (0.9 kg)	10 Pack
	FL-DR-0.5X2.25-100PK			100 Pack
	FL-DR-0.5X2.25NC			Each
C	FL-DR-0.5X2.25NC-10PK	0.5" x 2.25" (12.70 mm x 57.15 mm)	2 lbs. (0.9 kg)	10 Pack
	FL-DR-0.5X2.25NC-100PK			100 Pack
	FL-DR-1X3.5			Each
D	FL-DR-1X3.5-10PK	0.5" x 2.25" (12.70 mm x 57.15 mm)	5 lbs. (2.3 kg)	10 Pack
	FL-DR-1X3.5-50PK			50 Pack

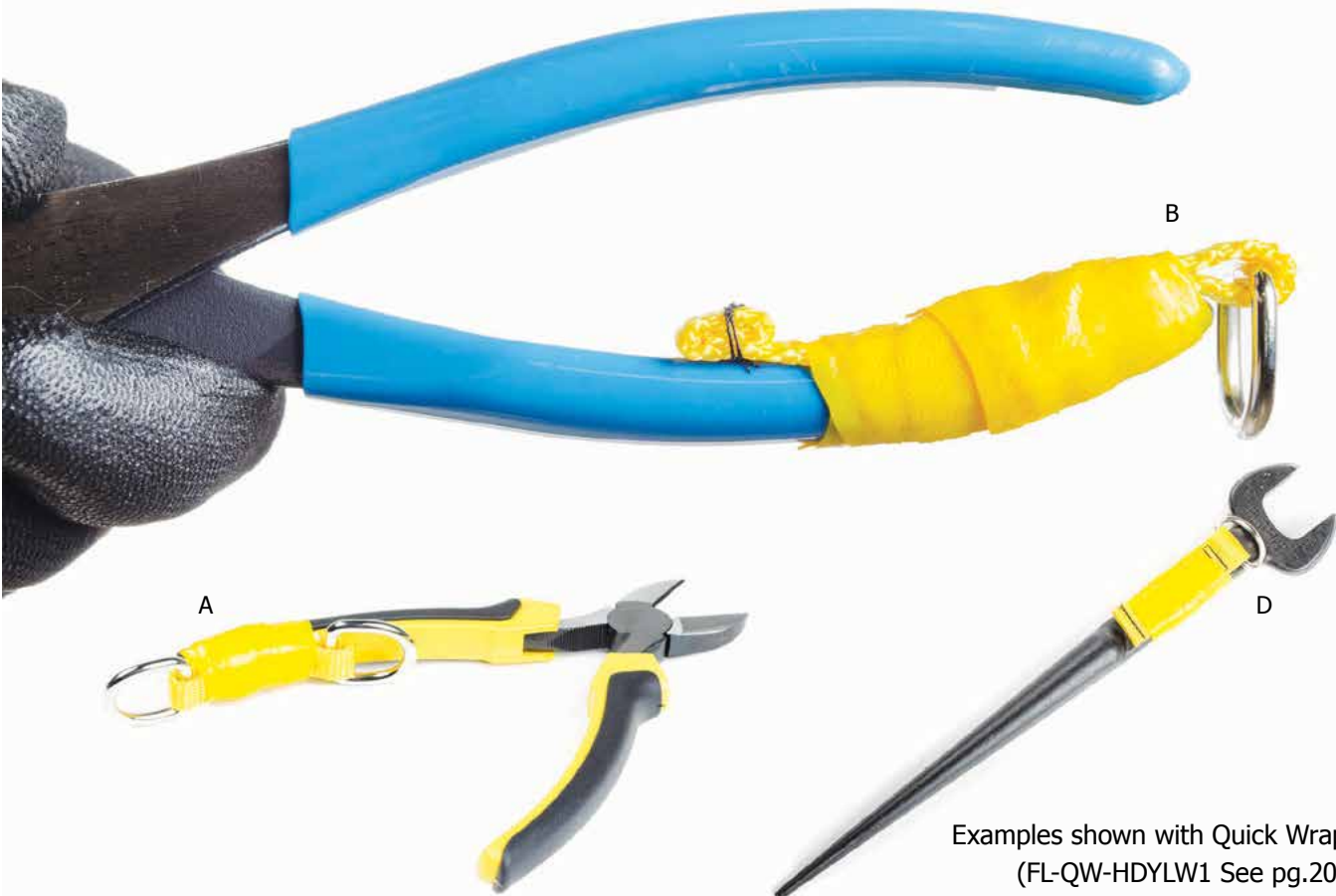

Examples shown with Quick Wrap Tape (FL-QW-HDYLW1 See pg.20)

Quick Wrap Tape

- Heavy duty 1 in. wide tape conforms to the shape of whatever it is applied to.
- Used with our D-Rings and Tool Cinch Attachments to create instant tethering points on virtually any tool.
- Made from a self-fusing silicone rubber that leaves no adhesive or residue behind.
- Inner fiberglass webbing increases the strength of the tape and makes the tape resistant to sharp objects.



Part No.	Length	Color	Qty.
FL-QW-HDBLU1	108" (274 cm)	Blue	Each
FL-QW-HDBLU1-10PK			10 Pack
FL-QW-HDBLU1-CASE			240 Case
A FL-QW-HDBLU1x2	108" (274 cm)	Blue	Each
FL-QW-HDBLU1x2-10PK			10 Pack
FL-QW-HDBLU1x2-CASE			120 Case
FL-QW-HDYLW1	216" (548.6 cm)	Yellow	Each
B FL-QW-HDYLW1-10PK			10 Pack
FL-QW-HDYLW1-CASE			240 Case



Quick Wrap Tape with D-Ring
(FL-DR-1X3.5 see pg.19)

Tool Cinch Attachments

- Tool Cinch Attachments feature a cinch design that allows users to quickly secure equipment up to 35 lbs. or 80 lbs.
- Stabilization wings can be used to keep Tool Cinch Attachments in place using Quick-Wrap Tape



	Part No.	Description	Load Rating	Qty.
A	*FL-VR-ATTACHMD	V-Ring attachment point	35 lbs. (15.9 kg)	Each
	*FL-VR-ATTACHMD-10PK			10 Pack
B	*FL-VR-1ATTACHMD	V-Ring attachment point, stabilization wing	35 lbs. (15.9 kg)	Each
	*FL-VR-1ATTACHMD-10PK			10 Pack
C	*FL-VR-2ATTACHMD	V-Ring attachment point, 2 stabilization wings	35 lbs. (15.9 kg)	Each
	*FL-VR-2ATTACHMD-10PK			10 Pack
D	*FL-VR-2ATTACHHD	V-Ring attachment point, 2 stabilization wings	80 lbs. (36.3 kg)	Each
	*FL-VR-2ATTACHHD-10PK			10 Pack



Shown with Quick Wrap Tape
(FL-QW-HDYLW1 See pg.20)



Shown with Bungee tether
(FL-EXT-H2LBUNGEE-MD See pg. 24)

Heat Shrink

- Protect your investment and connection point!
- Heat Shrink protects our Quick-Wrap Tape from abrasives and harsh work environments.
- Heat Shrink links reduce in size by 200% when heat is applied.



Part No.	Size	Qty.
FL-HS-0.75X1.75-25PK	0.75in x 1.75in (1.9 cm x 4.5 cm)	25 Pack
FL-HS-1X1.75-25PK	1in x 1.75in (2.5 cm x 4.5 cm)	25 Pack
FL-HS-1.5X2-25PK	1.5in x 2in (3.8 cm x 5.1 cm)	25 Pack
FL-HS-2X4-10PK	2in x 4in (5.1 cm x 10.2 cm)	10 Pack
FL-HS-3X4-10PK	3in x 4in (7.6 cm x 10.2 cm)	10 Pack

D-Ring Cord

- Easily cinches to tools weighing up to 5 lbs. (2.3 kg).
- Simply pass the loop end of a D-Ring Cord through a pre-drilled hole or closed handle to create an attachment point.
- Extremely durable and reusable.

Part No.	Load Rating	Qty.
*FL-DR-CORD	5 lbs. (2.3 kg)	Each
*FL-DR-CORD-10PK		10 Pack



Quick Spins

- Simply slides onto the handle of a tool in seconds.
- Swivel spin top makes them tangle resistant.
- Reusable and suitable for non-conductive use.

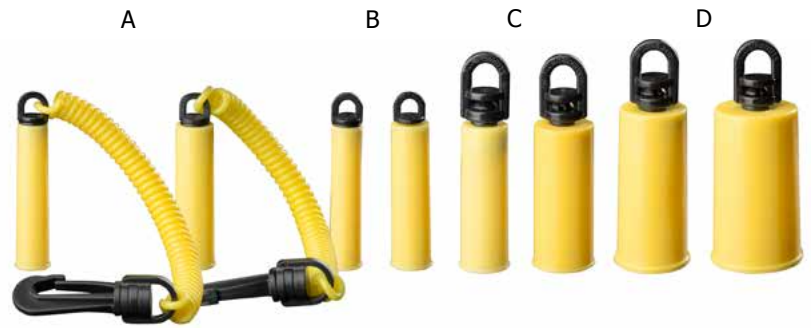

	Part No.	Description	Qty.
A	FL-QS-P-10PK	Pen Holder, 0.3in (0.8cm)	10 Pack
	FL-QS-PM-10PK	Permanent Marker Holder 0.5in (1.3cm)	10 Pack
B	FL-QS-PCOIL-10PK	Pen Holder with Coil attached	10 Pack
	FL-QS-PMCOIL-10PK	Permanent Marker Holder with Coil attached	10 Pack
C	FL-QS-S-10PK	Small, 0.6in (1.5cm)	10 Pack
	FL-QS-M-10PK	Medium, 0.8in (2cm)	10 Pack
D	FL-QS-L-10PK	Large, 1in (2.5cm)	10 Pack
	FL-QS-XL-10PK	X Large, 1.2in (3.1cm)	10 Pack



Micro D-Ring Cord

- Designed to allow for easy tethering of small devices such as cell phones, cameras and radios.
- Adheres to most surfaces creating an attachment point in seconds.
- Load rated for 2 lbs. when used with FL-EXT-C2LCOIL
- Uses 3M very high bond adhesive.



Part No.	Load Rating	Qty.
FL-DR-MICRO-10PK	2lb (0.9kg)	10 Pack

Quick Rings

- Quick Rings are an economical solution for tethering tools quickly.
- Allow many tools up to 2 lbs. to be made tether-ready.
- Ring pliers can be used to simplify quick ring installation.

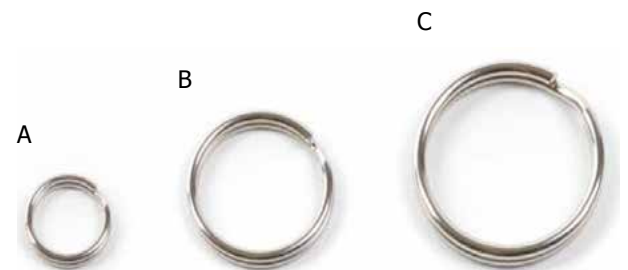

	Part No.	Size	Qty
A	FL-QR-00.75-25PK	0.75in (1.9cm)	25 Pack
B	FL-QR-01-25PK	1in (2.5cm)	25 Pack
C	FL-QR-01.5-25PK	1.5in (3.8cm)	25 Pack

Bungee Tethers



	Part No.	Load Rating	Length (relaxed)	Length (stretched)	Qty.
A	FL-EXT-H2LBUNGEE	15lb (4.5kg).	32 in. (81.3 cm)	47 in. (119.4 cm)	Each
	FL-EXT-H2LBUNGEE-10PK				
B	FL-EXT-H2LBUNGEE-MD	35lb (15.9kg).	31 in. (15.9 cm)	52 in (132.1 cm)	Each



Shown with Tool Cinch Attachments
(See pg.21)



Shown with Tool Cinch Attachments
(See pg.21)



Shown with Scaffold Wrench Holster
(FL- HOL-SCAFFCOMBO See pg.29)

Coil Tethers

Easy to clean and out of the way—exactly what a tether should be. The lightweight vinyl construction and ultra-compact design of our Coil Tethers makes them an ideal alternative to classic bungee tethers. Since we first introduced them to the marketplace, we've continued to refine and improve our line of coil lanyards with feedback from actual workers in the field.

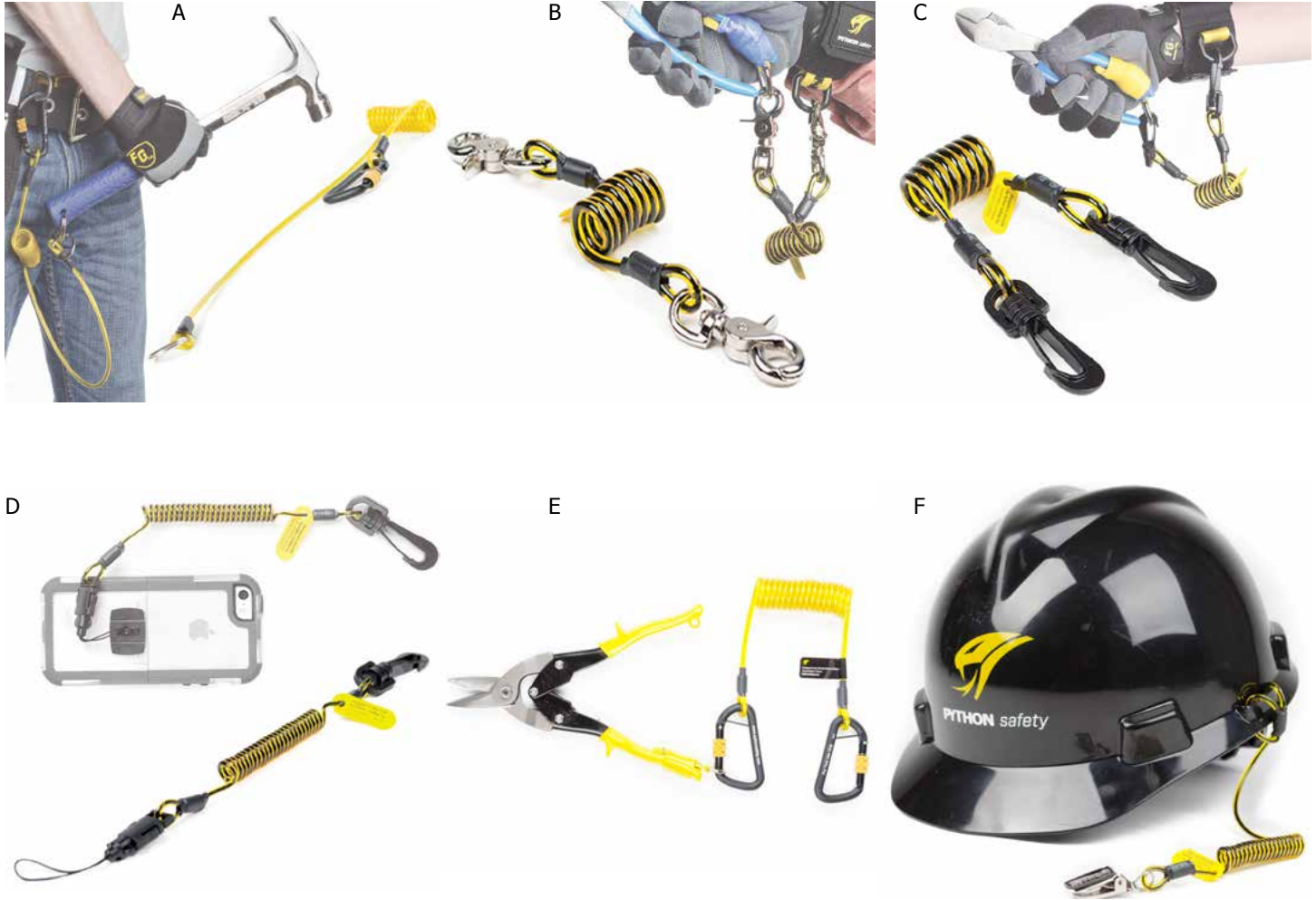

Part No.	Description	Length (relaxed)	Length (stretched)	Load Rating	Qty.	
A	FL-EXT-H2QRCOIL	Hook to Quick Ring Coil	3in (7.6cm)	62in (157.5cm)	2lb (0.9kg).	Each
	FL-EXT-H2QRCOIL-10PK					10 Pack
B	FL-EXT-T2TCOIL	Double Trigger Coil Extension	1.75in (4.4cm)	24in (70cm)	5lb (2.3kg).	Each
	FL-EXT-T2TCOIL-10PK					10 Pack
C	FL-EXT-C2CCOIL	Clip to Clip Coil Tether. Non-conductive	1.75in (4.4cm)	24in (70cm)	2lb (0.9kg).	Each
	FL-EXT-C2CCOIL-10PK					10 Pack
D	FL-EXT-C2LCOIL	Clip to Loop Coil Tether. Non-conductive	7in (17.8cm)	34in (86.4cm)	2lb (0.9kg).	Each
	FL-EXT-C2LCOIL-10PK					10 Pack
E	FL-EXT-H2HCOIL-10PK	Hook to Hook Coil Tether	4in (10.2cm)	62in (157.5cm)	5lb (2.3kg)	10 Pack
	FL-EXT-HARDHAT-10PK					Hard Hat Tether
F	FL-EXT-HARDHAT-100PK					

Trigger2Trigger Lanyards

- Thumb-controlled trigger snaps on both sides of these lanyards are easy to operate, even while wearing gloves.
- Trigger snaps swivel, making them tangle-resistant.



	Part No.	Description	Load Rating	Size	Qty.
A	FL-EXT-T2T0.5X36	Trigger to Trigger Lanyard.	10lb (4.5kg)	0.5in x 36in (1.27cm x 91.4cm)	Each
	FL-EXT-T2T0.5X36-10PK				10 Pack
B	FL-EXT-T2T0.5X24	Trigger to Trigger Lanyard.	10lb (4.5kg)	0.5in x 24in (1.27cm x 61cm)	Each
	FL-EXT-T2T0.5X24-10PK				10 Pack
C	FL-EXT-T2T0.5x12	Trigger to Trigger Lanyard.	10lb (4.5kg)	0.5in x 12in (1.27cm x 30.5cm)	Each
	FL-EXT-T2T0.5x12-10PK				10 Pack

Heavy & Medium-Duty Tool Lanyards

- Features an aluminum double-action twist-lock carabiner to prevent accidental opens.
- Works well with medium-duty tool cinch.

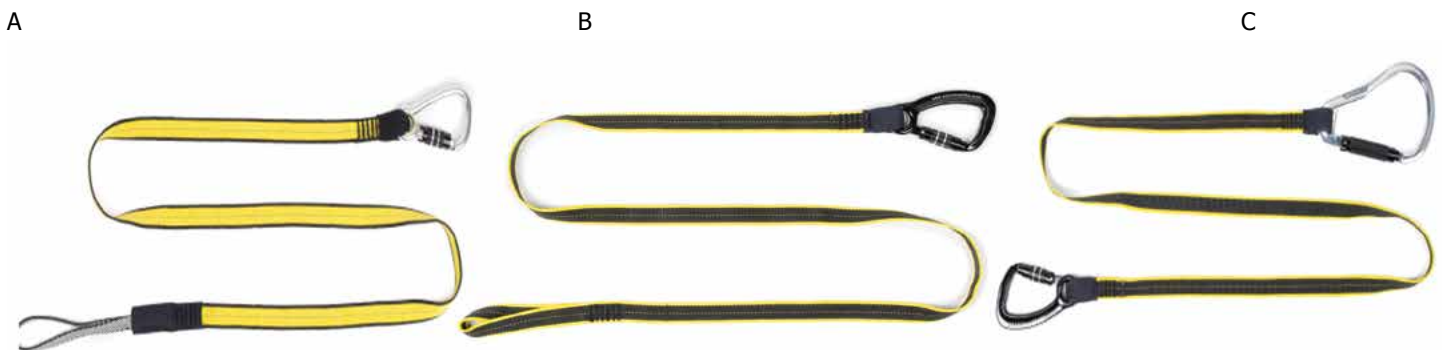

	Part No.	Description	Load Rating	Size
A	FL-EXT-H2L1X72MD	Hook to Loop Lanyard. Medium Duty.	35lb (15.88kg)	1in x 72in (2.5cm x 182.29cm)
B	FL-EXT-H2L1X72HD	The Heavy Duty Hook to Loop Lanyard.	80lb (36.3kg)	1in x 72in (2.5cm x 182.29cm)
C	FL-EXT-H2R1X72HD	The Heavy Duty Hook to Rail Tool Lanyard.	80lb (36.3kg)	1in x 72in (2.5cm x 182.29cm)

Holsters

Alphasource® & Python Safety® strive to make your job easier and safer. That's why our next-generation Smart Holsters™ are packed with intelligent new productivity features.

BEACON™ HI-VISIBILITY REFLECTORS

Products equipped with Python Safety® Beacon™ Hi-Visibility Reflectors are always easy to identify and locate, even when left in dark spaces. Highly reflective material is stitched into the front and back of the holster allowing it to be detected in low light conditions with a flashlight.



A FASTER, SMARTER WAY TO HOLSTER WITH QUICK-MAG™

Quick-Mag™ speeds up your workflow and reduces how often your tools need to be holstered. A powerful magnetic tool staging system allows tools to simply stick to the holster ensuring that your tools are always at the ready.



BOTTOM DRAIN VENT

Even in rainy weather conditions, holsters with a drain vent stay in outstanding working form. The vent helps keep the holster dry by allowing water to pass through, protecting your tools from rusting, and protecting your holster from dry rot.

Single and Dual Tool Holsters

- Single and Dual Tool Holsters are equipped with D-Rings that are load rated for 5lbs (2.3kg).
- Several variants of these holsters come with Python Safety Retractors (indicated below).
- Retractors are load rated for 1.5lbs (0.7kg).
- Single and Dual Tool Holsters feature Beacon™ Hi-Vis Reflectors and the Quick-Mag™ magnetic tool staging system.
- Single Tool Belt Holster Extra Deep dimensions: 8in x 3.5in (20cm x 8cm) for larger tools.
- A bottom drain vent allows the holster to work even in wet conditions.
- Neoprene pocket fits optional retractor.

*Patent Pending



Part No.	Description	Retractors	Belt / Harness
A	*FL-HOL-1TOOLHAR	None	Harness
B	*FL-HOL-1TOOLHARRET	1x	Harness
C	*FL-HOL-1TOOLBLT	None	Belt
D	*FL-HOL-1TOOLBLTRET	1x	Belt
E	*FL-HOL-1TOOLXD	None	Belt
F	*FL-HOL-2TOOLHAR	None	Harness
G	*FL-HOL-2TOOLHARRET	2x	Harness
H	*FL-HOL-2TOOLBLT	None	Belt
I	*FL-HOL-2TOOLBLTRET	2x	Belt

FL-EXT-H2LBUNGEE Tether and FL-DR-CORD Sold Separately

Tape Measure Holsters

- Designed to be used with virtually any tape measure, or the optional tape measure sleeve, allowing tape measures to be safely tethered and holstered.
- Includes a Retractor
- The tape measure sleeve conforms to the size of nearly every tape measure.
- Features Beacon™ High-Visibility Reflectors.

Part No.	Description
A *FL-HOL-TAPERET	Tape Measurer Holster with Retractor
B *FL-HOL-TAPESLEEVE	Tape Holster Sleeve
A+B *FL-HOL-TAPECOMBO	The Tape Holster with Retractor and Sleeve Combo



Pouch Holster with Retractor

- Quickly holster tape measures and other small tools.
- Includes a retractor

Part No.	Description
*FL-HOL-POUCHRET	Pouch Holster with Retractor



Scaffold Wrench Holster with Retractor

- Quickly holster scaffold wrenches while working at height.
- Features Beacon High-Visibility Reflectors.

Part No.	Description
*FL-HOL- SCAFFWRET	Scaffold Wrench Holster with Retractor
*FL- HOL-SCAFFCOMBO	Scaffold Wrench Holster Combo



Hammer Holster

- The Hammer Holster allows for the safe holstering of virtually any hammer under 5 lbs.
- D-ring on the side of the holster is load rated for 5 lbs. (2.3 kg).
- The combo comes with a Hook2Quick Ring Coil Tether that is specially designed for use with the Hammer Holster. The Hook2Quick Ring Coil Tether is load rated for 2 lbs. (0.9 kg).
- During transport, the Hammer Holster can be locked shut with a hook and loop strap. While being used, the strap can be locked up allowing for easy hammer access and holstering.



Part No.	Description
*FL-HOL-HAMMER	Hammer Holster for Belt
*FL-HOL-HAMMERCOMBO	Hammer Holster & Hook2Quick Ring Coil Tether

Adjustable Radio Holster

- Holster adjusts to fit virtually any hand-held radio, cell phone, and many other devices.
- Can be worn from belt or harness.
- A Micro D-Ring can be placed on the back of a device, and can then be tethered to a D-ring on the front of the Adjustable Radio Holster using a Clip2Loop Coil Tether



Part No.	Description
*FL-HOL-ADJRADIO	Adjustable Radio Holster
*FL-HOL-ADJRADIOCOMBO	Adjustable Radio Holster, Clip to Loop Coil Tether and Micro D-Ring

Battery Holster/Sleeve

- Unique sleeve design conforms to the size of virtually any drill battery.
- Sleeve is cinched to the drill, allowing the drill to be tethered off while being used at height.
- 10 lb. (4.5 kg) load rating.



Part No.	Description
FL-HOL-BATTERY-LG	The Battery Sleeve

Spray Can/Bottle Holster

- Flexible neoprene holster allows for quick tethering of bottles and spray cans.
- Comes with Clip2Clip Coil Tether

Part No.	Description
*FL-HOL-BOTTLE	Spray Can/Bottle Holster
*FL-HOL-BOTTLECOMBO	Spray Can/Bottle Holster and Clip2Clip Coil Tether



Comfort Tool Belt

- Extra padding provides superior comfort compared to many other tool belts.
- Modular approach allows user to customize their own holster and pouch system.

Part No.	Description	Size
FL-BELT-COMFORT-S-M	Size Small - Medium,	(28in - 36in) (71cm - 91cm)
FL-BELT-COMFORT-L-XL	Size Large	(36in - 44in) (91cm - 112cm)
FL-BELT-COMFORT-2XL-3XL	Size 2XL-3XL	(44in - 52in) (112cm - 132cm)



Utility Tool Belt

- Padded Cordura provides for durability and comfort.

Part No.	Size
FL-BELT-UTILITY-SL	28-46in (71-117cm)
FL-BELT-UTILITY-XL	40-54in (102-137cm)



A

B

Belt Loops

- Used for tying off tools from a belt, while the
- Used for staging tools.

	Part No.	Description	Load Rating	Qty.
A	FL-BELT-DRLOOP	Belt Loop D-Ring,	5 lbs. (2.3kg)	Each
	FL-BELT-DRLOOP-10PK			10 Pack
B	FL-BELT-TRLOOP	Belt Loop Trigger	5 lb (2.3kg)	Each
	FL-BELT-TRLOOP-10PK			10 Pack



Small Parts Pouches

Patent# D675,440

- Innovative self-closure system traps objects inside, making it nearly impossible for objects to fall out once placed in the bag.
- Easy to retrieve objects since no opening or closing is necessary.
- Compatible with most tool belts.



Belt loops located on back of pouch.

Part No.	Description
A	FL-PCH-PARTSXD-CB The Extra-Deep Small Parts Pouch, Canvas Black
B	FL-PCH-PARTS-CO Small Parts Pouch, Canvas Orange
C	FL-PCH-PARTS-CC Small Parts Pouch (Belt), Canvas Camo
D	FL-PCH-PARTS-VY Small Parts Pouch, Yellow Vinyl
E	FL-PCH-PARTS-CB Small Parts Pouch, Canvas Black

Tool Pouches

- Constructed from a heavy-duty canvas with an inner lining to help prevent punctures.
- Multiple inner pockets accommodate a number of tools while an integrated D-ring makes tethering tools incredibly easy.
- Available in standard and extra-deep variations.
- The standard pouch uses a hook and loop closure system that can be locked open during use.
- The extra-deep Tool Pouch features a magnetic closure system as well as a side-release buckle.



	Part No.	Load Rating	Size	Retractors/triggers
A	FL-PCH-TOOLTRIG	5lb (2.27kg)	7.5in x 11in x 5in (19cm x 27cm x 12cm)	2 triggers
	FL-PCH-TOOLXDTRIG	5lb (2.27kg)	8.75in x 13in x 5in (22cm x 33cm x 12cm)	2 triggers
B	FL-PCH-TOOLRET	5lb (2.27kg)	7.5in x 11in x 5in (19cm x 27cm x 12cm)	2 retractors
	FL-PCH-TOOLXDRET	5lb (2.27kg)	8.75in x 13in x 5in (22cm x 33cm x 12cm)	2 retractors
C	FL-PCH-TOOL	5lb (2.27kg)	7.5in x 11in x 5in (19cm x 27cm x 12cm)	-
	FL-PCH-TOOLXD	5lb (2.27kg)	8.75in x 13in x 5.00in (22cm x 33cm x 12cm)	-

Tool Pouches

A



B



C

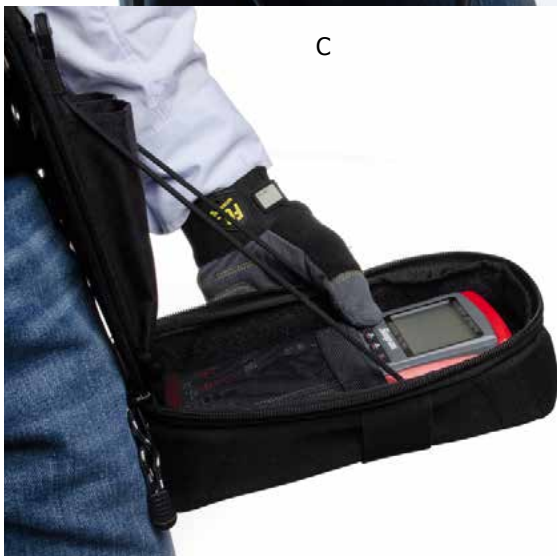

D



Part No.	Description
A FL-PCH-UTILITY	Python Safety's® Utility Pouch has 2 side wing holsters designed for working at height with spud wrenches and sleeve bars. Includes side-release closure system, 2 welded D-Rings on front of pouch, belt loop on back of the pouch, heavy-duty 22oz. (0.6kg) cotton duck fabric.
B FL-PCH-UTIL-ZIP	Utility Pouch with Zipper. Canvas style utility pouch. Two outside and inside pockets. Tether ready built-in rings. Zipper closure system.
C FL-PCH-INSPECT	The Python Safety® Inspection Pouch is designed for the safe transport and use of most multi-meters, air monitors, and other portable testing devices. Three Tool Pockets inside the pouch are perfect for tools and testing probes. Tools can be tied off to a D-Ring inside the pouch or a D-Ring located on either side of the back of the pouch. Adjustable. *Patent Pending
D FL-PCH-HNGR	Tool bag hanger for ExoFit STRATA™ harnesses. Attaches to most tool bags and pouches. Simple pivoting and a pass-through design provides fast and easy installation. Lightweight aluminum construction. 40lb (18.1kg) loadrating. <i>Bag not included.</i>

Safe Buckets

With an integrated closure system that helps prevent dropped objects, our Safe Buckets are designed to be the perfect companion for workers at height carrying heavy loads.



	Part No.	Load rating	Closure system	Material	Height/diameter	Capacity
A	*FL-BKT-100HLC-5G	100lb (45kg)	Hook and Loop	Canvas	15in/12.5in (38cm/32cm)	1840 in ³ (4673cm)
	FL-BKT-100HLC	100lb (45kg)	Hook and Loop	Canvas	15in/12.5in (38cm/32cm)	1840 in ³ (4673cm)
B	FL-BKT-100DRAWC	100lb (45kg)	Drawstring	Canvas	15in/12.5in (38cm/32cm)	1840 in ³ (4673cm)
	FL-BKT-250HLV	250lb (113kg)	Hook and Loop	Vinyl	15in/12.5in (38cm/32cm)	1840 in ³ (4673cm)
C	FL-BKT-250DRAWV	250lb (113kg)	Drawstring	Vinyl	15in/12.5in (38cm/32cm)	1840 in ³ (4673cm)

Closure systems

Every Safe Bucket features either a unique, patent-pending drawstring or a locking hook and loop closure system that acts as an extra layer of spill-protection during transport and lifting. Colorful indicator tabs provide quick visual cues to indicate whether the bucket is in lockdown mode or easy-access mode.

Hook & Loop Closure



Drawstring Closure



Hard-Body Safe Bucket Insert

- Converts a standard soft-body Safe Bucket into a hard-body Safe Bucket.
- Reusable hard-body Safe Bucket insert keeps your Safe Bucket standing upright, making it easier to stage tools and stay productive.
- Integrated inner pockets allow tools to be holstered and organized quickly.



Part No.	Description
FL-BKT-HBINSERT	Hard-Body Safe Bucket Insert

Long Safe Buckets

- Transport scaffolding and longer tools safely and easily with our Long Safe Buckets.
- More effective than hand-to-hand transportation or using rope with hitch knots.
- Hook and loop top closure system keeps poles secure during lift.
- Equipped with a double twist-action locking carabiner for maximum safety.



Part No.	Length	Closure system	Load rating
FL-BKT-100HLC4	48in (122cm)	Hook and loop	100 lbs. (45.4 kg)
FL-BKT-100HLC6	72in (183cm)	Hook and loop	100 lbs. (45.4 kg)
FL-BKT-100HLC10	120in (305cm)	Hook and loop	100 lbs. (45.4 kg)

Pullaway Wristbands

Pullaway wristbands are designed for those who work around rotating or moving equipment. They feature an elastic strap to conform to the wearer's wrist size automatically and come in standard and slim variants.

Part No.	Description	Qty.
FL-WB-SLIM-S	Small Pullaway Wristband Slim	Each
FL-WB-SLIM-S-10PK		10 Pack
FL-WB-SLIM-M	Medium Pullaway Wristband Slim	Each
FL-WB-SLIM-M-10PK		10 Pack
FL-WB-SLIM-L	Large Pullaway Wristband Slim	Each
FL-WB-SLIM-L-10PK		10 Pack
FL-WB-S	Small Pullaway Wristband	Each
FL-WB-S-10PK		10 Pack
FL-WB-M	Medium Pullaway Wristband	Each
FL-WB-M-10PK		10 Pack
FL-WB-L	Large Pullaway Wristband	Each
FL-WB-L-10PK		10 Pack



Adjustable Wristbands



Adjustable Wristband

Our adjustable wristband uses a hook and loop system to adjust to any wrist size. An elastic band helps ensure a comfortable fit.



Adjustable Wristband with Cord

Adjusts to any wrist size using a hook and loop system. A built-in cord is used to quickly attach and stage tools directly to the wristband.



Adjustable Wristband with Retractor

Adjusts to any wrist size. A built-in retractor with an attached trigger can be used to quickly work with many hand tools.

	Part No.	Description	Load rating	Qty.
A	FL-WB-ADJ	Adjustable Wristband.	5lb (2.3kg)	Each
	FL-WB-ADJ-10PK			10 Pack
B	FL-WB-ADJCORD	Adjustable Wristband with Cord.	5lb (2.3kg)	Each
	FL-WB-ADJCORD-10PK			10 Pack
C	FL-WB-ADJRET	Adjustable Wristband with Stainless Steel Retractor and Trigger.	1.5lb (0.68kg)	Each
	FL-WB-ADJRET-10PK			10 Pack



FME 1 PLUS CABINET

FME Alpha Double Decker	40
FME AlphaGrande Cabinet	40
FME 1 Plus Cabinet	40
FME 1 Cabinet	41
FME 2 Cabinet	41
FME 3 Drop Prevention Cabinet	41
FME 4 Cabinet	42
FME 5 Cabinet	42
FME 6 Cabinet	42



HOW TO CUSTOM ORDER

Step 1

Choose the cabinet style
Example: FME-CAB-AG

Step 2

Choose the stocked contents that are right for your specific program.
Example: FME-CAB-AG-WH*

Step 3

Choose the color.
Available Colors: Red, Orange, Green, Pink, Yellow and Gray
Example: FME-CAB-AG-WH-OR



Example part number for a FME AlphaGrande Warehouse Cabinet in the color orange:
FME-CAB-AG-WH-OR

Stocked Contents

Part Number	Description
STD-*	The Original includes covers, caps, plugs, tape, tarps, magnetic sheets, lanyards
DEL-*	The Deluxe, Standard plus mesh & magnetic covers and lanyards
DIES-*	Diesel Cabinet with Custom Covers
ELEC-*	Electrical cabinet with custom breaker covers
DP-*	Drop Prevention Supplies Stocked Cabinet
DP-DLX-*	Drop Prevention Supplies Deluxe Cabinet
BNS-*	Empty Cabinet w/ Bins
FAB-*	Fab Shop
FOSS-*	Fossil
I&C-*	I & C
MECH-*	Mechanical Maintenance
OPS-*	OPS Tag Out
PIPE-*	Pipe Fitter
REF-*	Refuel
SFTY-*	Safety Cabinet
SPEC-T-*	Training
TURB-*	Turbine
TURB-G-*	Gas Turbine Cabinet Kit
TURB-S-*	Steam Turbine Cabinet
VAL-*	Valve
V&P-*	Valve & Pipe
WH-*	Warehouse
WELD-*	Welding

FME Alpha Double Decker

Shelves are stacked on top of a drawer cabinet for maximum storage
 Forklift pockets for easy mobility
 The biggest cabinet we offer!!!
 Lead time 6-8 weeks



Part No.	Size	Size (metric)
FME-CAB-DD	56in W x 28in D x 88in H	143cm x 72cm x 224cm

FME AlphaGrande Cabinet

Our biggest double wide cabinet for maximum storage
 Includes eight heavy duty drawers
 Contains a huge variety of FME products
 Forklift pockets for easy mobility
 Also available without drawers
 In stock Colors: Red and Orange



Part No.	Size	Size (metric)
FME-CAB-AG	60in W X 36in D X 78in H	152.4cm x 91.4cm x 198cm

FME 1 Plus Cabinet

Our newest Alphasource® original design
 The bins rack in the back of the cabinet
 Has the depth to hold the larger door bins used in the AlphaGrande
 Forklift Pockets for easy mobility
 In stock Colors: Red and Orange



Part No.	Size	Size (metric)
FME-CAB1P	36in W X 30in D X 78in H	91.4cm x 76.2cm x 198cm

FME 1 Cabinet

The original FME cabinet
 Most economical storage solution for your FME supplies
 Forklift pockets for easy mobility
 In stock Colors: Red, Orange, and Pink

Part No.	Size	Size (metric)
FME-CAB1	36in W X 24in D X 78in H	91.4cm x 61cm x 198cm



FME 2 Cabinet

Large mobile cabinet with wheels and drawers
 Stocked with caps, plugs, FME covers, EZ-Wipes, and Drop prevention products
 Call and customize to meet your specific needs
 Lead time 6-8 weeks
 Colors: Gray, Red, Light Blue, Dark Blue, Orange, Green, Pink

Part No.	Size	Size (metric)
FME-CAB2	56.5in W X 28.5in D X 39.4in H	143.5cm x 72.4cm x 100.1cm



FME 3 Drop Prevention Cabinet

Alphasource original design
 Extra-wide counter height cabinet with racking bins, locking casters
 Forklift pockets for easy mobility
 In stock Colors: Red, Orange, and Pink

Part No.	Size	Size (metric)
FME-CAB3-DP	48in W X 24in D X 49in H	122cm X 61cm X 124.5cm



FME 4 Cabinet

Counter height cabinet used for mobile storage and smaller distribution locations
Efficient design has stacked bins in the cabinet body, locking casters, and small bins on the doors

Wheels for quick mobility
In stock Colors: Red and Orange
Other: Pink



Part No.	Size	Size (metric)
FME-CAB4	36in W X 24in D X 49.5in H	91.4cm x 61cm x 125.7cm

FME 5 Cabinet

A one-stop supply station for all of your FME needs
Custom drawer configuration
Wheels for quick mobility
Lead time 6-8 weeks
Suggested application: Deluxe Drop Prevention Cabinet
Colors: Gray, Red, Light Blue, Dark Blue, Orange, Green, Pink



Part No.	Size	Size (metric)
FME-CAB5-DP	33.5in W x 22.5in D x 40.25in H	106cm x 57cm x 85.1cm
FME-CAB5-DPDLX	56.5in W X 28.5in D X 39.4in H	143.5cm X 72.4cm X 100.1cm

FME 6 Cabinet

Small, mobile, and economical FME Drop Prevention Cabinet
Wheels for quick mobility
Customize the FME 6 to meet your specific needs
Call us for available colors

Part No.	Description
FME-CAB6DP	FME Drop Prevention Cabinet





Custom FME Controls	44
FME Covers	46
FME Mesh Nylon Cover with Pocket	46
FME Mesh Covers	47
FME Disposable Bags	47
FME Outdoor Storage/Warehouse Covers	48
FME Hi-Temp Silicone Covers	49
FME Tarps	49
FME Mesh & Magnetic Tarps	50
FME Magnetic Round Covers	51
FME Mesh Magnetic Round Covers	51
Diesel Covers	52
High Temperature Fabrics	52
Welding Blankets and Curtains	53
Welding Screens	53
Insulated Welding Pads	53
Catchment Tarps	54
Magnetic Mesh LP Blade Cover	54
Versatarps	54
Leak Diverter	54
Fire Retardant Debris Netting Roll Goods	55
Fire Retardant Mesh Rolls	56
Cover Guard® Diamond Plate Floor Cover	56
Hi-Temp Magnetic Covers	57
Stock Magnetic Drain Covers	57
Griffolyn®	57
Caps and Plugs Kits	58
Pipe Plug Kit	58
Inflatable Plugs	59
Plug Accessories	60
High Temp Hose and Bladder Protectors	60
Flow Stoppers	61
Nylon Expansion Plugs	61
Cast Aluminum Expansion Plugs	62
Safe-T Sponge®	63
High Temperature Caps and Plugs	64

Custom FME Controls

Good FME Solutions are not always a one size fits all. Our expert FME team will use our experience with Industry OE (Operating Experience) to design the best solution for your plant. Call for custom solution.

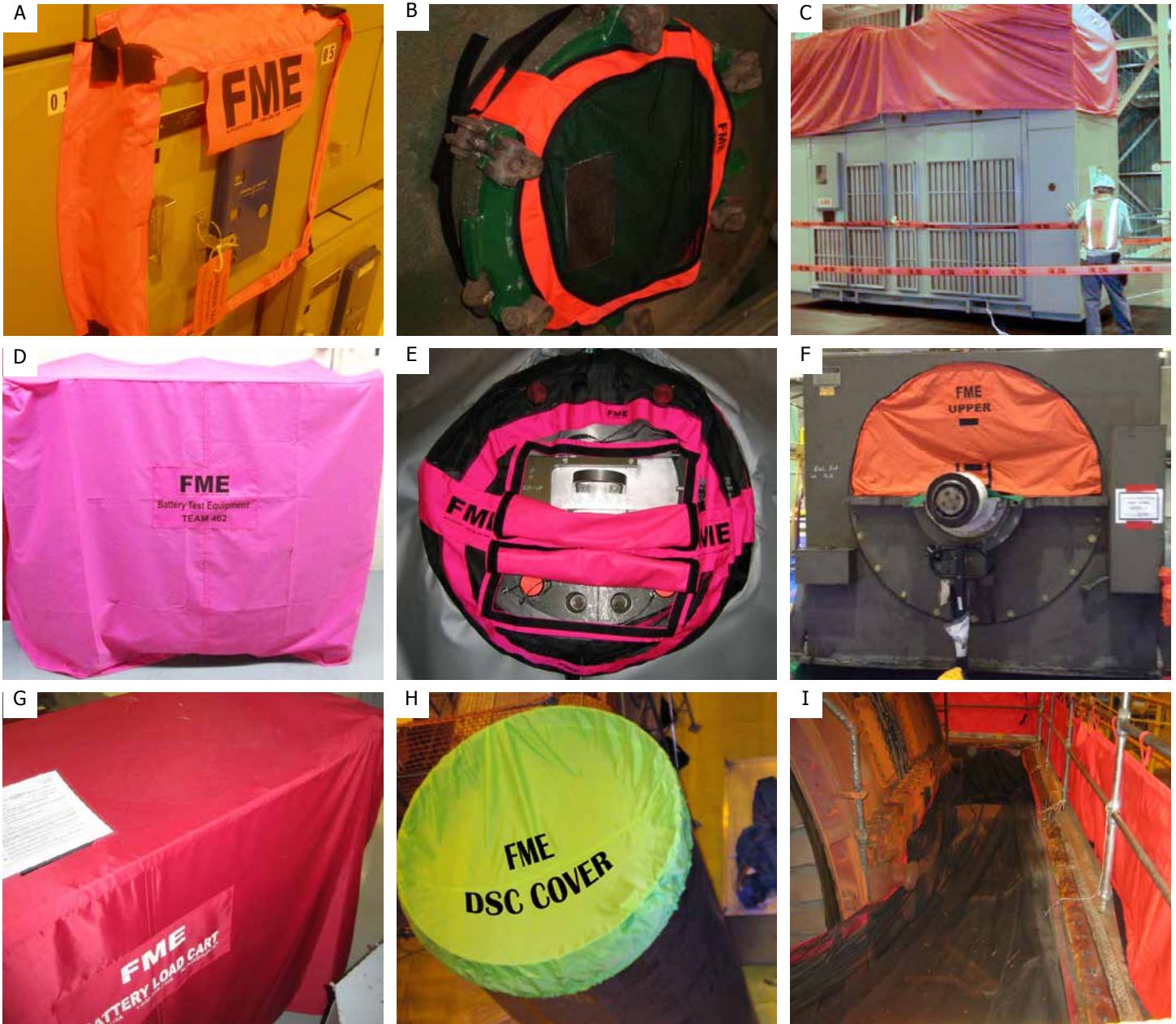

A	Racking Breaker Cover
B	Magnetic Condenser or Manway Cover
C	Transformer Cover
D	Battery Test Equipment Covers with Team Number
E	Steam Generator Manway Cover
F	Generator & Alterex Cover
G	Battery Load Cart Cover
H	Dry Storage Cask Cover
I	Turbine Catchnet

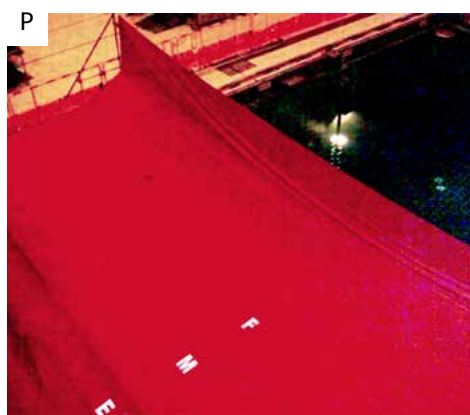

J	Magnetic Tarps and Handrail Covers
K	Variable Frequency Drive Cover
L	Diesel Cover
M	Ground Cart Cover with Fire Retardant Clear Panel
N	Custom Hand Rail Cover
O	Condenser Tube Bundle Cover
P	Spent Fuel Pool Cover
Q	Load Center Cover
R	New Fuel Storage

FME Covers

FME Covers are used for pipe and component covers in the plant.
 Add color code to part number to designate color choice.
 Colors: Orange (-OR), Red (-RED), Pink (-PK), Green (-GN)

Part No.	Size	Part No. (Metric)	Size (Metric)
FME-TUBECVR	1in Diameter	FME-25MM	25mm Diameter
FME-2	2in Diameter	FME-50MM	50mm Diameter
FME-4	4in Diameter	FME-100MM	100mm Diameter
FME-6	6in Diameter	FME-150MM	150mm Diameter
FME-8	8in Diameter	FME-200MM	200mm Diameter
FME-10	10in Diameter	FME-250MM	250mm Diameter
FME-12	12in Diameter	FME-300MM	300mm Diameter
FME-15	15in Diameter	FME-400MM	400mm Diameter
FME-18	18in Diameter	FME-450MM	450mm Diameter
FME-24	24in Diameter	FME-600MM	600mm Diameter
FME-30	30in Diameter	FME-750MM	750mm Diameter
FME-36	36in Diameter	FME-900MM	900mm Diameter
FME-40	40in Diameter	FME-1000MM	1000mm Diameter
FME-48	48in Diameter	FME-1250MM	1250mm Diameter

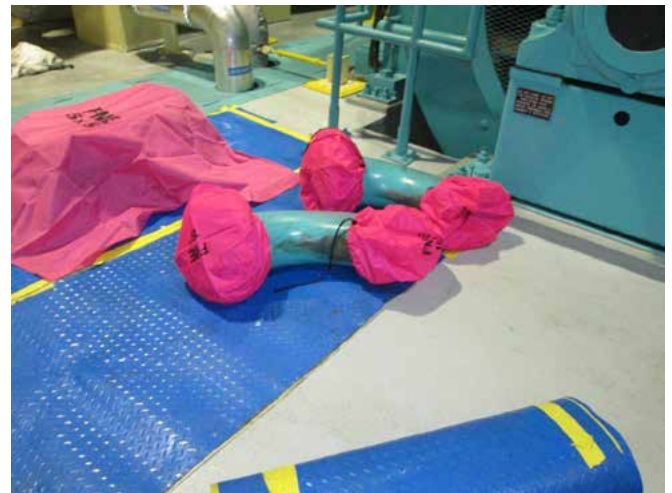

FME Mesh Nylon Cover with Pocket

FME Mesh Bags with Pocket Nylon Covers. Keep your caps safe in the large outside pocket on this 2 in diameter mesh bag.

Add color code to part number to designate color choice.

Available Colors: Orange (-OR), Red (-RED), Pink (-PK), Green (-GN), Yellow (-Y)

Part No.	Size	Part No. (Metric)	Size (Metric)
FME-V2-POC	2 in Diameter	FME-V50MM-POC	50 mm Diameter



FME Mesh Covers

FME Mesh Fabric Covers provide a breathable pipe cover to allow for airflow.

Add color code to part number to designate color choice.

Colors: Orange (-OR), Red (-RED), Pink (-PK), Green (-GN), Yellow (-Y)

Part No.	Size	Part No. (Metric)	Size
FME-V1	1in Diameter	FME-V25MM	25mm Diameter
FME-V2	2in Diameter	FME-V50MM	50mm Diameter
FME-V4	4in Diameter	FME-V100MM	100mm Diameter
FME-V6	6in Diameter	FME-V150MM	150mm Diameter
FME-V8	8in Diameter	FME-V200MM	200mm Diameter
FME-V10	10in Diameter	FME-V250MM	250mm Diameter
FME-V12	12in Diameter	FME-V300MM	300mm Diameter
FME-V15	15in Diameter	FME-V400MM	400mm Diameter
FME-V18	18in Diameter	FME-V450MM	450mm Diameter
FME-V24	24in Diameter	FME-V600MM	600mm Diameter
FME-V30	30in Diameter	FME-V750MM	750mm Diameter
FME-V36	36in Diameter	FME-V900MM	900mm Diameter
FME-V40	40in Diameter	FME-V1000MM	1000mm Diameter
FME-V48	48in Diameter	FME-V1250MM	1250mm Diameter



FME Disposable Bags

More cost effective compared to nylon, multiple uses and no metal components.

Add color code to part number to designate color choice.

Colors: Orange (-OR), Red (-RED), Pink (-PK)

Part No.	Size	Size (Metric)
FME-1-DISP	1 in Diameter	25 mm Diameter
FME-2-DISP	2 in Diameter	50 mm Diameter
FME-4-DISP	4 in Diameter	100 mm Diameter
FME-6-DISP	6 in Diameter	150 mm Diameter
FME-10-DISP	10 in Diameter	250 mm Diameter
FME-12-DISP	12 in Diameter	300 mm Diameter
FME-15-DISP	15 in Diameter	400 mm Diameter
FME-18-DISP	18 in Diameter	450 mm Diameter
FME-24- DISP	24 in Diameter	600 mm Diameter
FME-30-DISP	30 in Diameter	750 mm Diameter
FME-36-DISP	36 in Diameter	900 mm Diameter
FME-38-DISP	38 in Diameter	950 mm Diameter



FME Outdoor Storage/Warehouse Covers

Material has built-in UV resistance, Fire retardant, Waterproof, and Easily Decon/cleaned.

Optional Mesh on the top of the cover to release pipe condensation.

Temperature Rating: 160° F (71° C) Continuous 180° F (82° C) Peak

NFPA 701 Large Scale

Add color code to part number to designate color choice.

Colors: Orange (-OR), Red (-RED), Pink (-PK)

Part No.	Part No. (Mesh)	Size
FME-OD1	FME-ODV1	1in Diameter
FME-OD2	FME-ODV2	2in Diameter
FME-OD4	FME-ODV4	4in Diameter
FME-OD6	FME-ODV6	6in Diameter
FME-OD8	FME-ODV8	8in Diameter
FME-OD10	FME-ODV10	10in Diameter
FME-OD12	FME-ODV12	12in Diameter
FME-OD15	FME-ODV15	15in Diameter



FME Outdoor Storage/Warehouse Covers Metric Sizes

Part No.	Part No. with Mesh	Size
FME-OD25MM	FME-ODV25MM	25mm Diameter
FME-OD50MM	FME-ODV50MM	50mm Diameter
FME-OD100MM	FME-ODV100MM	100mm Diameter
FME-OD150MM	FME-ODV150MM	150mm Diameter
FME-OD200MM	FME-ODV200MM	200mm Diameter
FME-OD250MM	FME-ODV250MM	250mm Diameter
FME-OD300MM	FME-ODV300MM	300mm Diameter
FME-OD400MM	FME-ODV400MM	400mm Diameter

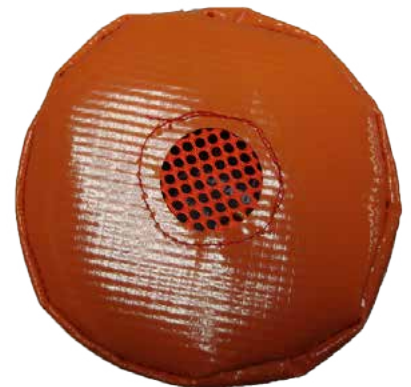

FME Hi-Temp Silicone Covers

Kevlar thread and metal free barrel lock. Optional High Temperature Mesh. Custom sizes available. Rated as F.M. Approved Welding Blanket fabric.

Temperature Rating:

500° F (260° C) Continuous temperature, 600° F (316° C) Peak Temperature

Optional: Mesh top- Vented for airflow. 1200° F (649° C) continuous temperature.

Colors (all in silicone fabric): Red or Gray



Part No.	Part No. (mesh)	Color	Size
FME-6-HT-GRAY	FME-V6-HT-GRAY	Gray	6in Diameter
FME-6-HT-R	FME-V6-HT-R	Red	6in Diameter
FME-10-HT-GRAY	FME-V10-HT-GRAY	Gray	10in Diameter
FME-10-HT-R	FME-V10-HT-R	Red	10in Diameter

FME Hi-Temp Silicone Covers Metric Sizes

*Pictured with High Temperature Mesh Top

Part No.	Part No. (mesh)	Color	Size
FME-150MM-GRAY	FME-V150-HT-GRAY	Gray	150 mm Diameter
FME-150MM-R	FME-V150MM-HT-R	Red	150 mm Diameter
FME-250MM-GRAY	FME-V250MM-HT-GRAY	Gray	250 mm Diameter
FME-250MM-R	FME-V250MM-HT-R	Red	250 mm Diameter



FME Tarps

These tarps are the answer to larger area FME controls – cover a component or an entire work bench of parts. Optional grommets (brass or stainless steel), or reinforced buttonholes for securing. Document pockets for traceability.

Custom Sizes Available, produced in our Philadelphia factory.

Choose 200, 400 or 1000 Denier (thickness).

Mesh in center or on panel for airflow.

Add color code to part number to designate color choice.

Available Colors: Orange (-OR), Red (-RED), Pink (-PK), Green (-GN)



Part No.	Part No. (mesh)	Size
FME-2X4	FME-V2x4	2ft x 4ft
FME-3X5	FME-V3X5	3ft x 5ft
FME-4X8	FME-V4X8	4ft x 8ft
FME-5X5	FME-V5X5	5ft x 5ft
FME-8X8	FME-V8X8	8ft x 8ft
FME-5X10	FME-V5X10	5ft x 10ft
FME-10X6	FME-V10X6	10ft x 6ft
FME-10X10	FME-V10X10	10ft x 10ft
FME-20x20	FME-V20x20	20ft x 20ft



FME Tarps Metric Sizes

Part No.	Part No. (mesh)	Size
FME-90CMX90CM	FME-V90CMX90CM	90cm x 90cm
FME-1.2MX2.4M	FME-V1.2MX2.4M	1.2m x 2.4m
FME-1.5MX1.5M	FME-V1.5MX1.5M	1.5m x 1.5m
FME-2.4MX2.4M	FME-V2.4MX2.4M	2.4m x 2.4m
FME-1.5MX3M	FME-V1.5MX3M	1.5m x 3m
FME-3MX1.8M	FME-V3MX1.8M	3m x 1.8m
FME-3MX3M	FME-V3MX3M	3m x 3m
FME-6MX6M	FME-V6MX6M	6m x 6m



FME Mesh & Magnetic Tarps

Magnetic Tarps provide a secure method of attachment. Excellent for use on vertical system openings, or when winds or heavy ventilation are a factor, and when anchor points are not available.

Add color code to part number to designate color choice.

Color: Colors: Orange (-OR), Red (-RED), Pink (-PK), Green (-GN)

Other Sizes available

Part No.	Part No. (mesh)	Size
FME-MC3X5	FME-MC3X5-M	3ft x 5ft
FME-MC4X8	FME-MC4X8-M	4ft x 8ft
FME-MC5X5	FME-MC5X5-M	5ft x 5ft
FME-MC8X8	FME-MC8X8-M	8ft x 8ft
FME-MC5X10	FME-MC5X10-M	5ft x 10ft
FME-MC10X6	FME-MC10X6-M	10ft x 6ft
FME-MC10X10	FME-MC10X10-M	10ft x 10ft
FME-MC15x15	FME-MC15x15-M	15ft x 15ft
FME-MC20X20	FME-MC20X20-M	20ft x 20ft



FME Mesh & Magnetic Tarps Metric Sizes

Part No.	Part No. (mesh)	Size
FME-MC90CMX1.5M	FME-MCV90CMX1.5M-M	90 cm x 1.5m
FME-MC1.2MX2.4M	FME-MCV1.2MX2.4M-M	1.2m x 2.4m
FME-MC1.5MX1.5M	FME-MCV1.5MX1.5M-M	1.5m x 1.5m
FME-MC2.4MX2.4M	FME-MCV2.4MX2.4M-M	2.4m x 2.4m
FME-MC1.5MX3M	FME-MCV1.5MX3M-M	1.5m x 3m
FME-MC3MX1.8M	FME-MCV3MX1.8M-M	3m x 1.8m
FME-MC3MX3M	FME-MCV3MX3M-M	3m x 3m
FME-MC6MX9M	FME-MCV6MX9M-M	6m x 9m



FME Magnetic Round Covers

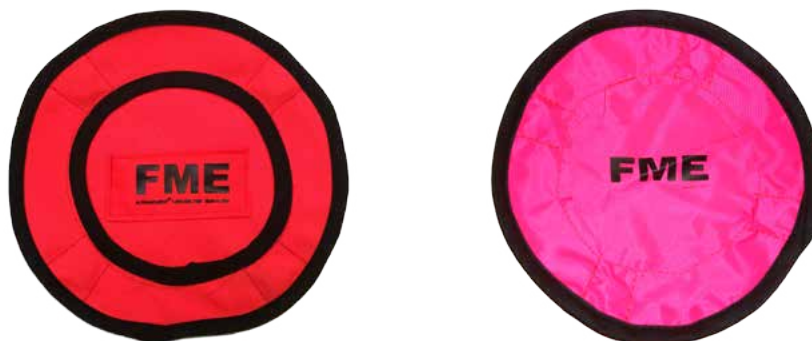

Part No.	Size	Part No. (Metric)	Size
FME-MCVR12	12in Diameter	FME-MCVR30CM	30cm Diameter
FME-MCVR18	18in Diameter	FME-MCVR45CM	45cm Diameter
FME-MCVR20	20in Diameter	FME-MCVR50CM	50cm Diameter
FME-MCVR22	22in Diameter	FME-MCVR55CM	55cm Diameter
FME-MCVR24	24in Diameter	FME-MCVR60CM	60cm Diameter
FME-MCVR26	26in Diameter	FME-MCVR66CM	66cm Diameter
FME-MCVR28	28in Diameter	FME-MCVR70CM	70cm Diameter
FME-MCVR30	30in Diameter	FME-MCVR76CM	76cm Diameter
FME-MCVR36	36in Diameter	FME-MCVR90CM	90cm Diameter

FME Mesh Magnetic Round Covers



Part No.	Size	Part No. (Metric)	Size
FME-MCVR10-M	10in Diameter	FME-MCVR25CM-M	25cm Diameter
FME-MCVR18-M	18in Diameter	FME-MCVR45CM-M	45cm Diameter
FME-MCVR20-M	20in Diameter	FME-MCVR50CM-M	50cm Diameter
FME-MCVR22-M	22in Diameter	FME-MCVR55CM-M	55cm Diameter
FME-MCVR24-M	24in Diameter	FME-MCVR60CM-M	60cm Diameter
FME-MCVR26-M	26in Diameter	FME-MCVR66CM-M	66cm Diameter
FME-MCVR28-M	28in Diameter	FME-MCVR70CM-M	70cm Diameter
FME-MCVR30-M	30in Diameter	FME-MCVR76CM-M	76cm Diameter
FME-MCVR36-M	36in Diameter	FME-MCVR90CM-M	90cm Diameter

Diesel Covers

Magnetic Diesel Covers conform to the shape of the diesel opening and quick installation reliably prevents FMI (Foreign Material Intrusion.)

Don't see your size? this is a small sample of the many different Diesel Covers we have produced.

Also available in easy to clean vinyl.

Add color code to part number to designate color choice.

Colors: Orange (-OR), Red (-RED), Pink (-PK) and Green(-GN)



Part No.	Length	Width
FME-DIES-10X12	10in(25cm)	12in(30cm)
FME-DIES-12X15	12in(30cm)	15in(38cm)
FME-DIES-14X18	14in(36cm)	18in(46cm)
FME-DIES-24X24	24in(61cm)	24in(61cm)
FME-DIES-48X21	48in(122cm)	21in(53cm)

High Temperature Fabrics and Other Material Barriers

ALPHAKEVLAR:

Fiberglass/Nomex/Kevlar® aramid fabric coated with red silicone for excellent cut, abrasion and chemical resistance. Barriers withstand temperatures up to 1000 degrees F (537 Celsius). Barriers also resist oil, acids and moisture.

ALPHA 600:

Hi-temp orange aramid blend fabric with service up to 1000 degrees F (537 Celsius). Barriers Offer good mildew and chemical resistance to most acids and alkali solutions.

ALPHA-SIL-600T:

New Hi-temp fabric will not leave particulate debris after cutting fabric. Barriers withstand temperatures up to 1800 degrees F (982 Celsius) and excursions to 3000 degrees F (1648 Celsius). A woven continuous filament amorphous silica fabric coated with black silicone rubber and Teflon, one side each.



Part No.	Description	Widths	Length	Weight
F-ALPHAKEVLAR-17-60	ALPHAKEVLAR Red Silicone Coated Kevlar®	60in	50yd	17oz/yd2
F-ALPHAKEVLAR-32-60	ALPHAKEVLAR Red Silicone Coated Kevlar®	60in	50yd	32oz/yd2
F-ALPHA-600-OR-60	Orange 600 Hi-temp Orange Aramid Blend	60in	50yd	17oz/yd2
F-ALPHA-SIL-600-T	Woven Continuous Filament Amorphous Silica Fabric: coated with black silicone rubber and Teflon, one side each	35in	50yd	27.3oz/yd2

Welding Blankets and Curtains

Custom Manufactured Textile Products - 17oz. red welding blankets and curtains
 These medium duty fabrics are ideal for welding blankets. Effectively containing sparks and light spatter, other uses include grinding shields, flame retardant pipe covers, drain covers, etc. service temperature is 600 degrees F constant 315 Celsius.

Also available with hi-strength magnets.

Custom Sizes available upon request.



Part No.	Width	Length	Weight Per Sq. Yd
F-ALPHAKEVLAR-17-3X4	3ft	4ft	17oz
F-ALPHAKEVLAR-17-5X5	5ft	5ft	17oz
F-ALPHAKEVLAR-17-6X6	6ft	6ft	17oz
F-ALPHAKEVLAR-17-8X8	8ft	8ft	17oz
F-ALPHAKEVLAR-17-10X10	10ft	10ft	17oz
F-ALPHAKEVLAR-17-12X12	12ft	12ft	17oz
F-ALPHAKEVLAR-17-20X30	20ft	30ft	17oz
FME-HT-10X10	High Temp 1800 Degree F 10'x10' Tarp with Tether Loops (Pictured)		

Welding Screens

Feature rugged tubular steel construction and one-piece curtains for complete elimination of light transmission between panels. Multi-Panel Screens feature hinged corners eliminating connectors which have to be purchased with other systems. All are furnished with platform legs.

Other sizes and colors available upon request

Part No.	Size	Color
F-WELDVVIEW-ORS	Small 6ft x 8ft x 6ft	Orange
F-WELDVVIEW-ORM	Medium 8ft x 8ft x 8ft	Orange



Insulated Welding Pads

Welding Pad, Silicone Coated Fiberglass, Withstand Temp. (Deg. F) 1750 (954 Celsius), Color Red, Features: Made With R51 Silicone, Withstands Temperatures in Excess of 1750 F, ANSI / FM 4950 Approved Material

Part No.	Width	Length	Thickness
F-ALPHA-HT-PAD12X24	12in	24in	1.5in thick
F-ALPHA-HT-PAD24X48	24in	48in	1.5in thick



Catchment Tarps

Used to prevent welding debris and tooling from falling below, during re-roofing projects etc. Medium duty (17oz.) (502.8ml) and heavy duty (32oz.) (946.4ml), effectively contains sparks and light spatter. The 17oz. Tarps prevents light tools, while 32oz. prevents most tools, and construction debris typically used in re-roofing projects from falling below roof line. Complete with hi-temp hanging loops.

Part No.	Width	Length	Weight Per Sq. Yd
F-ALPHAKEVLAR-CT-17-20X20	20ft	20ft	17oz (502.8ml)
F-ALPHAKEVLAR-CT-17-20X30	20ft	30ft	17oz (502.8ml)
F-ALPHAKEVLAR-CT-32-20X20	20ft	20ft	32oz (946.4ml)
F-ALPHAKEVLAR-CT-32-20X30	20ft	30ft	32oz (946.4ml)



Magnetic Mesh LP Blade Cover

Designed for use during blade replacement projects.

Part No.	Description
F-LPBLADE-MAG	Magnetic Mesh LP Blade Cover

Versatarps

Versatarp line of catchment tarps funnel away leaks through a built in hose attachment.

Catchment tarps manufactured of F/R material for applications where high temperature fabric is not necessary.

Part No.	Size	Part No.	Size
B3x3VERSA	3ft x 3ft	B7x7VERSA	7ft x 7ft
B4x4VERSA	4ft x 4ft	B8x8VERSA	8ft x 8ft
B5x5VERSA	5ft x 5ft	B10x10VERSA	10ft x 10ft
B6x6VERSA	6ft x 6ft	B12x12VERSA	12ft x 12ft
B6x8VERSA	6ft x 8ft	B15x15VERSA	15ft x 15ft
B6x10VERSA	6ft x 10ft	B20x20VERSA	20ft x 20ft



Leak Diverter

Springs open fast to stop leaks, just pop open this leak diverter.

Part No.	Size
F-LEAKAWAY	30in x 30in



Fire Retardant Debris Netting Roll Goods

ALPHA-44DN

Fire-retardant orange netting. Meets NFPA 701 Large Scale.

Product features: Knitted polyethylene threads with reinforced border
Lightweight, yet sturdy mesh

Aperture size: 1/4in

Part No.	Roll Size
F-ALPHA-44-4150	4ft x 150ft Roll
F-ALPHA-44-5.6150	5.6ft x 150ft Roll
F-ALPHA-44-8.6150	8.6ft x 150ft Roll
F-ALPHA-44-10.6150	10.6ft x 150ft Roll

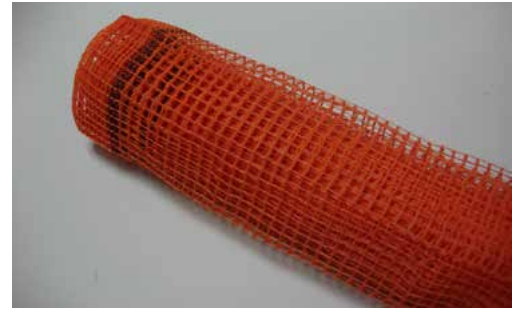

ALPHA-FC-HTDN

Woven high-temp fiberglass cloth. Lightweight high-temperature mesh barrier fabric.

Product features:

Operating temperature 1200 degrees F with excursions to 1500 degrees F

Thermal shock resistant, High heat reflectance, Excellent corrosion resistance.

Part No.	Roll Size
F-ALPHA-FC-HTDN2530	30in x 25yd
F-ALPHA-FC-HTDN5030	30in x 50yd
F-ALPHA-FC-HTDN10030	30in x 100yd
F-ALPHA-FC-HTDN2548	48in x 25yd
F-ALPHA-FC-HTDN5048	48in x 50yd
F-ALPHA-FC-HTDN10048	48in x 100yd

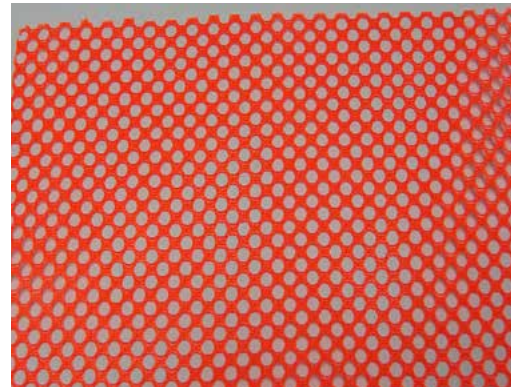

ALPHA-PMDN

100% orange polyester raschel knit

Fire-retardant netting

Product features

Lightweight yet sturdy mesh

Aperture size: 3/16in

Part No.	Roll Size (Width and Length)
F-ALPHA-PMDN	60in x 100yd

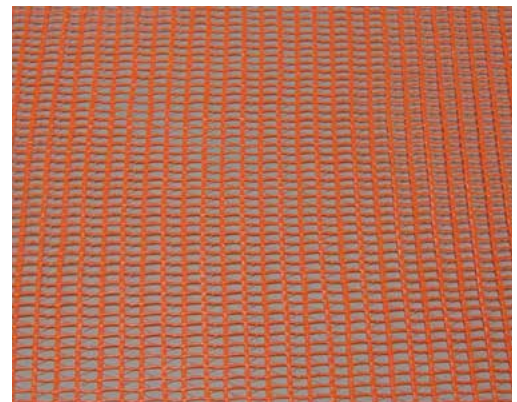

Fire Retardant Mesh Rolls

Available in black, pink, red and orange.
Sold by the roll /per yard. NFPA 701 large scale compliant.

Part No.	Roll Width
F-MESH-ROLL-BLK	60in
F-MESH-ROLL-RED	60in
F-MESH-ROLL-OR	60in
F-MESH-ROLL-PK	60in

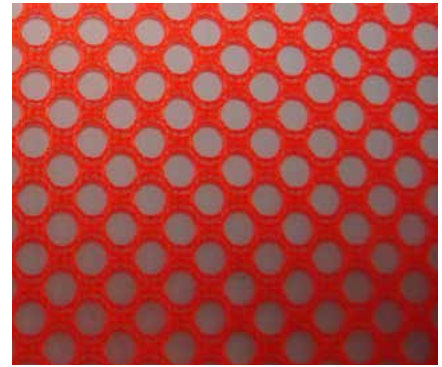

ALPHA-84DN

Fire-retardant orange netting. Meets NFPA 701 Large Scale
Product features:
PVC coated polyester with reinforced border
Aperture size: 1/8in - 3/16in

Part No.	Roll Size
F-ALPHA-84-4150	4 ft x 150ft Roll
F-ALPHA-84-5.6150	5.6ft x 150ft Roll

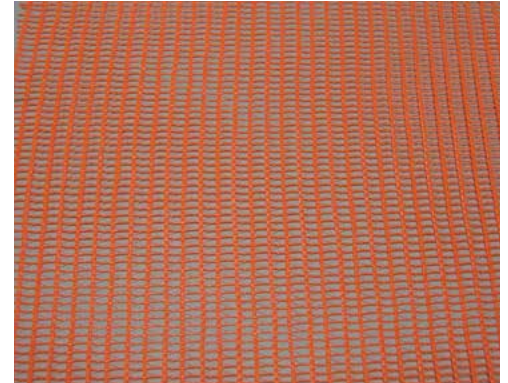

Cover Guard® Diamond Plate Floor Cover

Fire retardant interior and exterior surface protection
Developed for the temporary protection of floors, walls, equipment and for wrapping and containment.

Liquid Resistant including oils, chemicals and solvents	Satisfies:
Puncture Resistant	Small flame test to BS 476 Part 12 1991
Anti-Slip, Anti-Trip	Large flame test to BS 5852, crib no. 7
U.V. Resistant	Smoke emission EN 2825 / Toxic gas emission EN2826
Anti-Static	Oxygen index BS2782 (Part 1 method 141 1986)(ISO 4589-1984)
Available on rolls that can be cut to any size	French M1 Standard - SME Centre de Recherches da Bouchet



Part No.	Size	area	weght	thickness
F-AF25X36B	Size: 35.8in x 180.4in (0.91m x 55m)	538foot ² (50m ²)	68.4lb (31klo)	635 Micron (25ml)

Hi-Temp Magnetic Covers with Hi-Strength, Rare Earth Bar Magnets

Close openings in condenser, reactor head or other large cavities with super hi-strength rare-earth bar magnets. For those applications where stronger magnetic attraction is required to keep covers firmly in place without shifting or gapping.

Send us a sketch of what you need covered and we will do the rest!



Part No.	Description	Width	Length	Weight per Sq. Yd
F-48X144-34-R	34oz Red Silicone Coated ALPHAKEVLAR	48in	114in	34oz/yd2
F-MC40X96-34-R	34oz Red Silicone Coated ALPHAKEVLAR	40in	96in	34oz/yd2

Stock Magnetic Drain Covers

DrainBlocker® Magnetic Drain Cover with DuPont Elvaloy®

Temperature Rating: Max Liquid Temp 225 F for 30 minutes Yellow top, Black bottom.

Part No.	Description
FME-MAG-DRAIN-RND6	12in Diameter, up to 6in Round Drain
FME-MAG-DRAIN-RND14	20in Diameter, up to 14in Round Drain
FME-MAG-DRAIN-RND24	30in Diameter, up to 24in Round Drain
FME-MAG-DRAIN-SQR36	42in x 42in, up to 36in Square Drain
FME-MAG-DRAIN-SQR42	48in x 48in, up to 42in Square Drain
FME-MAG-DRAIN-SQR48	54in x 54in, up to 42in Square Drain



Griffolyn®

This Fire Retardant 3-ply laminate combines two layers of fire retardant, linear low density polyethylene and a high-strength cord grid.

Griffolyn® Special Features:

- Weather and Corrosion Protection
- Anti-Static
- Chemically Resistant
- Lightweight
- Heat Shrinkable
- Low Permeability
- UV Stabilized
- Puncture Resistant
- Long Outdoor Life
- Fire Retardant to NFPA701 Large Scale

Temperature Rating:

Minimum: -15°F / -27°C

Maximum: 170°F / 77°C

Available Colors: Orange, Red, Pink, Green

Part No.	Size	Color
F-TX1200FR-O	50in x 300ft	Orange
F-TX1200FR-R	50in x 300ft	Red
F-TX1200FR-P	50in x 300ft	Pink
F-TX1200FR-G	50in x 300ft	Green



Caps and Plugs Kits

From our Alphasource® TOOLSAVER2GO series.

Custom, portable case stocked with I & C series Caps & Plugs or Maintenance series. Caps and Plugs.

Add color code to part number to designate color choice.

Colors: Red (-RED) and Orange (-OR)



Part No.	Description	Qty
FME-KIT-I&C2GO	Portable I&C Kit	1 Case
FME-KIT-MAINT-C&P-2GO	Portable Maintenance Caps and Plugs Kit	1 Case

Pipe Plug Kit

This kit includes Nylon Expansion Plugs from 1/2 in through 4 in sizes (includes fittings and caps) in a hard carrying case with custom foam inserts.

Each Plug kit includes the following items:

- (2) each of the 1/2in, 3/4in, 1in, 1.25in, 1.50in (flanged plugs, solid stem)
- (2) each of the 1/2in, 3/4in, 1in, 1.25in, 1.50in (flanged plugs, vented stem)
- (2) each of the 1/2in, 3/4in, 1in, 1.25in, 1.50in (vented stem)



Part No.	Description	Qty
FME-KIT-PP2GO	Pipe Plug Kit	1 Kit

Inflatable Plugs

Inflatable plugs and bladders provide an internal pipe plug. They are available in rubber or nitrile. The dipped canvas cover is fire retardant, protects the bladder, and provides reinforcement in case of accidental over inflation. All of our Inflatable Plugs are supplied with safety tethers at NO additional cost. Be safe with value priced.

Alphasource® Best Fit® Bag Plugs

*Ask us about our Inflatable Plug Accessories, such as hand pumps, pressure gauges & hose covers, on page 60.



Diameter Size (in)	Diameter Size (mm)	Part No. NATURAL GUM RUBBER	Part No. NATURAL GUM RUBBER WITH F/R COVER	Part No. NITRILE (BUNA-N)	Part No. NITRILE (BUNA-N) WITH F/R COVER
2	51	F-BC2-T	F-BC2FR-T	F-BC2N-T	F-BC2FRN-T
3	76	F-BC3-T	F-BC3FR-T	F-BC3N-T	F-BC3FRN-T
4	102	F-BC4-T	F-BC4FR-T	F-BC4N-T	F-BC4FRN-T
6	152	F-BC6-T	F-BC6FR-T	F-BC6N-T	F-BC6FRN-T
8	203	F-BC8-T	F-BC8FR-T	F-BC8N-T	F-BC8FRN-T
10	254	F-BC10-T	F-BC10FR-T	F-BC10N-T	F-BC10FRN-T
12	305	F-BC12-T	F-BC12FR-T	F-BC12N-T	F-BC12FRN-T
14	356	F-BC14-T	F-BC14FR-T	F-BC14N-T	F-BC14FRN-T
16	406	F-BC16-T	F-BC16FR-T	F-BC16N-T	F-BC16FRN-T
18	457	F-BC18-T	F-BC18FR-T	F-BC18N-T	F-BC18FRN-T
20	508	F-BC20-T	F-BC20FR-T	F-BC20N-T	F-BC20FRN-T
22	559	F-BC22-T	F-BC22FR-T	F-BC22N-T	F-BC22FRN-T
24	610	F-BC24-T	F-BC24FR-T	F-BC24N-T	F-BC24FRN-T
26	660	F-BC26-T	F-BC26FR-T	F-BC26N-T	F-BC26FRN-T
28	711	F-BC28-T	F-BC28FR-T	F-BC28N-T	F-BC28FRN-T
30	762	F-BC30-T	F-BC30FR-T	F-BC30N-T	F-BC30FRN-T
32	813	F-BC32-T	F-BC32FR-T	F-BC32N-T	F-BC32FRN-T
34	864	F-BC34-T	F-BC34FR-T	F-BC34N-T	F-BC34FRN-T
36	914	F-BC36-T	F-BC36FR-T	F-BC36N-T	F-BC36FRN-T
40	1016	F-BC40-T	F-BC40FR-T	F-BC40N-T	F-BC40FRN-T
42	1067	F-BC42-T	F-BC42FR-T	F-BC42N-T	F-BC42FRN-T
44	1118	F-BC44-T	F-BC44FR-T	F-BC44N-T	F-BC44FRN-T
48	1219	F-BC48-T	F-BC48FR-T	F-BCN48-T	F-BC48FRN-T
52	1321	F-BC52-T	F-BC52FR-T	F-BCN52-T	F-BC52FRN-T
54	1372	F-BC54-T	F-BC54FR-T	F-BCN54-T	F-BC54FRN-T
60	1524	F-BC60-T	F-BC60FR-T	F-BCN60-T	F-BC60FRN-T

Plug Accessories



	Part No.	Description
A	F-B-GKRSP-15PSI	Gauge Kit with Regulator
B	F-AFHC-15PSI	Airline with Gauge, 6' Air Hose Line
C	F-A-AFHC	Extra Airline
D	F-B-INL-GK30PSI	Inline Gauge Kit with Gauge
E	F-B-GA-30PSI	Bladder Gauge 30 PSI
	F-B-GA-15PSI	Bladder Gauge 15 PSI

High Temp Hose and Bladder Protectors

Part No.	Size	Length
F-IPHSCVR-REG	0.5in x 3ft hose size	3ft
F-IPHSCVR-LG	0.5in x 6ft hose size	6ft
F-SLEEVE-2X3	2in	3ft
F-SLEEVE-2X6	2in	6ft



Part No.	Description	Size
F-IPHAT-SML	High temp cover for small Inflatable covers. Attaches to F-IPHSCVR-REG	2in-6in
F-IPHAT-MED	High temp cover for medium Inflatable covers. Attaches to F-IPHSCVR-REG	10in-16in
F-IPHAT-LG	High temp cover for Large Inflatable covers. Attaches to F-IPHSCVR-LG	18in-22in
F-IPHAT-XL	High temp cover for XL Inflatable covers. Attaches to F-IPHSCVR-LG	24in-30in
F-IPHAT-2XL	High temp cover for 2XL Inflatable covers. Attaches to F-IPHSCVR-LG	larger than 30in

Flow Stoppers

- Used as a block plug, a water/air test plug, or leak locating back plug
- Can be floated down pipe and stopped at desired location to prevent going down a manhole for installation or removal.
- Grows shorter as it inflates to put less stress on plug.



Part No.	Range Inches	Min Inches	Infl Pressure PSI	Back Pressure PSI	Length Inches	Weight (Lbs)
FME-MLS-1.5/2.8	1.4 - 2.8	1.3	2.8	45	34	1
FME-MLS-02/04	2 - 4	1.8	4	45	34	1.1
FME-MLS-03/06	3 - 6	2.6	6	45	34	1.4
FME-MLS-04/08	4 - 8	3.5	8	45	19	5
FME-MLS-06/12	6 - 12	5.5	12	45	19	8
FME-MLS-08/16	8 - 16	7.3	16	45	19	9
FME-MLS-12/24	12 - 24	11.3	24	45	19	21
FME-MLS-15/30	15 - 30	14.2	30	45	19	35
FME-MLS-20/40	20 - 40	19.1	40	45	14.5	51
FME-MLS-24/48	24 - 48	23	48	45	14.5	93

Nylon Expansion Plugs

Low Pressure, Quality, lightweight, durable Nylon- 20% lighter than metal. Tough/shatterproof and easily cleaned and maintained, corrosion resistant. Plaster or cement will not adhere to the plug. Friction-reducing acetyl co-polymer thrust washer inserted between plate and wing nut provides for easy expansion. Plugs are used to create an airtight seal.

Larger sizes incorporate strengthening ribs to provide rigidity in use. SS Parts withstand 60-100 PSI and VS Parts withstand 24-42 PSI. Silicon, Nitrile, and Viton seals available



Part No. Solid Stem	Part No. Hollow Stem	NOMINAL SIZE (in) (mm)		SIZE UNEXPANDED (in) (mm)		SIZE EXPANDED (in) (mm)	
F-VS0.50	F-SS0.50	0.5	13	0.49	12	0.6	15
F-VS0.75	F-SS0.76	0.75	19	0.74	19	0.9	23
F-VS1.00	F-SS1.00	1	25	0.975	25	1.2	30
F-VS1.25	F-SS1.25	1.25	32	1.225	31	1.45	37
	F-SS1.50	1.5	38	1.48	38	1.75	45
F-VS1.50		1.5	38	1.42	36	1.93	49
F-VS2.00		2	51	1.93	49	2.36	60
F-VS2.50		2.5	64	2.4	61	2.76	70
F-VS3.00		3	76	2.87	73	3.31	84
F-VS4.00		4	102	3.54	90	4.25	108
F-VS5.00		5	127	4.72	120	5.37	136
F-VS6.00		6	152	5.5	140	6.29	160



Cast Aluminum Expansion Plugs

Aluminum Expansion Plugs are used to create an airtight seal. The cast aluminum is non-corrosive and durable yet lightweight. Made with heavy duty aluminum and natural rubber these plugs, easily handle and up to 70% lighter than similar steel plugs.

Fill or Vent - threaded pipe stem has removable cap.

Simple to install and work with, a wing nut easily expands the rubber seal.

Special sizes are available upon request



Part No.	NOMINAL SIZE		SIZE UNEXPANDED		SIZE EXPANDED	
	(in)	(mm)	(in)	(mm)	(in)	(mm)
F-AP01.50	1.5	38.1	1.456	36.98	1.889	47.98
F-AP02.00	2	50.8	1.889	47.98	2.44	61.98
F-AP02.50	2.5	63.5	2.44	61.98	2.775	70.485
F-AP03.00	3	76.2	2.795	70.993	3.425	86.994
F-AP03.50	3.5	88.9	3.503	88.98	3.7	93.98
F-AP04.00	4	101.6	3.779	95.99	4.133	104.47
F-AP04.50	4.5	114.3	4.215	107.06	4.724	119.99
F-AP05.00	5	127	4.842	122.99	5.393	136.98
F-AP06.00	6	152.4	5.9	149.86	6.55	166.37
F-AP07.00	7	177.8	6.55	166.37	7.3	185.42
F-AP08.00	8	203.2	7.7	195.58	8.55	217.17
F-AP09.00	9	228.6	8.2	208.28	9.1	231.14
F-AP10.00	10	254	9.2	233.68	10.25	260.35
F-AP11.00	11	279.4	10.3	261.62	11.2	284.48
F-AP12.00	12	304.8	11.35	288.29	12.45	316.23
F-AP14.00	14	355.6	13.8	350.52	15.1	383.54
F-AP15.00	15	381	14.35	364.49	15.8	401.32
F-AP16.00	16	406.4	15.6	396.24	17	431.8
F-AP18.00	18	457.2	17.45	443.23	19.25	488.95
F-AP20.00	20	508	19.15	486.41	20.65	524.51
F-AP21.00	21	533.4	20.65	524.51	22.1	561.34
F-AP24.00	24	609.6	23.55	598.17	25.5	647.7
F-AP27.00	27	685.8	26.25	666.75	27.7	703.58
F-AP30.00	30	762	29.25	742.95	31	787.4
F-AP33.00	33	838.2	32.5	825.5	34.8	883.92
F-AP36.00	36	914.4	34.5	876.3	36.8	934.72

Safe-T Sponge®

The Advanced F.M.E. Products Safe-T Sponge® is designed to keep tubes , pipes and machinery openings clean during meld prep and repair operations.

Low halogen foreign material exclusion devices for fossil and nuclear power plants. Very popular for use during turbine repairs and overhauls.

All Safe-t Sponges are performance tested and made in USA US Patent # 6506014 & 6824356

Fossil Part No.	Nuclear Part No.	O.D. Size	Qty
F-PL1	F-NPL1	1"	25
F-PL1.25	F-NPL1.25	1.25"	25
F-PL1.50	F-NPL1.5	1.50"	25
F-PL2	F-NPL2	2.25"	25
F-PL2.5	F-NPL2.5	2.75"	25
F-PL3	F-NPL3	3.25"	25
F-PL4	F-NPL4	4.25"	15



Compatible for both Fossil & Nuclear Part No.	Laminated F/R Part No.	O.D. Size	Qty
F-PL5	F-LPL5	5"	10
F-PL6	F-LPL6	6"	10
F-PL8	F-LPL8	8"	10
F-PL10	F-LPL10	10"	10
F-PL12	F-LPL12	12"	1
F-PL14	F-LPL14	14"	1
F-PL16	F-LPL16	16"	1
F-PL18	F-LPL18	18"	1
F-PL20	F-LPL20	20"	1
F-PL22	F-LPL22	22"	1
F-PL24	F-LPL24	24"	1
F-PL26	F-LPL26	26"	1
F-PL 28	F-LPL28	28"	1
F-PL 30	F-LPL30	30"	1
F-PL 32	F-LPL32	32"	1
F-PL 34	F-LPL34	34"	1
F-PL 36	F-LPL36	36"	1
F-PL 38	F-LPL38	38"	1
F-PL 40	F-LPL40	40"	1
F-PL 42	F-LPL42	42"	1
F-PL 44	F-LPL44	44"	1
F-PL 46	F-LPL46	46"	1
F-PL 48	F-LPL48	48"	1
F-PL 50	F-LPL50	50"	1



Flame resistant laminate standard

F-PL1 to F-PL4, optional F-PL5 to F-PL50 (example: F-LPL-30).

Call for F-LPL5 to F-LPL50 pricing - may require extra lead time.

Laminated enclosed Safe-T-Sponge®

F-LE4 to F-LE16 available by special order.

F-PL1 to F-PL4 available two styles

Boiler applications order PL ...

Nuclear applications order NPL...

to ensure compatible parts using no metal.

Cleaning and sounding order PL...C

F-PL5 through F-PL50 specify if Nuclear use

When placing order please state

Nuclear or Fossil application use.

High Temperature Caps and Plugs

Tapered Silicone Caps and Plugs

TS Series tapered caps / plugs are made of a flexible and durable silicone material. The TS series offers all the versatility of our traditional tapers with the added resilience of silicone. Ideal for use in masking applications that require temperature and corrosion resistance. Available in red



Part No.	Dim A	Dim B	Dim C	Dim D	Dim E	Dim F
FME-TS-00	0.116	0.182	0.053	0.12	0.38	0.33
FME-TS-0	0.173	0.24	0.111	0.177	0.38	0.4
FME-TS-1	0.24	0.295	0.174	0.24	0.38	0.46
FME-TS-2	0.299	0.365	0.235	0.302	0.38	0.52
FME-TS-3	0.361	0.418	0.298	0.365	0.38	0.58
FME-TS-4	0.419	0.485	0.356	0.422	0.38	0.65
FME-TS-5	0.471	0.536	0.409	0.485	0.44	0.71
FME-TS-6	0.532	0.608	0.468	0.545	0.44	0.77
FME-TS-7	0.58	0.667	0.518	0.605	0.5	0.83
FME-TS-8	0.64	0.727	0.578	0.664	0.5	0.9
FME-TS-9	0.69	0.788	0.628	0.726	0.56	0.96
FME-TS-10	0.75	0.848	0.687	0.785	0.56	1.02
FME-TS-11	0.802	0.911	0.74	0.849	0.63	1.08
FME-TS-12	0.866	0.975	0.803	0.912	0.63	1.15
FME-TS-13	0.964	1.09	0.901	1.027	0.75	1.27
FME-TS-14	1.094	1.215	1.031	1.152	0.75	1.43
FME-TS-15	1.224	1.355	1.161	1.292	0.75	1.52
FME-TS-16	1.312	1.465	1.249	1.402	0.88	1.65
FME-TS-17	1.447	1.6	1.384	1.537	0.88	1.77
FME-TS-18	1.56	1.682	1.498	1.62	0.75	1.9
FME-TS-19	1.75	1.88	1.688	1.818	0.75	2.02
FME-TS-20	1.78	1.95	1.718	1.888	1	2.15
FME-TS-21	1.9	2.076	1.837	2.013	1	2.27
FME-TS-23	2.035	2.21	1.976	2.153	1	2.36

Caps and Plugs

DMP Series

The curved pull-tab design provides more surface contact area requiring less gripping force during installation and removal. Flexible material can stretch onto larger dimensions for a snug fit.

Material: Vinyl (PVC)

Add color code to part number to designate color choice.

Colors: Orange (-OR) and Red (-R)

Temperature Range: Up to 350°F (177°C)

Part No.	A in (mm)	B in (mm)
F-DM0125-1A	0.125 (3)	1 in (25)
F-DMPC0180-1/2A	0.187 (5)	1/2 (13)
F-DMPC0207-1A	0.218 (6)	1 (25)
F-DMPC0240-1A	0.25 (6)	1 (25)
F-DMPC0365-1A	0.375 (10)	1 (25)
F-DMPC0490-1-1/2A	0.5 (13)	1-1/2 (38)
F-DMPC0740-1-1/2A	0.75 (19)	1-1/2 (38)
F-DMPC0865-1-1/2A	0.875 (22)	1-1/2 (38)
F-DMPC0990-1-1/2A	1 (25)	1-1/2 (38)
F-DMPC1500-1-1/2A	1.5 (38)	1-1/2 (38)

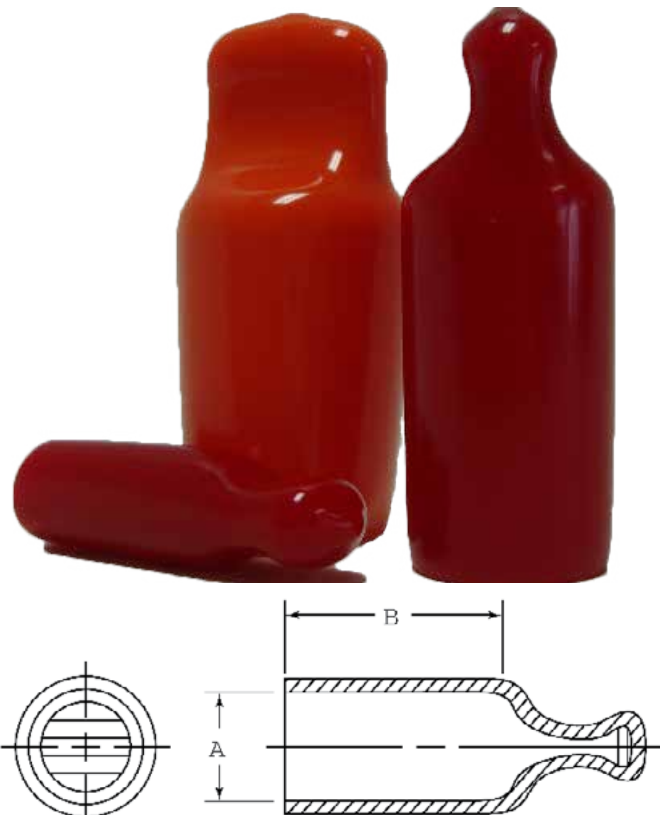

PC SERIES

PC Pull tab vinyl caps feature an extra long tab centered at the top of the closure which will allow the cap to be finger-removed easily, eliminating the use of tools which could damage threads or part surfaces.

Add color code to part number to designate color choice.

Colors: Orange (-OR) and Red (-R)

Other sizes and colors available upon request

Sold in reusable tinted Ziploc bags.

Part No.	A in (mm)	B in (mm)	C in (mm)
FME-PC521-12	0.521 (13)	0.625 (16)	0.125 (3)
FME-PC677-12	0.677 (17)	0.812 (21)	0.187 (4)

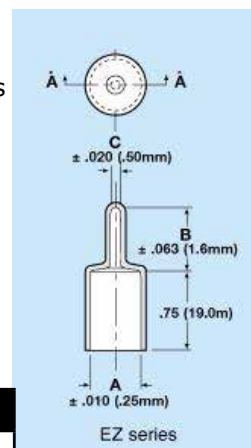

VCF Series

Ideal for tubing or valve stem protection.

Vinyl caps with flanges ensure simple, easy removal with a flange at the closed end that is small enough not to interfere, but large enough to grasp during removal.

Material: Vinyl

Add color code to part number to designate color choice.

Colors: Orange (-OR) and Red (-R)

Packaged in reusable tinted Ziploc Bags

Part No.	A in (mm)	B in (mm)	C in (mm)
FME-VCF250-16	0.25 (6)	0.05 (1)	1.00 (25)
FME-VCF375-16	0.375 (10)	0.06 (2)	1.00 (25)
FME-VCF500-16	0.5 (13)	0.06 (2)	1.00 (25)
FME-VCF750-16	0.75 (19)	0.065 (2)	1.00 (13)
FME-VCF1000-16	1.00 (25)	0.07 (12)	1.00 (13)

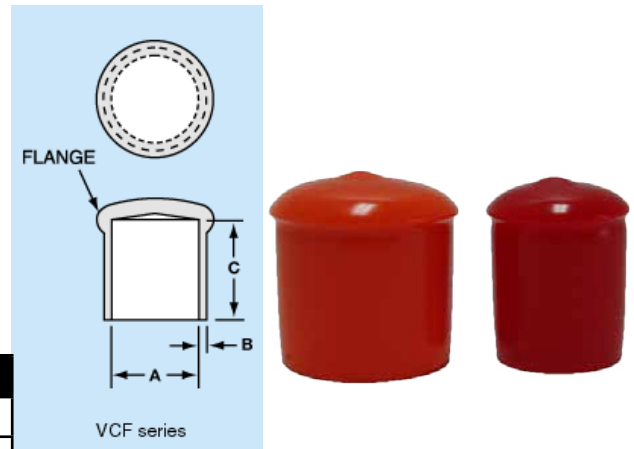

VVC Series –Vinyl caps

Our Vent-A-Cap™ Series used to protect the ends of tubing connectors and instrument tips. Vented for air release and easy removal. The venting allows for air flow. They are Gamma friendly as well. These caps are tapered to fit multiple sizes for a variety of tubing and instruments.

Color: Red

Part No.	A in (mm)	B in (mm)	C in (mm)	D in (mm)
FME-VVC2920	0.23 (6)	0.281 (7)	0.7 (18)	0.045 (1)
FME-VVC2924	0.355 (9)	0.415 (11)	0.75 (19)	0.055 (1)
FME-VVC2930	0.542 (14)	0.602 (15)	0.9 (23)	0.06 (2)
FME-VVC2932	0.667 (17)	0.737 (19)	0.875 (22)	0.06 (2)



VENTED MUSHROOM CAPS

Each cap is designed with a 30 mesh screen to prevent debris from entering the vent pipe. Zinc-plated cast iron

Used by Operations for vertical pipe openings

*Also available in colors upon request.

Part No.	FEMALE NPT SIZE in (mm)
FME-4021	0.75 (19)
FME-4022	1 (25)
FME-4023	1.25 (32)
FME-4024	1.5 (38)
FME-4025	2 (51)

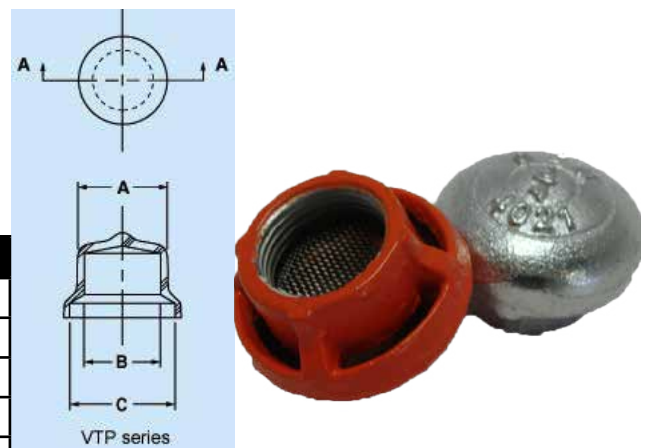

VTP Series Vinyl Plugs

Series VTP plugs provide a snug fit when pushed into open ports, ensuring a tight closure that will not pop out accidentally. A simple tug on the flanged lip of an installed VTP breaks the seal for easy removal. Molded from a specially formulated vinyl that is non-shredding.

Colors: Red Material: Vinyl

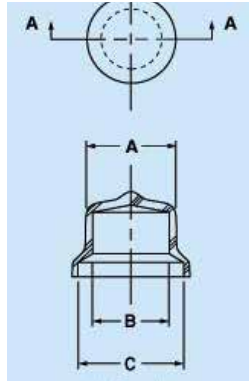

Part No.	To Fit Thread Size (NPT)	To Fit Thread Size (STD)	A in (mm)	B in (mm)	C in (mm)
FME-VTP-2	1/8 in	3/8 in	0.4 (10)	0.29 (7)	0.437 (11)
FME-VTP-3	1/4 in	1/2 in	0.53 (14)	0.365 (9)	0.555 (14)
FME-VTP-4	3/8 in	5/8 in	0.64 (16)	0.52 (13)	0.75 (19)
FME-VTP-5	1/2 in	3/4 in	0.8 (20)	0.682 (17)	0.937 (24)
FME-VTP-55	3/4 in	7/8 in	0.87 (23)	0.732 (19)	1.000 (25)
FME-VTP-6	3/4 in	1-1/16 in	1.025 (28)	0.891 (23)	1.188 (30)
FME-VTP-7	1 in	1-3/16 in, 1-1/4 in, 1-5/16 in	1.275 (32)	1.147 (29)	1.453 (37)

Socket Weld Caps -V Series

These socket-weld fitting plugs are designed to provide maximum protection for close fit socket weld applications. The straight wall on the plugs O.D. provides a secure and friction fit with the mating parts I.D.

Material: Low-Density Polyethylene

Add color code to part number to designate color choice.

Colors: Orange (-OR) and Red (-R)

Other colors available upon request.

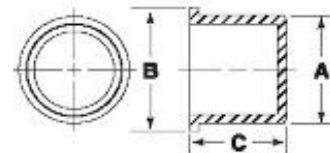

Part No.	Socket Weld Size	A in (mm)	B in (mm)	C in (mm)
FME-V23	1/2 in	0.875 (22)	1 (25)	0.355 (9)
FME-V31	3/4 in	1.085 (28)	1.2 (30)	0.43 (11)
FME-V42	1 in	1.35 (34)	1.475 (37)	0.43 (11)
FME-V53	1-1/4 in	1.695 (43)	1.181 (46)	0.43 (11)
FME-V57	1-1/2 in	1.935 (49)	2.06 (52)	0.43 (11)
FME-V68	2 in	2.426 (62)	2.55 (65)	0.555 (14)

CE Series NPT Caps- CLOSED END CAPS

These deeper walled polyethylene plastic pipe caps provide a barrier for threaded pipe ends. The added length of the CE series caps provides a positive seal on the pipe surface beyond last thread.

Designed to protect threads from damage and contamination during transit, handling and storage.

Easy to install and remove. These caps have the durability of traditional pipe caps with anelasticity that ensures they will stay on the pipe until you intentionally remove it.

Add color code to part number to designate color choice.

Colors: Orange (-OR) and Red (-R)

Some sizes available in Green (-GN)

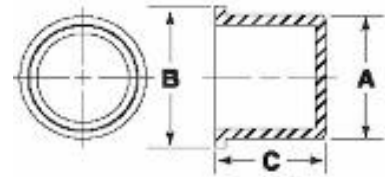

Part No.	To Fit Thread Size	A in (mm)	B in (mm)
FME-CE318	3 NPT	3.5 (89)	1.63 (41)
FME-CE319	3 -1/2 NPT	4 (102)	1.66 (42)
FME-CE320	4 NPT	4.5 (114)	1.72 (44)
FME-CE321	5 NPT	5.56 (141)	1.81 (44)
FME-CE322	6 NPT	6.62 (168)	1.94 (49)
FME-CE324	8 NPT	8.62 (219)	2.13 (54)
FME-CE325	10 NPT	10.75 (273)	2.34 (59)
FME-CE326	12 NPT	12.75 (324)	2.53 (64)
FME-CE327	14 NPT	14 (356)	2.66 (68)
FME-CE328	16 NPT	16 (406)	2.44 (62)
FME-CE329	18 NPT	18 (457)	2.44 (62)
FME-CE330	20 NPT	20 (508)	2.64 (67)
FME-CE331	22 NPT	22 (559)	2.36 (60)
FME-CE332	24 NPT	24 (610)	2.44 (62)
FME-CE333	26 NPT	26 (660)	4.53 (115)
FME-CE334	28 NPT	28 (711)	4.53 (115)
FME-CE335	30 NPT	30 (762)	4.53 (115)

Tapered Caps and Plugs Series

Caps for external and internal NPT fittings. T Series can be used as either caps or plugs. Because they are tapered in design and made from highly pliable (flexible) polyethylene, they not only can be applied to fit snugly but are readily removable.

Material: Low-Density Polyethylene.* Packaged in reusable tinted ziploc bags.

Colors: Orange

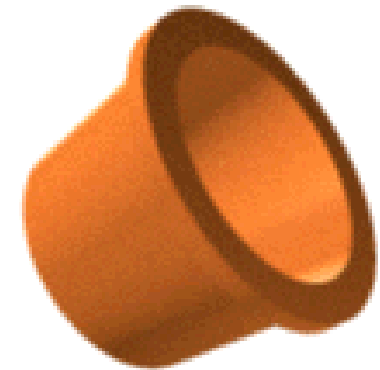
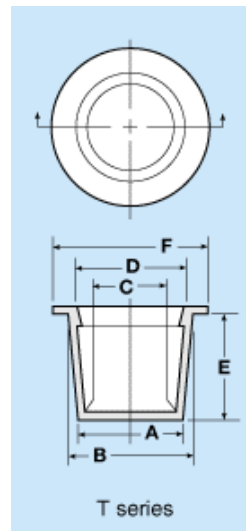

Part No.	A in (mm)	B in (mm)	C in (mm)	D in (mm)	E in (mm)	F in (mm)
FME-TC237-Y-OR	0.299 (8)	0.367 (9)	0.235 (6)	0.303 (8)	0.41 (10)	0.50 (13)
FME-TC238-D-OR	0.362 (9)	0.428 (11)	0.298 (8)	0.364 (9)	0.41 (10)	0.56 (14)
FME-T3-OR	0.361 (9)	0.427 (11)	0.298 (8)	0.365 (9)	0.38 (10)	0.56 (14)
FME-T4-OR	0.419 (11)	0.485 (12)	0.356 (9)	0.422 (10)	0.38 (10)	0.63 (16)
FME-T5-OR	0.471 (12)	0.547 (14)	0.409 (10)	0.485 (12)	0.44 (11)	0.69 (18)
FME-TC189-2-OR	0.50 (13)	0.568 (14)	0.436 (12)	0.504 (13)	0.47 (12)	0.72 (18)
FME-TC242-2-OR	0.61 (15)	0.695 (18)	0.549 (14)	0.634 (16)	0.53 (13)	0.84 (21)
FME-T8-OR	0.64 (16)	0.727 (18)	0.578 (15)	0.664 (17)	0.50 (13)	0.88 (22)
FME-TC245-OR	0.727 (18)	0.825 (21)	0.663 (17)	0.761 (19)	0.59 (15)	1.00 (25)
FME-T12X-OR	0.915 (23)	1.04 (26)	0.855 (21)	0.98 (25)	0.69 (18)	1.16 (29)
FME-TC249-OR	0.967 (25)	1.092 (28)	0.903 (23)	1.028 (26)	0.78 (20)	1.25 (32)
FME-T14X-OR	1.175 (30)	1.284 (35)	1.113 (28)	1.222 (31)	0.63 (16)	1.44 (37)
FME-TC727-OR	1.435 (36)	1.50 (38)	1.34 (34)	1.42 (36)	0.80 (20)	1.75 (44)
FME-T17-S-OR	1.513 (38)	1.60 (41)	1.451 (37)	1.537 (39)	0.50 (13)	1.75 (44)
FME-TC195-F-OR	1.56 (40)	1.682 (43)	1.498 (38)	1.62 (41)	0.78 (20)	1.88 (48)
FME-T19-OR	1.75 (44)	1.88 (48)	1.688 (43)	1.818 (46)	0.75 (19)	2.00 (51)
FME-TC911-OR	1.865 (47)	1.975 (50)	1.785 (45)	1.895 (48)	0.67 (17)	2.38 (60)
FME-TC258-OR	1.981 (50)	2.133 (54)	1.917 (49)	2.069 (53)	1.00 (25)	2.25 (57)
FME-TC1230-OR	2.28 (58)	2.40 (61)	2.216 (56)	2.336 (59)	0.75 (19)	2.80 (71)
FME-TC209-OR	3.27 (83)	3.562 (90)	3.20 (81)	3.492 (89)	1.12 (28)	3.69 (94)

Tapered Caps and Plugs CPT Center Pull Tab series

This plug has the same configuration and dimensions of standard tapered caps and plugs, but with an integral center-pull tab which facilitates insertion and removal of the plug. The tab extends well above the plug body, making it easy to grasp. Since the tab will not break off during removal. Available with a machined punch in the tab. Also available with a STOP tag installed.



see page 78 for stop tags

Part No. Pkg Qty 100	Part No. Punched Pkg Qty 100	Part No. Punched With Stop Tag Pkg Qty 10	A in(mm)	B in(mm)	C in(mm)	D in(mm)
FME-229P*	FME-PP229*	FME-STI-229P-10PK	0.331(8)	0.397(10)	0.56(14)	0.38(10)
FME-204P	FME-PP204	FME-STI-204P-10PK	0.803(20)	0.912(23)	1.06(27)	0.66(17)
FME-249P	FME-PP249	FME-STI-249P-10PK	0.967(25)	1.092(26)	1.25(32)	0.78(20)
FME-252P	FME-PP252	FME-STI-252P-10PK	1.224(31)	1.355(34)	1.50(38)	0.75(19)
FME-255P	FME-PP255	FME-STI-255P-10PK	1.633(41)	1.75(44)	1.94(49)	0.78(20)
FME-206P	FME-PP206	FME-STI-206P-10PK	1.797(46)	1.938(49)	2.16(55)	1.00(25)
FME-198P	FME-PP198	FME-STI-198P-10PK	2.23(57)	2.27(58)	2.50(64)	0.50(13)
FME-207P	FME-PP207	FME-STI-207P-10PK	2.30(58)	2.464(63)	2.66(68)	1.00(25)

*In stock in orange only

TPN Series Plugs

Resists oil and heat up to 250 degrees

but is not intended for permanent application

Material: High-Density Polyethylene

Add color code to part number to designate color choice.

Colors: Orange (-OR) and Red (-R)

Applicable Spec: MIL-C-5501/5, NAS 840

Sold in packages of 100 pieces.

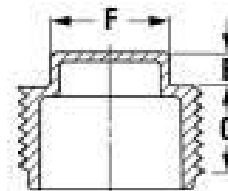
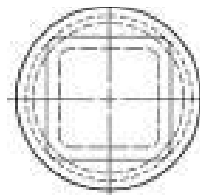

Part No.	B in(mm)	C in(mm)	F in(mm)	To Plug NPT Thread Size
FME-TP1*	0.25(6)	0.29(7)	0.28(7)	1/8- 27
FME-TP31KK1	0.25(6)	0.35(9)	0.38(10)	1/4- 18
FME-TP5Q1	0.25(6)	0.42(11)	0.44(11)	3/8- 18
FME-TP71KK1	0.25(6)	0.47(12)	0.56(14)	1/2- 14
FME-TP9Q1	0.25(6)	0.52(13)	0.62(16)	3/4- 14
FME-TP11Q1**	0.25(6)	0.59(15)	0.81(2')	1- 11-1/2
FME-TP131KK1**	0.38(10)	0.83(21)	1.00(25)	1-1/4- 1-1-1/2
FME-TP15Q1**	0.38(10)	0.83(21)	1.25(32)	1-1/2- 1-1-1/2

* In stock in orange only **Also in stock in fluorescent green and yellow

PT Series Knurled Head NPT Threaded Plugs

Knurled head design allows the user to install or remove these by hand easier. Used to protect NPT threads against contaminants and moisture.

Material: High-Density Polyethylene

Color : Red

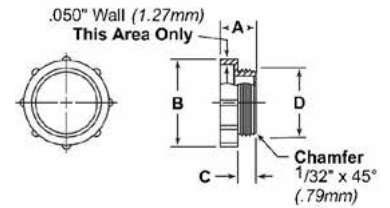

Part No.	To Fit NPT Thread Size	A in(mm)	B in(mm)	C in(mm)	D in(mm)
FME-PT1/4	1/4in	0.5(13)	0.725(18)	0.225(6)	0.44(11)
FME-PT3/8	3/8in	0.475(12)	0.9(23)	0.225(6)	0.585(15)
FME-PT1/2	1/2in	0.5(13)	1.12(28)	0.25(6)	0.7(18)
FME-PT3/4	3/4in	0.5(13)	1.3(33)	0.25(6)	0.94(24)
FME-PT1	1in	0.5(13)	1.565(40)	0.25(6)	1.18(30)

Swage Series Caps and Plugs CD Series Caps

Knurled for ease of application, CD Series caps seal flared JIC fittings exceptionally well against dirt and moisture, and are also used for masking during painting and plating.

Material: Low-Density Polyethylene

Add color code to part number to designate color choice.

Colors: Orange (-OR) and Red (-R)

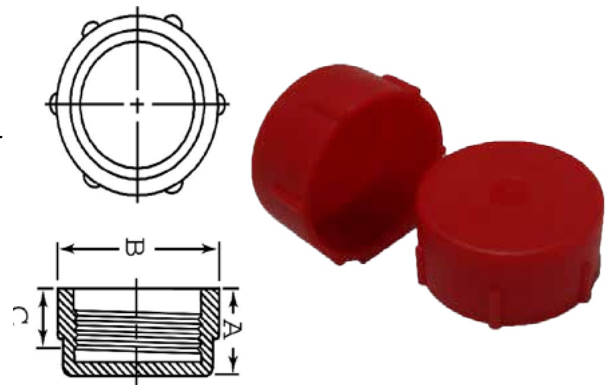

Part No.	To Fit Thread Size	A in(mm)	Fits Hydraulic Fitting Size	No. of Knurls
FME-CD2	1/4 - 36in	0.22(6)	N/A	4
FME-CD3	3/8 - 24in	0.47(12)	3/16in	4
FME-CD4	7/16 - 20in	0.47(12)	1/4in	4
FME-CD5	1/2 - 20in	0.47(12)	5/16in	6
FME-CD6	9/16 - 18in	0.53(13)	3/8in	6
FME-CD8	3/4 - 16in	0.57(14)	1/2in	6
FME-CD12	1- 1/16 - 12in	0.75(19)	3/4in	8
FME-CD16*	1-5/16 - 12in	0.84(21)	1in	8

* In stock in orange only

PDE Series Plugs

Knurled for ease of application, PDE series plugs are designed to fit compression fitting (swage) tubes as well as nut assemblies interchangeably.

Material: Low-Density Polyethylene

Add color code to part number to designate color choice.

Colors: Orange (-OR) and Red (-R)

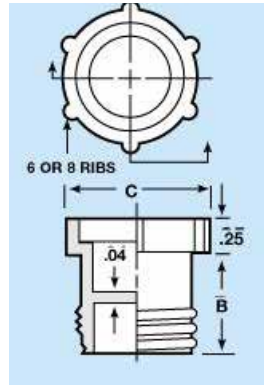

Part No.	To Fit Thread Size	B in(mm)	C in(mm)
FME-PDE4	7/16-20in	0.4(10)	0.56(14)
FME-PDE6	9/16-18in	0.48(12)	0.68(17)
FME-PDE8	3/4-16in	0.54(14)	0.87(22)

TC Metric Series Caps

Metric Threaded Caps

Protects threaded components from dust, moisture and damage during production, storage and shipment.

Designed with an easy to grip head for ease of hand. installation.

Available in Red

Material: Low-Density Polyethylene.

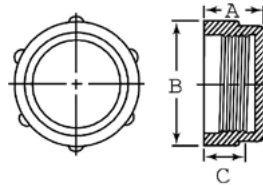

Part No.	To Fit Metric Thread Size	A in (mm)	B in(mm)	C in(mm)
FME-12100A	M8 x 1	0.394(10)	0.472(12)	0.295(8)
FME-12101A	M10 x 1	0.394(10)	0.539(14)	0.295(8)
FME-12102A	M12 x 1	0.472(12)	0.622(16)	0.374(10)
FME-12104A	M14 x 1.5	0.472(12)	0.697(18)	0.374(10)
FME-12105A	M16 x 1.5	0.472(12)	0.776(20)	0.374(10)
FME-12106A	M18 x 1.5	0.551(14)	0.85(22)	0.453(12)
FME-12107A	M20 x 1.5	0.551(14)	0.925(24)	0.374(10)
FME-12108A	M22 X 1.5	0.543(14)	1.024(26)	0.453(12)
FME-12109A	M24 x 1.5	0.551(14)	1.142(29)	0.453(12)
FME-12110A	M25 x 1.5	0.551(14)	1.122(29)	0.453(12)
FME-12111A	M26 x 1.5	0.551(14)	1.181(30)	0.453(12)
FME-12967A	M28 x 1.5	0.488(12)	1.26(32)	0.551(14)
FME-12122A	M30 x 2	0.453(12)	1.339(34)	0.61(16)
FME-12123A	M36 x 2	0.63(16)	1.587(40)	0.531(14)
FME-12124A	M42 x 2	0.63(16)	1.831(47)	0.531(14)
FME-12126A	M52 x 2	0.63(16)	2.224(57)	0.531(14)

Push-On Metric Caps

These easy-to-use push-on caps are designed to protect metric fittings. Intended to be reused, this durable cap has a flange for ease of installation and removal. While this cap was developed for metric fittings, its versatile design enables it to be used on a wide variety of threaded and non-threaded fittings.

Material: Low Density Polyethylene

Color: Red

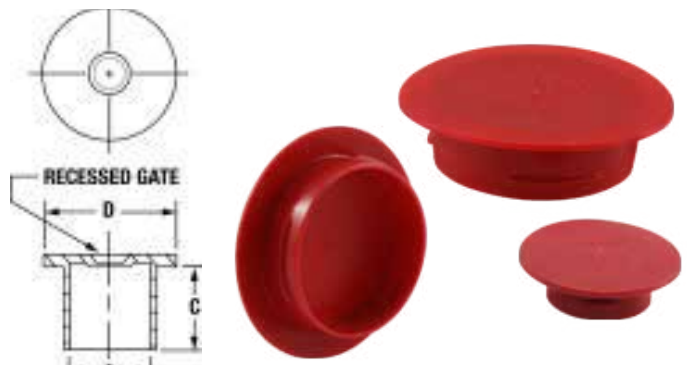

Part No.	To Cap Metric Thread Size	A in(mm)	C in(mm)	D in(mm)
FME-PM10	M10	0.384(10)	0.323(8)	0.689(18)
FME-PM12	M12	0.463(12)	0.47(12)	0.768(20)
FME-PM14	M14	0.54(14)	0.47(12)	0.846(22)
FME-PM16	M16	0.617(16)	0.47(12)	0.925(24)
FME-PM18	M18	0.696(18)	0.47(12)	1.004(26)
FME-PM20	M20	0.774(20)	0.553(14)	1.083(28)
FME-PM22	M22	0.855(22)	0.553(14)	1.161(30)
FME-P0100	M27	1.051(28)	0.75(19)	1.31(33)
FME-P0110	M30	1.175(30)	0.75(19)	1.44(37)
FME-PM33	M33	1.285(31)	0.689(18)	1.594(41)
FME-PM38	M38	1.481(38)	0.689(18)	1.791(45)
FME-PM42	M42	1.641(42)	0.689(18)	1.949(50)

UN Series

Quick Fit Plugs for Standard/JIC/Metric/BSP Threads.

This uniquely-designed range of plugs have sets of blades which will lock tight when pushed into a threaded hole and twisted.

Each plug covers a range of different thread sizes and styles.

Easily removes by simply unscrewing the plug from the thread.

Material: Low-Density Polyethylene

Color: Red

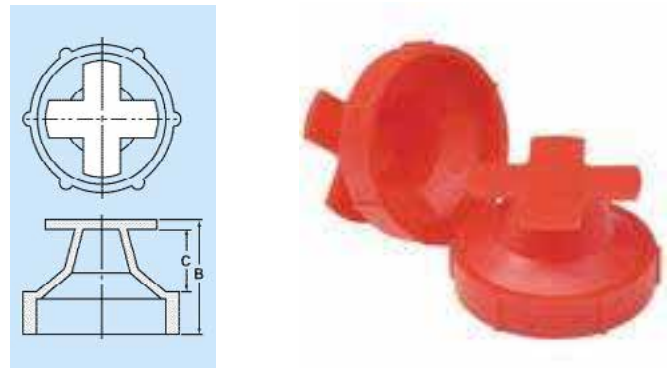

Part No.	To Fit NPT Thread Size	To Fit Standard Thread Size	To Fit Metric Thread Size	To Fit BSP Thread Size	A in(mm)	B in(mm)
FME-UN9995A	N/A	N/A	N/A	N/A	0.42(11)	0.233(6)
FME-UN9996A	1/8 in	7/16 in	M10	1/8 in	0.438(11)	0.24(6)
FME-UN9997A	1/4 in	9/16 in	M14	N/A	0.575(15)	0.285(7)
FME-UN9998A	N/A	1/2 in	M12	1/4 in	0.485(12)	0.325(8)
FME-UN9763A	N/A	3/4 in	M16-20	3/8 in	0.78(20)	0.375(10)
FME-UN9764A	N/A	1 in	M20-24	1/2 in - 5/8 in	0.99(25)	0.445(11)
FME-UN9774A	3/4 in	1 3/16 in	M30	3/4 in - 7/8 in	1.24(31)	0.435(11)
FME-UN9765A	N/A	1 7/16 in	M33-36	1 in	1.475(37)	0.445(11)

TP Metric Series Plugs

This series accommodates an extensive range of metric and BSP/Gas threaded sizes.

Knurled head for easy grip.

Secure fit for excellent protection against dirt, corrosion and moisture.

Material: Low-Density Polyethylene

Available in Red

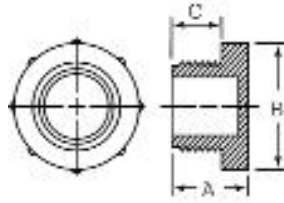

Part No.	To Fit Metric Thread Size	A (in)	A (mm)	B (in)	B (mm)	C (in)	C (mm)
FME-12011A	M8 x 1	0.562	14	0.484	12	0.374	10
FME-12012A	M10 x 1	0.574	15	0.602	15	0.409	10
FME-12013A	M12 x 1	0.657	17	0.728	18	0.421	11
FME-12017A	M12 x 1.5	0.641	16	0.657	17	0.342	9
FME-12018A	M14 x 1.5	0.677	17	0.728	18	0.374	10
FME-12019A	M16 x 1.5	0.677	17	0.866	22	0.492	13
FME-10458A	M18 x 1.5	0.72	18	0.96	24	0.539	14
FME-12020A	M20 x 1.5	0.716	18	1.035	26	0.551	14
FME-10128A	M22 x 1.5	0.72	18	1.11	28	0.539	14
FME-12021A	M24 X 1.5	0.728	18	1.232	31	0.543	14
FME-12022A	M25 x 1.5	0.728	18	1.232	31	0.551	14
FME-12023A	M26 x 1.5	0.736	19	1.287	33	0.543	14
FME-12030A	M52 x 1.5	0.846	22	2.508	64	0.61	16

EZP Series Plugs

Easily locks into place. A simple push permits fast removal using the attached flexible pull tab.

Stop tags can easily be attached to tab.

Material: Low-Density Polyethylene

Color : Red

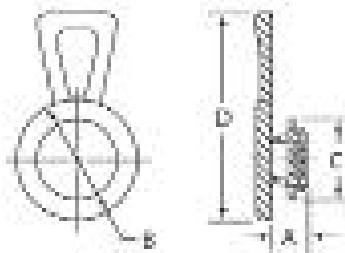

Part No.	To Fit Standard Thread Size	To Fit Metric Thread Size	A in(mm)	B in(mm)	C in(mm)	D in(mm)
FME-EZP1020	7/16 in	M10,M12	0.3(8)	0.748(19)	0.52(13)	1.34(34)
FME-EZP1030	1/2 in, 5/8 in, 9/16 in	M14,M16	0.275(7)	0.893(23)	0.649(17)	1.574(40)
FME-EZP1040	3/4 in	M18,M20	0.314(8)	1.181(30)	0.767(20)	1.85(47)
FME-EZP1050	7/8 in	M22,M24	0.374(10)	1.35(34)	0.937(24)	2.023(51)
FME-EZP1060	1 1/6 in, 1 1/8 in	M26,M28	0.374(10)	1.574(40)	1.086(28)	2.244(57)

Flange Protector Plugs

These protectors have a tapered body and wide flange to protect the entire machined surface of the valve flange. Friction-fits to the valve bore

Color: Orange

Material: Low-Density Polyethylene

Part No.	Description	Size (in)	Size (mm)	Qty
F-FP1191AH1	Flange Plug 5 in	5.02	128	25 Pack
F-FP1201AH1	Flange Plug 6 in	5.915	150	25 Pack

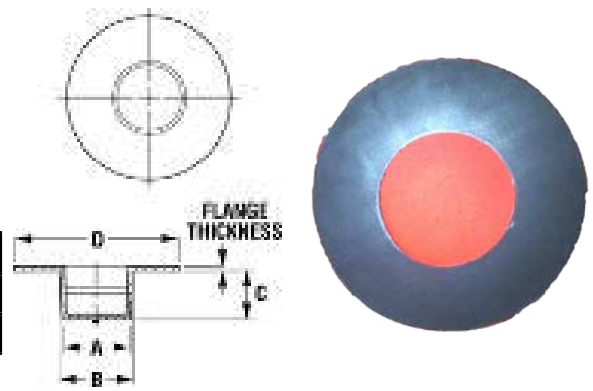

Flange Covers

Widely viewed as the industry standard for flange protection, the snap-in flange protectors require no additional fastening devices. Simply insert the flange into bolt holes and apply minimal pressure. These flange protectors were engineered for quick and easy installation. The FC series is resistant to petroleum residues.

Material: Low-Density Polyethylene

Color: Orange (-OR) some sizes available in Green (-GN)

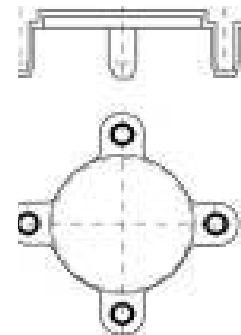

Part No.	Pipe Size (in)	Pipe Size (mm)	Qty
F-FC150-050	0.5	N/A	100 Pack
F-FC150-075	0.75	N/A	100 Pack
F-FC150-1	1	25.4	100 Pack
F-FC150-1-050	1.5	N/A	100 Pack
F-FC150-2	2	50.8	50 Pack
F-FC150-3	3	76.2	50 Pack
F-FC150-4	4	101.6	50 Pack
F-FC150-6	6	152.4	25 Pack
F-FC150-8	8	203.2	25 Pack
F-FC150-10	10	254	25 Pack
F-FC150-12	12	304.8	25 Pack

Flange Covers 300lb PSI

F-FC300-050	0.5	N/A	100 Pack
F-FC300-075	0.75	N/A	100 Pack
F-FC300-1	1	25.4	100 Pack
F-FC300-1-025	1.25	N/A	100 Pack
F-FC300-1-050	1.5	N/A	100 Pack
F-FC300-2	2	50.8	50 Pack
F-FC300-3	3	76.2	50 Pack
F-FC300-4	4	101.6	50 Pack
F-FC300-6	6	152.4	25 Pack
F-FC300-8	8	203.2	25 Pack
F-FC300-10	10	254	25 Pack
F-FC300-12	12	304.8	25 Pack



FME Signs	77
Magnetic FME Signs	77
Magnetic Signs	77
Low Chloride Metal Markers	78
Stop Tags	78
Banners	78
FME Magnetic Sheets	79
Nuclear Grade Duct Tape	79
Barrier Tape	79
FME Adhesive Floor Tape	80
Pennant Lines	80
Labels	80
Hard Hat Labels	81
Floating Cable Ties / Tie Wraps	81
Speedwraps	81
Custom Printed Mats	82
Hog Heaven II Modular	83
Comfort Tile	83
Comfort Tile with Grit	83
Kneeling Comfort	83
Comfort Flow	83
Stanchions	84
Wall Mount Stanchions	85
Stanchion Belt Ends	86
Stanchion Pack	86
Retracta-Cone	87
The Retracta-Cade Crowd Control Barrier	87
Retracta-Cade Light Kits	87
FME Vests	88
FME Armbands	88
FME Culture Awareness	89
Posters	90



FME Signs

Colors: Orange (-OR), Red (-R), or Pink (-PK)

Part No.	Description	Qty.
FME-SGNBZ	FME Buffer Zone Sign 11in x 8.5in	10 Pack
FME-SGNZCST	FME Custom Zone Sign 11in x 8.5in	10 Pack
FME-SGNFLTG	FME Floating Sign 11in x 8.5in	10 Pack
FME-SGNZ1-10x12-R	FME Zone 1 Sign 10in x 12in	10 Pack
FME-SGNZ2-10x12-R	FME Zone 2 Sign 10in x 12in	10 Pack



Magnetic FME Signs

Colors: Orange (-OR), Red (-R), or Pink (-PK)

	Part No.	Size	Qty.
A	FME-SGN-4x4MAG	4 in x 4 in	10 Pack
	FME-SGN-8x8MAG	8 in x 8in	10 Pack
B	FME-SGN-6MAG	6 in diameter	10 Pack
	FME-SGN-12MAG	12 in diameter	10 Pack



Magnetic Signs

Part No.	Description	Qty.
FME-SGNMAG10x10	Magnetic Breaker Removed Sign 10in x 10in	10 Pack
FME-SGNMAG16x16	Magnetic Breaker Removed Sign 16in x 16in	10 Pack
FME-SGN-RSMG-12x8	Rigid Styrene custom Printed with Rare Earth Magnets 12in x 8in	10 Pack
FME-SGN-RSMG-14x14	Rigid Styrene custom Printed with Rare Earth Magnets 14in x 14in	10 Pack



Low Chloride Metal Markers

- Markers will not cause damage to the integrity of the metal
- Marks on rough, smooth, wet, oily or dry surfaces
- Withstands heat and weathering and does not chip, peel, fade or rub-off
- Meets specifications for stainless steel and nuclear components
- Independent laboratory certifications of analysis are available
- Colors: White, Yellow, Black, Red, Blue, Green, Orange, and Pink

Also Available: Low Chloride Standard Paint Marker, Low Chloride Felt tip Paint Marker, Low Chloride Fine Point Paint Marker, Low Chloride Jumbo Solid Paint Marker

Color	Part No. Thickness 5/64 in	Part No. Thickness 1/8 in	Part No. Thickness 3/16 in
White	F-00250	F-00251	F-00252
Yellow	F-00253	00254	F-00255
Black	F-00256	F-00257	F-00258
Red	F-00259	F-00260	F-00261
Blue	F-00262	F-00263	F-00264
Green	F-00265	F-00266	F-00267
Orange	F-00268	F-00269	F-00270
Pink	F-00271	F-00272	F-00273



Also Available:
Low Chloride Standard Paint Marker, Low Chloride Feltip Paint Marker, Low Chloride Fine Point Paint Marker, Low Chloride Jumbo Solid Paint Marker

Stop Tags

- FME Stop Tags are dielectric and reusable
- Choose the consecutively numbered signs for inventory control
- Made in the USA
- Colors: Orange (-OR), Red (-R), or Pink (-PK)

Part No.	Description	Qty.
FME-STOP	FME Stop Tag	25 Pack
FME-STOP-CT	FME Stop Tag with Cable Ties	25 Pack
FME-STOP-NR	FME Stop Tag with Consecutive Numbers	25 Pack



Banners

- Fabric Banners with: magnets, grommets or buttonholes
- Made in the USA

Colors: Orange (-OR), Red (-R), or Pink (-PK)

Part No.	Description
FME-BNR2	FME Banner 2ft
FME-BNR3	FME Banner 3ft
FME-BNRHRISK	FME Banner High Risk
FME-BNRSTDRISK	FME Banner Standard Risk
FME-BRNFMEZ	FME Zone Banner
FME-SIGN36x48-DFZ	Testing Sign-Distraction Free Zone



FME Magnetic Sheets

Best uses:

- Cover small openings
- Easily cut to any size
- Colors: Orange (-OR), Red (-R), or Pink (-PK)



Part No.	Size
FME-MAG24X36	24 in x 36 in

Nuclear Grade Duct Tape

In stock Colors: Red (-R)

Part No.	Description	Qty.
FME-TAPE-DCT-NUC-R	Nuclear Grade Duct Tape Red	24 Rolls

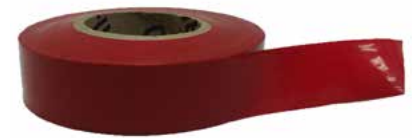

Barrier Tape

*Custom Printing Available



Part No.	Description	Qty.
FME-TAPE	FME Boundary Tape 3 in x 1000 ft (7.6cm x304.8m)	10
FME-TAPE-BZ	FME Buffer Zone Tape 3 in x 1000 ft (7.6cm x304.8m) orange	10
FME-TAPE-AR	FME Area Tape 3 in x 1000 ft (7.6cm x304.8m) pink	10
FME-TAPE-FZ-WO	FME Area Diagonal Stripe 3 in x 1000 ft (7.6cm x304.8m) white/orange	10
FME-TAPE-PK1	FME ZONE 1 in wide tape 1 in x 500 ft (2.54 cm x 152.4 m) pink	10
FME-TAPE-BT-21	Caution Radiation Area yellow/magenta	10
FME-TAPE-BT-66	Caution "Cuidado" Caution yellow w/ black lettering	10
FME-TAPE-BT-15	Caution Men Working Overhead yellow w/ black lettering	10
FME-TAPE-BT-56	Caution Authorized Personnel Only yellow w/ black lettering	10
FME-TAPE-BT-57	Caution Entry Requires Permission yellow w/ black lettering	10
FME-TAPE-BT-58	Caution Restricted Area Keep Out yellow w/ black lettering	10
FME-TAPE-BT-49	Danger Danger Danger red w/ black lettering	10
FME-TAPE-BT-50	Danger Do Not Enter red w/ black lettering	10
FME-TAPE-BT-51	Danger Hazardous Area red w/ black lettering	10
FME-TAPE-BT-52	Danger Hazardous Area Keep Out red w/ black lettering	10
FME-TAPE-BT-53	Danger Hazardous Material Do Not Enter red w/ black lettering	10
FME-TAPE-BT-54	Danger High Voltage Area red w/ black lettering	10
FME-TAPE-BT-55	Danger Keep Out red w/ black lettering	10
FME-TAPE-BT-60	Danger Confined Space Do Not Enter red w/ black lettering	10

FME Adhesive Floor Tape

Dimensions: 3 in x 36 yd (7.6 cm x 32.9 m)

Part No.	Description	Qty.
FME-TAPE-FL	FME Adhesive Floor Tape	10
FME-TAPE-FL-BAR	FME Barrier Floor Tape, red or orange	10
FME-TAPE-FLRBAR/RU	FME Barrier with ruler markings, orange	10
FME-TAPE-FL-BZ	FME Buffer Zone, red, orange or green	10
FME-TAPE-FL-HR	FME High Risk, orange	10
FME-TAPE-FL-MR	FME Medium Risk, orange	10
FME-TAPE-FL-CCA-YW	FME Configuration Control Area, yellow	10
FME-TAPE-FL-FZ	FME Zone 1 red	

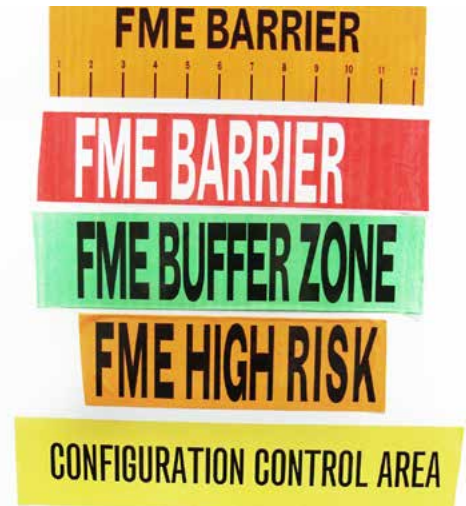

Pennant Lines

Dimensions: Pennant size is 12in. x 9in. and the length of the pennant line is 60ft. Custom printing available

Part No.	Description
FME-TAPE-PEN5	Caution
FME-TAPE-PEN31	Black / Yellow Stripes
FME-TAPE-PEN49	Danger
FME-TAPE-PEN55	Danger Keep Out



Labels

Colors: Orange (-OR), Red (-RED), Pink (-PK), or Green (-GN)



	Part No.	Description	Qty.
A	FME-LABEL2X3	FME Labels 2in x 3in	250 Roll
	FME-LABEL3X5	FME Labels 3in x 5in	250 Roll
B	FME-LABEL2X3-SP	Barrera FME 50mm x 75mm Spanish Labels	250 Roll
	FME-LABEL3X5-SP	Barrera FME 75mm x 125mm Spanish Labels	250 Roll
C	FME-LABEL1.5	1.5 in x 1.5 in vinyl Labels	1000 Pcs

Hard Hat Labels

Custom labels available.

Part No.	Description	Qty.
FME-LABELHH-FM	FME Monitor Labels	25 Pack
FME-LABELHH-FME	FME Labels	25 Pack



Floating Cable Ties / Tie Wraps

No metal components

Zero absorption

Sold in 250/Pks

Colors: Orange (-OR), Yellow (-YW), Green (-GN), Red (-R)

Part No.	Size
F-L-R0008	8in / 200mm
F-L-R022	11in / 275mm
F-L-R145	14.5in / 368mm



Speedwraps

Industrial strength die cut Velcro Ties

Colors: Orange (-OR), Red (-R), Green (-GN), Blue (-BL), Black (-BLK), White (-W), Yellow (-YW)



Part No.	Size (in)	Size (mm)	Qty.
F-SW.5x6	0.5in x 6in	150mm length	100 pack
F-SW.5x8	0.5in x 8in	200mm length	100 pack
F-SW.5x11	0.5in x 11in	275mm length	100 pack
F-.SW75x15	0.75in x 15in	375mm length	100 pack
F-.SW75x18	0.75in x 18in	450mm length	100 pack
F-SW.75x24	0.75in x 24in	600mm length	100 pack
F-SW2X48	2in x 48in	50mm x 120cm	Rolls/each
F-SW3X72	3in x 72in	50mm x 180cm	Rolls/each
F-SW3X96	3in x 96in	50mm x 240cm	Rolls/each

Custom Printed Mats

Alphasource® has you covered with the best quality industrial and custom floor matting. Call and speak to our in-house designer for available sizes and custom solutions.



Classic Impressions Custom Shape
F-MAT733
Description
Any custom shape. Heavy 32oz/sq yd High twist heat-set nylon face fabric. Heavy 90mil rubber backing 20% recycled rubber. 4 Color Process. For Indoor Use.

Hog Heaven
F-MAT422
Description
Anti-fatigue. Safe for welding areas. Custom mats available. Certified Slip Resistant. Anti-Static. 17 Logo Colors. 8 Background Colors.

Classic Impressions HD Logo
F-MAT73
Description
150 Color Options. 20% Recycled Rubber. For Indoor Use.



Superscrape Impressions Logo
F-MAT3559
Description
150 Color Options. UV Stable. 15% Recycled Rubber. Indoor/Outdoor Mat.

Waterhog Logo Inlay
F-MAT234
Description
UV Stable Polypropylene. 19 standard Color Options. 20% Recycled Rubber. For Entryway Use.

Waterhog ECO Elite
F-MAT2268
Description
17 Logo colors. 8 Background colors. Indoor/Outdoor Mat. Choose for larger mats up to 20ft. (6m)

Industrial Mats

Hog Heaven II Modular

- Anti-fatigue mats for dry areas
- Oil and chemical resistant
- Welding safe and electrically conductive
- Available in 18"x18" or 36"x36" tiles



Part No.	Description
F-MAT-MID-01	Middle Tile
F-MAT-SIDYLO-04	Side Tile with Stripe Yellow Border
F-MAT-CORYLO-05	Corner Tile with Stripe Yellow Border

Comfort Tile with Grit

Part No.	Description
F-MAT-MID-01-GT	Grit Middle Tile
F-MAT-SIDYLO-04-GT	Grit Side Tile with Stripe Yellow Border
F-MAT-CORYLO-05-GT	Grit Corner Tile with Stripe Yellow Border



Kneeling Comfort

- Closed-cell blended nitrile rubber cushion
- Thick nitrile rubber base
- Electrically conductive
- Grease and oil proof, non-absorbent
- Built in handle for easy transportation
- Made of partially recycled material

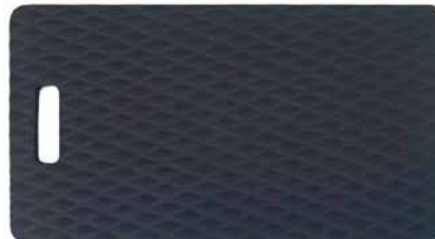

Part No.	Size
F-MAT433	12in x 22in

Comfort Flow

- High density nitrile rubber cushion
- Grease and oil proof chemical resistant
- Lifetime anti-microbial treatment to prevent odors and degradation
- Drainage holes
- Made of partially recycled material



Part No.	Description
F-MAT420	Comfort Flow Mat

Stanchions

Stanchions are the perfect solution for large areas that need to be designated. We offer high quality custom printed belts for your specific applications and needs.



Custom Stanchion Options Custom Stanchion Pole Finishes



Custom Stanchion Belt Colors and Printing Options

Standard Belt Options	
BK - Black	GN - Green
GR - Grey	DG - Dark Green
WH - White	LB - Light Blue
BN - Brown	BL - Blue
MN - Maroon	DB - Dark Blue
RD - Red	PL - Purple
OR - Orange	FY - Fluorescent Yellow
YW - Yellow	FO - Fluorescent Orange
	BW - Black/White Stripe

Specialty Belt Options (Double Sided)	
	BYD - Black/Yellow Diagonal
	RWD - Red/White Diagonal
	MYD - Magenta/Yellow Diagonal
	THIS LANE CLOSED TLC - This Lane Closed
	CAUTION-DO NOT ENTER CAU - Caution-Do Not Enter
	DANGER-KEEP OUT DKO - Danger-Keep Out
	NO ENTRY NE - No Entry
	AUTHORIZED ACCESS ONLY AAO - Authorized Access Only



Stanchion with Custom Finish Pole and Retractable-Belt



Part No.	Description
FME-STN15	15ft Retractable-Belt 2.5in diameter post with 3.25in diameter head 14in diameter base weight with floor protectors 27lb overall weight, 40in overall post height
FME-STN30	30ft Retractable-Belt 2.5in diameter post with 4in square head 14in diameter 30lb weather proofed base weight, 38lb overall weight 2.5in diameter outdoor rated wheels

Wall Mount Stanchions

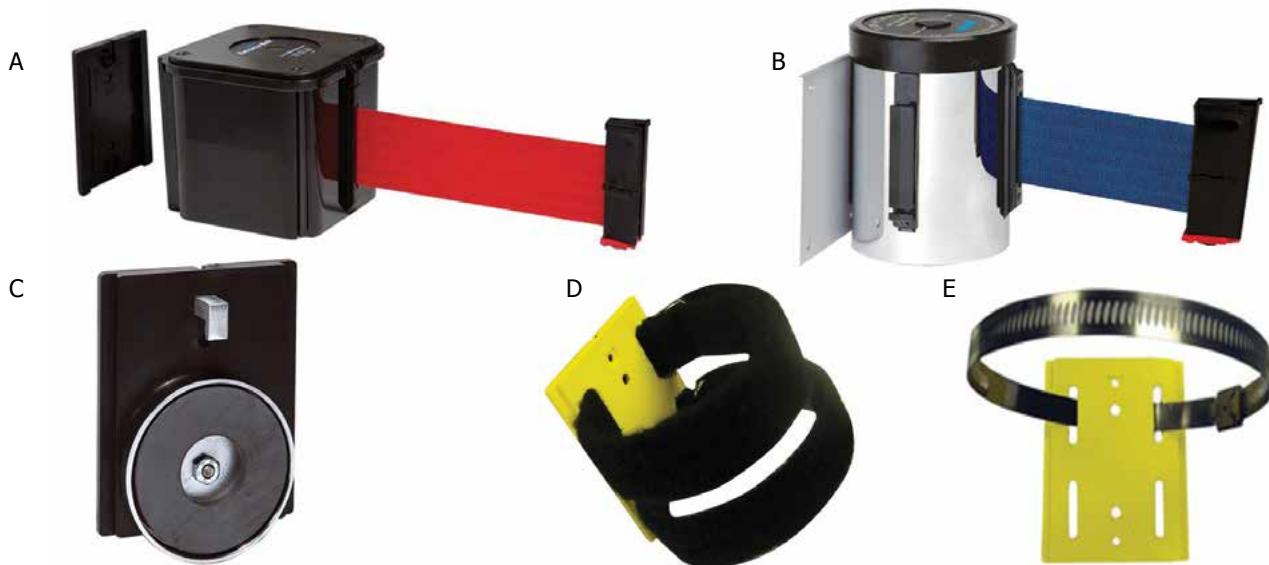

Part No.	Description
A	FME-STN-WM412 412 Series Wall Mount Unit
B	FME-STN-WM700 700 Series Wall Mount Unit
C	FME-STN-WMXX-MM Mount Magnet
D	FME-STN-WMXX-VM Velcro Mount
E	FME-STN-WMXX-HCM Hose Clamp Mount

Stanchion Belt Ends



Part No.	Description
A FME-STN-WMXX-YY-MBE	Magnetic Belt End
B FME-STN-WMXX-YY-SC	Suction Cup Belt End
C FME-STN-WMXX-YY-BE	Universal Belt End (Standard)
D FME-STN-WMXX-YY-SH	S-Hook Belt End

Stanchion Pack with Chain and Sign Adapters

- 2.5 in. stanchion
- 2.5 in. diameter pole and 14in. base
- 2.5 pounds or 6.5 pounds when base is filled with sand
- Overall height is 40in.
- Made from high density polyethylene containing UV inhibitors, and rustproof
- Available in packs of four or six
- Available Colors: Pink (-PK), Orange (-OR), Green (-GN) or Yellow (-YW)



Part No.	Description
FME-STN-PL-PK4	4 pack of stanchions with chain
FME-STN-PL-PK6	6 pack of stanchions with chain
FME-STN-PL-CHAIN	2 in heavy duty safety barrier chain for indoors/outdoors.

Retracta-Cone

- A highly visible warning against hazardous areas
- Safer alternative to floor or caution tape
- Reusable, more visible, and more durable
- Multiple mounting and receiving options
- Available in 10ft, 15ft, and 29ft belt lengths



Part No.	Description
FME-STN-RETCN10	10ft Retracta-Cone Topper
FME-STN-RETCN15	15ft Retracta-Cone Topper

The Retracta-Cade Crowd Control Barrier

- Crowd control where and when you need it
- The Retracta-Cade: Heavy-duty 37lbs.
- Barrier provides immediate security at low cost
- Easily retracts for easy storage and transport
- Deployed Size: 120inL x 32inD x 41inH
- Retracts to: 48inL x 8inD x 12inH
- Made in the USA



Part No.	Size
FME-STN-RETCADE	120inL x 32inD x 41inH

Retracta-Cade Light Kits

- LED lights slide into the top of the Retracta-Cade for increased visibility at day or night
- Hard carrying case charges and stores six LED lights
- Lights are waterproof and impact-resistant
- Colors: Red (-R), Yellow (-YW), or Blue (-BL)



Part No.	Description
FME-STN-RETCADE-LIG	Retracta-Cade Light Kit

FME Vests

- Lightweight ANSI /SEA 107-2010 Class 2 safety vests
100% Polyester
- All vests are available in different colors and custom printing
- Sizes: Medium - 4XL
- Also available in mesh material



	Part No.	Description	QTY
A	FME-VESTMNTR	FME Monitor Vest	5
B	FME-VESTCRANE	Crane Spotter Vest	5
C	FME-VESTBRIDGE	Bridge Spotter Vest	5
D	FME-VEST-F301I	Orange Class 2 Arc1 Safety Vest	5
E	FME-VEST-CSTM-Y	Yellow Safety Vest Custom Printed	5
F	FME-VESTSHRF	FME Sheriff's Vest with Sheriff Badge	5

FME Armbands



	Part No.	Description	QTY
A	FME-AB-EVAL	FME Fire Armband	5
B	FME-AB-TRNR	FME Trainer Armband	5
C	FME-AB-FM	FME Monitor Armband	5

FME Culture Awareness

Drive your message and FME program with: Posters, t-shirts, polos, hats, stress balls, Koosies, pens, water bottles, flashlights, and other custom items. Stress balls come in many shapes, such as the football, patriotic stress ball and atom pictured. Ask your Alphasource® Consultant for a recommendation specific to your program.

GEAR



	Part No.	Description
A	FME-HATS-CSTM	Custom Hats
B	FME-TSHIRTS-CSTM	Custom T-Shirts
D	FME-SCKPCK-CSTM	Custom Snack Packs
E	FME-KOOSIE-CSTM	Custom Koosie
F	FME-STRESSBALL-CSTM	Custom Stress Balls

POSTERS

Alphasource® has you covered with FME Control, Sports Themes, FMI, and Drop Prevention Awareness Posters. Ask us for a quote on one of the many designs available.

Sizes:

US	Metric
11 x 17 in	28 x 43 cm
18 x 24 in	46 x 36 cm
24 x 36 in	61 x 91 cm

A



B



C



D



E



F



G



H



I



Part No.	Description
A	FME-PSTR-SP-HCKY Sports theme FME Poster: Hockey
B	FME-PSTR-SP-SCCR Sports theme FME Poster: Soccer
C	FME-PSTR-SP-BKBL Sports theme FME Poster: Basketball
D	FME-PSTR-SP-FTBL Sports theme FME Poster: Football
E	FME-PSTR-HELI FME Awareness Poster: Helicopter Crash
F	FME-PSTR-CELL Foreign Material Controls Poster
G	FME-PSTR-DP-PYM-H Protect Your Melon Drop Prevention "Work Safe"
H	FME-PSTR-DP-PYM-S Protect Your Melon "Safety is Our Culture"
I	FME-PSTR-PLANE FME Awareness Poster: "Focus on FME"



iShot® PTZ-550 Camera System	92
iShot® Retrieval Kit	92
iShot® 7mm OD Color Micro	93
Micro CA-300 Explorer	93
The Micro CA-100	93
Ridgid® Seesnake Accessories	93
Hawkeye® Articulating Borescope	94
Magnetic Trays	94
Drill Magnet	94
Magnetic Ruler	95
Magnetic Accessories	95
Magnetic Pickup Tools	95

iShot® PTZ-550 Camera System

- Features Sony FCB-EV7500 HD Zoom Camera
- 5.5 Inches in diameter with a total operating envelope from fixed mount 7.25 inch sphere
- 7.2lbs
- 30x optical zoom, autofocus and image stabilization
- Automatic wide dynamic range/gain/white balance
- Kevlar reinforced polyurethane cable
- Continuous 360 degree pan
- 245 degree tilt
- 35 watt lamps / one spot / flood
- Waterproof, 6061 Anodized aluminum design
- Submersible to 100 Ft.



Part No.	Description
FME-EM-EM15669	iShot® PTZ-550 Camera System

iShot® Retrieval Kit

- 7mm Diameter OD Camera Head
- NTSC or PAL
- High quality video in low light conditions
- Great for submersible, hazardous, high temp, radiation, and EMI prone environments
- Cabling available in PVC or Teflon® in lengths of 3.5M or 15M
- The Teflon® cable option operates in environments up to 550F (290C)
- Specialty modifications available including multiple field of view lenses



Part No.	Description
FME-EM14533	Catseye 6000 Video Fiberscope
FME-EM14540	Catseye Probe Assembly
FME-EM9063A	iSHOT Catseye V-Probe Reel
FME-EM13987	iShot® iGrab™ RT-750 Complete ElectroMechanical Retrieval Tool Kit with 0.75 OD mechanical body, for standard jaw sets, control box, 100 ft (30.5m) and a case. 300 series stainless steel
FME-EM14451	iShot® iGrab™ RT-1000 FOSAR Complete ElectroMechanical Retrieval Tool Kit with 1.0 OD mechanical body, for standard jaw sets, control box, 100 ft (30.5m) and a case. 300 series stainless steel

iShot® 7mm OD Color Micro Camera

- Kits are available in 15' or 25' lengths
- Flexible stainless steel construction
- 6mm Fork and Tine Tool
- 6mm Gripping Pliers Tool
- 6mm Cup Forcep Tool
- 6.35mm Magnet
- 10mm Viper Tool
- 4mm Snare Tool
- Plunger style handle controls opening and closing
- Kit includes storage/travel case



Part No.	Description
FME-EM-QN43H	iShot® 7mm OD Color Micro Camera

Ridgid® Seesnake

Micro CA-300 Explorer

- Display: 3.5" color LCD (320x240 resolution)
- Image Capture: JPG images and AVI video
- Additional Ports: PAL/NTSC
- Image Controls: brightness, image rotation
- Lighting: Four fully adjustable LEDs
- Camera Diameter: .7" (17mm)
- Cable Reach: 3' (expandable to 30" with optional extensions)
- Waterproof up to 10" when properly assembled
- Power Source: 4x AA batteries

The Micro CA-100

- Easily records still images and videos in hard-to reach areas
- Display: 3.5" color LCD (320x240 resolution), RCA cable included
- Camera head: 17mm diameter made with anodized aluminum
- Utilizes a comfortable pistol-grip design
- Lighting: Four fully adjustable LEDs
- Image Controls: image rotation, brightness
- Waterproof up to 10" when properly assembled
- Power Source: 4x AA batteries
- Attachments: Mirror, hook and magnet



Part No.	DESCRIPTION
FME-BORE-SS-EXPLORER	Micro CA-300 Explorer
FME-BORE	Micro CA-100 Explorer

Ridgid® Seesnake Accessories

Part No.	Description
P/N: FME-BORE-SSE-6	6ft Extender Cable for use with Seesnake Micro & Explorer
P/N: FME-BORE-CAM17	17mm Camera Replacement End
P/N: FME-BORE-CAM6	6mm Camera Replacement End



The Sidewinder™ System

- Best use, inspection of tubes and pipes
- Wireless viewing and recording, extends to 100 ft. long
- Sidewinder™ inspects into tubing as narrow as 13/16 in.
- Records up to 32GB of video and images on a micro SD card
- Image Controls: remote wireless viewing and recording
- Attachments: Easily connects to your PC via USB



Part No.	DESCRIPTION
FME-SDWINDER	The Sidewinder™ System

Hawkeye® Articulating Borescope

- Display: Utilizes a five inch LCD video monitor
- Outer diameter of 4mm
- Heavy-duty travel case included
- Lighting: Built in light source
- OD Custom length video borescopes also available by special order
- Attachments: 90 degree prism tip attachment for 4mm or 6mm



Part No.	Description
FME-BORE-HWKEYE-4/1.5M	4 way articulation, 1.5M length
FME-BORE-HWKEYE-4/3M	4 way articulation, 3M length
FME-BORE-HWKEYE-2	2 way articulation available in 4mm x 1.5M

Magnetic Trays

Part No.	Size
FME-MG-TRY14.65x6.25	14.65in X 6.25in
FME-MG-TRY9.5X5.5	9.5in X 5.5in
FME-MG-6R	6in Diameter
FME-MG-11INX11IN	11in X 11in



Drill Magnet

Part No.	Description
FME-MAG-DRILL	Drill Magnet prevents most metal drill shavings from falling into machines.



Magnetic Ruler

- Flexible and magnetic UV-resistant red and blue ink on a white vinyl surface
- Units of measure: standard and metric
- Sticks to metal surfaces for hands-free measuring
- One meter long



Part No.	Description
FME-MAG-RULER	1 yard/ meter Flexible Magnetic Measuring Tape. Sticks to metal surfaces.

Magnetic Accessories

	Part No.	Description
A	FME-MAG-HOOK	Magnet with carabiner attached
B	FME-MAG-RING	Magnet with quick ring attached
C	FME-MAGRAILBAR	Ceramic bar magnet 25lb pull



Magnetic Pickup Tools

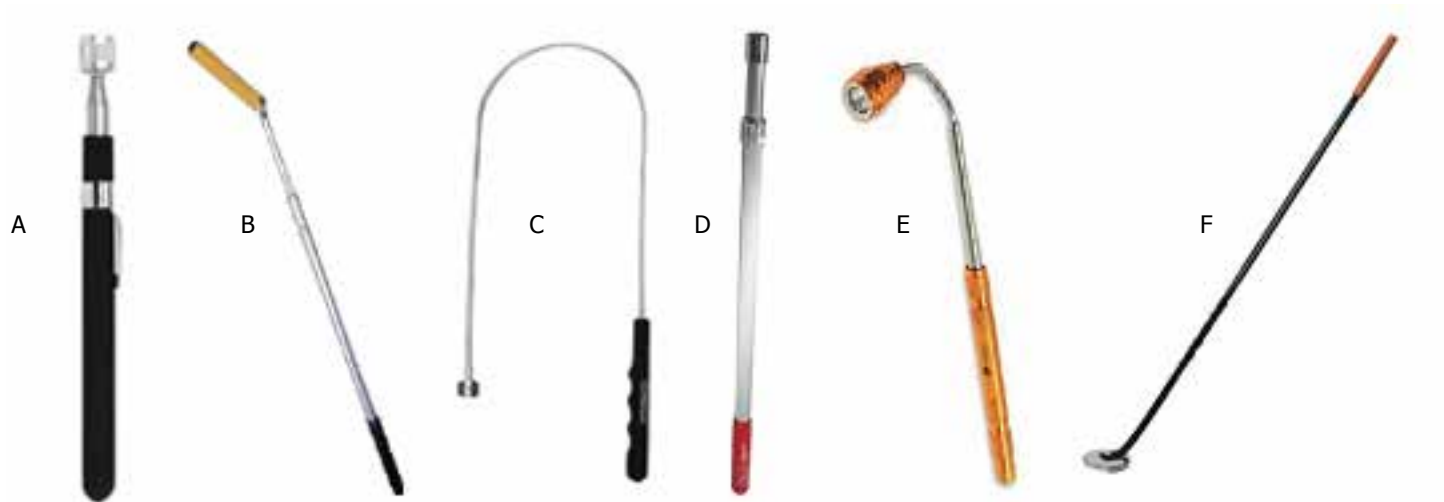

	Part No.	Description
	FME-MAG-HT3	MAG PICK-UP TOOL W/ POWERCAP, WILL LIFT OVER 10lb
A	FME-MAG-PU-U5	MAG PICK-UP TOOL W/ POWERCAP, WILL LIFT OVER 2-1/2lb
	FME-MAG-PU-U2	MAG PICK-UP TOOL W/ POWERCAP, WILL LIFT OVER 5lb
B	F-RT-FLSHDM-OR	CATSPA W FLEXIBLE LIGHTED PICK-UP TOOL
C	FME-MAG-LIS310	FLEXI HEAD PICK UP TOOL 14 1/2in TO 23-1/4in
D	FME-MAG-PU-U2FL	FLEXIBLE MAGNET PICK-UP TOOL
E	FME-MAG-EZRED	MONSTER MAGNET 36in, LIFTS UP TO 10lb
F	FME-MAG-PU40	TELESCOPING MAG PICK-UP PAL, 65lb PULL STRENGTH

The Alphasource RFID Toolsaver® system will eliminate your handwritten logs, provide instant reconciliation of items, and keep track of calibration and/or inspection dates and much more. Alphasource has provided RFID solutions to Exelon, Duke, FPL, First Energy, PSECO and others in the highly regarded nuclear industry. In 2015 American Woodmark Corp, won the Innovation Award of Excellence at APICS. Our software engineers designed and integrated the enterprise wide RFID solution that earned this award.

There are a number of areas where our RFID Toolsaver® can help to reduce human performance issues, eliminate the time spent reconciling logs and providing a real Return on Investment (ROI).



Our Software engineers have developed and delivered systems for agencies and companies such as NASA, ITT Aerospace, US Steel, Merck and many other leading companies.

Toolsaver® RFID Systems Applications

(Radio Frequency Identification)

Toolsaver® RFID systems are completely customizable and site specific. Any Toolsaver® bundle can be a simple turnkey system. Each system can incorporate and interface with existing bar codes and 3rd party software. Ask us for a white paper comparison of RFID & Barcode Systems.

Tool Cribs

With our system, companies can streamline the process of checking in/checking out tools and the associated paper logs that have been used in the past. The Alphasource, Inc. Toolsaver® RFID System automatically assigns tools to the personnel checking them out and deletes them from his /her file when they are returned. Any tools still outstanding will result in a notification screen alerting the attendant and employee of this. This instant accountability and electronic database means that tools will be returned more often and if they are not, will be more easily located and accounted for. Save time, increase accountability and minimize tool losses. Any items with inspection dates or calibration dates can be easily accommodated and the system will not allow items that are not within date parameters be checked out.



FME Zone

With our Toolsaver® System, FME Zones can now be automated. The software will keep track of everything entering the zone, either by scanning a tagged item, taking a picture of an item or typing in a description of an item. When items are removed, they are marked as being so in the database. Reports or zone status can be brought up any time on the local screen to see what is still inside the zone and what has been removed. The FME Coordinator or Area Manager can check the status remotely from his/her desktop to check on the zones status.





Armory

Our Weapon Tracking System automates the process of armory inventory, weapon check-in/out, test firing and maintenance history of the weapons and tracking the qualifications of the security personnel. The system allows for downloading range results directly to an RFID enabled badge worn by security personnel so that if the qualifications are not correct, that officer will not be allowed to check out any weapons needing a particular qualification. Any weapons that are out of date for maintenance or test firing will not be allowed to be checked out of the armory. Accounting for weapons sent out for repair or maintenance can also be tracked with our system. Inventory can be quickly and accurately reconciled by simply using a handheld wand and placing it near tagged rifles, pistols and radios.

Fire Hose & Extinguishers

Use our system to automate the monthly process of fire extinguisher inspection. Employing a handheld devices enable inspection data to be stored at the extinguisher site as well as being downloaded to a central database for recordkeeping. Eliminate handwritten logs and be sure that each location has been inspected. Fire hose inspection can easily be a part of this application or its own stand alone application.



Valve Maintenance

Tags attached to the valves in service can be updated with the maintenance history of each valve and can also be stored in a central database. Using a hand held device, a tag can be read at the valve site to determine any service needs based on time and date. Any work done can be noted right there and later downloaded to the central database.



Portal Monitors

The addition of an exit gate arrays at specific exits of the site will help prevent high dollar value tools from leaving the site without authorization. Tools such as grinders and rechargeable drills can be tagged and to prevent them from leaving the facility. Tool shrinkage+ will be minimized and companies will achieve a real ROI based on minimizing tool losses.

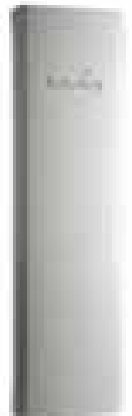

Chemistry

Our system can utilize RFID enabled labels that can be attached directly to chemical containers for chemical locker inventory. A quick scan of the locker, using a handheld scanner, before leaving the RCA means the next person going in will know what they need to bring with them without having to enter and exit the RCA multiple times. Even combustible liquids can be safely tracked and monitored.



IT Storage and Tracking

Our IT Asset Control and Tracking RFID System was designed based on a strict criteria, performing at NRC standards to track and minimize the chances of a cyber security attack or virus infestation.

- 1) Automatically track asset use and log times, incorporating Work Order information.
- 2) The system prompts the user to perform a Virus scan on an asset both before use and during return of an asset to inventory.
- 3) If the asset does not pass the virus scans, the system will instruct the user not to use the asset and to contact the appropriate IT personnel and wait for them with further instructions.
- 4) Keep inventory of 10 or more different IT storage areas. Each area has its own unique inventory of assets as they are assigned to a particular storage area.
- 5) If an asset is returned to the incorrect storage area, the system directs the user to the proper storage area for that particular asset.
- 6) Generates sortable and customizable reports as needed for administration, recordkeeping and inspections.
- 7) Perform without the need for on-site management. User performs all functions with no need for an attendant.
- 8) IT Managers have the ability to check-in on any or all IT inventory locations from their desktop PC's.



M&TE Storage

M&TE tools and equipment can be tagged and tracked just like the tools in the Tool Crib. Inspection dates and/or calibration dates can be set so that when an item is out of range of either date, the system will alert the attendant. The system will not allow the use of outdated equipment until maintenance/inspection/calibration has been performed and the corresponding date has been changed in the system.



FME Zone Hardware

Northern Apex RG Radiant Wand

When connected to the data reader, can be used to read tagged items in hard to reach locations. This custom 900 MHz wand was designed by Northern Apex to give you the best possible results.



Impinj Speedway Revolution

A 900 MHz reader that offers autopilot senses - that automatically configures and adapts to new and changing environments. It is available in both 2 and 4 port versions with EPC global UHF Class 1 Gen 2 / ISO 18000-6C interface protocol.



FME Zone Hardware Connections

Laptop
or
PC
↓
to
LAN



RFID Reader



Antenna

Tablet

A Windows-Based Tablet



Motorola MC 3090

The MC 3090 is a handheld computer used for the commercial space. It is compact and rugged, with a color touch screen. It has Wi-Fi 802.11a/b/g wireless connectivity and an omni-directional MAX RFID Antenna.



Motorola MC 9090

The MC9090 is a rugged, handheld computer that can be used in remote industrial and commercial areas. It is a multi-modal single device supports 1D, 1D ER (extended range, US only) and 2D bar code scanning, RFID (EPC Gen 2) and imaging.



Data Storage

We recommend that the RFID Database be hosted on a LAN or use our Cloud-Based Data Storage.

EZ-Wipes	102
Microfiber	102
Nuclear Grade Wiping Cloth	103
HERMITEX® Nuclear Grade Wipers	103
The Multiple Applications Wipers	103
Low TiO2 Wiper	103
F-AlphaWipe®	104
Laundry Cart	104
Tinted Tacky Mats	104



Wiping Cloths, Towels, Rags and Nuclear Grade Wipers

Choose between: 100% Cotton or Premium Microfiber Tether-Ready, pre-packaged or bulk rags by the pound.

EZ-Wipes

- The cleaning industry's best selling towel
- 15in. x 25in.
- 100% absorbent cotton
- Perfectly laundered and lint free
- Custom printed for a nominal charge
- Colors: Orange (-OR), Yellow (-YW), Green (-GN), White (-W), Red (-R), and Blue (-B)



Part No.	Description	Qty
F-EZ-WIPE-NT	EZ-Wipe without tether provision	25 Pack
F-EZ-WIPE	EZ-Wipe with tether provision (buttonhole)	25 Pack
F-EZ-WIPE-FLT	Floating EZ-Wipe with tether provision	25 Pack
F-EZ-WIPE-LAN	EZ-Wipe with Lanyard	25 Pack
F-EZ-WIPE-LANFLT	Floating EZ-Wipe with Floating Lanyard.	25 Pack

Microfiber



	Part No.	Description	Qty
A	F-ALPHA-M16X27	16in x 16in Terry Cloth 70% Polyester, 30% polyamide Medium weight microfiber Colors: Blue, Green, Yellow, Orange or Pink	50 Pack
B	F-ALPHA-M16X27	16in x 27in new style plush Heavy Weight Colors: Blue ,Green ,Red	50 Pack
C	F-ALPHA-M16X16SB-BL	16in x 16in Soft suede microfiber Colors: Blue Feels and works like a real chamois Medium Weight	50 Pack
	F-ALPHA-M12X12SR	12in x 12in smaller ribbed microfiber towels Used for scrubbing Blue or Green	50 Pack
D	F-ALPHA-M16-27W	16in x 27in waffle weave microfiber towel Colors: Blue, Red, Green	50 Pack
	F-ALPHA-M16-16W	16in x 16in waffle weave microfiber towel Colors: Blue, Green, Red	50 Pack

Nuclear Grade Wiping Cloth

- 18in. x 18in.
- 100% natural cotton balbriggan knit
- Preferred wiping cloth for general wiping & stainless steel cleaning
- Meets specification A-A-2522 for wiping rags
- Certificate of analysis available upon request



Part No.	Description	Qty
F-203N-25	Nuclear Grade Wiping Cloth	25lb boxes
F-203N-50	Nuclear Grade Wiping Cloth	50lb boxes

HERMITEX® Nuclear Grade Wipers

- Manufactured from 100% purified cotton fibers
- Bright white, high quality, low-lint, and non-abrasive
- Textured weave provides more surface area for trapping contaminants
- Absorbs more than 400 times its dry weight in liquids
- Sold by the case only

Part No.	Description	Qty
CH-300-CONT	Continuous Roll	12 rolls/case
CH-300-CUT	Pieces/Roll - 100	12 rolls/case
CH-300-FP	Pieces/Roll - Folded 10ft x 16ft	1,000 pcs/case



The Multiple Applications Wipers

- No-run interlock double-knit fabric
- Made from 100% continuous-filament polyester
- Contains four fully-sealed borders to prevent the release of fibers and particles
- Withstands rigorous use on rough surface
- Great for contamination control

Part No.	Size	Qty
F-Alpha 10	9in x 9in (23cm x 23cm)	1,000 wipers/case
F-ALPHA 12	12in x 12in (20cm x 30cm)	1,000 wipers/case



Low TiO2 Wiper

- No-run interlock, double-knit from 100% continuous-filament LT polyester
- Includes a No Titanium Dioxide (TiO₂) feature
- Manufactured with state-of-the-art sealed border technology
- Excellent balance of wiping efficiency, abrasion resistance, and absorbency

Part No.	Size	Qty
F-Alpha 10 LT	9in x 9in (23cm x 23cm)	1,500 wipers/case



F-AlphaWipe®

- Highly adsorbent polyester wiper
- 100% continuous-filament polyester in a double-knit, no-run interlock pattern
- Cleanroom laundered and packaged
- Includes a laundered cut edge
- Ideal for general cleaning and spill control

Part No.	Description	Qty
F-AlphaWipe®	Size: 24in x 44in (61cm x 112cm)	225 wipers total/case

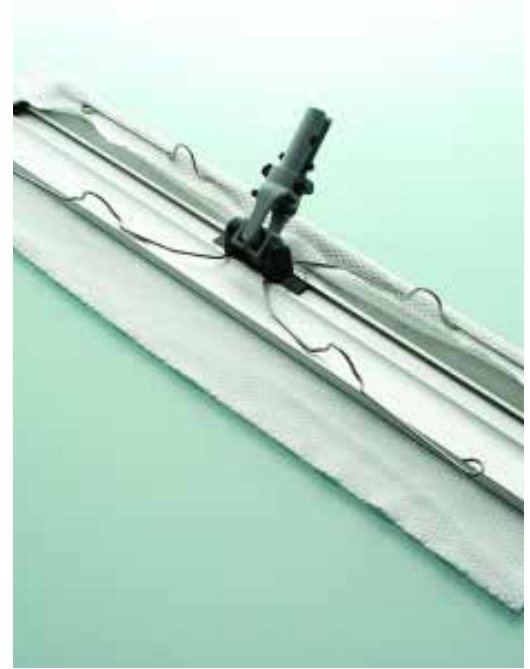

Laundry Cart

- Made for soiled covers
- Removable and super-strong
- Lightweight 1 in. vinyl liner
- Collapsible steel tubular powder coated frame with standard 3 in. polyolefin casters
- Customizable liner to meet your specific needs
- Cart can also be attached to cabinets
- 26in. x 21in. x 36in.
- Colors: Orange (-OR), Red (-R), Pink (-PK)
Other colors available upon request

Part No.	DESCRIPTION
FME-LNDRY-CART	Laundry Cart
FME-LNDRY-CRTLNR	FME Cart Liner



Tinted Tacky Mats

- Mats grab contaminants with no adhesive transfer
- Partners well with our Adhesive Floor Tape
- Used to establish an unbeatable FME Buffer Zone

Part No.	Description	Qty.
F-AB91846-30BL	Tacky Mat, 18in x 46in, 30 layers, Blue	8/cs
F-AB924X36-30BL	24in x 36in, 30 layers, Blue	8/cs



TINTED PLASTICS

Tinted Stretch and Shrink Wrap	106
Color Tinted Stretch Wrap	106
Color Tinted Easy Wrap	106
Shrink Wrap	106
Heavy Duty Handwrapper	107
VCI Anti-Rust Poly Sheeting	107
Tinted Document Covers	107
Document Pouches	108
Tinted PVC Tubing	108
Tinted Sleeving/ Lay Flat Tubing	108



Tinted Stretch and Shrink Wrap Color Tinted Stretch Wrap

- Ideal for color coding warehouse inventory and shipments
- Extra-quiet, puncture-resistant 80 or 120 gauge cast film
- Colors: Red (-R), Blue (-B), Green (-GN), Orange (-OR), Black (-BK)



Part No.	Description	Gauge	Weight/Case	Rolls/Case
FME-TSW1000	18in x 1000ft Color Tinted Stretch Wrap	120	39lb	4 Rolls
FME-TSW1500	18in x 1500ft Color Tinted Stretch Wrap	80	39lb	4 Rolls

Color Tinted Easy Wrap

- Color-tinted cast stretch wrap
- Lightweight and portable, recommended for regular loads
- Industrial Cast- quiet and clear
- Colors: Red (-R), Blue (-B), Green (-GN), Orange (-OR), Black (-BK)



Part No.	Description	Gauge	Weight/Case	Rolls/Case
FME-ESYWR	20in x 1000ft Color Tinted Easy Wrap	80	31lb	4 Rolls

Shrink Wrap

- Attaches to any structure
- Premium polyethylene film heavy-duty seamless material
- Flame retardant, U.V. treated, and waterproof
- Simply apply heat gun forcing the film to mold to any shape for a skin-tight enclosure
- Also available in 10mil & 12mil
- Colors: White



Part No.	Description	Per Pallet
FME-WSW9-20X100	9 mil. Shrink Wrap 20in x 100in	20

Heavy Duty Handwrapper

- A control knob adjusts to size of roll
- Does not slip or lose tension
- Broad zinc base does not tip over
- Holds rolls up to 20 inches



Part No.	Description	Shipping Weight
FME-HAND-1	Holds rolls up to 18in	5lb
FME-HAND-2	Holds 18in and 20in rolls	5lb

VCI Anti-Rust Poly Sheeting

- Create custom packaging for engine parts, bearings, and other metal components
- Heavy-duty poly resists tearing
- Heat sealable, odorless, non-toxic, and recyclable
- Provides corrosion protection: 6 months-outdoors, 12 months-indoors



Part No.	Description	Weight per Roll
FME-PSW-VCI36	36in X 500in Anti Rust Poly Sheeting	26lb
FME-PSW-VCI48	48in x 500in Anti Rust Poly Sheeting	35lb

Tinted Document Covers and Binders

- Holds paperwork for FME tasks
- Tinted for easy visibility
- Colors: Orange (-OR), Red (-R), Pink (-PK) & Green (-GN)



Part No.	Description	Qty.
FME-DOCCVR	Document Cover (Orange or Red)	25
FME-DOC-BNDR	Document Binder in FME Colors	5

Document Pouches

- FME Secure Document Pouch, Heavy Duty Velcro closure and strap.
- Constructed of Fire-retardant material certified to NFPA 701 Large Scale which helps meet NFPA 805 requirements.
- Available Colors: Orange (-OR) or Pink (-PK)

Part No.	Size
FME-DOCPCH	11in x 13in
FME-DOCPCH-MINI	8in x 10in



Tinted PVC Tubing

- Perfect for diagnostic testing applications less than 10 PPM Chlorides
 - Roll length: 50 feet, Shore 65 A.
 - Colors: Orange (-OR)
- *Other colors available upon request*

Part No.	Description	Qty.
F-TU1114	1in ID, 1-1/4 in OD	1
F-TU1814	1/8in ID, 1/4 in OD	1
F-TU316516	3/16in ID, 5/16in OD	1
F-TU1438	1/4in ID, 3/8in OD	1
F-TU3812	3/8in ID, 1/2 in OD	1
F-TU1234	1/2in ID, 3/4in OD	1
F-TU581316	5/8in ID, 13/16in OD	1
F-TU341	3/4in ID, 1in OD	1
F-TU114112	1-1/4in ID, 1-1/2in OD	2
F-TU112134	1-1/2in ID, 1-3/4inOD	1



Tinted Sleeving/ Lay Flat Tubing

- Protects cables and hoses from contamination
 - Colors: Orange (-OR)
- *Other colors available upon request*

Part No.	Description	Qty.
F-LFT24	2in 4mil. 500in Tinted Sleeving	1 Roll
F-LFT44	4in 4mil. 500in Tinted Sleeving	1 Roll
F-LFT64	6in 4mil. 500in Tinted Sleeving	1 Roll
F-LFT84	8in 4mil. 500in Tinted Sleeving	1 Roll
F-LFT104	10in 4mil. 500in Tinted Sleeving	1 Roll



Welding Fabrics	110
FME Brushes	110
Bristle Disc	111



Welding Fabrics

For High Temperature Fabrics see page 53

Welding Screens



Insulated Welding Pads



Welding Blankets and Curtains



Cover Guard® Diamond Plate Floor Cover



FME Brushes

Hurricane Brushes
FME compliant wire free brushes



	Part No.	Description	Qty.
A	FL-B90003	Hurricane SYN Welders Brush	12 PCS
B	FL-B90002	Hurricane Brush, Scratch SYN	12 PCS.
C	FL-B90001	Hurricane Brush, Scratch SYN, tooth brush style	12 PCS.

Bristle Disc

- Great for deburring, finishing, polishing, and cleaning surfaces
- Delivers a high-quality finish
- Maintains a safe operating environment



Part No.	size	grade	color	trim (T=Tapered)	Max. RPM	Discs/Box
F-M3186986	1in	50	Green	5/8in	30,000	20
F-M3187068	1in	80	Yellow	5/8in	30,000	20
F-M3187105	1in	120	White	5/8in	30,000	20
F-M3187303	2in	50	Green	5/8in T	25,000	10
F-M3187327	2in	80	Yellow	5/8in T	25,000	10
F-M3187334	2in	120	White	5/8in T	25,000	10
F-M3187341	3in	50	Green	5/8in T	15,000	10
F-M3187365	3in	80	Yellow	5/8in T	15,000	10
F-M3187372	3in	120	White	5/8in T	15,000	10
F-M3330549	4.5in	36	Brown	5/8in-11	12,000	10
F-M3242415	4.5in	50	Green	5/8in-11	12,000	10
F-M3242422	4.5in	80	Yellow	5/8in-11	12,000	
F-M3242439	4.5in	120	White	5/8in-11	12,000	10
F-M3824537	4.5in	50	Green	m14-2	12,000	10
F-M38276854	7in	50	Green	7/8	6,000	5

Bristle Disc Accessories



Part No.	Description	Size	Qty/Box
F-M38451012	Disc Pad Holder 1in Hardness-med	1/4-20 Int	5
F-M38450944	Disc Pad Holder 2in Hardness-med	1/4-20 Int	5
F-M38450961	Disc Pad Holder 2in Hardness-hard	1/4-20 Int	5
F-M38450923	Disc Pad Holder 3in Hardness-med	1/4-20 Int	5
F-M38450916	Disc Pad Holder 3in Hardness-hard	1/4-20 Int	5/8in T
F-M38451029	Shank 1/4 in-20 Ext	1/4/1/4-20 Ext	5/8in T



**Your First Source for:
FME, RFID, Drop Prevention
&
Innovative Safety Supplies**

800.589.7369

www.Alphasourceintl.com

Alphasource® Inc.

P.O. Box 12250

4837-49 N. Stenton Ave.

Philadelphia, PA 19144

Telephone:(215) 844-6470

Toll Free:(800) 589-7369

FAX:(215) 844-6252

FME@alphasourceintl.com

REV072016