



**MARSHALL  
GRUBER  
COMPANY**

# *Product Catalog*

Supplies for cast polymer & composites manufacturing & fabrication,  
including cultured marble, solid surface and engineered stone.

*Call toll-free at (866) 260-6457*



**MARSHALL  
GRUBER  
COMPANY**

*New floating bowl molds  
from Gruber Systems  
for 2016!*

Freshen up your 2016 product offerings with these two new floating bowl mold designs from Gruber Systems. These two new designs are sure to be popular with your customers. Both should be cast with no overflow. For more information, contact Marshall Gruber at 866-260-6457, or email [info@marshall-gruber.com](mailto:info@marshall-gruber.com)

**NEW!**  
*Ramp Bowl 14" x 20"*

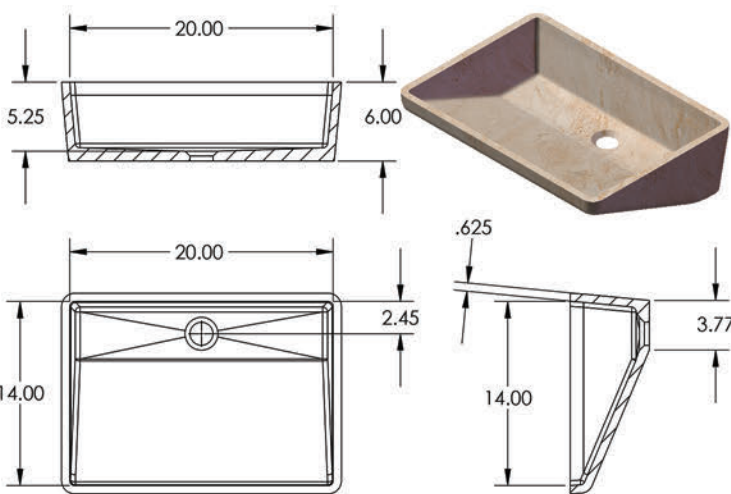

MOLD PART	CATALOG No.	DESCRIPTION
MALE	20143	108 - 14 x 20 Ramp Bowl
FEMALE	401437	Fem - 14 x 20 Ramp Bowl
PERMANENT HAT		
REUSEABLE HAT		
NAME	14 x 20 Ramp Bowl	
CAST WEIGHT	Approx. 28 Lbs	SCALE None   DATE 12.15.15   PAGE No.

**NEW!**  
*Drop Wave 12" x 18"*

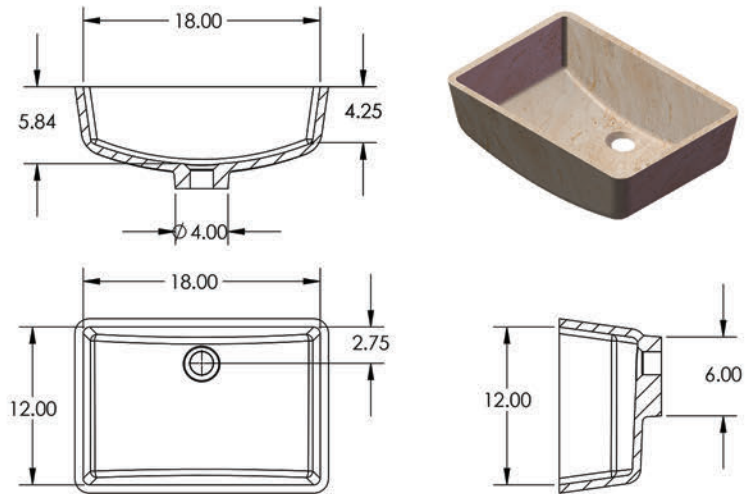

MOLD PART	CATALOG No.	DESCRIPTION
MALE	20142	108 - 12 x 18 Drop Wave
FEMALE	401427	Fem - 12 x 18 Drop Wave
PERMANENT HAT		
REUSEABLE HAT		
NAME	12 x 18 Drop Wave	
CAST WEIGHT	Approx. 25 Lbs	SCALE None   DATE 12.15.15   PAGE No.

# Table of Contents

(866) 260-6457  
www.Rjmarshall.com



Marshall Gruber offers an extensive range of the highest quality parts and products for the manufacture of cultured marble, solid surface, engineered stone and other cast polymer products. Marshall Gruber also offers tools, supplies and accessories for fabricators and other installers of kitchen and bath products.

## ***Pigments***

Color Pigments .....	1
----------------------	---

## ***Mold Setup Accessories***

Hats	
Permanent Hats .....	2
Permanent Hats for Bath Accessories .....	4
Reusable Polyethylene Hats .....	5
Reusable Polyethylene Funnels .....	6
Divider Bars	
Aluminum .....	7
Polyethylene (Rigid Plastic) Divider Bars .....	8
Polyurethane (Flexible Plastic) Divider Bars .....	8
End Stop Divider Bars .....	9
Lavatory Bowl Setup Components (Faucet Hole Rings, Bowl Clips, FUA's, etc) .....	12
Overflow System Components (Polycollars) .....	12
Polydomes & Assembly Components (Polydomes, Tubing, Drain Boss, Captive Nut, Reusable Stem, etc) ...	13

## ***Mold Care Products***

Mold Strippers & Cleaners .....	14
Mold Sealers .....	14
Mold Release .....	15
Mold/Gelcoat Repair .....	15

## ***Tooling Waxes & Clays***

Tooling Wax & Clay .....	16
Applicators & Accessories .....	16

## ***Tapes, Films, Adhesives & Sealants***

Tapes .....	17
Silicone/Sealant/Caulking .....	17
Clear Protective Film .....	18

## ***Abrasives***

Sanding, Grinding & Buffing Media .....	18
---	----

## ***Tools & Supplies***

Hole Saws & Drill Bits .....	19
Hand Tools & Accessories (Clamps, Scrapers, Wedges) ..	19
Spray Equipment .....	20

## ***Bathroom Accessories***

Beauty Rings, Towel Bars & Rings, Etc .....	21
---	----

## ***Personal Protective Equipment***

Gloves, Aprons, Respirators & Masks .....	21
Cotton Wipes .....	21

## ***Spare/Replacement Parts***

Filters, Wheels & Casters, and Table Vibrators .....	22
--	----

### ***Unit of Measure Definitions***

Throughout this catalog, units of measure are abbreviated. This chart defines those abbreviations:

<b>Abbreviation</b>	<b>Unit of Measure (UOM)</b>
Ea .....	Each
Bx .....	Box
Cs .....	Case
Dr .....	Drum (per)
Ft .....	Foot (per)
Gal .....	Gallon (per)
Kt .....	Kit
L .....	Liter (per)
Lb .....	Pound (per)
RI .....	Roll
Pal .....	Pallet (per)
Pk .....	Pack
Pr .....	Pair
St .....	Set

## Color Pigments

### Brocom Standard Pigments

Marshall Gruber offers high quality Brocom Designer Marble color pigments, specifically designed for use with cultured marble and solid surface applications.

- Engineered specifically for cultured marble and solid surface
- Formulated so they can be stored almost indefinitely
- Custom color matching is available at no charge.
- Ready to use - no formulating or adjusting
- Produced without toxic pigments such as lead and cadmium
- Packaged in standard 5 lb sizes. Call for other sizes or colors.

**Note:** Part numbers will start with one of the two following values. Note the application of each is different, so determine your application and order the appropriate formulation.

**ATH = Aluminum Tri-Hydrate (for Solid Surface)**

**A = Calcium Carbonate based (for Cultured Marble)**

Series/Color	ATH (5 Lb)	A (5 Lb)
<b>Kohler</b>		
Kohler Almond	ATH1424-5	A408-5
Kohler Almond Beige	ATH3167-5	A1138-5
Kohler Antique Red	CALL!	A514-5
Kohler Aspen Green	ATH2662-5	A609-5
Kohler Biscuit	ATH2038-5	A2006-5
Kohler Black	CALL!	A306-5
Kohler Cerulean Blue	CALL!	A217-5
Kohler Chamois	ATH1436-5	CALL!
Kohler Cobalt Blue	ATH2242-5	A1251-5
Kohler Country Gray	CALL!	A311-5
Kohler Designer Black	ATH1358-5	CALL!
Kohler Dresden Blue	ATH2219-5	CALL!
Kohler Espresso	ATH3162-5	A119-5
Kohler Harvest Gold	ATH1445-5	A418-5
Kohler Heron Blue	CALL!	A220-5
Kohler Ice Gray	CALL!	A1314-5
Kohler Innocent Blush	ATH3531-5	A517-5
Kohler Jersey Cream	CALL!	A426-5
Kohler Mexican Sand	CALL!	A112-5
Kohler Navy	CALL!	A218-5
Kohler Navy '90	CALL!	A1234-5
Kohler Parchment	ATH3151-5	A107-5
Kohler Raspberry Puree	CALL!	A511-5
Kohler Sandbar	ATH5181-5	CALL!
Kohler Sea Foam Green	CALL!	A638-5
Kohler Sequoia	ATH3154-5	CALL!
Kohler Swiss Chocolate	ATH3156-5	A118-5

Series/Color	ATH (5 Lb)	A (5 Lb)
Kohler Taupe	ATH3149-5	A101-5
Kohler Teal	CALL!	A645-5
Kohler Terra Nueva	ATH3116-5	CALL!
Kohler Thunder Gray	ATH1373-5	CALL!
Kohler Vermont Blue	CALL!	A1210-5
Kohler Wild Rose	ATH3563-5	A500-5
<b>Eljer</b>		
Eljer Almond	CALL!	A121-5
Eljer Dusty Rose	CALL!	A519-5
Eljer Golden Wheat	ATH1443-5	CALL!
Eljer Island Sea	ATH2243-5	CALL!
Eljer Natural	ATH2191-5	CALL!
Eljer Peach Bisque	CALL!	A518-5
Eljer Ruby '99	ATH6509-5	CALL!
Eljer Sage	ATH2658-5	CALL!
Eljer Sandlewood	ATH2179-5	A125-5
Eljer Silk	ATH3030-5	CALL!
<b>American Standard</b>		
Am Std Euro White	ATH2072-5	CALL!
Am Std Fawn Beige	ATH3173-5	CALL!
Am Std Light Mink	ATH2184-5	A1166-5
Am Std Linen	ATH4144-5	CALL!
Am Std Loganberry	ATH4530-5	CALL!
Am Std Persian Brown	ATH3160-5	CALL!
Am Std Rain Forest	ATH2660-5	CALL!
Am Std Regency Blue	ATH2206-5	CALL!
Am Std Rhapsody Blue	ATH2245-5	CALL!
Am Std Shell Whisper	ATH3579-5	A528-5

Series/Color	ATH (5 Lb)	A (5 Lb)
Am Std Sterling Silver	ATH1361-5	A309-5
Am Std Warm White	ATH2068-5	CALL!
<b>U-R</b>		
U-R Crème	CALL!	A410-5
U-R Mushroom	CALL!	A1014-5
U-R Rose Dawn	CALL!	A501-5
U-R Silver Gray	ATH1350-5	CALL!
<b>Formica</b>		
Custom Agean Mist	CALL!	A1666-5
Custom Almond	CALL!	A1157-5
Custom Beige	ATH3480-5	CALL!
Custom Country Gray	CALL!	A1323-5
Custom Dark Bone	ATH5186-5	CALL!
Custom Dark Evergreen	CALL!	A1687-5
Custom Deep Green	CALL!	A1689-5
Custom Gold	ATH1472-5	CALL!
Custom Seagreen	ATH3650-5	CALL!
Custom Sterling Silver	CALL!	A1322-5
Custom Violet	ATH7586-5	CALL!
Formica Antique White	CALL!	A1059-5
<b>Wilsonart</b>		
Wilsonart Antique White	CALL!	A2040-5
Wilsonart Beige (1530-6)	CALL!	A1155-5
Wilsonart Bermuda	ATH3226-5	CALL!
Wilsonart Peach	CALL!	A1532-5
<b>Welbourne</b>		
Welbourne Champagne	CALL!	A1403-5

**Call for volume discounts, samples, sizes and other Brocom colors!**



*Permanent Hats*

These hats become a permanent part of the marble product, providing a finished underside which requires little or no additional finishing. To select the proper permanent hat, find your bowl in the first column, then select the appropriate permanent hat. Hats are grouped by white or clear plastic, then by “With Overflow”, or with “No Overflow”.

**Note:** Hats in the following Permanent Hat Chart that are bolded and asterisked are the **IL** order numbers. These hats are superior compared to the older original hats, and are less expensive. We recommend you order the IL hats. If you prefer to order the original hats (at a higher price), use the number shown, but remove the IL designation from the number.



Permanent Hat Chart			White Hats		Clear Hats	
			With Overflow	No Overflow	With Overflow	No Overflow
Bowl Name	Description	Qty/Case	Order No.	Order No.	Order No.	Order No.
Bar Sink	PH-Bar (Fits 20051/20052)	25	CALL	00239	CALL	CALL
Cambria D	PH-Cambria D	50	00209	CALL	00209C	CALL
Canadian Oval (Large)	PH-Canadian Oval/Shell 20”	50	002237	0022371	002237C	0022371C
Canadian Oval (Small)	PH-Canadian Oval 19”	50	CALL	CALL	0022372C	CALL
Carmel	PH-G/GS - 5/8”	50	00206	CALL	00206C	CALL
	PH-G/GS	50	00207	002061	00207C	002061C
Catalina	PH-SL	50	00226	002262	00226C	002262C
Coronado Oval	PH-Coronado	25	00261	00260	00261C	00260C
Deep Malibu w/ OG Rim	PFH-DCL/FL	50	00343	003431	00343C	003431C
Delaware	PH-DESD/DE	50	002035	002036	002035C	002036C
Delaware w/ Soap Dish	PH-DESD/DE	50	002035	002036	002035C	002036C
Diamond	PH-DD	25	002233	002234	002233C	002234C
	PH-DD 3/5”	25	002233-1	002234-1	002233-1C	002234-1C
Diamond (Little)	PH-LDD	50	002235	002236	002235C	002236C
Diplomat (Fab US) 17”	PH Fab UO/US	50	00240	CALL	00240C	CALL
Dixie (Small)	PH-LN/LNS	25	00233	00234	00233C	00234C
Dixie	PH-N Texas	50	<b>002560IL*</b>	CALL	<b>002560ILC*</b>	CALL
	PH-N/NS	50	<b>00284IL*</b>	<b>002842IL*</b>	<b>00284ILC*</b>	<b>002842ILC*</b>
	PH-N/X Square No Faucet Landing	50	<b>00281IL*</b>	CALL	<b>00281ILC*</b>	CALL
	PH-N/NS Square Hole	50	<b>00283IL*</b>	CALL	<b>00283ILC*</b>	CALL
	PH-N Square Oversized	50	002831	CALL	002831C	CALL
	PFH-Comp-N	50	00341	00344	00341C	00344C
Hexagon	PH-Hex	50	00329	00331	00329C	00331C
Hilo	PH-W	50	00220	002202	00220C	002202C
	PH-W-SM Square	50	002201	CALL	002201C	CALL
Hilo w Soap Dish	PH-WSD	50	00231	002315	00231C	002315C
	PH-WSD 3/4” Wall Thickness	50	002312	CALL	CALL	CALL
Kona	PH-G/GS	50	00206	CALL	00206C	CALL
	PH-G/GS 5/8”	50	00207	002061	00207C	002061C
La Paz	PH-LZ	50	002112	002113	002112C	002113C

# Mold Accessories

(866) 260-6457  
www.Rjmarshall.com



## Permanent Hats (continued)

Bowl Name	Description	Qty/Case	White Hats		Clear Hats	
			With Overflow	No Overflow	With Overflow	No Overflow
			Order No.	Order No.	Order No.	Order No.
Laguna	PH-N/NS	50	<b>002841L*</b>	<b>002842IL*</b>	<b>002841LC*</b>	<b>002842ILC*</b>
	PH-N/NS Square Hole	50	<b>002831L*</b>	CALL	<b>002831LC*</b>	CALL
	PH-N Texas	50	<b>0025601L*</b>	CALL	<b>0025601LC*</b>	CALL
	PH-N Texas No Faucet Landing	50	002512	CALL	002512C	CALL
	PH-N/X Square No Faucet Landing	50	<b>002811L*</b>	CALL	<b>002811LC*</b>	CALL
	PH-Comp-N	50	00341	00344	00341C	00344C
	PH-N Square Oversized	50	002831	CALL	002831C	CALL
Laguna (Deep)	PH-Deep N	50	00286	CALL	00286C	CALL
Lanai	Fab Shell	50	00240	CALL	00240C	CALL
Lanakai	PH-Y/YS (*Side Overflow)	50	00222*	002221	00222C	002221C
	PH-Y Center Overflow	50	002226	CALL	002226C	CALL
Mai Tai	PH-I Oval Pour	50	002081	002085	002081C	002085C
	PH-I (Thin) Oval Pour	50	002081	CALL	002081C	CALL
	PH-I (Square Pour)	50	00208	00357	00208C	00357C
Makaha	PH-LN/LNS	25	00233	00234	00233C	00234C
Malibu	PH-CC	50	<b>002231L*</b>	<b>002232IL*</b>	<b>002231LC*</b>	<b>002232ILC*</b>
Malibu Flair	PFH-DCL/FL	50	00343	003431	00343C	003431C
Malibu w Soap Dish	PH-CCSD	50	00230	002305	00230C	002305C
Maui	PH-WX 109	50	00228	002285	00228C	002285C
Moana	PH-P	50	00217	00229	00217C	00229C
Molokai	PH-S	50	00218	002185	00218C	002185C
Molokai (Deep)	PH-SS	50	00227	CALL	00227C	CALL
Monterey	PH-LN/LNS	25	00233	00234	00233C	00234C
Newport	PH-L	50	<b>002101L*</b>	002532	<b>002101LC*</b>	002532C
Newport (Deep)	PH-LL	50	00224	00365	00224C	00365C
	PH-LL (Short)	50	002241	CALL	002241C	CALL
Olympic Oval Large	PH-LG Olympic	25	CALL	00237	CALL	00237C
	PH-VSS-108	50	00205	CALL	00205C	CALL
	PH-VSS-108 1-1/8" Deck	50	002051	CALL	CALL	CALL
Olympic Oval Small	PH-SM Olympic	25	CALL	00353	003531C	00353C
Pearl (Mini)	PH-Mini Pearl	50	00339	00229	00339C	00229C
	PH-Mini Pearl	50	CALL	00340	CALL	CALL
Redondo	PH-Y/YS Side Overflow	50	00222	002221	00222C	002221C
	PH-Y/YS Center Overflow	50	002226	CALL	002226C	CALL
Royale (Large)	PH-RL	50	002252	002254	002252C	002254C
	PH-RL - 3/4" thick	50	002252-01	002254-01	002252C-01	002254C-01
	PH-RL - 7/8" thick	50	002252-02	002254-02	002252C-02	002254C-02
Royale (Small)	PH-LRL	50	002104	002105	002104C	002105C
Savannah	PH-SH	50	002258	002259	002258C	002259C
Sun Fluted (Large)	PH-108 Sun Fluted Large	50	00338	CALL	00338C	CALL

# Mold Accessories

(866) 260-6457  
www.Rjmarshall.com



Permanent Hats (continued)			White Hats		Clear Hats	
			With Overflow	No Overflow	With Overflow	No Overflow
Bowl Name	Description	Qty/Case	Order No.	Order No.	Order No.	Order No.
Sun Fluted (Small)	PH-108 Sun Fluted Small	50	003381	CALL	003381C	CALL
Sun Oval (Large)	PH-108 Sun Oval Large	25	00352	CALL	00352C	CALL
Sun Oval (Small)	PH-108 Sun Oval Small	50	003381	CALL	003381C	CALL
Super Bowl I	PH-RR	50	00225	002250	00225C	002250C
Super Bowl I with Soap Dish	PH-RRSD	50	002251	002253	002251C	002253C
Super Bowl II	PH-MR	50	00214	002140	00214C	002140C
Super Bowl III	PH-MMR	50	00215	00215N	00215C	CALL
Topaz	PH-108 AA	25	00200	CALL	00200C	CALL
Ventura	PH-V	50	002190	002191	002190C	002191C
Waikiki	PH-N Square Oversized	50	002831	CALL	002831C	CALL
	PH-N/NS	50	<b>002841L*</b>	<b>0028421L*</b>	<b>002841LC*</b>	<b>0028421LC*</b>
	PH-N/X Square No Faucet Landing	50	<b>002811L*</b>	CALL	<b>002811LC*</b>	CALL
	PH-N/NS Square Hole	50	<b>002831L*</b>	CALL	<b>002831LC*</b>	CALL
	PH-N/NS Square Oversized	50	002831	CALL	002831C	CALL
	PH-N Texas	50	<b>0025601L*</b>	CALL	<b>0025601LC*</b>	CALL
Wave 22" w/Chamfer	PH-108-Wave 22" Bowl w/ Chamfer	50	002260	CALL	002260C	CALL
Wave (Small)	PH Small Wave Round Pour Hole	50	02556*	CALL	02556C*	CALL
	PH Small Wave Square Pour Hole	50	02557*	CALL	02557C*	CALL

Note: Sold per case. Refer to "Qty/Case" columns for units packaged per case. Permanent hats can be ordered in smaller quantities for an additional packaging fee.

## Permanent Hats for Bathroom Accessories

These hats are for bathroom accessories including soap and shampoo dishes and holders, and toilet paper roll holders. These hats become a permanent part of the marble product, providing a finished underside which requires little or no additional finishing. To select the proper permanent hat, find the desired item in the first column, then select the appropriate permanent hat - either white or clear.

Soap/Shampoo Holder Name	Description	Qty/Case	White Hats	Clear Hats
			Order No.	Order No.
Sweetheart I Soap Holder	PH-180-1 Sweetheart I Soap Dish Permanent Hat	100	00290	00290C
Sweetheart II Soap Holder	PH-180-2/3 Sweetheart II Soap Dish Permanent Hat	100	002904	002904C
Sweetheart III Soap Holder	PH-180-2/3 Sweetheart III Soap Dish Permanent Hat	100	002904	002904C
Sweetheart III Shampoo Holder	PH-180-6 Sweetheart III Shampoo Holder Permanent Hat	100	002907	002907C
Sweetheart IV Soap/Shampoo Holder	PH-180-17 Sweetheart III Soap/Shampoo Combination 100 Permanent Hat	100	002908	002908C
Toilet Paper Holder	PH-180-7 Toilet Paper Holder Permanent Hat	100	002906	002906C

## Reusable Polyethylene Hats (with overflow)

Unlike Permanent Hats, these Marshall Gruber Reusable Hats can be used repeatedly. They are manufactured of high density polyethylene. To order Untrimmed Hats, contact your Marshall Gruber sales representative.

Note: The hats pictured are Trimmed and have no overflow.

Bowl Name	Description	Order No.
Access Rectangle	RH-ADA Rectangle	01338
Cambria D	RH-Cambria D	01352
Canadian Oval (Large)	RH-Canadian Oval/Shell	01355
Canadian Oval Shell	RH-Canadian Oval/Shell	01355
Carmel	RH-G RH-G Side Overflow	01356 013562
Catalina	RH-SL	01369
Delaware	RH-DESD/DE	013540
Delaware, w/ Soap Dish	RH-DESD/DE	013540
Diamond	RH-DD	013545
Diamond (Little)	RH-LDD	013547
Dixie	RH-N/NS RH-N-N Square RH-N/NS Square Oversize	01362 013622N 013622
Hexagon	RH-Hex	01370
Hilo	RH-W	01364
Hilo, w/ Soap Dish	RH-WSD	01379
La Paz	RH-LZ	013675
Laguna	RH-N/NS RH-N/NS Square RH-N/NS Square Oversize	01362 013622N 013622
Laguna (Deep)	RH-Deep N	01395
Lanakai	RH-Y/YS	01366
Mai Tai	RH-I (Square Pour Hole)	01358
Makaha	RH-LN/LNS	013615
Malibu	RH-CC Oval	01367
Malibu Deep, w/ OG Rim	RH-DCL/FL	01442
Malibu, w/ Soap Dish	RH-CCSD	013672
Malibu Flair	RH-DCL/FL	01442
Maui	RH-WX	01372
Moana	RH-P Square Hole	013628
Molokai	RH-S	01363
Molokai (Deep)	RH-SS	01371
Monterey	RH-LN/LNS	013615
Newport	RH-L	01361
Newport (Deep)	RH-LL	01368
Olympic Oval Large (Untrimmed)	RH-LG Olympic	01452
Redondo	RH-Y/YS (Side Square)	01366
Royale (Large)	RH-RL	013693



Bowl Name	Description	Order No.
Royale (Small)	RH-LRL	013678
Savannah	RH-SH	013634
Sun Fluted (Large)	RH-Sun Fluted Large	01443
Sun Fluted (Small)	RH-Sun Fluted Small	01445
Sun Oval (Large)	RH-Sun Oval Large	01397
Super Bowl I	RH-RR Square Hole	013685
Super Bowl I, w/ Soap Dish	RH-RRSD	013684
Super Bowl II	RH-MR Square Pourhole	013623
Super Bowl III	RH-MMR	013624
Topaz	RH-AA	01350
Ventura	RH-V	013683
Waikiki	RN-N/NS RH-N Square Hole RH-N Square Hole Oversize	01362 013622N 013622



## Mold Accessories

### *Reusable Polyethylene Hats (without overflow)*

Bowl Name	Description	Order No.
Access Rectangle	RH-ADA Rectangle	013385
Bar Sink	RH-Bar (20051/20052)	01453
Carmel	RH-G	013564
Catalina	RH-SL	
Celebrity Rectangle	RH-13x17 Rectangle	010807
Delaware	RH-DESD/DE	013541
Delaware, w/ Soap Dish	RH-DESD/DE	013541
Diamond	RH-DD	013546
Diamond, Little (Little Diamond)	RH-LDD	013548
Dixie	RH-N	013680
Hilo	RH-W	013640
Hilo w Soap Dish	RH-WSD	013686
Kona	RH-G/GS	013563
La Paz	RH-LZ	013676
Laguna	RH-N	013680
Mai Tai	RH-I	013681
Makaha	RH-LN/LNS	013614
Malibu	RH-CC Oval	013723
Monterey	RH-LN/LNS	013614

Bowl Name	Description	Order No.
Newport	RH-L	013612
Olympic, Small	RH-Small Olympic	01392
Ramp Bowl, 14" x 20"	RH-Ramp	015819
Redondo	RH-Y/YS	01375
Royale (Large)	RH-RL	013694
Royale (Small)	RH-LRL	013679
Savannah	RH-SH	013635
Sun Oval (Large)	RH-Sun Oval Large	01396
Super Bowl I	RH-RR	013688
Super Bowl II	RH-MR RH-MR Square Pourhole	013687 01384
Ventura	RH-V	013689
Waikiki	RH-N	013680
Wave, 12" x 20"	RH-Wave 12x20	013636
Wave, Chamfer	RH-Wave Chamfer	013636
Wave, Deep Small w/ Oval Pour	RH-Deep Small	015094
Wave, Drop 12" x 18"	RH-Drop Wave	015818
Wave, Small	RH-Small Wave	015093

### *Reusable Polyethylene Funnels*

*Available in Round, Oval and Square funnel pour holes.*

*Fits Marshall Gruber Permanent and Reusable Hats.*

These Reusable Funnels are used in conjunction with Marshall Gruber Permanent and/or Reusable Hats to reduce spillage and wastage of cultured marble matrix during filling of the mold. Manufactured of high quality polyethylene, these hats can be used multiple times and clean up by flexing the material. Order the version with the hole opening that matches your permanent or reusable hat.

**Note:** Lead times of 1-4 weeks may apply.  
Call for more information.

**Order Information:**

Round - Ea - #02082

Oval - Ea - #02083

Square (5" x 5") - Ea - #02084

Shown is the oval funnel (#02082) mounted on a Reusable Hat (with oval opening).



*Aluminum Divider Bars* (Sold individually unless otherwise stated)

Aluminum Divider Bars	Outside Corner Divider Bars	Inside Corner Divider Bars
<p>Chamfer Divider Bar - 8' length - #AD4408 12' length - #AD4408-12</p>	<p>Chamfer Outside Corner Plastic Divider Bar - #AD4408-C</p>	<p>Chamfer Inside Corner Plastic Divider Bar - #AD4408-IC</p>
<p>Also available! Chamfer Profile Polyethylene Bar 8' length - Box/3 - #POLY4408</p>		
<p>O-Gee Aluminum Divider Bar 8' length - #AD4410</p>	<p>O-Gee Outside Corner Plastic Divider Bar - #AD4410-C</p>	<p>O-Gee Inside Corner Plastic Divider Bar - #AD4410-IC</p>
<p>Also available! O-Gee Profile Polyethylene Bar 8' length - Box/4 - #POLY4410</p>		
<p>Half Round Aluminum Bullnose Divider Bar 8' length - #AD4494, 12' length - #AD4494-12</p>	<p>Half-Round Outside Corner Bullnose Plastic Divider Bar - #AD4494-C</p>	<p>Half-Round Inside Corner Bullnose Plastic Divider Bar - #AD4494-IC</p>
<p>Also available! Half-Round Bullnose Profile Poly Bar - 8' length - Box/3 - #POLY4494</p>		
<p>Drop O-Gee Aluminum Divider Bar 8' length - #AD5266</p>	<p>O-Gee Drop Lip Outside Corner Plastic Divider Bar - #AD5266-C</p>	<p>O-Gee Drop Lip Inside Corner Plastic Divider Bar - #AD5266-IC</p>
<p>Texas (Double) O-Gee Drop Lip Aluminum Divider Bar - 8' length - #AD5265</p>	<p>Texas O-Gee Drop Lip Outside Corner Plastic Divider Bar - #AD5265-C</p>	<p>Texas O-Gee Drop Lip Inside Corner Plastic Divider Bar - #AD5265-IC</p>

**Polyethylene (Rigid Plastic) Divider Bars**

These very popular rigid, reusable divider bars are available in both low-density and high-density polyethylene are available in several different cross-section sizes. These divider bars can be cut or trimmed if needed. They are held in place with double-faced masking tape on flat decks and vanity top molds to form the straight boundaries of customized parts. Because they are fabricated out of polyethylene, they won't stick to cast polymer parts, requiring little setup time, and even work in non-gelcoated applications. We can also custom-cut any size wished for an additional charge. Sold in 8' lengths.

	Low Density	High Density
Dimensions	Order No.	Order No.
3/8" x 3/4" x 96"	PDL1002 (6/Box)	PD1002 (6/Box)
1/2" x 3/4" x 96"	PDL10015 (6/Box)	PD10015 (6/Box)
3/4" x 3/4" x 96"	PDL1001 (6/Box)	PD1001 (6/Box)
1-1/2" x 3/4" x 96"	PDL10028 (3/Box)	PD10028 (3/Box)

**Polyurethane (Flexible Plastic) Divider Bars**

Flexible custom-edge divider bar allows for a customized, decorative edge treatment for cast polymers. Flexibility allows for compound curves in unique applications, and is very popular with manufacturers. All bars are 9 feet long and sold individually unless noted otherwise. F.O.B. Dallas, TX.

<p>3/4" Round Divider Bar - 8' Length - #AD4407-F</p>	<p>Chamfer Profile Divider Bar - #AD4408-F</p>	<p>Shipped as individual rolls.</p>
<p><b>Also available!</b> 3/4" Round ALUMINUM Divider Bar 12' length - #4407-12</p>		
<p>O-Gee Profile Divider Bar - #AD4410-F</p>	<p>Bull Nose Profile Divider Bar - #AD4494-F</p>	<p>Texas O-Gee Drop Lip Double Profile Divider Bar - #AD4409-F</p>
<p>O-Gee Drop Lip Profile Divider Bar - #AD5266-F</p>	<p>Black Rope Divider (Black) 1-1/2" x 146" Length - #010715</p>	<p>Double Texas O-Gee Profile Divider Bar #AD5265-F</p>

## Urethane End-Stop Divider Bars

These reusable dividers are indispensable for custom set-ups where cove-back or integral backsplash molds are involved. Designed to fit the contours of a specific cove-back mold, End-Stop dividers are used to establish the end boundaries for custom tops and are composed of a urethane material that provides a more finished edge on the part. When ordering, indicate the specific mold series number (straight or dripless) with which the divider will be used. Two styles are available - Reinforced (Black in color) or Unreinforced (Yellow in color). For other requirements, call for assistance.



### Black (Reinforced) End-Stop Dividers

Order No.	Series	Profile	Description	UOM
010714R	139	Texas OG	Black Divider 139 Texas OG - Double Edge 22"	Ea
0107453R	625	Bullnose Right	Black Divider 625 Bullnose Right 1-3/8"	Ea
0107454R	625	Bullnose Left	Black Divider 625 Bullnose Left 1-3/8"	Ea
010671R	138	OG Right	Black Divider 138 OG Right 25"	Ea
010672R	138	OG Left	Black Divider 138 OG Left 25"	Ea
010673R	138	Double OG	Black Divider 138 Double Sided OG 25"	Ea
0106805R	524	Step Down Bullnose	Black Divider 1-1/2" Full Step Down Bullnose	Ea
0106815R	524	Step Down Right Bullnose	Black Divider 1-1/2" Full Step Down Right Bullnose	Ea
010681R	524	Step Down Right	Black Divider 1-3/8" Step Down Right	Ea
0106825R	254	Step Down Left	Black Divider 1-1/2" Full Step Down Left	Ea
010682R	524	Step Down Left	Black Divider 1-3/8" Step Down Left	Ea
01068R	524	Step Down Straight	Black Divider 1-1/2" Step Down Straight	Ea
010701R	139	Texas OG (Double Double)	Black Divider 139 - 30 Double Sided	Ea
010702R	139	Texas OG	Black Divider 139 - 30" Right	Ea
010703R	139	Texas OG	Black Divider 139 - 30" Left	Ea
010713R	139	OG Front	Black Divider 139 OG Front	Ea
010712R	138	OG Front	Black Divider 138 OG Front	Ea
01071R	138	OG Right	Black Divider 138 OG Right	Ea
010721R	138	Left/Right Single OG	Black Divider 138 Double Sided (Left/Right) OG	Ea
010722BR	139	Double Texas OG	Black Divider 139 Double OG 22"	Ea
01072R	138	OG Left	Black Divider 138 OG Left Hand	Ea
010725R	139	Texas OG	Black Divider 139 - 1" x 144"	Ea
010732R	523	Bullnose Right	Black Divider 523 Bullnose - Closed End Right	Ea
010733R	523	Bullnose Left	Black Divider 523 Bullnose End - Closed End Left	Ea
010740R	625	Bullnose Right	Black Divider 625 - 2" Bullnose	Ea
0107450R	625	Bullnose	Black Divider 625 1-1/2" Bullnose	Ea
010751R	110	Straight	Black Divider 110 x 1/2"	Ea
010752R	110	Straight	Black Divider 110 x 1-1/4"	Ea
010773R	111	Straight	Black Divider 111 x 1-1/4"	Ea
010774R	111	Straight	Black Divider 111 x 1/2"	Ea
010776R	111	Straight	Black Divider 111 x 1"	Ea
010777R	111	Straight	Black Divider 111 x 23"	Ea
01078R	119	Straight	Black Divider 119	Ea
01079R	119	Straight	Black Divider for 119-NB-120	Ea



# Mold Accessories

(866) 260-6457  
www.Rjmarshall.com



## Black (Reinforced) End-Stop Dividers (continued)

Order No.	Series	Profile	Description	UOM
010805R	128	Straight	Black Divider 128	Ea
01080R	125	Straight	Black Divider 125	Ea
01082R	219	Straight	Black Divider 219	Ea
01083R	230	Straight	Black Divider 230	Ea
010835R	230	Straight	Black Divider 230 1-12" Custom	Ea
01087R	340	Straight	Black Divider 340	Ea
01097R	111	Chamfer	Black Divider Chamfer 111-NB-146	Ea
010992R	111	Straight	Black Divider 111-25-NB-146	Ea
010993R	522	Bullnose Close End	Black Divider 522-146 Close End	Ea
010995R	522	Bullnose	Black Divider 522 Bullnose 1-3/8"	Ea
010996R	522	Bullnose Banjo	Black Divider 522-146 Bullnose Banjo	Ea
010997R	522	Bullnose	Black Divider 522 Bullnose 1-1/2" Right 522RGT	Ea
010998R	522	Bullnose	Black Divider 522 Bullnose 1-1/2" Left	Ea
010999R	111	Straight	Black Divider 111 x 22-5/8"	Ea
011003R	525	Bullnose	Black Divider 525 - 1-1/2" Bullnose 25"	Ea
011005R	625	Bullnose	Black Divider 625 2" Bullnose Right	Ea
011006R	625	Bullnose	Black Divider 625 2" Bullnose Left	Ea
011008R	525	Bullnose	Black Divider 525 Left	Ea
011009R	525	Bullnose	Black Divider 525 Right	Ea
01117R	111	Radius	Black Divider Radius 111 Right	Ea
01118R	111	Radius	Black Divider Radius 111 Left	Ea
01120R	540	Straight	Black Divider 540-NB-146	Ea
011282R		Rope	Black Rope Divider Deck Left	Ea
011283R		Rope	Black Rope Divider Deck Right	Ea
01133R	111	Chamfer	Black Divider 111 Chamfer Right Hand	Ea
01134R	111	Chamfer	Black Divider 111 Chamfer Left Hand	Ea
011391R	522	Banjo Left	Black Divider 522 Banjo Arm Left	Ea
011392R	522	Banjo Right	Black Divider 522 Banjo Arm Right	Ea
011395R		Straight Rope	Black Divider Straight Rope 20876	Ea
011405R	138	Drop OG Left	Black Divider 138 Drop OG Left	Ea
011406R	138	Drop OG Right	Black Divider 138 Drop OG Right	Ea

## Yellow (Unreinforced) End-Stop Dividers

Order No.	Series	Profile	Description	UOM
01062	223	Straight	Yellow Divider 223	Ea
01064	137	OG	Yellow Divider 137-120 x 1/4" OG	Ea
01067	138	OG Front	Yellow Divider 138 - OG Front 25"	Ea
01071	138	OG Right	Yellow Divider 138 - OG Right Hand	Ea
01072	138	OG Left	Yellow Divider 138 - OG Left Hand	Ea
01078	119	Straight	Yellow Divider 119	Ea
01083	230	Straight	Yellow Divider 230	Ea
01097	111	Chamfer	Yellow Divider Chamfer 111-NB-146	Ea



# Mold Accessories

(866) 260-6457  
www.Rjmarshall.com



## Yellow (Unreinforced) End-Stop Dividers (continued)

Order No.	Series	Profile	Description	UOM
01120	540	Straight	Yellow Divider 540-NB-146 Bluntnose 3/4"	Ea
01133	111	Chamfer RT	Yellow Divider 111 Chamfer Right Hand	Ea
01134	111	Chamfer Left	Yellow Divider 111 Chamfer Left Hand	Ea
010671	138	OG Right	Yellow Divider 25" 138 - OG Right	Ea
010672	138	OG Left	Yellow 25' 138 - OG Left	Ea
010673	138	Left/Right OG	Yellow 25' 138 - OG Double Edge	Ea
010712	138	OG Front	Yellow Divider 138 OG Front	Ea
010721	138	Left/Right Single OG	Yellow Divider 138 - OG Double Edge	Ea
010723	138	OG	Yellow Divider 138 - OG 144 - 1/4"	Ea
010724	138	OG	Yellow Divider 138 - OG 144 - 1"	Ea
010725	139	OG	Yellow Divider 139 - 1" x 144"	Ea
010732	523	Bullnose Right	Yellow Divider 523 Bullnose Closed End Right	Ea
010733	523	Bullnose Left	Yellow Divider 523 Bullnose Closed End Left	Ea
010740	625	Bullnose	Yellow Divider 625 w/ 2" Bullnose	Ea
010744	630	Bullnose	Yellow Divider 630 w/ 2" Bullnose	Ea
010745	636	Bullnose	Yellow Divider 636 w/ 2" Bullnose	Ea
010752	110	Straight	Yellow Divider 110 - 1-1/4"	Ea
010754	110	Straight	Yellow Divider 110 EZ Fit with Grin	Ea
010755	219	Straight	Yellow Divider 219 EZ-Fit	Ea
010756	219	Straight	Yellow Divider 219 - 146 EZ-Fit with Grin	Ea
010771	111	Straight	Yellow Divider 111 - 15/16"	Ea
010772	111	Straight	Yellow Divider 111	Ea
010773	111	Straight	Yellow Divider 111 (1988) 1-1/4"	Ea
010774	111	Straight	Yellow Divider 111 - 1/2"	Ea
010777	111	Straight	Yellow Divider 111 - 23"	Ea
010805	128	Straight	Yellow Divider 128	Ea
010806	129	Straight	Yellow Divider 129	Ea
010835	230	Straight	Yellow Divider 230 Series x 1-1/2" Custom	Ea
010892	219	Straight	Yellow Divider	Ea
010993	522	Bullnose Close End	Yellow Divider 522 - 146 Close End	Ea
010994	522	Bullnose Close End	Yellow Divider 522 - 146 Close End	Ea
010995	522	Bullnose	Yellow Divider 522 Bullnose 1-3/8"	Ea
010996	522	Bullnose Banjo	Yellow Divider 522 - 146 Bullnose Banjo	Ea
010997	522	Bullnose Right	Yellow Divider 522 Bullnose 1-3/8" Right	Ea
010998	522	Bullnose Left	Yellow Divider 522 Bullnose 1-3/8" Left	Ea
011003	525	Bullnose	Yellow Divider 525-1-1/2" Bullnose 25"	Ea
011203	540	Bluntnose	Yellow Divider 540-NB-146 Bluntnose 1-1/2"	Ea
0107450	625	Bullnose	Yellow Divider 625 1-3/8" Bullnose	Ea
0107452	642	Bullnose	Yellow Divider 642 1-3/8" Bullnose	Ea
22354B	625	Bullnose	Yellow Divider/Aluminum Dam 625 1-1/2" Ends	Ea
22355B	636	Bullnose	Yellow Divider/Aluminum Dam 636	Ea
22356B	630	Bullnose	Yellow Divider/Aluminum Dam 630	Ea

## Lavatory Bowl Setup Components

### Faucet Hole Rings

Our silicone-coated Faucet Hole Rings are a real time saver for manufacturers, since they provide a fast, easy way to create 1¼" (3.2 cm) diameter faucet fixture holes in a vanity top. Faucet hole rings are positioned and set in place on the vanity mold to create holes in the finished product where the faucets will be installed, saving drilling time later. Installers need only to pop out holes prior to faucet installation. Available in five different sizes to accommodate different thicknesses of marble.

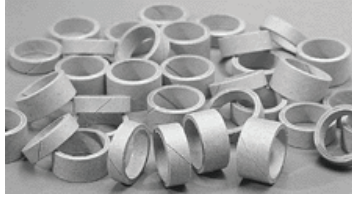

Cardboard (approx. 1,000 per box)

#### Order Information

- 3/8" (.95cm) - #000016C
- 1/2" (1.3cm) - #00001C
- 5/8" (1.6cm) - #00002C
- 3/4" (1.9cm) - #00003C
- 7/8" (2.2cm) - #00004C

### Bowl Clips

Bowl clips are used with the floating unit assembly for firmly attaching undermount bowls to marble vanity tops. The screw of the floating unit assembly fits through the slot of the bowl clip, resulting in a firm, solid attachment of undermount bowls to cultured marble vanity tops. Packaged in quantities of 100 or 1,000.

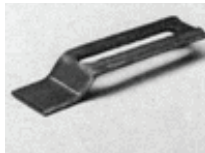

#### Order Information

- 100 per Box - #000061
- 1000 per Box - #00006

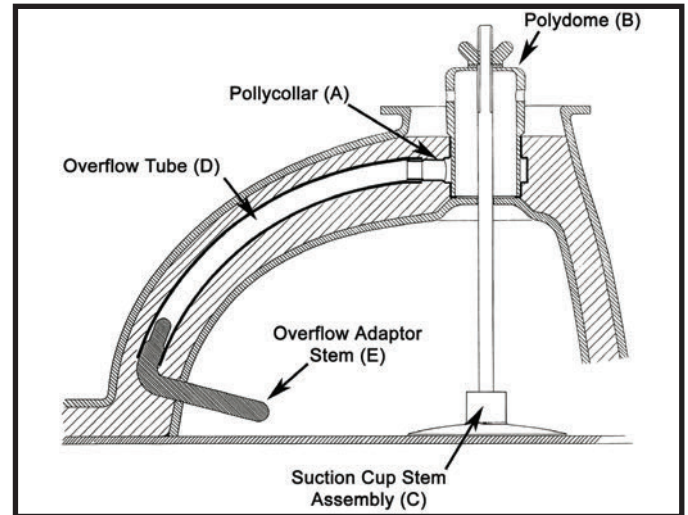

### Floating Unit Assembly (FUA)

Known at "T-Nuts" to many, they are placed into the ungelled matrix. When the marble cures, they provide a solid anchor for attaching undermount bowls to marble vanity tops and bases to marble table tops. The paper tab on the "T-Nut" assembly prevents it from sinking too far into the matrix and also serves as a spacer for the proper positioning of the "T-Nut" when used with speedy plugs. It also serves as a spacer for the proper positioning of the FUA when used with speedy plugs.

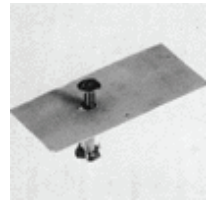

#### Order Information

- Assembled - 100/Box - #000051
- Assembled - 1000/Box - #00005

## Overflow System Components

### Polycollars

Trimmed polycollars have the top cut off, and untrimmed polycollars are not trimmed.

### Round Overflow Polycollars

The slim round polycollar used in combination with our 1/2" tubing and round stem provides an economical overflow system.

#### Order Information

- Trimmed - 1-Step - 100 per box - #001014G
- Trimmed - 1-Step - 500 per box - #001014-5G
- Trimmed - 2-Step - 100 per box - #00103G
- Trimmed - 2-Step - 500 per box - #00103-5G
- Trimmed - 3-Step - 100 per box - #00101G
- Trimmed - 3-Step - 500 per box - #00101-5G
- Untrimmed - 1-Step - 100 per box - #001013G
- Untrimmed - 1-Step - 500 per box - #001013-5G
- Untrimmed - 2-Step - 100 per box - #001011G
- Untrimmed - 2-Step - 500 per box - #001011-5G
- Untrimmed - 3-Step - 100 per box - #00102G
- Untrimmed - 3-Step - 500 per box - #00102-5G

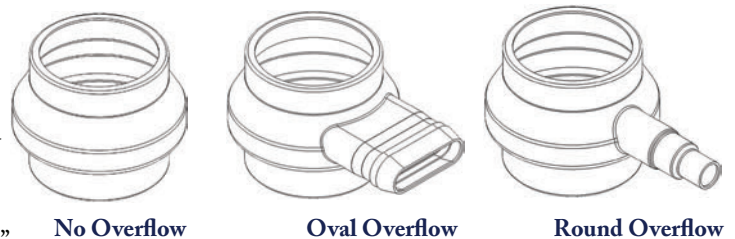

### No Overflow Polycollars

#### Order Information

- No Overflow - Trimmed - 100 per box - #00108G
- No Overflow - Trimmed - 500 per box - #00108-5G
- No Overflow - Untrimmed - 100 per box - #00106G
- No Overflow - Untrimmed - 500 per box - #00106-5G

### Oval Overflow Polycollars

Use with our polydome or drain boss, oval overflow pipe, and oval stem. The new slim style improves resistance to thermal shock, makes gelcoating application easier, and speeds production.

#### Order Information

- Trimmed - 100 per box - #00104G
- Trimmed - 500 per box - #00104-5G
- Untrimmed - 100 per box - #00105G
- Untrimmed - 500 per box - #00105-5G

## Polydomes & Assembly Components

### Standard Polydomes

Polydomes define the drain outlet size and serve as a base for the polycollar. Bolt it into place and gelcoat before casting. Fits perfectly with Marshall Gruber Polycollars.

Standard Polydome - Ea - #01130

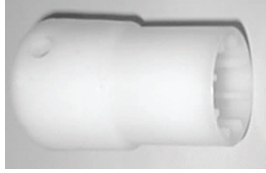

### Oval Overflow Pipe

The Overflow Pipe connects directly to the oval polycollar at the drain end and to the overflow stem at the overflow outlet. In addition, it features an integral, calibrated scale that permits quick and accurate trimming to achieve a proper fit on any size and shape of bowl. Like the polycollar, the overflow pipe becomes a permanent part of the finished bowl. They are available in boxes of 100 and 500.

#### Order Information

Overflow Pipe Box/100 - #00026G

Overflow Pipe Box/500 - #00026-5G

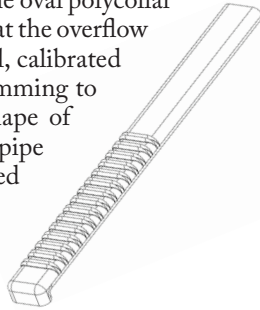

### Round Plastic Tubing

Flexible, pliable 1/2" clear vinyl tubing is used to provide a germ-resistant permanent bowl overflow. Fits snugly onto the round polycollar. Use with a round stem to create a clean outlet hole. Boxed plastic tubing is preferred if it is being shipped via UPS, since shipping boxed items is relatively less expensive.

#### Order Information

1/2" Round PVC Tubing - 100' Roll - #001010

1/2" Round PVC Tubing - 100' Roll (Boxed) - #001010B



### Drain Boss - Standard

Made from aluminum, this eliminates the need for polydomes, captive nut assemblies and suction cup assemblies. Polycollar fits directly onto the drain boss for faster production. 1-9/16" standard, but custom sizes available by request. Excellent for use with modular vanities and floating bowls (when using Ex-Wax).

#### Order Information

1-9/16" Standard Drain Boss - Ea - #191045



### Drain Boss - Hollow Core

This product utilizes the same 1-9/16" diameter Drain Boss, but with a larger 1/2" center drilled hole and a slightly larger bolt with drilled center "hollow core". The hollow core serves two functions: It allows pressure to be equalized from the mold surface to the backside of the mold. And allows the operator to blow air into the mold cavity during demolding.

#### Order Information

Drain Boss Captive Nut Assembly - Ea - #R-01132

### Suction Cup Stem Assembly

The Suction Cup Stem Assembly is used to firmly attach the polydome, overflow components and floating bowl mold to a vanity top mold. Individual components may be ordered separately. Fits all sizes.

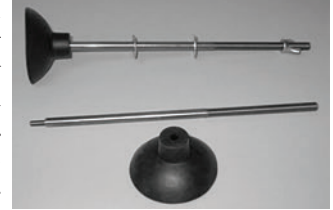

#### Order Information

11-1/2" Stem Assembly - Ea - #011271

Stem Only 3/8 x 11-1/2" 4" - Ea - #01127

Suction Cups for Stem Assembly - Ea - #01122

Wing Nut 3/8"-16 - Ea - #01123

3/8" Washer - Ea - #01123-1

### Captive Nut Assembly

Because this assembly is permanently affixed to the drain end of the mold, there is no need for a stem assembly. The polydome attaches with an eye bolt for easy removal. Time and materials are saved for a more efficient production process.



#### Order Information

Captive Nut Assembly - Ea - #01131

Bolt only - Captive Nut Assembly - Ea - #011311

Jam Nut - Captive Nut Assembly - Ea - #0113212

Captive Nut/Flat Washer 5/16 - Lb - #0113213

Lock Washer-Captive Nut Assembly - Ea - #0113214

### Reusable Stems

#### Oval To Round Adapter Stems

The adaptor stem allows manufacturers to connect round overflow tubing to a mold with an oval overflow hole already cut.

Adaptor Stem - Ea - #001017



#### Round Stems

The new round stem is angled 90° for easy insertion, so that round tubing can be attached without crimping. Creates a cleaner, more attractive outlet that is easier to finish, and eliminate the need to redrill when adding a round beauty ring.

Round Overflow Stem - Ea - #001015



#### Oval Stems

The oval stem was designed to fit Marshall Gruber Oval Overflow Pipe and Oval Beauty Rings. It is easily removed for reuse and eliminates costly refinishing of the overflow hole.

Oval Overflow Stem - Ea - #01124





## Mold Strippers & Cleaners

### GruberCare™ Stripper

Order Information

128oz can - Ea - #010614  
- Case of 4 - #010613

### MR Solvent Cleaner

Order Information

Quart Can - Ea - #MR0802  
- Case of 10 - #MR0803  
Gallon Can - Ea - #MR0804  
- Case of 4 - #MR0805

### GruberCare WetStrip™ Mold Cleaning System

**Designed for:** Thorough cleaning of all mold finishing compounds, including wax based release systems, and substantial removal of polymer based release systems. Excellent for surface preparation prior to application of polymer or waxed based releases.

**Benefits:**

- Ecological - all water based, biodegradable.
- Labor saving - cleans faster than solvent wiping.
- More effective - better porosity cleansing of polishing compounds.

### MR 2-in-1

Order Information

Gallon - Can - #MR0904  
- Case of 4 - #MR0905

### MR E Release

Order Information

Liter - #MR1004-L  
Gallon - #MR1004 (note: min. order 125 liters\*/approx. 32 gallons)  
53 Gal Drum - #MR1004-D

### MR 100 Waterbase

Order Information

Gallon - Case of 4 - #MR0705



**Not designed for:** Dissolving styrene buildup, green wax crystallization or other process contamination. WetStrip replaces the use of harsh solvent cleaning after new mold building or maintenance processes.

### MR Wet Strip Kit

Kit includes 1 gallon wet/strip cleaner, 1 gallon wet/strip rinse, 2 empty spray bottles, and 1 brush.

Order Information

Kit - Ea - #MR0600  
Bottles - Ea - #MR0602  
Brush - Ea - #MR0603

### MR Wet Strip Cleaner

Cleaner only.

Order Information

Gallon - #MR0404  
Gallon - Case of 4 - #MR0405  
55 Gal Drum - #MR0408

### MR Wet Strip Rinse

Rinse only.

Order Information

Gallon - Can - #MR0504  
Gallon - Case of 4 - #MR0505  
55 Gal Drum - #MR0508

## Mold Sealers

### GuberCare MR Sealer

GruberCare MR Sealer is designed as a mold sealer for glass reinforced polyester, vinyl ester, epoxy or metal molds. For use in combination with the MR GP and MR HI-TEC products. It should be used to prevent styrene emission or migration from new molds and eliminate surface porosity of metallic molds. The resin both seals micro porosity and fills minor scratches on the mold surface. The result is a smooth, high gloss surface primed for GruberCare top-coat application. GruberCare MR Sealer is especially recommended for use on new molds and repaired areas on older molds.

**Product Benefits:**

- Efficient mold sealer and primer
- Easy application
- Enhances mold gloss (see application details for appropriate coating technique)
- Low odor
- Minimal mold build-up
- Versatile, can be used on all mold surfaces
- Durable; provides semi-permanent base-coat for mold release agent top coats

Order Information

Quart - Ea - #MR0102  
Quart - Case of 10 - #MR0103  
Gallon - Ea - #MR0104  
Gallon - Case of 4 - #MR0105  
Squeeze Bottle - 1 Pint - Ea - #MR0601-1



### GruberCare Sealer

Order Information

32 oz can - Each - #010628  
32 oz can - Case of 4 - #010627  
128 oz can - Each - #010626  
128 oz can - Case of 4 - #010625

**Mold Release**

**Grubercare MR GP (General Purpose Multi-Release)**

Multi-release system yielding high gloss moldings. GruberCare MR GP is designed to release gel-coated glass reinforced polyester or vinyl ester parts from gel-coated molds. Purposely formulated for reinforced polyester resins or high gloss moldings using gelcoats and increased temperature performance. GruberCare MR GP is an advanced polymeric resin in a non-chlorinated organic solvent blend. GruberCare MR GP is ideally suited for high gloss applications. The product is quick and easy to apply and produces a high gloss durable finish capable of giving many releases before reapplication is necessary.

**Product Benefits:**

- Easy application
- Non contaminating
- Non-chlorinated, Ecologically friendly solvents
- Low odor
- Minimal mold build-up
- Superior gloss retention
- Durable; provides multiple releases per application

**Order Information**

- Quart Can - Ea - #MR0202
- Quart - Can - Case of 10 - #MR0203
- Gallon - Ea - #MR0204
- Gallon - Case of 4 - #MR0205
- Squeeze Bottle - 1 Pint - #MR0601-2



**GruberCare Interphase Wax**

GruberCare Interphase Wax is a liquid blend of high-melting point waxes formulated as an interphase release to minimize dulling wax build-up caused by continuous use of Release Wax. When used in conjunction with GruberCare Release/Indicated Wax, time between mold strippings can be extended significantly. Use Interphase Wax approximately every 10 castings or when dulling wax build-up begins to appear on the mold surface.



**Order Information**

- 128 oz can - #010622
- 128 oz can - Case of 4 - #010621

**GruberCare Release Wax**



**Order Information**

- 15 oz can - Ea - #010630
- 15 oz can - Case of 12 - #010629

**GruberCare MR Hi-Tec**

GruberCare MR Hi-Tec is designed to release epoxy, polyester, vinyl ester, phenolic and other thermosetting resins. Provides a durable film capable of giving many releases per application and will not contaminate the released surface.



**Order Information**

- Quart - Can - Ea - #MR0302
- Quart - Can - Case of 10 - #MR0303
- Gallon - Ea - #MR0304
- Gallon - Case of 4 - #MR0305
- Squeeze Bottle - 1 Pint - #MR0601-3

**GruberCare Flange Wax**

**Order Information**

- 108 oz can - #010618
- 108 oz can - Case of 4 - #010617
- 5 Gal (Slurry Wax equivalent) Pail - Ea - #010645

**Cotton Blend Wipe**

Cotton wipes are made of a special lint-free fiber construction that is both durable and yet disposable. They are great for waxing molds and for general clean-up.

**Order Information**

- Cotton Blend Wipe - 25 lb Box - 3010138

**Mold / Gelcoat Repair Kits**



**MetaMold Gelcoat Repair Kits**

These Gruber Gelcoat Repair Kits are used to repair Gruber Molds constructed of MetaMold gelcoat process. These kits provide necessary gelcoat repair material to repair most nicks, impacts, scratches and other damage.

**MetaMold Gelcoat Patch Kit**

- 1 Pint - #191226

**MetaMold Repair Kit with Surfacing Agent**

This kit provides the same components as the MetaMold kit, but also includes a surfacing agent.

**MetaMold Kit w/ Surfacing Agent**

- 1 Pint - #191230

**Vinyl Ester Repair Kits**

These Gruber Gelcoat Repair Kits are used to repair Gruber Molds constructed of Vinyl Ester gelcoat process. These kits provide necessary gelcoat repair material to repair most nicks, impacts, scratches and other damage.

**Vinyl Ester Gelcoat Patch Kit**

- 1 Pint - #191228

**Vinyl Ester Repair Kit with Surfacing Agent**

This kit provides the same components as the Meta Mold kit listed above, but also includes a surfacing agent.

**Vinyl Ester Kit w Surfacing Agent**

- 1 Pint - #191231

**Red Gelcoat Mold Repair Kits - #191225**



## Tooling Wax & Clay

### Rhino Extrudable Wax

Cast polymer manufacturers have long recognized the benefits of using wax fillets in setting up molds for production. The smooth radii and ease of finishing from wax provide significant benefits to the user compared to clay. Marshall Gruber has developed an extrudable wax that combines the flexibility of clay and the quality of wax. Our wax is available in 5" x 1" sticks.

#### Order Information

- Ex-hard 2lb box - #SP1018
- Ex-hard 24lb case - #SP1019
- Hard 2lb box - #SP1020
- Hard 24lb case - #SP1021
- Soft 2lb box - #SP1022
- Soft 24lb case - #SP1023
- Ex-Soft 2lb box - #SP1024
- Ex-Soft 24lb case - # SP1025



### Tooling Clay

Tooling Clay is used for the same purposes as Ex-Wax and Tooling Wax - to create a smooth radius between the edge of a floating bowl mold and the surface of the vanity deck on which it is positioned. Like Ex-Wax, no special applicator tools or heat are required in its use. The clay can be extruded in the size required through the Clay/Wax Extruder. Sold in 5 lb Boxes of 20 sticks or 50 lb Cases of 10 Boxes (200 sticks). Each clay stick is 4 oz and 1" x 1" x 5"



#### Order Information

- Tooling Clay Soft - 5lb Box - #02209A
- Tooling Clay Soft - 50lb Case - #02210A
- Tooling Clay Hard - 5lb Box - #02209H
- Tooling Clay Hard - 50lb Case - #02210H

### Tooling Wax

Tooling Wax is used to create a smooth radius between the edge of a floating bowl mold and the surface of the vanity deck on which it is positioned. Available in a 1lb roll, 2lb boxes and case quantities.



#### Order Information

- #1 - 1/16" - 1lb Roll - #01037
- #1 - 1/16" - 2lb Roll - #01038
- #2 - 1/8" 1 lb Roll - #01039
- #2 - 1/8" - 2lb Box - #01040
- #2 - 1/8" - 2lb - Case of 20 Rolls - #010400
- #3 - 3/16" - 1lb Roll - #01041
- #3 - 3/16" - 2lb Box - #01042
- #3 - 3/16" - 2lb - Case of 20 Rolls - #010420

### EX-Wax

This Marshall Gruber extrudable fillet material offers the best characteristics of both fillet wax and modeling clay. EX-Wax leaves a smooth radius, doesn't contain solvents, tools easily and is extrudable. A box contains 12 sticks and weighs 2lbs. A case contains 12 boxes of 12 sticks each, or 144 total sticks.

#### Order Information

- Super Extra Soft - Case/12 Boxes - #02218
- Soft - Case/12 Boxes - #02214
- Hard - Case/12 Boxes - #02216
- DuraHard - Case/12 Boxes - #02219
- Super Soft - Box/12 Sticks - #02223
- Soft - Box/12 Sticks - #02213
- Hard - Box/12 Sticks - #02215
- DuraHard - Box/12 Sticks - #02220

## Applicators & Accessories

### Waxing (Radius) Tools

Create a smooth, clean wax radius around the edge of your molds on a deck surface with these handy, simple, radius hand tools that work.



#### Order Information

- #1 (1/4-1/8 Radius) - Ea - #01031
- #2 (1/2-3/8 Radius) - Ea - #01032
- #3 (3/4-5/8 Radius) - Ea - #01033

### Clay/Wax Extruder's & Parts

The Pneumatic or Manual Clay Extruder offers a convenient way to quickly create an exacting bead of wax or clay for mold setup.

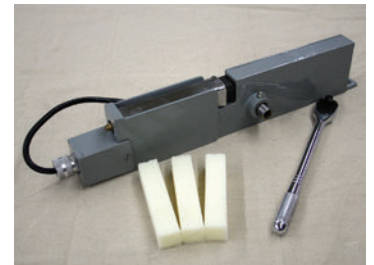

#### Order Information

- Manual Extruder - Ea - #100005
- Pneumatic Extruder - Ea - #100017

#### Related Accessories:

- Kit, Nozzle, Clay Extruder (Set/3) - #100012
- Clay Extruder Light Bulb - Ea - #100013
- Pneumatic Extruder Teflon Scraper - Ea - #100021
- Pneumatic Clay Extruder Tube - Ea - #1000214

## Masking Tape & Other Tapes

Marshall Gruber offers a variety of quality tape products for a variety of uses and applications.

### #519 General-Purpose Masking Tape\*

High quality, crepe paper coated with a superior pressure-sensitive adhesive. Excellent tensile strength and moderate heat and UV-resistant. Adheres to most surfaces. Clean removal.

#### Order Information

- 3/4" #519 Masking (18mm) - Ea - #X010183A  
- Case of 48 - #X010184A
- 1" #519 Masking (24mm) - Ea - #X010181A  
- Case of 36 - #X010182A
- 1-1/2" #519 Masking (36mm) - Ea - #X010185A  
- Case of 24 - #X010186A
- 2" #519 Masking (48mm) - Ea - #X010187A  
- Case of 24 - #X010188A
- 3" #519 Masking (72mm) - Ea - #X010179A  
- Case of 16 - #X010180A

### #515 Utility Grade Masking Tape (Intertape)\*

Versatile, general-purpose, semi-bleached crepe paper with excellent tensile strength and bonding properties. Very comfortable, and good resistance to "bleed-through". Used for a variety of home and industrial applications.

#### Order Information

- 1" #515 Masking (24mm) - Ea - #X010181  
- Case of 36 - #X010182
- 1-1/2" #515 Masking (36mm) - Ea - #X010185  
- Case of 24 - #X010186
- 2" #515 Masking (48mm) - Ea - #X010187  
- Case of 24 - #X010188

### RG15 General Purpose Strapping Tape

A 5.6 mil, clear, fiberglass reinforced, polyester backed, pressure-sensitive strapping tape with good adhesion, medium tensile strength and medium impact strength. Excellent resistance to scuffs, abrasion and moisture. Adheres to almost any surface. Ideal for everyday bundling and palletizing.

#### Order Information

- 3/4" #RG15 Reinforced (18mm) - Ea - #X010194R  
- Case of 48 - #X010195R

\*Special order item - minimum order based on size requested applies. Lead times apply.

## Silicone / Sealant

### BOSS #385 RTV Tub'N'Tile Plumber Silicone

Silicone is the perfect all purpose adhesive and sealant for the installation of kitchen, bath, or any product exposed to any wet environment.

#### Order Information

- Clear - 10 oz. Tubes - Case of 12 - #010233B
- White - 10 oz. Tubes - Case of 12 - #010237B
- Translucent - 10 oz. Tubes - Case of 12 - #010235T

### Caulking Gun

#### Order Information

- Caulking Gun - Ea - #191089

### PG505 Crepe Paper Masking Tape

PG505 is a 5.8 mil, general grade, industrial, pressure-sensitive masking tape. PG505 offers an excellent balance of quick stick, panel adhesion and holding properties. Not recommended for outdoor exposure.

#### Order Information

- 3/4" (18mm) Amer PG-505 - Case of 48 - #AM010184
- 1" (24mm) Amer PG-505 - Case of 36 - #X010154
- 1-1/2" (36mm) Amer PG-505 - Ea - #X010155  
- Case of 24 - #AM010186
- 2" (48mm) Amer PG-505 - Ea - #X010157  
- Case of 24 - #AM010188

### #591 Double Coated Paper Tape

This flatback paper is coated on both sides with a high shear adhesive that bonds to almost any surface. Easy release crepe paper liner allows for automatic or hand dispensing applications. Excellent tensile strength, conforms to almost any surface without tearing.

#### Order Information

- 1/2" #591 Double Face (12mm) - Ea - #X010190  
- Case of 72 - #X010191
- 3/4" #591 Double Face (18mm) - Ea - #X010192  
- Case of 48 - #X010193
- 1" #591 Double Face (24mm) - Ea - X010200  
- Case of 36 - X010201

### #597 Double Sided Vinyl Film Tape

Durable PVC film with permanent rubber adhesive, 5.9 mil and 15lb tensile strength. Vinyl film tape for a variety of general purpose uses. Ideal for splicing paper or foil, sign positing, mirror manufacturing, engravers, insulation holding on metal buildings and carpet mounting.

#### Order Information

- 3/4" (18mm) #597 Double Face Vinyl - Ea - X010192A  
- Case of 48 - X010193A

### 01018 Double Faced Foam Tape

#### Order Information

- Thermal Insulated 1/6"x3"x100' - 164284

### Dow Corning Tub, Tile & Ceramic Silicone Sealant

Dow Corning® Tub, Tile, and Ceramic Silicone Sealant, a one-component, acetoxy-cure, fast-cure, mildew-resistant silicone rubber sealant for watertight sealing bathtubs, shower enclosures, sinks, vanities, counter tops, ceramic tile, lavatories, faucets saunas, hot tubs, plumbing fixtures, and piping. Dow Corning® Tub, Tile, and Ceramic Silicone Sealant is designed for dynamically moving joints for both new and remedial construction. Cured sealant is mildew resistant.

Special order only.

#### Order Information

- Clear - 10.3 Oz Tubes - Case of 12 - #X010233
- White - 10.3 Oz Tubes - Case of 12 - #X010237
- Transparent - 10.3 Oz Tubes - Case of 12 - #X01035

## Clear Protective Film

Marshall Gruber Clear Protective Film is perfect for protecting the finished surface of all of your cast polymer products. Designed to protect the finish of any product during shipping, storage, or installation, protective film is the best way to insure your product looks as good as the day it was made. Specifically designed for cultured marble applications.



### Order Information

6" - 3 mil - 600' Roll - Ea - #66003  
6" - 5 mil - 600' Roll - Ea - #66005  
12" - 3 mil - 600' Roll - Ea - #126003  
15" - 3 mil - 600' Roll - Ea - #156003  
18" - 3 mil - 600' Roll - Ea - #186003  
21" - 3 mil - 600' Roll - Ea - #216003  
21" - 5 mil - 600' Roll - Ea - #216005  
24" - 3 mil - 600' Roll - Ea - #246003  
24" - 5 mil - 600' Roll - Ea - #246005  
30" - 3 mil - 600' Roll - Ea - #306003  
36" - 3 mil - 600' Roll - Ea - #366003

## Abrasives

## Sanding, Grinding & Buffing Media

### Eagle Wet/Dry Sandpaper

9 x 11", Sleeve of 50 sheets.

#### Order Information

80 grit - Sleeve - #SPE80  
100 grit - Sleeve - #SPE100  
120 grit - Sleeve - #SPE120  
180 grit - Sleeve - #SPE180  
220 grit - Sleeve - #SPE220  
320 grit - Sleeve - #SPE320  
400 grit - Sleeve - #SPE400  
600 grit - Sleeve - #SPE600  
800 grit - Sleeve - #SPE800  
1000 grit - Sleeve - #SPE1000  
1200 grit - Sleeve - #SPE1200

### Grinding Discs - 7"

#### Order Information

7"x7/8", 24 grit  
- Box/25 - #102061B  
7"x5/8", 36 grit  
- Box/25 - #102063B  
7", 24 grit  
- Box/50 - #T8332-24

### Sanding Discs

#### Eagle 5" STIKIT

#### Order Information (100 per box)

80 grit - #SPD80-5  
120 grit - #SPD120-5  
150 grit - #SPD150-50  
180 grit - #SPD180-50  
220 grit - #SPD220-50  
320 grit - #SPD320-50  
400 grit - #SPD400-50  
600 grit - #SPD600-50

#### Eagle 6" STIKIT

#### Order Information\*(100 per box)

80 grit - #SPD80-6  
120 grit - #SPD120-6  
150 grit - #SPD150-6  
180 grit - #SPD180-6  
220 grit - #SPD220-6  
320 grit - #SPD320-6  
400 grit - #SPD400-6  
600 grit - #SPD600-6

\*Dustless versions also sold. Call for availability.

### Sanding Belts

#### Order Information

3 x 21" - 40 grit - Box/10 - #SB321-B  
15 x 60" - 60 grit - Box/10 - #A1560B60

### Wide Sanding Belts for Wide Belt

#### Sanding Machines - 37"x60"

#### Order Information

120 grit - Ea - #SSB120  
240 grit - Ea - #SSB240

### Buffing Bricks

Buffing Bricks are an all-purpose fine abrasive compound that is ideal for everything from buffing minor scuffs and scratches on mold surfaces to polishing of finished parts. Use on molds after final sanding. Product is a unique wet/sharp silica-based compound. Formulated in a dry, brick-like form, buffing bricks are sold separately in two separate box quantities, or per pound in drum.

Quantity pricing is available - call for details.

#### Order Information

Gruber Buffing Brick - Each - #01015  
Gruber Buffing Bricks - 10/Box - #010151  
Gruber Buffing Bricks - Drum/lb - #010152

### Buffing Bricks - for Cultured Marble

Quickly and easily removes orange peel, sandpaper marks and slight imperfections. Leaves work clean with high lustrous finish. Use on gel-coated fiberglass surfaces after final sanding to bring out luster.

Available in three abrasive grades:

Mild / Medium / Sharpest

3lb bricks sold individually or in cases of 10.

#### Order Information

WP-1, White (Mild) - Ea - #010154J  
- Case - #0101545J  
WP-5, Green (Medium) - Ea - #010155J  
- Case - #0101555J  
WP-12, Blue (Sharpest) - Ea - #010153J  
- Case - #0101535J

### Buffing Pads

Made of long-lasting, heavy-duty fibers. These 8" diameter buffing pads are intended for use with rotary buffers. They include a semi-rigid canvas backing. Buffing pads come in several styles: with or without hook and loop fasteners. Available individually or in cases of 36.

#### Order Information\*

#### 100% Wool

1-1/2" - Each - #010165  
1-1/2" - Case - #0101652  
1-1/2" - Case - #010166  
1-1/2", w/Soft Curve - Each - #010167  
1-1/2", w/Soft Curve - Case - #010168

#### 50% Wool, 50% Polyester blend

1-1/2" - Each - #010163  
1-1/2" - Case - #010164  
1-1/2", w/Soft Curve - #010175  
1-1/2", w/ Soft Curve - Case - #010176

#### With Velcro backing

1-1/2" - Blend - Case - #010178  
1-1/2" - Wool - Each - #010179  
1-1/2" - Wool - Case - #010180

#### Other

50/50, 1-1/2" Wool - Case - #010164B  
Pad, Double Face - 1/Box - #0101664C  
Finishing (Fine), 7" - Case - #010149  
Superbuff 2+2 White  
- Case/24 - #DS010182  
Superbuff 2+2 Double Sided Yellow  
-Case/24 - #DS010184

\*Repackaging fee may apply to smaller quantities.

### Buffing Pad Cleaning Tool

This simple tool extends the life of your buffing pads by breaking-up dried compound and removing it from the pad.

#### Order Information

Buffing Pad Cleaning Tool - #01017



## Hole Saws

### Heavy-Duty, Carbide-Tipped Hole Saws

#### Order Information

- 3/4" Hole Saw - Ea - #020429
- 7/8" Hole Saw - Ea - #020430
- 1" Hole Saw - Ea - #020431
- 1-1/8" Hole Saw - Ea - #020461
- 1-1/4" Hole Saw - Ea - #020432
- 1-1/2" Hole Saw - Ea - #020433
- 1-3/8" Hole Saw - Ea - #020465
- 1-5/8" Hole Saw - Ea - #020466
- 1-3/4" Hole Saw - Ea - #020434
- 1-7/8" Hole Saw - Ea - #020467
- 2" Hole Saw - Ea - #020435
- 2-1/8" Hole Saw - Ea - #020468
- 2-1/4" Hole Saw - Ea - #020436
- 2-1/2" Hole Saw - Ea - #020437
- 2-3/8" Hole Saw - Ea - #020439
- 2-5/8" Hole Saw - Ea - #020469
- 2-3/4" Hole Saw - Ea - #020441
- 2-7/8" Hole Saw - Ea - #020470
- 3" Hole Saw - Ea - #020442
- 3-1/4" Hole Saw - Ea - #020443
- 3-1/2" Hole Saw - Ea - #020440
- 3-5/8" Hole Saw - Ea - #020473
- 4" Hole Saw - Ea - #020445
- 4-1/4" Hole Saw - Ea - #020475
- 4-1/2" Hole Saw - Ea - #020462
- 5" Hole Saw - Ea - #020463



### Hole Saw Shanks and Drill Bits

#### 1/4" Pilot Drill Bit and Shank Combination Kits:

Note: Hole Saw Shanks include a 1/4" Pilot Drill Bit in the kit. 3/8" Shanks require purchase of separate 3/8" Pilot Drill Bit.

For 3/4" to 7/8" hole saws (S-12) - Ea - #020451  
Set = one S-12 Shank and one CP-41 Pilot Drill Bit (see below).

For I " to 3-3/4" hole saws (HS-S4) - Ea - #020452  
Set = one HS-S4 Shank and one CP-41 Pilot Drill Bit (see below).

#### Shank only for 3/8" Pilot Drill Bit

Note: No Pilot Drill Bit is included with this item.

For 4" to 7-1/2" hole saws (XHS-6A) - Ea - #020464

Note: For 3/8" Pilot drill bit, Order Item No. 020459 below.

### Pilot Drill Bits

Note: These Pilot Drill Bits do not include a shank. See above.

Pilot Drill Bit - 1/4" Diameter (CP-41) - Ea - #020460

Pilot Drill Bit - 3/8" Diameter - Ea - #020459

## Hand Tools & Accessories

### Clamps

#### Heavy Duty Gee Clamps

Heavy duty Gee Clamps are compatible with all Gruber Systems tubs, shower bases, and modular and custom vanity molds.



#### Order Information

Gee Clamps - Each - #103615

### Scrapers

Scrapers are used to quickly and easily remove material from deck and other flat surfaces.

#### Order Information

Pot Scraper - 3-1/2" x 6-1/2" - Ea - #020260

Rubber Squeegee - 36" - Ea - 110391

### Wedges



Plastic Wedges (from top to bottom (Lg, Med, Sm))



Hardwood Wedges

#### Order Information

Hardwood Wedges\* - 4" x 3/4" - Bag of 100 - #010066

Hardwood Wedges\* - 4" x 3/4" - Box of 500 - #010067

\*Note: Hardwood wedges may vary in precise dimensions.

Plastic Wedge (Smallest) - 4" x 1-1/2" - Ea - #PW41

Plastic Wedge (Small) - 5-3/4" x 1-7/8" - Ea - #010063

Plastic (Medium) - 6" x 2-1/4" - Ea - #PW62

Plastic (Large) - 10" x 3-1/8" - Ea - #PW103

## Spray Equipment

### Air Powered Gelcoat/Resin Spray Gun - with 6" Tip

**Model 100-6, For all Gelcoat and Spray Granite applications.**



Complete with FN6 nozzle, lid, plastic cup, nozzle brush, paper cup, cup liner, micron gauge & instructions. This professional grade sprayer is a must for every fiberglass, composite and cultured marble shop. This gun is used for spraying not only gelcoat and resins, but other materials such as parting films, spray gypsum, tooling gelcoats, sandable primers, granite enhanced gelcoats, adhesives and paints. With our largest nozzle, it will even sand blast. The easy to clean design means clean up times less than five minutes. Wipe the lid and nozzle, through away the cup, and you're ready to go again. We have also designed the gun to work with standard paper cups (Sweetheart P4325 & Solo 320).

#### Order Information

Model 100 Cup Gun (w/#6 tip) (G300-001) - #G100

#### Fluid Nozzles

##### Order Information

FN-3 - 3/32" (2.4 mm) Fluid Nozzle - #G200-3  
FN-6 - 3/16" (4.8 mm) - #G200-6  
FN-8 - 1/4" (6.2 mm) - #G200-8  
FN-9 - 9/32" (7.1 mm) - #G200-9  
Fluid Nozzle "O" Ring (1 Req.) - #G200-009A

### Replacement Parts - Model 100 Spray Gun

#### Order Information

Replacement Tips (#4/#5/#6) - Set/3 - #G1001  
100-4 Air Nozzle Assembly (w/ O-Rings) - #G100-4  
O-Ring - #G200-002B  
Flow Control (Needle Valve Assembly) - #G200-014  
Model 100 - "O" Ring Rebuild Kit\* - #G200-016  
Trigger Assembly V/O Rings - #G100-7  
Trigger/Needle Valve Body "O" Ring - #G300-002A  
Trigger Valve Upper Body "O" Ring - #G300-002B  
Trigger Valve Stem "O" Ring - #G300-003A  
Air Nozzle Assembly (with "O" Rings) - #G300-004  
Air Nozzle "O" Ring - #G300-005A  
Lock Screw "O" Ring - #G300-006A  
Lock Screw Assembly W/ "O" Ring - #G300-007  
Pull Ring Spring - #G300-012  
Pull Ring Spring Assembly - #G300-013  
Needle Valve Assembly - #G300-014  
Needle Valve Stem "O" Ring - #G300-015A  
"O" Ring Rebuild Kit (for G100-gun) - #G300-016

### Disposable Spray Gun Cups

Disposable 32oz. Sweetheart Cups are designed to fit the ES-100 Cup Gun and are coated for Gel-Coat spraying operations.

#### Order Information

Paper cups - 32 oz unwaxed\*\* - Sleeve/25 - #G200  
Paper cups - 32 oz lined\*\* - Case/500 - #G2001  
Plastic Liner For Reusable Cups Pk/100 - #G300-011-BAG  
Polycup For Model 100 Gun - #G200P  
Cast Aluminum Cup Lid - #G300-010-3  
Cup Lid Assembly (Aluminum) - #G200010  
Graduated Heavy Duty Plastic Cup - #G300-011HD  
\* 2-2A, 2-3A, 2-5A, 1-6A, 3-9A and 1-15A  
\*\* Fits Models 100/200/300 spray guns

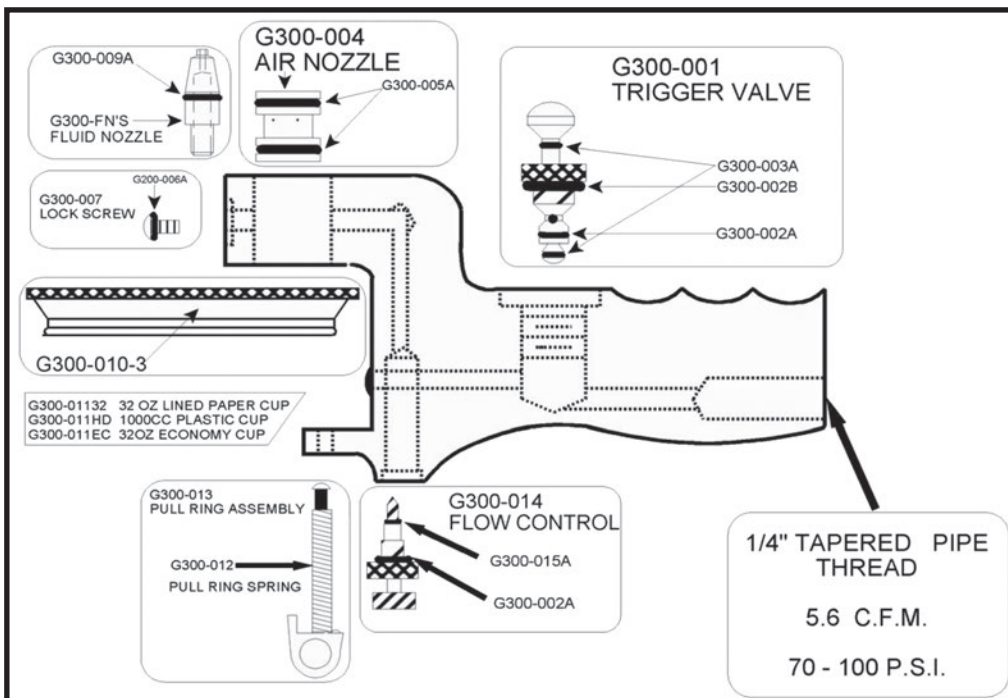

### Stir Sticks

Useful for many shop uses - including mixing gelcoat or pigment, spread adhesive, etc. Box of 1000.

Order No. 020261

### Catalyst Dispenser Squeeze Bottles

Order No. 020070



## *Bathroom Accessories*

### Beauty Rings (Vanity Overflow Holes)

Beauty Rings are a small decorative component that is used to surround, beautify and protect a bowl overflow hole. Rings are available in both oval and round shapes, and in a variety of finishes, including chrome, polished brass and white plastic. Subject to minimum purchase quantities.



### Oval Beauty Rings

#### Order Information

Chrome Plated (ABS plastic) - 100/Bag - #001010C

White Plastic - 100/Bag - #001012W

### Round Beauty Rings

#### Order Information

Chrome Plated (ABS plastic) - 100/Bag - #001011C

White Plastic - 100/Bag - #001013W

### Towel Bars & Rings

Special sizes available - call for more information.

#### Order Information

Towel Bar/Acrylic 24" L x 1" Diameter - Ea - #0001812

Towel Ring - Chrome plated - Ea - #000171

Towel Bar - Chrome plated - 24" - Ea - #000181

### Shower Drains

#### Order Information

Shower Pan Drain - Chrome - Ea - #SD103C

Shower Pan Drain Plug (rubber) - Ea - #191291

Drain Collar - Black Universal (nylon) - Ea - #018001

Drain Collar - White Universal (polyethylene) - Ea - #01800

### 6" Grab Bars

#### Order Information

White Acrylic - Ea - #07809C6

Chrome ABS - Ea - # 07825C6

Brushed Nickel ABS - Ea - #07841C6

## *Personal Protective Equipment*

### Latex Gloves



### Heavy Duty Latex Gloves

12 dozen (144) per case.

Large - #000198-L

### Disposable Latex Gloves

Disposable/single-use. Pre-powdered, natural latex. Non-sterile, Ambidextrous.

#### Order Information

Large - #002000-L

Medium - #002000-M

### Coveralls/Aprons

Disposable Aprons - 100/Box - #010141



### Respirators & Masks

#### Particulate Respirator

Medium/Large - Moldex N95 - 20/Box - #990031



#### Molded Contour Cup Face Mask

Maytex. Aluminum Nose Guard. Exceeds 95% bacteria filtration efficiency. 50/Box.

#### Order Information

Molded Contour Cup Face Mask - 50/Box - #010142

Particle/Dust Mask - Box/30 - #990029R

### Cotton Knit Wipe

#### Order Information

Cotton Knit Wipes - 5 Lb Box - #010649W



## Assorted

### Filters

#### Order Information

#### Baghouse Grindbooth Filter Bags:

- Filter Bags - 6" diameter x 84" Large - Ea - #111309
- Filter Bags 6" diameter x 96" Large - Ea - #111310

#### HEPA Grinding Booth Filters:

- Pre-Filter 20" x 20" X 1" - Ea - #111341
- Pocket Filter 20" x 20" x 12" - Ea - #111343
- HEPA Filter - 24" x 24" x 12" - Ea - #111345

#### Vacuum Pump Filters

##### (for GS1000/GS1500 Vacuum Mixers):

- Filter Felt, 0740-V104 Vacuum Pump - Pair - #111664
- Vac Filter Assembly 0740-V104 - Ea - #111662

##### Vacuum Pump Filters (for GS1700 Vacuum Mixers):

- Filter, Vacuum Pump, AC393 - Ea - #0838210

#### Pneumatic System Filters:

- Filter Regulator Unit (Air Conditioner) - Ea - #180510
- Filter Regulator BB3-01-FK00 - Ea - #083205

#### Tilt/Rotate Cart Filter:

- Evaporator (SPG-100 Laman Air Dryer) - Ea - #0831610
- Filter replace - L-100 Laman Air Dryer) - Ea - 0831611

#### Hi-Boy Cart Filter:

- Vent Filter (Hi-Boy Hydraulic Tank) - Ea - #163670

### Wheels and Casters



From left to right: Vibe Table Wheels, Skatewheel for Conveyor systems, and 4" V-Groove wheels (pn 111106) for cart track.

#### Order Information

##### Replacement 350# Pot Dolly

- Standard Front Wheel - Ea - #083069
- Rear Swivel Type - Ea - #083070

##### Quiet Type Wheel (for Vibrator Tables) w/ Nut & Bolt (complete unit) - Ea - #0831400

##### Aluminum Insert For Wheel\* - Ea - #0831260

\*Aluminum inserts required for bearing assemblies, 2 required per wheel.

##### Standard Steel w/Wheel (Nut & Bolt) - Ea - #110039

##### Steel Skatewheel - Ea - #1100390

##### 4" V-Groove Wheel with Bearing / Bushing / Sleeve - Ea - #111106

##### Caster, Standard, Rigid, V-Groove - for Tilt/Rotate Table - Ea - #083090

### Table Vibrators

For use on Electric and Pneumatic Vibrator Tables.

Pneumatic Vibrators are used to vibrate excess air out of marble matrix after pouring. Three types are available - ball bearing, turbine and electric.

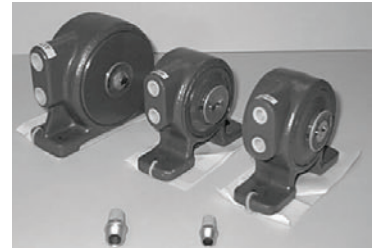

Vibrator Mufflers are used to reduce the noise during vibration.

#### Vibrators - Ball Bearing

##### Order Information

- Vibrator #25 - Ea - #02012
- Vibrator #35 - Ea - #02013
- Vibrator #41 - Ea - #02014
- Muffler - Vibrator #25 & #35 - Ea - #02015
- Muffler - Vibrator #41 - Ea - #02017

#### Vibrators - Turbine

##### Order Information

- VS-320 Vibrator - #VS-320
- VS-380 Vibrator - #VS-380

#### Vibrators - Electric

##### Order Information

- 230/460V, 60Hz, 3 Phase - 0831174

### Table Vibrator Replacement Bushings

#### Bushing for new style Pneumatic Vibe Table (with tube frames)

##### Order Information

- Replacement Bushing - Ea - #023007
- Replacement Kit - 8 Bushings - #023007K

#### **Black Vibe Bushings Electric** - Replaces vibrator bushings 023000 used on 3PH Electric Vibrator Table.

**Note:** When replacing an original bushing, you must replace all bushing, and you may need to lower the table by 1/4". To replace an original, buy the kit.

##### Order Information

- Replacement Bushing - Ea - #023005
- Replacement Kit - 8 Bushings - #023005K

#### Kit Stepped Vibe Bushing - Old Style. For use with old style tables with channel top frames.

##### Order Information

- Replacement Bushing - Ea - #023008
- Replacement Kit - 8 Bushings - #023008K

(866) 260-6457  
www.Rjmarshall.com







**MARSHALL  
GRUBER  
COMPANY**

## Introducing 5 NEW Spray Granatex Colors.

Granatex GTX 600 is better known throughout the industry as "Spray Granatex". Granatex 600 is a unique formulation used for spray manufacturing cost-efficient granite-looking products. Granatex 600 is highly suitable as an architectural surface coating.



**Coswell Gold**  
02750023

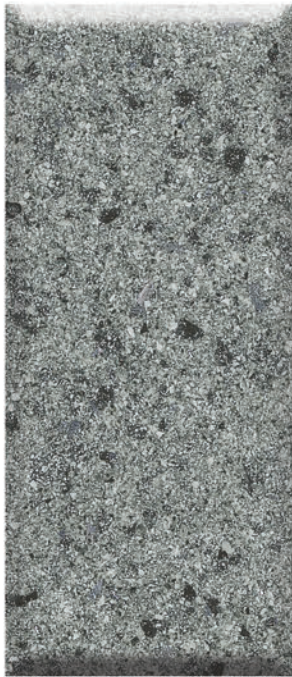

**Steel Gray\***  
02750022



**Brownstone**  
02750024



**Cobblestone Gray**  
02750025



**Brownwood**  
02750029

Once a sufficient layer of Granatex 600 has been applied, the remainder of the part can be back filled with a low cost casting system or reinforced with fiberglass. The result is an affordable part with granite-like appearance. Superior performance and depth can be achieved when sprayed behind a clear gelcoat. It can be applied to a wide range of materials using either a dry hopper spray system or a wet spray system.

Spray methods for Granatex 600 vary depending on the type of part and production equipment available. Dry hopper systems are excellent for large production shops due to minimal down time when changing colors and reduced clean-up time. In applications where parts are intricately shaped, a wet spray system works well as it can be more closely controlled. Marshall Gruber recommends a 70/30 gelcoat to granule ratio. Designed to be user friendly, Granatex 600 uses a mix and spray concept. Using the recommended ratio of gelcoat to granules, manufacturers simply have to blend the gelcoat, granules and appropriate amount of catalyst to create a mix that is ready to spray.

Available in 40 lb or 400 lb containers and Super Sack quantities are available upon request.

**Ask about custom color matching from Marshall Gruber.**

**866.260.6457**

**info@marshall-gruber.com**

**www.Rjmarshall.com**

\* Features a reflective additive.

Actual color and granule size will vary. Final product determination must be based on spraying in your process.

August 2016





# MARSHALL GRUBER COMPANY

Marshall Gruber offers an extensive range of the highest quality parts and products for the manufacture of cultured marble, solid surface, engineered stone and other cast polymer products. Marshall Gruber also offers tools, supplies and accessories for fabricators and other installers of kitchen and bath products.

*For customer service or assistance, contact:*

	Mansfield Facility	Rockledge Facility
Toll-free Telephone:	<b>(866) 260-6457</b>	
Local Telephone:	(682) 422-9674	(321) 639-0431
Fax orders:	(682) 518-9762	(321) 639-0437
Address:	220 Airport Drive Mansfield, Texas 76063	365 Gus Hipp Blvd Unit D Rockledge, Florida 32955
Email:	<b>info@marshall-gruber.com</b>	
Website:	<b>www.Rjmarshall.com</b>	

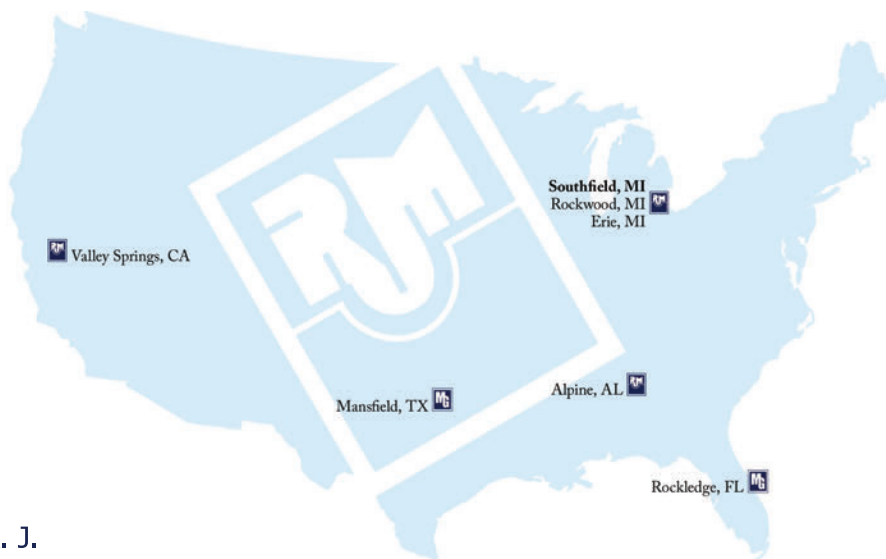

THE R.J.  
MARSHALL  
COMPANY

[www.Rjmarshall.com](http://www.Rjmarshall.com)

The Marshall-Gruber Company, LLC believes the above information to be accurate and true. However, the Marshall-Gruber Company makes no warranty, express or implied, with respect to the product's performance, color, quality, merchantability, or fitness for a particular purpose. Environmental conditions and/or manufacturing processes may vary beyond the Marshall-Gruber Company's control and users should satisfy for themselves that these materials are suitable for the particular application. Specification and design changes may occur at any time. The Marshall-Gruber Company is not responsible for inadvertent, accidental or typographical errors in this publication.

© 2017 by Marshall Gruber Company. All rights reserved. Specifications subject to change without notice.

**March 2017**