





# YOUR SOURCE FOR...

**SHEET METAL, INC.** visit our website at [www.zmsheetmetal.com](http://www.zmsheetmetal.com)

Quality through Innovation.

## QUALITY

- TIGHTEST MANUFACTURER'S TOLERANCES IN THE INDUSTRY
- HEM SAFETY EDGES FOR YOUR SAFETY & PROTECTION
- CONSISTENT GAUGE STANDARDIZATION
- COLOR CODED-BAR CODING PRODUCTS
- FABRICATED IN THE USA

---

**“Quality is remembered  
long after the  
price is forgotten.”**

## INNOVATION

- BAR CODING BOXES AND COLOR CODING OF FINISHED PRODUCTS
- COMPUTERIZED ESTIMATING SERVICE
- MASS PRODUCTION CAPABILITIES FOR STANDARD OR CUSTOM PRODUCTS
- AUTOMATED ASSEMBLY LINES

---

**“Other manufacturers  
develop products  
to meet their  
own objectives,  
we develop products  
to meet yours.”**

## SERVICE

- DEDICATED PRIVATE FLEET TO ENSURE PROMPT DELIVERY
- PERSONALIZED TRACKING OF ORDERS
- 3 TO 5 DAY TURN ON TRUCKLOADS
- ADD ONS TO ORDERS
- COMPUTERIZED RESIDENTIAL OR COMMERCIAL QUOTES
- TELEPHONE HOTLINE

# Round Pipe & Accessories



## No. 47 Round Pipe

Gauge	Length	3"	4"	5"	6"	7"	8"	9"	10"	12"	14"	16"	18"	20"	22"	24"
30	24"	10	10	10	10	10	10	5	5	5	N/A	N/A	N/A	N/A	N/A	N/A
26	24"	10	10	10	10	10	10	5	5	5	5	5	N/A	N/A	N/A	N/A
24	24"	N/A	5	10	10	10	10	5	5	5	5	5	5	5	5	5
30	60"	10	10	10	10	10	5	5	5	5	N/A	N/A	N/A	N/A	N/A	N/A
26	60"	5	5	10	10	10	5	5	5	5	5	5	N/A	N/A	N/A	N/A
24	60"	N/A	5	10	10	10	5	5	5	5	5	5	5	5	5	5
30	120"	1	1	10	10	10	5	N/A	N/A	N/A	N/A	N/A	N/A	N/A	N/A	N/A

## No. 48-90° Elbow

Gauge	Length	3"	4"	5"	6"	7"	8"	9"	10"	12"	14"	16"	18"	20"	22"	24"
30	90°	48	48	36	30	18	12	6	4	4	N/A	N/A	N/A	N/A	N/A	N/A
26	90°	24	48	24	18	18	12	6	4	4	4	4	N/A	N/A	N/A	N/A
24	90°	N/A	48	24	18	18	12	6	4	4	4	4	4	4	<b>BY ORDER</b>	

## No. 49-45° Angle

Gauge	Length	3"	4"	5"	6"	7"	8"	9"	10"	12"	14"	16"	18"	20"	22"	24"
30	45°	24	12	12	12	12	12	12	12	6	N/A	N/A	N/A	N/A	N/A	N/A
26	45°	24	12	12	12	12	12	12	12	6	4	4	N/A	N/A	N/A	N/A
24	45°	N/A	12	12	12	12	12	12	12	6	4	4	2	2	1	1

# Register Boots

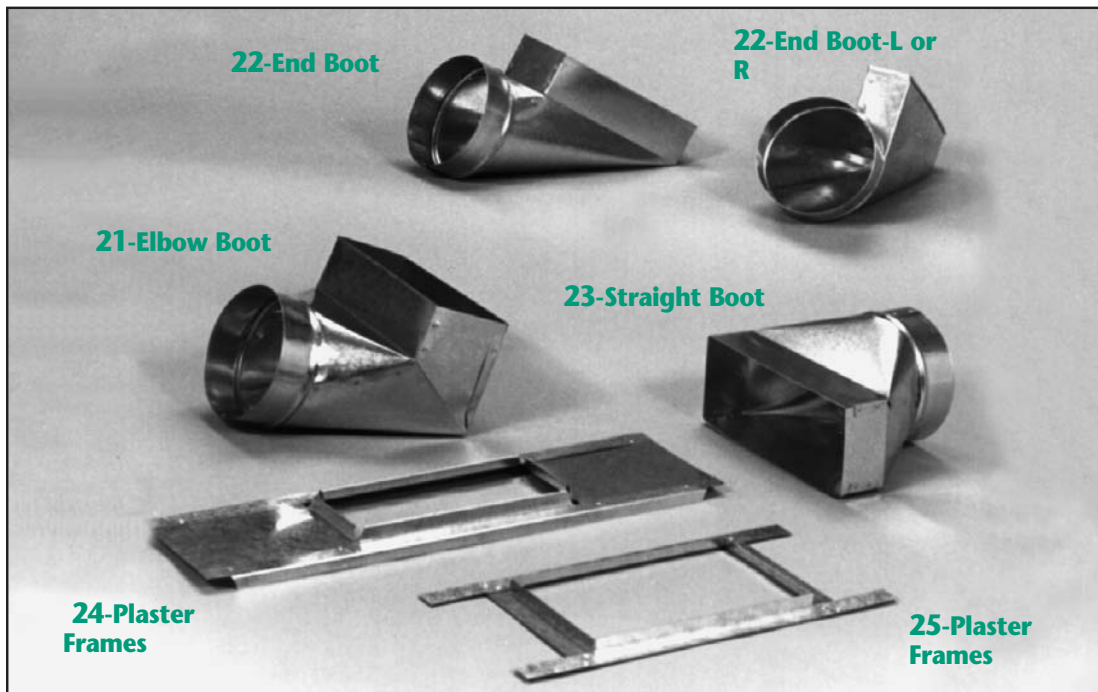

Size	No. 21 Ell Boot	No. 22 End Boot	No. 23 Str Boot	Size	No. 21 Ell Boot	No. 22 End Boot	No. 23 Str Boot
8x2¼x4	12	12	12	8x4x5	12	12	12
8x2¼x5	12	12	12	8x4x6	12	12	12
8x2¼x6	12	12	12	8x6x5	12	12	12
8x4x4	12	12	12	8x6x6	12	12	12
10x2¼x4	12	12	12	12x4x4	12	12	12
10x2¼x5	12	12	12	12x4x5	24	12	18
10x2¼x6	18	18	24	12x4x6	18	24	24
10x2¼x7	12	12	12	12x4x7	12	18	18
10x4x4	12	12	12	12x4x8	12	12	12
10x4x5	24	30	18	12x6x6	12	12	12
10x4x6	24	30	36	12x6x7	12	18	12
10x4x7	24	24	30	12x6x8	12	12	12
10x4x8	12	12	12	12x8x8	12	N/A	12
10x6x4	12	12	12	14x2¼x6	12	12	12
10x6x5	18	24	30	14x2¼x7	12	12	12
10x6x6	18	24	30	14x4x6	12	12	12
10x6x7	16	18	24	14x4x7	12	12	12
10x6x8	12	12	12	14x4x8	12	12	12
12x2¼x5	12	12	12	14x6x7	6	8	12
12x2¼x6	24	24	24	14x6x8	8	8	12
12x2¼x7	24	12	18				

No. 24 & No. 25 Plaster Frames	10x4	10x6	12x4	12x6
16"	12	12	12	12
24"	12	12	12	12



# Stack Boots

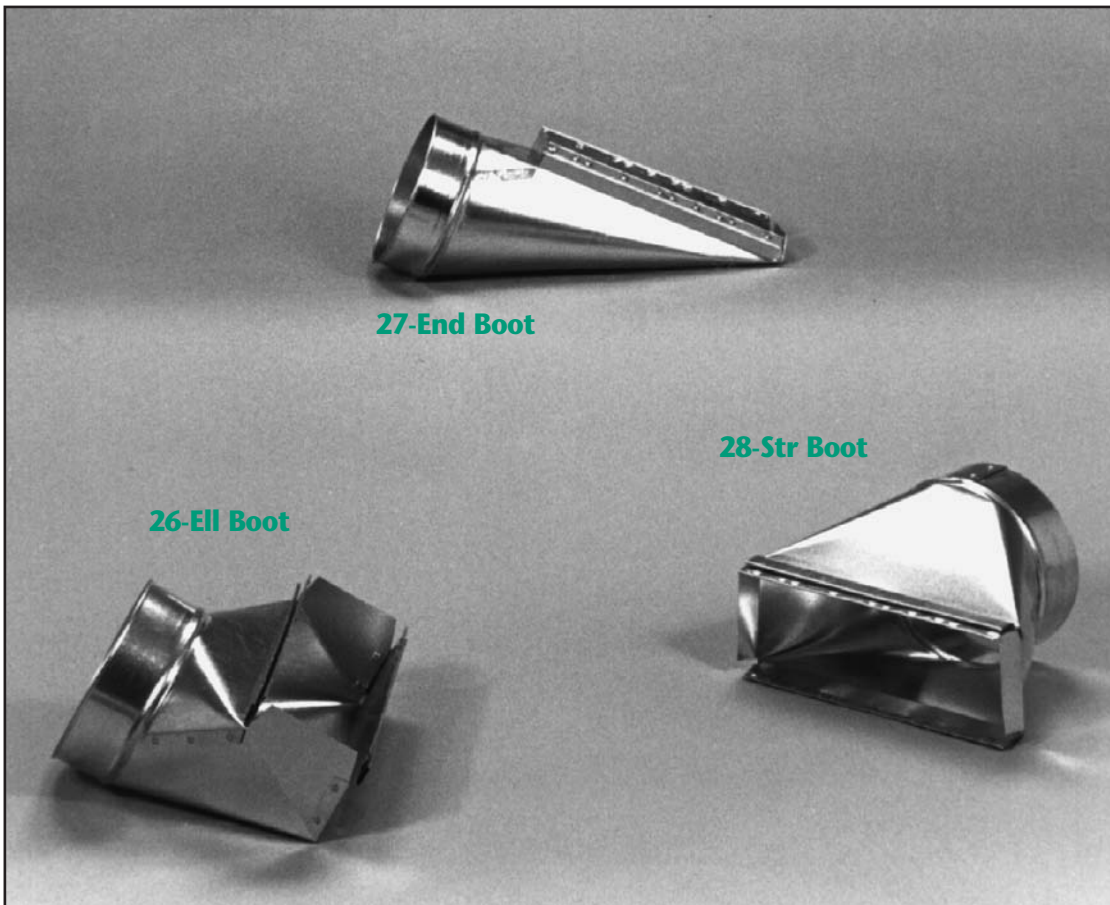

Size	No. 26 ElI Boot	No. 27 End Boot	No. 28 Str Boot
8x3¼x4	12	12	12
8x3¼x5	12	12	12
8x3¼x6	12	12	12
10x3¼x4	12	12	12
10x3¼x5	12	12	12
10x3¼x6	24	12	12
10x3¼x7	12	12	12
10x3¼x8	12	12	12
12x3¼x5	12	12	12
12x3¼x6	12	12	12
12x3¼x7	12	12	12
12x3¼x8	12	12	12
14x3¼x6	12	12	12
14x3¼x7	12	12	12
14x3¼x8	12	12	12

# Oval Pipe & Fittings



Item No. and Description	5"	6"	7"	8"
No. 43 Oval A Collar	12	12	12	12
No. 60 Oval Pipe 100" sec	6	6	6	6
No. 60A Oval Pipe 60" sec	6	6	6	6
No. 61 Vertical Oval Elbow	36	30	24	12
No. 62 Flat Oval Elbow	12	12	12	12
No. 70 Flat Oval Angle	12	12	12	12
No. 71 Vertical Oval Angle	36	30	24	12



# Oval Pipe & Fittings



Item No. and Description	4"	5"	6"	7"	8"	
No. 72 Oval to Round Straight Boot	N/A	12	18	12	12	
No. 73 Oval to Oval Reverse Boot	N/A	12	12	12	12	
No. 74 Oval to Round End Boot	N/A	12	12	12	12	
No. 76 Oval Head						
8x4	30	30	30	N/A	N/A	
8x6	30	30	30	N/A	N/A	
10x4	24	24	24	24	N/A	
10x6	24	24	24	24	N/A	
12x4	18	18	18	18	18	
12x6	18	18	18	18	18	
14x6	12	12	12	12	12	
Additional Sizes Available Upon Request: 12 - 12x8x6 12 - 12x8x7 12 - 12x8x8						
No. 76H Head Box With Collar						
10x6	30	30	30	30	N/A	
12x6	24	24	24	24	N/A	
Blank Available						
No. 77 Oval Head Thin						
8x6	24	24	24	24		
10x4	24	24	24	24		
10x6	24	24	24	24		
12x6	24	24	24	24		
No. 78 Oval Register Boot						
10x4	N/A	12	12	12		
12x2½	N/A	12	12	12		
12x4	N/A	12	12	12		
No. 79 Hi-Lo Oval STHD						
10x6	18	18	18	18		
12x6	14	14	14	14		
Item No. and Description	5" to 5"	6" to 5"	6" to 6"	7" to 6"	7" to 7"	8" to 8"
No. 75 Oval to Round Elbow Boot	24	30	18	24	24	12

# Rectangular Duct & Fittings

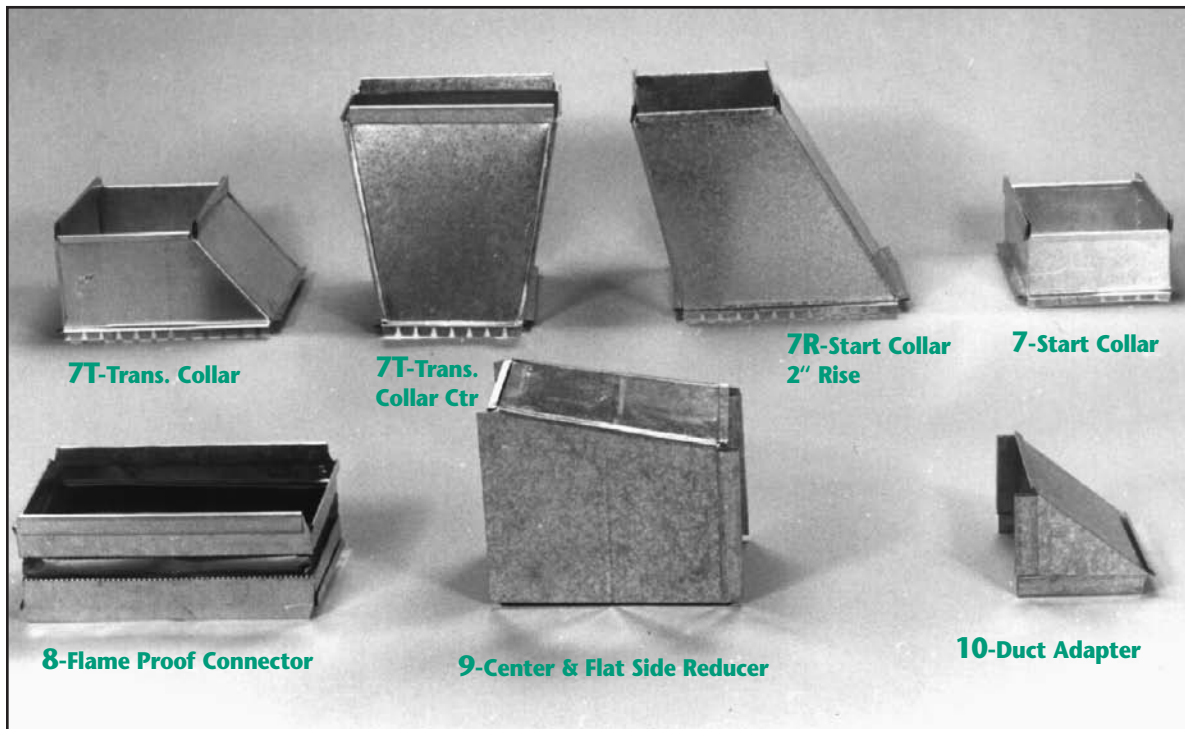
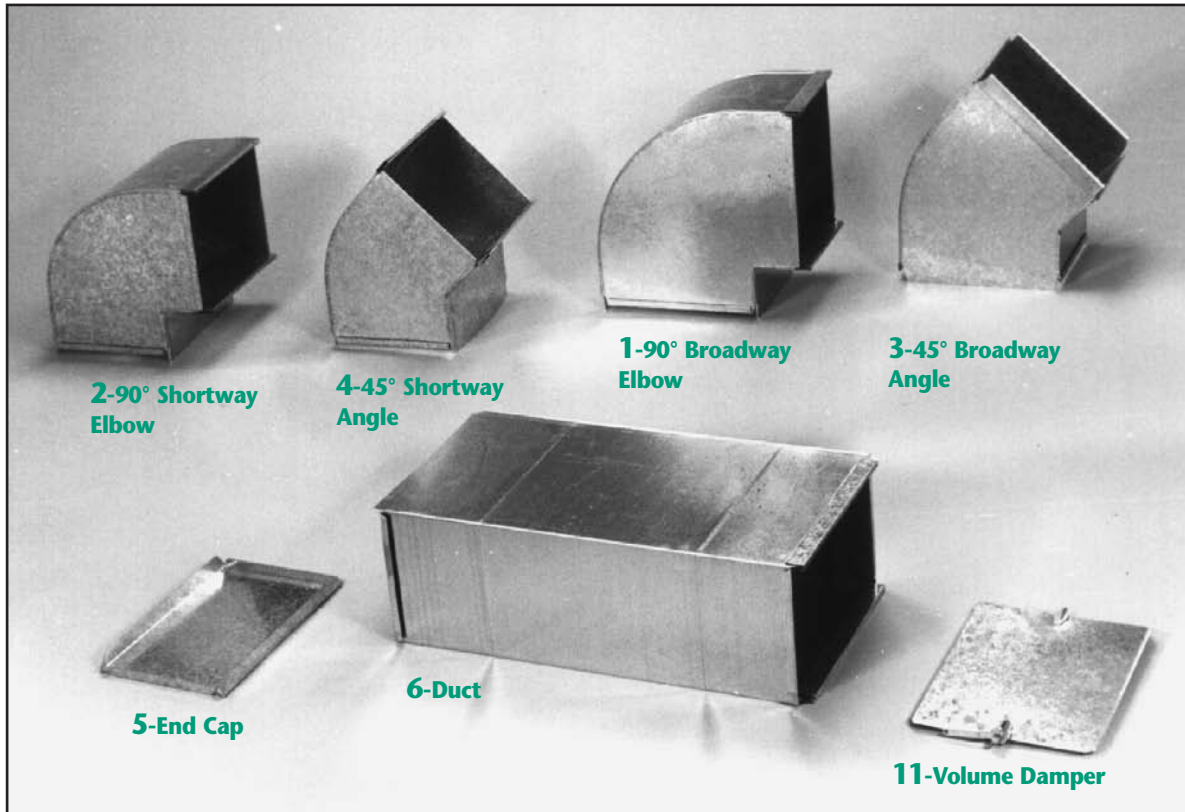



# Rectangular Duct & Fittings

Item No. and Description	8x8	10x8	12x8	14x8	16x8	18x8	20x8	22x8	24x8	26x8
			10x10	12x10	14x10	16x10	18x10	20x10	22x10	24x10
					12x12	14x12	16x12	18x12	20x12	22x12

- No. 1-90° Broadway Elbow
- No. 2-90° Shortway Elbow
- No. 3-45° Broadway Angles
- No. 4-45° Shortway Angles
- No. 5-End Cap
- No. 6-48 2 pc. Duct
- 60 2 pc. Duct
- 96 2 pc. Duct
- No. 7 Start Collar
- 6" long
- No. 7R Start Collar 2" Rise
- No. 7T Trans. Collar
- No. 8 Flame Proof Connector
- No. 9 Center & Flat Side Reducer
- No. 10 -Duct Adapter
- No. 11 Volume Damper
- No. 18 Plenum Specify length X width X height

## ORDER BY QUANTITY NEEDED

If you would like to convert your duct and fittings from 8" to 10" or 12", simply add the width and depth together and this will give you the total inches you need.  
*For example: 16x8 duct would convert to 14x10 or 12x12.*

All fittings and duct come with slips attached, drive ears turned, notched and pre-cut to length drives for faster installation.

Duct has button-lock seam for easier field assembly.

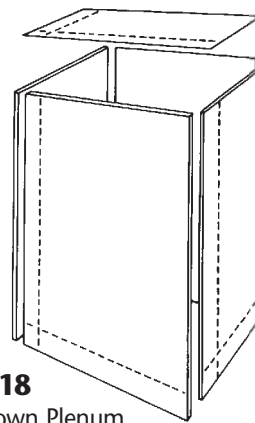

**18**  
Knock Down Plenum

Item No. and Description	12"x20"	16"x20"	20"x20"	25"x20"
No. 12 Return Air Boot w/o Filter Rack				
No. 12 Return Air Boot w/ Filter Rack				

### BY ORDER



**12**  
Throat Dim 5"

# Metal Take Offs

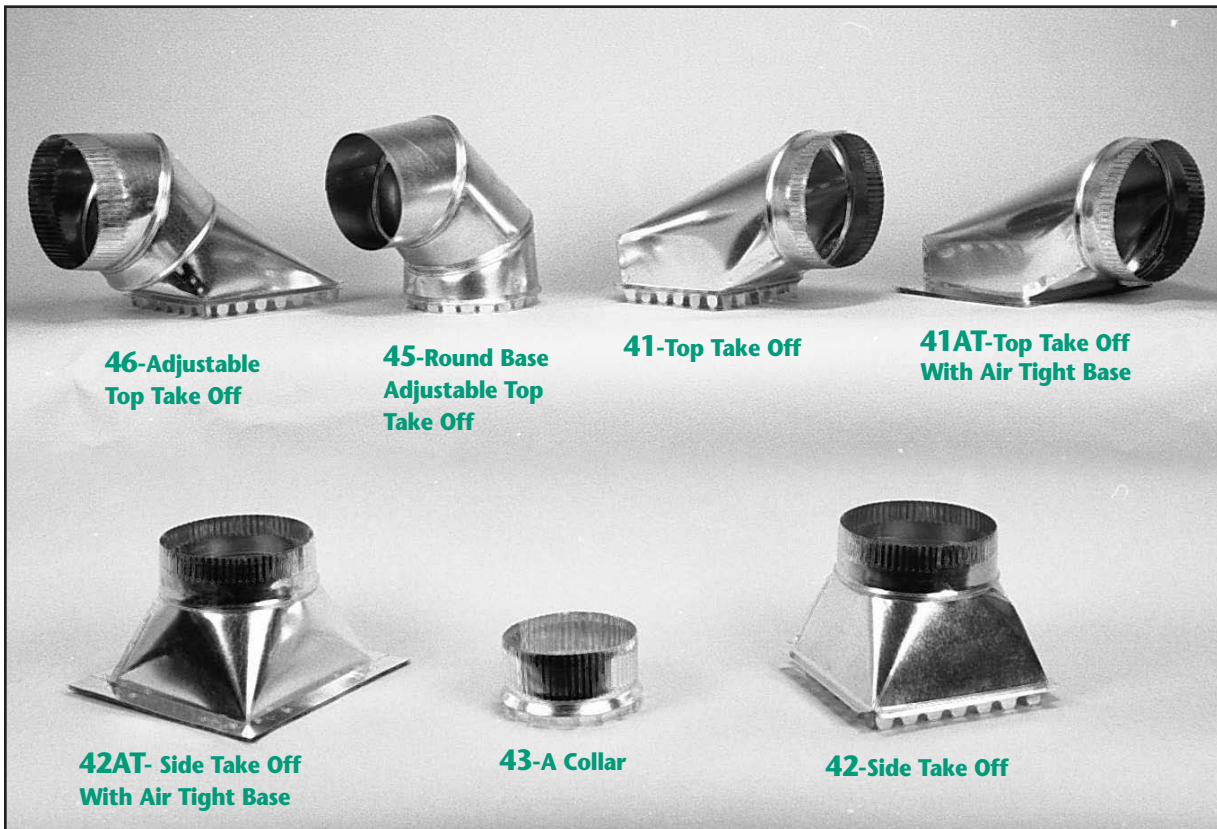

Item No. and Description	3"	4"	5"	6"	7"	8"	9"	10"	12"	14"	16"
No. 41 Top Takeoff		12	24	24	24	12	6	6	6	4	2
No. 41 With Adjustable Top Base		2" Large		6" Large With Damper							
No. 42 Side Takeoff		12	24	30	24	30	12	10	8	8	6
No. 42 With Adjustable Top Base		2" Large		6" Large With Damper							
No. 43 A Collar	12	12	48	36	48	48	12	12	12	12	12
No. 45 Round Base Adjustable Top Take Off		12	12	12	12	12	N/A	N/A	N/A	N/A	N/A
No. 46 Adjustable Top Take Off		N/A	36	24	18	12	12	6	4	N/A	N/A



# Duct Board Take Offs

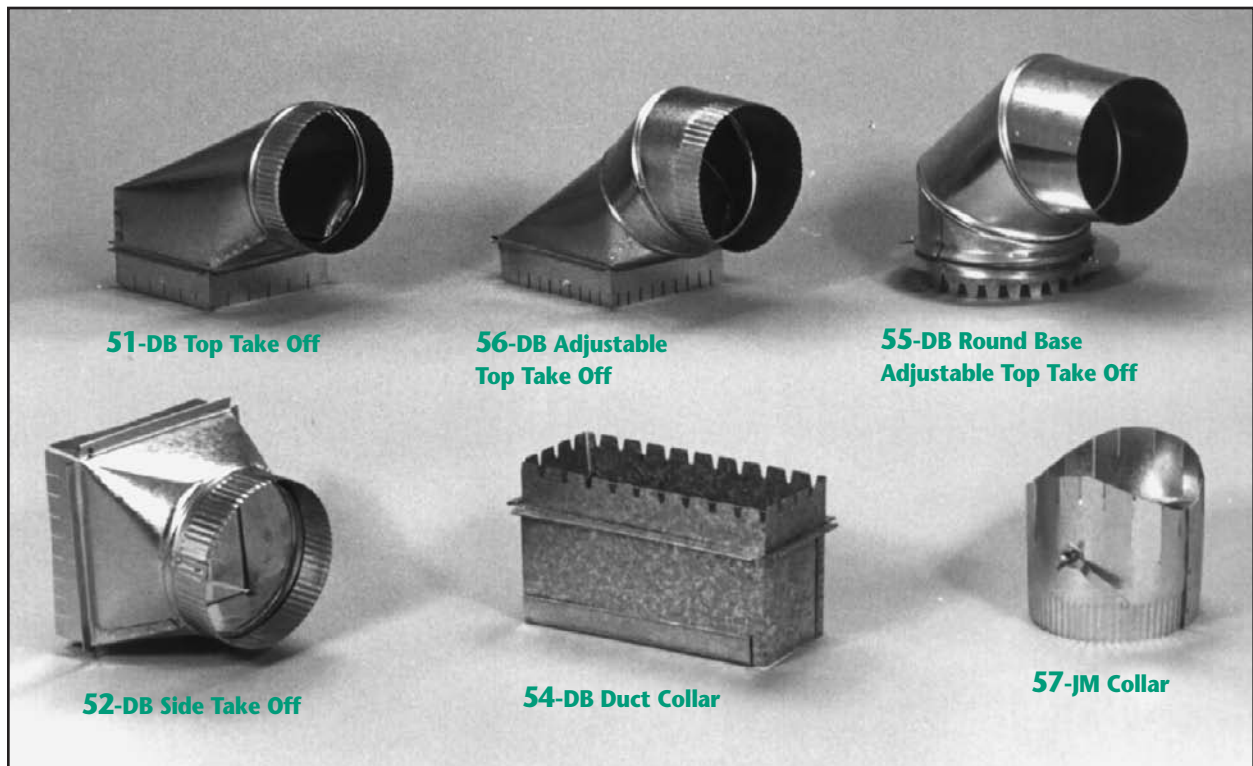

Item No.	4"	5"	6"	7"	8"	9"	10"	12"	14"
51-DBTTO	12	18	30	18	12	12	6	6	6
52-DBSTO	12	18	30	24	12	12	6	6	6
54-DB Duct Collar	12	12	12	12	12				
55-DB Round Base Adjustable Top Take Off	12	12	12	12	12	N/A	N/A	N/A	N/A
56-DB Adjustable Top Take Off	N/A	12	12	12	12	N/A	N/A	N/A	N/A
57-JM Collar	12	40	30	24	40				

# Outlet Boxes

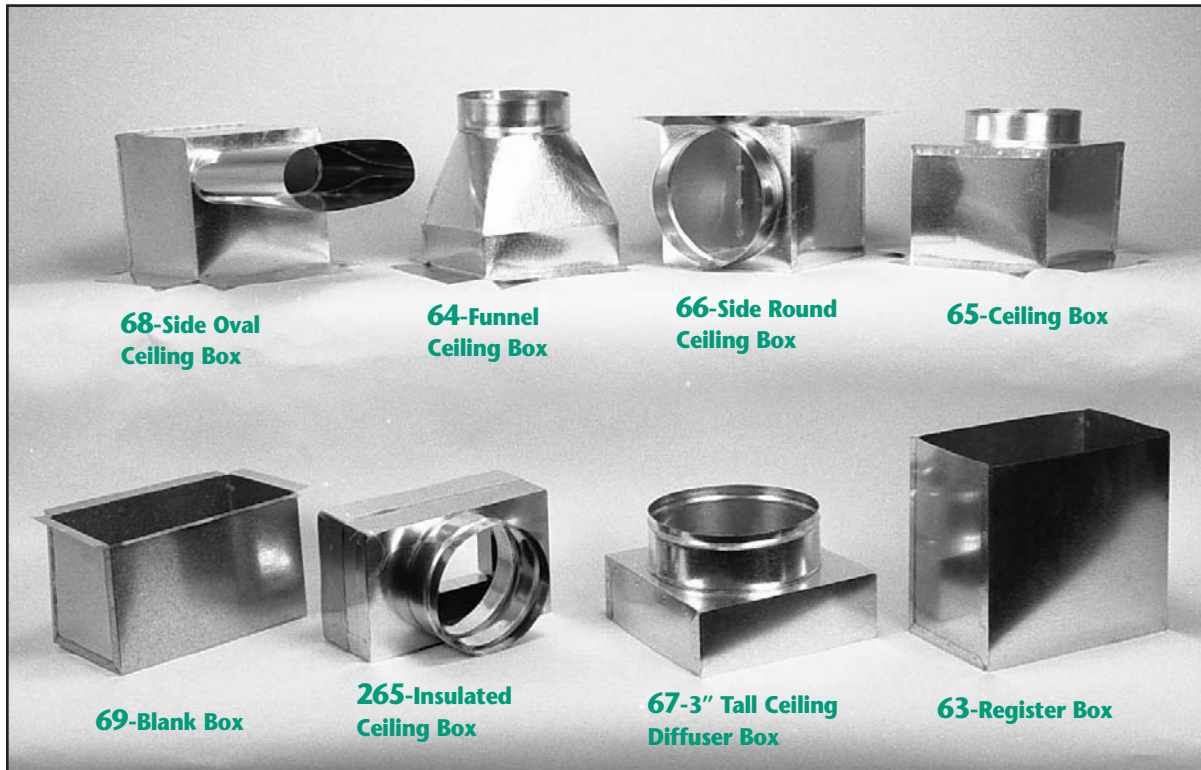

**68-Side Oval Ceiling Box**

**64-Funnel Ceiling Box**

**66-Side Round Ceiling Box**

**65-Ceiling Box**

**69-Blank Box**

**265-Insulated Ceiling Box**

**67-3" Tall Ceiling Diffuser Box**

**63-Register Box**

No. 64, 65 and 66 Ceiling Boxes									
Width	4"	5"	6"	7"	8"	9"	10"	12"	14"
6x6	24	24	24	N/A	N/A	N/A	N/A	N/A	N/A
8x8	12	12	12	12	12	N/A	N/A	N/A	N/A
10x10	12	12	12	12	12	12	12	N/A	N/A
12x12	6	6	6	6	6	6	6	6	N/A
14x14	6	6	6	6	6	6	6	6	6

Item No. and Description	8x4	8x6	10x4	10x6	12x4	12x6
No. 63 Register Box 9" Deep	12	12	12	12	12	12
No. 69 Blank Box 12" Deep	12	12	12	12	12	12

Item No. and Description	8x8x6	10x10x7	12x12x8
No. 68 Side Oval Ceiling Box	6	6	4
No. 265 Insulated Ceiling Box	Custom Fabricated To Your Specific Dimensions		
No. 67 3" Tall Ceiling Diffuser Box	Custom Fabricated To Your Specific Dimensions		



# Wall Stack & Fittings

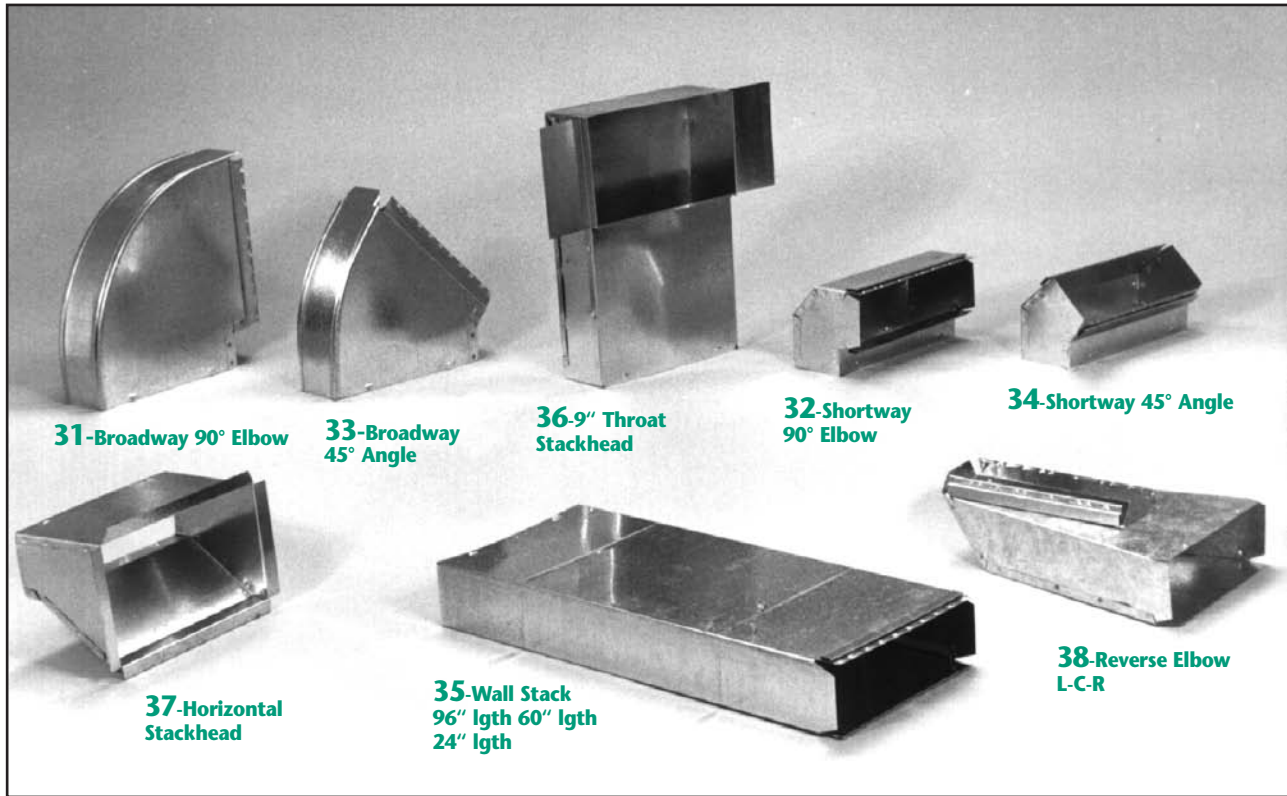

Item No. and Description	8x3¼	10x3¼	12x3¼	14x3¼
	8x2¼	10x2¼	12x2¼	14x2¼
No. 31 Broadway 90° Elbow	————— <b>BY ORDER</b> —————			
No. 32 Shortway 90° Elbow	12	12	12	12
No. 33 Broadway 45° Angle	————— <b>BY ORDER</b> —————			
No. 34 Shortway 45° Angle	12	12	12	12
No. 35 Wall Stack 24" length	5	5	5	5
No. 35 Wall Stack 60" length	5	5	5	5
No. 35 Wall Stack 96" length	5	5	5	5
No. 38 Reverse Elbow LRC	1	1	1	1

Item No. and Description	8x6x3¼	10x6x3¼	12x6x3¼	14x6x3¼
	8x6x2¼	10x6x2¼	12x6x2¼	14x6x2¼
No. 36 9" Throat Stackhead	12	12	12	12
No. 37 Horizontal Stackhead	12	12	12	12

# Tees

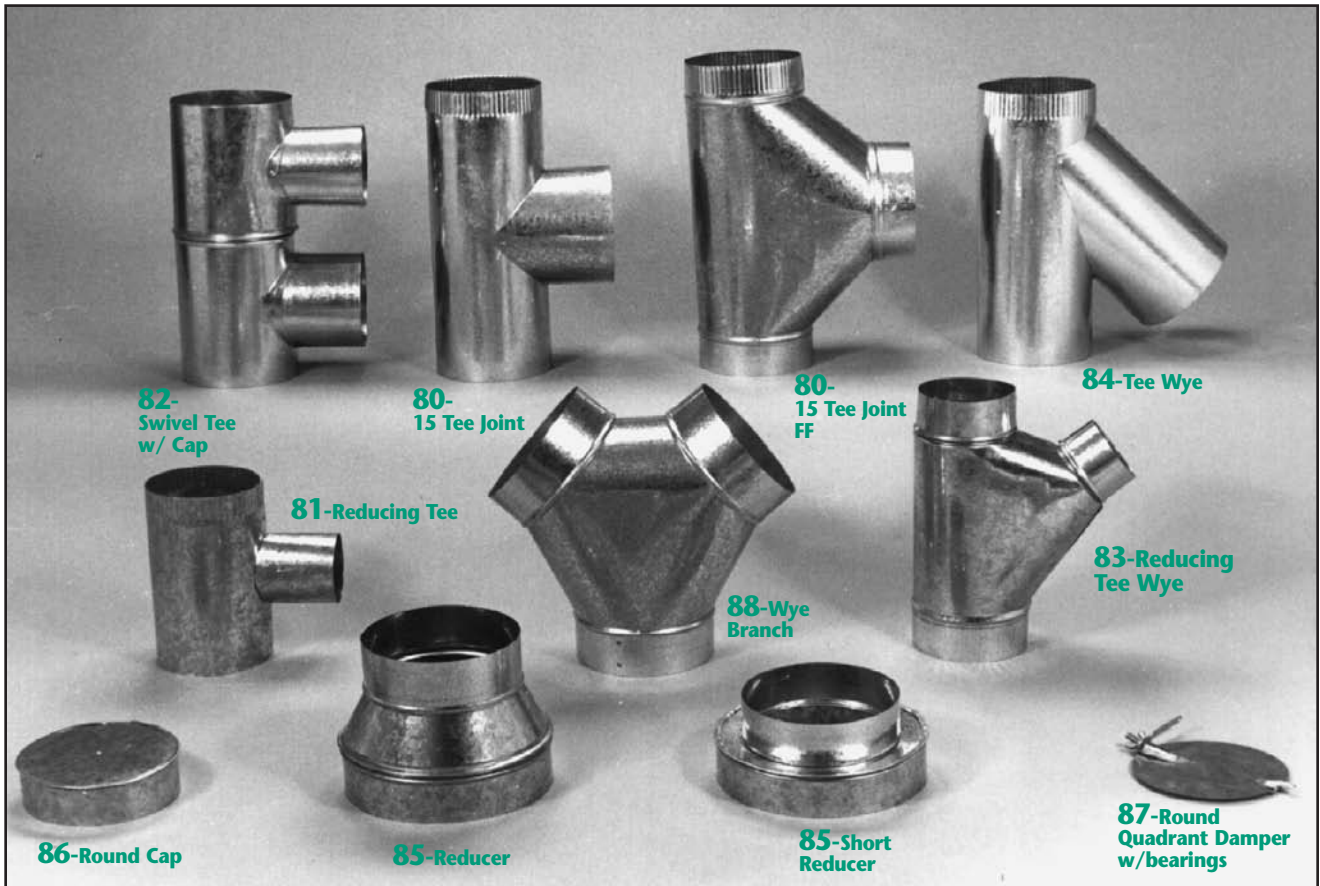

Item No. and Description	3"	4"	5"	6"	7"	8"	9"	10"	12"	14"	16"	18"	20"	22"	24"
No. 80 Tees	12	12	12	12	12	6	6	6	2	2	BY ORDER				
No. 86 Round Cap	12	12	12	12	12	12	12	12	BY ORDER						
No. 87 Round Damper	12	12	12	12	12	12	12	12	BY ORDER						

Item No. and Description	4"	5"	6"	7"	8"	9"	10"	12"	14"	16"	18"	20"	22"	24"	
No. 81 Reducing Tee	BY ORDER								BY ORDER						
No. 82 Swivel Tee	BY ORDER								BY ORDER						
No. 83 Reducing Tee Wye	BY ORDER								BY ORDER						
No. 84 Tee Wye	BY ORDER								BY ORDER						
No. 85 Reducer	12	12	12	12	12	12	12	6	6	BY ORDER					

Item No. and Description	7x5x5	8x6x6	10x8x8
No. 88 Wye Branch	12	12	12

Specify all opening dimensions on all products listed above when ordering.

# Exhaust Vents

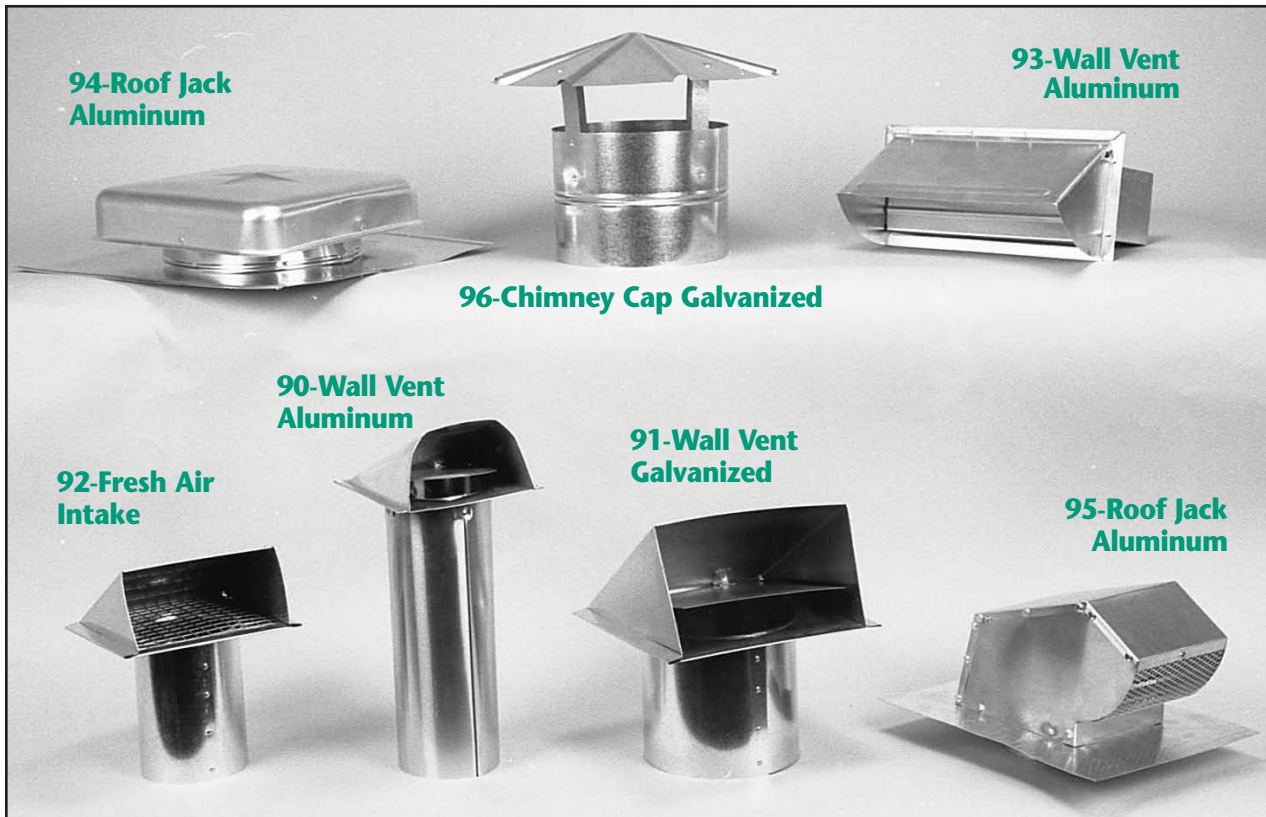

Item No. and Description	Size	Box Quantity
No. 90 Wall Vent Aluminum	3"	12
No. 90 Wall Vent Aluminum	4"	12
No. 91 Wall Vent Galvanized	6" - 7" - 8" - 10"	12 - 12 12 - 6
No. 92 Fresh Air Intake	3" - 10"	<b>— BY ORDER —</b>
No. 93 Wall Vent Aluminum	10"x3¼"	6
No. 94 Roof Jack Aluminum	7"	6
No. 95 Roof Jack Aluminum	4"	1
No. 96 Chimney Cap Galvanized	3"-24" available	<b>— BY ORDER —</b>

# Collars & Spin Fittings

## Spin Fittings for Metal

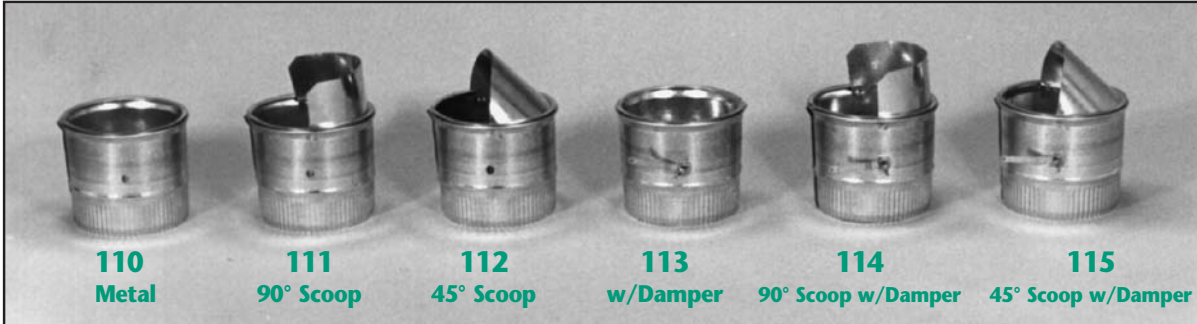

## Duct Board Spin Fittings

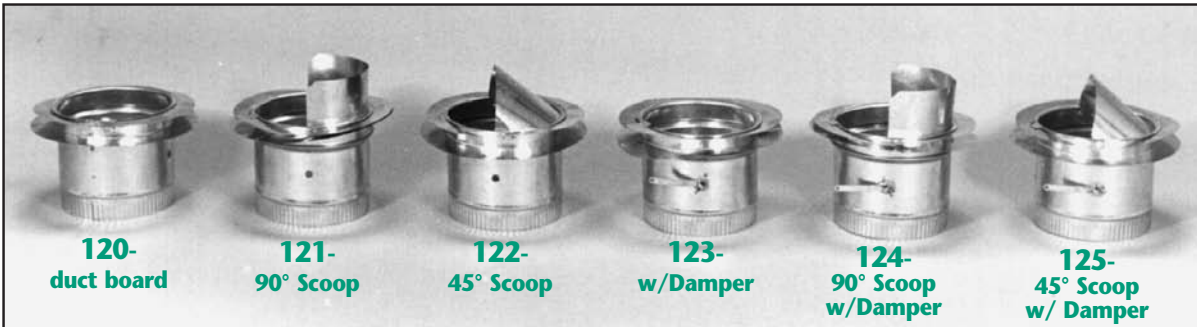

## Air Tite Take Off

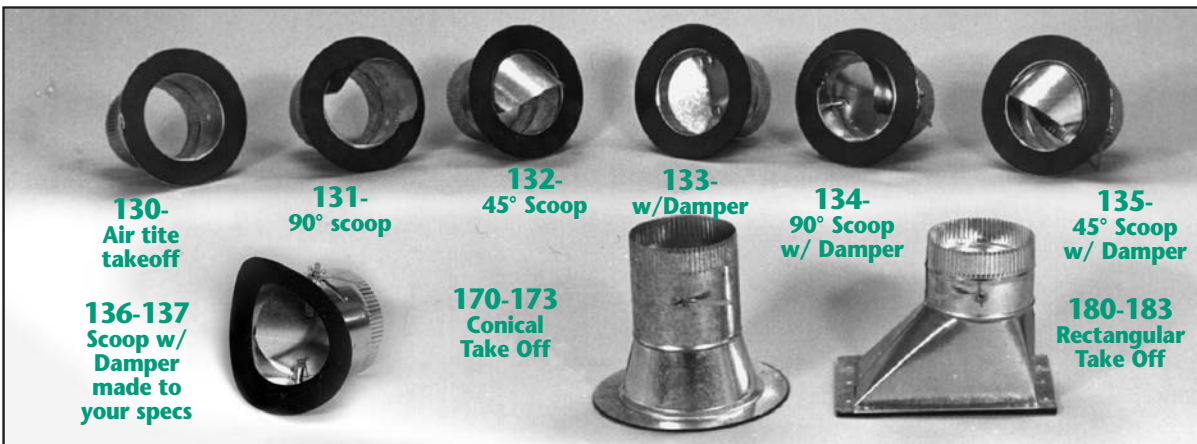

## Tap Collars

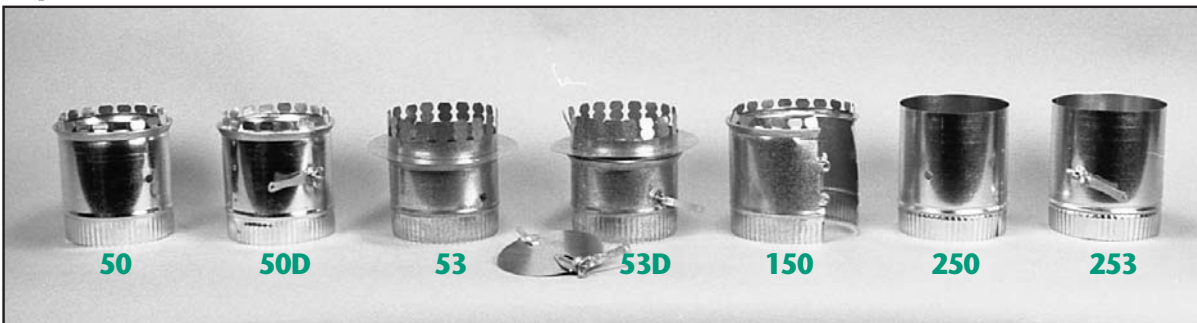



# Collars & Spin Fittings

**Item No.**                      **4" 5" 6" 7" 8" 9" 10" 12" 14" 16" 18" 20" 22" 24"**

## Spin Fittings for Metal

No. 110 Metal	12	24	24	24	40	30	30	15	10	<b>BY ORDER</b>	_____
No. 111 90° Scoop	12	24	24	16	32	24	24	12	8		_____
No. 112 45° Scoop	12	24	24	16	32	24	24	12	8		_____
No. 113 w/Damper	12	24	24	24	40	30	30	15	10		_____
No. 114 90° Scoop w/Damper	12	24	24	16	32	24	24	12	8		_____
No. 115 45° Scoop w/Damper	12	24	24	16	32	24	24	12	8		_____

## Duct Board Spin Fittings

No. 120 Duct Board	12	24	24	16	30	15	15	10	10	<b>BY ORDER</b>	_____
No. 121 90° Scoop	12	24	16	16	24	12	12	8	8		_____
No. 122 45° Scoop	12	24	16	16	24	12	12	8	8		_____
No. 123 w/ Damper	12	24	24	16	30	15	15	10	10		_____
No. 124 90° Scoop w/Damper	12	24	16	16	24	12	12	8	8		_____
No. 125 45° Scoop w/Damper	12	24	16	16	24	12	12	8	8		_____

## Air Tite Take Off

No. 130 Air Tite Take Off	12	30	24	16	24	15	15	10	6	6	6	<b>BY ORDER</b>	_____
No. 130 3" Tall	50	50	50	50	25	18	18	12					_____
No. 131 90° Scoop	12	24	16	16	18	12	12	8	6				_____
No. 132 45° Scoop	12	24	16	12	18	12	12	8	4				_____
No. 133 w/Damper	12	30	24	16	24	15	15	10	6	6	6		_____
No. 134 90° Scoop w/Damper	12	24	16	16	18	12	12	8	6				_____
No. 135 45° Scoop w/Damper	12	24	16	12	18	12	12	8	4				_____
No. 136-137 Scoop w/Damper	12 per box												_____

## Tap Collars

No. 50 for Metal	60	40	30	24	30	24	24	15	12	6	6	<b>BY ORDER</b>	_____
No. 50D for Metal	60	40	30	24	30	24	24	15	12	6	6		_____
No. 53 for Duct Board	48	30	24	16	24	15	15	10	6	6	6		_____
No. 53D for Duct Board	48	30	24	16	24	15	15	10	6	6	6		_____
No. 170 AT Conical Take Off	N/A	12	12	N/A	12	N/A	12	12	N/A				_____
No. 173 AT Conical Take Off	N/A	12	12	N/A	12	N/A	12	12	N/A				_____
Damper Section 250/253	12	40	30	24	30	24	24	15	12			_____	

## Snap Tap Collars

No. 150 for Metal	N/A	60	60	36	36	24	24	12	12	12	12	<b>BY ORDER</b>	_____
No. 153 for Metal	N/A	60	60	36	36	24	24	12	12				_____
No. 160 for Duct Board	N/A	60	60	36	36	24	24	12	12				_____
No. 163 for Duct Board	N/A	60	60	36	36	24	24	12	12				_____

Item No.	Size	Rect. Opening	Box Quantity
No. 183 Rectangular	5"	10x5	12
No. 180 Take Off	6"	10x6	12
	7"	12x6	12
	8"	12x6	12
	10"	14x8	8
	12"	16x10	4
	14"	18x12	4
	16"	20x14	3

# Connectors & Accessories

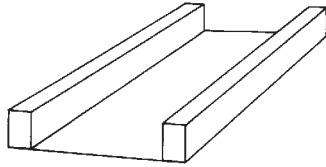

**100**  
Panning

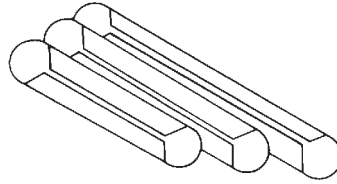

**102**  
Drive

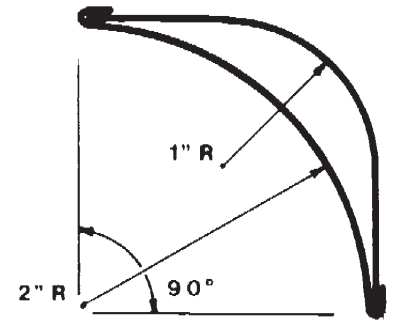

**108**  
2" Double Wall Vane

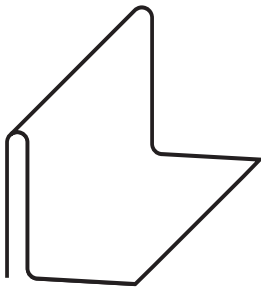

**200**  
Cold Air Strip

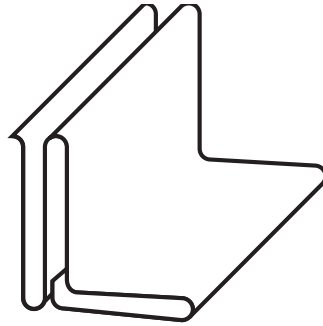

**103**  
Standing S Cleat

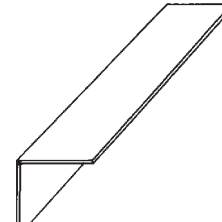

**104**  
90° Angle

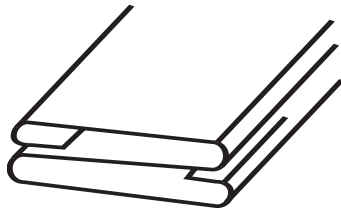

**101**  
S Cleat

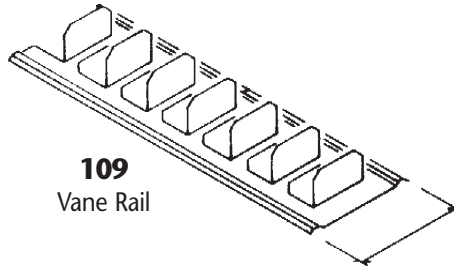

**109**  
Vane Rail

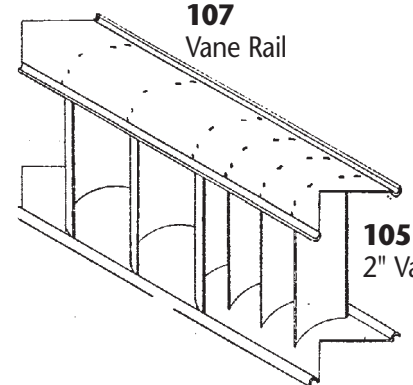

**107**  
Vane Rail

**105**  
2" Vane

Available	10 ft	Custom lgth	28 gauge	26 gauge	24 gauge
101	*	*	*	*	
102	*	*	*	*	
103	*	*		*	*
104	*	*		*	*
105 2" Vane		*		*	*
106 4" Vane		*		*	*
107 Vane Rail	*	*		*	*
108 2" Double Wall Vane	*	*		*	*
109 Vane Rail	*	*		*	*

Available					
100 Panning	17"x36"	17"x30"			
Cold Air Strip	60"	96"	120"		

All quantities of 10

# New Products

## Class "O" Aluminum Flex Duct

Item No. and Description	3"	4"	5"	6"	7"	8"	9"	10"	12"	14"	16"
Class "O" Aluminum Flex	24	15	10	15	10	7	6	5	3	2	1
Available Diameter sizes 3"-16" 96" section Lengths											

## Return Airbox

Recessed E/C  
 Sized to your specifications  
 Air return opening sizes: 24"x12"  
 24"x10"  
 24"x8"

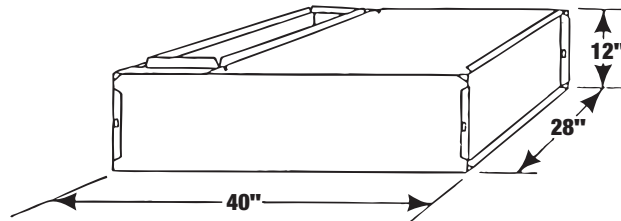

## El Boot #21

With 6" Extension  
 Custom Fabricated To  
 Your Specific Dimensions  
 (See Register Opening Options Below)  
 Available in 26GA or 30GA

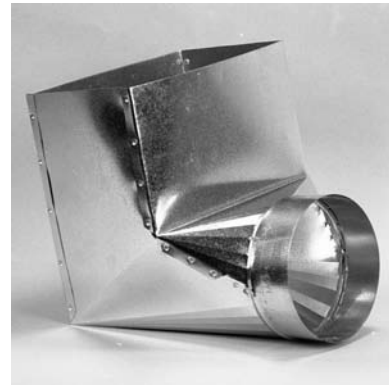

## El Boot #21

With Radiation or Fire Damper Installed  
 Custom Fabricated To  
 Your Specific Dimensions  
 (See Register Opening Options Below)  
 Available in 26GA or 30GA

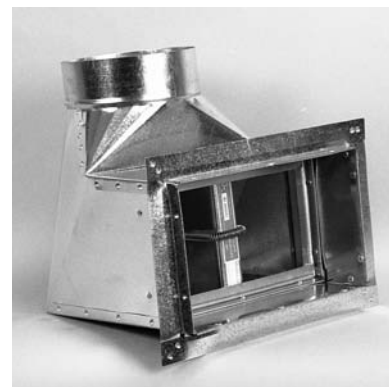

### Register Opening Options:

- 1) RAW (Shown Top)
- 2) 1" Flange (Not Shown)
- 3) Drywall Setback Flange 1/2"x1" (Shown Bottom)

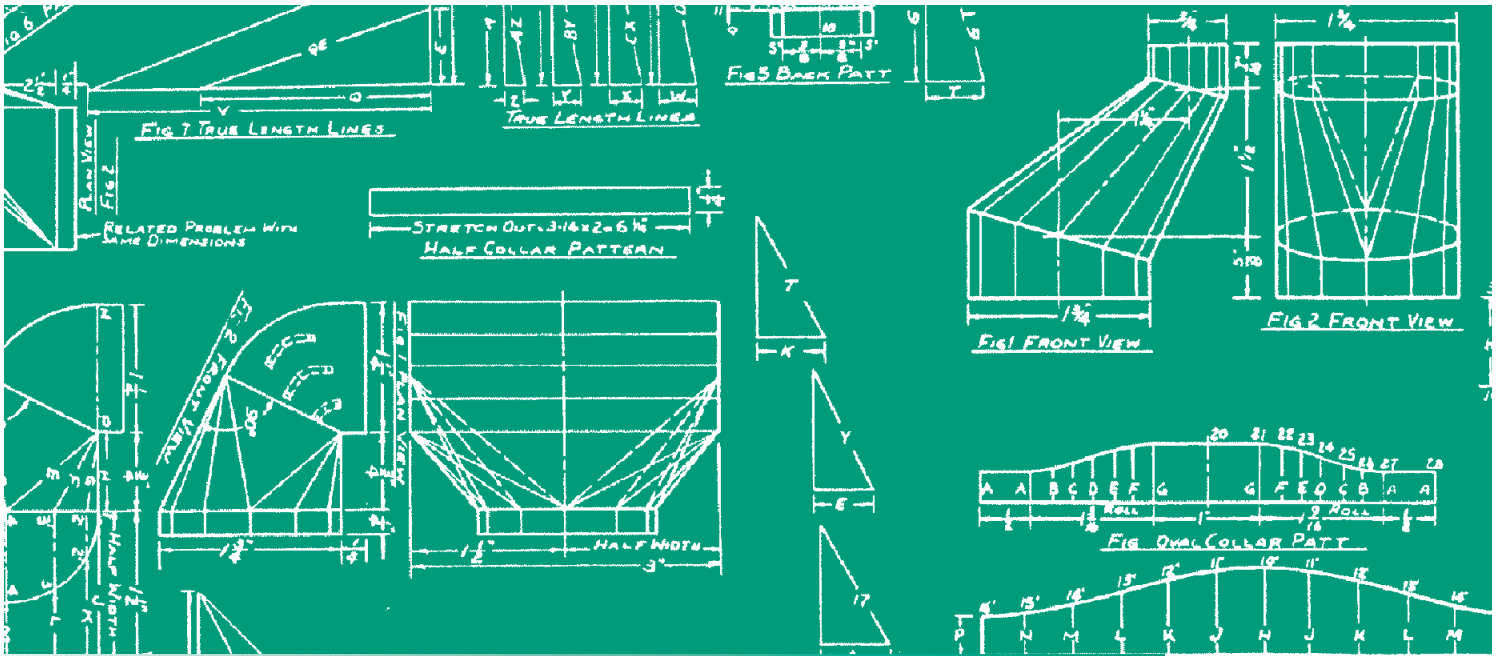

**General Offices & Plant:**

Chantilly Plant  
 Unit C102, 3931 Avion Park Court  
 Chantilly, VA 20151  
 Metro (703) 631-9600  
 Fax # (703) 263-9005 Accounting  
 Fax # (703) 631-3731 Sales

**Manufacturing Plant:**

Winchester Plant  
 260 Lenoir Drive  
 Winchester, VA 22603-1951  
 Out of State 1-800-433-6275  
 In Virginia 1-800-523-6186  
 Local (540) 667-0084  
 Fax # (540) 667-0059  
[www.zmsheetmetal.com](http://www.zmsheetmetal.com)

