

# Product Catalogue for **BLÜCHER® EuroPipe**

Drainage Pipework System

**BLÜCHER® EuroPipe**

**BLÜCHER® Channel**

**BLÜCHER® Drain**

01.2019 25084



**BLÜCHER®**

A **WATTS** Brand

[mca@blucher.com](mailto:mca@blucher.com) • [blucher.com](http://blucher.com)

© 2019 blucher.com

**BLÜCHER®**

A **WATTS** Brand



## Safe solutions

BLÜCHER® stainless steel drainage products are installed in almost any kind of construction project, from multi-storey apartments and food processing factories to hospitals and on board prestigious cruise liners. We have specialised our competencies within four main segments:

Housing

Commercial

Industrial

Marine

The BLÜCHER® drainage system is a modular system providing numerous possible product combinations.

### BLÜCHER® Drain

Floor drains for light- to heavy-duty flow and load applications.

### BLÜCHER® Channel

Standard, modular or customised channels and kitchen channels for all flow and load applications.

### BLÜCHER® EuroPipe

Push-fit drainage pipe-work system for soil, waste and rainwater.

### Customised solutions

To ensure that any drainage requirement can be fulfilled we are always ready to solve your special request.

## Strong products

All BLÜCHER® drainage products are produced in stainless steel grade AISI 304 or optionally grade AISI 316L. This material is ideally suitable for high-quality drainage systems:

- Fire resistant
- High strength - low weight
- Environmentally friendly

Furthermore it is corrosion resistant, resistant to impacts and thermal stress and requires little maintenance.

In the BLÜCHER® drainage products the inherent qualities of stainless steel are enhanced by careful product design resulting in:

- Long product life expectancy
- Excellent hygienic properties
- Easy installation
- Whole-life cost advantages
- Excellent flow capacities

All BLÜCHER® products are chemically descaled and passivated in order to enhance the natural corrosion resistance and provide a uniform matt-silver surface finish.

All stainless steel components are manufactured from recycled materials and are 100% recyclable.

## Danish quality

Founded in Denmark in 1965, BLÜCHER has developed into a leading manufacturer of stainless steel drainage systems. Today, BLÜCHER is an international company with subsidiaries and representations worldwide. The BLÜCHER Group employs more than 350 staff worldwide.

Customers all over the World appreciate our know-how, dedicated service and common sense.

Through quality stainless steel products and drainage solutions that lead waste water away, BLÜCHER is committed to the promise of keeping up the flow.

The BLÜCHER® drainage products are manufactured in Denmark using the most modern production methods and in accordance with the internationally recognised quality standard ISO 9001. Furthermore, the most respected classification societies endorse the BLÜCHER® drainage products worldwide.



## **Selected references around the World**

Hospitals, schools, commercial kitchens, the food and beverage industry and the pharmaceutical industry are among the customers that benefit from BLÜCHER stainless steel drainage systems.

### **Housing**

BLÜCHER® stainless steel floor drains and pipe system are used all over the World in Scandinavian-style wet bathrooms in single and multi-storey buildings.

### **Commercial**

Queen Mary Hospital, Hvidovre hospital, Princess Alexandra Hospital, Blackpool Victoria Hospital, Queen Elizabeth Hospital, St. James Hospital, University College London Hospital, Sportcentrum Fitness First, Czàsar Swimming Pool, Sports & Aquatic Centre, International Grammar School, Collège Bellevue, Elite University, Universitat Pompeu Fabra, Augustenborgskolan, Canadian International School, North Texas State University, Elderly Citizens Home Adelaide, Old Peoples Home Budapest, Maryland State Prison, Uppsala Polishus, Oslo Opera, Hilton Hotels, Hotel Marriot, Sofitel, Novotel, The Ritz Carlton Bahrain, McDonalds, Burger King, Pizza Hut, Le Louvre, Bahrain National Museum, Ministère de L'Industri, State Library of Victoria, Royal Danish Theatre, Copenhagen Zoo, Hong Kong Disneyland, Dubai Mall, IKEA, Tesco, Coop, Metro, Carrefour, Lidl, Woolworths, Gardamoen Oslo, Copenhagen Airport, Heathrow Airport, Barcelona Airport, New Athens Airport, Orly Airport, Arlanda Airport, Helsinki Airport.

### **Industrial**

Pfizer, GSK, Astra Zeneca, Johnson & Johnson, Aventis, Kraft, Nestlé, Danish Crown, Daloon, Tulip, Knorr, Singapore Airport Catering, Ahlgreens, Estrella, Kelloggs, CocaCola, Pepsi, Heineken, Carlsberg, Whitbread Breweries, Budweiser, Tropicana Juice Processing, Absolut Vodka. Nestlé, Arla Food, Danone, Unilever, Almarai Dairy. Mercedes, Renault, L'Oreal, Sony, BASF, 3M, IBM World Headquarters, Honeywell, Colgate Palmolive, Royal Copenhagen, Hella.

### **Marine**

Freedom of the Seas, Liberty of the Seas, Norwegian Star, Color Magic, Pride of Hawaii, Galaxy, AIDA Diva, Celebrity Solstice. MY Platinum (Dubai Ports Authority), M/S Caravelle (Jade Yachts), Safari (Blohm & Voss) Lady Haya (Pesaro), Pelorus (Lürssen Kröger Werft), Oceanco Kusch Yachts Agentur.

3 vehicle carriers and 10 container ships (MHI Japan), 6 container vessels (AP Møller), 35 commercial vessels (Mawai China), 24 container vessels (Dalian Shipyards China).

Agbami Off Shore, Consafe-Aberdeen Oil Platform Bingo I & Bingo II Offshore Oil Rigs. Auxillary vessel (British Navy), 5 frigates (Norwegian Navy), 2 logistics vessels (Danish Navy), 2 survey vessels Dutch Navy.



## The BLÜCHER® range comprises:

### BLÜCHER® Drain Domestic



Shower drains for concrete/tiled and vinyl floors

- SQUARE, TRIO and CIRCLE
- Removable and easy-to-clean water trap
- Range of design gratings

WaterLine shower channels for concrete/tiled and vinyl floors

- For installation against wall(s) or away from walls
- Range of design gratings

### BLÜCHER® Drain Industrial



Industrial drains for concrete/tiled, resin or vinyl floors

- SQUARE and CIRCLE
- Removable and easy-to-clean water trap
- Large range of gratings for all applications and load classes

### BLÜCHER® EuroPipe



Push-fit drainage pipes and fittings, Ø50-Ø315 mm

- Low weight, high strength
- For vacuum and gravity systems
- RS82 renovation system (see separate catalogue)

## BLÜCHER® Channel



Channels and kitchen channels for concrete/tiled, resin and vinyl floors

- Removable and easy-to-clean water trap
- Large range of gratings for all applications and load classes

## BLÜCHER® HygienicPro



Point and linear drains for applications with strict requirements to hygiene and high capacity, e.g. production areas in the food and beverage industry

- Quickly leads away solid waste, even at small water volumes
- No corners and cavities inside thus preventing bacterial growth
- Less production stops for emptying and cleaning filter baskets

## BLÜCHER® Drain Roof



Roof drainage system for single-ply membrane or bitumen in gravity and vacuum systems

- Roof drains and BLÜCHER® EuroPipe pipework system
- Easy installation
- Long product life expectancy

**BLÜCHER® product catalogues can be ordered from our customer center or downloaded from [www.blucher.com](http://www.blucher.com)**



# HACCP certified

BLÜCHER is the first drainage system manufacturer to hold a HACCP certification confirming that the BLÜCHER® products support the integrity and safety of foods as demanded by industry expectations, legislation and standards.



**WaterMark**

AS 3495 (Stainless Non-Pressure)

Authorization requirements for plumbing products  
- Stainless steel nonpressure pipes and fittings



BLÜCHER is owned by the American group Watts Water Technologies, Inc. (NYSE: WTS) which is a world leader in the manufacture of innovative products to control the efficiency, safety and quality of water.



## **BLÜCHER® EUROPIPE**

Presentation of BLÜCHER® EuroPipe - pipes and fittings. . . . .	1
Pipes. . . . .	4
Fittings - Bends. . . . .	6
Fittings - Branches. . . . .	7
Fittings - Access pipes and bends. . . . .	9
Fittings - Toilet adaptors. . . . .	9
Fittings - Sockets. . . . .	10
Fittings - Increases and reducers. . . . .	10
Fittings - Adaptors. . . . .	11
Accessories. . . . .	13
Pipe cutters and other tools. . . . .	15





# Pipes and fittings for commercial and industrial applications

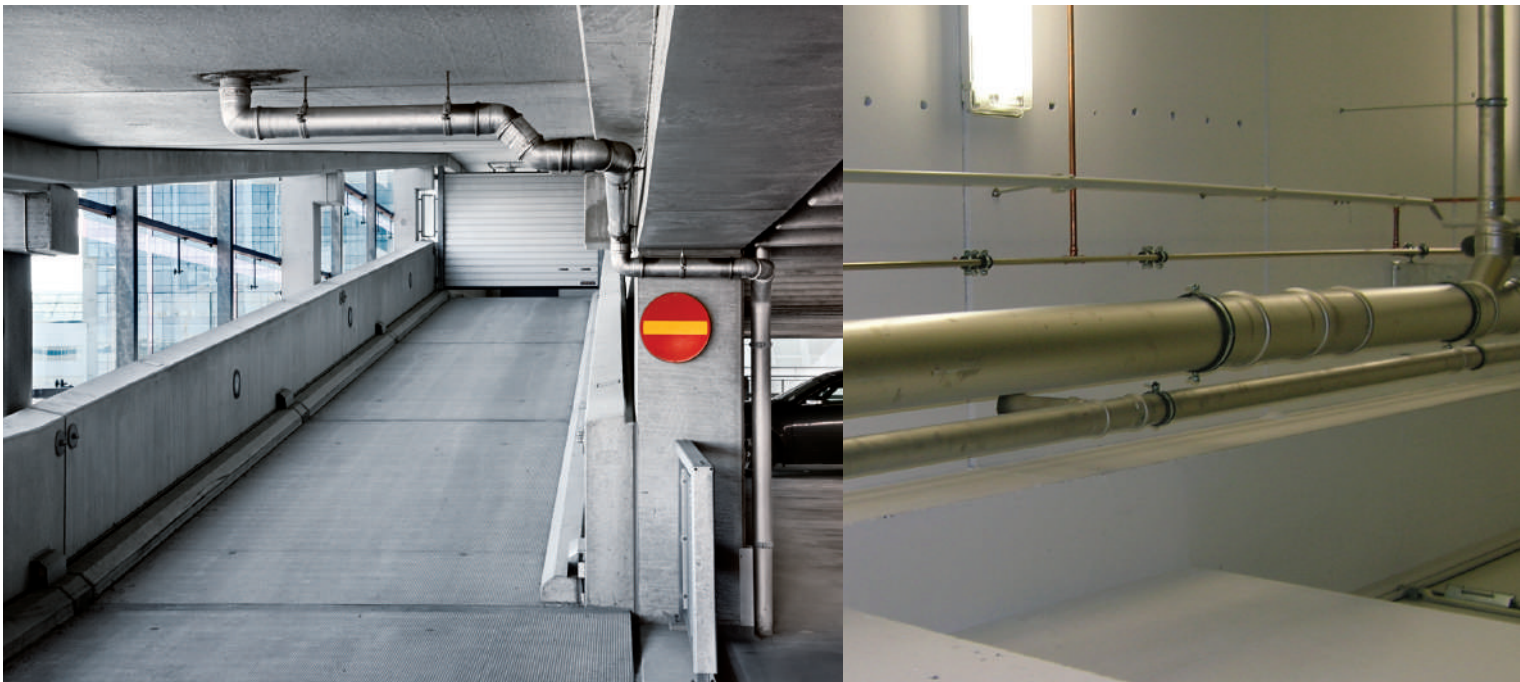

## Push-fit system Lightweight Fire resistant

### Applications

- Above or below ground
- Completely interchangeable between vacuum and gravity systems

### Details

- Standard dimensions Ø50 - Ø315mm
- Standard lengths 0.15 - 6 metres
- Extensive range of fittings
- Sealing ring included (one sealing ring for gravity and vacuum)
- Stainless steel AISI304/EN 1.4301 or AISI316L/EN 1.4404

### Variants

- Range of sealing rings for various applications

### Options

- Range of pipe hangers
- Access pipe with hinged door
- Rat stop
- Electrical or manual pipe cutters

## Complete systems

BLÜCHER® EuroPipe system can be used for many purposes - waste-water drainage, rainwater drainage, vacuum-cleaning systems, roof drainage

Waste-water drainage system, gravity

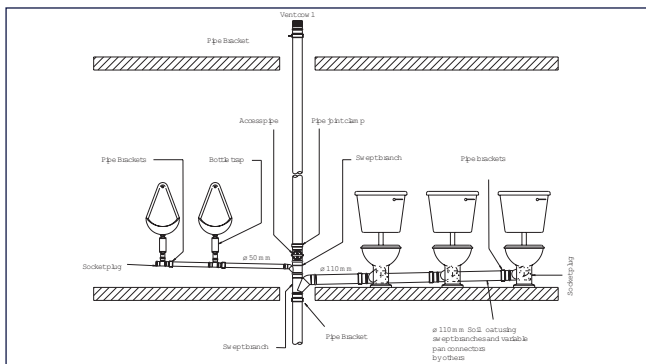

Waste-water drainage system, vacuum

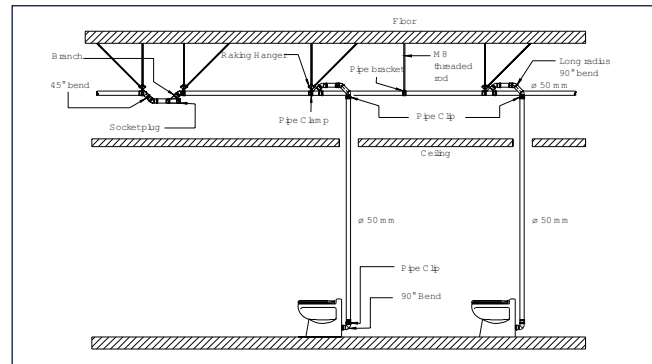

Below ground installation

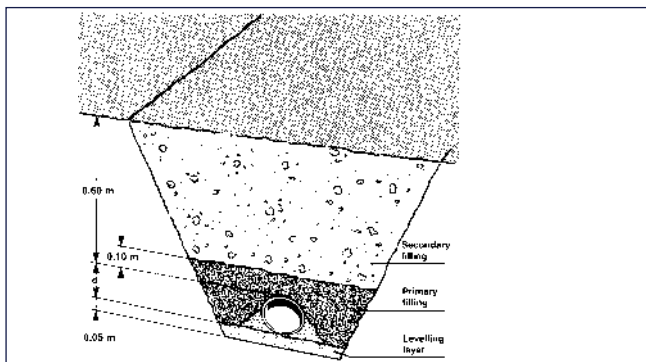

Below ground, pipes cast in raft foundation

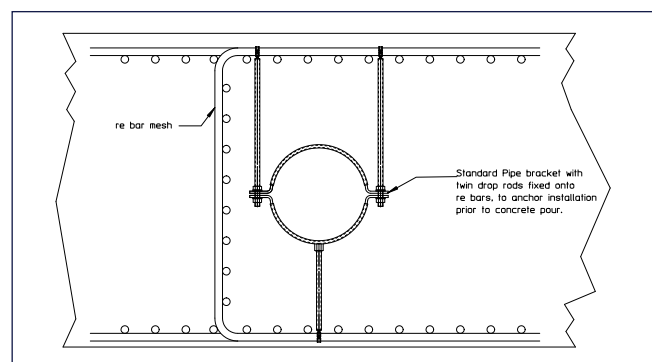

Siphonic rainwater installation

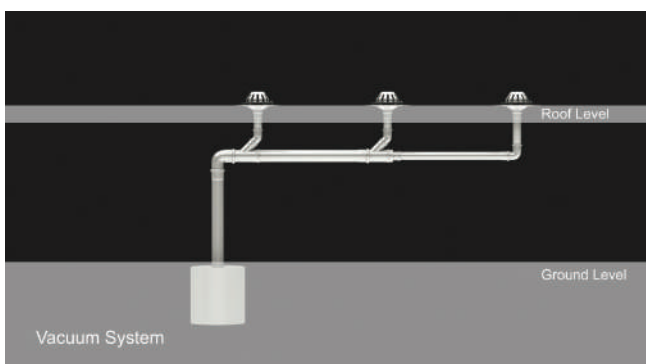

Gravity rainwater installation

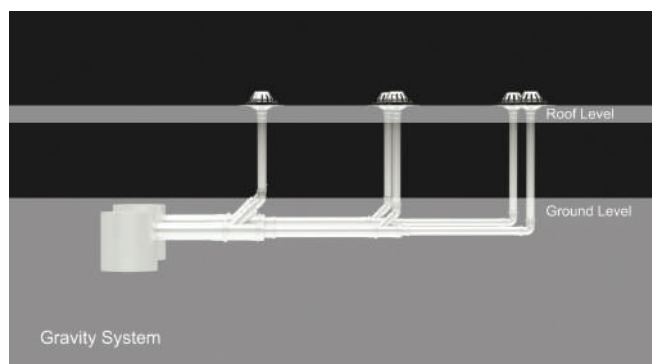

# Installation examples

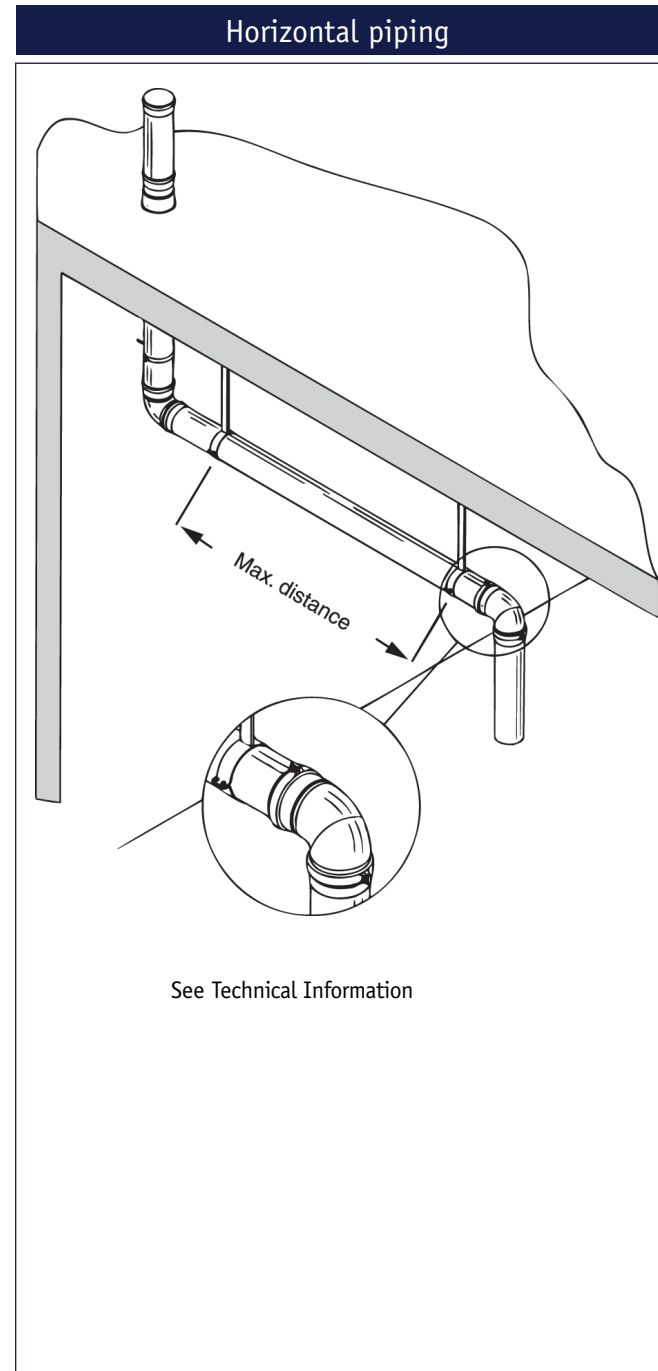
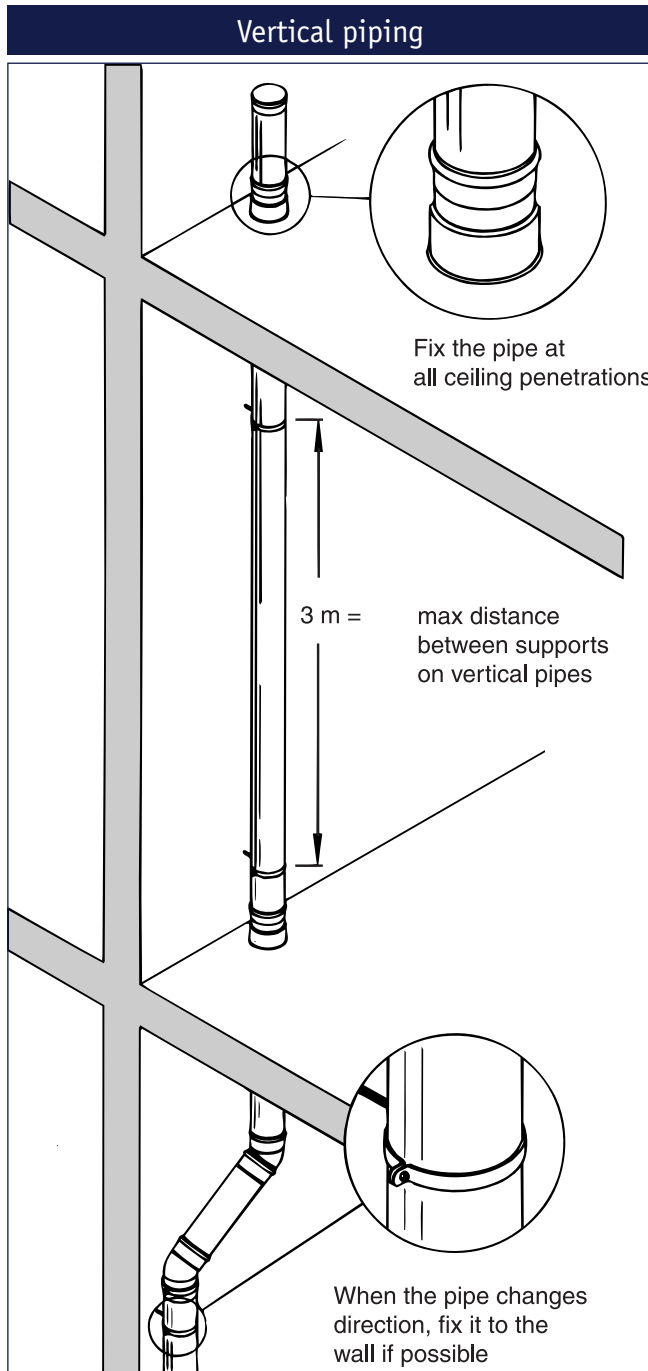

One fixing point per storey is normally sufficient. As opposed to plastic pipes, stainless steel pipes require only one pipe hanger per 3 metres, resulting in less sound and faster installation.

**For further specifications and installation advice see the catalogue: "Technical information on BLÜCHER<sup>®</sup> EuroPipe".**

Horizontal pipe runs are always to be installed with a gradient. If no self-cleansing calculation is available, a gradient of 20 ‰ is recommended in gravity systems. Horizontal pipe runs in vacuum systems are to be installed in accordance with the recommendations of the vacuum system supplier.

When connecting major branch lines, the pipe is to be fixed just below the branch line.

**DIMENSIONAL DRAWING, SOCKET AND SPIGOT END**  
PIPES AND FITTINGS

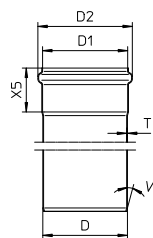

Type no.	EAN no.	D	D1	D2	X5	T	V(°)
811.XXX.050 S		50	51	61	42	1	20
811.XXX.075 S		75	76	87	50	1	20
811.XXX.110 S		110	111	123	57	1	20
811.XXX.160 S		160	161	177	72	1.25	20
811.XXX.200 S		200	201	219	90	1.5	20
811.XXX.250 S		250	251	277	108	1.5	20
811.XXX.315 S		315	316	344	116	2	20

**STRAIGHT PIPE WITH ONE SOCKET TYPE 811**

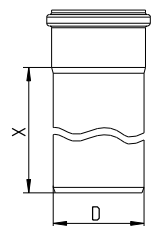

Type no.	EAN no.	D	X	Kg
811.015.050 S	5705499400205	50	150	0,25
811.025.050 S	5705499400281	50	250	0,38
811.050.050 S	5705499400366	50	500	0,68
811.075.050 S	5705499400441	50	750	1,00
811.100.050 S	5705499400526	50	1000	1,25
811.150.050 S	5705499400601	50	1500	1,90
811.200.050 S	5705499400687	50	2000	2,45
811.300.050 S	5705499400762	50	3000	3,82
811.400.050 S	5705499400854	50	4000	5,06
811.500.050 S	5705499400939	50	5000	6,31
811.600.050 S	5705499401011	50	6000	7,56
-----				
811.015.075 S	5705499400229	75	150	0,41
811.025.075 S	5705499400304	75	250	0,58
811.050.075 S	5705499400380	75	500	1,00
811.075.075 S	5705499400465	75	750	1,50
811.100.075 S	5705499400540	75	1000	1,95
811.150.075 S	5705499400625	75	1500	2,75
811.200.075 S	5705499400700	75	2000	3,70
811.300.075 S	5705499400793	75	3000	5,78
811.400.075 S	5705499400878	75	4000	7,66
811.500.075 S	5705499400953	75	5000	9,54
811.600.075 S	5705499401035	75	6000	11,42
-----				
811.015.110 S	5705499400243	110	150	0,61
811.025.110 S	5705499400328	110	250	0,87
811.050.110 S	5705499400403	110	500	1,50
811.075.110 S	5705499400489	110	750	2,15
811.100.110 S	5705499400564	110	1000	2,85
811.150.110 S	5705499400649	110	1500	4,30

Continues on next page



**STRAIGHT PIPE WITH ONE SOCKET TYPE 811**

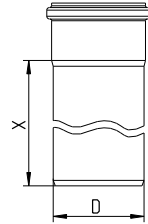

Type no.	EAN no.	D	X	Kg
Continued from previous page				
811.200.110 S	5705499400724	110	2000	5,40
811.300.110 S	5705499400816	110	3000	8,34
811.400.110 S	5705499400892	110	4000	11,26
811.500.110 S	5705499400977	110	5000	14,02
811.600.110 S	5705499401059	110	6000	16,78
-----				
811.015.160 S	5705499400267	160	150	1,19
811.025.160 S	5705499400342	160	250	1,69
811.050.160 S	5705499400427	160	500	2,96
811.075.160 S	5705499400502	160	750	4,22
811.100.160 S	5705499400588	160	1000	5,48
811.150.160 S	5705499400663	160	1500	8,02
811.200.160 S	5705499400748	160	2000	10,54
811.300.160 S	5705499400830	160	3000	15,59
811.400.160 S	5705499400915	160	4000	20,64
811.500.160 S	5705499400991	160	5000	25,69
811.600.160 S	5705499401073	160	6000	30,74
-----				
811.015.200 S	5705499412291	200	150	1,96
811.025.200 S	5705499412307	200	250	2,77
811.050.200 S	5705499412314	200	500	4,62
811.075.200 S	5705499412321	200	750	6,47
811.100.200 S	5705499412338	200	1000	8,32
811.200.200 S	5705499412345	200	2000	15,71
811.300.200 S	5705499412352	200	3000	23,10
-----				
811.050.250 S	5705499121735	250	500	5,84
811.100.250 S	5705499121742	250	1000	10,47
811.200.250 S	5705499121759	250	2000	19,72
811.300.250 S	5705499121766	250	3000	28,97
-----				
811.050.315 S	5705499413748	315	500	9,93
811.100.315 S	5705499413762	315	1000	17,70
811.200.315 S	5705499413786	315	2000	33,24
811.300.315 S	5705499413809	315	3000	48,77

**PIPE WITH ACCESS TYPE 813**

IMPACT RESISTANT

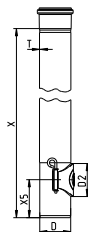

Type no.	EAN no.	D	D2	X	X5	T	Kg
813.150.075 S	5705499413557	75	80	1500	92	2	5,61
813.150.110 S	5705499413540	110	120	1500	123	2	8,41

For non pressurized system

- Bends

**BEND 15° TYPE 820.015**

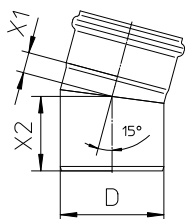

Type no.	EAN no.	D	X1	X2	Kg
820.015.050 S	5705499401127	50	19	53	0,15
820.015.075 S	5705499401141	75	21	65	0,28
820.015.110 S	5705499401165	110	25	78	0,47
820.015.160 S	5705499401189	160	29	99	1,08
820.015.200 S	5705499410976	200	31	123	1,99
820.015.250 S	5705499121599	250	38	136	3,03
820.015.315 S	5705499413816	315	46	151	5,50

**BEND 30° TYPE 820.030**

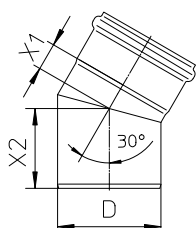

Type no.	EAN no.	D	X1	X2	Kg
820.030.050 S	5705499401226	50	23	57	0,16
820.030.075 S	5705499401240	75	25	70	0,28
820.030.110 S	5705499401264	110	33	86	0,51
820.030.160 S	5705499401288	160	40	110	1,19
820.030.200 S	5705499410983	200	45	137	2,20
820.030.250 S	5705499121605	250	56	153	3,35
820.030.315 S	5705499413823	315	68	172	6,18

**BEND 45° TYPE 820.045**

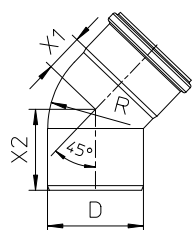

Type no.	EAN no.	D	X1	X2	R	Kg
820.045.050 S	5705499401301	50	27	60	50	0,17
820.045.075 S	5705499401325	75	34	76	75	0,30
820.045.110 S	5705499401349	110	43	93	110	0,56
820.045.160 S	5705499401363	160	57	128	172	1,55
820.045.200 S	5705499414011	200	61	151	200	2,38
820.045.250 S	5705499414028	250	77	177	250	3,69

**BEND 87.5° TYPE 820.090**

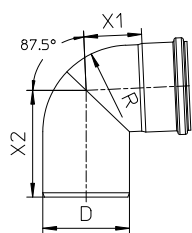

Type no.	EAN no.	D	X1	X2	R	Kg
820.090.050 S	5705499401387	50	41	87	50	0,21
820.090.075 S	5705499401400	75	54	108	75	0,39
820.090.110 S	5705499401424	110	74	136	110	0,67
820.090.160 S	5705499401448	160	103	184	171	2,10
820.090.200 S	5705499414042	200	116	216	200	3,00
820.090.250 S	5705499414059	250	145	269	250	4,77

- Bends

**BEND, LARGE RADIUS 45° TYPE 825.045**

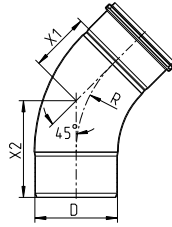

Type no.	EAN no.	D	X1	X2	R	Kg
825.045.200 S	5705499410990	200	144	234	300	4,18
825.045.250 S	5705499121612	250	187	280	375	6,53
825.045.315 S	5705499413830	315	204	320	400	10,78

**BEND, LARGE RADIUS 87.5° TYPE 825.090**

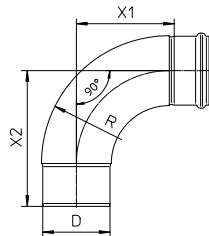

Type no.	EAN no.	D	X1	X2	R	Kg
825.090.050 S	5705499408843	50	77	125	97	0,65
825.090.075 S	5705499408850	75	104	155	133	1,00
825.090.110 S	5705499408867	110	160	222	209	1,41
825.090.160 S	5705499408874	160	244	322	313	2,99
825.090.200 S	5705499411423	200	307	397	300	6,41
825.090.250 S	5705499121629	250	391	484	375	9,88
825.090.315 S	5705499413847	315	421	538	400	15,78

- Branches

**OBLIQUE BRANCH 45° TYPE 838**

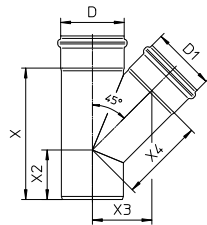

Type no.	EAN no.	D	D1	X	X2	X3	X4	Kg
838.050.050 S	5705499402353	50	50	133	62	54	76	0,32
838.050.075 S	5705499402377	75	50	144	56	66	94	0,48
838.050.110 S	5705499402391	110	50	147	42	84	119	0,70
838.075.075 S	5705499402414	75	75	183	78	78	110	0,64
838.075.110 S	5705499402438	110	75	181	60	95	135	0,88
838.110.110 S	5705499402452	110	110	236	91	105	149	1,16
838.110.160 S	5705499402476	160	110	258	80	131	186	2,11
838.160.160 S	5705499402490	160	160	331	120	156	220	3,04
838.160.200 S	5705499411027	200	160	359	123	177	250	4,37
838.200.200 S	5705499411034	200	200	415	151	194	274	5,47
838.200.250 S	5705499121650	250	200	432	142	217	307	6,61
838.250.250 S	5705499121667	250	250	512	177	236	334	8,57
838.250.315 S	5705499413878	315	250	518	154	270	416	12,48
838.315.315 S	5705499413885	315	315	621	200	294	382	16,53

- Branches

BRANCH 87.5° TYPE 830

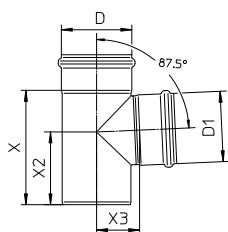

Type no.	EAN no.	D	D1	X	X2	X3	Kg
830.050.050 S	5705499401608	50	50	106	71	35	0,27
830.050.075 S	5705499401622	75	50	139	98	49	0,44
830.050.110 S	5705499401646	110	50	132	93	66	0,64
830.050.160 S	5705499401660	160	50	158	109	88	2,40
830.075.075 S	5705499401684	75	75	139	90	52	0,50
830.075.110 S	5705499401707	110	75	152	104	69	0,76
830.075.160 S	5705499412550	160	75	179	121	95	1,46
830.110.110 S	5705499401721	110	110	183	117	69	0,88
830.110.160 S	5705499401745	160	110	236	152	93	1,84
830.160.160 S	5705499401769	160	160	288	184	104	2,40
830.160.200 S	5705499411003	200	160	293	186	125	3,45
830.200.200 S	5705499411010	200	200	333	206	128	4,17
830.200.250 S	5705499121636	250	200	352	220	155	5,50
830.250.250 S	5705499121643	250	250	407	245	152	6,53
830.250.315 S	5705499413854	315	250	416	253	189	9,95
830.315.315 S	5705499413861	315	315	481	286	196	12,22

DOUBLE BRANCH 87.5° TYPE 831

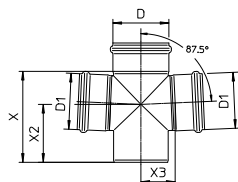

Type no.	EAN no.	D	D1	X	X2	X3	Kg
831.050.050 S	5705499401783	50	50	106	71	35	0,36
831.050.075 S	5705499401806	75	50	139	98	49	0,54
831.050.110 S	5705499401820	110	50	132	93	66	0,72
831.050.160 S	5705499412567	160	50	158	109	88	1,38
831.075.075 S	5705499401844	75	75	139	90	52	0,66
831.075.110 S	5705499401868	110	75	152	104	69	0,89
831.110.110 S	5705499401882	110	110	183	116	69	1,14
831.110.160 S	5705499401905	160	110	236	152	94	2,05
831.160.160 S	5705499401929	160	160	288	184	104	2,91

DOUBLE BRANCH 45° TYPE 836

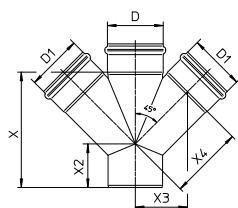

Type no.	EAN no.	D	D1	X	X2	X3	X4	Kg
836.050.050 S	5705499402117	50	50	128	57	54	76	0,59
836.050.075 S	5705499402131	75	50	144	56	66	94	0,69
836.050.110 S	5705499402155	110	50	147	42	84	119	0,80
836.075.075 S	5705499402179	75	75	183	74	78	110	1,15
836.075.110 S	5705499402193	110	75	182	60	95	135	1,31
836.110.110 S	5705499402216	110	110	233	88	105	149	2,10
836.110.160 S	5705499402223	160	110	258	80	131	186	2,85
836.160.160 S	5705499402230	160	160	331	120	156	221	5,28
836.200.200 S	5705499412598	200	200	415	151	194	274	5,28
836.250.250 S	5705499412604	250	250	512	177	236	334	7,01



- Access pipes and bends

**BEND 87.5° WITH ACCESS TYPE 822**

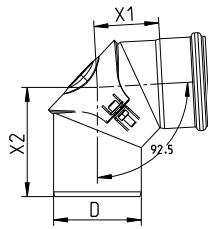

Typenr.: 822.090.110  
1:5  
110902 J0

Type no.	EAN no.	D	X1	X2	Kg
822.090.075 S	5705499401509	75	57	102	0,61
822.090.110 S	5705499401523	110	81	137	0,97
822.090.160 S	5705499401547	160	112	205	1,97

For non pressurized system

**PIPE WITH ACCESS TYPE 840**

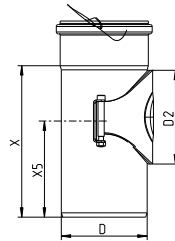

Type no.	EAN no.	D	D2	X	X5	Kg
840.075.075 S	5705499402674	75	80	139	92	0,64
840.110.110 S	5705499403794	110	120	194	123	0,90
840.111.110 S	5705499402698	110	120	253	187	1,16
840.160.160 S	5705499402711	160	120	277	208	2,41
840.200.200 S	5705499412215	200	120	288	208	3,45

For non pressurized system

**PIPE WITH ACCESS TYPE 813**

IMPACT RESISTANT

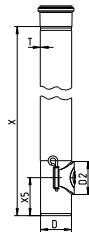

Type no.	EAN no.	D	D2	X	X5	T	Kg
813.150.075 S	5705499413557	75	80	1500	92	2	5,61
813.150.110 S	5705499413540	110	120	1500	123	2	8,41

For non pressurized system

- Toilet adaptors

**TOILET ADAPTOR STRAIGHT TYPE 855.090**

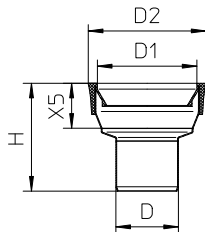

Type no.	EAN no.	D	D1	H.	D2	X5	Kg
855.090.075 S	5705499403299	75	110	130	133	55	0,42
855.090.110 S	5705499403305	110	110	126	133	55	0,39

- Sockets

**DOUBLE COUPLING TYPE 841**

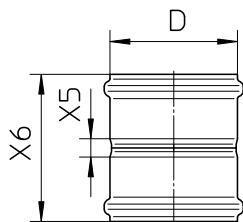

Type no.	EAN no.	D	X5	X6	Kg
841.050.050 S	5705499402735	50	13	97	0,15
841.075.075 S	5705499402759	75	20	120	0,26
841.110.110 S	5705499402773	110	16	130	0,45
841.160.160 S	5705499402797	160	20	162	1,05
841.200.200 S	5705499411065	200	20	200	1,85
841.250.250 S	5705499121674	250	30	246	3,11
841.315.315 S	5705499413908	315	30	262	5,36

**DOUBLE SLIP COUPLING TYPE 842**

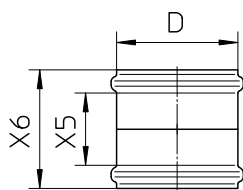

Type no.	EAN no.	D	X5	X6	Kg
842.050.050 S	5705499402810	50	71	97	0,12
842.075.075 S	5705499402827	75	91	120	0,21
842.110.110 S	5705499402834	110	97	130	0,45
842.160.160 S	5705499402841	160	118	162	1,05
842.200.200 S	5705499411072	200	147	200	1,82
842.250.250 S	5705499121681	250	173	264	3,11
842.315.315 S	5705499413915	315	177	262	5,36

- Increases and reducers

**INCREASER ECCENTRIC TYPE 850**

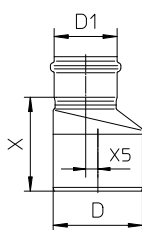

Type no.	EAN no.	D	D1	X	X5	Kg
850.050.075 S	5705499403084	75	50	87	7	0,22
850.050.110 S	5705499403107	110	50	114	25	0,38
850.075.110 S	5705499403138	110	75	116	15	0,42
850.075.160 S	5705499403169	160	75	178	37	1,20
850.110.160 S	5705499403206	160	110	140	22	1,06
850.160.200 S	5705499413434	200	160	165	20	1,67
850.200.250 S	5705499413441	250	200	195	25	2,57
850.200.315 S	5705499413953	315	200	280	58	4,61
850.250.315 S	5705499413977	315	250	242	33	4,82

**REDUCER ECCENTRIC TYPE 850**

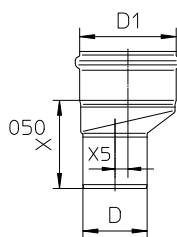

Type no.	EAN no.	D	D1	X	X5	Kg
850.075.050 S	5705499403121	50	75	80	7	0,28
850.110.050 S	5705499403183	50	110	99	25	0,50
850.110.075 S	5705499403190	75	110	104	15	0,55
850.160.110 S	5705499408485	110	160	123	22	1,08
850.200.160 S	5705499413373	160	200	153	20	1,77
850.250.200 S	5705499413380	200	250	192	25	1,00
850.315.250 S	5705499413984	250	315	229	33	4,93

- Adaptors

**FEMALE ADAPTOR TYPE 885.0**

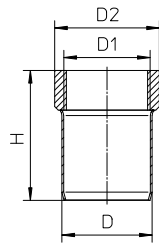

Type no.	EAN no.	D	D1	H.	D2	Kg
885.025.050 S	5705499403435	50	1"	93	40	0,18
885.032.050 S	5705499403459	50	1¼"	72	48	0,17
885.040.050 S	5705499403466	50	1½"	72	58	0,19
885.050.050 S	5705499403473	50	2"	77	67	0,22

BSP thread.

**MALE ADAPTOR TYPE 886.0**

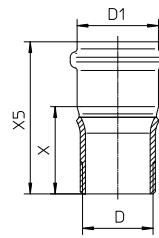

Type no.	EAN no.	D	D1	X	X5	Kg
886.050.032 S	5705499410693	1¼"	50	55	97	0,25
886.050.050 S	5705499403503	2"	50	56	98	0,27

BSP thread.

**UNIVERSAL FLANGE TYPE 854.500**

WITH SOCKET

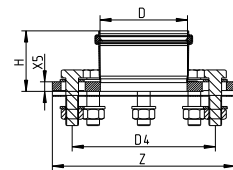

Type no.	EAN no.	D	Z.	H.	D4	X5	Kg
854.500.050 S	5705499138870	50	Ø160	58	94-126	10	0,85
854.500.075 S	5705499138894	75	Ø200	71	129-161	12	1,49
854.500.110 S	5705499138917	110	Ø230	76	163-192	12	2,16
854.500.160 S	5705499138955	160	Ø285	102	228-244	15	3,72

Flanges with 4 screw joints (D=50-75mm)  
Flanges with 8 screw joints (D=110-160mm)

**UNIVERSAL FLANGE TYPE 854.510**

WITH SPIGOT

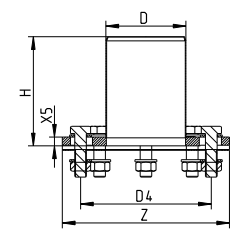

Type no.	EAN no.	D	Z.	H.	D4	X5	Kg
854.510.050 S	5705499138887	50	Ø160	150	94-126	10	0,95
854.510.075 S	5705499138900	75	Ø200	150	129-161	12	1,61
854.510.110 S	5705499138924	110	Ø230	150	163-192	12	2,32
854.510.160 S	5705499138962	160	Ø285	150	228-244	15	3,72

Flanges with 4 screw joints (D=50-75mm)  
Flanges with 8 screw joints (D=110-160mm)

## Clamps

### PIPE JOINT CLAMP TYPE 847

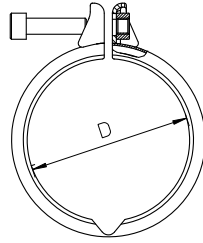

Type no.	EAN no.	D
847.050.050 S	5705499412420	50
847.075.075 S	5705499412437	75
847.110.110 S	5705499412444	110
847.160.160 S	5705499412468	160
847.200.200 S	5705499412475	200
847.250.250 S	5705499121773	250

### CROSS RAKING FIXING FOR PIPE JOINT CLAMP TYPE 847

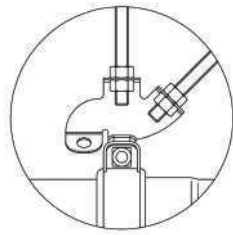

Type no.	EAN no.
847.000.000 S	5705499409628

To be used with pipe joint clamp type 847.

## Plugs

### SOCKET PLUG TYPE 844.000

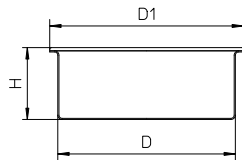

Type no.	EAN no.	D	D1	H.
844.000.050 S	5705499402933	50	58	50
844.000.075 S	5705499402940	75	85	45
844.000.110 S	5705499402957	110	120	45
844.000.160 S	5705499402964	160	170	45
844.000.200 S	5705499412239	200	210	50
844.000.250 S	5705499123654	250	265	65
844.000.315 S	5705499413922	315	335	82

Use of pipe joint clamp type 847 is necessary if any pressure in the pipe system is expected.

### SOCKET PLUG TYPE 844

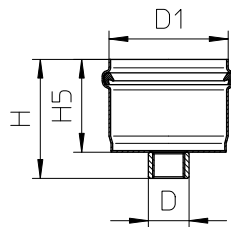

Type no.	EAN no.	D	D1	H.	H5.
844.069.050 S	5705499409567	½"	50	67	50
844.082.075 S	5705499409574	½"	75	78	61
844.087.110 S	5705499409581	½"	110	84	67

BSP thread.



Water traps

**P-TRAP 87.5° TYPE 525**

WITH COUPLING AND DRAIN PLUG

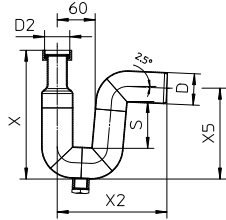

Type no.	EAN no.	D	S	D2	X	X2	X5	Kg
525.032.050 S	5705499114065	50	74	1¼"	205	175	145	0,95
525.040.050 S	5705499114072	50	74	1½"	205	175	145	0,90
525.050.050 S	5705499114089	50	74	2"	205	175	145	0,88

BSP thread.

**P-TRAP 87.5° TYPE 525.090**

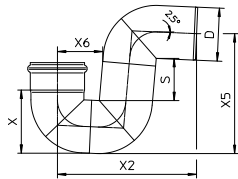

Type no.	EAN no.	D	S	X	X2	X5	X6	Kg
525.090.050 S	5705499101461	50	74	67	175	145	60	0,45
525.090.075 S	5705499101478	75	81	93	222	189	74	0,84
525.090.110 S	5705499101485	110	89	132	289	249	94	1,49
525.090.160 S	5705499101492	160	105	187	388	338	121	6,22

**FLOW RATES FOR P-TRAP 87.5° TYPE 525.090**

Type no.	EAN no.	Min Flow (l/s)	Max Flow (l/s)
525.090.050 S	5705499101461	0.7	1.7
525.090.075 S	5705499101478	2.5	3.7
525.090.110 S	5705499101485	3.4	10.4
525.090.160 S	5705499101492	7.5	28.5

Accurate flow rate depending on installation.

**S-TRAP 180° TYPE 525.180**

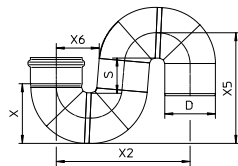

Type no.	EAN no.	D	S	X	X2	X5	X6	Kg
525.180.050 S	5705499114096	50	74	67	166	145	60	0,54
525.180.075 S	5705499114102	75	81	93	217	190	74	1,00
525.180.110 S	5705499114119	110	89	132	292	249	94	2,00
525.180.160 S	5705499114126	160	105	187	394	342	122	4,40

**BOTTLE WATER TRAP TYPE 505**

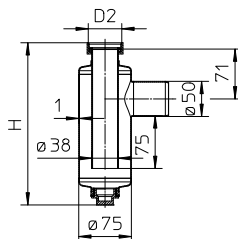

Type no.	EAN no.	H	D2	Kg
505.032.050 S	5705499101447	250	1¼"	0,95
505.040.050 S	5705499101454	233	1½"	0,85
505.050.050 S	5705499114058	243	2"	1,20

75 mm water seal. BSP thread.

Sealing rings

**EPDM LIP SEALING RING BLACK TYPE 801**  
FOR STANDARD USE

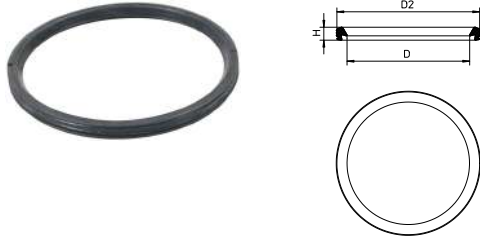

Type no.	EAN no.	D	H	D2
801.EPDM.050	5705499400038	50	7.8	61.8
801.EPDM.075	5705499400045	75	7.8	87.1
801.EPDM.110	5705499400069	110	8.9	124.2
801.EPDM.160	5705499400076	160	11.5	180.1
801.EPDM.200	5705499410785	200	12.8	223.8
801.EPDM.250	5705499121704	250	19	282
801.EPDM.315	5705499413700	315	20	350

**FPM LIP SEALING RING TYPE 801**  
FOR HIGH TEMPERATURES

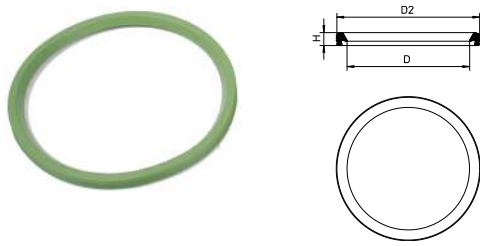

Type no.	EAN no.	D	H	D2
801.FPM.050	5705499408102	50	7.8	61.8
801.FPM.075	5705499408119	75	7.8	87.1
801.FPM.110	5705499408126	110	8.9	124.2
801.FPM.160	5705499408133	160	11.5	180.1
801.FPM.200	5705499410808	200	12.8	223.8
801.FPM.250	5705499121728	250	19	282
801.FPM.315	5705499413717	315	20	350

**NBR LIP SEALING RING BLACK/YELLOW TYPE 801**  
FOR USE WITH OIL



Type no.	EAN no.	D	H	D2
801.NBR.050	5705499400106	50	7.8	61.8
801.NBR.075	5705499400113	75	7.8	87.1
801.NBR.110	5705499400120	110	8.9	124.2
801.NBR.160	5705499400137	160	11.5	180.1
801.NBR.200	5705499410822	200	12.8	223.8
801.NBR.250	5705499121711	250	19	282
801.NBR.315	5705499413724	315	20	350

**SI LIP SEALING TYPE 801**  
FOR USE IN FIRE-APPROVED PRODUCTS

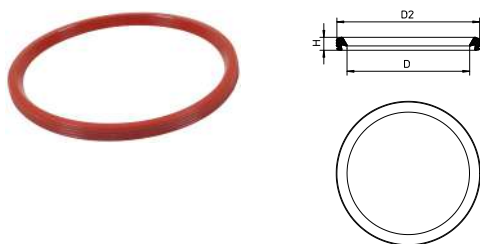

Type no.	EAN no.	D	H	D2
801.SI.050	5705499408140	50	7.8	61.8
801.SI.075	5705499408157	75	7.8	87.1
801.SI.110	5705499408164	110	8.9	124.2
801.SI.160	5705499408171	160	11.5	180.1

### MANUAL PIPE CUTTER

Cutting is done by a special disc cutter, which cuts and grips at the same time.

N.B.: Do not cut fittings.



Type no.	EAN no.	Designation
006.050.110	5705499000061	Manual pipe cutter (40 - 110 mm)
006.125.200	5705499001020	Manual pipe cutter (110 - 200 mm)
006.200.315	5705499123531	Manual pipe cutter (200 - 315 mm)
006.000.005	5705499000023	Spindle for 006.050.110
006.000.000	5705499000016	Cutting disc for 006.050.110
006.000.001	5705499001068	Cutting disc for 006.125.200 & 006.200.315

### ELECTRICAL PIPE CUTTER

Cutting time:  
Seconds.

Changeover time:  
Changeover from one cutting disc to another can be effected within a matter of seconds.

Cutting quality:  
The cutting motion has been developed to produce a bevelled leading edge to cut ends. As a result only the application of BLÜCHER jointing lubricant is required prior to jointing cut ends.

Power supply:  
110 Volt/Min 2 kVA/60 Hz or 220 Volt/50 Hz.

Pipe diametres:  
50-160 mm

N.B.: Do not cut fittings.



Type no.	EAN no.	Designation
800.050.160	5705499400021	Electrical pipe cutter 220 V
800.050.160 GB	5705499000184	Electrical pipe cutter 110 V, 16 A
800.050.160 US	5705499000191	Electrical pipe cutter 110 V, USA plug
800.030.006	5705499400014	Cutting disc
006.050.160	5705499124132	Support base for electrical pipe cutter

### CUTTING OIL/JOINTING LUBRICANT

Jointing lubricant is applied to make jointing a simple action. After a few days the lubricant will dry out and lose its lubricity making subsequent demounting of a joint difficult. If subsequent demounting of joints can be envisaged then we can supply a silicone based lubricant that will not dry out. BLÜCHER jointing lubricant is based on a mild and harmless liquid detergent that is biologically degradable. BLÜCHER cutting oil is recommended for use with BLÜCHER® EuroPipe pipe cutters.



Type no.	EAN no.	Designation
007.000.000	5705499000078	Atomizer
007.100.050	5705499000085	Jointing lubricant 0.5 L
007.500.050	5705499000092	Cutting oil 0.5 L

### ASSEMBLY TOOL



Type no.	EAN no.	Designation
806.000.160	5705499124149	For pipes D=160mm
806.000.200	5705499123500	For pipes D=200mm
806.000.250	5705499124156	For pipes D=250mm

### DIMPLING JAWS

FOR PRESSING PROJECTIONS ON PIPES



Type no.	EAN no.
800.200.001	5705499403978

