



JD Edwards World

Product Costing and

Manufacturing Accounting

Guide

Version A9.1

Revised - April 30, 2008

Copyright © 2006, Oracle. All rights reserved.

The Programs (which include both the software and documentation) contain proprietary information; they are provided under a license agreement containing restrictions on use and disclosure and are also protected by copyright, patent, and other intellectual and industrial property laws. Reverse engineering, disassembly, or decompilation of the Programs, except to the extent required to obtain interoperability with other independently created software or as specified by law, is prohibited.

The information contained in this document is subject to change without notice. If you find any problems in the documentation, please report them to us in writing. This document is not warranted to be error-free. Except as may be expressly permitted in your license agreement for these Programs, no part of these Programs may be reproduced or transmitted in any form or by any means, electronic or mechanical, for any purpose.

If the Programs are delivered to the United States Government or anyone licensing or using the Programs on behalf of the United States Government, the following notice is applicable:

U.S. GOVERNMENT RIGHTS

Programs, software, databases, and related documentation and technical data delivered to U.S. Government customers are "commercial computer software" or "commercial technical data" pursuant to the applicable Federal Acquisition Regulation and agency-specific supplemental regulations. As such, use, duplication, disclosure, modification, and adaptation of the Programs, including documentation and technical data, shall be subject to the licensing restrictions set forth in the applicable Oracle license agreement, and, to the extent applicable, the additional rights set forth in FAR 52.227-19, Commercial Computer Software--Restricted Rights (June 1987). Oracle Corporation, 500 Oracle Parkway, Redwood City, CA 94065.

The Programs are not intended for use in any nuclear, aviation, mass transit, medical, or other inherently dangerous applications. It shall be the licensee's responsibility to take all appropriate fail-safe, backup, redundancy and other measures to ensure the safe use of such applications if the Programs are used for such purposes, and we disclaim liability for any damages caused by such use of the Programs.

The Programs may provide links to Web sites and access to content, products, and services from third parties. Oracle is not responsible for the availability of, or any content provided on, third-party Web sites. You bear all risks associated with the use of such content. If you choose to purchase any products or services from a third party, the relationship is directly between you and the third party. Oracle is not responsible for: (a) the quality of third-party products or services; or (b) fulfilling any of the terms of the agreement with the third party, including delivery of products or services and warranty obligations related to purchased products or services. Oracle is not responsible for any loss or damage of any sort that you may incur from dealing with any third party.

Oracle, JD Edwards, PeopleSoft, and Retek are registered trademarks of Oracle Corporation and/or its affiliates. Other names may be trademarks of their respective owners.

Open Source Disclosure

Oracle takes no responsibility for its use or distribution of any open source or shareware software or documentation and disclaims any and all liability or damages resulting from use of said software or documentation. The following open source software may be used in Oracle's PeopleSoft products and the following disclaimers are provided.

This product includes software developed by the Apache Software Foundation (<http://www.apache.org/>). Copyright (c) 1999-2000 by The Apache Software Foundation. All rights reserved. THIS SOFTWARE IS PROVIDED "AS IS" AND ANY EXPRESSED OR IMPLIED WARRANTIES, INCLUDING, BUT NOT LIMITED TO, THE IMPLIED WARRANTIES OF MERCHANTABILITY AND FITNESS FOR A PARTICULAR PURPOSE ARE DISCLAIMED. IN NO EVENT SHALL THE APACHE SOFTWARE FOUNDATION OR ITS CONTRIBUTORS BE LIABLE FOR ANY DIRECT, INDIRECT, INCIDENTAL, SPECIAL, EXEMPLARY, OR CONSEQUENTIAL DAMAGES (INCLUDING, BUT NOT LIMITED TO, PROCUREMENT OF SUBSTITUTE GOODS OR SERVICES; LOSS OF USE, DATA, OR PROFITS; OR BUSINESS INTERRUPTION) HOWEVER CAUSED AND ON ANY THEORY OF LIABILITY, WHETHER IN CONTRACT, STRICT LIABILITY, OR TORT (INCLUDING NEGLIGENCE OR OTHERWISE) ARISING IN ANY WAY OUT OF THE USE OF THIS SOFTWARE, EVEN IF ADVISED OF THE POSSIBILITY OF SUCH DAMAGE.

Send Us Your Comments

JD Edwards World Release A9.1 Documentation, Revised - April 30, 2008

JD Edwards World welcomes your comments and suggestions on the quality and usefulness of this publication. Your input is an important part of the information used for revision.

- Did you find any errors?
- Is the information clearly presented?
- Do you need more information? If so, where?
- Are the examples correct? Do you need more examples?
- What features did you like most about this manual?

If you find any errors or have any other suggestions for improvement, please indicate the title and part number of the documentation and the chapter, section, and page number (if available). You can send comments to us by e-mail at:

jde_world_doc_ww@oracle.com

If you would like a reply, please give your name, address, telephone number, and electronic mail address (optional).

Contact a JD Edwards World representative by calling Oracle Global Support Center at 1-800-289-2999 for current information or if you have any questions regarding this document.

Contents

1 Overview

Overview to Product Costing and Manufacturing Accounting.....	1-1
System Integration.....	1-1
Features	1-2
Product Costing and Manufacturing Accounting Integration	1-3
Achieving Effective Cost Management.....	1-7
Tables.....	1-8
Menu Overview	1-10

2 Product Costing

Overview to Product Costing	2-1
About Product Costing	2-1
Set Up Product Costing	2-5
Setting Up Product Costing.....	2-5
Setting Up Accounting Cost Quantities.....	2-5
Setting Up Item Cost Levels	2-6
Converting Item Cost Levels.....	2-10
Setting Up Item Costs.....	2-11
Setting Up Cost Components	2-16
Setting Up Manufacturing Constants for Product Costing.....	2-17
Setting Up Simulated Rates for a Work Center	2-21
Setting Up Actual Rates for a Work Center and Overhead	2-23
Review Bills of Material and Routings.....	2-25
Reviewing Bills of Material and Routings for Product Costing	2-25
Reviewing Product Costing in Bills of Material	2-25
Reviewing Routings for Product Costing.....	2-30
Create Simulated Costs	2-35
Creating Simulated Costs	2-35
Creating the Costing Exceptions Report.....	2-36
Creating a Simulated Rollup	2-38

Work with Simulated Cost Components	2-41
Working with Simulated Cost Components.....	2-41
Reviewing and Revising Simulated Cost Components	2-41
Setting Up Standard Rate and Factor Codes	2-45
Assigning Values to User Defined Cost Components.....	2-47
Reviewing the Standard Cost Simulation Report	2-50
Setting Up Cost Bucket Codes for Costed Bills of Material.....	2-50
Reviewing Costed Bills of Material.....	2-52
Setting Up Operation Bucket Codes for Costed Routings.....	2-60
Reviewing a Costed Routing	2-61
Update Frozen Costs	2-67
Updating Frozen Costs	2-67
Review Costing Information	2-73
Reviewing Costing Information	2-73
Reviewing Frozen Cost Components	2-73
Reviewing the Item Ledger.....	2-75
Reviewing the Single Level Costed Bill of Material Report.....	2-78
Reviewing the Multi-Level Costed Bill of Material Report	2-79
Reviewing the Cost Components Report.....	2-80
Reviewing the Cost Integrity Report	2-81
Work with Additional Costing Features	2-83
Working with Additional Costing Features	2-83
Copying Costs.....	2-83
Copying Frozen Costs to Simulated Costs.....	2-84
Updating Sales Order Price/Cost	2-84
Updating Product Costs	2-84
3 Product Costing in ERPx Environments	
Overview to Product Costing in ERPx Environments.....	3-1
About Product Costing in ERPx Environments	3-1
Understand Batch Product Costing	3-3
About Batch Product Costing	3-3
Understand Product Costing for Planning Items	3-5
About Product Costing for Planning Items	3-5
Work with Process Industry Costing.....	3-7
Working with Process Industry Costing.....	3-7

Reviewing Product Costing for Processes.....	3-9
Reviewing Product Costing for Intermediates	3-11
Reviewing Product Costing for Ingredients.....	3-13
Reviewing Product Costing for Co- and By-Products	3-14
Calculating Costs for Co- and By-Products.....	3-19
Reviewing Product Costing for Percent Bills of Material.....	3-28
Understand Configured Items	3-31
About Costing for Configured Items	3-31
4 Manufacturing Accounting	
Overview to Manufacturing Accounting.....	4-1
About Manufacturing Accounting	4-1
Set Up Manufacturing Accounting	4-15
Setting Up Manufacturing Accounting.....	4-15
Setting Up General Ledger (G/L) Class Codes	4-15
Reviewing Manufacturing AAIs.....	4-17
Work with Work Orders.....	4-25
Working with Work Orders	4-25
Creating a Work Order (P48013)	4-25
Attaching a Parts List and Routing Instructions	4-28
Issuing Parts to Work Orders.....	4-29
Recording Hours and Quantities Used.....	4-31
Recording Component Scrap	4-34
Recording Completions to Work Orders.....	4-37
Create Journal Entries	4-41
Creating Journal Entries.....	4-41
Creating Journal Entries for Work in Process or Completions.....	4-44
Reviewing Variances (P3102)	4-47
Creating Journal Entries for Variances	4-52
Creating Journal Entries for Bulk Manufacturing Gains and Losses.....	4-56
Reviewing Summarized Work Order Journal Entry Batches	4-57
Review General Ledger Batches	4-59
Reviewing General Ledger Batches.....	4-59
Post to the General Ledger.....	4-69
Posting to the General Ledger.....	4-69
Posting Manufacturing Journal Entries	4-69

Reviewing the Posting Edit Report for Manufacturing	4-72
Reviewing the Posting Journal Report	4-73
Reviewing the Item Ledger/Account Integrity Report	4-74
Reviewing World Writer Reports for Manufacturing Accounting.....	4-76

5 Manufacturing Accounting in ERPx Environments

Overview to Manufacturing Accounting in ERPx Environments.....5-1

About Manufacturing Accounting in ERPx Environments.....	5-1
--	-----

Understand Process Industry Accounting.....5-3

About Process Industry Accounting.....	5-3
--	-----

6 Processing Options

Product Costing Processing Options.....6-1

Item Cost Level Conversion - Final (P41815).....	6-1
Item Cost Revisions (P4105).....	6-1
Costing Exceptions (P30801).....	6-2
Cost Simulation (P30820).....	6-2
Item Cost Components (P30026)	6-4
Costed Bill of Material Inquiry (P30206)	6-4
Costed Routing Inquiry (P30208)	6-5
Item Cost Update (P30835).....	6-6
Item Ledger - Costs (P4111)	6-7
Costed Bill (P30440).....	6-8
Multi-Level Costed Bill (P30445).....	6-9
Cost Components (P30026P).....	6-10
Cost Component/Ledger Integrity (P30543).....	6-10
Copy Component Cost Values (P30890)	6-10
Cost Simulation Reset (P30850)	6-11
Update Sales Cost, Price, or Exchange Rate (P42950).....	6-11
Item Cost Revisions (P4105).....	6-13

Product Costing in ERPx Environments Processing Options6-15

Costed Routing Inquiry (P30208)	6-15
---------------------------------------	------

Manufacturing Accounting Processing Options.....6-17

AAI Revisions (P40901)	6-17
Generate and Print Work Orders (P31410)	6-17
Component Scrap Transactions (P31116).....	6-22
Manufacturing WIP Journal Entries (P31802)	6-23
Manufacturing Variance Journal Entries (P31804).....	6-24

Work Order Closing and Clear WIP (P31806)	6-25
Gain/Loss Analysis Report (P415402)	6-26
General Ledger Post (P09800)	6-27
Item Ledger/Account Integrity (P41543)	6-30

7 Appendices

Appendix A – Calculations in Cost Rollup..... 7-1

Material Cost Components.....	7-1
Routing Cost Components	7-2
Outside Operation Cost Components (Usually Dx)	7-3

Appendix B – Calculations for Variances 7-7

Standard Costs	7-7
Current Costs.....	7-7
Planned Costs.....	7-8
Actual Costs.....	7-8
Completed/Scrapped Costs.....	7-9

Appendix C – Purchase Price Variance 7-11

Example: Purchase Price Variance and Material Burden.....	7-11
---	------

Appendix D – Functional Servers 7-13

About Functional Servers	7-13
--------------------------------	------

Appendix E – Files and Fields Updated..... 7-15

Appendix F – Troubleshooting Techniques for Product Costing 7-17

Run the Integrity Analysis Program (P30601)	7-17
Verify the Processing Options for P30820	7-17
Review A1 Cost Setup.....	7-18
Review Batch Quantity Setup	7-18
Adjust Primary Unit of Measure	7-18
Adjust the B1 or B2 Costs.....	7-18
Adjust the B3 through C4 Costs.....	7-19
Adjust the D1, D2, D3 Costs	7-19

Appendix G – Routing Cost Type Calculations..... 7-21

B1 Direct Labor.....	7-21
B2 Setup Labor	7-21
B3 Machine Run	7-21
B4 Labor Efficiency Cost.....	7-21
C1 Machine (Mach) Variable (Var) Overhead (O/H) Cost.....	7-22
C2 Machine Fixed Overhead Cost.....	7-22

C3 Labor Variable Overhead 7-23
C4 Labor Fixed Overhead 7-23

1 Overview

Overview to Product Costing and Manufacturing Accounting

Maintaining accurate and complete records on the value of inventory is one of the major concerns of most businesses today. Keeping too much of an unprofitable stock, or using inappropriate methods of costing certain inventory items, can quickly deplete your profits.

The Product Costing system allows you to store and retrieve cost information. It also helps you to manage your costs by providing informational inputs to your company's business plan. With accurate product costing, you can evaluate the following manufacturing processes to determine the impact to your company's bottom line:

- Manufacturing budgets (direct labor, indirect labor, and overhead)
- Product design (design and manufacturing engineering)
- Accounting (gross margin by product line or item)

After you establish costs in the Product Costing system, the Manufacturing Accounting system tracks the costs, reports on variances, and posts manufacturing transactions to the general ledger.

Note: The term work order is used throughout this guide. In general, however, transactions that affect work orders also affect rate schedules.

System Integration

Product Costing and Manufacturing Accounting are two of the systems that are included in the Enterprise Requirements Planning and Execution (ERP_x) system.

ERP_x is a closed-loop manufacturing system that formalizes company and operations planning, and the implementation of those plans. Use the ERP_x system to coordinate your inventory and labor resources to deliver products according to a managed schedule.

The following diagram shows the systems that make up ERP_x and the sequence in which they are implemented.

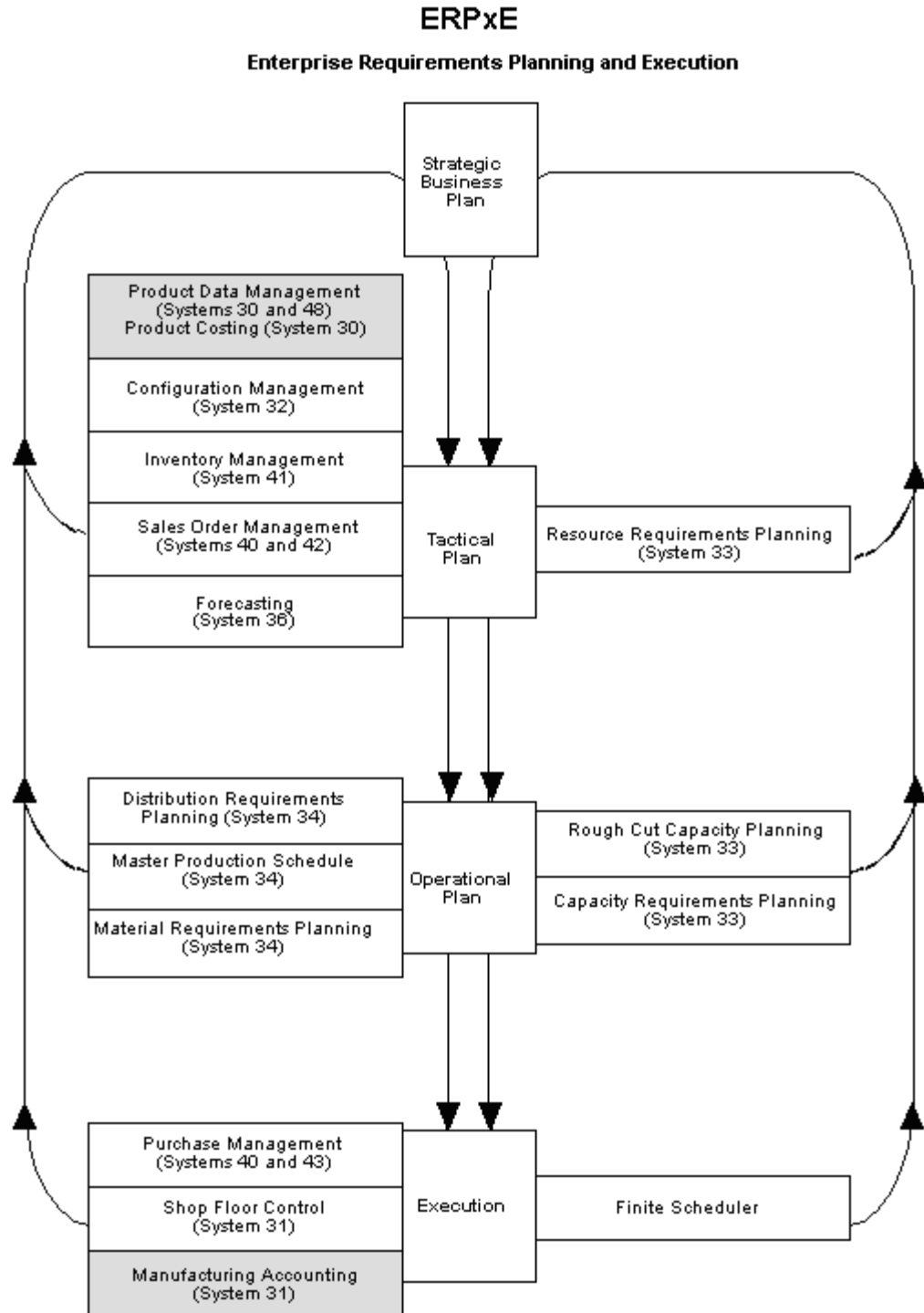

Features

The Product Costing and Manufacturing Accounting systems provide flexibility to accommodate your manufacturing environment. Some of the benefits and features of these systems are:

Feature	Description
User defined cost add-ons	Define and maintain an unlimited number of cost components for tracking specific costs, such as freight, taxes, duty, and electricity.
User defined cost rollup methods	Define an unlimited number of cost methods to use in cost simulation analyses.
User defined cost factors and rates	Allocate cost factors and rates to a specific item. Used with cost add-ons to calculate additional costs.
Cost variances	Print a complete set of reports to compare old costs with new costs before implementing any changes.
Bill of material rollup	Calculate the total material cost by retrieving the bill of material for all items and adding the total cost of the components.
Cost simulation	Run a complete simulation of costs before any live data is updated as the frozen standard.
Multi-facility costing	Maintain cost information at the branch/plant level to allow for cost variances at different locations for identical manufactured items.
Variances	Review four kinds of variances: <ul style="list-style-type: none"> ▪ Engineering ▪ Planned ▪ Actual (material and labor) ▪ Other
Journal entries for variances	Create detailed or summary journal entries for work order variances.
Journal entries for work order transactions	Create detailed or summary journal entries for work in process or completions.
Automatic accounting instruction (AAI) tables	Charge dollar amounts to specified accounts.
Reports	Print reports listing detailed costs and variances for work orders.

Product Costing and Manufacturing Accounting Integration

Product costing plays a significant role in the manufacturing environment. Before you can implement your Manufacturing Accounting system, you must decide between using either standard cost or actual cost methodology by branch plant. If you choose standard cost methodology, set up frozen standard cost component values for the products you produce. If you choose actual cost methodology, then set up raw material and work center costs, not cost components. To calculate

standard cost component values, you must consider the following aspects in the manufacturing environment:

- Cost reporting (What does the item really cost to produce?)
- Variance reporting (actual versus standard costs)
- Product and job costing (detailed information)
 - Materials
 - Labor
 - Overhead

After you calculate your cost component values in a simulated mode and are satisfied with the results, you must establish frozen standard cost components. If you choose standard cost methodology, then all shop floor transactions use these frozen standards for calculations, which, in turn, create transactions in your general ledger and are the basis of your inventory valuation. If you choose actual cost methodology, then shop floor transaction costs are calculated as they occur. For actual cost, simulation and frozen cost components are not established.

Certain functions within the Product Costing and Manufacturing Accounting systems overlap with other Manufacturing and Distribution systems, such as Product Data Management and Shop Floor Control. Therefore, it is important that you have a basic understanding of the following tables and how they interact with other systems:

- Item Master (F4101)
- Manufacturing Data (F4102)
- Branch/Plant Master (F4102)
- Bill of Material Master (F3002)
- Routing Master (F3003)
- Work Center Master (F30006)

The following illustration demonstrates the interaction of tables within the Product Costing and Manufacturing Accounting systems.

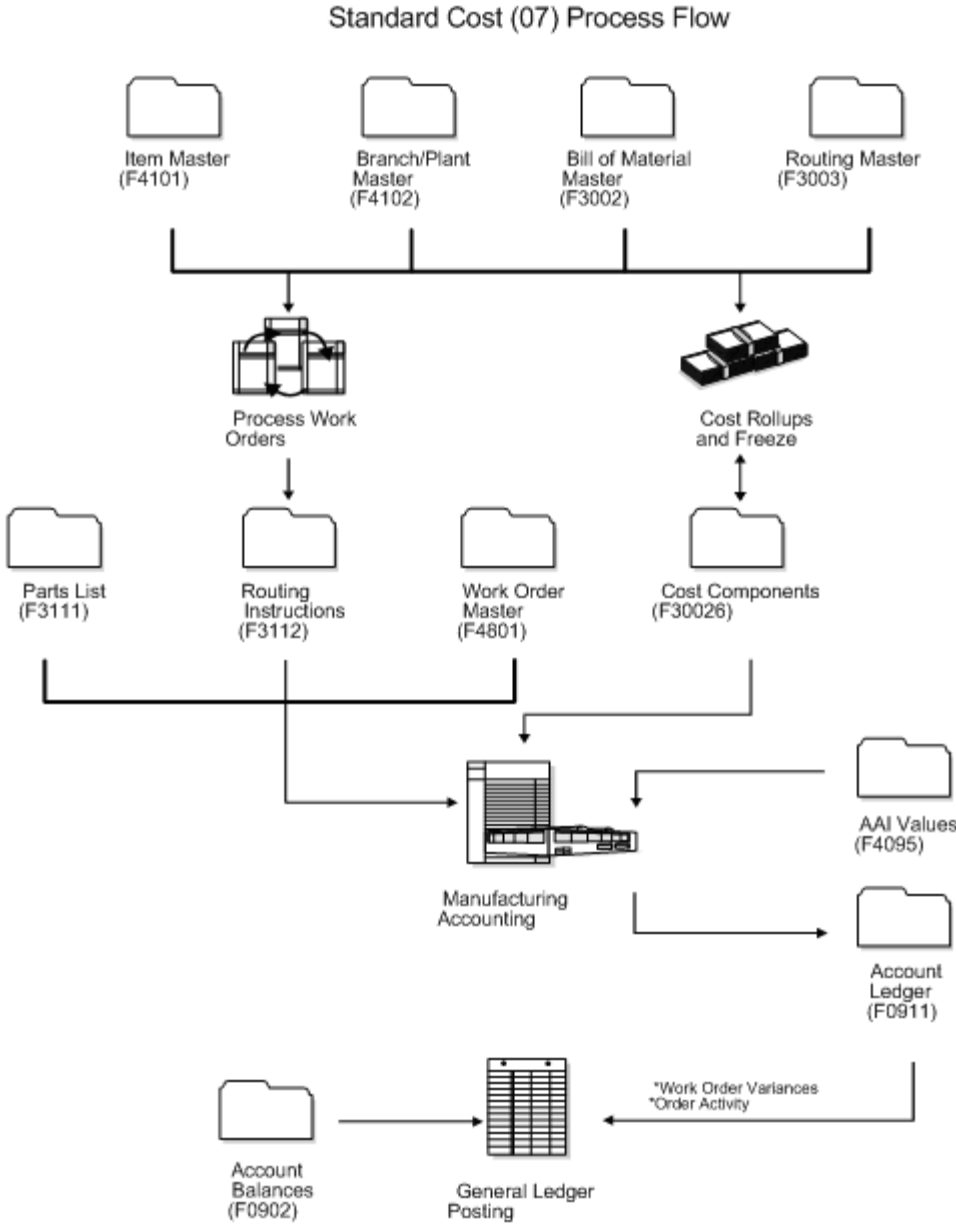

Actual Cost (02) Process Flow

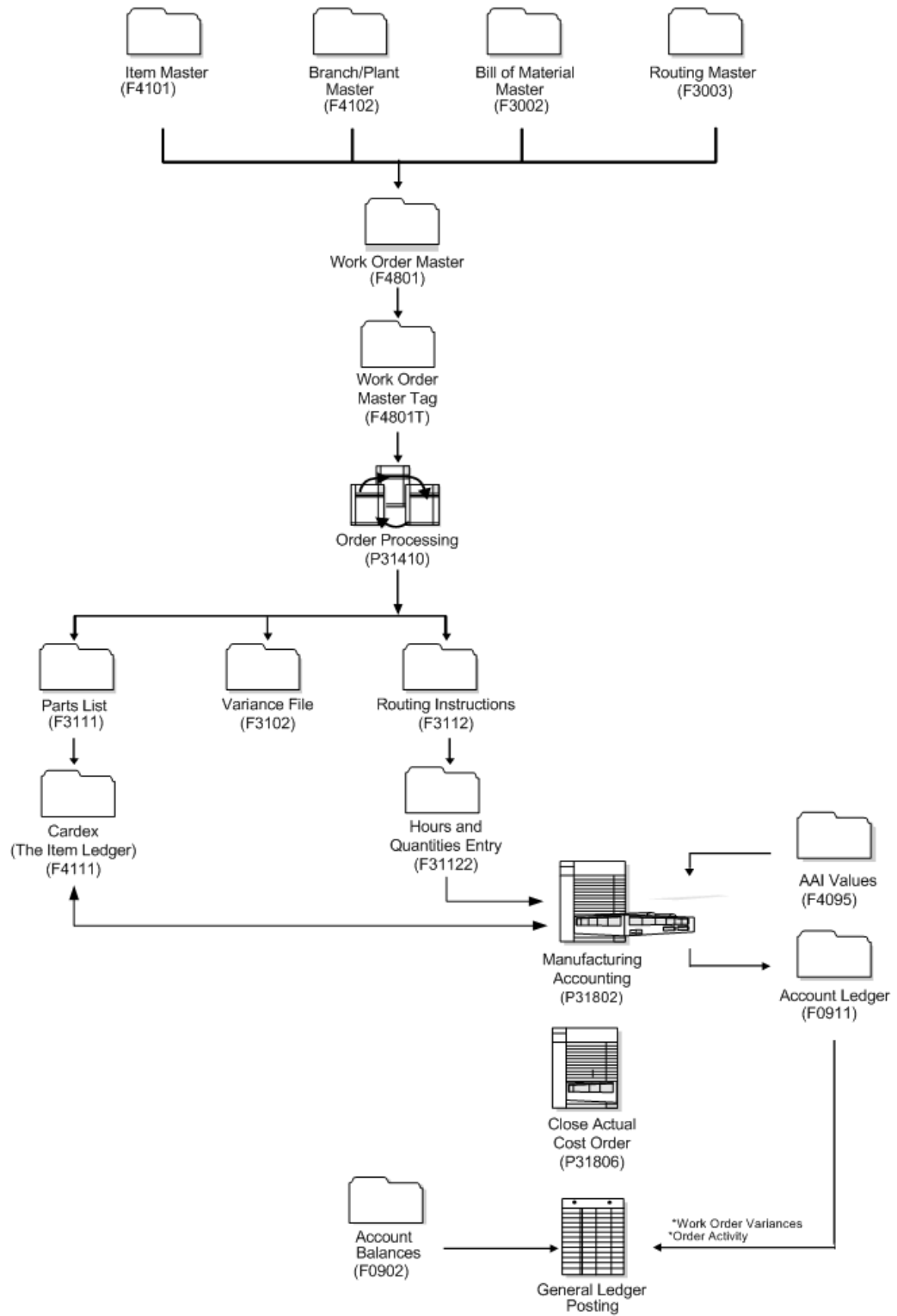

Achieving Effective Cost Management

Most of the major areas or departments within your manufacturing company contribute information to your product costing activities and, therefore, affect the overall accuracy of your manufacturing budget.

The following table lists examples of departments within your company and the aspects of the Product Costing system which are affected by that department.

Department	Description
Design Engineering	<p>The Design Engineering group is responsible for ensuring that:</p> <ul style="list-style-type: none"> ▪ The bill of material is complete ▪ The make-buy information is accurate ▪ The engineering change orders (ECOs) have been taken into account
Sales	<p>The Sales force contributes important information regarding target markets, as well as the latest trends in manufacturing. For effective cost management, it is important that your sales force provide timely and reasonable forecasts.</p>
Manufacturing Engineering	<p>The Manufacturing Engineering group is responsible for identifying:</p> <ul style="list-style-type: none"> ▪ Correct processes ▪ Changes to existing processes ▪ Manufacturing overhead ▪ Accurate information about work centers
Purchasing	<p>The Purchasing department must provide:</p> <ul style="list-style-type: none"> ▪ Accurate supplier costs ▪ Accurate transportation costs
Manufacturing Operations	<p>Manufacturing Operations provides vital information to the product costing effort. For example:</p> <ul style="list-style-type: none"> ▪ Input transaction data in a timely and accurate manner ▪ Identify any discrepancies in the bills of material and routings
Accounting	<p>The Accounting staff must:</p> <ul style="list-style-type: none"> ▪ Ensure that all items have costs ▪ Identify general and administrative overhead ▪ Produce timely variance reports (standard costs versus current costs)

Several other issues should be considered as you define and manage your manufacturing costs, including:

- When (and how often) do you change standard costs?
- How do you limit access to those authorized to change standard costs?
- When are new items reflected in the standard?
- How do you account for labor rates and work center overhead?

You might also encounter these typical circumstances as you define costs and perform rollups:

- Not all standards are available before your initial cost rollup.
- You have used incorrect units of measure.
- Your company inaccurately reports labor hours and costs.
- New products are not updated in a timely manner.
- Standards are updated too frequently.
- Items have been added to or deleted from the bill of material since the last cost update.
- Steps in the routing master have been changed since the last cost update.

Tables

Table	Description
Cost Components (F30026)	Contains all cost methods and cost components for each method for all items. The exception to this is the weighted average cost method 02, which is used for the actual cost methodology.
Cost Ledger (F4105)	Contains the costs of all items.
Manufacturing Constants (F3009)	Stores variables that indicate whether Standard or Actual costs are used and whether to include efficiency and overhead in the cost.
Manufacturing Data (F4102)	Stores the accounting cost quantity, which the system uses to determine the allocation of fixed setup and material costs for an item.
Routing Master (F3003)	Stores routing information, including operation sequence, work center, run time, setup time, and machine time. The system uses this information to calculate labor, machine, and overhead costs.
Bill of Material Master (F3002)	Contains information at the business unit level about bills of material, such as quantities of components. The system uses this information to calculate material costs.
Work Center Rates (F30008)	Contains all rates for each work center, such as overhead and labor.
Work Center Master (F30006)	Contains detailed data about all defined work centers, including efficiency.

Table	Description
Item Ledger (F4111)	Contains IB transactions that indicate changes in inventory value.
Account Master (F0901)	Contains account definitions, including numbers and descriptions.
Account Ledger (F0911)	Contains detailed transactions in the general ledger.
Account Balances (F0902)	Contains net postings for each period and prior year balances (net and cumulative). There is one record per account, ledger type, subledger, fiscal year, and transaction currency table.
User Defined Codes (F0005)	<p>Contains user defined codes and their descriptions. User defined codes in product costing and manufacturing accounting include:</p> <ul style="list-style-type: none"> ▪ Cost methods (40/CM) ▪ Cost components (30/CA) ▪ Cost buckets (30/CB) ▪ Operation buckets (30/CO)
Standard Rate and Factor Codes (F00191)	<p>Contains user-defined rate and factor codes that the system uses in conjunction with the Rate Code and Rate Amount fields to calculate extra costs (electricity, taxes, tooling changes, and so on).</p> <p>To access this table from the P30026 Manufacturing Cost Components screen, select the F21 function key.</p>
Batch Control (F0011)	Contains system-generated batch header information, including the batch number, batch status, and batch entry date.
Automatic Accounting Instruction (AAI) Values (F4095)	Contains account numbers that are used to create journal entries and charge dollars to those accounts.
Work Order Master (F4801)	Contains all work order header information. The data from this table appears on shop floor paperwork. The system updates this table when completion transactions occur against a work order.
Work Order Master Tag (F4801T)	Contains cost ledger information. The data from this table indicates whether standard or actual cost accounting is executed.
Parts List (F3111)	Contains the parts list that is attached to a work order. It contains one record for each part. The system creates this table interactively or when you run the Order Processing program.
Work Order Time Transactions (F31122)	Contains detail records of reported routing transaction activity.

Table	Description
Routing Instructions (F3112)	Contains the routing steps that are attached to a work order. It contains one record for each operation sequence number and work center. The system creates this table interactively or when you run the Order Processing program.
Work Order Variances (F3102)	Contains the amounts used for work order variance calculations. The Order Processing program or interactive attachment initially updates this table followed by the Journal Entries for Manufacturing Accounting program.
Item Master (F4101)	Stores basic information about each defined inventory item, such as item numbers, descriptions, category codes, and units of measure.
Branch/Plant Master (F4102)	Defines and maintains warehouse or plant level information, such as branch level category codes.
Address Book (F0101)	Contains a variety of information, including information about customers, suppliers, employees, and prospects.
Business Unit Master (F0006)	Identifies information about business units, such as company names and category codes assigned to the business unit.
Cost Ledger (F4105)	Contains total costs for each cost method and level for all inventory items. Defines the Sales/Inventory and Purchasing cost method for each item.

Menu Overview

JD Edwards World systems are menu-driven. Menus are organized according to function and frequency of use.

Product Costing

Access Product Costing functions from the Product Data Management menus.

Manufacturing Systems G3
Product Data Management G30



Daily Processes

* Daily Product Costing G3014



Periodic Processes

* Periodic Product Costing G3023

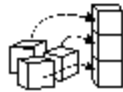

Setup Processes

* Product Costing Setup G3042

Fast Path Commands

The following table illustrates the fast path commands you can use to move among the Product Costing menus.

Command	Menu	Title
DPC	G3014	Daily Product Costing
PPC	G3023	Periodic Product Costing
SPC	G3042	Product Costing Setup

Manufacturing Accounting

Access Manufacturing Accounting functions from the Shop Floor Control menus.

Manufacturing Systems G3
Shop Floor Control G31



Daily Processes

* Daily Manufacturing Accounting G3116



Periodic Processes

* Periodic Manufacturing Accounting G3123

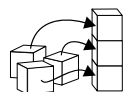

Setup Processes

* Shop Floor Control Setup G3141

Fast Path Commands

The following table illustrates the fast path commands you can use to move among the Manufacturing Accounting menus.

Command	Menu	Title
MA	G3116	Daily Manufacturing Accounting
PMA	G3123	Periodic Manufacturing Accounting
SSFC	G3141	Shop Floor Control Setup

2 Product Costing

Overview to Product Costing

Objectives

- To understand product costing and its overall importance in a manufacturing environment
- To learn about standard, actual and user defined cost methods
- To learn about the differences between frozen and simulated costs

About Product Costing

Working with the Product Costing system consists of the following tasks:

- Reviewing bills of material and routings
- Setting up product costing
- Creating simulated costs
- Working with simulated cost components
- Updating frozen costs
- Reviewing costing information
- Working with additional costing features

What Are Standard Costs?

You can work with a variety of cost methods in the Product Costing system. However, the Manufacturing Accounting system uses the standard cost method (07). This method represents the expected (target) cost of an item for a specific period of time, such as quarterly, semi-annually, or annually.

With standard costing, you estimate costs for each end item assembly and manufactured part on a level-by-level basis before production begins. These cost estimates are based on both past performance and analysis of future conditions.

Standard cost:

Net Added Cost	Total Cost
Includes: <ul style="list-style-type: none"> ▪ Labor ▪ Overhead ▪ Outside Operations ▪ Extra Costs ▪ Materials (for purchased parts only) 	Includes: <ul style="list-style-type: none"> ▪ The item's net added cost ▪ Total cost of lower-level components

The net added cost represents the cost to manufacture an item at this level in the bill of material. For manufactured parts, the cost includes labor, outside operations, and cost extras, but not materials (lower-level items). For purchased parts, the net added cost includes the cost of materials. The total cost of an item represents the sum of the net added cost and all lower-level component item costs.

Why Maintain Standard Costs?

By defining and monitoring product costs, you can measure your company's current manufacturing performance against your standard (target) costs. Product costing provides information about the dollar investments tied to your materials, work in process, and physical inventory. You can use this information to determine pricing on end items and service components.

Simulated Versus Frozen Costs

Simulated costs represent a "what if" analysis for a given cost method. You might want to calculate simulated costs because of changing factors in the business environment, such as labor rates or the cost of raw materials. You can simulate cost change scenarios (rollups) as many times as needed before you finalize the changes.

You finalize the changes by performing a frozen update for the given cost method. A frozen update copies your simulated values and makes them your frozen costs, and updates the Cost Ledger table (F4105) with the total cost. These costs remain in effect until you update them with another frozen update.

You can simulate costs using the standard cost method 07 or any other cost method (other than 02). The Manufacturing Accounting system uses the standard cost method to establish costs for shop floor transactions, unless actual costing is indicated in Manufacturing Constants.

Caution: Do not simulate and freeze the 02 cost method.

What are Actual Costs?

Using an actual cost method to determine ROI, the same data of total parts, machine hours, and labor hours are used. However, instead of using standard costs of labor and machine, actual costs are used.

An important difference from standard costing is how actual costing considers hourly cost of machines and labor. Standard cost is calculated from an hourly cost of machines and labor multiplied by the cycle time of the part. With this calculation, cost absorption is for only that portion of the time when the machine is in use. There is no cost penalty for underutilizing machines and labor. More important, there is no cost benefit for using machines and labor more efficiently. All cost is attached to value-added hours and new machines must show significant reduction in amount of hours to be justified.

In contrast, the actual cost method shows the actual cost of current operations and includes incentive to operate new machines more efficiently. The actual cost of labor is the wage and benefits cost per hour rather than using standard labor hours.

What are Parent Items?

A parent item is a product sold as a completed item or repair part. A parent item is subject to a customer order or sales forecast.

The parent item setup tells the system whether this item will be treated as a standard cost or actual cost item.

- Sales/Inventory Cost Method – The item cost revisions (P4105) sales/inventory cost method is the key field. An actual cost item must have a sales/inventory cost method 02 average cost. The cost method is captured in the LEDG field of the work order tag file (F4801T) when a work order is created and determines whether the work order is treated as standard or actual cost.
- Inventory Cost Level – The inventory cost level 3 (cost by lot/location) can be used for an actual cost item as well as cost level 2. Inventory cost level 3 is not supported for standard cost items.
- Extra Costs (F30026) – Extra costs can be set up for an actual cost item in the P30026 by inputting them on the parent item number. For an actual cost item, input is allowed directly into the frozen cost fields, without running P30835 as required by standard cost.

What Are Cost Components?

Cost components represent the individual costs that make up an item, for example, material, labor, overhead, and extras. Material, labor, and overhead costs are automatically calculated by the system. Extra costs, such as electricity, are manually controlled.

Use cost components to maintain complete item costing information. You can use them to set up simulated cost scenarios to help plan for future cost changes, and to display the simulated or frozen net added and total component costs for any item.

In addition, you can:

- Allow for extra add-on costs related to the manufacturing of a product, such as electricity, insurance, water, or warehouse space.
- Review specific calculations used to determine cost amounts for any item.
- Maintain costs by branch for multi-facility processing. Multi-facility processing allows for different costing values based on regional or business variations.
- Set up costing rates that represent cost elements.
- Define additional cost factors to include in product costing calculations.

Components for an actual cost parent do not have to match the cost method of the parent. Actual cost will use the cost per the sales/inventory cost method for the component from P4105. The P30026 frozen cost is not used by actual cost.

Component cost will be calculated at the time of material issue, so the P4105 cost must be populated before the issues program is run. The user should also keep in mind that the P4105 cost for all subassemblies must be populated before they are issued to the parent as well.

See Also

- *Setting Up Cost Components (P30026)*
- *Assigning Values to User Defined Cost Components (P30026)*

Set Up Product Costing

Setting Up Product Costing

You can customize the Product Costing system to meet your specific manufacturing environment needs. The system uses the values you define to determine your product costs.

This section contains the following:

- [Setting Up Accounting Cost Quantities](#)
- [Setting Up Item Cost Levels](#)
- [Converting Item Cost Levels](#)
- [Setting Up Item Costs](#)
- [Setting Up Cost Components](#)
- [Setting Up Manufacturing Constants for Product Costing](#)
- [Setting Up Simulated Rates for a Work Center](#)
- [Setting Up Actual Rates for a Work Center and Overhead](#)

Setting Up Accounting Cost Quantities



From Inventory Management (G41), choose **Item Revisions**
From Item Revisions (G4112), choose **Manufacturing Data** under the **Item Branch/Plant Information** heading

The system uses accounting cost quantities to determine the allocation of fixed setup costs for an item. Accounting cost quantities represent the most commonly manufactured quantity of a work order for this item. During cost rollup, the system divides the fixed setup costs by the accounting cost quantity you specify to determine a unit setup and fixed cost.

To set up an accounting cost quantity (ACQ)

On Manufacturing Data

Complete or review the following field:

- Accounting Cost Quantity

Field	Explanation
Accounting Cost Qty (ACQ)	An amount that the system uses in the cost rollup program to determine the allocation of setup costs. The system totals the setup costs and divides the sum by this quantity to determine a unit setup cost. The default is 1. The system also uses ACQ as a divisor for fixed material costs in order to derive a per unit value. Since ACQ is a divisor, do NOT set ACQ to zero (0).

Setting Up Item Cost Levels

	<p>From Inventory Management (G41), choose Inventory Master/Transactions From Inventory Master/Transactions (G4111), choose Item Master Information</p>
--	--

The cost level you assign to an item indicates the level at which the system maintains costs. You determine whether the system maintains one overall cost for an item (cost level 1) or a different cost for the item in each branch/plant (cost level 2). The system can also maintain a different cost for each location and lot within a branch/plant (cost level 3). However, in the Product Costing system, costs at cost level 3 are informational only. All items used in a manufacturing environment

should have cost levels of 1 or 2, except configured items, which must be cost level 3. Cost level 3 is recommended for actual cost items (cost method 02).

To set up an item

On Item Master Information

1. Complete or review the following fields:

- Stocking Type
- G/L Class Code
- Line Type
- Unit of Measure
- Inventory Cost Level

2. Choose Manufacturing Values (F10) to display the Plant Manufacturing Data screen.

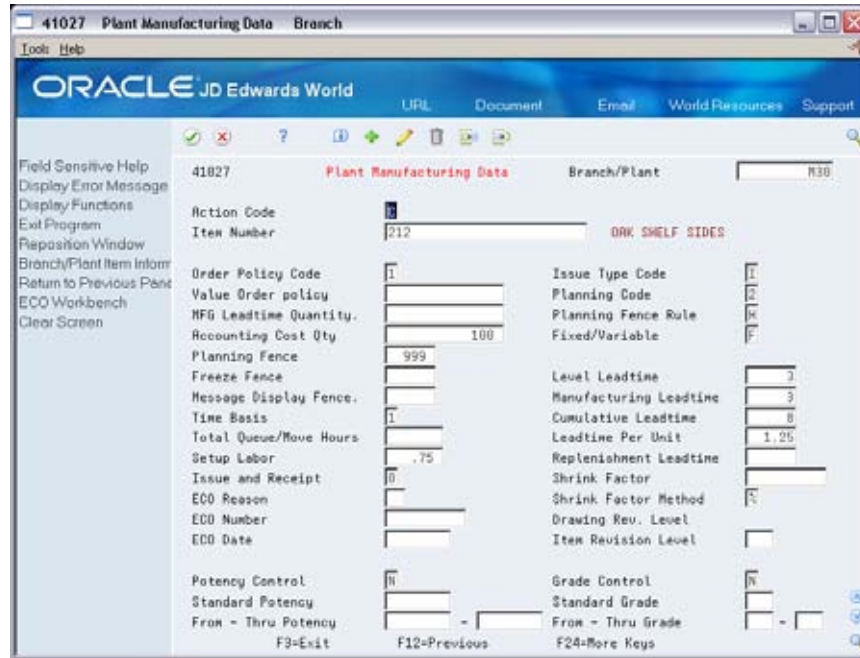

3. Complete or review the following field:

- Accounting Cost Qty

Field	Explanation
Stocking Type	Stocking types are found in UDC Table 41/1. Product costing looks at the corresponding second description for "M" or "P" in this table. If the second description is "P", the cost in F4105 will be used. If the second description is "M", there must be a Bill of Material (BOM) and or Routing from which costs can be calculated.
G/L Class Code	G/L posting codes are setup in the UDC Table 41/9. G/L Class code is one of the keys to the product costing and manufacturing accounting AAI tables. It is the only key that is item specific and can be used to point journal entries associated with the item to specific object accounts in the general ledger. The G/L Class code will default to the Item Branch/Plant (BP) record, and from the Item BP record to the primary location in the item location record. This primary location in the item location record is where manufacturing costing and accounting will look to find the G/L Class code for the item.
Line Type	Line Types control how lines in a transaction are processed and the systems with which the transaction interfaces – G/L, AP, AR, Inventory Management, etc.

Field	Explanation
Unit of Measure	<p>The primary unit of measure MUST be the smallest unit of measure.</p> <p>Units of Measure to consider for manufacturing are:</p> <ul style="list-style-type: none"> ▪ Production ▪ Component <p>Set up all units of measure to convert to the primary unit of measure (UOM) in the Unit of Measure Conversion table. The Simulated Rollup will write item costs to the F30026 in the primary unit of measure. The F4105 costs are also maintained in the primary UOM.</p>
Inventory Cost Level	<p>A code that indicates whether the system maintains one overall inventory cost for the item, a different cost for each branch/plant, or a different cost for each location and lot within a branch/plant. The system maintains inventory costs in the Cost Ledger table (F4105).</p> <p>Valid codes are:</p> <ol style="list-style-type: none"> 1 Item level (The item will have only one F4105 record. Every Branch/Plant and every location will use the same F4105 record.) 2 Item/Branch level (For every item Branch/Plant, there is a unique or separate item cost. If there are two branch/plants, then the F4105 will have two F4105 records.) 3 Item/Branch/Location level (Not recognized by the Manufacturing system, except for configured and actual cost items.)
Accounting Cost Qty	<p>Product costing uses this quantity as the standard quantity produced. Since the ACQ is considered the standard quantity, the Simulated Rollup will look for a batch BOM and a batch routing that match the ACQ to use for the cost simulation.</p> <p>If there is no matching BOM, or routing, the 0 (zero) quantity BOM and routing will be used to calculate standard cost. A zero or blank on the BOM or routing represents the amount of components needed to make one item.</p> <p>Setup costs (B2) are divided by the ACQ to determine a per unit setup cost.</p> <p>This value cannot be zero or blank.</p>

Converting Item Cost Levels



From Inventory Management (G41), enter 27
From Inventory Advanced & Technical Ops (G4131), choose Item Cost Level Conversion

After you have entered cost information, you might need to change an item's cost level. You must use the Item Cost Level Conversion program to change an item's cost level after cost information has been entered.

If you run this program, it deletes all existing cost records for the item in the Cost Ledger table (F4105) and creates new cost records that correspond to the level. The system uses the sales/inventory cost method for the item to create the new cost records.

The program does not change the cost valuation of items and does not create journal entries. For example, if you change an item's cost level from branch/plant and location to branch/plant, all existing cost records for the branch/plant and location must contain the same sales/inventory cost method and cost.

You can run Item Cost Level Conversion in proof mode or final mode. When you run the program in proof mode, the system generates the Item Cost Level Conversion report, showing errors that need correction. You should always run the program in proof mode first and correct any discrepancies.

When you run the program in final mode, the system updates the following tables:

- Inventory Cost Level field in the Item Master (F4101)
- Cost Ledger (F4105)

Caution: Changing your item cost levels changes data throughout the system. You should restrict access to this program.

Before You Begin

- Back up your data tables completely before you begin the data conversion process. If the results of the conversion are unsatisfactory, you can use the backup tables to restore data tables to their original format.
- Verify that no users are accessing the Item Master or Cost Ledger tables when this program is running in final mode.

41815		JD Edwards World			Page	-	2
		Item Cost Level Conversion			Date	-	4/10/17
*** Proof Mode ***							
Item Number	Branch	Location	Lot	L CM	Unit Cost	Remark	
E001	30			3 01	6.6378	Basing comparison on this record	
E001	30	DAMAGED		3 01	6.4100	Cost not the same	
P002	10			3 01	30.7500	Basing comparison on this record	
P002	10	1 B 1		3 02	30.3750	Costing Method/Cost not the same	
P002	20			3 01	31.4333	Basing comparison on this record	
P002	20	1 B 1		3 02	30.8417	Costing Method/Cost not the same	
P002	30			3 01	30.1049	Basing comparison on this record	
P002	30	1 B 1		3 02	30.2500	Costing Method/Cost not the same	
P002	40			3 02	30.5610	Basing comparison on this record	
P002	40	D		3 02	30.2500	Cost not the same	
P002	40	R		3 02	30.2500	Cost not the same	
P002	40	1 B 1		3 02	30.2500	Cost not the same	
P002	40	3 E		3 02	30.2500	Cost not the same	
TS002	10			3 01	43.1200	Basing comparison on this record	
TS002	10	1 C 1		3 02	43.5000	Costing Method/Cost not the same	
TS002	20			3 01	43.1200	Basing comparison on this record	
TS002	20	1 C 1		3 02	43.5000	Costing Method/Cost not the same	
TS002	30			3 01	66.0000	Basing comparison on this record	
TS002	30	1 C 1		3 01	43.9573	Cost not the same	
TS002	40			3 02	43.7336	Basing comparison on this record	
TS002	40	R		3 02	43.5000	Cost not the same	
TS002	40	1 C 1		3 02	43.5000	Cost not the same	
TS002	40	2 C 1		3 02	43.5000	Cost not the same	
V001	10			3 01	16.1500	Basing comparison on this record	
V001	10	1 A 1	9310140004	3 01	16.0000	Cost not the same	
V001	10	1 A 2	9310140002	3 01	16.0000	Cost not the same	
V001	20			3 01	16.1500	Basing comparison on this record	
V001	20	1 A 1	9310140005	3 01	16.0000	Cost not the same	
V001	20	1 A 2	9310140003	3 01	16.0000	Cost not the same	
V001	30			3 01	16.1500	Basing comparison on this record	
V001	30	1 A 1	00000006	3 01	16.0000	Cost not the same	
V001	30	1 A 2	00000005	3 01	16.0000	Cost not the same	
V001	40			3 02	16.1455	Basing comparison on this record	
V001	40	D	00000007	3 02	16.0000	Cost not the same	
V001	40	R	00000007	3 02	16.0000	Cost not the same	
V001	40	1 A 1	00000007	3 02	16.0000	Cost not the same	
V001	40	1 A 2	00000007	3 02	16.0000	Cost not the same	
V001	40	3 F	00000007	3 02	16.0000	Cost not the same	

See Also

- *Setting Up Item Cost Levels (P4101)*

Processing Options

See [Item Cost Level Conversion \(P41815\)](#).

Setting Up Item Costs

You must provide cost information for each of your items for the system to track inventory costs. You specify the cost method that the system uses to determine an item's cost for:

- Sales/inventory transactions
- Purchase orders

For example, in a distribution environment, you can have the system use the weighted average cost method to determine the inventory cost for an item and use the last-in cost method to determine the item's unit cost for purchase orders. In a manufacturing environment, you must choose between Standard (07) and Weighted Average (02) cost methods to determine the inventory cost.

For each cost method you assign to an item, you must also specify a cost. For example, to use the last-in cost method for an item, you must enter an initial cost for that cost method. The system updates the last-in cost based on the cost of the item as of the last receipt date.

For purchased items and outside operations, the main inputs to product costing are entered on Cost Revisions or Cost Components.

To set up item costs, complete the following tasks:

- Set up new cost methods
- Assign cost methods

See Also

- *Updating Product Costs*

To set up a new cost method

You can set up user-defined codes (40/CM) to define your own cost methods. For example, you might want to establish a cost method to maintain a history of last year's costs. Codes 01 through 08 are hard-coded and cannot be altered. Codes 09 through 19 are reserved for JD Edwards World use.

On General User Defined Codes

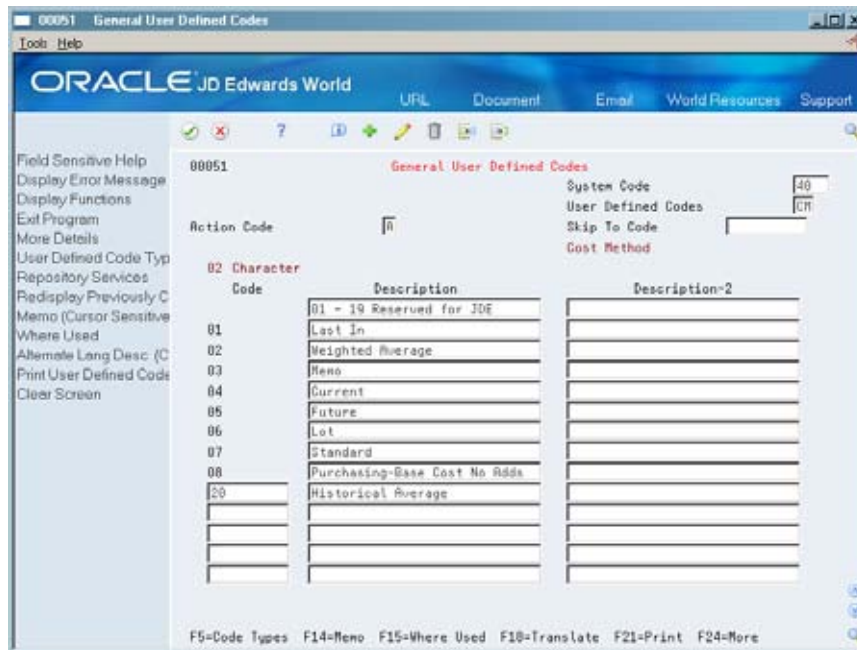

Complete the following fields:

- Code
- Description
- Description-2

Field	Explanation
Code	This column contains a list of valid codes for a specific user-defined code list. The number of characters that a code can contain appears in the column title.
Description	A user-defined name or remark.
Description-2	Additional text that further describes or clarifies a field in JD Edwards World systems.

What You Should Know About

Code	This code defines cost methods that are used in the cost rollup and assigned to items. This is a two-character, alphanumeric field.
Description 1	Identifies the cost method.
Description 2	Identifies additional information about the cost method.

To assign cost methods

	From Product Data Management (G30), choose Daily Product Costing From Daily Product Costing (G3014), choose Enter/Change Item Costs
---	--

Each time you add an item on this form, the program displays all cost methods set up in the user defined code table 40/CM. This includes eight predefined methods that the program provides and any additional methods you create. You specify which methods to apply to an item by assigning a unit cost for each method.

On Cost Revisions

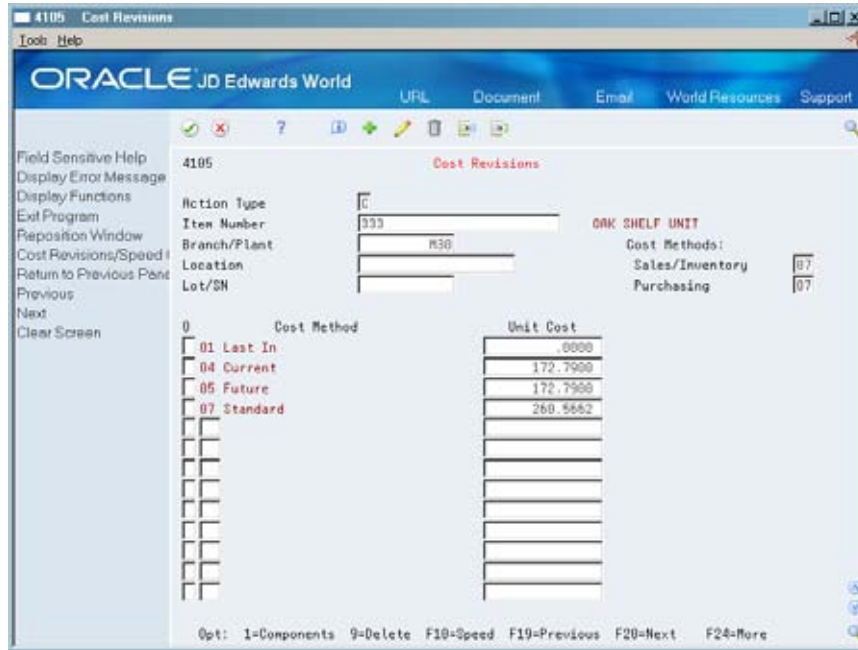

1. Complete the following field for each applicable cost method:
 - Unit Cost
2. Enter the appropriate cost methods in the following fields:
 - Sales/Inventory
 - Purchasing

Field	Explanation
Unit Cost	<p>Depending on the cost method, this data can come from various sources, for example, purchasing or the cost update.</p> <p style="text-align: center;"><i>Form-specific information</i></p> <p>The cost for one unit of this item, based on the corresponding cost method in the primary unit of measure.</p>
Sales/Inventory	<p>A code (table 40/CM) that indicates the cost method that the system uses to calculate the cost of goods sold value for the item. Cost methods 01-08 are hard-coded.</p> <p style="text-align: center;"><i>Form-specific information</i></p> <p>If you maintain costs at the item level, the system retrieves the default value for this field from the data dictionary. If you maintain costs at the item and branch/plant level, the system retrieves the default value from Branch/Plant Constants.</p>

Field	Explanation
Purchasing	<p>A code (table 40/CM) that indicates the cost method that the system uses to determine the cost of the item for purchase orders. Cost methods 01-08 are hard-coded.</p> <p style="text-align: center;"><i>Form-specific information</i></p> <p>If you maintain costs at the item level, the system retrieves the default value for this field from the data dictionary. If you maintain costs at the item and branch/plant level, the system retrieves the default value from Branch/Plant Constants.</p>

What You Should Know About

Assigning a cost method without specifying a cost

If you assign a cost method for sales/inventory or purchasing that is not set up with a cost amount, a warning message appears. If you do not enter a cost amount for the cost method, the system assigns a zero cost.

Changing unit costs

You can change the dollar amount for any cost method at any time. If you change the amount for the cost method you use to track costs of goods sold, the system applies the new amount to your on-hand quantity of the item. It also creates journal entries to account for the difference between the old and the new amounts.

Updating unit costs

Certain programs update the dollar amount for cost methods 01-08. For example:

- Last-in method – The system interactively updates this unit cost based on the last cost of the item at the time of a purchase order receipt or after an inventory adjustment.
- Weighted average method – The system calculates and updates this amount by adding transaction quantities, adding transaction costs, and dividing the total cost by the total quantity.
- Purchase method – Same as last-in method, but without landed costs.
- Standard, current, and future methods – Updated by the Frozen Update program.

If you include additional costing methods, you must update them manually.

Removing a cost method

You can remove a cost method for an item if it is no longer applicable. If you try to remove your sales/inventory or purchasing cost method, the system displays a warning message. The system does not delete the cost method, but updates it to a zero cost.

Processing Options

See [Item Cost Revisions \(P4105\)](#).

Setting Up Cost Components

Use cost components to identify and track each element or type of cost for an item. Cost components that begin with A, B, and C are hard-coded by JD Edwards World and cannot be changed. You can define an unlimited number of additional cost components to account for extra costs for an item, such as electricity or research and development. These user defined cost components can begin with any letter except A, B, or C. JD Edwards World recommends, but does not require, that you use cost component D for outside operations. You can assign separate cost components by categories that are applicable to your business.

Note: Although it might appear that you can set up extra cost components that begin with A, B, or C, the Simulate Cost Rollup program actually deletes these cost components. JD Edwards World recommends that you define extra costs with an “X” for easy identification.

See Also

- *Assigning Values to User Defined Cost Components (P30026)*
- *Appendix A – Calculations in Cost Rollup*

To set up a cost component

On General User Defined Codes

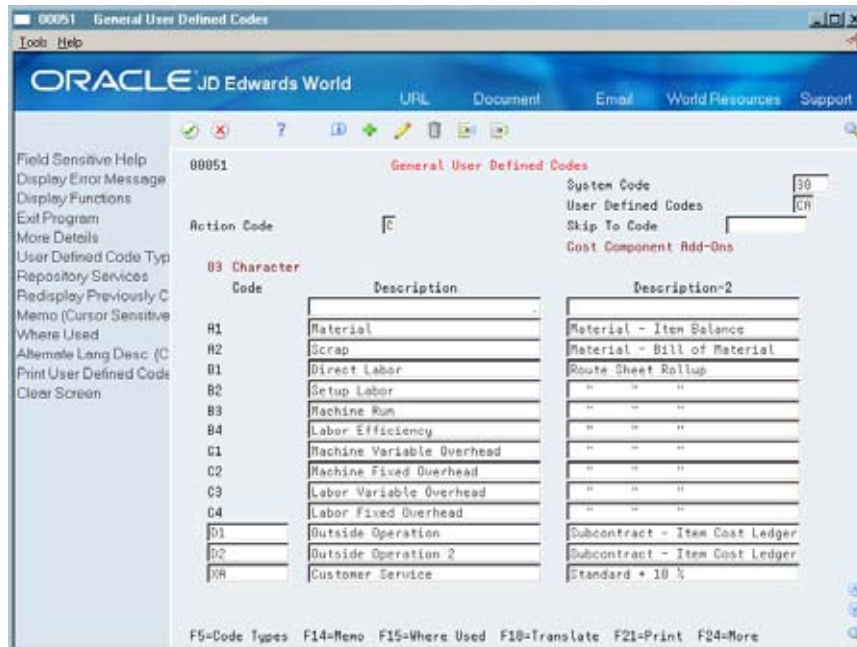

Complete the following fields:

- Code
- Description
- Description-2

Field	Explanation
Code	<p>This column contains a list of valid codes for a specific user defined code list. The number of characters that a code can contain appears in the column title.</p> <p>Use this code to identify all of the possible cost components that can be used in the cost rollup for an item.</p>
Description	A user defined name or remark that identifies what each cost component represents.
Description-2	Additional text that further describes or clarifies a field in JD Edwards World systems.

Setting Up Manufacturing Constants for Product Costing

	<p>From Product Data Management (G30), enter 29 From Product Data Management Setup (G3041), choose Manufacturing Constants</p>
--	--

You must establish information that is unique to your branch/plant. Use manufacturing constants to set options that determine:

- Overhead types to be included in the cost rollup and how to calculate overhead costs
- Whether to consider work center efficiency when calculating direct labor and overhead
- Whether overheads are calculated as percents or rates

Note: If you select to modify cost by Work Center Efficiency, the system creates B4 in the Simulation Rollup. Also, overheads calculated as percents or rates determine how the Overhead cost components (C1 – C4) are expressed in the Work Center Rate Revisions.

See Also

- Setting Up Manufacturing Constants (P3009) in the Product Data Management Discrete Manufacturing Guide

To set up manufacturing constants for Product Costing

On Manufacturing Constants

The screenshot shows the 'Manufacturing Constants' form in Oracle JD Edwards World. The form is titled '3089 Manufacturing Constants' and is for the 'R30 Memphis Mfg. Plant'. The form contains several sections of settings:

- Action Code:** 1
- Branch:** R30 Memphis Mfg. Plant
- Log Bill of Material Changes:** N
- On-Line BOM Validation (Y/N):** Y
- Log Quality Management Changes:** N
- Overheads as Percents or Rates:** P
- Modify cost by Work Center Eff:** Y
- Include Efficiency in Overhead:** Y
- Include Var. Labor Overhead in cost:** Y
- Calculate Var. on Direct Labor:** Y
- Calculate Var. on Setup Labor:** Y
- Include Fixed Labor Overhead in cost:** Y
- Calculate Fixed on Direct Labor:** Y
- Calculate Fixed on Setup Labor:** Y
- Include Var. Machine Overhead in cost:** Y
- Include Fixed Machine Overhead in cost:** Y
- Backflush Options:** N
- Master Routings (Y/N):** N
- Commitment Control:** S
- Hard/Soft Commit:** S
- Percent Bill Validation:** S
- Status for Changes:** 90
- Work Hours Per Day:** 8.00
- Hours:** 8.00
- Shift Code / Desc.:** []
- Actual Costing Only:** Y
- Labor Rate Source:** []
- Machine Rate Source:** []

Complete the following fields:

- Overheads as Percents or Rates
- Modify cost by Work Center Efficiency
- Include Work Center Efficiency in Overhead
- Include Variable Labor Overhead in Cost
- Calculate Variable on Direct Labor
- Calculate Variable on Setup Labor
- Include Fixed Labor Overhead in Cost
- Calculate Fixed on Direct Labor
- Calculate Fixed on Setup Labor
- Include Variable Machine Overhead in Cost
- Include Fixed Machine Overhead in Cost

Field	Explanation
Overheads as Percents or Rates	<p>Determines how values for overhead fields (cost components C1 through C4) in the Work Center Rate Revisions table (F30061) are expressed. Valid codes are:</p> <p>R Express overhead values as rates (currency values). For example, enter five dollars as 5.00.</p> <p>P Express overhead values as percents. Enter percents as whole numbers. For example, enter five percent as 5.00.</p>
Modify cost by Work Center Eff	<p>Controls whether the cost rollup creates cost component B4 (for labor efficiency) based on the direct labor value (cost component B1) and the Work Center Efficiency percent from the Work Center Revisions table (F3006). Valid values are:</p> <p>Y Yes. Create cost component B4.</p> <p>N No. Do not create cost component B4.</p>
Include Efficiency in Overhead	<p>If you specified that you want to modify costs by work center efficiency, this field determines whether the cost rollup includes work center efficiency when calculating overhead values. Valid values are:</p> <p>Y Include work center efficiency.</p> <p>N Exclude work center efficiency.</p>
Include Var. Labor Overhead in cost	<p>Controls whether the cost rollup creates cost component C3 (for variable labor overhead) in the Cost Components table (F30026). Valid values are:</p> <p>Y Yes. Create cost component C3.</p> <p>N No. Do not create cost component C3.</p>
Calculate Var. on Direct Labor	<p>Determines whether the cost rollup includes direct labor expenses (cost component B1) in the total used to calculate variable labor overhead (cost component C3). Valid values are:</p> <p>Y Include direct labor expenses.</p> <p>N Exclude direct labor expenses.</p>
Calculate Var. on Setup Labor	<p>Determines whether the cost rollup includes setup labor expenses (cost component B2) in the total used to calculate variable setup overhead (cost component C3). Valid values are:</p> <p>Y Include setup labor expenses.</p> <p>N Exclude setup labor expenses.</p>
Include Fixed Labor Overhead in cost	<p>Controls whether the cost rollup creates cost component C4 (for fixed labor overhead) in the Cost Components table (F30026). Valid values are:</p> <p>Y Yes. Create cost component C4.</p> <p>N No. Do not create cost component C4.</p>

Field	Explanation
Calculate Fixed on Direct Labor	Determines whether the cost rollup includes direct labor expenses (cost component B1) in the total used to calculate fixed labor overhead (cost component C4). Valid values are: Y Include direct labor expenses. N Exclude direct labor expenses.
Calculate Fixed on Setup Labor	Determines whether the cost rollup includes setup labor expenses (cost component B2) in the total used to calculate fixed setup overhead (cost component C4). Valid values are: Y Include setup labor expenses. N Exclude setup labor expenses.
Include Var. Machine Overhead in cost	Controls whether the cost rollup creates cost component C1 (for variable machine overhead) in the Cost Components table (F30026). Valid values are: Y Yes. Create cost component C1. N No. Do not create cost component C1.
Include Fixed Machine Overhead in cost	Controls whether the cost rollup creates cost component C2 (for fixed machine overhead) in the Cost Components table (F30026). Valid values are: Y Yes. Create cost component C2. N No. Do not create cost component C2.

What You Should Know About

Overhead Rates

Overhead rates are established in the Manufacturing Constants by selecting the type costs that will be included.

Labor Rates

Actual cost allows two choices for the source of labor rates in the Manufacturing Constants. Standard cost will not read this option, but will continue to use frozen 07 work center rates as the source for labor rates.

- Source Type 1 - Frozen work center rates for cost method 02 from the Work Center Rates Table (F30008). Navigation: G3014 number 4.
- Source Type 2 - Employee labor rates from the Employee Labor Rates Table (F00191). Navigation: G3141 number 11.

Machine Rates

The source for machine rates for an actual cost item can come from one of two choices in Manufacturing Constants. Standard cost will not read this option, but will continue to use frozen 07 work center rates as the source for labor rates.

- Source Type 1: Frozen work center rates for cost method 02 from the Work Center Rates Table (F30008). Navigation: G3014 number 4.
- Source Type 2: Equipment Rental Rate table (F1301). Navigation: G1343 number 4

The default for both labor and machine rates is the work center rate.

Setting Up Simulated Rates for a Work Center



From Manufacturing Systems (G3), choose **Product Costing**
From Product Costing (G3014), choose **Enter/Change Work Center Rate**

You can effectively manage changes to a work center by tracking rates for labor and machine costs. You can update simulated rates for machine and labor hours by work center and cost method. The system uses these values in other manufacturing calculations, such as costed routings, labor rate variance reports, and direct labor efficiency reports.

Each operation sequence in the routing is associated with a work center. The number of people who work in a work center (crew size), although not directly used in product costing, will default into the routing.

Standard Costing uses frozen (07) work center rates. Standard work center rates are set up for each work center by keying in simulated costs for all categories, including labor, overhead and machine.

Work Center rates are then frozen when you run the Frozen Update (P30835) with the processing option for Update Work Center Rates turned on.

Work Centers can have rates for both the standard and actual cost methods by entering simulated costs in the Work Center rates, and selecting the cost method in the Frozen Update processing options.

Work Center rates can be frozen independent of an item by using the Freeze Work Center Rates program (P30860).

Before You Begin

- You must set up your work centers on Enter/Change Work Centers before you can assign rates. See *Entering Work Centers* in the *Product Data Management Discrete Manufacturing Guide* for complete information on setting up work centers.

See Also

- Entering Costing and Accounting Information (P30061) in the Product Data Management Discrete Manufacturing Guide

To set up simulated rates for a work center

On Enter/Change Work Center Rate

Complete the following fields:

- Work Center
- Cost Method
- Simulated Direct Labor
- Simulated Setup Labor
- Simulated Labor Variable Overhead
- Simulated Labor Fixed Overhead
- Simulated Machine Run
- Simulated Machine Variable Overhead
- Simulated Machine Fixed Overhead

Field	Explanation
Work Center	A number that identifies a branch, plant, work center, or business unit.

Field	Explanation
Cost Method	A user defined code (system 40, type CM) that identifies a cost method. Cost methods 01 through 08 are hard-coded. <i>Form-specific information</i> This code was entered on Branch/Plant Constants.
Direct Labor	This rate, in cost per hour, is the rate used to calculate the current labor cost as of the last simulation and update.
Setup Labor	This rate, in cost per hour, is the rate used to calculate the current setup labor cost as of the last simulation and update.
Labor Var. Overhead	This rate, in cost per hour or percent of labor, is the rate used to calculate the current variable labor overhead cost as of the last simulation and update.
Labor Fixed Overhead	This rate, in cost per hour or percent of labor, is the rate used to calculate the current fixed labor overhead cost as of the last simulation and update.
Machine Run	This rate, in cost per hour, is the rate used to calculate the current machine cost as of the last simulation and update.
Machine Var. O/H	This rate, in cost per hour or percent of labor, is the rate used to calculate the current variable machine overhead cost as of the last simulation and update.
Machine Fixed O/H	This rate, in cost per hour or percent of labor, is the rate used to calculate the current fixed machine overhead cost as of the last simulation and update.

Setting Up Actual Rates for a Work Center and Overhead

The frozen work center rates (F30008) are maintained for actual cost by entering 02 cost method rates for the work center in the F30008 and running the frozen update P30835 or the Freeze Work Center Rates program (P30860). Standard cost 07 and actual cost 02 rates can all be maintained for the same work center. The system uses the rates for the cost method of the parent item to calculate work order cost.

The actual cost Work Order Overhead Rates (F30006) are calculated using the rates or percentages found in the Work Center Rates Table (F30006) for the cost method of the parent item.

Review Bills of Material and Routings

The bill of material and routing for an item contain important information that affects costing.

This section contains the following:

- [Reviewing Bills of Material and Routings for Product Costing](#)
- [Reviewing Product Costing in Bills of Material](#)
- [Reviewing Routings for Product Costing](#)

Reviewing Bills of Material and Routings for Product Costing

To ensure that bill and routing information is set up correctly:

- Review product costing in bills of material
- Review routings for product costing

Reviewing Product Costing in Bills of Material



From Product Data Management (G30), choose **Daily PDM Discrete**
From Daily PDM Discrete (G3011), choose **Enter/Change Bill**

Review your bills of material to understand the bills' input to your material product costs. Only items with a bill type of M are costed.

Field	Explanation
Bill Type	Simulated Rollup will only cost an "M" type BOM. Alternate bills (BOMs) can be used but "M" is recognized as the standard.

Field	Explanation
Batch Quantity	<p>Batch quantities are used when there are physical constraints on a manufacturing process or items must be produced in certain quantities. The batch BOM that matches the ACQ is recognized as the standard batch size and is used by the Simulated Rollup program.</p> <p>Note: If the Batch quantity does not match the ACQ, the Simulated Rollup program will look for a 0 (zero) quantity BOM.</p> <p>Material costs (A1) will not roll if the batch quantity does not match the ACQ and if there is not a 0 (zero) batch quantity BOM.</p>
Feature Cost and Feature Planned %	<p>These fields are in the bill specifically for Kit and Planning Bills, but they affect all types of bills. Costing will be adjusted by the feature cost % if it is anything other than 100%.</p>
Fixed/Variable	<p>If a fixed quantity is used on the BOM, Simulated Rollup will divide the fixed amount by the ACQ to calculate the per unit cost. Fixed quantity components are not extended by the work order quantity.</p>
Component Branch/Plant	<p>The system defaults the Branch Plant entered on the Bill of Material header into this field. You can also change this field manually.</p>
Percent of Scrap	<p>This percent is a whole number entered directly onto the BOM. The amount of material required is increased by the scrap percent and therefore increases cost if there is a value. This additional material will generate an Scrap (A2) cost in the Simulated Rollup. Scrap costs require component scrap to be recorded via Component Scrap P31116.</p>
Operation Scrap %	<p>Operational scrap % is populated by the yield % in the routing. The material required is increased by this percentage. Operation scrap % does not generate A2 cost.</p>
Additional Information about the BOM	<p>Dates for all components should be "in effect" to be included in the cost rollup.</p>

See Also

- *Working with Bills of Material (P3002) in the Product Data Management Discrete Manufacturing Guide*

To review bill of material information

On Enter/Change Bill

Component Item	Description	Quantity Per	UM	V	I
012	ORAK SHELF SIDES	2	EA	V	I
121	ORAK SHELF TOP/BOTTOM	2	EA	V	I
424	ORAK SHELVES	4	EA	V	I
444	ORAK SHELF CABINET INSERT ASS	1	EA	V	I
123	HARDWARE KIT	1	EA	V	I
122	BULK HARDWARE	12	EA	V	I

1. Review the following fields:
 - Component Item
 - Quantity Per
 - Unit Of Measure
 - Fixed or Variable
2. Access the detail area (F4).

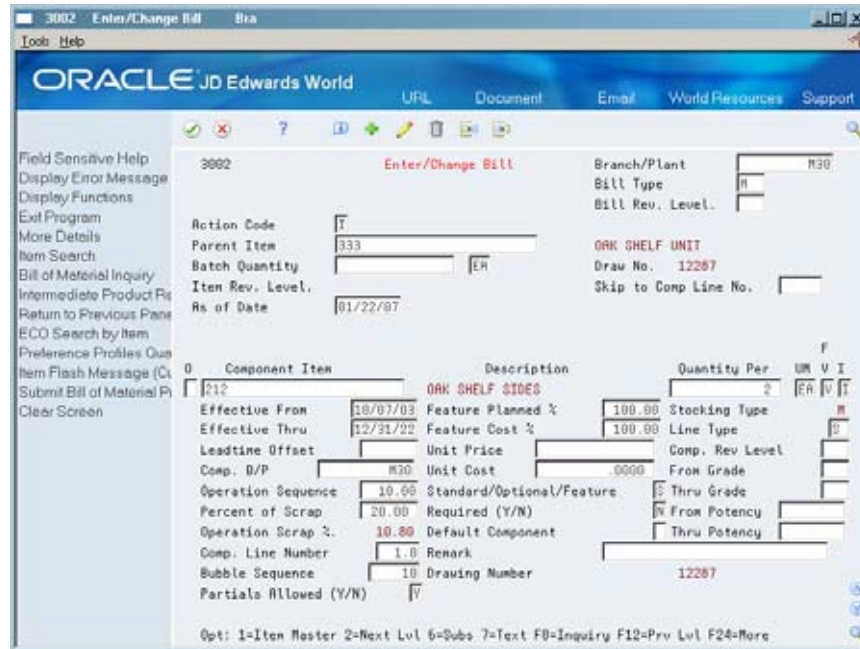

3. Review the following fields:

- Feature Cost Percent
- Percent of Scrap
- Operation Scrap Percent

Field	Explanation
Parent Item	A number that the system assigns to an item. It can be in short, long, or 3rd item number format. <i>Form-specific information</i> The Parent Item field contains the item number of the item to be manufactured.
Component Item	This field contains the item number of the item(s) that are required to make the parent item.
Batch Quantity	A frequently manufactured quantity of the parent item in the production unit of measure.
Quantity Per	The number of units to which the system applies the transaction. <i>Form-specific information</i> A number that indicates how many components you use to manufacture the parent item. A quantity of zero is valid. The default value is 1.
UM (Unit of Measure)	The default value coming from the component unit of measure in the Item Master table.

Field	Explanation
F V	<p>Indicates if the quantity per assembly for an item on the bill of material varies according to the quantity of the parent item produced or is fixed regardless of the parent quantity. This value also determines if the component quantity is a percent of the parent quantity. Valid values are:</p> <p>F Fixed Quantity</p> <p>V Variable Quantity (Default)</p> <p>% Quantities are expressed as a percentage and must total 100%</p> <p>For fixed quantity components, the Work Order and MRP systems do not extend the component's quantity per assembly value by the order quantity. ACQ is used as a divisor by the cost rollup for fixed components.</p> <p>For Process Manufacturing, the system stores percent components. Therefore, the system treats zero batch sizes like variable quantity components, and treats batch sizes greater than zero like fixed quantity components.</p>
Feature Cost %	<p>A percentage used by the Simulate Cost Rollup program to calculate the cost of a feature or option item as a percentage of the total cost of the parent.</p> <p>Enter the percentage as a whole number: 5% as 5.0.</p>
Percent of Scrap	<p>Scrap is the percentage of unusable component material created during the manufacture of a particular parent item. During DRP/MPS/MRP generation, the system increases gross requirements for the component item to compensate for the loss.</p> <p>Note: Shrink is the expected loss of parent items (and hence, components) due to the manufacturing process. Shrink and scrap are compounded to figure the total loss in the manufacture of a particular item. Accurate shrink and scrap factors can help to produce more accurate planning calculations.</p> <p>Enter percents as whole numbers: 5% as 5.0.</p> <p style="text-align: center;"><i>Form-specific information</i></p> <p>The Shop Floor Control and Material Requirements Planning systems inflate component requirements by this percentage. This scrap percent is unique to the relationship of one parent and one component.</p>
Operation Scrap %	<p>The system uses this value to increase or decrease the amount of materials to account for loss within the operation. The system updates this value on Enter/Change Bill of Material when you run the Planned Yield Update program. The system calculates this value by compounding the yield percentages from the last operation to the first operation. Use a processing option in Enter/Change Routing to enable the system to calculate the component scrap percent.</p>

Reviewing Routings for Product Costing

	From Product Data Management (G30), choose Daily PDM Discrete From Daily PDM Discrete (G3011), choose Enter/Change Routing
---	---

Review your routings to understand their input to your labor and overhead costs.

See Also

- Working with Routings (P3003) in the Product Data Management Discrete Manufacturing Guide

To review routing information

On Enter/Change Routing

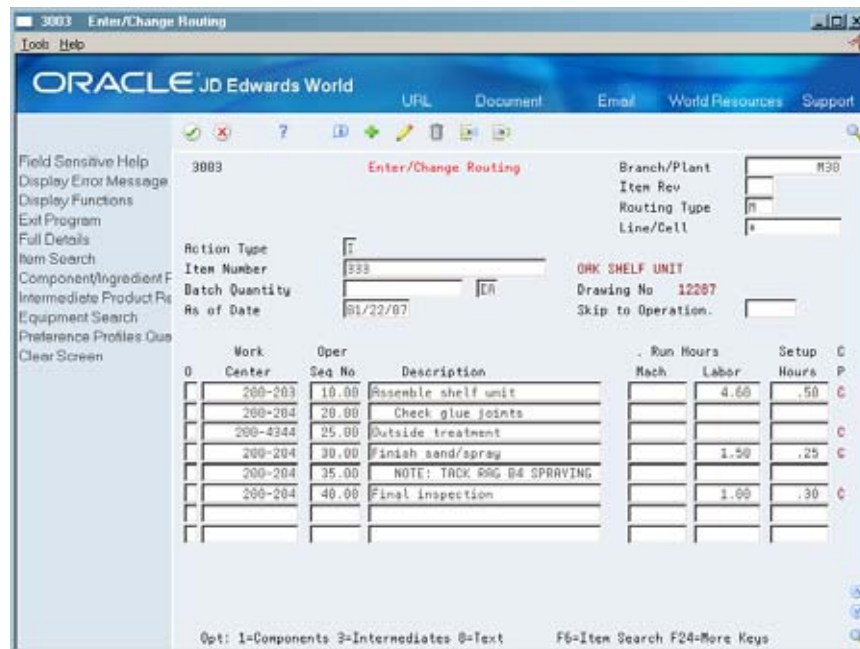

- Review the following fields:
 - Work Center
 - Machine Run Hours
 - Labor Run Hours
 - Setup Hours
- Access the detail area (F4).

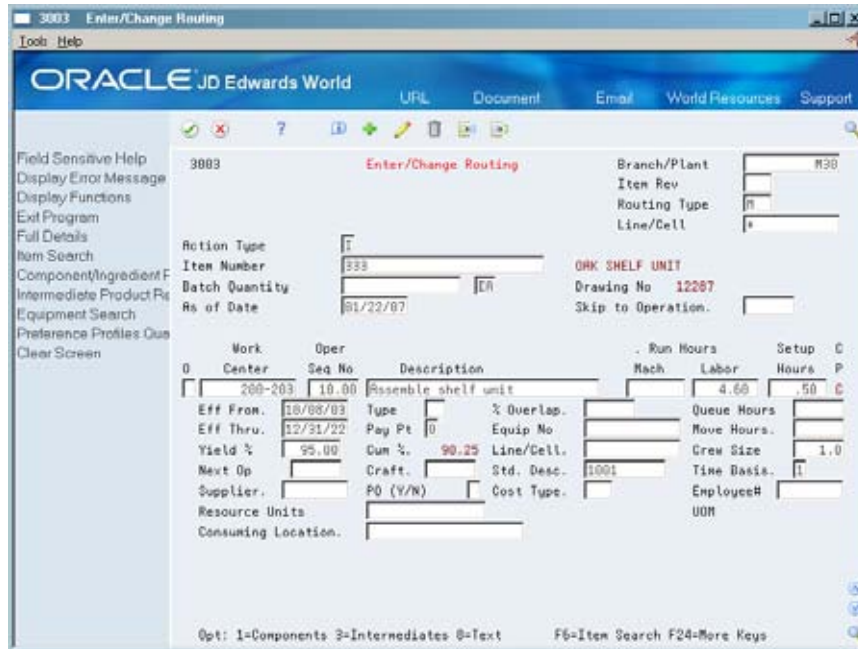

3. Review the following fields:

- Time Basis
- Crew Size
- Cost Type
- Type
- Yield Percent
- Cumulative Percent

Field	Explanation
Work Center	A number that identifies a branch, plant, work center, or business unit. <i>Form-specific information</i> For Equipment users, this is the craft/resource responsible for completing the maintenance activity.
Routing Type	Simulated Rollup will only cost an "M" type routing.
Mach	This is the standard machine hours expected to be incurred in the normal production of this item.

Field	Explanation
Labor	<p>This is the standard hours of labor expected in the normal production of this item.</p> <p>The run labor hours in the Routing Master table (F3003) are the total hours it takes the specified crew size to complete the operation. The hours are multiplied by the crew size during shop floor release and product costing.</p> <p style="text-align: center;"><i>Form-specific information</i></p> <p>For Equipment/Plant:</p> <p>This is the estimated number of hours needed to complete a maintenance activity.</p>
Setup Hours	<p>The standard setup hours you expect to incur in the normal completion of this item.</p>
Time Basis	<p>A user-defined code (system 30, type TB) that identifies the time basis or run rate per hour for machine or labor hours entered for any routing step. You can set rates per unit, per 10, per 1000, and so on.</p> <p>The system uses the values in the Description-2 field on the User Defined Codes screen for costing and scheduling calculations. The description is what the code represents, but is not used in calculations.</p> <p>Simulated Rollup uses the Time Basis Code as a divisor to calculate per unit cost:</p> <p>{10 routing hours / 100 (TB Description 2) = .1 (hours per unit)}</p> <p>The Time Basis code will default from the Item Branch Plant into each operation sequence of the routing.</p>
Crew Size	<p>The number of people who work in the specified work center or routing operation.</p> <p>The system automatically populates this field with the information from the Work Center. The system multiplies the Run Labor value in the Routing Master table (F3003) by crew size during cost simulation to generate total labor dollars used in the cost simulation.</p> <p style="text-align: center;"><i>Form-specific information</i></p> <p>For Shop Floor Control:</p> <p>If the Prime Load Code is L or B, the system uses the total labor hours for back scheduling. If the Prime Load Code is C or M, the system uses the total machine hours for back scheduling without modification by crew size.</p> <p>The Crew Size field on the Routing Revisions screen displays the value set on the Enter/Change Work Centers screen (P3006). You can override the value by changing this field on the Routing Revisions form. However, the Enter/Change Work Centers form will not reflect this change.</p>

Field	Explanation
Cost Type	<p>This code designates each element of cost for an item. An example of the coding structure is:</p> <p>A1 Purchased raw material B1 Direct labor routing sheet rollup B2 Setup labor routing sheet rollup C1 Variable burden routing sheet rollup C2 Fixed burden routing sheet rollup Dx Usually used for outside processing routing sheet rollup Xx Usually used for extra add-ons, such as electricity, water, and so forth</p> <p>The optional add-on computations usually operate with the type "X" extra add-ons. This cost structure allows you to use an unlimited number of cost components to calculate alternative cost rollups. The system then associates these cost components with one of six user-defined summary cost buckets.</p>
Type	<p>A user-defined code (system 30, type OT) that indicates the type of operation. For example:</p> <p>A Alternate routing TT Travel time IT Idle time T Text (Enter text at Description)</p> <p style="text-align: center;"><i>Form-specific information</i></p> <p>For Product Costing: Only operations with a "blank" type operation code are costed.</p>
Yield %	<p>Represents the planned output yield percent for a step. The Planned Yield Update program uses this value to update the Cumulative Percent in the bill of material and the Operation Scrap Percent in the routing. Materials Requirements Planning uses the step scrap percent and the existing component scrap percent to plan component demand.</p>
Cum %	<p>Represents the cumulative planned output yield percent for a step. The system uses this value to adjust the operation step scrap percent for the components at that operation step. This enables the MRP system to use the operation step scrap percent along with the existing component scrap percent to plan component demand.</p>

Create Simulated Costs

Creating Simulated Costs

You can use the Product Costing system to calculate costs on a “what if” basis. You can view the effect of any changes you want to incorporate without altering the frozen standard costs. In addition, you can simulate cost change scenarios (rollups) as many times as needed before you finalize the changes during the frozen update process.

For example, you can use simulated rollups to:

- Simulate an increase in material costs
- Forecast the impact of changes to labor rates
- Develop strategies for pricing, contractual, or labor negotiation

The simulated rollup uses information from the following tables to generate costs:

Table	Description
Manufacturing Constants (F3009)	Values from Manufacturing Constants indicate whether overhead should be included in cost component calculations.
Work Center Rates (F3008)	The rollup program uses dollar amounts and/or percentages for the calculation of labor, machine, and overhead costs.
Routing Master (F3003)	Hours required for each operation and crew size values are from the Routing Master table.
Bill of Material Master (F3002)	The Bill of Material table provides information on the material required at each level of the bill.
Cost Ledger (F4105)	The Cost Ledger table provides costs for purchased items and outside operations.

The Simulate Cost Rollup program sums the costs of all the components in each level of the parent item’s bill of material to arrive at a total cost for the parent item.

This section contains the following:

- [Creating the Costing Exceptions Report](#)
- [Creating a Simulated Rollup](#)

Creating the Costing Exceptions Report

From Daily Product Costing (G3014), choose **Periodic Product Costing**
 From Periodic Product Costing (G3023), choose **Costing Exceptions**

Before you roll up simulated costs, run the Costing Exceptions program. The program generates a report, which lists any problems associated with an item. An example of a problem is an item without a routing. You should correct the problems and run the Costing Exceptions program again before creating a simulated rollup.

Item	Item Description	T	Plant	Work Center	Oper	Description

ACE	Acetone Bulk	B	DEPOT1			30 - No Cost Component 07- material cost
ADD	Fuel Additive	B	DEPOT1			30 - No Cost Component 07- material cost
ADD	Fuel Additive	B	DEPOT2			30 - No Cost Component 07- material cost
AEROSOL CANS	Industrial Gases	S	27			50 - Manufactured item with no BOM
AR101278	Engine Oil Filter	P	YARD			50 - Manufactured item with no routing
AR86745	Fuel Filter	P	YARD			30 - No Cost Component 07- material cost
AT105663	Hydraulic Oil Filter	P	YARD			30 - No Cost Component 07- material cost
AT105664	Transmission Oil Filter	P	YARD			30 - No Cost Component 07- material cost
AT58368	Pump Return Filter (HFWD)	P	YARD			30 - No Cost Component 07- material cost
AT60645	Front Axle Filter (HFWD)	P	YARD			30 - No Cost Component 07- material cost
AT75035	Air Filter - Primary	P	YARD			30 - No Cost Component 07- material cost
AT75036	Air Filter - Secondary	P	YARD			30 - No Cost Component 07- material cost
A200	Acetone-200LT Drum	S	DEPOT1			50 - Manufactured item with no BOM
A3T30	A3T Series Fuse 30 AMP	P	YARD			50 - Manufactured item with no routing
A3T40	A3T Series Fuse 40 Amp	P	YARD			30 - No Cost Component 07- material cost
A3T50	A3T Series Fuse 50 Amp	P	YARD			30 - No Cost Component 07- material cost
BASEA	Base Oil Bulk	B	DEPOT1			30 - No Cost Component 07- material cost
BASEB	Base Oil Bulk	B	DEPOT1			30 - No Cost Component 07- material cost
BB303	Ball Bearing Fafnir 303KD	P	YARD			30 - No Cost Component 07- material cost
BB310	Ball Bearing Fafnir 301KD	P	YARD			30 - No Cost Component 07- material cost
BB311	Ball Bearing Fafnir 311KD	P	YARD			30 - No Cost Component 07- material cost
BIKE	Bike Parent	K	10			50 - Manufactured item with no routing
BIKE10	10 Speed Bike	M	10			50 - Manufactured item with no routing
BIKE10B	10 Speed Bike-Blue	P	10			30 - No Cost Component 07- material cost
BIKE10G	10 Speed Bike-Green	P	10			30 - No Cost Component 07- material cost
BIKE15	15 Speed Bike	M	10			50 - Manufactured item with no routing
BIKE15B	15 Speed Bike-Blue	P	10			30 - No Cost Component 07- material cost
BIKE15G	15 Speed Bike-Green	P	10			30 - No Cost Component 07- material cost
BINDER	Spiral Binder	P	M55			30 - No Cost Component 07- material cost
BINDER	Spiral Binder	P	M56			30 - No Cost Component 07- material cost
BINDER	Spiral Binder	P	M80			30 - No Cost Component 07- material cost
BINDER	Spiral Binder	P	M95			30 - No Cost Component 07- material cost
BINDERST01	Spiral Binder	P	M55			30 - No Cost Component 07- material cost

What You Should Know About Processing Options

Indicate in the processing options the minimum level of error messages that you want to include in the report. You can define severity levels and error messages specific to your company by using Vocabulary Overrides. For example, if *labor hours are zero* is important to your company, then you might want to assign this error message a higher severity level.

The text of the message can also be changed, but it must maintain the same meaning as the original message defined by JD Edwards World. For example, you could change the message text *labor hours are zero* to *no labor hours*.

The following are examples of errors on which the system searches and the severity level to which they are assigned by JD Edwards World.

Severity	Message Text
50	Manufactured item with no BOM

Severity	Message Text
40	No rates for work center
30	No labor rate (for selected cost method)
30	No cost component - material cost
30	No setup labor rate (for selected cost method)
30	No variable overhead rate (for selected cost method)
30	No fixed overhead rate (for selected cost method)
30	No work center machine run rate (for selected cost method)
30	No work center machine variable overhead rate (for selected cost method)
30	No work center machine fixed overhead rate (for selected cost method)
20	Purchased part with BOM
20	BOM component with no quantity per
10	Setup hours are zero
10	Machine hours are zero
10	Labor hours are zero
10	Extras at standard and not at current or future or vice versa
10	No accounting lot size set up (future)

Processing Options

See [Costing Exceptions \(P30801\)](#).

See Also

- *Working with Vocabulary Overrides (P9220) in the Technical Foundation Guide* for more information on changing the text of error messages

Creating a Simulated Rollup

	From Manufacturing Systems (G3), choose Product Costing From Daily Product Costing (G3014), choose Simulate Standard Rollup
---	--

Use the Simulate Cost Rollup program to calculate costs on a “what if” basis. Then, you can view the results on Enter/Change Cost Components.

You can perform simulated rollups and frozen updates for any cost method, excluding 02. Manufacturing Accounting system uses frozen standard costs (cost method 07), if standard costing is indicated in Manufacturing Constants.

To choose a bill of material and routing, the program searches first for a bill whose batch quantity matches the accounting cost quantity. If no such bill is found, the program uses the zero batch bill. The zero batch bill has a blank batch quantity on the header section. The component item(s) quantity per is the amount required to build one unit of the parent item.

Cumulative Yield

Cumulative yield, defined on the routing, affects labor and machine hours in the rollup calculations. There must be enough hours expended to obtain 100% yield at the last operation. In a series of routings, the hours must be adjusted accordingly. The following example illustrates how costing of hours is affected by cumulative yield:

Cumulative Yield = 85% (0.85)

Yield	Labor	Machine	Setup
Without Yield	5	5	5
With Yield	5.88	5.88	5

For each operation, the labor and machine hours are adjusted by dividing the hours by the cumulative yield. Setup hours are not affected.

Operation Scrap

Operation scrap, defined on the bill of material, affects material cost calculations in the rollup. There must be enough material at each operation in order to obtain 100% yield at the last operation. When material cost is calculated, the quantity of the components is adjusted accordingly. The following example illustrates the effect of operation scrap on costing:

Parent = A

Component = B

Quantity per = 3

Cost of B = 5.00

Operation scrap = 8%

Cost of B rolled into parent item A = $3 \times 1.08 \times 5 = 16.20$.

Before You Begin

- Create the Costing Exceptions report

What You Should Know About

Master Routings

The program uses the master routing instead of the standard routing for the item from the Routing Master table (F3003) if all of the following are true:

- The Master Routing field on the Manufacturing Constants form is set to Y for the branch.
- The parent item has a cross-reference item defined for master routing. (The cross-reference item must be defined with a cross-reference type of MR and the Address field must be blank.)
- The cross-reference item has an item routing defined.

Unit of Measure Conversions

The program converts all units of measure to the primary unit of measure for the purpose of the rollup.

When one of the units of measure is a potent unit of measure, the conversion equation includes the standard potency value from Branch/Plant Manufacturing Data. The following example illustrates a conversion involving a potent unit of measure:

- Component = B
- Quantity per = 3
- Primary unit of measure = GA (physical gallons)
- Component unit of measure = GP (potent gallons)
- Standard potency = 50%
- Cost of B = 50.00 (from the Cost Ledger table)
- Cost rolled into parent item = $[(3 / .5) \times 50] = 300.00$

When converting from potent units to physical units, the program divides by the standard potency. When converting from physical to potent units, the program multiplies by the standard potency.

Outside Operations

If your item has an outside operation set up in the routing, verify the following before running the Simulate Cost Rollup program:

- You have set up a branch/plant record for the *OP item
- There is a valid cost in the Cost Ledger table (F4105) for the method specified in the Outside Operations processing option of the Simulate Cost Rollup program

Bulk Products

All costing is based on quantities at standard temperatures. If you enter issues or completions quantities at ambient temperatures, the program converts them to standard.

See Also

- *Updating Frozen Costs (P30835)*
- *Appendix A – Calculations in Cost Rollup*

Processing Options

See [Cost Simulation \(P30820\)](#).

Work with Simulated Cost Components

Working with Simulated Cost Components

After you have created simulated costs, review costing information to determine the effects of the current rollup scenario. Revise the costing information as necessary. When costs are correct, run the Frozen Update program.

This section contains the following:

- [Reviewing and Revising Simulated Cost Components](#)
- [Setting Up Standard Rate and Factor Codes](#)
- [Assigning Values to User Defined Cost Components](#)
- [Reviewing the Standard Cost Simulation Report](#)
- [Setting Up Cost Bucket Codes for Costed Bills of Material](#)
- [Reviewing Costed Bills of Material](#)
- [Setting Up Operation Bucket Codes for Costed Routings](#)
- [Reviewing a Costed Routing](#)

Reviewing and Revising Simulated Cost Components



From Manufacturing Systems (G3), choose **Product Costing**
From Daily Product Costing (G3014), choose **Enter/Change Cost Components**

You review costing information and set up simulated cost scenarios to help plan for future cost changes.

You can change only simulated costs. You can set a processing option if you want to manually maintain the routing cost components (B and C) and protect them from being overwritten.

For the system to calculate B and C cost components, all of the following conditions must be met:

- A routing operation must have a work center with rates in the Work Center Master table for the cost component to display.
- The type operation code on the routing must indicate a normal operation (that is, the type operation code is blank).
- The effective dates on the routing must be valid. The default for As Of date is today's date.

See Also

- Creating Simulated Costs (P30820)
- Appendix A — Calculations in Cost Rollup

On Enter/Change Cost Components

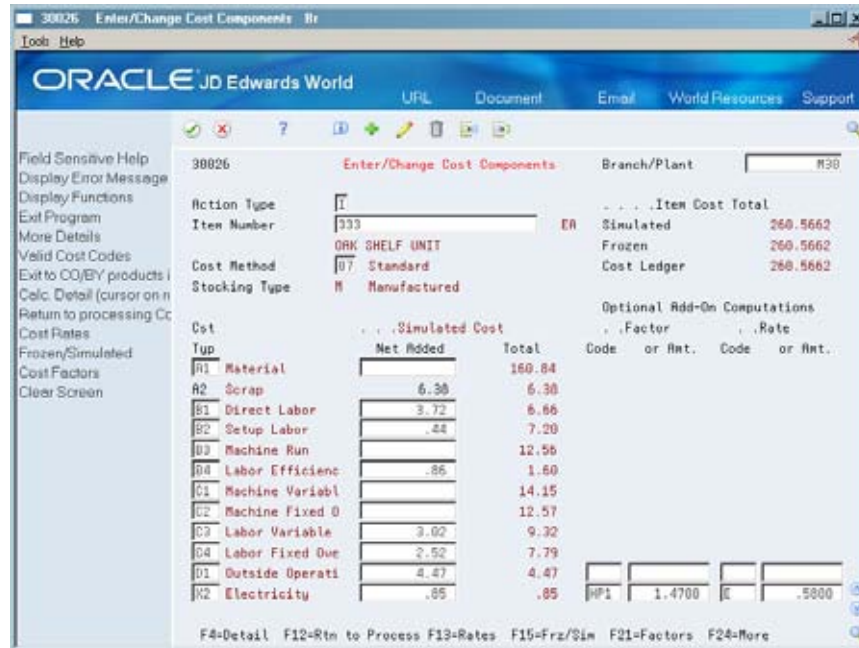

1. Review or revise the following fields:

- Item Cost Total - Simulated
- Item Cost Total - Cost Ledger
- Cost Method
- Cost Type
- Simulated Cost Net Added
- Simulated Cost Total

2. Access the detail calculations for net added value of a routing cost component (F10).



You might want to view the detail calculations for one of the net added values. These values are calculated from work center data, work center rates, and manufacturing constants.

The detailed calculation at the right indicates how the program calculates the cost component value for the operation sequence that is highlighted.

The detail calculations screen shows real-time costs. These costs might be different from those shown on the Enter/Change Cost Components form, if you have changed the item's routing, work center rates, or manufacturing constants since you last ran the Simulate Cost Rollup program.

Field	Explanation
Cost Method	A user defined code (system 40, type CM) that identifies a cost method. Cost methods 01 through 08 are hard-coded.
Cst Type	<p>This code designates each element of cost for an item. An example of the coding structure is:</p> <ul style="list-style-type: none"> A1 Purchased raw material B1 Direct labor routing sheet rollup B2 Setup labor routing sheet rollup C1 Variable burden routing sheet rollup C2 Fixed burden routing sheet rollup Dx Usually used for outside processing routing sheet rollup Xx Usually used for extra add-ons, such as electricity, water, and so forth <p>The optional add-on computations usually operate with the type "X" extra add-ons. This cost structure allows you to use an unlimited number of cost components to calculate alternative cost rollups. The system then associates these cost components with one of six user defined summary cost buckets.</p> <p style="text-align: center;"><i>Form-specific information</i></p> <p>The field to the right of the code describes the cost.</p>

Field	Explanation
Net Added	Used to calculate cost during the simulation process. <i>Form-specific information</i> This is the cost to build this item at this level in the bill of material. This cost does not include materials (lower-level components). The heading above the Net Added and Total columns indicates if the costs are simulated or frozen values.
Simulated Cost	For the designated cost method, used to calculate the cost of all the lower levels during the simulation process. <i>Form-specific information</i> This is the sum of the net added cost at this level plus the sum of the total costs of the item's direct components (which includes those items' lower-level component costs.) The heading above the Net Added and Total columns indicates if the costs are simulated or frozen values.

What You Should Know About

Item cost totals

The Item Cost Total values are the total costs of all cost components as of the last cost simulation for simulated values, and as of the last frozen update for frozen values. Simulated and frozen values are from the Item Cost Components table.

If the program finds a discrepancy between the Frozen Total and Cost Ledger Total fields, it highlights both fields.

See also *Reviewing the Cost Integrity Report* for more information on comparing frozen and cost ledger values.

Deleting costs

You must delete costs at the bill of material level at which they occur. For example, you cannot delete costs for lower-level components by locating the parent item. Instead, locate the component item number and remove the costs for the component. The system does not make the corresponding cost change to the higher level components and parent item until you run the Simulate Cost Rollup program.

To delete outside processing costs (usually cost component Dx), delete the cost component from the routing. Then, delete the cost component and net added value from Enter/Change Cost Components.

Net Added Routing Costs and Frozen Costs

If the Net Added on routing costs does not match frozen costs, the routings may have been changed after the frozen costs were established.

To work around this issue, simulate and freeze the costs.

Processing Options

See [Item Cost Components \(P30026\)](#).

Setting Up Standard Rate and Factor Codes



From Product Costing Setup (G3042), choose **Standard Rates** or **Standard Factors**

Standard rate and factor codes represent overhead costs or other indirect costs that cannot be attributed directly to a certain production process or operation, but must be accounted for in product costing for an item. These types of costs include utilities, insurance, research and development costs, rent or lease costs, or other overhead or general operating costs. Rate and factor codes are user defined.

The Simulate Cost Rollup program uses the rates and factors you define to calculate some of the costs that appear on Enter/Change Cost Components.

See Also

- *Assigning Values to User Defined Cost Components (P30026)*

To set up standard rate and factor codes

On Standard Rates or Standard Factors

Code	Description	Rate
E	Electricity (\$/KWH)	.5000
I	Insurance (\$/M)	.0150
L1	Labor Type 1	14.0000
M1	Machine 1	45.0000
RSD	R & D Charge	.0200
WHS	Warehouse Space	.0220
WTR	Water	.2010

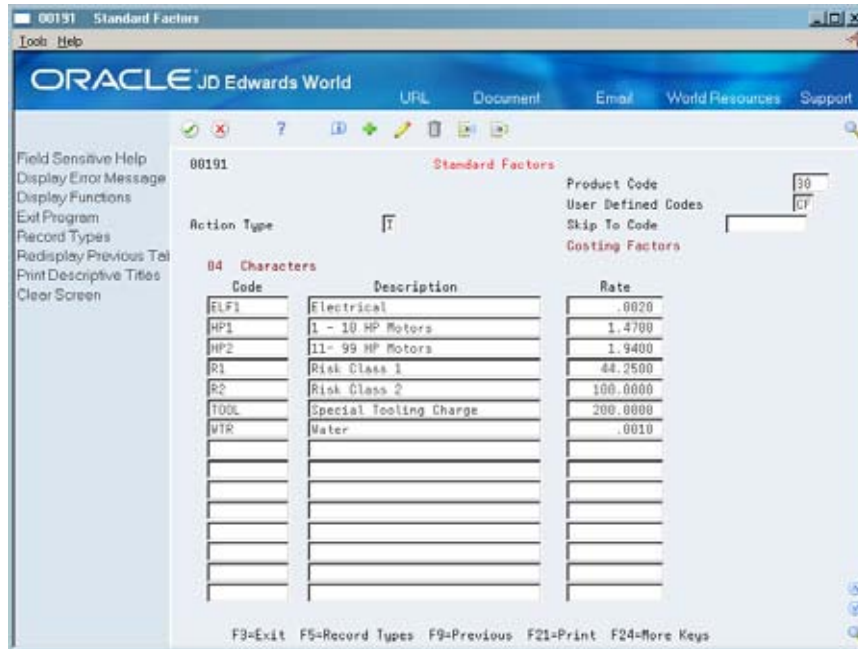

Complete the following fields:

- Code
- Description
- Rate

Field	Explanation
Code	This column contains a list of valid codes for a specific user defined code list. The number of characters that a code can contain appears in the column title.
Description	A user defined name or remark.
Rate	A code used to define rate information in the General Rate/Message Records table (F00191).

What You Should Know About

- Code** A rate or factor code used to define the value in the Rate field, as follows:
- Rate code — On Enter/Change Cost Components, the value is used in conjunction with the Factor Code and Factor Amount fields to calculate extra costs.
 - Factor code — On Enter/Change Cost Components, the value is used in conjunction with the Rate Code and Rate Amount fields to calculate extra costs.
- Description** A description of the rate code or factor code.

Rate This rate is used to calculate extra costs.

Assigning Values to User Defined Cost Components



From Manufacturing Systems (G3), choose **Product Costing**
From Daily Product Costing (G3014), choose **Enter/Change Cost Components**

You can define net added values for user defined extra costs in one of the following ways:

- Assign a net added value manually
- Assign a predefined value
- Assign a calculated value based on another component's total value
- Assign a calculated value based on another component's net added value
- Assign a calculated value by multiplying a rate and factor

You can also change cost information or delete extra cost components.

See Also

- *What Are Cost Components? (P30026)*
- *Setting Up Cost Components (30/CA)*

. . . Simulated Cost			. . . Item Cost Total	
Typ	Net Added	Total	Simulated	Frozen
R1 Material		160.84	260.5662	260.5662
R2 Scrap	6.30	6.30		
B1 Direct Labor	3.72	6.66		
B2 Setup Labor	.44	7.20		
B3 Machine Run		12.56		
B4 Labor Efficiency	.86	1.60		
C1 Machine Variabl		14.15		
C2 Machine Fixed 0		12.57		
C3 Labor Variable	3.02	9.32		
C4 Labor Fixed Due	2.52	7.79		
D1 Outside Operati	4.47	4.47		
N2 Electricity	.05	.05		
			Factor	Rate
			1.4700	.5000

To assign a net added value manually

On Enter/Change Cost Components

Complete the following fields:

- Cost Component
- Simulated Cost Net Added

Note: The program writes manually entered costs to the Total field when you run the Simulate Cost Rollup program.

To assign a predefined value

Use user defined rate codes and factor codes to identify net added costs. For example, to calculate the value for cost component X5, the program uses the amount defined for rate code R&D.

On Enter/Change Cost Components

Complete the following fields:

- Cost component
- Factor Code
- Factor Amount
- Rate Code
- Rate Amount

Field	Explanation
Code	A code used to retrieve rate or factor information from the Generic Rate File (F00191). System Code 30 Record Type CF or CR
Amt	A generic factor number used to calculate data.

To assign a calculated value based on another component's total value

The system can calculate the net added value based on the *total value* for an existing cost component. The system calculates this value when you enter the data on Enter Cost Components. The costs are then rolled up into the cost of the item when you run Simulate Cost Rollup.

On Enter/Change Cost Components

1. Complete the following field:
 - Cost component
2. Enter an ampersand (&) followed by the cost component code in the following field:
 - Factor Code
3. Complete one of the following fields:
 - Rate Code
 - Rate Amount

The program retrieves the total value for the cost component and multiplies it by the rate value indicated.

To assign a calculated value based on another component's net added value

The system can calculate the net added value based on the *net added value* for an existing cost component. The system calculates this value when you enter the data on Enter Cost Components. The costs are then rolled up into the cost of the item when you run Simulate Cost Rollup.

On Enter/Change Cost Components

1. Complete the following field:
 - Cost Component
2. Enter an asterisk (*) followed by the cost component code in the following field:
 - Factor Code
3. Complete one of the following fields:
 - Rate Code
 - Rate Amount

The program retrieves the net added value for the cost component and multiplies it by the rate value indicated.

To assign a calculated value by multiplying a rate and factor

The system can calculate the net added value by multiplying a rate amount and factor amount. If you enter both amounts, the system multiplies the two numbers to calculate the net added cost for that cost component for that item. If either the rate or factor is blank, the system multiplies by zero (0).

On Enter/Change Cost Components

1. Complete the following field:
 - Cost Component
2. Complete both of the following fields:
 - Factor Amount
 - Rate Amount

Reviewing the Standard Cost Simulation Report

The Simulate Cost Rollup program generates the Standard Cost Simulation report. The report shows the previous cost of the item, the simulated rolled up cost, and the variance between the two.

After reviewing the simulated costs, you revise incorrect information and create simulated costs again to include the changes.

30825		JD Edwards World				Page - 3				
		Standard Cost Simulation				Date - 2/20/17				
Branch M30 Memphis Mfg. Plant										
Cost Method. 07 Standard										
Item Number	Item Description	Cst Typ	Cost Desc.	Net Added	Total	Simulated Cost. Net Added	Total	Variance Net Added	Total	Percent
1001	Pen & Pencil Set	B1	Direct Lab	.0979	.0979	.0979	.0979			
		B2	Setup Labo	24.8000	24.8000	24.8000	24.8000			
		B3	Machine Ru	.0338	.0338	.0338	.0338			
		B4	Labor Effi	.0184	.0184	.0096	.0096	.0088-	.0088-	47.826-
		C1	Machine Va	.0271	.0271	.0271	.0271			
		C2	Machine Fi	.0294	.0294	.0294	.0294			
		C3	Labor Vari	23.6307	23.6307	23.6255	23.6255	.0052-	.0052-	.022-
		C4	Labor Fixe	24.8594	24.8594	24.8550	24.8550	.0044-	.0044-	.017-
	UOM. . EA		2nd Item Number.	73.4967	73.4967	73.4783	73.4783	.0184-	.0184-	.025-
1008A	Drawer Labels	A1	Material	.0344	.0344	.0100	.0100	.0244-	.0244-	70.930-
	UOM. . EA		2nd Item Number.0344	.0344	.0100	.0100	.0244-	.0244-	70.930-
1122	CRT AS/400 Compati	A1	Material		362.5410		362.5410			
		B1	Direct Lab	24.1500	156.1813	24.1500	31.4938	124.6875-		79.835-
		B2	Setup Labo	10.6250	69.0750	10.6250	31.2500	37.8250-		54.759-
		B3	Machine Ru	1.6250	12.7400	1.6250	7.9950	4.7450-		37.244-

Setting Up Cost Bucket Codes for Costed Bills of Material

From Product Costing Setup (G3042), choose Cost Buckets

Use cost bucket codes to combine the material and value-added cost for each item into one group. With cost buckets, you can total cost components by groups according to their use. In addition, you can assign a cost bucket sequence number to

each cost component to tell the system how to group the costs on costed bill inquiries and reports.

Each cost bucket can contain several defined cost components. Column sequence is defined by the number in the Description-2 field. For example, you might define the columns (buckets) and user defined codes as follows:

Bucket #	Title	Cost Components Included in Buckets
Column 1	Purchase	Cost components A1 (material), A2 (scrap), and D1 (outside operations)
Column 2	Labor	Cost components B1 (direct labor), B2 (setup labor), and B4 (labor efficiency)
Column 3	Machine	Cost component B3 (machine run)
Column 4	Overhead	Cost components C1 (machine variable) and C2 (machine fixed)
Column 5	Extras	Cost components X1 (taxes) and X2 (electricity)

To set up a cost bucket code

On Cost Buckets

The screenshot shows the 'Cost Buckets' form in Oracle JD Edwards World. The form title is '00051 Cost Buckets'. It features a menu bar with 'Tools' and 'Help'. Below the menu bar, there are several fields: 'System Code' (30), 'User Defined Codes' (CD), 'Skip To Code', and 'Cost Buckets'. The main area contains a table with the following data:

Code	Description	Description-2
R1	Purchase	1
R2	Purchase	1
B1	Labor	2
B2	Labor	2
B3	Machine	3
B4	Labor	2
C1	Overhead	4
C2	Overhead	4
C3	Overhead	4
C4	Overhead	4
D1	Purchase	1
D2	Purchase	1
XR	Extras R-D	5
XB	Extras R-D	5

At the bottom of the form, there are function keys: F5=Code Types, F14=Memo, F15=Where Used, F16=Translate, F21=Print, F24=More.

Complete the following fields:

- Code – Cost Component
- Description – Component Description
- Description-2 – Column Number

What You Should Know About

Code – Cost Component	Designates the cost components to be grouped.
Description – Sequence Number	The name that you want to appear as the heading for the cost bucket column on costed bill inquiries and reports. You only need to enter this title once for each sequence number. If the program finds more than one name for a bucket, it uses the name defined for the last cost component that it accumulates into the cost bucket.
Description-2	Specifies in what column (bucket) each cost component is grouped.

Reviewing Costed Bills of Material

	From Manufacturing Systems (G3), choose Product Costing From Daily Product Costing (G3014), choose Costed Bill Inquiry
---	---

Effective cost and profit projection depend on accurate and comprehensive item cost information. Use Costed Bill Inquiry to view costs for both parent items and components to assist you in budgeting resources and planning for future cost of items.

The program displays summarized costs for the direct components of a parent item, and net added and total costs for the parent item:

- For the parent item, the costs displayed are the net added cost components from the Cost Components table.
- For each component, the costs displayed are calculated based on the as of date from the bill of material and the cost method used. The program uses the as of date to ignore obsolete component lines in the bill of material.

For example, you can view all costs of manufacturing a parent item, including assembly, subassembly, and component costs. In addition, the manufacturing cost of a component is divided into five user defined categories for precise costing calculations:

- Purchase
- Labor
- Machine
- Overhead
- Extras

Note: The program can accumulate purchase costs for up to 999 components on each bill of material. Components beyond 999 are not included in the costing process.

To review a costed bill of material

On Costed Bill Inquiry

Component Item	Purchase	Labor	Machine	Overhead	Extras 1	Total
333	10.85	9.05		5.54	16.98	42.44
212	28.80	.10	2.34	4.11		35.35
121	27.36	.83	1.42	2.44		31.25
424	52.80	.25	9.10	21.21		82.56
444	52.80	10.05		11.05		73.10
123	4.00					4.00
122	.84					.84
Standard Totals	171.69	19.40	12.56	43.84	16.98	264.58

1. Review the following fields:

- As of
- Cost Method
- Requested Quantity
- Unit Of Measure
- Skip to Sequence Number
- Component Item
- Purchase
- Labor
- Machine
- Overhead
- Extras
- Total (row)
- Total (column)

2. Access the detail area (F4).

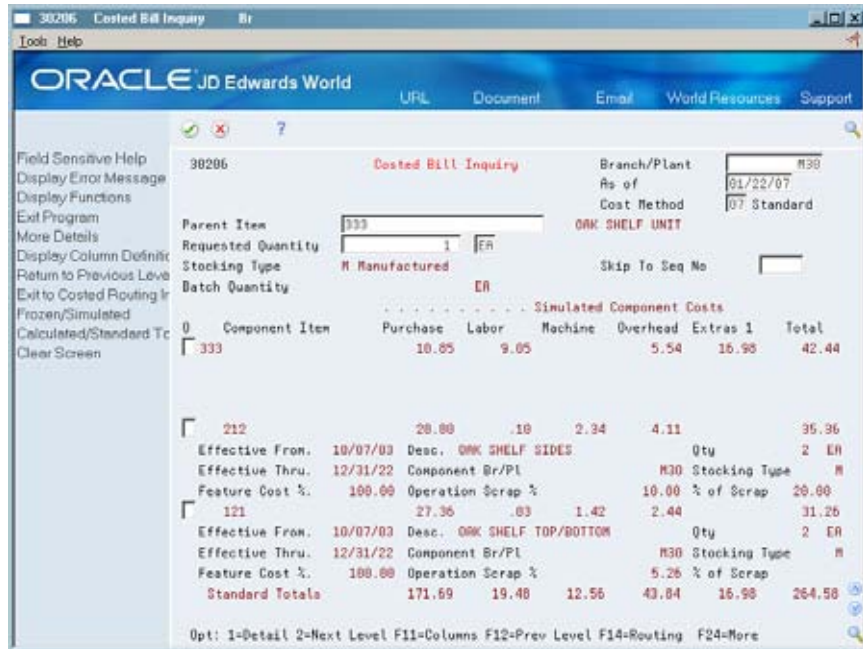

3. Review the following fields:

- Effective - From Date
- Effective - To Date
- Feature Cost Percent
- Operation Scrap Percent
- Quantity
- Percent of Scrap

4. Access the costed bill information for the components.

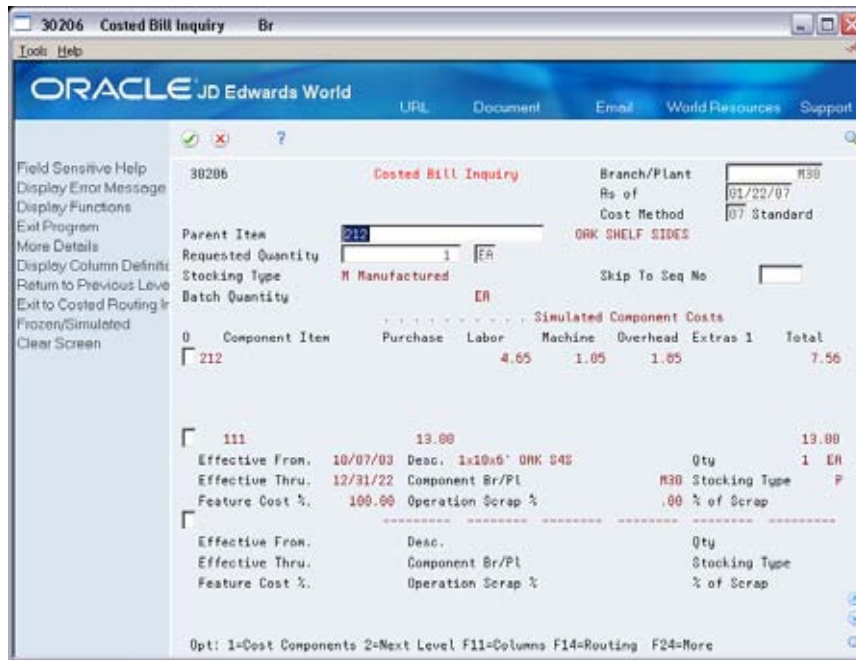

5. Toggle to review frozen or simulated costs (F15).
6. Access Cost Bucket Key (Columns) to review an item's cost buckets.

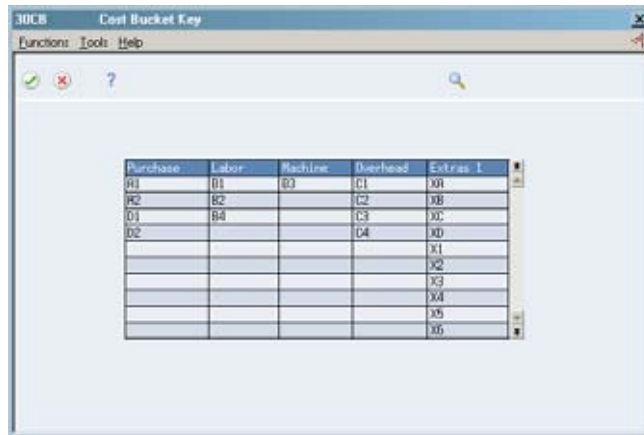

Field	Explanation
As of	This field is used for effectivity checking. Enter a specific date to display documents (orders, bills of material, routings, as applicable) that are effective on or after that date. The current system date is the default, but you can enter any future or past date.
	<i>Form-specific information</i>
	The system uses the bill of material that is effective as of this date.

Field	Explanation
Component Item	<p>A number that the system assigns to an item. It can be in short, long, or 3rd item number format.</p> <p style="text-align: center;"><i>Form-specific information</i></p> <p>In the header, this is the item number of the parent. In the detail area, these are the item numbers of the components.</p>
Requested Quantity	<p>The number of parent items you want to process. The system calculates lower-level values in quantity per the number of parent items requested. For example, if 3 components are needed for a parent item, and the requested quantity is 10, the system plans for 30 components.</p> <p style="text-align: center;"><i>Form-specific information</i></p> <p>This is the number of parent items for which you want to view cost breakdowns. Costs are figured in quantity per the parent item.</p>
Skip To Seq No	<p>A number that indicates the sequence of the components on a bill of material. It initially indicates the relative sequence in which a component was added to a kit or single level bill of material. You can modify this number to change the sequence in which the components appear on the bill of material.</p> <p>Skip To fields allow you to enter a component line number that you want to begin the display of information.</p> <p style="text-align: center;"><i>Form-specific information</i></p> <p>You can enter a component line number with which to begin the display.</p>
Purchased	<p>Work Amount field for the Manufacturing System.</p> <p style="text-align: center;"><i>Form-specific information</i></p> <p>This is cost bucket No. 1 as defined for user defined code 30/CB, Cost Buckets. You can view the cost components assigned to the cost bucket. Cost extras must be defined in cost buckets to be included in the amounts in this display. The total of this column appears at the bottom of the screen in the "Totals" row. The heading above the columns indicates which costs are displayed: frozen or simulated. You can toggle between simulated and frozen values.</p>
Labor	<p>Work Amount field for the Manufacturing System.</p> <p style="text-align: center;"><i>Form-specific information</i></p> <p>Cost bucket No. 2 as defined for user defined code 30/CB, Cost Buckets. You can view the cost components assigned to the cost bucket. Cost extras must be defined in cost buckets to be included in the amounts in this display. The total of this column appears at the bottom of the screen in the "Totals" row. The heading above the columns indicates which costs are displayed: frozen or simulated. You can toggle between simulated and frozen values.</p>

Field	Explanation
Setup	<p>Work Amount field for the Manufacturing System.</p> <p><i>Form-specific information</i></p> <p>Cost bucket No. 3 as defined for user defined code 30/CB, Cost Buckets. You can view the cost components assigned to the cost bucket. Cost extras must be defined in cost buckets to be included in the amounts in this display. The total of this column appears at the bottom of the screen in the "Totals" row. The heading above the columns indicates which costs are displayed: frozen or simulated. You can toggle between simulated and frozen values.</p>
Overhead	<p>Work Amount field for the Manufacturing System.</p> <p><i>Form-specific information</i></p> <p>Cost bucket No. 4 as defined for user defined code 30/CB, Cost Buckets. You can view the cost components assigned to the cost bucket. Cost extras must be defined in cost buckets to be included in the amounts in this display. The total of this column appears at the bottom of the screen in the "Totals" row. The heading above the columns indicates which costs are displayed: frozen or simulated. You can toggle between simulated and frozen values.</p>
Extras	<p>Work Amount field for the Manufacturing System.</p> <p><i>Form-specific information</i></p> <p>Cost bucket No. 5 as defined for user defined code 30/CB, Cost Buckets. You can view the cost components assigned to the cost bucket. Cost extras must be defined in cost buckets to be included in the amounts in this display. The total of this column appears at the bottom of the screen in the "Totals" row. The heading above the columns indicates which costs are displayed: frozen or simulated. You can toggle between simulated and frozen values.</p>
Total	<p>Work Amount field for the Manufacturing System.</p> <p><i>Form-specific information</i></p> <p>Contains system calculated totals for item costs, that is, for each component and parent item.</p>

Field	Explanation
Effective From	<p>A date that indicates one of the following:</p> <ul style="list-style-type: none"> ▪ When a component part goes into effect on a bill of material ▪ When a routing step goes into effect as a sequence on the routing for an item ▪ When a rate schedule is in effect <p>The default is the current system date. You can enter future effective dates so that the system plans for upcoming changes. Items that are no longer effective in the future can still be recorded and recognized in Product Costing, Shop Floor Control, and Capacity Requirements Planning. The Material Requirements Planning system determines valid components by effectivity dates, not by the bill of material revision level. Some forms display data based on the effectivity dates you enter.</p>
Qty	<p>The number of units to which the system applies the transaction.</p> <p style="text-align: center;"><i>Form-specific information</i></p> <p>This is the quantity per assembly and indicates how many of a component are used in the parent.</p>
Effective Thru	<p>A date that indicates one of the following:</p> <ul style="list-style-type: none"> ▪ When a component part is no longer in effect on a bill of material ▪ When a routing step is no longer in effect as a sequence on the routing for an item ▪ When a rate schedule is no longer active <p>The default is December 31 of the default year defined in the Data Dictionary for Century Change Year. You can enter future effective dates so that the system plans for upcoming changes. Items that are no longer effective in the future can still be recorded and recognized in Product Costing, Shop Floor Control, and Capacity Requirements Planning. The Material Requirements Planning system determines valid components by effectivity dates, not by the bill of material revision level. Some forms display data based on the effectivity dates you enter.</p>
Feature Cost %	<p>A percentage used by the Simulate Cost Rollup program to calculate the cost of a feature or option item as a percentage of the total cost of the parent.</p> <p>Enter the percentage as a whole number: 5% as 5.0</p>

Field	Explanation
Operation Scrap %	The system uses this value to increase or decrease the amount of materials to account for loss within the operation. The system updates this value on Enter/Change Bill of Material when you run the Planned Yield Update program. The system calculates this value by compounding the yield percentages from the last operation to the first operation. Use a processing option in Enter/Change Routing to enable the system to calculate the component scrap percent.
% of Scrap	<p>Scrap is the percentage of unusable component material created during the manufacture of a particular parent item. During DRP/MPS/MRP generation, the system increases gross requirements for the component item to compensate for the loss.</p> <p>Note: Shrink is the expected loss of parent items (and hence, components) due to the manufacturing process. Shrink and scrap are compounded to figure the total loss in the manufacture of a particular item. Accurate shrink and scrap factors can help to produce more accurate planning calculations.</p> <p>Enter percents as whole numbers: 5% as 5.0</p>

What You Should Know About

Displayed costs

This program calculates the cost associated with each cost component in the same way as the Simulate Cost Rollup program.

See also Appendix A – Calculations in Cost Rollup.

The top line (the parent) is the net added cost of the parent from the Cost Components table. The lines for the components are the cost breakdown for all next level components. The totals across the bottom are the total costs of the parent item from the Cost Components table. The rightmost bottom total is the total of all costs for the parent item.

The costs on Costed Bill Inquiry are real-time costs, so they can change if you update the bill of material or routing for an item. The Enter/Change Cost Components screen displays the costs computed when you run Simulate Cost Rollup. As a result, the values might differ from those on Costed Bill Inquiry if you have changed the bill of material, routing, or manufacturing constants since you last ran the rollup.

See Also

- *Setting Up Cost Bucket Codes for Costed Bills of Material* (on the G3042 menu)

Processing Options

See [Costed Bill of Material Inquiry \(P30206\)](#).

Setting Up Operation Bucket Codes for Costed Routings

Use operation bucket codes to combine component costs in each step in the routing. That is, you can group operation costs into totals that appear on costed routing inquiries and reports.

For example, you might track labor costs by separate cost components that represent setup, run, and overhead labor for an item. You could combine these cost components into one total cost for labor on the costed routing inquiry or report for the item by assigning the same sequence number to each cost component.

To set up an operation bucket code

On General User Defined Codes

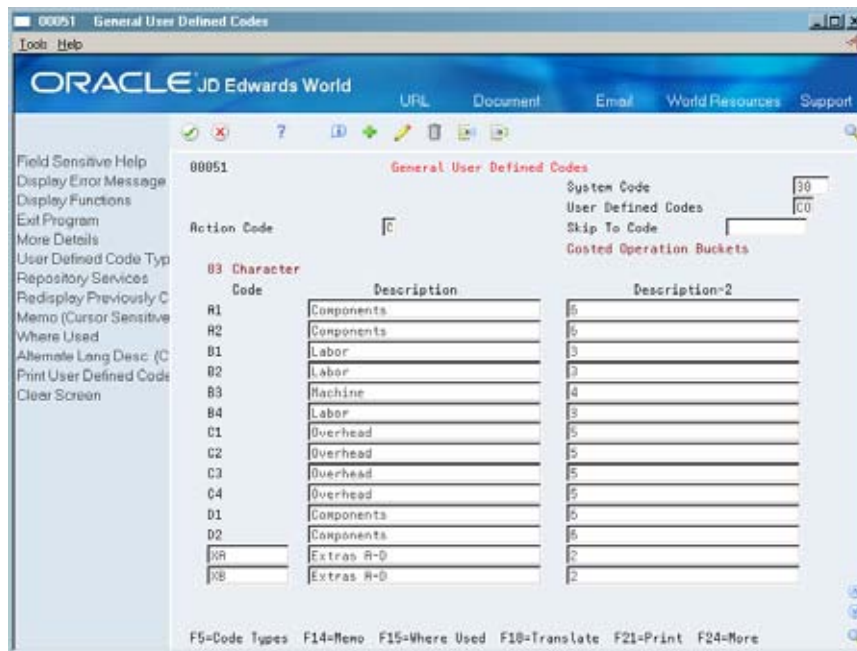

Complete the following fields:

- Code – Cost Component
- Description – Sequence Number
- Description-2

What You Should Know About

Code - Cost Component Designates the cost components to be grouped.

Description - Sequence Number	The name that you want to appear as the heading for the operation bucket column on costed routing inquiries and reports. You only need to enter this title once for each sequence number. If the program finds more than one name for a bucket, it uses the name defined for the last cost component that it accumulates into the operation bucket.
Description 2	Specifies in what column (bucket) each cost component is grouped.

Reviewing a Costed Routing



From Manufacturing Systems (G3), choose **Product Costing**
 From Daily Product Costing (G3014), choose **Costed Routing Inquiry**

Use **Costed Routing Inquiry** to review the summarized costs of an item for each operation in the routing. This information can help you effectively manage production costs. For example, you can:

- View the work center responsible for an operation
- Determine if a work center performs multiple operations
- Display simulated or frozen costs for labor values for cost methods
- Calculate the totals for all costs by cost categories

Note: The program can accumulate purchase costs for up to 999 components on each bill of material. Components beyond 999 are not included in the costing process.

To review a costed routing

On Costed Routing Inquiry

Work Center	Op Seq	Labor	Machine	Overhead	Components	Total
200-203	10.00	5.4699		3.9131	34.5696	43.9526
200-4344	25.00				27.3676	27.3676
200-204	30.00	2.0075		1.1564	104.0000	107.1639
200-204	40.00	1.9050		.8333	4.8400	7.5783
		9.3824		5.9027	170.7772	186.0623

1. Review the following fields:

- As of Date
- Cost Method
- Requested Quantity
- Unit Of Measure
- Up to Operation Sequence
- Extras 1-3
- Extras 4-7
- Work Center
- Operation Sequence Number
- Labor
- Machine
- Overhead
- Components
- Total (row)
- Total (column)

2. Access the Detail screen (Option 5).

30200W Detail

Functions Tools Help

Operation Sequence No 10.00 Assemble shelf unit

Category	Type	Description	Cost
Labor	B1	Direct Labor	2,6750
	B2	Setup Labor	2,1250
	B4	Labor Efficiency	.6690
Overhead	C3	Labor Variable Overhead	2,1344
	C4	Labor Fixed Overhead	1,7707
Components	R1	Material	20,0000
	R2	Scrap	5,7616

3. On Detail, review the following fields:
 - Category
 - (Cost) Type
 - Description
 - Cost
4. On Costed Routing Inquiry, toggle to review frozen or simulated costs (F15).
5. To review an item's operation buckets, access Operation Bucket Key Window (F11).

30C0 Operation Bucket Key Window

Functions Options Tools Help

Labor	Machine	Overhead	Components	Extras 1-3	Extras 4-7
B1	B3	C1	R1	X1	X8
B2		C2	R2	X2	X6
B4		C3	D1	X3	X7
		C4	D2		X4
					X5
					X6
					X7

Field	Explanation
As of	This field is used for effectivity checking. Enter a specific date to display documents (orders, bills of material, routings, as applicable) that are effective on or after that date. The current system date is the default, but you can enter any future or past date.
	<i>Form-specific information</i>
	The routing that is effective as of this date is used.

Field	Explanation
Requested Quantity	<p>The number of parent items you want to process. The system calculates lower-level values in quantity per the number of parent items requested. For example, if 3 components are needed for a parent item, and the requested quantity is 10, the system plans for 30 components.</p>
	<i>Form-specific information</i>
	<p>This is the number of parent items for which you want to see cost breakdowns. Costs are figured in quantity per the parent item.</p>
Op Seq	<p>In routings, this number is used to sequence the fabrication or assembly steps in the manufacture of an item. You can track costs and charge time by operation.</p>
	<p>In bills of material, this number designates the routing step in the fabrication or assembly process that requires a specified component part. You define the operation sequence after you create the routing for the item. The Shop Floor Control system uses this field in the backflush/preflush by operation process.</p>
	<p>In engineering change orders, this number is used to sequence the assembly steps for the engineering change.</p>
	<p>Skip To fields allow you to enter an operation sequence that you want to begin the display of information.</p>
	<p>You can use decimals to add steps between existing steps. For example, use 12.5 to add a step between steps 12 and 13.</p>
	<i>Form-specific information</i>
	<p>Top of form: A processing option controls whether "Skip to" or "Up to" operation sequence mode is in effect.</p>
	<p>In "Skip to" mode, the system uses an entered operation sequence number as the starting point when displaying operations, and displays the total from that point forward on the total line.</p>
	<p>In "Up to" mode, the system uses an entered operation sequence number as the cutoff for displaying operations. The total for all operations up to and including the operation sequence number entered appears on the total line.</p>
	<p>Bottom of form: The Op Seq field contains a number that indicates the order of each step in the manufacturing operation.</p>
Purchased	<p>Work Amount field for the Manufacturing System.</p>
	<i>Form-specific information</i>
	<p>Cost bucket No. 1 as defined for user defined code 30/CO, Operation Buckets. A processing option controls whether the system adds cost bucket 1 (Extras 1-3) and cost bucket 2 (Extras 4-7), at the top of the screen, into the grand total of all costs for the parent item at the bottom of the screen.</p>

Field	Explanation
Work Center	<p>A number that identifies a branch, plant, work center, or business unit.</p> <p><i>Form-specific information</i></p> <p>This is the business unit assigned to the work center for the operation sequence listed.</p>
Labor	<p>Work Amount field for the Manufacturing System.</p> <p><i>Form-specific information</i></p> <p>Cost bucket No. 3 as defined for user defined code 30/CO, Operation Buckets. The total of this column appears at the bottom of the screen in the "Totals" row. The heading above the columns indicates which costs are displayed: frozen or simulated. You can toggle between simulated and frozen values.</p> <p>You also can view a detailed breakdown of the cost components added to determine the total for the work center.</p>
Machine	<p>Work Amount field for the Manufacturing System.</p> <p><i>Form-specific information</i></p> <p>Cost bucket No. 4 as defined for user defined code 30/CO, Operation Buckets. The total of this column appears at the bottom of the screen in the "Totals" row. The heading above the columns indicates which costs are displayed: frozen or simulated. You can toggle between simulated and frozen values.</p> <p>You also can view a detailed breakdown of the cost components added to arrive at the total for the work center.</p>
Overhead	<p>Work Amount field for the Manufacturing System.</p> <p><i>Form-specific information</i></p> <p>Cost bucket No. 5 as defined for user defined code 30/CO, Operation Buckets. The total of this column appears at the bottom of the screen in the "Totals" row. The heading above the columns indicates which costs are displayed: frozen or simulated. You can toggle between simulated and frozen values.</p> <p>You can also view a detailed breakdown of the cost components added to arrive at the total for the work center.</p>
Total	<p>Work Amount field for the Manufacturing System.</p> <p><i>Form-specific information</i></p> <p>This column contains system-calculated totals for each row of costs, that is, for each operation sequence.</p> <p>The totals across the bottom of the screen are the totals of each cost bucket.</p> <p>The rightmost bottom total is the total of all costs for the routing for an item.</p>

What You Should Know About

Displayed costs

This program calculates the cost associated with each cost component in the same way as the Simulate Cost Rollup program.

See also *Appendix A — Calculations in Cost Rollup*.

The costs on Costed Routing Inquiry are real-time costs, so they can change if you update the bill of material or routing for an item. The Enter/Change Cost Components screen displays the costs computed when you run Simulate Cost Rollup. As a result, the values might differ from those on Costed Routing Inquiry if you have changed the bill of material, routing, or manufacturing constants since you last ran the rollup.

Master routings

The program uses the master routing for the item from the Routing Master table (F3003) if all of the following are true:

- The Master Routing field on the Manufacturing Constants screen is set to Y for the branch.
- The parent item has a cross-reference item defined for master routing. (The cross-reference item must be defined with a cross-reference type of MR and the Address field must be blank.)
- The cross-reference item has an item routing defined.

See Also

- *Setting Up Operation Bucket Codes for Costed Routings* (on menu G3042)

Processing Options

See [Costed Routing Inquiry \(P30208\)](#).

Update Frozen Costs

Updating Frozen Costs



From Manufacturing Systems (G3), choose **Daily Product Costing**
From Daily Product Costing (G3014), choose **Frozen Update** or **Frozen Update/WIP Revaluation**

After you perform simulated rollups to determine the effect of changes, you can update your frozen costs with simulated values by running a frozen update. Most companies run this program at the beginning of a new fiscal year to create their manufacturing costs for the next fiscal period.

You can perform simulated rollups and frozen updates for any cost method, except 02. The Manufacturing Accounting system uses frozen standard costs (method 07), unless Actual Cost is indicated in the Manufacturing Constants.

Note: This program uses the costs generated by the most recent run of the Simulate Cost Rollup program. If you have changed information since the last simulated cost rollup, those changes will not be reflected by the frozen update.

The Frozen Update program uses the costs that were generated by the Simulate Cost Rollup program to:

- Update unit costs in the Cost Ledger table (F4105) for the cost method selected
- Update frozen costs in the Cost Components table (F30026) for the cost method selected
- Update labor and overhead rates in the Work Center Master table (F30006)
- Print report totals by company, branch/plant, and G/L category code
- For on-hand balances, create an Item Balance (IB) record in the Item Ledger table (F4111) if the cost method selected matches the sales/inventory cost method for an item, and a journal entry if a net change in value exists.
- For on-hand balances, write journal entries to the Account Ledger table (F0911) in either detail or summary format

An item ledger record is written if the cost method selected for update is the standard (07) cost method or the sales/inventory cost method. The item ledger record indicates a change in inventory value for the updated items. The number of item ledger records written depends on the cost level of the item, which is defined in the Item Master table (F4101). For example, items at cost level 2 would have an item ledger record for each branch/plant at which they are defined, because costs can differ by branch/plant.

For cost level 3, an item ledger record is written for each lot/location.

In addition, if you set the processing option, the program does the following for work in process (WIP):

- Adjusts inventory values in the Work Order Variances table (F3102) for any open orders
- Writes journal entries to the Account Ledger table (F0911) in either detail or summary format

Costs in the Work Order Variances table (F3102) are updated for those open work orders affected by a cost change. In other words:

- The program creates a journal entry only if a work order has an outstanding WIP balance.
- WIP costs are only updated for open work orders (variance flag is less than 3)
- The work order is updated only if it contains an item selected for cost update.

Standard, completed, and scrapped costs are updated using the new parent frozen costs. Current, planned, and actual costs are updated using the new component costs and work center rates (simulated in proof mode and frozen in final mode).

Journal Entries for On-Hand Balances

The program creates journal entries in either detail or summary format that match in amount with the item ledger records. Thus the program maintains integrity between the Item Ledger and the Account Ledger. Use the Item Ledger/Account Integrity report to verify this integrity.

The process flow is as follows:

- The program creates a journal entry only if an item ledger record has been written.
- An item ledger record is written only if an item cost ledger record has been updated.
- An item cost ledger record is updated only if a cost component record has been updated.

The program accesses the following AAIs to obtain the object account.

AAI Table Number	Description	Use
4134	Inventory	Debit to show increase in item cost Credit to show decrease in item cost
4136	Expense or COGS	Debit to show expense or loss Credit to show income or gain

Detail Journal Entries

If you choose detail format, the program creates matching debit and credit account ledger records for every item ledger record created. Use the detail format when you

want a detailed audit trail. If running in detail mode, the work order number can be written to the GL detail Subledger field facilitating research. It is advisable to run the proof in detail mode, followed by a summary mode run.

Summary Journal Entries

If you choose summary format, the program creates debit and credit records by subtotals of company, general ledger category code, and transaction type. Use the summary format to reduce the amount of detail in the general ledger. You can select to run summary journal entries with a detailed report.

Caution: Consider the memory allocation requirements, as the potential volume can be quite large.

Journal Entries for WIP

The program creates journal entries in either detail or summary format that match in amount with the work order costs. Thus the program maintains integrity between the WIP balances and the Account Ledger. Use Variance Inquiry to verify this integrity.

The program accesses the following AAIs to obtain the object account.

AAI Table Number	Description	Use
4136	Expense or COGS	Debit to show expense or loss Credit to show income or gain
3120	WIP	Debit to show increase in WIP costs Credit to show decrease in WIP costs

Detail Journal Entries

If you choose detail format, the program creates matching debit and credit account ledger records for every updated work order. Use the detail format when you want a detailed audit trail. However, consider that the potential volume is large, requiring a lot of memory.

Summary Journal Entries

If you choose summary format, the program creates debit and credit records by subtotals of company, general ledger category code, and transaction type. Use the summary format to reduce the amount of detail in the general ledger. You can still run a report as a detailed audit trail.

Before You Begin

- Ensure that you have set up item cost levels on the initial Item Master Information form. See *Setting Up Item Cost Levels*.

What You Should Know About

Ensuring Manufacturing Work Orders are Closed

For a manufacturing work order to be considered closed, the variance flag (PPFG) on the work order header must have a value of 3. To achieve this, set the processing options on the variance program as follows:

#9 Enter a value greater than or equal to 11.

Note: You can only view this field by file utility.

Reports

The program produces the following reports:

Report	Description
Item Cost Ledger Exception report	The program produces this report if it finds any general ledger errors while formatting the journal entries. The report lists an error message once for the same combination of AAI number, account number, and G/L category code. Correct any errors and run the Frozen Update program again.
Frozen Standard Update report	This report shows the effect of the inventory revaluation based on the changes made to the cost revisions records for the inventory items. You can print all items or only those that have a cost change. You can run the report in proof mode or final mode. The report provides the following information: <ul style="list-style-type: none"> ▪ Old and new costs for each updated item ▪ Variances between old and new costs ▪ Item quantity on hand ▪ Net amount of change in cost ▪ Summary of the amount changed by item general ledger category (facilitates any manual journal entries required) ▪ G/L exception errors ▪ Whether G/L transactions have been written ▪ Either G/L subtotals by company and G/L category code or G/L category code only
WIP Revaluation Exception report	If you choose to do WIP revaluation, the program produces this report if it finds any general ledger errors while formatting the journal entries. An error message is printed once for the same combination of AAI number, account number, and G/L category code. Correct any errors and run the Frozen Update program again.

Report	Description
WIP Revaluation Update report	<p>If you choose to do WIP revaluation, this report shows the effect of the inventory revaluation based on the changes made to the cost revisions records for the inventory items. The report lists all open work orders that use any of the items whose costs have changed. You can run the report in proof mode or final mode. The report provides the following information:</p> <ul style="list-style-type: none"> ▪ Old and new WIP balance for each work order ▪ Variances between old and new WIP balance ▪ Net amount of change in WIP ▪ G/L transactions, if requested, in either detail or summary format ▪ WIP Revaluation journal entries can be viewed from G3116, number 9.

30834	JD Edwards World	Page 1
	Item Cost Ledger Update - Final Mode	Date 4/03/17
	G/L Exception Report	
Batch Number . . . 129171		
Batch Date 04/03/17		
Account Number	G/L AAI Do G/L Date Numb Ty Cat	Error Messages

No Errors Found		

30835	JD Edwards World	Page - - - 3							
	Item Cost Ledger Update - Final Mode	Date - - - 4/03/17							
Batch Number . . . FINAL									
Batch Date									
J/E Mode Detailed									
Cost Method 07 Standard									
Item Number	Branch	Location	Lot	G/L Cat	Old Cost	New Cost	Variance	Qty on Hand	Net Change
111	M30			IN20	13.0000	13.0000	.0000		
121	M30			IN20	14.8527	14.8527	.0000	140960	
122	M30			IN20	.0700	.0700	.0000	597336	
123	M30			IN20	4.0000	4.0000	.0000		
212	M30			IN20	15.9607	15.9607	.0000		
333	M30			IN20	261.6500	260.5662	1.0838-	5931	6428.02-
								5931	6428.02-

30837	JD Edwards World	Page - 1
	WIP Re-Valuation Update	Date - 2/12/17
	G/L Exception Report	
Batch Number . . . PROOF		
Batch Date		
Account Number	G/L AAI Do G/L Date Numb Ty Cat	Error Messages

No Errors Found		

Update Frozen Costs

30838		JD Edwards World		Page	-	1		
		WIP Re-Valuation Update		Date	-	2/12/17		
Batch Number . . . PROOF								
Batch Date . . .								
J/E Mode . . . Detailed								
Cost Method. . . 07 Standard								
Document.	Item Number	Co	Branch	G/L Cat	Old Total WIP Cost	New Total WIP Cost	WIP Variance	Original Quantity
00157147	772481-PC3	12020	12-20	IN20	55.50	59.50	4.00	2.0000
Report Total. . . .					55.50	59.50		

30838		JD Edwards World		Page	-	2	
		WIP Re-Valuation Update		Date	-	2/12/17	
Batch Number . . . PROOF							
Batch Date . . .							
J/E Mode . . . Detailed							
Cost Method. . . 07 Standard							
G/L RECAP							
Do Document Ty	G/L Date	Co	Account Description Explanation	G/L Account Amounts		LT
					Debit	Credit	
IB	157147	02/12/17	12020 Material	12-20.1710.A1	6.00		AA
			WIP Revaluation				
IB	157147	02/12/17	12020 Labor	12-20.1720.B1	7.00		AA
			WIP Revaluation				
IB	157147	02/12/17	12020 Machine	12-20.1720.B3	2.00-		AA
			WIP Revaluation				
IB	157147	02/12/17	12020 Fixed Machine	12-20.1730.C2	7.00-		AA
			WIP Revaluation				
IB	157147	02/12/17	12020 Physical Inventory & Adjs	12-20.6310			4.00- AA
			WIP Revaluation				
Doc. Total					4.00	4.00-	
Number of Documents, if Detailed				1			

See Also

- *Creating Journal Entries (P31802)* for more information on detail and summary journal entries
- *Reviewing the Item Ledger/Account Integrity Report (P41543)*

Processing Options

See [Item Cost Update \(P30835\)](#).

Review Costing Information

Reviewing Costing Information

After you run the Frozen Update program to revalue your inventory, you should review the updated costing information. These costs stay in effect until you run the update again.

This section contains the following:

- [Reviewing Frozen Cost Components](#)
- [Reviewing the Item Ledger](#)
- [Reviewing the Single Level Costed Bill of Material Report](#)
- [Reviewing the Multi-Level Costed Bill of Material Report](#)
- [Reviewing the Cost Components Report](#)
- [Reviewing the Cost Integrity Report](#)

Reviewing Frozen Cost Components



From Manufacturing Systems (G3), choose Product Costing From Daily Product Costing (G3014), choose Enter/Change Cost Components
--

After you run the Frozen Update program to revalue your inventory, review the frozen costs.

To review frozen cost components

On Enter/Change Cost Components

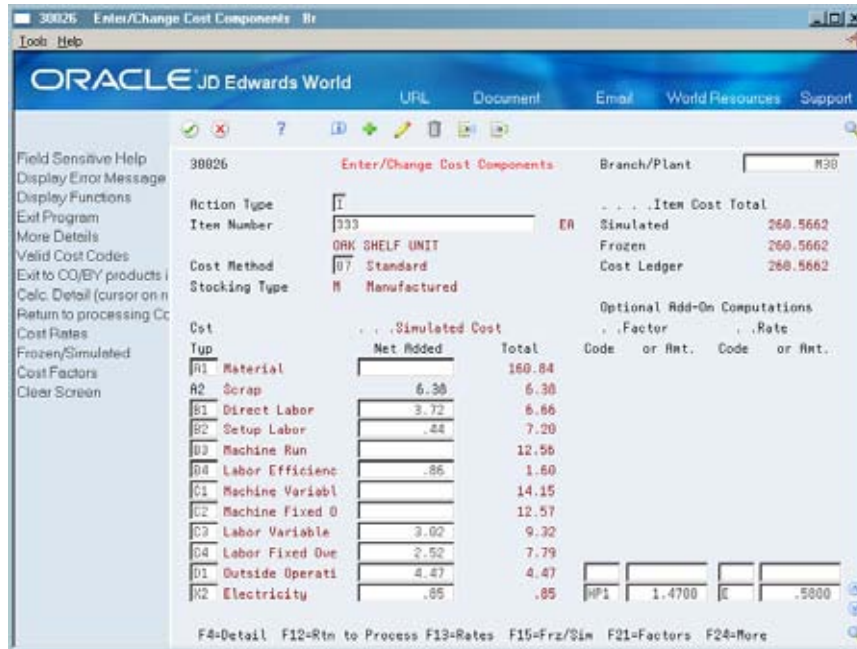

1. Review the following field:

- Item Cost Total Frozen

2. Access the detail area (F4).

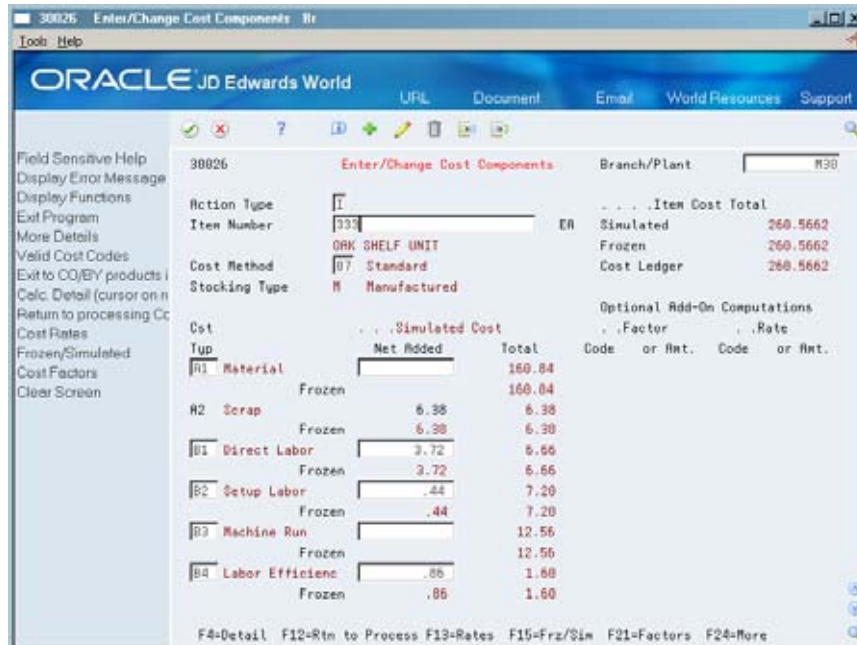

3. Toggle (F15) to review frozen or simulated costs.

Field	Explanation
Frozen	The accumulated standard cost rolled up from lower levels.

Reviewing the Item Ledger

	From Manufacturing Systems (G3), choose Product Costing From Daily Product Costing (G3014), choose Item Ledger
---	---

Use Item Ledger to view Item Balance (IB) transactions for an item. The Frozen Update program transfers IB transactions to the item ledger if all of the following are true:

- The frozen cost changes in the Cost Ledger table (F4105) for a given cost method
- That cost method is used as the sales/inventory cost method
- A quantity on hand exists

You can view ledger information in five formats, depending on the processing options you choose:

- Real-time history (standard format)
- Running quantity balance (to review transactions with running quantity balances as of a specified general ledger date)
- Running amount balance (to review transactions with running amount balances as of a specified general ledger date)
- Location item ledger format (for warehouse management)
- Lot status, grade, potency item ledger format (for bulk inventory)

To review the item ledger

On Item Ledger

4111 Item Ledger

ORACLE JD Edwards World

Item Number: 333, Branch/Plant: H30, Location: *
 ORK SHELF UNIT, Memphis Mfg. Plant

Quantity on Hand: 5931 ER
 Value: 1,545,418.13

Document	Ty	Date	Branch/Plant	Quantity	UM	Unit Cost	Ext. Cost
110009	IC	10/29/16	H30	16252	ER	109.7796	3,064,290.06
117962	IC	06/29/16	H30	14043	ER	189.7796	2,665,074.92
117930	IC	04/29/16	H30	11235	ER	109.7796	2,132,173.01
117082	IC	01/30/16	H30	8248	ER	189.7796	1,565,302.14
110120	IC	04/06/15	H30	3212	ER	189.7796	609,572.08
110111	IC	01/16/15	H30	2104	ER	109.7796	414,478.65
30835	IB	03/29/14	H30		ER	70.7866	419,835.32
3114	RI	12/16/13	H30	5832-	ER	189.7796	1,106,794.63-
3111	RI	12/16/13	H30	4640-	ER	109.7796	000,577.34-
3109	RI	12/16/13	H30	4666-	ER	189.7796	885,511.61-
3105	RI	12/16/13	H30	4635-	ER	189.7796	879,628.45-

Opt: 5=Details F5=Item Search F10=Ledger/Running Balance F24=More Keys

1. Enter IB in the following field:

- Document Type

2. To review running quantity balances, access Running Balance (F10).

4111 Item Ledger

ORACLE JD Edwards World

Item Number: 333, Branch/Plant: H30, Location: *
 ORK SHELF UNIT, Memphis Mfg. Plant

Dt From/G/L: 12/31/06
 Dt Thru/G/L: *

Document	Ty	Date	Branch/Plant	Unit Cost	Quantity	Quantity Balance
41026		06/15/12	H30	.0000		
30835	IB	03/29/14	H30	70.7866		
1031	RI	02/15/15	H30	189.7796	750-	750-
1033	RI	03/16/15	H30	189.7796	750-	1500-
1038	RI	04/16/15	H30	189.7796	676-	2184-
1040	RI	05/16/15	H30	189.7796	1014-	3198-
1042	RI	06/16/15	H30	189.7796	1104-	4302-
1044	RI	07/16/15	H30	189.7796	1094-	5396-
1046	RI	08/16/15	H30	189.7796	1431-	6827-
1048	RI	09/16/15	H30	189.7796	1573-	8400-
1050	RI	10/16/15	H30	189.7796	1614-	10014-

Opt: 5=Details F5=Item Search F10=Ledger/Running Balance F24=More Keys

Use this format to tie inventory balances to the general ledger or to view balance information as of a period or fiscal year end. The program calculates the balance and displays item ledger records by general ledger date in ascending order.

3. On Running Balance, review the following fields:
 - Date From G/L and Date Through G/L
 - Quantity Balance
4. Access the Details form (Option 5).

The screenshot shows a window titled '4111W Item Ledger Information'. The fields displayed are:

Branch/Plant	M30
Item Number	333
Description	DRK SHELF UNIT
Location	
Lot/SN	
Quantity	ER
Unit Cost	70.7066
Extended Cost	419,835.32
Document	30835 IB
Trans Date	03/29/14
Creation Date	03/29/14
Time of Day	11:50:40
G/L Date	03/29/14
User ID	DEMO
Batch Number	
Work Station	J30035
Reference	Program ID P30035
Lot Status Code	Approved
Lot Grade	
Lot Potency	
Quantity Balance	
Amount Balance	419,835.32
Lot Exp Date	
Posted Edit Code	
Posted to Summary	
To Be Purged	
Reason Code	
Explanation	Manufacturing Cost Change
Supplier	

Note: For manufacturing transactions (document types IM and IC), the G/L date and batch number do not appear until you process journal entries for manufacturing accounting. These transactions do not appear in the running balance until you run Journal Entries for Work in Process or Completions.

Field	Explanation
Document Type	<p>A user defined code (system 00/type DT) that identifies the origin and purpose of the transaction.</p> <p>JD Edwards World reserves several prefixes for document types, such as vouchers, invoices, receipts, and timesheets.</p> <p>The reserved document type prefixes for codes are:</p> <p>P Accounts payable documents</p> <p>R Accounts receivable documents</p> <p>T Payroll documents</p> <p>I Inventory documents</p> <p>O Order processing documents</p> <p>J General ledger/joint interest billing documents</p> <p>The system creates offsetting entries as appropriate for these document types when you post batches.</p>

Field	Explanation
Dt From/Trans	The beginning date in the date range. This is the date from which you want the system to display information.
Dt Thru/Trans	The ending date in the date range. This is the date through which you want the system to display information. If you leave this field blank, the system uses the current period.
Quantity Balance	The total quantity requested.

Processing Options

See [Item Ledger - Costs \(P4111\)](#).

Reviewing the Single Level Costed Bill of Material Report

	From Daily Product Costing (G3014), choose Periodic Product Costing From Periodic Product Costing (G3023), choose Costed Bill
---	--

Use the Costed Bill program to create a report that lists the total cost of parent items detailed by component costs. Use this information to develop more accurate financial plans by monitoring product costs.

You can customize this report to help you in your analysis. For example, you can:

- Process the report using any valid cost method
- Process the report for simulated or frozen costs
- Specify a date for the program to use as a criterion when accessing information
- Print all product costs and user defined categories on the report
- Print the report for one branch, selected branches, or all branches

This report presents the component costs in five user defined cost buckets. In addition, the program totals the cost buckets for each item. Each cost bucket can contain several cost components, depending on how you set up your user defined codes.

30440	JD Edwards World		Page	-	1
	Costed Bill - Current Cost		Date	-	1/31/17
Cost Method 07 Standard					
Requested Quantity 1					
Item Number/Description	Branch	Quantity	UM Purchase	Simulated Costs	
				Labor	Machine Overhead Extras

212	M30	1	EA	4.6500	1.0575 1.8567
OAK SHELF SIDES					
111	M30	1	EA	13.0000	
1x10x6' OAK S4S					

Parent Item Number				13.0000	4.6500 1.0575 1.8567
Batch Quantity			EA		
Accounting Cost Qty.		100	EA		

					7.5642
					13.0000
					20.5642

See Also

- Setting Up Cost Bucket Codes for Costed Bills of Material (P00051, 30/CB)

Processing Options

See [Costed Bill \(P30440\)](#).

Reviewing the Multi-Level Costed Bill of Material Report



From Daily Product Costing (G3014), choose **Periodic Product Costing**
From Periodic Product Costing (G3023), choose **Multi-Level Costed Bill**

Use the Multi-Level Costed Bill program to create a report that lists the total cost of parent items detailed by component costs. Use this information to develop more accurate financial plans by monitoring product costs.

You can customize this report to help you in your analysis. For example, you can:

- Specify the number of units that the program costs when you run the report
- Process the report using any valid cost method
- Process the report for simulated or frozen costs
- Specify a date for the program to use as a criterion when accessing information
- Print all product costs and user defined categories on the report
- Print the report for one branch, selected branches, or all branches

This report presents the component costs in five user defined cost buckets. In addition, the program totals the cost buckets for each item. Each cost bucket can contain several cost components, depending on how you set up your user defined codes.

30445		JD Edwards World						Page	1
		Multi-Level Costed Bill Report						Date	2/21/17
Cost Method 07 Standard									
Requested Quantity 1									
Level	Item Number/Branch	Description	S I B T Purchase	Labor	Frozen Costs Machine	Overhead	Extras	Total	
0	2214	CRT Keyboard Fea F I							
	M30	Unit Cost							
1	2215	CRT 3180 Style K P I		42.0000				42.0000	
	M30 Qty P	1 EA Unit Cost		42.0000				42.0000	
1	2216	CRT AT Style Key P I		42.0000				42.0000	
	M30 Qty P	1 EA Unit Cost		42.0000				42.0000	
	Batch Quantity	EA							
	Accounting Cost Qty. . . .	1 EA							
0	5120	Oak Desk With Ch M I		677.3400	368.1829	24.7071	595.1073	1665.3373	
	M30	Unit Cost			23.0380		25.3419	309.4224	
1	4277	FRAMING KIT, 30x P I		47.3900				47.3900	
	M30 Qty P	1 EA Unit Cost		47.3900				47.3900	
1	4133	SIDE ASSY, 30x30 M I		140.0000	206.8332	1.5340	364.3240	712.6912	
	M30 Qty P	4 EA Unit Cost			8.0313		8.8344	16.8657	
.2	3390	LEG OAK, 1.5x1.5 M I		22.2800	41.5520	.3250	79.7746	143.9316	
	M30 Qty P	2 EA Unit Cost			20.7760	.1625	39.8873	60.8258	
.3	2611	OAK BOARD, 2x2x1 P I		10.2300				10.2300	
	M30 Qty P	1 EA Unit Cost		10.2300				10.2300	
.3	2417	LEG CAP, 1.5x1.5 P I		.9100				.9100	
	M30 Qty P	1 EA Unit Cost		.9100				.9100	
.2	3386	SIDE PANEL, OAK, M I		12.7200	2.1250	.0585	2.4720	17.3755	

See Also

- *Setting Up Cost Bucket Codes for Costed Bills of Material (P00051, 30/CB)*

Processing Options

See [Multi-Level Costed Bill \(P30445\)](#).

Reviewing the Cost Components Report

	From Daily Product Costing (G3014), choose Periodic Product Costing From Periodic Product Costing (G3023), choose Cost Components
---	--

Use the Cost Components program to create a report that displays the component costs and total cost for each item. This information comes from the Enter/Change Cost Components form.

You can customize this report to meet your specific needs. For example, you can:

- Process the report using any valid cost method.
- Review the cost type and description by item number.
- Identify items.
- Define the exact information to appear on the report from data selection options. For example, you can select specific items and choose whether to include factors or rates for add-on and extra costs.
- Print the report for a single item, several items, or all items.

You can include any of the cost components you define for an item in the cost bucket that you specify.

30026P		JD Edwards World		Page	2				
		Cost Components		Date	6/19/17				
Item Number	Item Description	Cst Typ	Cost Description	Simulated Cost Net Added	Simulated Cost Total	Optional Add-On Component Code	Factor	Component Code	Rate
Cost Method.	04 Current	Branch	M30						
1007	MAHOGANY, 8x10x.50in	A1	Material	4.2200	4.2200				
			2nd Item Number.	4.2200	4.2200				
1008	PLYWOOD, 30x60x.50, ACA	A1	Material	3.9300	3.9300				
			2nd Item Number.	3.9300	3.9300				
111	1x10x6' OAK S4S	A1	Material	13.0000	13.0000				
			2nd Item Number.	13.0000	13.0000				
1122	CRT AS/400 Compatible	A1	Material		362.5410				
		B1	Direct Labor		.0197				
		B2	Setup Labor		.1949				
		B3	Machine Run		.0112				
		B4	Labor Efficiency		.0035				
		C1	Machine Variable Overhea		.0140				
		C2	Machine Fixed Overhead		.0117				
		C3	Labor Variable Overhead		.1588				
		C4	Labor Fixed Overhead		.1490				
			2nd Item Number.		363.1038				
1127	OAK BOARD, 12x24x.75	A1	Material	5.2800	5.2800				
			2nd Item Number.	5.2800	5.2800				
121	OAK SHELF TOP/BOTTOM	A1	Material		13.0000				
		B2	Setup Labor	.0155	.0155				
		B3	Machine Run	.0007	.0007				
		C1	Machine Variable Overhea	.0005	.0005				
		C2	Machine Fixed Overhead	.0006	.0006				
		C3	Labor Variable Overhead	.0147	.0147				
		C4	Labor Fixed Overhead	.0155	.0155				
			2nd Item Number.	.0475	13.0475				

See Also

- Setting Up Cost Bucket Codes for Costed Bills of Material (P00051, 30/CB)

Processing Options

See [Cost Components \(P30026P\)](#).

Reviewing the Cost Integrity Report

	From Daily Product Costing (G3014), choose Periodic Product Costing From Periodic Product Costing (G3023), choose Cost Integrity
---	---

Use the Cost Integrity program to create a report that compares the sum of the frozen standard cost components on the Enter/Change Cost Components screen and the unit cost in the Cost Ledger table (F4105) and lists variances. For cost level 3 items, the program uses the unit cost for the primary location of the item in the Cost Ledger table.

30543		JD Edwards World			Page -	2	
		Cost Component/Ledger Integrity			Date -	6/19/17	
Branch	Item Number	Description	Stock Type	Cost Mthd	Cost Rollup	Cost Ledger	Variance
M30	1122	CRT AS/400 Compatible	K Manuf	04	363.1038	363.1038	
	1122	CRT AS/400 Compatible	K Manuf	05	363.1038	363.1038	
	1122	CRT AS/400 Compatible	K Manuf	07	363.1038	363.1038	
	2434	CRT Chassis Subassembly	M Manuf	04	294.1038	294.1038	
	2434	CRT Chassis Subassembly	M Manuf	05	294.1038	294.1038	
	2434	CRT Chassis Subassembly	M Manuf	07	294.1038	294.1038	
	2954	AS/400 Mother Board 22314	M Manuf	04	57.7360	57.7360	
	2954	AS/400 Mother Board 22314	M Manuf	05	57.7360	57.7360	
	2954	AS/400 Mother Board 22314	M Manuf	07	57.7360	57.7360	
	2556	Printed Circuit Board 12227	F Purch	04	18.3700	18.3700	
	2556	Printed Circuit Board 12227	F Purch	05	18.3700	18.3700	
	2556	Printed Circuit Board 12227	F Purch	07	18.3700	18.3700	
	1990	Board Sockets 88339	F Purch	04	2.0200	2.0200	
	1990	Board Sockets 88339	F Purch	05	2.0200	2.0200	
	1990	Board Sockets 88339	F Purch	07	2.0200	2.0200	
	1827	Dip Swith, 192177 CRT	F Purch	04	5.3200	5.3200	
	1827	Dip Swith, 192177 CRT	F Purch	05	5.3200	5.3200	
	1827	Dip Swith, 192177 CRT	F Purch	07	5.3200	5.3200	
	1552	Audible Alarm, CRT Mother	F Purch	04	16.3700	16.3700	
	1552	Audible Alarm, CRT Mother	F Purch	05	16.3700	16.3700	
	1552	Audible Alarm, CRT Mother	F Purch	07	16.3700	16.3700	
	2403	Crt Graphics Card	F Purch	04	17.9000	17.9000	
	2403	Crt Graphics Card	F Purch	05	17.9000	17.9000	
	2403	Crt Graphics Card	F Purch	07	17.9000	17.9000	
	2899	AS/400 CRT Chassis Frame	M Manuf	04	201.9799	201.9799	
	2899	AS/400 CRT Chassis Frame	M Manuf	05	201.9799	201.9799	
	2899	AS/400 CRT Chassis Frame	M Manuf	07	201.9799	201.9799	
	2298	AS/400 Chassis Main Frame	M Manuf	04	26.7090	26.7090	
	2298	AS/400 Chassis Main Frame	M Manuf	05	26.7090	26.7090	
	2298	AS/400 Chassis Main Frame	M Manuf	07	26.7090	26.7090	
	1999	Sheet Metal 12.7 X 16.2	F Purch	04	26.5510	26.5510	
	1999	Sheet Metal 12.7 X 16.2	F Purch	05	26.5510	26.5510	
	1999	Sheet Metal 12.7 X 16.2	F Purch	07	26.5510	26.5510	
	1770	AS/400 Chassis Frame Supports	M Manuf	04	87.5924	87.5924	
	1770	AS/400 Chassis Frame Supports	M Manuf	05	87.5924	87.5924	
	1770	AS/400 Chassis Frame Supports	M Manuf	07	87.5924	87.5924	

Processing Options

See [Cost Component/Ledger Integrity \(P30543\)](#).

Work with Additional Costing Features

Working with Additional Costing Features

You can use several additional features to work with costing information. You can copy costs for an item from one cost method to another. You can reset your simulated costs to their frozen values. You can update the costs in your sales orders with the most current cost values. You can update costs for an item globally, using an amount or a percentage change.

This section contains the following:

- [Copying Costs](#)
- [Copying Frozen Costs to Simulated Costs](#)
- [Updating Sales Order Price/Cost](#)
- [Updating Product Costs](#)

Copying Costs



From Daily Product Costing (G3014), choose Periodic Product Costing From Periodic Product Costing (G3023), choose Copy Costs

Use Copy Costs to copy the simulated or frozen costs and work center rates from one cost method to the simulated costs for another cost method. You can also copy work center rates between cost methods within the same work center.

Based on the processing option values, the program copies information in the Cost Components table (F30026) and the Work Center Rates table (F30008) to update costs for the cost method and branches you specify. You can only replace *simulated* costs, not frozen costs, in the *copy to* branch. Run the Frozen Update program to update frozen costs.

Caution: To ensure acceptable results, JD Edwards World recommends that you plan your choices carefully and write them down before you enter them. This program does not generate a report of the updated costs.

Processing Options

See [Copy Component Cost Values \(P30890\)](#).

Copying Frozen Costs to Simulated Costs

	From Daily Product Costing (G3014), choose Periodic Product Costing From Periodic Product Costing (G3023), choose Reset Simulated Costs
---	--

For the cost method and branches you choose, use **Reset Simulated Costs** to reset simulated costs to their frozen values. Resetting costs allows you to begin a simulation again.

Processing Options

See [Cost Simulation Reset \(P30850\)](#).

Updating Sales Order Price/Cost

	From Sales Order Management (G42), choose End of Day Processing From End of Day Processing (G4213), choose Update Sales Price/Cost
---	---

Use the **Update Sales Price/Cost** program to update the unit and extended cost in your sales orders with the most current cost values specified in the **Cost Ledger table (F4105)**. If multi-currency processing is active in the system, the program updates the **Foreign Unit** and **Extended Cost** fields as well. Use data selections to designate particular information to be processed.

Caution: When you run this program, the system updates your live sales order detail information. Therefore, JD Edwards World recommends extreme caution in setting up data selections.

See Also

- *Updating Prices for a Customer (P42950) in the Sales Order Management Guide*

Processing Options

See [Update Sales Cost, Price, or Exchange Rate \(P42950\)](#).

Updating Product Costs

	From Inventory Management (G41), choose Inventory Price/Cost Updates From Inventory Price/Cost Updates (G4123), choose Speed Cost Maintenance
---	--

Use **Speed Cost Maintenance** to update costs for purchased items in the branch/plants, locations, and lots you choose. You can increase or decrease costs by a percentage or dollar amount, or you can specify a new dollar amount. You also specify the cost method for which you want to update costs.

See Also

- *Setting Up Item Costs (P4105)*
- *Updating Item Costs (P4105) in the Inventory Management Guide*

To update a product's cost

On Speed Cost Maintenance

1. To locate current cost information for an item, complete the following fields:
 - Item Number
 - Branch/Plant (if applicable)
 - Cost Method to Update
2. Complete the following fields:
 - Increase/Decrease Amount
 - Amount Type (A % *)
 - Unit Cost

Field	Explanation
Increase / Decrease Amount:	<p>The dollar amount or percentage by which you want to increase or decrease unit costs for items. You can also indicate a different amount to override current unit costs. The value you specify in the Amount Type field determines whether you enter an amount or a percentage.</p> <p>Note: Enter percentages as whole numbers. For example, enter 10 to increase costs by 10%. To decrease costs, enter a negative sign before the number. For example, enter -10 to decrease costs by 10%.</p> <p style="text-align: center;"><i>Form-specific information</i></p> <p>The system changes all costs for all locations.</p>
Unit Cost	<p>Depending on the cost method, this data can come from various sources, for example, purchasing or the cost rollup.</p> <p style="text-align: center;"><i>Form-specific information</i></p> <p>The cost for one unit of this item, based on the corresponding cost method.</p>
Amount Type (A % *)	<p>A code that indicates whether the number in the Increase/Decrease Amount field is an actual amount or a percentage value. Valid codes are:</p> <p>A Amount % Percentage * Cost Override Amount</p>

What You Should Know About

Displayed information	<p>The information that appears on Speed Cost Maintenance depends on the cost level for the item. For example, if an item has a cost level of 2, the system displays costs for all branch/plants. If an item has a cost level of 3, the system displays costs for all locations at the branch/plant you specify.</p> <p>See Setting Up Item Cost Levels.</p>
------------------------------	--

Processing Options

See [Item Cost Revisions \(P4105\)](#).

3 Product Costing in ERPx Environments

Overview to Product Costing in ERPx Environments

Objectives

- To learn how batches must be set up to calculate costs correctly
- To understand how kit items are costed
- To understand how co-/by-products are costed at an operation level
- To understand how configured items are costed

About Product Costing in ERPx Environments

If you use the Product Costing system in any special environment (using batches, kits, rate schedules, processes, or configured items), the system calculates product costs differently.

Understanding product costing in ERPx environments requires the following:

- Understanding batch product costing
- Understanding product costing for kit items
- Working with process industry costing
- Understanding configured items

Understand Batch Product Costing

About Batch Product Costing

For bills of material and routings, you can have a batch quantity for products that are normally built in specific batch sizes, such as chemicals, food, or petroleum.

To obtain a correct rollup when you use a batch quantity, the accounting cost quantity, the bill of material batch size, and the routing batch size must match, as follows:

- Labor and overhead costs are rolled up only if the accounting cost quantity and the routing batch size match.
- Material costs are rolled up only if the accounting cost quantity and the bill of material batch size match.

The following table illustrates these possibilities.

Accounting Cost Quantity	Bill Batch Size	Routing Batch Size	Rollup
10,000	10,000	10,000	Complete
5,000	10,000	10,000	None
10,000	5,000	10,000	Labor and Overhead Only
10,000	10,000	5,000	Material Only

If the Simulate Cost Rollup program does not find a bill of material whose batch quantity matches the accounting cost quantity, it uses the zero batch bill. ACQ is the primary UOM.

What You Should Know About

Displayed quantities

Quantities displayed on Costed Bill and Enter/Change Cost Components are expressed per each unit of measure, not batch quantity.

See Also

- *Working with Bills of Material (P3002) in the Product Data Management Discrete Manufacturing Guide*

Understand Product Costing for Planning Items

About Product Costing for Planning Items

When you use planning bills to support forecasting with options, the Simulate Cost Rollup program calculates the average cost of the parent phantom based on the feature costing percentage, as follows:

- The parent phantom must have a stocking type of M (manufactured). The options can be manufactured or purchased.
- The feature costing percentages of the components are user defined on the bill of material.
- The Simulate Cost Rollup program multiplies the feature costing percentage by the cost of the option (from the branch/plant table) to determine the option's share of the parent phantom's average cost.
- The program then adds dollar amounts for each option to determine the average cost for the parent phantom.

The following diagram illustrates an example of product costing for a kit item.

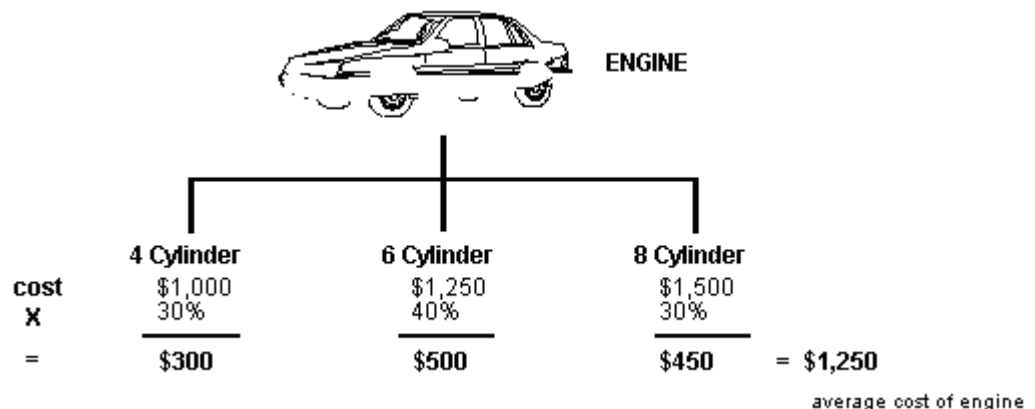

Non-Stock Kit Items

When a non-stock item is included as part of kit, the cost and price records (F4105 and F4106) for the non-stock items are not used with kit components. Since the item cost and price records are not used by the system, the sales order process looks to the Bill of Material Unit Cost and Unit Price fields when a sales order for a kit containing the non-stock item is created.

When a non-stock item is set up in the Item Master the system does not require an Item Branch / Plant record. That non-stock item may be included as a component of a kit. If the component is added to a kit, the Enter / Change Bill of Material program (P3002) may require a branch record if processing option # 1 in P3002 is turned on to validate for an Item Branch/Plant record.

These fields are not used for any manufacturing costing or accounting. These fields are only used for costing / pricing on sales orders when a non-stock item is part of a kit.

Non-stock items cannot be sold independently (as a stand-alone item) because the sales order process looks for a location record and location records cannot be created for non-stock items.

The setup of a non-stock item in a kit involves the following Item Master information:

- Stocking type N
- Line type N

Note: JD Edwards World recommends leaving Processing Option #1 for P3002 off, or the system requires an Item/Branch record in order for the item to be listed on the kit Bill of Material. The F4105 and F4106 records do not need to be populated and are not used.

See Also

- *Entering Planning Bills (P3002) in the Forecasting Guide*

Work with Process Industry Costing

Working with Process Industry Costing

Process manufacturing creates a product by mixing, separating, forming, or performing chemical reactions. This is usually a two-step procedure, which consists of a mixing or blending step, followed by a filling or packaging step. This type of manufacturing can also include intermediate steps, such as curing, baking, or fermenting.

Process manufacturing companies create a variety of items, including:

- Liquids
- Fibers
- Powders
- Gases

Pharmaceuticals, foods, and beverages are specific examples.

A process includes ingredients (equivalent to parts on a work order) and a process routing or recipe. The output from a process includes intermediates, by-products, and co-products.

Output	Description
Intermediate	The output from an operation that is used as the input to the next operation. There is no cost associated with an intermediate.
By-Product	The material produced incidental to or as a residual of the process.
Co-Product	An end item produced as a result of the process. There are usually two or more co-products from a process.

The following illustrates an example of a process.



Process - Potato Chips

Ingredients	Routing	Co-product and By-product
Potato Slices	10 Starch wash potatoes	
	20 Drain water	BY → Waste Water
	30 Add water, soak	
	40 Drain water	BY → Waste Water
Frying Oil	50 Deep fry	BY → Used Frying Oil
Seasoning	60 Add seasoning	
	70 Package	
Nitrogen	80 Add preservatives	CO → Potato Chips

You define a process item with ingredient relationships. These relationships also determine co-products, by-products, intermediates, and substitutions.

You define the steps that are required to produce a manufactured item with process routings. These routings also determine work centers and labor standards.

This section contains the following:

- [Reviewing Product Costing for Processes](#)
- [Reviewing Product Costing for Intermediates](#)
- [Reviewing Product Costing for Ingredients](#)
- [Reviewing Product Costing for Co- and By-Products](#)
- [Calculating Costs for Co- and By-Products](#)
- [Reviewing a Costed Process](#)
- [Reviewing Product Costing for Percent Bills of Material](#)

See Also

- About Process Manufacturing in the Shop Floor Control Process Manufacturing Guide

Reviewing Product Costing for Processes



From Product Data Management (G30), choose **Daily PDM Process**
From Daily PDM Process (G3012), choose **Enter/Change Process**

Review process manufacturing to note the differences from discrete manufacturing in the input and output of costing.

To review product costing for a process

On Enter/Change Process

3003 Enter/Change Process

Oracle JD Edwards World

Branch/Plant: 040

Process Type: P

Line/Cell: P

Action Code: F

Process: 200 Ethanol Process

Batch Quantity: 100

As of Date: P

Skip to Operation: P

Work Center	Oper Seq#	Description	Run Hours			Setup Hours	P
			Mach	Labor	Hours		
200-4004	10.00	Grate potatoes with water	.00		.10	C	
200-4004	20.00	Add liquids from other process		.10		C	
200-4011	30.00	Transfer liquid to vats		.20		C	
200-4011	40.00	Add yeast killer		.01		C	
200-4013	50.00	Transfer to fermentation	3.00			P	
200-4012	60.00	Separate solids from liquids		1.00		P	
200-4014	70.00	Distillation of liquids	6.00			C	
200-4014	80.00	Add contaminants		.30		C	

Opt:1=Ingredients 2=C/B Products 3=Intermediates F6=Item Search F24=More

1. Review the following fields:
 - Machine Run Hours
 - Labor Run Hours
 - Setup Hours
2. Access the detail area (F4).

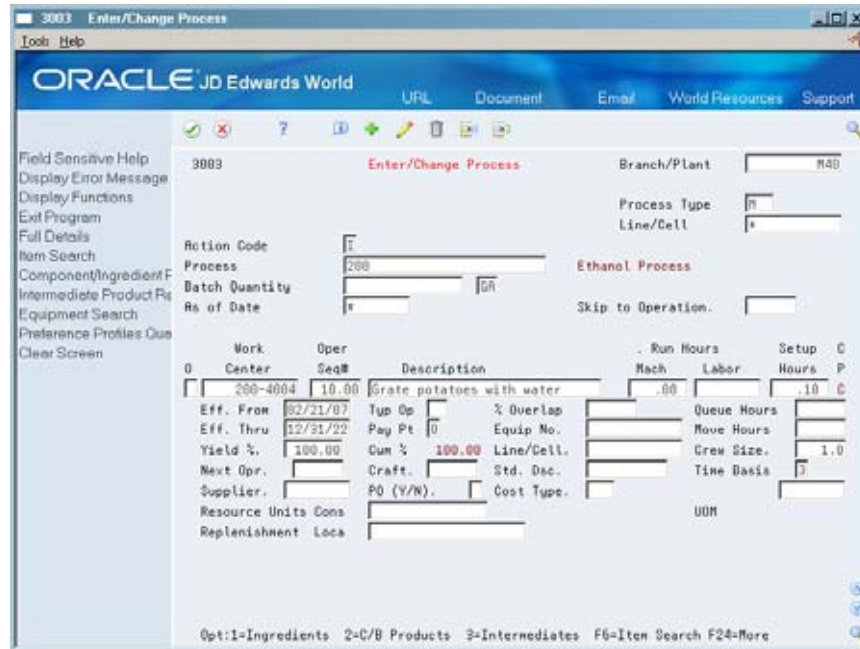

3. Review the following fields:

- Time Basis
- Crew Size
- Cost Type
- Type of Operation
- Yield Percent
- Cumulative Percent

Field	Explanation
Yield %	Represents the planned output yield percent for a step. The Planned Yield Update program uses this value to update the Cumulative Percent in the bill of material and the Operation Scrap Percent in the routing. Materials Requirements Planning uses the step scrap percent and the existing component scrap percent to plan component demand.
Cum %	Represents the cumulative planned output yield percent for a step. The system uses this value to adjust the operation step scrap percent for the components at that operation step. This enables the MRP system to use the operation step scrap percent along with the existing component scrap percent to plan component demand.

Reviewing Product Costing for Intermediates



From Product Data Management (G30), choose **Daily PDM Process**
From Daily PDM Process (G3012), choose **Enter/Change Process**

An intermediate is the product of an operation. This product is not the end item of the process, but an input to the next operation. You define intermediates when you need to express them in a unit of measure different from that of the parent item, or when you need to track the quantity of materials at each operation. Only one intermediate is allowed per operation. You cannot define an intermediate for the last operation, because the output of the last operation is the end item of the process.

An example of an intermediate is fermented liquid. The liquid ferments for an extended period of time before being distilled. The resulting liquid is not a finished product. Rather, it proceeds to the next operation.

If you define an intermediate item at a particular operation, you also establish a ratio between the intermediate quantity and the parent quantity. The system uses this ratio for costing the operation. A direct relationship exists among hours, the time basis, parent batch quantity, and intermediate operation quantity.

The system uses intermediate quantities to cost only direct labor hours (cost component B1) and direct machine hours (B3) from the routing. These hours are then used to calculate efficiency (B4) and overhead (C1-C4).

The labor and machine hours at an operation with an intermediate are the hours to produce one unit of measure of the intermediate. The hours are then adjusted in the rollup by the total quantity of intermediates produced at that operation. The following example illustrates the effect of intermediates on costing:

Operation 10

Labor Hours = 5

Intermediate quantity produced = 50 pounds

Hours for costing = 5 x 50 = 250

See Also

- *Attaching the Intermediate Items (P31111) in the Shop Floor Control Process Manufacturing Guide*

To review product costing for an intermediate

On Enter/Change Process

1. Access Intermediate Product Revisions (F9).

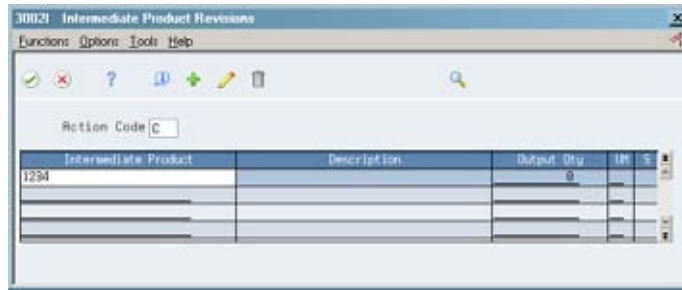

2. On Intermediate Product Revisions, review the following fields:

- Output Quantity
- Operation Sequence Number

Field	Explanation
Output Qty	<p>The number of units to which the system applies the transaction.</p> <p style="text-align: center;"><i>Form-specific information</i></p> <p>The quantity of an intermediate produced at the current step in the process.</p>
Op Seq	<p>In routings, this number is used to sequence the fabrication or assembly steps in the manufacture of an item. You can track costs and charge time by operation.</p> <p>In bills of material, this number designates the routing step in the fabrication or assembly process that requires a specified component part. You define the operation sequence after you create the routing for the item. The Shop Floor Control system uses this field in the backflush/preflush by operation process.</p> <p>In engineering change orders, this number is used to sequence the assembly steps for the engineering change.</p> <p>Skip To fields allow you to enter an operation sequence that you want to begin the display of information.</p> <p>You can use decimals to add steps between existing steps. For example, use 12.5 to add a step between steps 12 and 13.</p> <p style="text-align: center;"><i>Form-specific information</i></p> <p>In the process industry, the sequence number that produces the intermediate product.</p>

Reviewing Product Costing for Ingredients



From Product Data Management (G30), choose **Daily PDM Process**
From Daily PDM Process (G3012), choose **Enter/Change Process**

Ingredients are the components of a process. You attach an ingredients list to a process (in the same way that you attach a parts list to a routing) as part of setup.

To review product costing for ingredients

On Enter/Change Process

1. Access Process Resource Revisions for Ingredients (Option 1).

ID	Ingredient	Description	Quantity Per	UM	T	B
0452		Non-Food Grade Potato	3	LB	H	B
0455		Peelings	16	QC	H	B

2. On Process Resource Revisions, review the following fields:

- Ingredient
- Quantity Per
- Unit Of Measure

3. Access the detail area (F4).

ID	Ingredient	Description	Quantity Per	UM	T	B
0452		Non-Food Grade Potato	3	LB	H	B
Eff From 02/21/07 Op Seq 10.00 Feat Plan % 100.00 Line Type S Thru 12/31/22 % of Scrap Feat Cost % 100.00 Fixed/Var Qty V Leadtime Offset Days From Potency From Grade 004 Ren Thru Potency Thru Grade 004 Ingredient Branch 040 Partials Allowed (Y/N) Y Ingredient Line Number 1.0 Operation Scrap Percent .00						

4. Review the following fields:

- Fixed or Variable

- Feature Cost Percent
- Percent of Scrap
- Operation Scrap Percent

Reviewing Product Costing for Co- and By-Products

	From Product Data Management (G30), choose Daily PDM Process From Daily PDM Process (G3012), choose Enter/Change Process
---	---

Co-products are produced, usually together, as a result of a process routing. They are normally the main products (end items) that are then sold to customers.

A by-product is a material of value produced incidental to or as a residual of the production process. By-products can be recycled, sold as-is, or used for other purposes.

Co-products and by-products are costed using the Feature Cost Percent field.

Example: Feature Cost Percent and Co-/By-Product Costing

In the following example:

- Cumulative cost = cost this operation + cost of previous operation - cost of the co-/by-product produced in the previous operation.
- The total of all percentages at an operation cannot exceed 100%.
- The total of all percentages at the last operation must equal 100%.

Operation	Co-/By-Product	%	Cost This Operation	Cumulative Cost	Co-/By-Product Cost
10	By 1	10	100.00	100.00	10.00
20	Co 1	30	100.00	100.00 + (100.00 - 10.00) = 190.00	57.00
	Co 2	20			38.00
30			100.00	100.00 + (190.00 - 95.00) = 195.00	
40	Co 1	60	100.00	100.00 + 195.00 = 295.00	177.00
	Co 2	30			88.50
	Co 3	10			29.50

To review product costing for co-/by-products

On Enter/Change Process

1. Access Process Resource Revisions for Co-/By-products (Option 2).

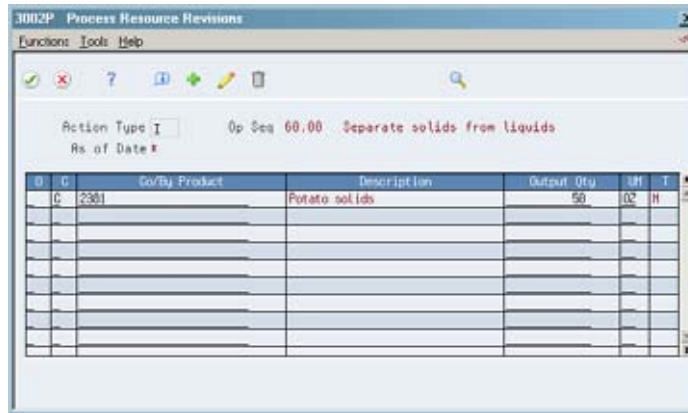

2. On Process Resource Revisions, review the following fields:

- Output Quantity
- Unit Of Measure
- Feature Cost Percent
- Resource Percent

Field	Explanation
Output Qty	<p>This value is the normal production quantity that is usually manufactured. An item can have multiple batch quantities, for example, liquids that are manufactured in different size vats.</p> <p style="text-align: center;"><i>Form-specific information</i></p> <p>This value specifies the quantity of each co-/by-product that the process produces. If you use batch bills, this is the quantity that the batch produces.</p>
UM	<p>A user defined code (00/UM) that indicates the quantity in which to express an inventory item, for example, CS (case) or BX (box).</p>
Feat Cost %	<p>A percentage used by the Simulate Cost Rollup program to calculate the cost of a feature or option item as a percentage of the total cost of the parent.</p> <p>Enter the percentage as a whole number: 5% as 5.0</p> <p style="text-align: center;"><i>Form-specific information</i></p> <p>This value is used in Cost Rollup to calculate what percent of the cost, up to and including the operation, that the co-/by-product comes out of, is apportioned to the co-/by-products at that step.</p> <p>The total of all percentages at an operation cannot exceed 100%. The total of all percentages at the last operation must equal 100%.</p>

Field	Explanation
Resource %	<p>If this option is chosen, this value indicates what percent of the ingredients should be issued separately to co-products and by-products.</p> <p style="text-align: center;"><i>Form-specific information</i></p> <p>This is used to issue ingredients separately to co-/by-products at work order completion, rather than a total issue for each ingredient.</p> <p>For co-/by-products at the final operation, their resource percent must equal 100 to issue all ingredients.</p>

To set up the Co-/By-Products Planning Table

	From Product Costing Setup (G3042), choose Co-/By-Products Planning Table
---	---

This table tells the system which processes to use to calculate the costs of co/by products (Cost %), as well as which processes to use to satisfy MRP demand for co-products (Plan %).

Normally, all demand for co-/by-products is satisfied from process work orders. However, for special circumstances, you can specify, for example, 50% from process work orders and 50% from co-product work orders themselves. To do so, enter less than 100% in the table. The remainder is automatically satisfied by co-product work orders.

Sometimes there will be more than one process that produces a co- or by-product. The cost for the co- or by-product from each process can then be allocated using the Co/By-Products Planning Table. This allows for assigning a weight to the costs from each process. For example, you may have a co-product that is produced by two processes. One process is the normal manufacturing process used 90% of the time. A second process is only used 10% of the time for rush orders, but the costs are much higher to produce this process. In the Co/By-Products Planning Table, the cost % is set to 90% for the first process, and 10% for the second. This allows the co-product's standard cost to reflect the extra costs that are incurred 10% of the time.

Even if all demand for co-/by-products is satisfied from process work orders, you must set up the co-/by-products planning table with a feature cost percent equal to 100. This ensures that the rollup calculates the costs of co- and by-products correctly.

On Co/By-Products Planning Table

Process/Item	Description	Pro	Plan %	Cost %
777	Potato Chip Process	Y	100.00	100.00

1. Complete the following fields:

- Co/By-Product
- Process/Item
- Pro (Process)
- Planned %
- Cost %

2. Access the detail area (F4).

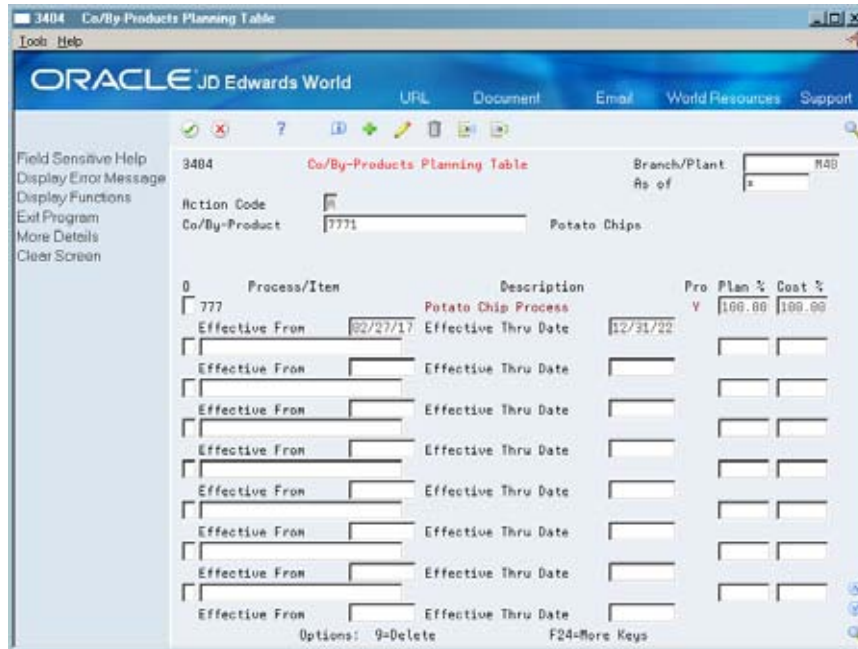

3. Complete the following fields:

- Effective From
- Effective Thru Date

Field	Explanation
Co-/By-Product	A number that the system assigns to an item. It can be in short, long, or 3rd item number format.
Process Item	This field indicates whether this is a process from which the co- or by-product is produced or a regular parent item.
Plan %	<p>The percentage of demand for a specified feature based on projected sales. For example, a company might sell 35% of their computers with a standard keyboard and 65% of them with an extended keyboard, based on customer demand.</p> <p>The Material Planning system uses this percentage to accurately plan for a feature's component items. Enter percents as whole numbers: 5% as 5.0. The default value is 100%.</p>
Cost %	<p>A percentage used by the Simulate Cost Rollup program to calculate the cost of a feature or option item as a percentage of the total cost of the parent.</p> <p>Enter the percentage as a whole number: 5% as 5.0</p> <p style="text-align: center;"><i>Form-specific information</i></p> <p>Used to calculate the cost of a co-/by-product when it can be produced from more than one process, or from a combination of a process and a work order. This value determines what percent of the cost of the co-/by-product is allocated to the selected process.</p>

Calculating Costs for Co- and By-Products

	From Manufacturing Systems (G3), choose Product Data Management From Product Data Management (G30), choose Daily PDM Process From Daily PDM Process (G3014), Choose Simulate Rollup
---	--

When you run the Cost Rollup the program (P30820), the system rolls up all of the costs for a process, as in the roll up of a discrete item. However, the process rollup involves more than a single end item, therefore, the system must calculate costs for co- and by-products.

You can use processing option 8 in P30820 to instruct the system to calculate costs for co- and by-products. When this processing option is turned on, the program divides the costs for the process into the co- and by-products according to the co- and by-product output quantity set up in the Process Resource Revisions screen (3002P). This gives the cost for the co/by product as it is produced in this process. The program then looks at the cost percentages in the co/by products planning table to allocate the cost from each process this co/by product is produced by to come up with a standard cost for the co/by product.

You can use processing option 10 to indicate that the costs of Co/By Products used as ingredients/components should not be cleared and recalculated.

To set up co- and by-products for a process

	From Manufacturing Systems (G3), choose Product Data Management From Product Data Management (G30), choose Daily PDM Process From Daily PDM Process (G3012), Choose Enter/Change Process
---	---

On Enter / Change Process

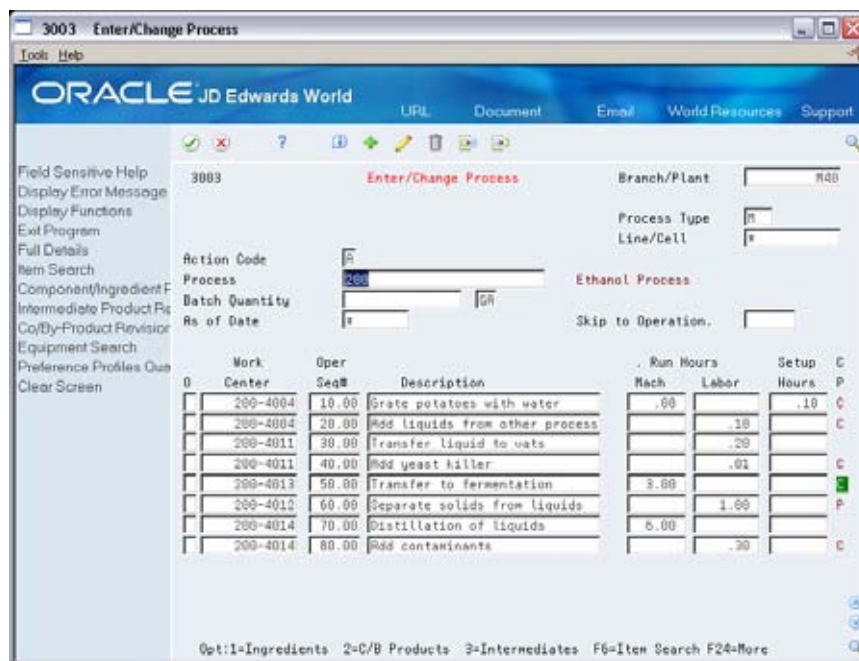

1. Complete the following fields:
 - Branch/Plant
 - Process Type
 - Process
 - Batch Quantity (Measure of Unit)
2. For each work center, complete the following fields:
 - Work Center
 - Oper Seq#
 - Description
 - Run Hours – Machine or Labor (as appropriate)
 - Setup Hours
3. Choose Co/By Product Revisions (F10). The Process Resource Revisions screen displays with the Co/By Product fields.

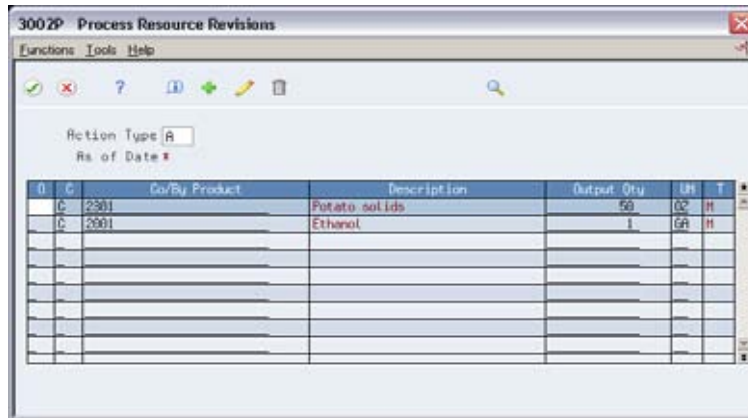

4. For each co- or by-product to include, complete the following fields:
 - C (Co-Product, By-Product, or Intermediate)
 - Co/By Product (Item Number)
 - Description
 - Output Qty
 - UM
 - T (Stocking Type)
5. Choose Component/Ingredient Revisions (F8). The Process Resource Revisions screen displays with the Ingredient fields.

Ingredient	Description	Quantity Per	UM	T	I
0402	Non-Food Grade Potato	3	LB	H	B
0405	Peelings	16	02	H	B
5215	Waste Water	32	02	H	B
2400	Yeast	4	02	P	B
246	Enzymes	6	02	P	B
099	Contaminant	4	02	P	B

6. For each ingredient, complete the following fields:
- Ingredient (Item Number)
 - Quantity Per
 - UM
 - I (Action Code)

Reviewing a Costed Process



From Manufacturing Systems (G3), choose **Product Costing**
 From Daily Product Costing (G3014), choose **Costed Process**

Use Costed Process to review the work center information and summarized costs of an item for each operation in the process. This information can help you effectively manage production costs. For example, you can:

- View the work center responsible for an operation.
- Determine if a work center performs multiple operations.
- Display simulated or frozen costs for labor values for cost methods.
- Calculate the totals for all costs by cost categories.
- View the costs of the ingredients.
- View the costs of the co- and by-products.
- View the costs for different quantities and units of measure. This feature allows you to simulate different scenarios and view the costing effect.

Note: The program can accumulate purchase costs for up to 999 components on each bill of material. Components beyond 999 are not included in the costing.

To review a costed process

On Costed Process

Work Center	Op Seq	Labor	Machine	Overhead	Components	Total
200-4007	10.00		.0029		.0318	.0348
200-4007	20.00	.0001				.0001
200-4007	30.00		.0029			.0030
200-4007	40.00	.0001				.0001
200-4008	50.00	.0253	.0003		.1404	.1659
200-4015	60.00	.0001			.3158	.3159
200-4016	70.00					
200-4016	80.00				.3000	.3000
		.0256	.0061	.0001	.7079	.0197

Opt: 1=Ingredients 2=Co/By 5=Detail F0=All Ingrid. F10= All Co/By F24=More

1. Review the following fields:

- As of Date
- Cost Method
- Requested Quantity
- Unit Of Measure
- Up to Operation Sequence
- Extras 1-3
- Extras 4-7
- Work Center
- Operation Sequence Number
- Labor
- Machine
- Overhead
- Components
- Total (row)
- Total (column)

Labor costs are real-time. They are calculated each time you access this form.

2. Toggle to review frozen or simulated costs (F15).

3. Access Operation Bucket Key Window to review the item's operation buckets (F11).

Labor	Machine	Overhead	Components	Extras 1-3	Extras 4-7
B1	B3	C1	D1	X1	X8
B2		C2	D2	X2	X8
B4		C3	D1	X3	X8
		C4	D2		X8
					X4
					X5
					X6
					X7

4. On Costed Process, access Costed Resources (F8).

30208P		Costed Resources		As of Date	
Requested Quantity	1 LB	. Simulated		Total	.9869
Ingredient	777	Purchased	Labor	Machine	Overhead
			.0256	.0053	
Totals			.7496	.2288	.0053
					.0032

Opt: 1=Comp. 2=Next Level F3=Exit F12=Previous F15=Frz/Sim F24 = Mor

Opt: 1=Ingredients 2=Co/By 5=Detail F8=All Incred. F10= All Co/By F24=More

You can view ingredient costs for a single operation or for all ingredients across all operations in the process. These costs are from the Cost Components table and reflect the last simulated rollup. Thus the costs might differ from those on Costed Process if you have changed the process since the last rollup.

5. On Costed Process, access Costed Resources for Co-/By-Products (F10).

Co/By Product	Purchased	Simulated Labor	Machine	Overhead
8015				
8215	.1251	.1593	.0827	.0810
8215	.1251	.1593	.0827	.0810
8225	.0639	.0381	.0011	.0004
7771	.6027	.0170	.0014	
Totals	.9763	.3945	.0979	.0040

You can view co-/by-product costs for a single operation or for all co-/by-products across all operations. If the co-/by-product is made from more than one process, the costs shown are for all processes. These costs are from the Cost Components table and reflect the last simulated rollup. Thus the costs might differ from those on Costed Process if you have changed the process since the last rollup.

- On Costed Process, access Detail to view all costs associated with an operation (Option 5).

Category	Type	Description	Cost
Machine	B3	Machine Run	.0029
Overhead	C1	Machine Variable Overhead	
Overhead	C2	Machine Fixed Overhead	
Components	B1	Material	.0316

Labor costs displayed are real-time. The cost components are grouped using cost buckets.

Field	Explanation
As of	This field is used for effectivity checking. Enter a specific date to display documents (orders, bills of material, routings, as applicable) that are effective on or after that date. The current system date is the default, but you can enter any future or past date. <i>Form-specific information</i> The routing that is effective as of this date is used.
Cost Method	A user defined code (system 40, type CM) that identifies a cost method. Cost methods 01 through 08 are hard-coded.

Field	Explanation
Requested Quantity	<p>The number of parent items you want to process. The system calculates lower-level values in quantity per the number of parent items requested. For example, if 3 components are needed for a parent item, and the requested quantity is 10, the system plans for 30 components.</p>
	<i>Form-specific information</i>
	<p>This is the number of parent items for which you want to see cost breakdowns. Costs are figured in quantity per the parent item.</p>
Op Seq	<p>In routings, this number is used to sequence the fabrication or assembly steps in the manufacture of an item. You can track costs and charge time by operation.</p>
	<p>In bills of material, this number designates the routing step in the fabrication or assembly process that requires a specified component part. You define the operation sequence after you create the routing for the item. The Shop Floor Control system uses this field in the backflush/preflush by operation process.</p>
	<p>In engineering change orders, this number is used to sequence the assembly steps for the engineering change.</p>
	<p>Skip To fields allow you to enter an operation sequence that you want to begin the display of information.</p>
	<p>You can use decimals to add steps between existing steps. For example, use 12.5 to add a step between steps 12 and 13.</p>
	<i>Form-specific information</i>
	<p>Top of form: A processing option controls whether “Skip to” or “Up to” operation sequence mode is in effect.</p>
	<p>In “Skip to” mode, the system uses an entered operation sequence number as the starting point when displaying operations, and displays the total from that point forward on the total line.</p>
	<p>In “Up to” mode, the system uses an entered operation sequence number as the cutoff for displaying operations. The total for all operations up to and including the operation sequence number entered appears on the total line.</p>
	<p>Bottom of form: The Op Seq field contains a number that indicates the order of each step in the manufacturing operation.</p>
Purchased	<p>Work Amount field for the Manufacturing System.</p>
	<i>Form-specific information</i>
	<p>Cost bucket No. 1 as defined for user defined code 30/CO, Operation Buckets. A processing option controls whether the system adds cost buckets 1 and 2 (at the top of the form) into the grand total of all costs for the parent item at the bottom of the form.</p>

Field	Explanation
Extras	<p>Work Amount field for the Manufacturing System.</p> <p><i>Form-specific information</i></p> <p>Cost bucket No. 2 as defined for user defined code 30/CO, Operation Buckets. A processing option controls whether the system adds cost buckets 1 and 2 (at the top of the form) into the grand total of all costs for the parent item at the bottom of the form.</p>
Work Center	<p>A number that identifies a branch, plant, work center, or business unit.</p> <p><i>Form-specific information</i></p> <p>This is the business unit assigned to the work center for the operation sequence listed.</p>
Labor	<p>Work Amount field for the Manufacturing System.</p> <p><i>Form-specific information</i></p> <p>Cost bucket No. 3 as defined for user defined code 30/CO, Operation Buckets. The total of this column appears at the bottom of the screen in the "Totals" row. The heading above the columns indicates which costs are displayed: frozen or simulated. You can toggle between simulated and frozen values.</p> <p>You also can view a detailed breakdown of the cost components added to determine the total for the work center.</p>
Machine	<p>Work Amount field for the Manufacturing System.</p> <p><i>Form-specific information</i></p> <p>Cost bucket No. 4 as defined for user defined code 30/CO, Operation Buckets. The total of this column appears at the bottom of the screen in the "Totals" row. The heading above the columns indicates which costs are displayed: frozen or simulated. You can toggle between simulated and frozen values.</p> <p>You also can view a detailed breakdown of the cost components added to arrive at the total for the work center.</p>
Overhead	<p>Work Amount field for the Manufacturing System.</p> <p><i>Form-specific information</i></p> <p>Cost bucket No. 5 as defined for user defined code 30/CO, Operation Buckets. The total of this column appears at the bottom of the screen in the "Totals" row. The heading above the columns indicates which costs are displayed: frozen or simulated. You can toggle between simulated and frozen values.</p> <p>You can also view a detailed breakdown of the cost components added to arrive at the total for the work center.</p>

Field	Explanation
Total	<p>Work Amount field for the Manufacturing System.</p> <p><i>Form-specific information</i></p> <p>This column contains system-calculated totals for each row of costs, that is, for each operation sequence.</p> <p>The totals across the bottom of the screen are the totals of each cost bucket.</p> <p>The rightmost bottom total is the total of all costs for the routing for an item.</p>

What You Should Know About

Displayed costs	This program calculates the cost associated with each cost component in the same way as the Simulate Cost Rollup program.
------------------------	---

See Also

- *Appendix A – Calculations in Cost Rollup (P30820)*
- *Setting Up Operation Bucket Codes for a Costed Routing*
- *Setting Up Cost Bucket Codes for Costed Bills of Material*

Processing Options

See [Costed Routing Inquiry \(P30208\)](#).

Cost Extras

Cost Extras for a process are treated differently due to the fact that they are not associated with a particular step of the process. Feature cost percentages are not used for distributing X costs (cost extras) that are entered on the process. Instead, the program determines the total of the NET ADDED B1-C4 costs for all of the co- and by-products, then determines the percentage of this total each co- and by-product comprises, and then uses this percentage to allocate the X cost.

Cost Extras (X Cost) on Ingredients

- If an ingredient that goes into a process has cost extras (X costs) built into it, these cost extras are allocated to the co- and by-products the same way the ingredients are allocated using the sequence where the ingredient is consumed, and the feature cost percentage of the Co/By product.

Reviewing Product Costing for Percent Bills of Material

	From Product Data Management (G30), choose Daily PDM Discrete From Daily PDM Discrete (G3011), choose Enter/Change Bill
---	--

You use a percent bill of material to express the ingredients as a percentage of the process quantity.

If you use percent bills of material, the system calculates costs based on the quantities specified in the percent bill.

To review a percent bill of material

On Enter/Change Bill

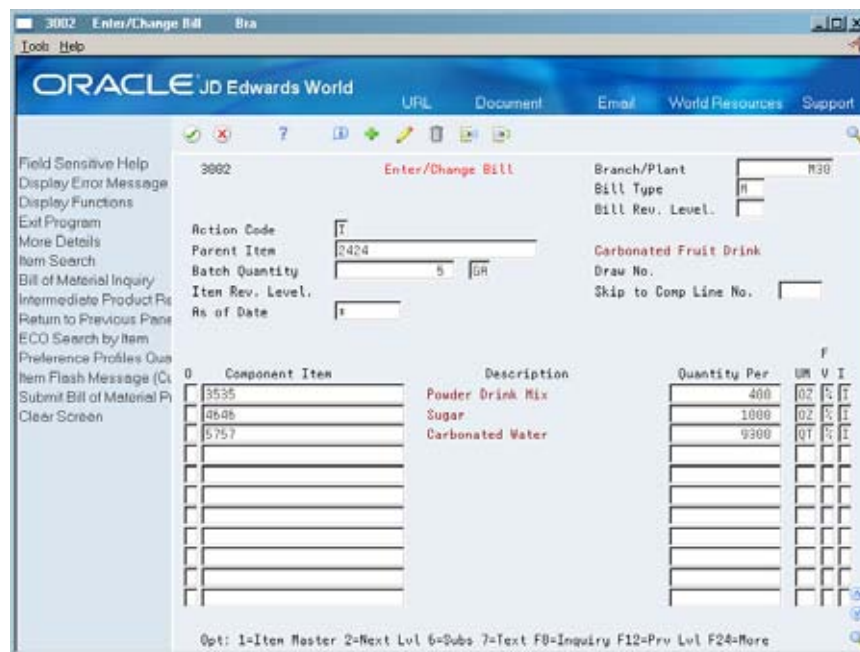

Review the following fields:

- Quantity Per
- Fixed or Variable

Field	Explanation
Quantity Per	The number of units to which the system applies the transaction. <i>Form-specific information</i> A number that indicates how many components you use to manufacture the parent item. A quantity of zero is valid. The default value is 1.

Field	Explanation
F V	<p data-bbox="787 262 1458 415">Indicates if the quantity per assembly for an item on the bill of material varies according to the quantity of the parent item produced or is fixed regardless of the parent quantity. This value also determines if the component quantity is a percent of the parent quantity. Valid values are:</p> <p data-bbox="787 426 1019 457">F Fixed Quantity</p> <p data-bbox="787 468 1149 499">V Variable Quantity (Default)</p> <p data-bbox="787 510 1450 573">% Quantities are expressed as a percentage and must total 100%</p> <p data-bbox="787 583 1450 678">For fixed quantity components, the Work Order and MRP systems do not extend the component's quantity per assembly value by the order quantity.</p> <p data-bbox="787 688 1450 804">For Process Manufacturing, the system stores percent components. Therefore, the system treats zero batch sizes like variable quantity components, and treats batch sizes greater than zero like fixed quantity components.</p>

See Also

- *Working with Components (P3002) in the Product Data Management Discrete Manufacturing Guide*

Understand Configured Items

About Costing for Configured Items

Costing for configured items is different from costing for non-configured items, because configured items do not have a standard bill of material or routing. Because there is no standard configuration, costing cannot be established before you enter the sales order. In other words, there are no standard costs for configured items.

The Process Work Orders program performs a cost rollup when it attaches a parts list and routing to a work order for a configured item. A processing option instructs the program to calculate the costs. When the costs are calculated, they are stored in the Work Order Variances table, not the Cost Components table.

When these costs have been established, the system updates the unit cost and extended cost on the sales order for the top-level configured item only.

The following graphic illustrates costing for configured items.

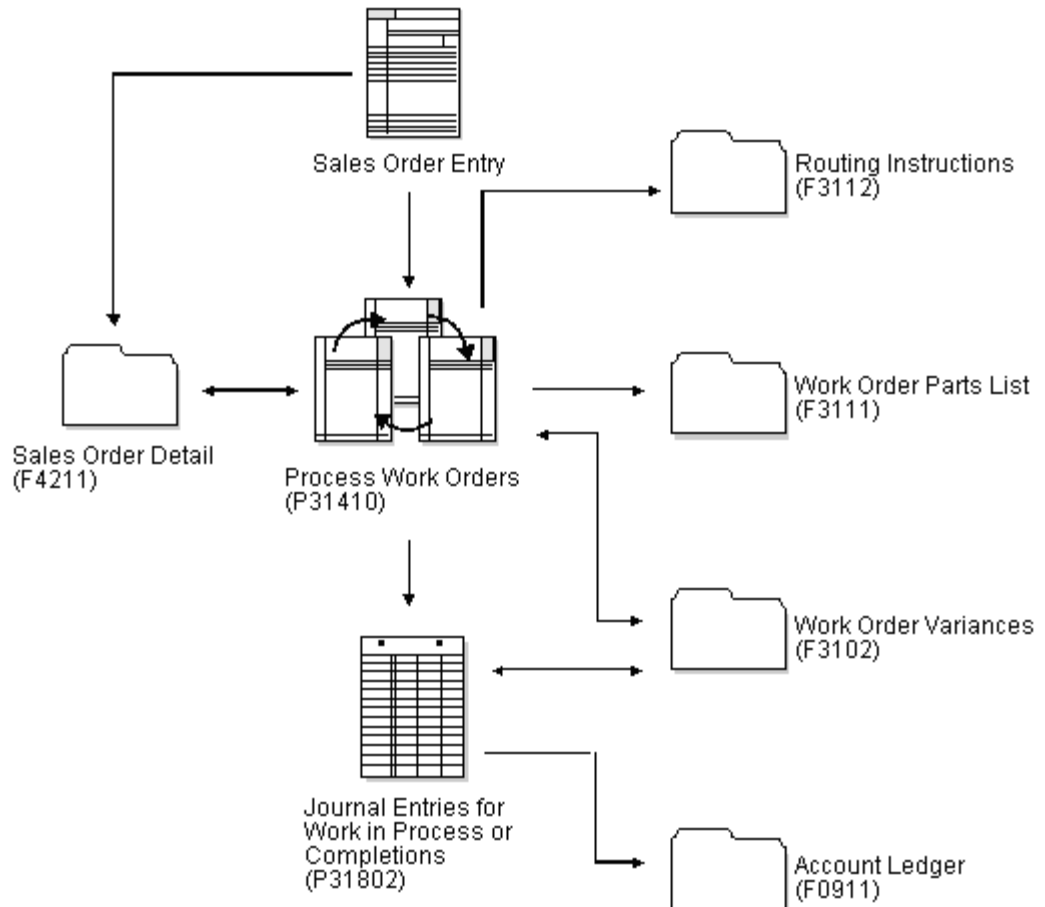

Example: Costing a Configured Item

The following example illustrates how the frozen standard costs are calculated for a configured item.

A basic assumption is that you have done a cost rollup for the non-configured items and that frozen standard costs exist on the Cost Components table for those items.

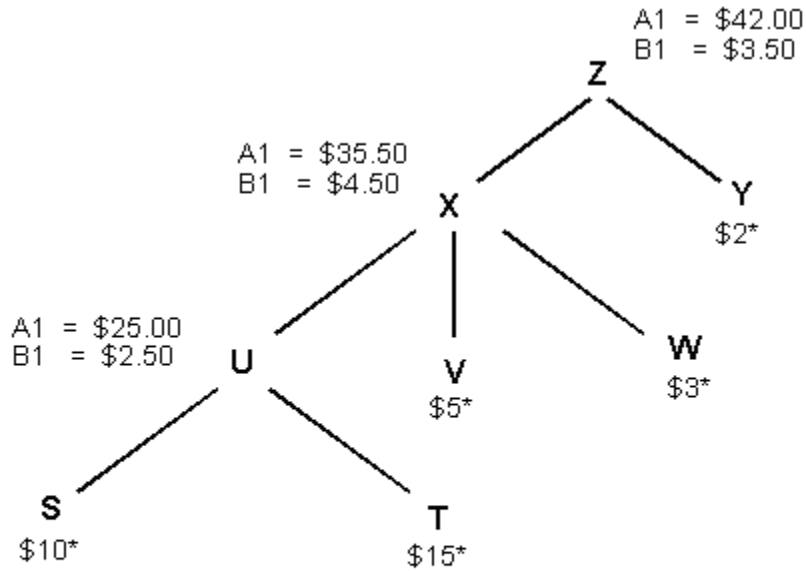

* component's total cost from sum of all cost components
 A1 material cost calculated from the total cost of the direct components
 B1 direct labor cost calculated from that item's routing

Process Work Orders Program

For the rollup to occur correctly, the data sequence for Process Work Orders must be set as follows.

Example: Process Work Orders Data Sequence Setup



The sales order number displays first, and then the sales order line number.

On the sales order, the lowest level components have the highest line number. Thus when you specify a descending sequence for the line numbers in the data sequence setup, Process Work Orders runs on the lowest level components first.

To ensure that the costs roll up properly, you must process work orders on the lowest level items first. In the example, you must process the work order for item U before the work order for item X, and the work order for item X before the work order for item Z.

See Also

- *About Configuration Management in the Configuration Management Guide*

4 Manufacturing Accounting

Overview to Manufacturing Accounting

Objectives

- To review the basic concepts of manufacturing accounting
- To review the basic concepts of posting to the general ledger
- To understand how the general ledger and the account code structure relate to manufacturing accounting
- To understand what happens when work order transactions take place
- To learn what calculations are performed in the Manufacturing Accounting system
- To understand how work order variances are calculated and how to interpret variance reports
- To identify the available manufacturing accounting reports

About Manufacturing Accounting

The Manufacturing Accounting system works with the General Accounting system to help you manage the general ledger functions for your organization.

Working with the Manufacturing Accounting system consists of:

- Setting up manufacturing accounting
- Understanding work orders in accounting
- Working with work orders
- Creating journal entries
- Reviewing general ledger batches
- Posting to the general ledger

The following two graphics illustrate the interaction between the Manufacturing Accounting system and the General Accounting system.

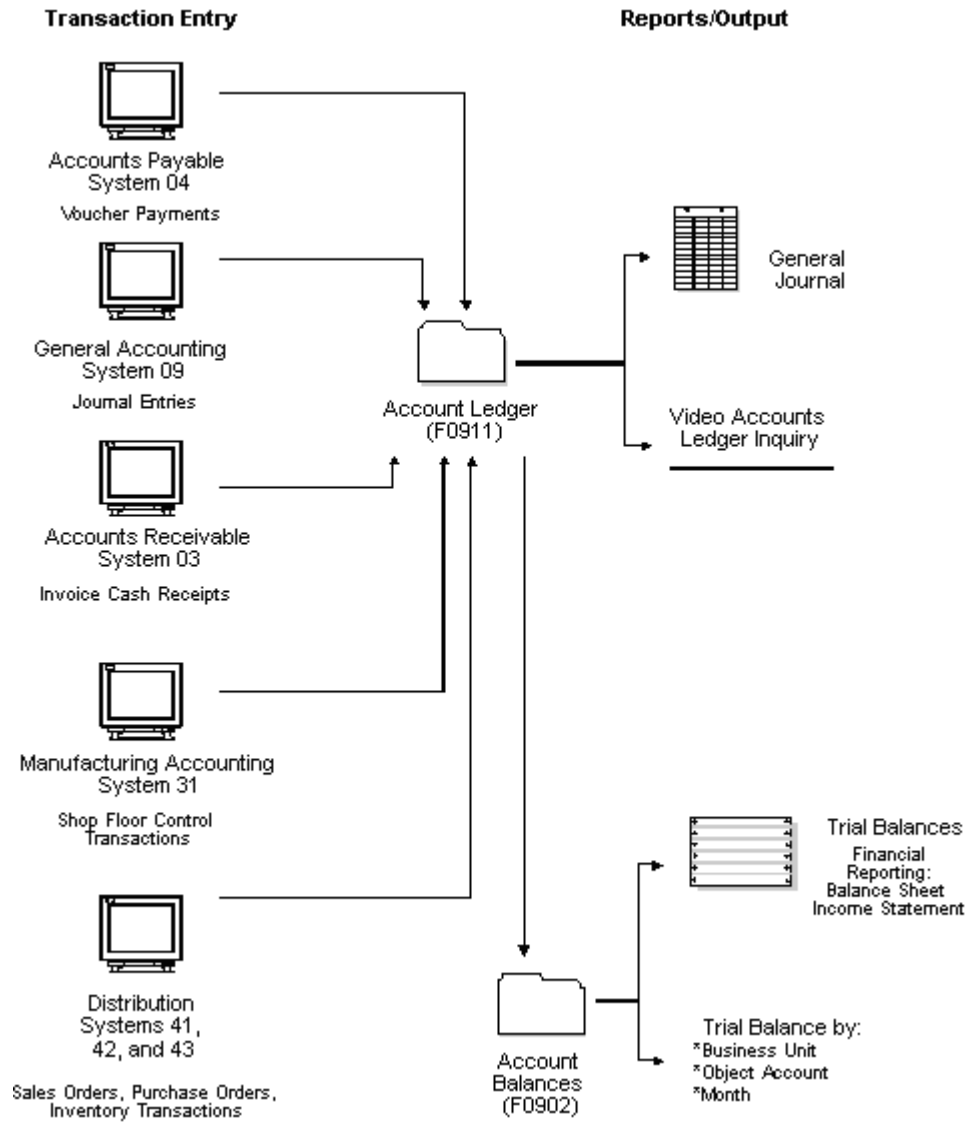

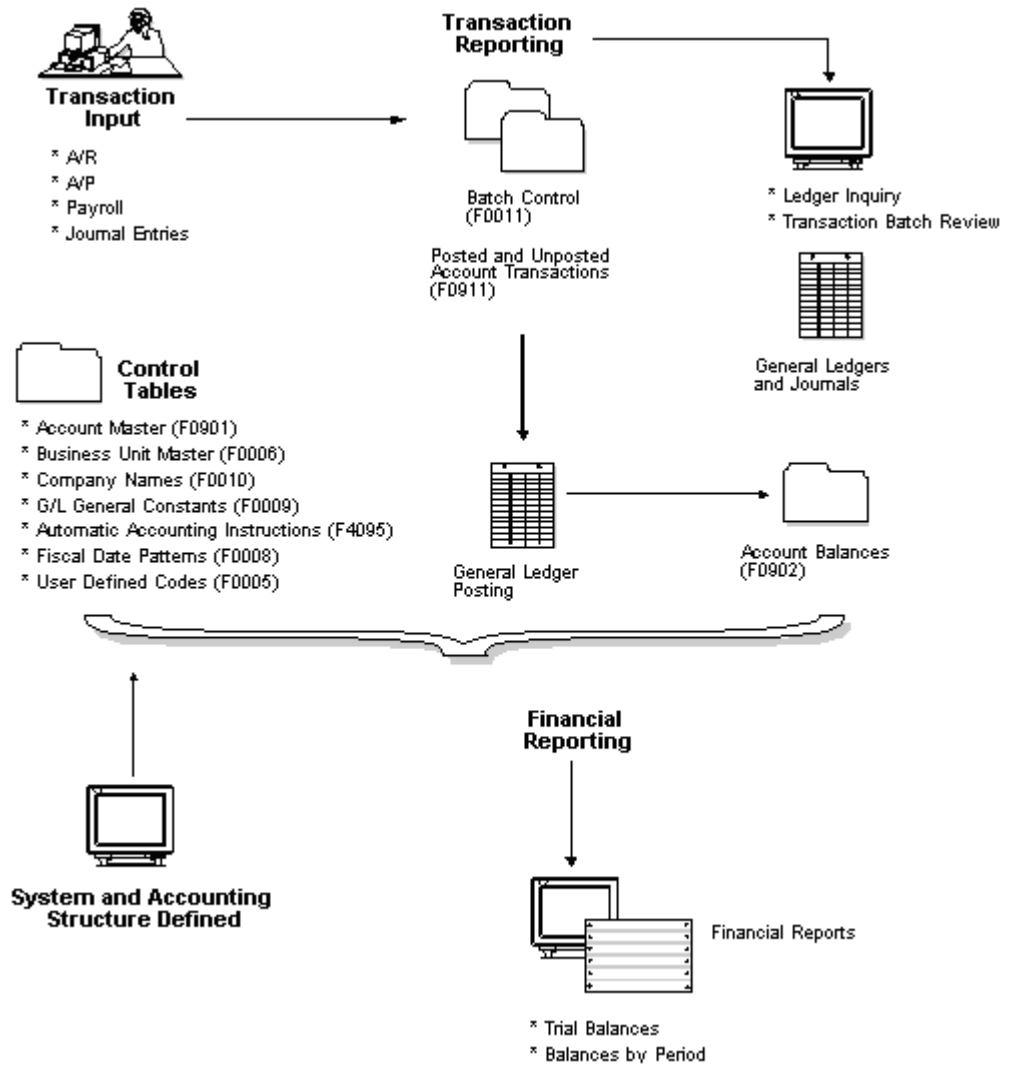

The following graphic (in two parts) illustrates the flow of the Manufacturing Accounting system.

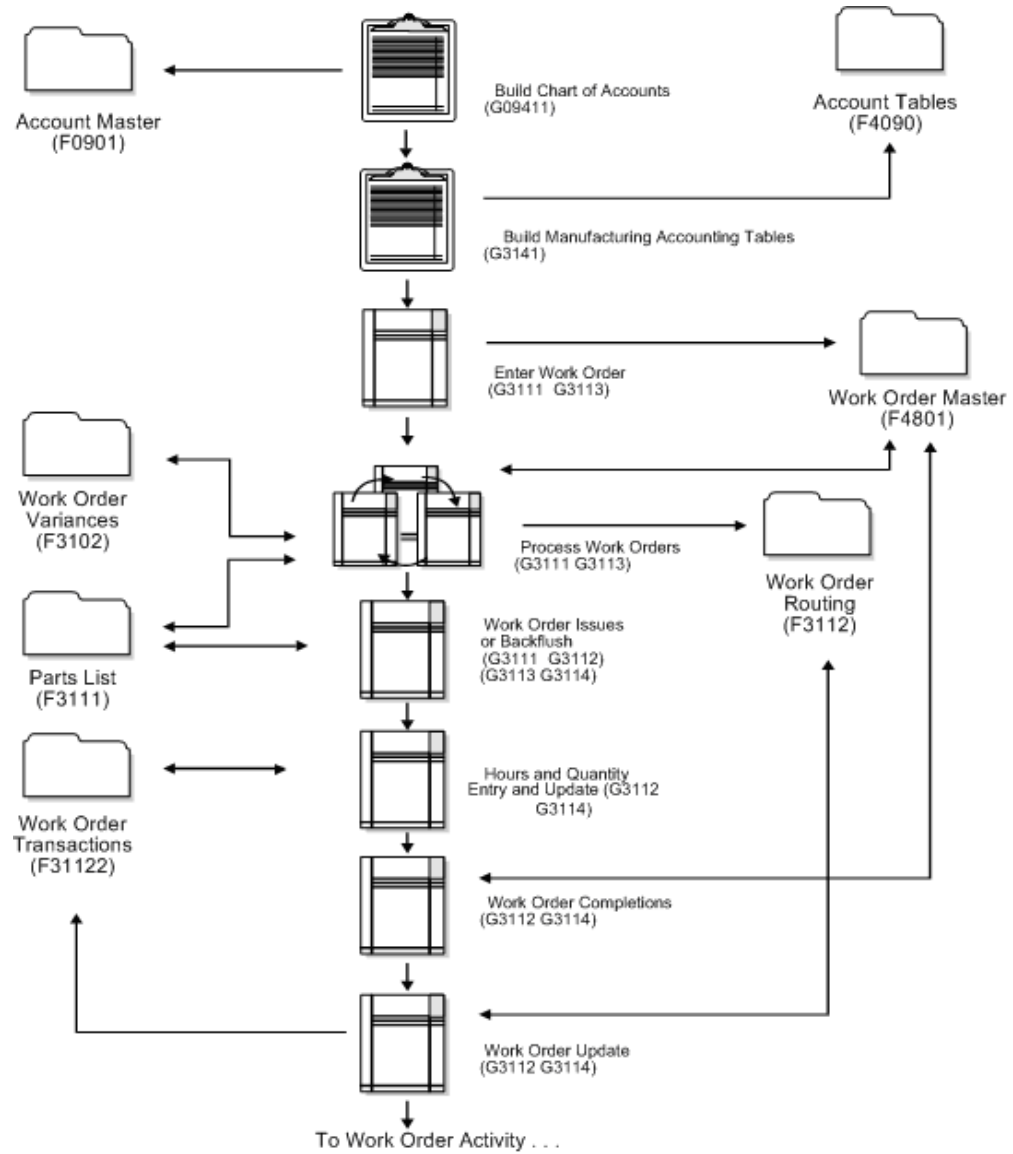

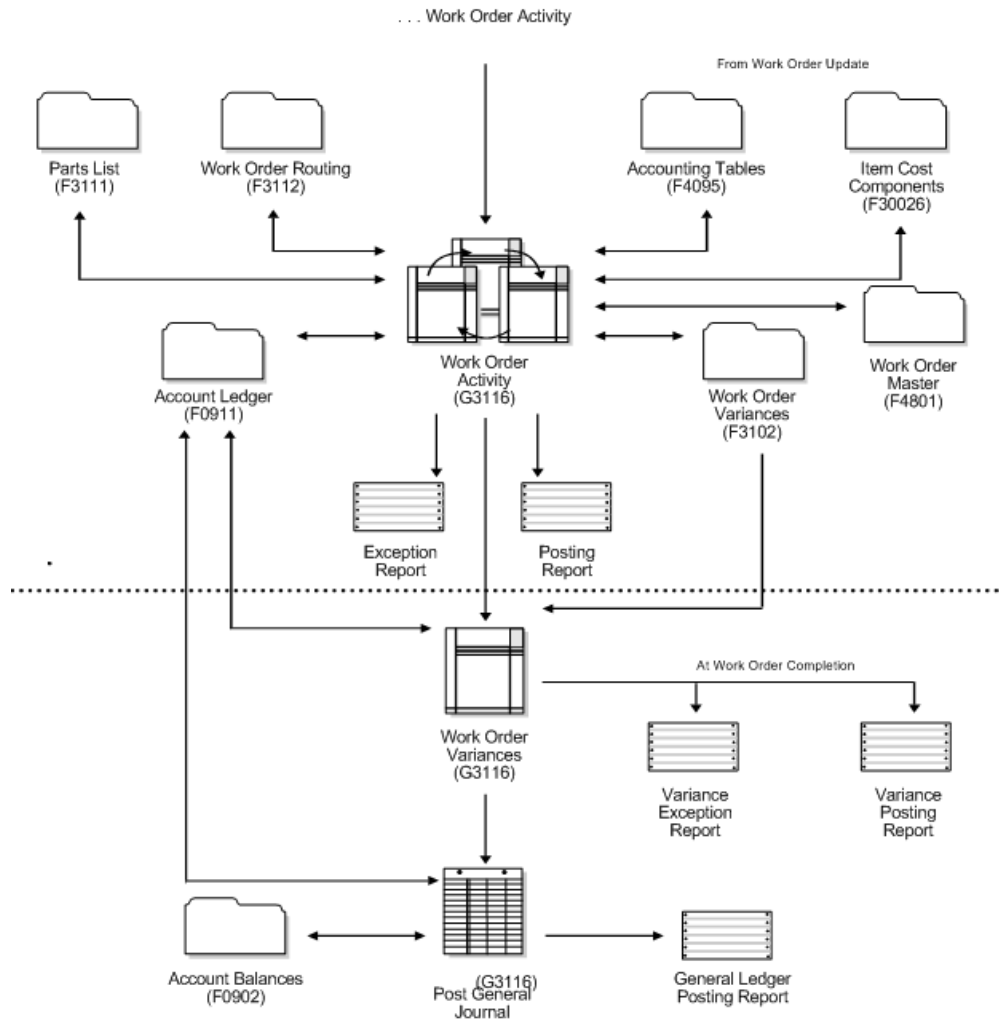

Accounting Fundamentals

Before you set up your company's Manufacturing Accounting system, you must have a basic understanding of the general ledger and accounting concepts. After you understand the underlying framework, you can use the Manufacturing Accounting system to:

- Create and generate work orders
- Run work order variances

The Accounting Equation

To determine a company's net worth, you must review the results at the end of the previous fiscal period and then take into account changes that have occurred during the year.

You calculate these changes with this basic accounting equation:



To extend this equation, Shareholders' Equity is equal to the change in contributed capital plus revenues, minus expenses and dividends. The complete equation is illustrated below:

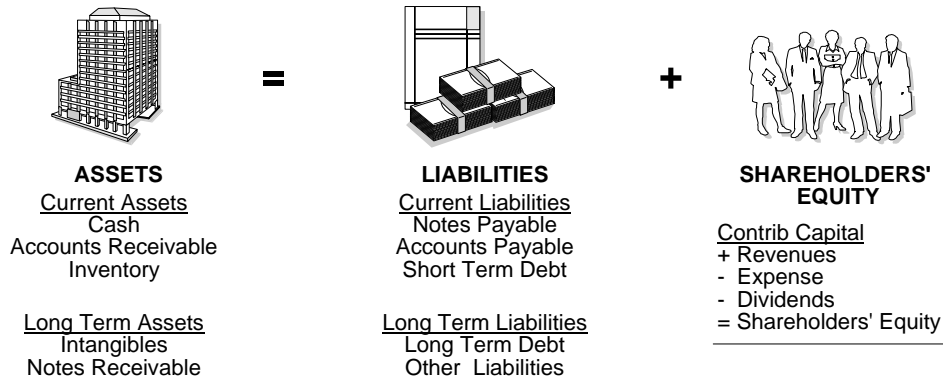

T-Accounts

The basis of all accounting systems is the T-account. This bookkeeping device is where you record the increases and decreases of a specific type of asset or liability caused by a business transaction.

T-accounts consist of two types of transactions—debits and credits. In the general ledger, “debit” and “credit” refer only to the position of the columns on the account. For example, you record an increase to an asset account as a debit and an increase to a liability account as a credit. Conversely, you record an increase to a revenue account as a credit and an increase to an expense account as a debit.

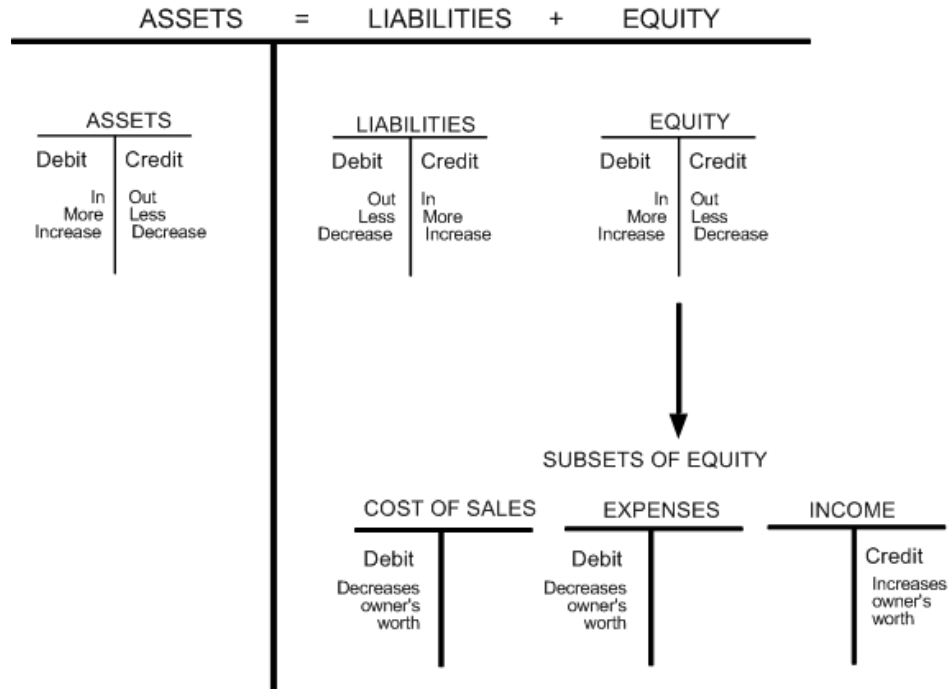

General Ledger Transactions

The following example shows how transactions are recorded in the general ledger.

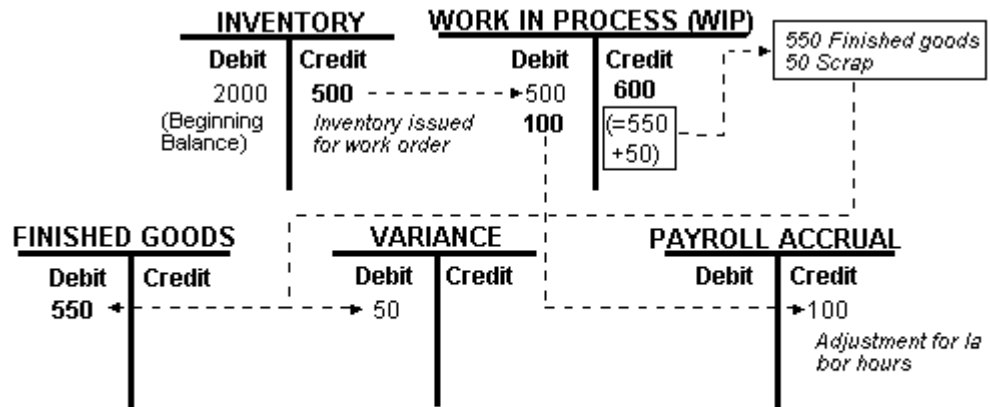

After work is complete, inventory transfers out of WIP to Finished Goods. The difference between the total inventory and the finished goods is the scrap, which transfers to the variance account.

Accounts and Account Numbers

The account code structure provides a method for the system to record transactions to the general ledger. When you set up your system, you must:

- Assign business unit/object/subsidiary codes
- Determine how amounts are posted

- Assign levels of detail that the system uses to structure accounts to roll up balances

Business Units

Business units are an important part of the basic account structure. Business units identify where general ledger activity occurs. They are the lowest organizational level within your business and the level at which you account for all revenues, expenses, assets, liabilities, and equity.

Business units of 12 alphanumeric characters are set up in the following format:

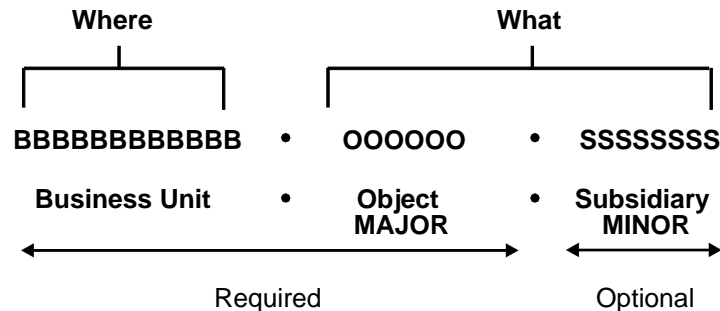

A company can have several revenue and expense business units, for example:

- Department
- Machine shop
- Drill press

Object and Subsidiary Accounts

Every business unit you define must have an object and, optionally, subsidiary accounts. The object and subsidiary accounts define the kind of transaction you are working with (for example, rent, paper supplies, and so on). These items make up your chart of accounts.

Object - "Major Account"

The object, or major account, describes the type of transaction with which you are working. The system requires objects for each transaction entry, such as:

- Rent expense
- Service sales
- Finished goods inventory

You use up to six alphanumeric characters in this field. To make data entry more efficient, you should consider using only numbers in the object.

Subsidiary - "Minor Account"

Subsidiary accounts are subdivisions of object accounts. Use a subsidiary account when you need more detailed accounting activity for an object account.

You can use up to eight alphanumeric characters in this field.

Account Numbers

An account number includes both the business unit and object.subsidiary codes. You can use periods (the default), commas, or other user defined symbols to separate the components of the account number.

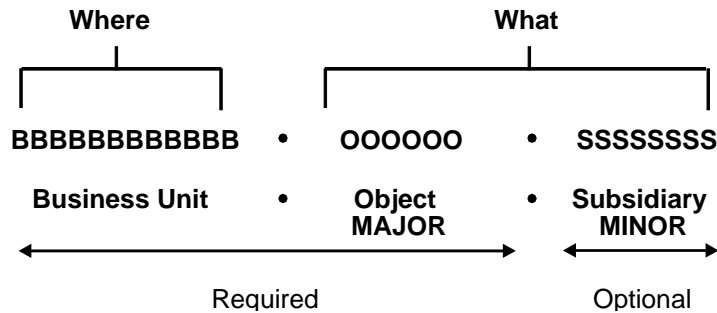

For example, you can categorize the “Cash in Banks” object (account 1110) into the following subsidiary accounts:

Account	Description
1110.BEAR	Bear Creek National Bank
1110.FIB	First Interstate Bank
1110.FRANCE	First Bank of France

See Also

- Creating a Flexible Format (P0907) in the General Accounting II Guide for other methods for numbering accounts.

Level of Detail

You assign levels of detail (LODs) to control which accounts are subtotaled during the rollup process. The system also displays the level of detail you view online and in printed reports.

Use LOD 3 through 9 for accounts. LOD 1 is reserved for companies and LOD 2 for business units. The system underlines LOD 3 on balance sheet reports and LODs 3 and 4 on income statement reports.

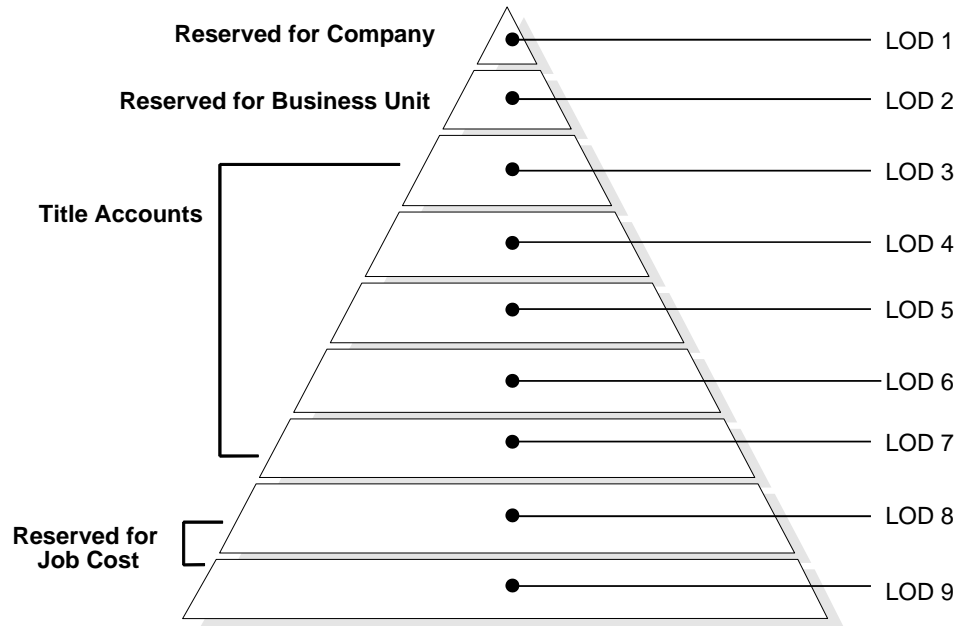

The following guidelines apply when you assign levels of detail to accounts:

- Assign LODs sequentially and do not skip a level of detail. Non-sequential levels of detail cause rollup errors in financial reports that run at a level you did not use.
- Assign LOD 3 to balance sheet title accounts for assets, liabilities, and equity.
- Assign either LOD 3 or LOD 4 to major title accounts on the income statement. For example:
 - Revenues
 - Direct costs
 - General and administrative expenses
 - Other income and expenses

What Is Subledger Accounting?

In addition to the regular business unit.object.subsidiary method of account coding, you can use subledger accounting. Subledgers are “subdivisions” of account details for categories that you do not want in the permanent chart of accounts.

The subledger and subledger type for a general ledger account work together to provide detailed accounting to the Account Master table (F0901). The subledger numbers become the audit trail for the posted subledger transactions.

You can group and report transactions posted to a general ledger account with subledger types. Subledger types allow you to view account totals in more detail. You can also report on subledgers across accounts (for example, all accounting activity by asset ID or by work order number).

Subledgers differ from subsidiary accounts in the following ways:

- Subledgers do not create additional records in the Account Master table (F0901).

- You enter and post transactions to the same account using different codes in the Subledger and Subledger Type fields rather than to different accounts.
- Subledgers can create additional records in the Account Balances table (F0902). You control this using the posting edit code on the Account Master table.

Subledger Types

There are eight predefined, hard-coded subledger types. Each one edits or validates the subledger number against a master table.

Core Subledger Types

Subledger Type	Description
A	Address Book number. This number is edited against the Address Book Master table (F0101). It is the most commonly used subledger type and is used for the detail method of intercompany settlements.
C	Business Unit number. This number is edited against the Business Unit Master table (F0006).

Other Subledger Types

Subledger Type	Description
E	Equipment Item number. This number is edited against the Equipment Master table (F1201).
L	Lease Item number. This number is edited against the Lease Master table (F1501).
I	Item number (short). This number is edited against the Item Master table (F4101).
O	Sales Order number. This number is edited against the Sales Order Master table (F4211).
S	Structure Subledger. This item is edited against the Chart of Accounts Format table (F0909).
W	Work order number. This number is edited against the Work Order Master table (F4801).
M	Summarized work order number. This number is used for summarized journal entries.

In addition, there are three subledger types (X, Y, and Z) that you can define with user defined codes (system 00, type ST). These types are not edited against any tables. You set up these types if you want the system to edit values against a format requirement rather than a specific value.

Posting Edit Codes

Use posting edit codes (PECs) to designate which accounts use subledgers and how the system posts accounts. These codes define how the system updates the general accounting tables and the type of information on which you can search or print a report.

Set the PEC on the Account Master table for all accounts that use subledger accounting. For subledger accounting, use one of the following PECs.

Posting Edit Code	Description
S	Summary. Posts subledgers in summary format on every transaction that references the account. You see only subledger detail in the Account Ledger table. This code requires subledger entry.
L	Long. Posts subledgers in detailed format. The system stores the subledger in detail in both the Account Ledger and Account Balances tables. This code requires subledger entry.
X	Does not allow subledger entry for the account.
Blank	Allows all posting. The system posts the subledger in detailed format. A blank code does not require subledger entry.

What Is the Chart of Accounts?

The chart of accounts is a record of the valid accounts you assign to the business units within your company's reporting structure. When you set up your chart of accounts, you define the location of the accounts using automatic accounting instructions (AAIs) that indicate which number ranges represent assets, liabilities, and so on.

The chart of accounts begins with the major headings of your transactions and continues with detailed transaction descriptions:

Transaction	Description
Assets	(Balance Sheet)
Liabilities	(Balance Sheet)
Owners' Equity	(Balance Sheet)
Revenues	(Income Statement)
Expenses	(Income Statement)

The chart of accounts displays the following elements:

- The account number
- The posting edit codes
- The level of detail assigned to the account
- Which accounts are assigned to which business units

Example: Chart of Accounts

Acct	Description	Post Edit	LOD	B/S BU100	DEN BU210
1000	Assets	N	3	X	
1001	Current Assets	N	4	X	
1100	Cash	N	5	X	
1110	Cash in Bank	N	6	X	
1130	Short-Term Investments	N	7	X	
1200	Accounts Receivable	M	5	X	
1210	Trade Accounts Receivable	M	6	6	
1215	Allow for Doubtful Accounts	N	5	X	
1400	Inventory	N	5	X	
1800	Prepaid Expenses		6	X	
1810	Prepaid insurance		6	X	
1890	Other Prepaid Expenses		6	X	
2000	Fixed Assets	N	4	X	
2001	Property and Equipment	N	5	X	
2020	Buildings	N	6	X	
2060	Furniture & Office Equipment	N	6	X	
2100	Accumulated Depreciation		6	X	
2160	Accum Depr - Buildings		5	X	
2170	Accum Depr - Office Furniture/Equipment		6	X	
3900	Accum Depr - Computer		6	X	
	Other Assets		5	X	

What Are Work Order Variances?

Variances occur when the frozen standard costs differ from other user defined cost methods, such as current costs. These variances can be due to differences in labor or overhead, or changes to the bill of material or routing.

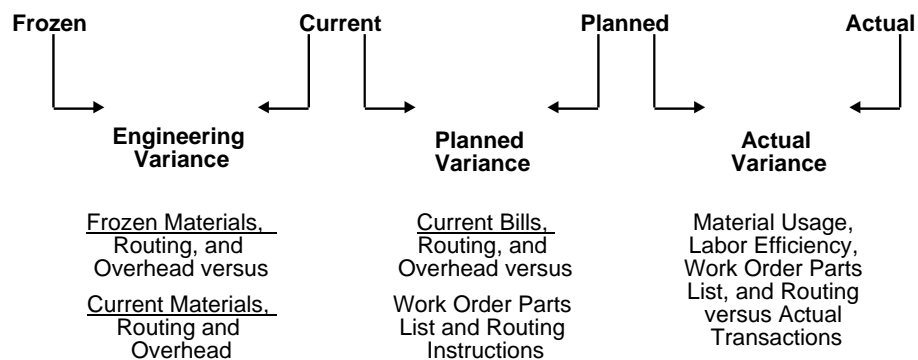

The following describes each variance type.

Variance Type	Description
Engineering	The difference between the frozen standard costs (material, labor, and overhead) at the beginning of the accounting period and the current costs derived from the bills of material, routings, and overhead rates.
Planned	The difference between the current costs derived from the bills of material, routings, and overhead rates and the costs based on the work order parts list and routing instructions. Planned variances can occur when you revise a work order.
Actual	<p>The difference between the cost values derived from the work order parts list and routing, and the material and labor that were actually reported against that work order. Actual variances can occur when you:</p> <ul style="list-style-type: none"> ▪ Issue material ▪ Record hours and quantities ▪ Record completions <p>Labor Efficiency (Actual) The difference between the planned and actual labor costs, based on the work order routing.</p> <p>Material Usage (Actual) The difference between the planned and actual material costs, based on the work order parts list.</p>
Other	<p>Three ways to produce Other Variances</p> <p>There are three ways to produce Other Variances in Manufacturing Accounting:</p> <ol style="list-style-type: none"> 1. The first is through rounding. If there is a difference in the number of data decimals in the work order variance file F3102 and the item cost component additions file F30026 versus the Account Ledger file F0911, the system produces a rounding variance. These other variances are for very small amounts. 2. The second is to change the Frozen Standard Cost of a parent or component in the F30026 when there is a work order in process. When there are existing costs and they get changed in the middle of producing an item, this leaves a balance in WIP when P31802 - Completions is run. You can revalue WIP when there is a change to Frozen Standard Costs by setting the processing options in Frozen Update (P30835). 3. The third way to produce an Other Variance is to over- or under-complete a work order.

Set Up Manufacturing Accounting

Setting Up Manufacturing Accounting

You can customize the Manufacturing Accounting system to meet your specific manufacturing environment needs.

This section contains the following:

- [Setting Up General Ledger \(G/L\) Class Codes](#)
- [Reviewing Manufacturing AAIs](#)

Note: Because the system generates journal entries based on how you set them up, you should define these options carefully.

Setting Up General Ledger (G/L) Class Codes



From Inventory Management (G41), choose **Inventory Master/Transactions**
From Inventory Master/Transactions (G4111), choose **Item Branch/Plant Information**

G/L class codes are used by the AAIs to determine to which accounts the system posts transactions.

To set up G/L class codes

On Item Branch/Plant Information

Complete the following field:

- G/L Class

This value defaults to the primary location G/L Class code on the Item Location screen (F11). Manufacturing Accounting programs use the primary location G/L Class code to locate the account number to use.

Field	Explanation
G/L Class	<p>A user defined code that identifies the G/L offset to use when the system is searching for the account to which it will post the transaction. If you do not want to specify a class code, you can enter **** (four asterisks) in this field.</p> <p>The table of Automatic Accounting Instructions (AAIs) allows you to predefine classes of automatic offset accounts for the Inventory, Purchase, and Sales Order Management systems. G/L categories might be assigned as follows:</p> <p>IN20 Direct Ship Orders</p> <p>IN60 Transfer Orders</p> <p>IN80 Stock Sales</p> <p>The system can generate accounting entries based upon a single transaction. As an example, a single sale of a stock item can trigger the generation of accounting entries similar to these:</p> <p>Sales-Stock (Debit) xxxxx.xx</p> <p>A/R Stock Sales (Credit) xxxxx.xx</p> <p>Posting Category: IN80</p> <p>Stock Inventory (Debit) xxxxx.xx</p> <p>Stock COGS (Credit) xxxxx.xx</p> <p>Although this field is four characters, the system uses only the last two characters of the Category and the last character of the Document Type to find the AAI.</p>

Reviewing Manufacturing AAIs



From any Shop Floor Control menu, enter 29
From Shop Floor Control Setup(G3141), choose **Automatic Accounting Instructions**

Each transaction that creates journal entries has automatic accounting instructions (AAIs) that instruct the program to post to specific G/L accounts. User defined AAIs connect manufacturing accounting, your chart of accounts, and financial reporting. You should create AAIs for each unique combination of company, transaction, document type, and G/L class that you anticipate using.

Note: AAIs are the same for actual cost as the AAIs used for standard cost.

To create G/L entries for transactions, the AAIs access the following information to find the account number to use:

- Company number
- Document type
- G/L class code
- Cost component

- Branch or business unit

Each AAI or record type points to a specific G/L account consisting of a business unit, an object, and a subsidiary code. JD Edwards World defines manufacturing AAIs at the 3000 level, as follows:

AAI	Description
3110 Raw Materials/Subassemblies	Specifies which balance sheet G/L accounts are used when issuing raw materials or parts from inventory to work in process. Also used to issue completed subassemblies from inventory back into work in process.
3120 Work in Process	For debit transactions, increases the material value of work in process by issuing raw materials and parts to work orders. Also records increases in direct labor, setup labor, machine time, and overhead by applying them to issued materials. For credit transactions, records the transfer of work order material costs from work in process inventory to some other inventory accounts because of work order completion. Also records the transfer of direct labor, setup labor, and overhead from work in process when work orders are complete.
3130 Subassemblies/Finished Goods	Specifies which balance sheet G/L accounts are used when receiving subassemblies or finished goods from work in process into inventory.
3220 Labor Variance	These five AAIs post debits when there is a difference between actual and standard costs associated with shop floor activities. Variances are posted as positive or negative depending on whether they are favorable or unfavorable.
3240 Material Variance	
3260 Planned Variance	
3270 Engineering Variance	
3280 Other Variance	
3401 Accruals	Specifies the profit and loss accounts that offset work in process labor transactions to work orders.

If you access the Automatic Accounting Instructions from any manufacturing menu, the system automatically enters 3000 (the beginning of the manufacturing AAIs) in the Skip To AAI field.

The following table shows which AAIs are used during the manufacturing accounting process.

Transaction Type	Debit Account	Credit Account
IM	3120	3110*
IC	3130	3120
IS	3130.scrap	3120

*The credit side of the IM transaction uses the G/L Class Codes of the components to write journal entries to take raw material out of inventory. The debit side of the IM transaction and all other transactions use the G/L Class Code of the parent to generate journal entries.

The following table shows which AAIs are used during the variance accounting AAIs.

Note: In the WIP Account (IM+IH)-IC=IV.

3120 (WIP)	Or	3120 (WIP)	Depending on WIP account, will debit or credit to clear variance from WIP
3220	Or	3220	Labor Variance
3240	Or	3240	Material Variance
3260	Or	3260	Planned Variance
3270	Or	3270	Engineering Variance
3280	Or	3280	Other Variance

To review AAIs

On Automatic Accounting Instructions

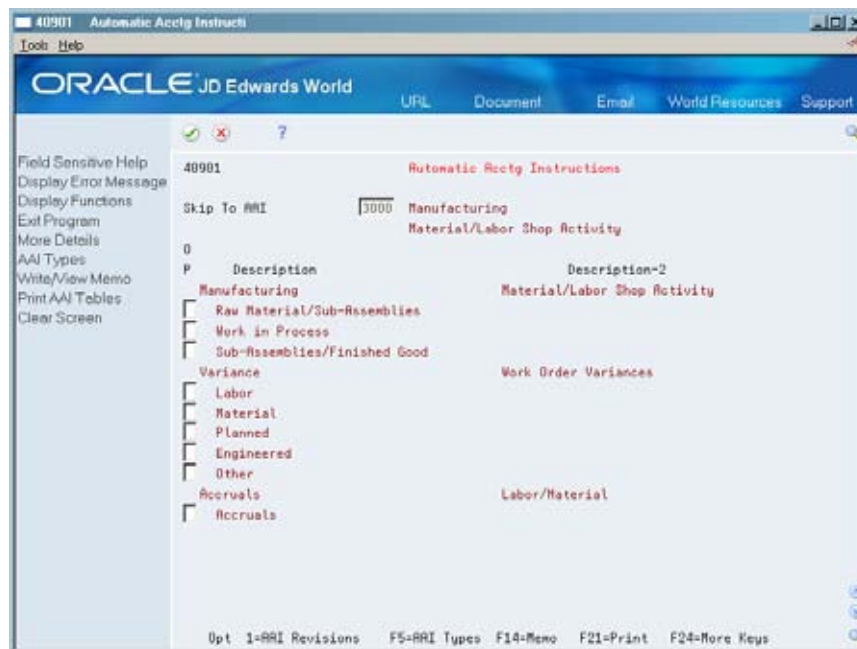

1. To view the AAI table number for each record, access the detail area (F4).

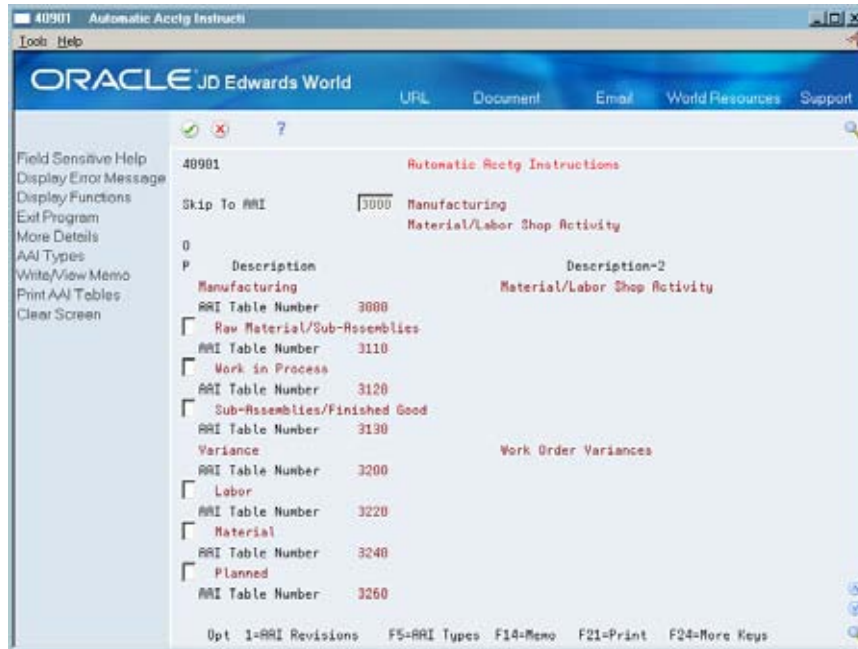

- To access Manufacturing and Distribution Automatic Account, choose AAI Revisions (Option 1).

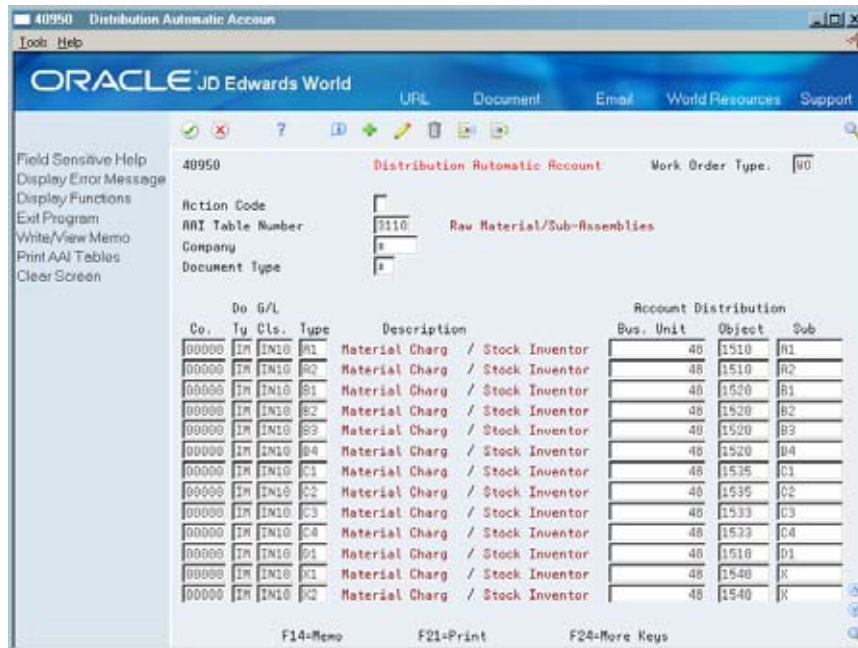

- On Manufacturing and Distribution Automatic Account, review the following fields:
 - Work Order Type
 - Company
 - Document Type
 - Company

- G/L Class Code
- Type
- Account Manufacturing and Distribution Business Unit
- Account Manufacturing and Distribution Object
- Account Manufacturing and Distribution Subsidiary

4. Access Memo Text (F14).

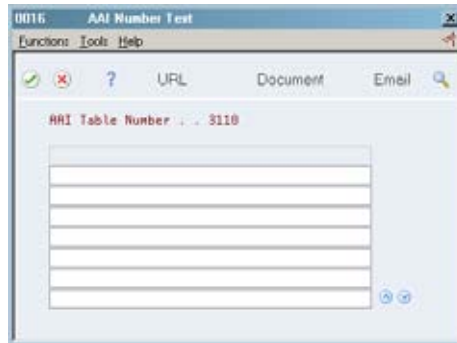

5. On AAI Number Text, review memo text for a record type.

Field	Explanation
Work Order Type	<p>A user defined code (00/DT) that identifies the type of document. This code also indicates the origin of the transaction. JD Edwards World has reserved document type codes for vouchers, invoices, receipts, and time sheets, which create automatic offset entries during the post program. (These entries are not self-balancing when you originally enter them.)</p> <p>The following document types are defined by JD Edwards World and should not be changed:</p> <p>P Accounts Payable documents</p> <p>R Accounts Receivable documents</p> <p>T Payroll documents</p> <p>I Inventory documents</p> <p>O Purchase Order Processing documents</p> <p>J General Accounting/Joint Interest Billing documents</p> <p>S Sales Order Processing documents</p>

Field	Explanation
Company	<p>A code that identifies a specific organization, fund, entity, and so on. This code must already exist in the Company Constants table (F0010). It must identify a reporting entity that has a complete balance sheet. At this level, you can have intercompany transactions.</p> <p>Note: You can use company 00000 for default values, such as dates and automatic accounting instructions (AAIs). You cannot use it for transaction entries.</p> <p style="text-align: center;"><i>Form-specific information</i></p> <p>In the inquiry field at the top of the form, the asterisk (*) is the default value. It causes the system to display AAIs for all companies.</p>
Document Type	<p>A user defined code (system 00/type DT) that identifies the origin and purpose of the transaction.</p> <p>JD Edwards World reserves several prefixes for document types, such as vouchers, invoices, receipts, and timesheets.</p> <p>The reserved document type prefixes for codes are:</p> <ul style="list-style-type: none">P Accounts payable documentsR Accounts receivable documentsT Payroll documentsI Inventory documentsO Order processing documentsJ General ledger/joint interest billing documents <p>The system creates offsetting entries as appropriate for these document types when you post batches.</p> <p style="text-align: center;"><i>Form-specific information</i></p> <p>In the inquiry field at the top of the form, the asterisk (*) is the default and causes the system to display all document types.</p>

Field	Explanation
Bus. Unit	<p>An alphanumeric field that identifies a separate entity within a business for which you want to track costs. For example, a business unit might be a warehouse location, job, project, work center, or branch/plant.</p> <p>You can assign a business unit to a voucher, invoice, fixed asset, and so on, for purposes of responsibility reporting. For example, the system provides reports of open accounts payable and accounts receivable by business units to track equipment by responsible department.</p> <p>Security for this field can prevent you from locating business units for which you have no authority.</p> <p>Note: The system uses this value for Journal Entries if you do not enter a value in the AAI table.</p> <p style="text-align: center;"><i>Form-specific information</i></p> <p>If you leave this field blank, the system uses the business unit that you entered on the work order, in the Charge to Cost Center field.</p>
Object Account	<p>The object account portion of a general ledger account. The term “object account” refers to the breakdown of the Cost Code (for example, labor, materials, and equipment) into subcategories (for example, dividing labor into regular time, premium time, and burden). If you are using a flexible chart of accounts and the object is set to 6 digits, JD Edwards World recommends that you use all 6 digits. For example, entering 000456 is not the same as entering 456, because the system enters three blank spaces to fill a 6-digit object.</p>
Sub	<p>A subdivision of an object account. Subsidiary accounts include more detailed records of the accounting activity for an object account.</p> <p style="text-align: center;"><i>Form-specific information</i></p> <p>If you leave this field blank, the system uses the value you entered on the work order in the Cost Code field.</p>

What You Should Know About

Selection of AAIs

To choose an AAI, the system searches first for an exact match between company and the G/L class code. If it does not find one, it then searches for the default company and the item's G/L class code. If it does not find a match there, it then searches for the company, and uses **** (four asterisks) for the G/L class code.

Processing Options

See [AAI Revisions \(P40901\)](#).

Work with Work Orders

Working with Work Orders

Work with work orders to view the effect of each step on manufacturing accounting.

This section contains the following:

- [Creating a Work Order \(P48013\)](#)
- [Attaching a Parts List and Routing Instructions](#)
- [Issuing Parts to Work Orders](#)
- [Recording Hours and Quantities Used](#)
- [Recording Component Scrap](#)
- [Recording Completions to Work Orders](#)

Creating a Work Order (P48013)



From Shop Floor Control (G31), choose **Daily Order Preparation * Discrete**
From Daily Order Preparation * Discrete (G3111), choose **Enter/Change Order**

Create a work order as the first step in the process of understanding the cycle of a work order and its effect on manufacturing accounting.

When a work order is entered, the parent item's Sales/Inventory cost method for the F4105 is retrieved and stored in the F4801T field called WALEDG. The value in this field will determine if costing of the work order is standard or actual. Valid cost methods are 02 for Actual Cost or 07 for Standard Costing. Work order processing, completions, outside operations receipts, manufacturing accounting and close actual cost work order will use this field to determine how values are calculated and written.

See Also

- *Creating Work Orders (P48013) in the Shop Floor Control Discrete Manufacturing Guide*

To create a work order

On Enter/Change Order

Complete the following fields:

- Item Number
- Requested
- Quantity Ordered
- Branch/Plant
- Charge to Business Unit
- Cost Code

Field	Explanation
Item Number	A number that the system assigns to an item. It can be in short, long, or 3rd item number format.

Field	Explanation
Requested	<p>The date that an item is to arrive or that an action is to be complete.</p> <p style="text-align: center;"><i>Form-specific information</i></p> <p>For Shop Floor Control</p> <p>When you change the requested date:</p> <ul style="list-style-type: none"> ▪ The system calculates a new start date based on the new requested date if you delete the date in the Start Date field before you enter the new requested date. If you do not delete the start date, the system does not recalculate or change it. ▪ The system recalculates the operation start and complete dates according to the scheduling rules defined.
Qty Ordered	<p>The quantity of units affected by this transaction.</p> <p style="text-align: center;"><i>Form-specific information</i></p> <p>For Shop Floor Control Discrete Manufacturing:</p> <p>When you change the order quantity, the system recalculates the following:</p> <ul style="list-style-type: none"> ▪ The component-required quantities and commitments ▪ The operation start and complete dates, if the lead times are variable <p>In the process industry:</p> <p>The quantity of co-/by-products produced by the process.</p>
Branch/Plant	<p>A code that represents a high-level business unit. It can be used to reference a branch or plant that might have departments or jobs, which represent lower-level business units (data item MCU), subordinate to it. For example:</p> <ul style="list-style-type: none"> ▪ Branch/Plant (MMCU) ▪ Dept A (MCU) ▪ Dept B (MCU) ▪ Job 123 (MCU) <p>Business unit security is based on the higher-level business unit.</p> <p style="text-align: center;"><i>Form-specific information</i></p> <p>For Shop Floor Control and Manufacturing Accounting:</p> <p>This field identifies the branch/plant in which the item resides.</p>

Field	Explanation
Charge to CC	<p>An alphanumeric field that identifies a separate entity within a business for which you want to track costs. For example, a business unit might be a warehouse location, job, project, work center, or branch/plant.</p> <p>You can assign a business unit to a voucher, invoice, fixed asset, and so on, for purposes of responsibility reporting. For example, the system provides reports of open accounts payable and accounts receivable by business units to track equipment by responsible department.</p> <p>Security for this field can prevent you from locating business units for which you have no authority.</p> <p>Note: The system uses this value for Journal Entries if you do not enter a value in the AAI table.</p> <p style="text-align: center;"><i>Form-specific information</i></p> <p>The default business unit for journal entries for the work order. The business unit on the AAI tables must be blank.</p>
Cost Code	<p>A subdivision of an object account. Subsidiary accounts include more detailed records of the accounting activity for an object account.</p> <p style="text-align: center;"><i>Form-specific information</i></p> <p>For Shop Floor Control and Manufacturing Accounting:</p> <p>If a value is not entered in the AAI table for subsidiary account, the system uses this value as a default in journal entries.</p>

Attaching a Parts List and Routing Instructions

	<p>From Shop Floor Control (G31), choose Daily Order Preparation * Discrete</p> <p>From Daily Order Preparation * Discrete (G3111), choose Order Processing</p>
---	---

You can attach the parts list and routing instructions in one of three ways:

- Manually
- Interactively
- Through the Process Work Orders program

For example, to understand its effect on manufacturing accounting, run Work Order Processing (P31410). Work order processing attaches the parts list and routing for a work order and updates the variance file, F3102. Costs will be generated in the standard and current columns of P3102 Variance Inquiry if the order is using standard cost. If using actual cost, the current column is populated and will be the original cost of the work order but no variances will be written.

A work order parts list (P3111) can also be attached from a bill of material or entered manually.

A work order routing (P3112) can be attached from a routing master or entered manually. The work order routing allows the entry of Employee Number and Machine Number. Actual cost orders will use the source for labor and machine rates from the Manufacturing Constants to determine these values. If employee rates and machine billing rates are chosen in the Manufacturing Constants and they are not entered, you will get a warning message and the system will use the 02 work center rates.

See Also

- *Attaching the Parts List Interactively (P3111) in the Shop Floor Control Discrete Manufacturing Guide*
- *Attaching the Routing Instructions Interactively (P3112) in the Shop Floor Control Discrete Manufacturing Guide*
- *Processing Work Orders (P31410) in the Shop Floor Control Discrete Manufacturing Guide*

Processing Options

See [Generate and Print Work Orders \(P31410\)](#).

Issuing Parts to Work Orders

	From Shop Floor Control (G31), choose Daily Order Preparation * Discrete From Daily Order Preparation * Discrete (G3111), choose Inventory Issues
---	--

Issue the necessary parts to the work order. There are four ways to issue parts:

- Manually
- Preflushing
- Backflushing
- Super backflushing

Whichever method you use, when you issue parts to a work order, you create:

- One source of an actual variance, if the cost of materials issued is different from the cost of materials specified on the parts list
- Unaccounted units in the Parts List table

For example, to understand its effect on manufacturing accounting, issue the parts manually using Work Order Inventory Issues (P31113).

At the time inventory is issued, the system will use the following to write the Cardex IM transaction. The component cost is calculated using the parts list quantity multiplied by the P4105 Sales/Inventory cost of the component item(s). The unaccounted units are written to the CTS1 field. For actual cost orders, the cost is written to the CST4 amounts field in the F3111. For actual cost orders, the P31802 uses CTS4 for the material issue journal entry value. For standard cost orders, the P31802 uses the frozen component cost from Cost Components (P30026).

For standard cost (07) parents, use processing option number 22 of the Inventory Issues program (P31113). This option generates the use the P4105 cost value rather than frozen standard cost. This option also prevents integrity issues between manufacturing journal entries and the Cardex. However, it should be noted that manufacturing variances are designed to be efficiency/usage variances. Using this option will add material cost into the variance.

Note: For standard cost, if the cost for the item in P4105 at the time of issue is not equal to the value in P30026 at the time Manufacturing accounting is run, the journal entry will not match the Cardex value.

See Also

- About Issue Transactions in the Shop Floor Control Discrete Manufacturing Guide

To issue parts to work orders

On Inventory Issues

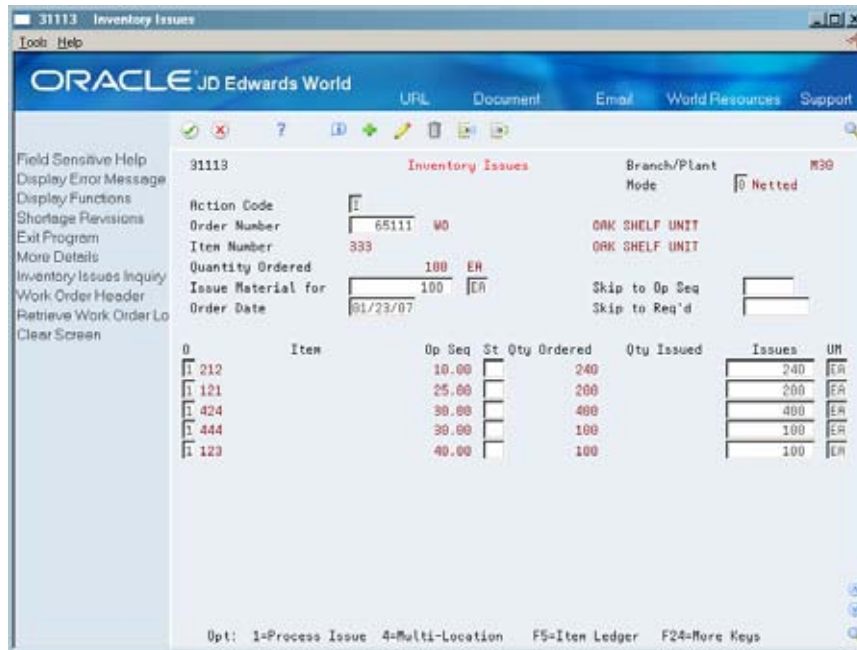

Complete the following fields:

- Order Number
- Issue Material For

Field	Explanation
Order Number	A number identifying the original document. This can be an invoice number, work order number, sales order number, journal entry number, and so on.

Field	Explanation
Issue Material for	The number of parent items you want to process. The system calculates lower-level values in quantity per the number of parent items requested. For example, if 3 components are needed for a parent item, and the requested quantity is 10, the system plans for 30 components.

Recording Hours and Quantities Used

	From Shop Floor Control (G31), choose Daily Order Reporting * Discrete From Daily Order Reporting * Discrete (G3112), choose Hours and Quantities
---	--

As you produce items on a work order, you record the hours spent on production and the number of items completed in that time.

When you record hours and quantities used, you create:

- One source of an actual variance, if the cost of machine and labor reported differs from the cost of machine and labor as specified on the work order parts list and routing instructions
- Unaccounted units in the Routing Instructions table

Hours & Quantities (P311221) retrieves machine and labor rates for actual cost orders from the sources in the Manufacturing Constants or they can be manually input.

The labor rates sources areas follows:

- Frozen Work center rates from the F30008 work center rates for the 02 cost method
- Employee labor rates table (31/ER in F00191)
- Manual entry (Manual entry will over-ride any of the other rates)

The machine rate sources include:

- Frozen Work center rates from the F30008 work center rates for the 02 cost method
- Equipment rental rates from F1301
- Manual entry (Manual entry will over-ride any of the other rates)

Labor by Shop Floor Control (P061181) is another way to process hours and quantities. You can activate this program and the related manufacturing fields by turning on processing options 10 through 12. This processing option updates the F31122 work order Time Transaction table with actual employee hours and labor rates charged to each work order. Enter a value of 1 in the option field to set an exit to the regular time entry screen for manufacturing.

To record hours and quantities used

On Hours and Quantities

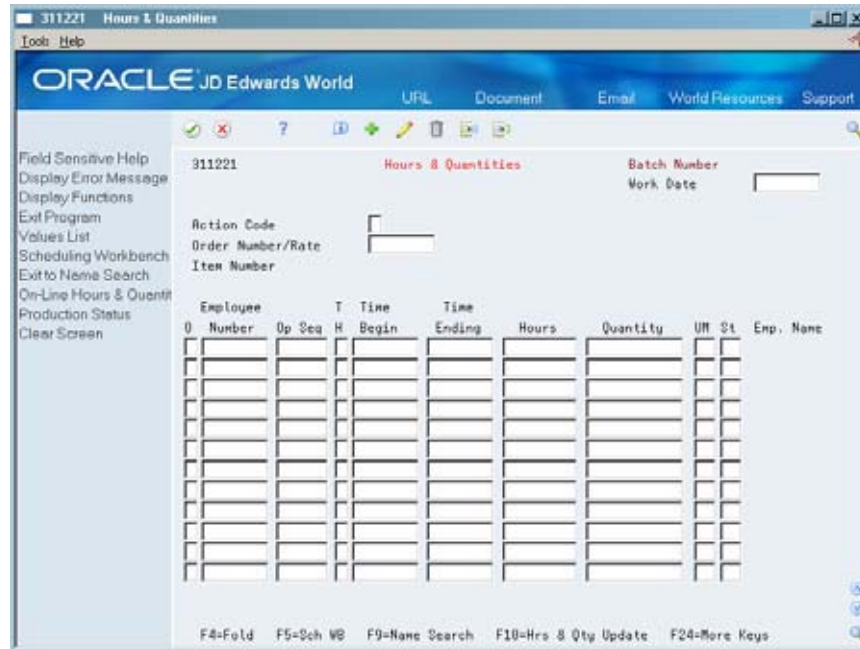

Complete the following fields:

- Work Date
- Order Number
- Employee Number
- Operation Number
- Type of Hours
- Hours
- Quantity
- Unit of Measure
- Operation Status

Field	Explanation
Work Date	A date that identifies the financial period to which the transaction is to be posted. The general accounting constants specify the date range for each financial period. You can have up to 14 periods. Generally, period 14 is for audit adjustments. The system edits this field for PBCO (posted before cutoff), PYEB (prior year ending balance), and so on.

Field	Explanation
Order Number/Rate	<p>A number identifying the original document. This can be an invoice number, work order number, sales order number, journal entry number, and so on.</p> <p style="text-align: center;"><i>Form-specific information</i></p> <p>You can specify the order number or employee number in the processing options for the Hours and Quantities program.</p>
Employee Number	<p>A number that identifies an entry in the Address Book system. Use this number to identify employees, applicants, participants, customers, suppliers, tenants, and any other Address Book members.</p>
Op Seq	<p>In routings, this number is used to sequence the fabrication or assembly steps in the manufacture of an item. You can track costs and charge time by operation.</p> <p>In bills of material, this number designates the routing step in the fabrication or assembly process that requires a specified component part. You define the operation sequence after you create the routing for the item. The Shop Floor Control system uses this field in the backflush/preflush by operation process.</p> <p>In engineering change orders, this number is used to sequence the assembly steps for the engineering change.</p> <p>Skip To fields allow you to enter an operation sequence that you want to begin the display of information.</p> <p>You can use decimals to add steps between existing steps. For example, use 12.5 to add a step between steps 12 and 13.</p> <p style="text-align: center;"><i>Form-specific information</i></p> <p>This is the sequence number of the routing step on the work order. You must enter this number.</p>
T H	<p>A code to indicate the type of time entered. Valid codes are:</p> <ul style="list-style-type: none"> 1 Run Labor Hours 2 Setup Labor Hours 3 Machine Hours 4 Quantities Completed 5 Quantities Scrapped 9 Miscellaneous (piece rate bonus and so forth)
Hours	<p>The number of hours associated with each transaction.</p>
Quantity	<p>The number of units committed for shipment in Sales Order Entry, using either the entered or the primary unit of measure defined for this item.</p> <p>In the Manufacturing system and Work Order Time Entry, this field can indicate completed or scrapped quantities. The quantity type is determined by the type code entered.</p>

Field	Explanation
St	A user-defined code (31/OS) that identifies the current status of a work order or engineering change order as the operation steps in the routing are completed.

Hours and Quantities Update (P31422)

Based on the information in F311221, entered from either P311221 or P061181, the Hours and Quantities Update (P31422) program will update F3112 with both unaccounted units and amounts using the CTS1-CTS6 fields:

- CTS1 Unaccounted Direct Labor Units
- CTS2 Unaccounted Setup Labor Units
- CTS3 Unaccounted Machine Units
- CTS4 Unaccounted Direct Labor Amounts
- CTS5 Unaccounted Setup Labor Amounts
- CTS6 Unaccounted Machine Amounts

Recording Component Scrap

	From Shop Floor Control (G31), choose Daily Order Preparation * Discrete From Daily Order Preparation * Discrete (G3111), choose Component Scrap
---	---

When you report the quantity of component material scrapped, and you run Journal Entries for Work in Process or Completions, the program calculates the new A2 cost value for the parent. If the amount of the scrapped material differs from the estimated scrap amount on the bill of material, this difference updates the amount of the actual variance.

See Also

- *Recording Component Scrap (P31116) in the Shop Floor Control Discrete Manufacturing Guide*

To record component scrap

On Component Scrap

The screenshot shows the Oracle JD Edwards World Component Scrap form. The form is titled "31116 Component Scrap" and includes a menu bar with "Tools" and "Help". The main area displays the following fields:

- Action Code: []
- Order Number: 55111 WO
- Item Number: 333
- Quantity Ordered: 100 EA
- Quantity Completed: [] EA
- Transaction Date: 01/23/07
- Branch/Plant Requested: M30
- Requested: 09/08/17
- Unit of Measure: OAK SHELF UNIT

Below the fields is a table for "Quantities" with columns for "Item", "Issued", "Scrapped", and "Quantity To Scrap". The table lists the following items:

Item	Issued	Scrapped	Quantity To Scrap	UM
212				EA
121				EA
424				EA
444				EA
123				EA

At the bottom of the form, there are two function keys: "F5-Inventory Issues" and "F24-More Keys".

- Review the following fields:
 - Quantity Ordered
 - Quantity Completed
 - Ingredient
 - Quantities Issued
 - Quantities Scrapped
- Complete the following field:
 - Quantity to Scrap
- Complete the following optional fields:
 - Unit of Measure
 - Transaction Date
- Access the detail area (F4).

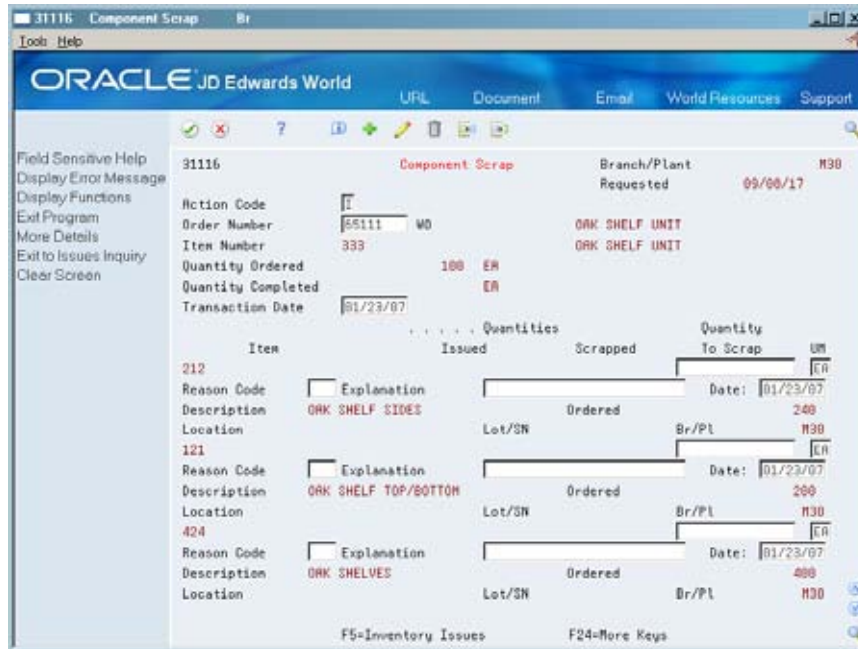

The detail area is only accessible if you have already issued parts to the work order.

5. Complete the following optional fields:

- Reason Code
- Explanation
- Date

Field	Explanation
Quantity Ordered	The quantity of units affected by this transaction. <i>Form-specific information</i> The work order quantity.
Quantity Completed	The number of units committed for shipment in Sales Order Entry, using either the entered or the primary unit of measure defined for this item. In the Manufacturing system and Work Order Time Entry, this field can indicate completed or scrapped quantities. The quantity type is determined by the type code entered. <i>Form-specific information</i> The quantity completed on this work order to date.
Transaction Date	The date that an order was entered into the system. This date determines which effective level that the system uses for inventory pricing.

Field	Explanation
Item Number	A number that the system assigns to an item. It can be in short, long, or 3rd item number format. <i>Form-specific information</i> These are the components used on this work order.
Scrapped	The number of units canceled in Sales Order or Work Order Processing, using either the entered or the primary unit of measure defined for this item. In manufacturing, this can also be the number of units scrapped to date.
Reason Code	A user-defined code (system 42/type RC) that explains the purpose for a transaction. For example, you can indicate the reason that you are returning items, such as the goods were damaged in shipment or too many goods were shipped. <i>Form-specific information</i> A user-defined code (system 41, type RC) that indicates the reason for the quantity scrapped at this operation.
Explanation	This text identifies the reason that a transaction occurred.
Quantities Issued field	The quantity of a component that has been issued to date.
Quantity to Scrap field	The quantity of a component that is being scrapped on this work order.

Processing Options

See [Component Scrap Transactions \(P31116\)](#).

Recording Completions to Work Orders

	From Shop Floor Control (G31), choose Daily Order Reporting * Discrete From Daily Order Reporting * Discrete (G3112), choose Full Completion
---	---

When you finish production of a work order on the shop floor, you must record the completions to inventory. These transactions update records in the Inventory Management system. You can record completions in the following ways:

- Super backflushing
- Partial completion
- Full completion
- Backflushing at completion

When you record completions to a work order, you create:

- One source of an actual variance, if the cost of materials and labor reported differs from the cost of materials and labor as specified on the work order parts list and routing instructions
- Unaccounted units in the Work Order Master table

For example, to understand its effect on manufacturing accounting, record a full completion.

The Work Order Completions (P31114) is a key program for actual costing. All material issues, hours and quantities entry and hours and quantities update should be in place before completing the work order. The entire work order must be completed to a single location. Stock should not be moved from this location until all accounting is complete. Parent scrap is reported at the time of work order completion.

Work order completion does all of the following in Actual Costing:

- Calculates the work order cost.
- Updates the units and amounts to the F4801 CTS1 and F4801T CTS4 fields.
- Creates/Updates unaccounted completions and scrap amounts in the F3102.
- Recalculates weighted average and updates the F4105 with the new unit cost for method 02.
- Updates the Cardex with the completed units and 02 value.

See Also

- *Completing Work Orders (P31114) in the Shop Floor Control Discrete Manufacturing Guide*

To record completions to work orders

On Full Completion

Complete the following fields:

- Order Number
- Quantity Completed
- Quantity Scrapped
- Date Complete
- Work Order Status

Field	Explanation
Scrapped	The number of units canceled in Sales Order or Work Order Processing, using either the entered or the primary unit of measure defined for this item. In manufacturing, this can also be the number of units scrapped to date.
Completed Date	The date the work order or engineering change order is completed or canceled.
St	A user-defined code (00/SS) that describes the status of a work order or engineering change order. Any status change from 90 thru 99 automatically updates the date completed.

What You Should Know About

Outside Operations

When outside operations purchase orders are received in the P3103W, the actual purchase order units and amounts are updated in the F3112 using the CTS7 and CTS8 fields.

Create Journal Entries

Creating Journal Entries

You create journal entries for work in process (issues, labor entry, and machine run time), completions, and manufacturing variances as the first step towards posting these transactions to the general ledger.

To create journal entries for shop order transactions (from work orders and rate schedules), complete the following tasks:

- [Creating Journal Entries for Work in Process or Completions](#)
- [Reviewing Variances \(P3102\)](#)
- [Creating Journal Entries for Variances](#)
- [Creating Journal Entries for Bulk Manufacturing Gains and Losses](#)
- [Reviewing Summarized Work Order Journal Entry Batches](#)

If you have extra costs on purchased items, and you want to calculate their costs separately, you need to understand purchase price variance and material burden cost.

See Also

- *Appendix C – Purchase Price Variance*

Journal Entries and the Three-Tier Process

When you enter daily journal transactions, you are performing the first of three steps in the JD Edwards World three-tier process. This process is used throughout all JD Edwards World entry programs and includes the following steps:

- Entering transactions into a batch
- Reviewing and approving the batch for posting
- Posting the batch transactions

The following graphic illustrates the three-tier process.

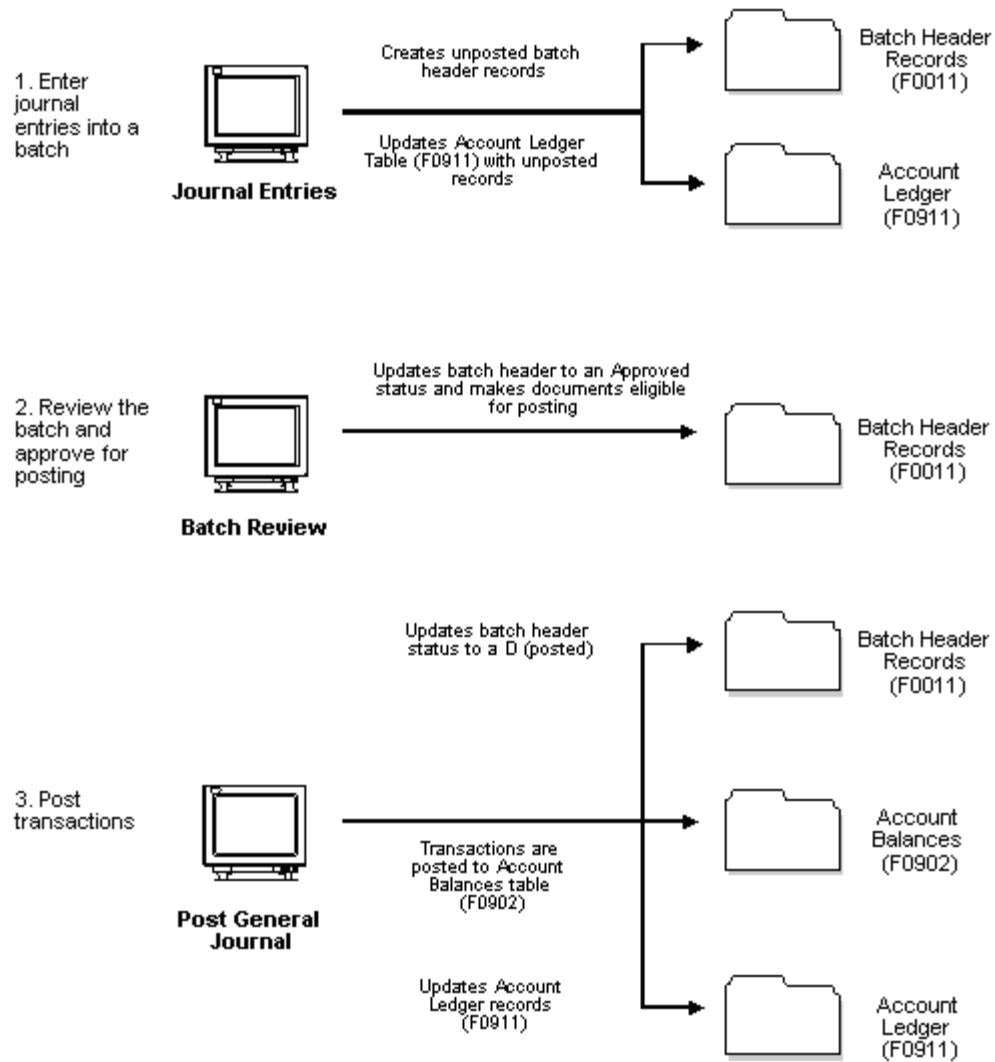

Journal entries can occur in two ways:

- Manually, when you enter transactions through the General Accounting system, such as:
 - Accruals
 - Adjustments
 - Reclassifications
- Automatically, when the Journal Entries for Work in Process or Completions program generates journal entries based on another system's transactions, such as:
 - Manufacturing Accounting
 - Shop Floor Control

In the Manufacturing Accounting system, you use programs to create journal entries for various types of shop floor activity, including:

- Material issues

- Labor and machine reporting
- Completions
- Scrap
- Variances
 - Engineering
 - Planned
 - Material usage (actual)
 - Labor efficiency (actual)
 - Other (volume)

Detail and Summary Journal Entries

You can enter detail or summary entries for both debit and credit journal entry transactions. Use the object portion of the account number to control the level of detail of your journal entries.

Detail Journal Entries

To enter detail journal entries for a work order by cost component, enter a different object account number for each cost component.

For example:

Cost Component	Business Unit	Account Number
A1	M30	1341
B1	M30	1342
B2	M30	1343

Summary Journal Entries

To summarize the cost components for an item on a work order into a single journal entry, enter the costs with the same object account number.

For example:

Cost Component	Business Unit	Account Number
A1	M30	1340
B1	M30	1340
B2	M30	1340

In addition, you can set processing options to:

- Summarize material issues (document type IM) by account number within a work order. There is one journal entry for each unique combination of account number and work order number.
- Summarize all journal entries by account number across work orders. There is one entry for the batch for each account. The entry is the sum of all work order transactions for each account by document type.
- Print a summarized Accounting Transaction report.

If you use summarized journal entries, the program batches the appropriate work orders and then builds the Cross-Reference table (F3106). The table can be viewed from the Work Order Processing menu (G3116), using the GL Review by WO Number menu (option 22).

Creating Journal Entries for Work in Process or Completions

	From Shop Floor Control (G31), choose Daily Manufacturing Accounting From Daily Manufacturing Accounting (G3116), choose Work in Process or Completions
---	--

Journal Entries for Work in Process or Completions creates journal entries for shop floor activity. You can report transactions for material issues, completions, and labor and machine hours reported against a work order.

This program locates unaccounted units in the Parts List table, Routing Instructions table, and Work Order Master table, and creates journal entries for them. The program then purges the unaccounted units.

This program also updates information in the Work Order Variances table (F3102), which Journal Entries for Variances uses to create journal entries for transactions with variances.

This program uses the following AAI tables to match inventory and cost transactions to general ledger accounts.

AAI	Description
3110 Credit inventory, raw materials/subassemblies	Moves inventory cost from inventory during issue reporting. Not used by variance accounting.
3120 Debit/credit work in process	Moves inventory cost to WIP during inventory issue and shop hours report. Also moves inventory from WIP during inventory completion reporting.
3130 Debit inventory, subassemblies/finished goods	Moves inventory cost to inventory during the completion reporting. Not used by variance accounting.
3401 Credit accruals	Moves shop hour cost to accruals during shop hours reporting. Not used by variance accounting.

Hierarchy Search for the Appropriate AAI

The system locates the general ledger account number to use when generating manufacturing entries by accessing the appropriate AAI table and searching for a unique combination of the following five keys:

- Work Order Type for the AAI
- Company Number
- Document Type
- General Ledger Class Code
- Cost Type

The program makes the following four passes to retrieve this information prior to finalizing the selection.

- It will attempt to locate an exact match in the AAIs based on the five keys.
- Next it will search for a match by the Order Type, the Company number that the Branch/Plant reports to, and the G/L Class Code.
- Next it will search for a match by the Order Type, the default/wild card Company 00000 and the G/L Class Code.
- As a last resort it will select the default/wild card Company of 00000 with a G/L Class Code wild card of ****.

31803		JD Edwards World				Page	1		
Batch Type	- 0	Manufacturing WIP Journal Entries				Date	4/03/17		
Batch Number	- 129172	for Work Orders in Process							
Batch Date	- 04/03/17	Status Less Than 95							
Report Mode	- Summarize by Acct. across WO's								
J/E Mode	- Summarize by Acct. across WO's								
G/L RECAP (Summarized by Account)									
Do Ty	Document Ty	Or Date	G/L Co	Account Description Explanation	G/L Account Subldgr-Ty	Amounts		LT	
						Debit	Credit		
IM	135634	WO	06/30/17	00200	Material	M30.1710.A1	3,416.28		AA
					Material Charged To W.O.'s				
					Summarized W.O.'s				
IM	135634	WO	06/30/17	00200	Material	M30.1510.A1		3,416.28-	AA
					Material Charged To W.O.'s				
					Summarized W.O.'s				
IH	135634	WO	06/30/17	00200	Outside Ops	M30.1710.D1	67.05		AA
					Labor Charged To W.O.'s				
					Summarized W.O.'s				
IH	135634	WO	06/30/17	00200	Labor	M30.1720.B1	59.86		AA
					Labor Charged To W.O.'s				
					Summarized W.O.'s				
IH	135634	WO	06/30/17	00200	Variable Labor	M30.1730.C3	44.18		AA
					Labor Charged To W.O.'s				
					Summarized W.O.'s				
IH	135634	WO	06/30/17	00200	Fixed Labor	M30.1730.C4	36.82		AA
					Labor Charged To W.O.'s				
					Summarized W.O.'s				
IH	135634	WO	06/30/17	00200	Other Charges	M30.1740.X	254.55		AA
					Labor Charged To W.O.'s				
					Summarized W.O.'s				
IH	135634	WO	06/30/17	00200	R&D	M30.1740.X5	.30		AA
					Labor Charged To W.O.'s				
					Summarized W.O.'s				
IH	135634	WO	06/30/17	00200	Accrued Payroll	200.4205		59.86-	AA
					Labor Charged To W.O.'s				
					Summarized W.O.'s				
IH	135634	WO	06/30/17	00200	Actual Burden Clearing Account	200.4333		335.85-	AA
					Labor Charged To W.O.'s				
					Summarized W.O.'s				
IH	135634	WO	06/30/17	00200	Other Accrued Expenses	200.4420		67.05-	AA
					Labor Charged To W.O.'s				
					Summarized W.O.'s				
IC	135634	WO	06/30/17	00200	Material	M30.1510.A1	3,332.07		AA
					Completed W.O.'s To Inventory				
					Summarized W.O.'s				
IC	135634	WO	06/30/17	00200	Material/Scrap	M30.1510.A2	95.76		AA
					Completed W.O.'s To Inventory				
					Summarized W.O.'s				
IC	135634	WO	06/30/17	00200	Outside Operations	M30.1510.D1	67.05		AA
					Completed W.O.'s To Inventory				
					Summarized W.O.'s				
IC	135634	WO	06/30/17	00200	Direct Labor	M30.1520.B1	55.92		AA
					Completed W.O.'s To Inventory				
					Summarized W.O.'s				
IC	135634	WO	06/30/17	00200	Setup Labor	M30.1520.B2	6.69		AA
					Completed W.O.'s To Inventory				
					Summarized W.O.'s				
IC	135634	WO	06/30/17	00200	Labor Efficiency	M30.1520.B4	12.99		AA

Configured Items

After the Order Processing (P31410) program establishes frozen standard costs for configured items, journal entries for configured items are created in the same way as for non-configured items.

See Also

- Reviewing Manufacturing AAI's (P40901)

Processing Options

See [Manufacturing WIP Journal Entries \(P31802\)](#).

Reviewing Variances (P3102)



From Shop Floor Control (G31), choose **Daily Manufacturing Accounting**
From Daily Manufacturing Accounting (G3116), choose **Variance Inquiry (P3102)**

Review variances to identify errors before you run Journal Entries for Variances. For example, if you did not issue parts to a work order, a large actual variance appears. You can issue the parts, rerun Journal Entries for Work in Process or Completions, and review the variances again. After you correct any errors, run Journal Entries for Variances.

The Variance Inquiry screen displays the costs and variances associated with a work order. You can view variances by comparing amounts calculated in one mode to amounts calculated in another mode. Modes include:

- Frozen
- Current
- As planned
- Actual
- Completed

Variance Inquiry inserts defaults of 1 and 2 into the column modes when you first access the program. These defaults compare frozen costs with current costs, but you can change the values to compare different modes. The program uses frozen standard costs from the Cost Components table (F30026). Current amounts are based on the current bills of material, routings, and constants. Both frozen and current amounts are extended by the work order quantity.

The following table describes this interaction in more detail.

OPAT/OPUN	CCCA/CCCU	PLAT/PLUN	CLAT/CLUN	CPAT/CPUN
Show Amounts				
Standard Amount	Current Amount	Planned Amount	Actual Amount	Completed Amount
<u>Engineering Variance</u>				
	<u>Planned Variance</u>			
		<u>Actual Variance</u>		
				<u>Other Variance</u>
Parent item P30026 frozen std costs multiplied by W/O QTY at time of parts list attachment	Bill (F3002) and Routing (F3003) are used for these calculations. (units * frz std cost (P30026) of components and W/C rates * hours)	W/O Parts list (F3111) and Routing (F3112) are used for these calculations (units * frz std cost (P30026) of components and W/C rates * hours)	W/O Parts list (F3111) and Routing (F3112) are used for these calculations (units * frz std cost (P30026) of components and W/C rates * hours)	Parent item P30026 frozen std costs multiplied by W/O QTY at time of IC trx
<i>P a r t s L i s t</i>				
Work Order Quantity	Parts List Quantity	Current Parts List Quantity	Actual Quantity Issued Parts	Quantity Completed & Scrapped
x	x	x	x	x
30026	Current 30026	Current 30026	Current 30026	30026
(Frozen Standard)	(Frozen Standard)	(Frozen Standard)	(Frozen Standard)	(Frozen Standard)
From parent	From components	From current components	From current components	From parent for each
				cost type
<i>R o u t i n g</i>				
Work Order Qty	Current Routing	Current Routing	Actual Reported Hours	Qty Completed & Scrapped
x	x	x	x	x
30026	Current 30008	Current 30008	Current 30008	30026
(Frozen Standard)	(Frozen Standard)	(Frozen Standard)	(Frozen Standard)	(Frozen Standard)
Work Center Rates from parent	Work Center Rates	Work Center Rates	Work Center Rates	from parent for each cost type
<i>P o p u l a t e d b y</i>				
Attaching Parts	Attaching Parts	Running Manufacturing Accounting in proof or final.	Running Manufacturing Accounting (P31802) in final	Running Manufacturing Accounting (P31802) in final
List and Routing to Work Order Interactively or Batch (P31410)	List and Routing to Work Order Interactively or Batch (P31410)	Planned cost is recalculated each time the P31802 is run		

The following describes how the system calculates the different types of variances:

- **Engineering Variance** – This type of variance identifies an "engineering" or design change to the original bill of material and routing. The system uses AAI 3270 to write a journal entry for the difference between frozen standard for the parent and the parts list x frozen component cost (and routing x current frozen work center rates as attached to the work order).
- **Planned Variance** – This type of variance identifies a "planned" change to the parts list or routing. The system uses AAI 3260 to write a journal entry for the difference between the "current" parts list and routing as originally attached and the parts list and routing at the time P31802 was run.
- **Actual Variance** – This type of variances identifies the "actual" shop floor activity. The system uses AAI 3240 to write a journal entry for the difference between actual material issues and the planned parts list.

Uses AAI 3220 to write a journal entry for the difference between actual hours and the planned routing

- Other Variance – The system uses AAI 3280 to write journal entries for rounding differences, differences created by freezing standard costs for an open work order, and differences created by over- or under-completing the work order.

Note: See processing options P31804, Over/Under Completions Tab, Restate Production Costs. If this processing option is set, over- and under-completions variances will be eliminated.

What You Should Know About

Configured Items

If you manufacture configured items, no engineering variance exists because there is no bill of material.

Process Industry Accounting

Small engineering variances can appear on Variance Inquiry because the frozen amounts differ slightly from the current amounts. However, Journal Entries for Variances rounds the amounts, and no variances print on the report.

Amounts are calculated in the process industry as follows:

- Frozen amounts – Frozen amounts are based on the cost of the process, from the Cost Components table (F30026).
- Actual amounts – The actual costs of the ingredients issued are added to calculate the actual A1 cost of the process.
- Completed amounts – For each cost component, the completed costs of the co- and by-products are added to calculate the completed cost of the process for that cost component. For example, the completed B1 cost of all co- and by-products is added. The sum of the B1 costs is the completed B1 cost of the process.

To review variances

On Variance Inquiry

Process/Item	Cost	P/C	Frozen Amount	Current Amount	Variance Amount
333 R1		P	161.7892	161.7892	
333 R2		P	5.2560	5.2560	
333 B1		P	.3728	3.7275	3.3547-
333 B2		P		.0446	-.0446-
333 B3		P			
333 B4		P	.0867	.0863	-.7796-
333 C1		P			
333 C2		P			
333 C3		P	.2756	2.7830	2.5074-
333 C4		P	.2297	2.3192	2.0095-
333 D1		P	4.7800	4.7800	
333 X2		P	.8526	.8526	
333 X3		P	.0330	.0330	
333 X5		P	.0200	.0200	
Totals			189.7796	198.5554	8.7758-

1. Complete the following fields:

- Column 1 Mode
- Column 2 Mode
- Order Number

2. Review the following fields:

- Quantity Ordered
- Quantity Completed
- Item
- Cost
- Parent/Component
- Variance Amount

Depending on the values you entered for Column 1 Mode and Column 2 Mode, two of the following amounts appear:

- Frozen Amount
- Current Amount
- As Planned Amount
- Actual Amount
- Completed Amount

Field	Explanation
Column 1 Mode	<p>Determines which amounts the system displays in the first column on the data table for the work order. Valid codes are:</p> <ul style="list-style-type: none"> 1 Frozen (Standard) Cost 2 Current Cost 3 Planned Cost 4 Actual Cost 5 Completed Cost (includes scrapped) <p>The difference (variance) between column 1 and column 2 amounts displays in the Variance Amount (3rd) column.</p>
Column 2 Mode	<p>Determines which amounts the system displays in the second column on the data table for the work order. Valid codes are:</p> <ul style="list-style-type: none"> 1 Frozen (Standard) Cost 2 Current Cost 3 Planned Cost 4 Actual Cost 5 Completed Cost (includes scrapped) <p>The difference (variance) between column 1 and column 2 amounts displays in the Variance Amount (3rd) column.</p>
Quantity Ordered	<p>The quantity of units affected by this transaction.</p> <p style="text-align: center;"><i>Form-specific information</i></p> <p>The original order quantity for the work order.</p>
Quantity Completed	<p>The units completed for the work order.</p> <p style="text-align: center;"><i>Form-specific information</i></p> <p>The sum of units completed and scrapped on the work order.</p>
Process/Item	<p>A number that the system assigns to an item. It can be in short, long, or 3rd item number format.</p> <p style="text-align: center;"><i>Form-specific information</i></p> <p>This column contains either the number assigned to the item on the work order or a brief description of the item.</p>

Field	Explanation
Cost	<p>This code designates each element of cost for an item. An example of the coding structure is:</p> <p>A1 Purchased raw material B1 Direct labor routing sheet rollup B2 Setup labor routing sheet rollup C1 Variable burden routing sheet rollup C2 Fixed burden routing sheet rollup Dx Usually used for outside processing routing sheet rollup Xx Usually used for extra add-ons, such as electricity, water, and so forth</p> <p>The optional add-on computations usually operate with the type “X” extra add-ons. This cost structure allows you to use an unlimited number of cost components to calculate alternative cost rollups. The system then associates these cost components with one of six user defined summary cost buckets.</p> <p style="text-align: center;"><i>Form-specific information</i></p> <p>This code indicates which cost element, or type of cost, the amounts are for.</p>
P/C	<p>A code that indicates if the parent item number has a child item number associated with it. Valid codes are:</p> <p>Blank No relationship has been defined. P Parent number. C Child number. B Co-/By-Product</p>

See Also

- *Appendix B — Calculations for Variances*

Creating Journal Entries for Variances

	<p>From Shop Floor Control (G31), choose Daily Manufacturing Accounting From Daily Manufacturing Accounting (G3116), choose Variances</p>
---	--

Journal Entries for Variances creates detailed or summary journal entries for work order and rate schedule variances. These include engineering, planned, actual, and other variance transactions for the following items:

- Material issues
- Hours entry
- Material completions

The program generates an exceptions report that lists errors such as invalid account numbers. If no errors exist, the report states that the batch is error-free. However, this error check is not as comprehensive as the error check for the general ledger post process.

You can set processing options to:

- Indicate to which general ledger date to post entries
- Indicate the document type for the manufacturing variances
- Use the work order number as the subledger number for detailed journal entries
- Update the status of the work orders processed
- Run the program in proof or final mode
- Summarize journal entries
- Print an accounting journal report that details the journal entries
- Calculate the variances using either the:
 - Completed (plus scrapped) quantity, or
 - Ordered quantity

When you run this program in final mode, the system creates a batch of journal entries for posting to the general ledger.

The following graphic illustrates the flow of information when you run Journal Entries for Variances.

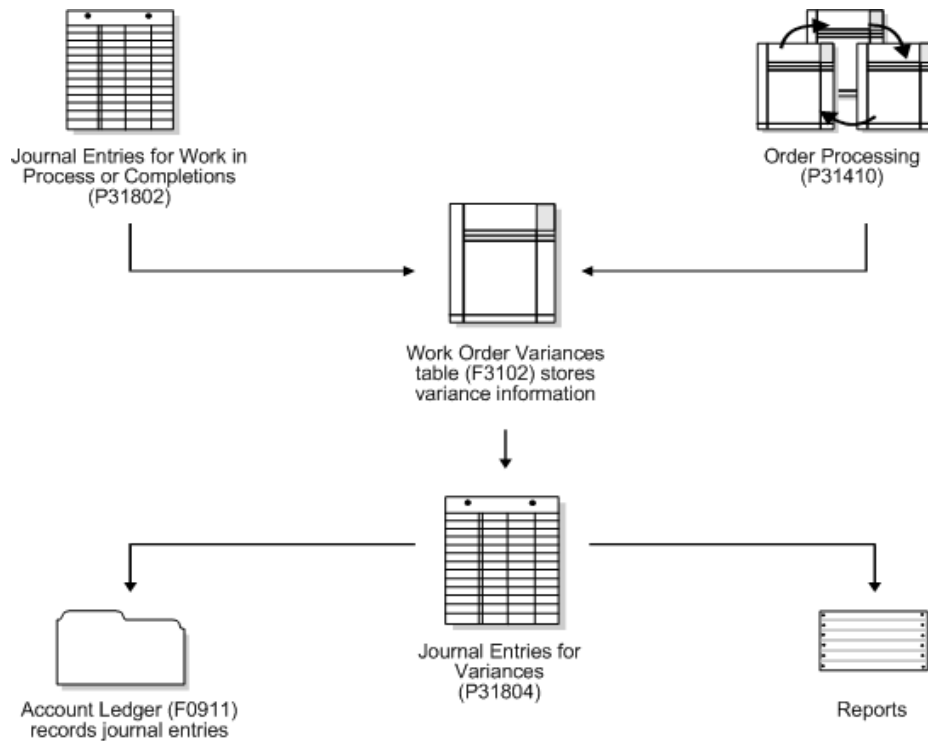

This program creates journal entries for variances using the following calculations.

Variance	Description
Engineering	Standard (frozen) cost minus current cost Results from a change to the standard bill of material or standard routing.
Planned	Current cost minus planned cost Results from a change to the parts list or routing instructions, or from a shrink factor.
Material usage (actual)	Planned cost minus actual cost
Cost components A1 and A2	Results from over- or under-issues.
Labor efficiency (actual)	Planned cost minus actual cost
All cost components except A1 and A2	Results from having actual hours that differ from the standard hours.
Other (to clear out WIP)	Completed cost minus standard cost Results from doing a cost rollup in the middle of the cycle.

The program uses the following AAI tables to match inventory and cost transactions to general ledger accounts:

AAI	Description
3120	WIP
3220	Variances, Labor
3240	Variances, Material
3260	Variances, Planned
3270	Variances, Engineered
3280	Other

The system uses the following data to match the transaction to the AAI account:

- Work order type for the AAI.
- Table number for the AAI. If the system does not find a match, it uses table 3280.
- Company number associated with the work order or component branch/plant. If the system does not find a match, it uses 00000.
- Document type associated with the transaction.
- G/L category code for the transaction item. If the system does not find a match, it uses **** (four asterisks).
- Cost component.

Before You Begin

- Run one or more available reports to review your production costs and variances. See *Reviewing World Writer Reports for Manufacturing Accounting*.

31805					JD Edwards World		Page	1
Batch Type	-				Manufacturing Variance Journal Entries		Date	4/03/17
Batch Number	-	129173			for Completed Work Orders			
Batch Date	-	04/03/17			Order Status EQ 96			
Report Mode	-	Summarize by Acct. across WO's						
J/E Mode	-	Summarize by Acct. across WO's						
G/L Recap (Summarized by Account)								
Do Ty	Document Ty	Or Date	G/L Co	Account Description Explanation	G/L Account Subldgr-Ty Amounts Debit Credit		LT
IV	135642	WO 04/03/17	00200	Direct Labor (Actual)	M30.6076.B1	3.95		AA
				Variance Calculated for W.O.'s Summarized Variances				
IV	135642	WO 04/03/17	00200	Setup Labor (Actual)	M30.6076.B2	8.92-		AA
				Variance Calculated for W.O.'s Summarized Variances				
IV	135642	WO 04/03/17	00200	Labor Eff (Actual)	M30.6076.B4	12.99-		AA
				Variance Calculated for W.O.'s Summarized Variances				
IV	135642	WO 04/03/17	00200	Material (Actual)	M30.6083.A1	84.21		AA
				Variance Calculated for W.O.'s Summarized Variances				
IV	135642	WO 04/03/17	00200	Scrap (Actual)	M30.6083.A2	95.76-		AA
				Variance Calculated for W.O.'s Summarized Variances				
IV	135642	WO 04/03/17	00200	Var Labor (ENG)	M30.6086.C3	1.34		AA
				Variance Calculated for W.O.'s Summarized Variances				
IV	135642	WO 04/03/17	00200	Fixed Labor (ENG)	M30.6086.C4	1.12		AA
				Variance Calculated for W.O.'s Summarized Variances				
IV	135642	WO 04/03/17	00200	Var Labor (Actual)	M30.6088.C3	2.52-		AA
				Variance Calculated for W.O.'s Summarized Variances				
IV	135642	WO 04/03/17	00200	Fixed Labor (Actual)	M30.6088.C4	2.10-		AA
				Variance Calculated for W.O.'s Summarized Variances				
IV	135642	WO 04/03/17	00200	Setup Labor	M30.6091.B2	2.23		AA
				Variance Calculated for W.O.'s Summarized Variances				
IV	135642	WO 04/03/17	00200	Material	M30.1710.A1		84.21-	AA
				Variance Calculated for W.O.'s Summarized Variances				
IV	135642	WO 04/03/17	00200	Scrap	M30.1710.A2		95.76	AA
				Variance Calculated for W.O.'s Summarized Variances				
IV	135642	WO 04/03/17	00200	Labor	M30.1720.B1		3.95-	AA
				Variance Calculated for W.O.'s Summarized Variances				
IV	135642	WO 04/03/17	00200	Setup	M30.1720.B2		6.69	AA
				Variance Calculated for W.O.'s Summarized Variances				
IV	135642	WO 04/03/17	00200	Labor Efficiency	M30.1720.B4		12.99	AA
				Variance Calculated for W.O.'s Summarized Variances				
IV	135642	WO 04/03/17	00200	Variable Labor	M30.1730.C3		1.18	AA
				Variance Calculated for W.O.'s Summarized Variances				
IV	135642	WO 04/03/17	00200	Fixed Labor	M30.1730.C4			

See Also

- Reviewing Manufacturing AAIs (P40901)*

Processing Options

See [Manufacturing Variance Journal Entries \(P31804\)](#).

Using the Close Actual Cost Work Order (P31806)

Since actual cost is not comparing costs to a standard, manufacturing variances are not created. Therefore you should not run the Manufacturing Variances Journal Entries (P31804) for actual cost work orders.

Instead, use Close Actual cost Work Order Accounting (P31806) to look for and find any costs that were not included at the time of completion (P31114). If unaccounted units or amounts are found, the report will instruct the user to run Manufacturing Accounting (P31802) before running P31806.

P31806 will write journal entries to clear WIP and adjust the Inventory balance. It will also adjust the finished good cost in the Cardex (P4111) and the per unit cost in (P4105) Cost Revisions.

Processing Options

See [Work Order Closing and Clear WIP \(P31806\)](#)

Creating Journal Entries for Bulk Manufacturing Gains and Losses

	From Bulk Stock Management (G4150), choose Bulk Stock Reconciliations From Bulk Stock Reconciliations (G41502), choose Gain/Loss Analysis Report
---	---

If you use bulk manufacturing and you indicated on the Work Center Master (F30006) that you want to calculate gains and losses, use this program to calculate the gains and losses. The program reads the Work Order Variances table (F3102) to calculate the total quantity issued and completed for a work center within a work order. The difference between the quantity issued and the quantity completed is the gain or loss for that work center. The program then writes a journal entry to the gain and loss account, and the offset to the manufacturing variance account for Other variances.

415141	Bulk Gain/Loss Exceptions										Page	1
											Date	12/31/17
Batch Number	Account Number	G/L Date	AAI Numb	Do Ty	G/L Cat	Cost Type	Document Number	Or Ty	Amount	Error Messages		
12345678	249.7513.A1	07/15/16	3280	IV	IN40	AL	12345678	WO	5.18	Account Number Invalid		

415142	Gain/Loss Posting Report										Page	1	
Batch Type	- O											Date	12/31/17
Batch Number	- 12345678												
Batch Date	- 07/15/16												
Report Mode	- Detailed												
J/E Mode	- Detailed												
Do Ty	Document Ty	Or Ty	G/L Date	Co	Account Description	G/L Subldgr-Ty	Account	Amounts	Debit	Credit	LT		
IV	12345678	WO	07/15/16	00249	Bulk Gains/Losses	249.9142	12345678	5.13			AA		
					Work Center BLEND1								
					Process Lube Oil 1 Blending								
					Gain/Loss Quantity: 3 LT								
IV	12345678	WO	07/15/16	00249	Material Variance	249.7513.A1	12345678				5.13- AA		
					Work Center BLEND1								
					Process Lube Oil 1 Blending								
Batch Total								5.13	5.13-				
Report Total								5.13	5.13-				

Processing Options

See [Gain/Loss Analysis Report \(P415402\)](#).

Reviewing Summarized Work Order Journal Entry Batches



From Shop Floor Control (G31), choose **Daily Manufacturing Accounting**
From Daily Manufacturing Accounting (G3116), choose **G/L Review - by WO Number**

You can view which work orders were summarized into a particular batch.

To review summarized work orders

On G/L Review – by WO Number

3106 G/L Review - by WO Number

Tools Help

ORACLE JD Edwards World

URL Document Email World Resources Support

Field Sensitive Help
Display Error Message
Display Functions
Exit Program
Sort By WO Number/B
Clear Screen

3106 G/L Review - by WO Number

User ID Enter '*' for all
Work Order
Document Number From: G/L Date From:
Thru: Thru:

0	Work Order	Document	Date		Batch	Date		User
P	Number	Ty	Number	Ty	Number	Ty	Date	

Option: 1-Detailed Batch Review F24=More Keys

Complete one or more of the following fields:

- User ID
- Work Order
- Document Number From:
- Document Number Thru:
- G/L Date From:
- G/L Date Thru:

The G/L Review – by WO Number screen displays summarized work order journal entries, their batch dates, and their general ledger dates.

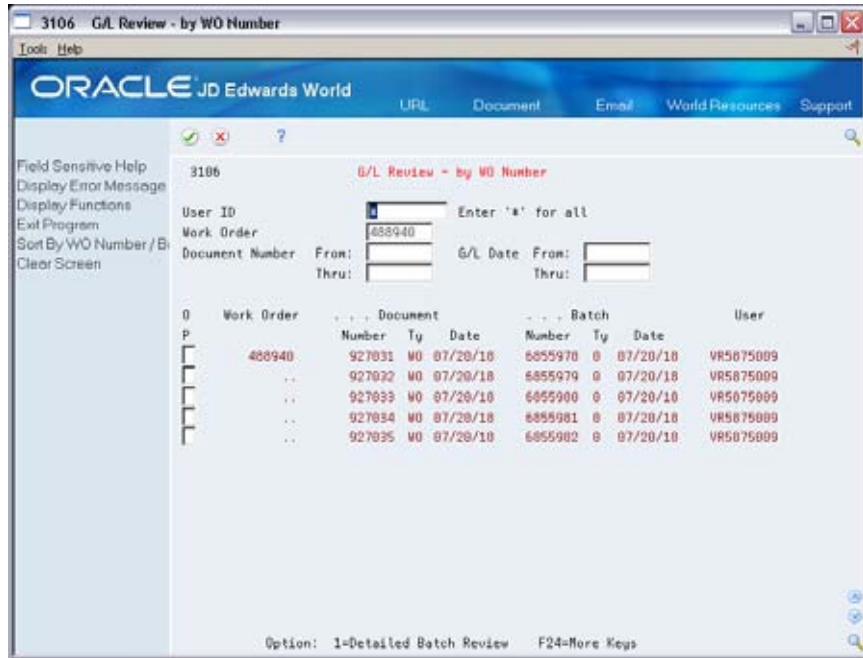

Review General Ledger Batches

Reviewing General Ledger Batches



From Shop Floor Control (G31), choose **Daily Manufacturing Accounting**
From Daily Manufacturing Accounting (G3116), choose **G/L Review**

After you generate journal entries, you review and approve them before posting them to the general ledger. This review is the second step in the JD Edwards World three-tier process.

When you review G/L batches, you can:

- Review all or specific batches
- Review G/L batch detail
- Review the original journal entry document

Each batch of journal entries has one of the following status codes:

- Pending
- Approved
- Error

The status that the system assigns depends on how you set the management approval in the Application Constants (F8 from the Branch/Plant Constants). If a batch has an error status, the system prevents it from posting.

The system updates information in the Batch Control (F0011) and the Account Ledger (F0911) tables.

Note: If you change, void, or add transactions to a posted batch, the system automatically changes the batch status from posted to the default entry status of pending or approved. You must then repost the batch. The post only processes changed transactions.

Before You Begin

- Verify that you have set up your general accounting system properly.
- Set the management approval in the Application Constants constants for approving journal entries for posting. This depends on the workflow and responsibility controls you establish for your organization.

See Also

- *Creating Journal Entries (P31802)*
- *Reviewing Journal Entries (P00201) in the General Accounting I Guide*

To review all or specific G/L batches

When you review all or specific journal entry batches, you can also approve a batch for posting (if allowed), change the status of a batch, or select a particular batch of journal entries to review the batch detail.

On G/L Review

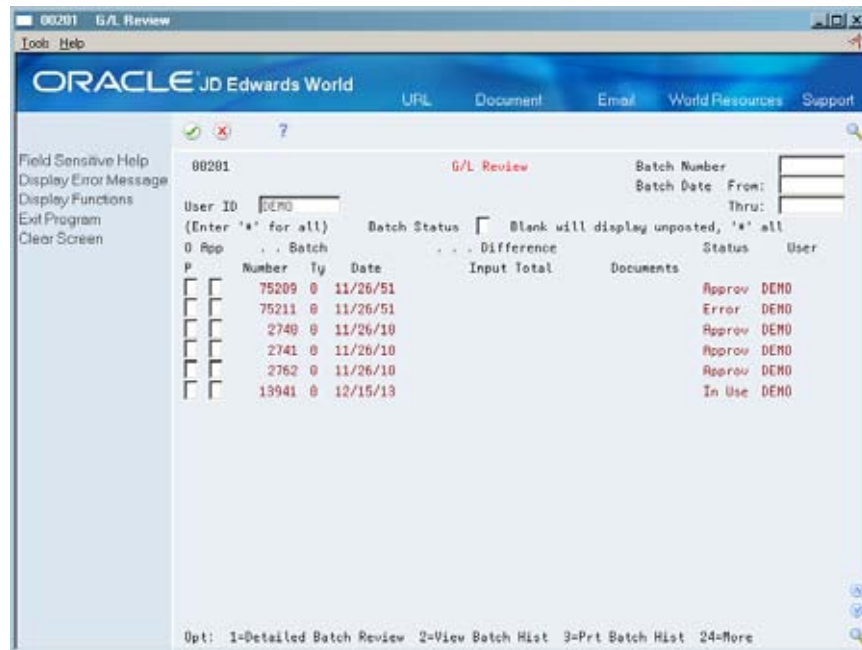

Review the following fields:

- Batch Number
- Batch Date From
- Batch Date Through
- User ID
- Batch Approved for Posting
- Batch Number
- Batch Type
- Batch Date
- Status
- User

Field	Explanation
Batch Number	A number that identifies a group of transactions that the system processes and balances as a unit. When you enter a batch, you can either assign a batch number or let the system assign it through Next Numbers. When you change, locate, or delete a batch, you must specify the batch number.
From:	The date of the batch. If you leave this field blank, the system date is used.
Thru:	The ending date of the range for the batches you want to display. If you specify a From date and leave the Thru date blank, the system displays all batches with that batch date and future batch dates.
User ID	The IBM-defined user profile.
App	A code that indicates whether a batch is ready for posting. Valid codes are: A Approved, ready for posting. P Pending approval. The batch will not post. If the Application Constants (F8 from the Branch/Plant Constants) do not specify manager approval, the system automatically approves batches that are not in error.
Ty	A code that indicates the system and type of entries for a batch. This is a user-defined code (system 98, type IT).
Batch Date	The date for the batch. If this is an entry field and you leave it blank, the system supplies the current date.
Batch Status	A user-defined code (98/IC) that indicates the posting status of a batch. Valid codes are: blank Unposted batches that are pending approval or have a status of approved. A Approved for posting. The batch has no errors, is in balance, but has not yet been posted. D Posted. The batch posted successfully. E Error. The batch is in error. You must correct the batch before it can post. P Posting. The system is posting the batch to the general ledger. The batch is unavailable until the posting process is complete. If errors occur during the post, the batch status is changed to E (error). U In use. The batch is temporarily unavailable because someone is working with it.

To review G/L batch detail

You can review detailed batch header information and general journal entry information (one line per document) for a batch. You can also select a specific journal entry from the batch to review or revise.

On G/L Review

1. Access General Ledger Batch Review (Option 1).

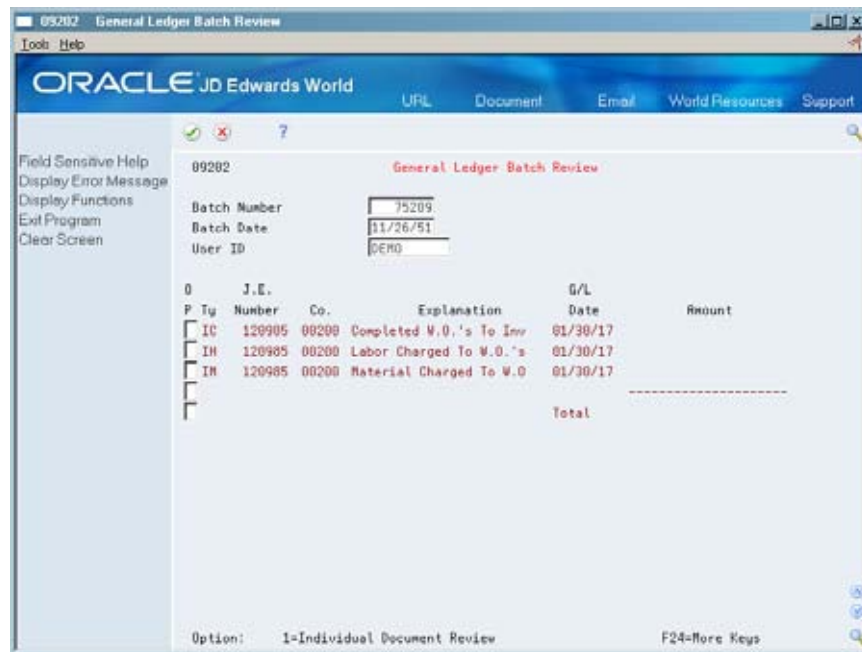

2. On General Ledger Batch Review, review the following fields:

- Mode
- Type
- Journal Entry Number
- Company
- Explanation
- G/L Date
- Amount
- Currency Code

Field	Explanation
Mode(F)	<p>This code indicates whether amounts are in the domestic currency of the company that the accounts are associated with, or in the foreign currency of the transaction. If Detailed Currency Restatement is being used, amounts restated from the domestic currency of the company that the accounts are associated with are shown. Codes are:</p> <p>D Domestic</p> <p>F Foreign</p>
Ty	<p>A user defined code (system 00/type DT) that identifies the origin and purpose of the transaction.</p> <p>JD Edwards World reserves several prefixes for document types, such as vouchers, invoices, receipts, and timesheets. The reserved document type prefixes for codes are:</p> <p>P Accounts payable documents</p> <p>R Accounts receivable documents</p> <p>T Payroll documents</p> <p>I Inventory documents</p> <p>O Order processing documents</p> <p>J General ledger/joint interest billing documents</p> <p>The system creates offsetting entries as appropriate for these document types when you post batches.</p>
Co	<p>A number that, along with document number, document type and G/L date, uniquely identifies an original document, such as invoice, voucher, or journal entry.</p> <p>For World, if you are using the Next Numbers by Company/Fiscal Year feature, the Automatic Next Numbers program (X0010) uses the document company to retrieve the correct next number for that company.</p> <p>If two or more original documents have the same document number and document type, you can use the document company to locate the desired document.</p>
Explanation	A description, remark, explanation, name, or address.
G/L Date	A date that identifies the financial period to which the transaction will be posted. The company constants table for general accounting specifies the date range for each financial period. You can have up to 14 periods. Generally, period 14 is for audit adjustments.
Amount	The gross amount of an invoice or voucher pay item, including tax but not including discounts. The total amount for a voucher or invoice is the accumulation of the open pay items. The accounting distributions must balance to the net amount of a voucher or invoice, not to the gross amount.

Field	Explanation
Cur Cod	A code that indicates the currency of a customer's or a supplier's transactions. <i>Form-specific information</i> This is the currency code of the transaction if the form is displaying foreign amounts (F in the Mode field). It is the currency code of the company if the form is displaying domestic amounts (D in the Mode field).

To review the original journal entry document

You can review the original journal entry document. You can also make changes to the accounting distributions, as well as add a new transaction to an existing batch.

On G/L Review

1. Access General Ledger Batch Review.
2. On General Ledger Batch Review, access Journal Entries (Option 1).

The screenshot shows the 'Journal Entries' form in Oracle JD Edwards World. The form title is '09101 Journal Entries'. The left-hand menu includes options such as 'Field Sensitive Help', 'Display Error Message', 'Display Functions', 'Toggle Display Format', 'Exit Program', 'Full Detail', 'Make a New Model', '% Journal Entry', 'Detailed Restatement E', 'Account Master Additor', 'Exit Out of Balance', 'Account Master Informal', 'Write/View Memo', 'Exit to Model Journal En', and 'Clear Screen'. The main area displays a table of journal entries with the following data:

Account No.	Amount	Explanation 2
R10.1510.R1	16,278,075.20	F0006-GN1
R10.1520.S1	1,939.90	F0006-GN1
R10.1520.S3	1,358.50	F0006-GN1
R10.1520.S4	96.90	F0006-GN1
R10.1535.C2	2,717.00	F0006-GN1
R10.1533.C4	4,075.50	F0006-GN1
R10.1710.R1	16,270,075.20	F0006-GN1
R10.1720.S1	1,939.90	F0006-GN1
R10.1720.S3	1,358.50	F0006-GN1
R10.1720.S4	96.90	F0006-GN1
R10.1730.C2	2,717.00	F0006-GN1
R10.1730.C4	4,075.50	F0006-GN1

At the bottom of the form, there are keyboard shortcuts: F5=Make New Model, F6=% JE, F15=Model JE's, F13=Acct Master, F24=More Keys.

3. On Journal Entries, review the following fields:
 - Account Number
 - Amount
 - Explanation 2
4. Access the detail area (F4).

5. Review the following fields:

- Units
- Subledger
- Type
- G/L Date
- Ledger Type

Field	Explanation
Account No	<p>A field that identifies an account in the general ledger. You can use one of the following formats for account numbers:</p> <ul style="list-style-type: none"> ▪ Standard account number (business unit.object.subsidiary or flexible format) ▪ Third G/L number (maximum of 25 digits) ▪ 8-digit short account ID number ▪ Speed code (not currently available in OneWorld) <p>The first character of the account indicates the format of the account number. You define the account format in the General Accounting Constants program.</p> <p style="text-align: center;"><i>Form-specific information</i></p> <p>Depending on your general accounting constants, you might be able to accept an invalid account number. Insert an & (ampersand) as the first character in front of the invalid account number. For example, &90.1107</p>

Field	Explanation
Amount	<p>A number that identifies the actual amount. Type debits with no sign or a plus sign (+). Type credits with a minus sign (-) either before or after the amount. You can use decimals, dollar signs, and commas. The system ignores non-significant symbols.</p> <p style="text-align: center;"><i>Form-specific information</i></p> <p>For a percent journal entry or a model for percent journal entries, enter the percent to be distributed to the account without a % (percent) sign. For example, enter 25.75 for 25.75%. The system will calculate the amount as a percentage of the amount to distribute.</p> <p>When you use the Journal Entry format with separate debit and credit columns, omit signs. Instead, enter the amount in the appropriate column (debit or credit).</p>
Explanation 2	<p>A name or remark that describes an element in the JD Edwards World systems.</p> <p style="text-align: center;"><i>Form-specific information</i></p> <p>An optional description of the transaction or a remark. Press the key that is set up to act as a duplication key to copy the description from the preceding line.</p>
Units	<p>The quantity of something that is identified by a unit of measure. For example, it can be the number of barrels, boxes, cubic yards, gallons, hours, and so on.</p>
Subledger	<p>A code that identifies a detailed auxiliary account within a general ledger account. A subledger can be an equipment item number, an address book number, and so forth. If you enter a subledger, you must also specify the subledger type.</p>
Type	<p>A user-defined code (00/ST) that is used with the Subledger field to identify the subledger type and subledger editing. On the User Defined Codes form, the second line of the description controls how the system performs editing. This is either hard-coded or user-defined. For example:</p> <ul style="list-style-type: none"> A Alphanumeric field, do not edit N Numeric field, right justify and zero fill C Alphanumeric field, right justify and blank fill
G/L Date	<p>A date that identifies the financial period to which the transaction is to post. The company constants table for general accounting specifies the date range for each financial period. You can have up to 14 periods. Generally, period 14 is for audit adjustments.</p>

Field	Explanation
Ledger Type	A user-defined code (system 09/type LT) that specifies the type of ledger, such as AA (Actual Amount), BA (Budget Amount), or AU (Actual Units). You can set up multiple, concurrent accounting ledgers within the general ledger to establish an audit trail for all transactions. <i>Form-specific information</i> The default ledger type is AA.

Post to the General Ledger

Posting to the General Ledger

Update your account balances with amounts from journal entries by posting the journal entries to the general ledger. After posting, the system provides several reports that you can use to view the journal entries that have been posted.

This section contains the following:

- [Posting Manufacturing Journal Entries](#)
- [Reviewing the Posting Edit Report for Manufacturing](#)
- [Reviewing the Posting Journal Report](#)
- [Reviewing the Item Ledger/Account Integrity Report](#)
- [Reviewing World Writer Reports for Manufacturing Accounting](#)

Posting Manufacturing Journal Entries



From Manufacturing Systems (G3), choose **Manufacturing Accounting**
From Manufacturing Accounting (G3116), choose **Post General Journal**

After you enter, review, and approve journal entries, use Post General Journal to post the journal entries to the general ledger.

You can only run one post at a time. You must ensure that all post menu selections are routed to the same job queue and that the job queue only allows one job to process at a time.

Caution: JD Edwards World strongly recommends that you do not customize the post program.

The post is the third step of the JD Edwards World three-tier process. The post itself consists of two phases, the pre-post process and the post process.

Pre-Post Process

The pre-post process consists of several elements:

Pre-Post Element	Description
Selection	The Post General Journal program selects unposted, approved transactions with a batch type 0 and other criteria specified in the processing options. These transactions come from the Account Ledger table (F0911).
Detail edit	<p>The program edits each transaction to determine whether:</p> <ul style="list-style-type: none"> ▪ The account exists in the Account Master and is a posting account. ▪ The business unit is valid in the Business Unit Master table (F0006). ▪ The G/L date is valid. ▪ Intercompany transactions exist. ▪ Detail currency restatement should be done.
Batch edit	The program edits each batch to ensure that it is approved and in balance. If the program finds any errors, it does not post the batch.
Posting Edit report	This report lists all batch errors that have occurred. It prints in batch sequence.
Error conditions	If any transaction in the batch is in error, the program places the entire batch in error, which prevents it from posting.

Note: You should not make changes to the accounts, automatic accounting instructions (AAIs), intercompany settlements, general accounting constants, or processing options when you run the post.

The following graphic illustrates the pre-post process.

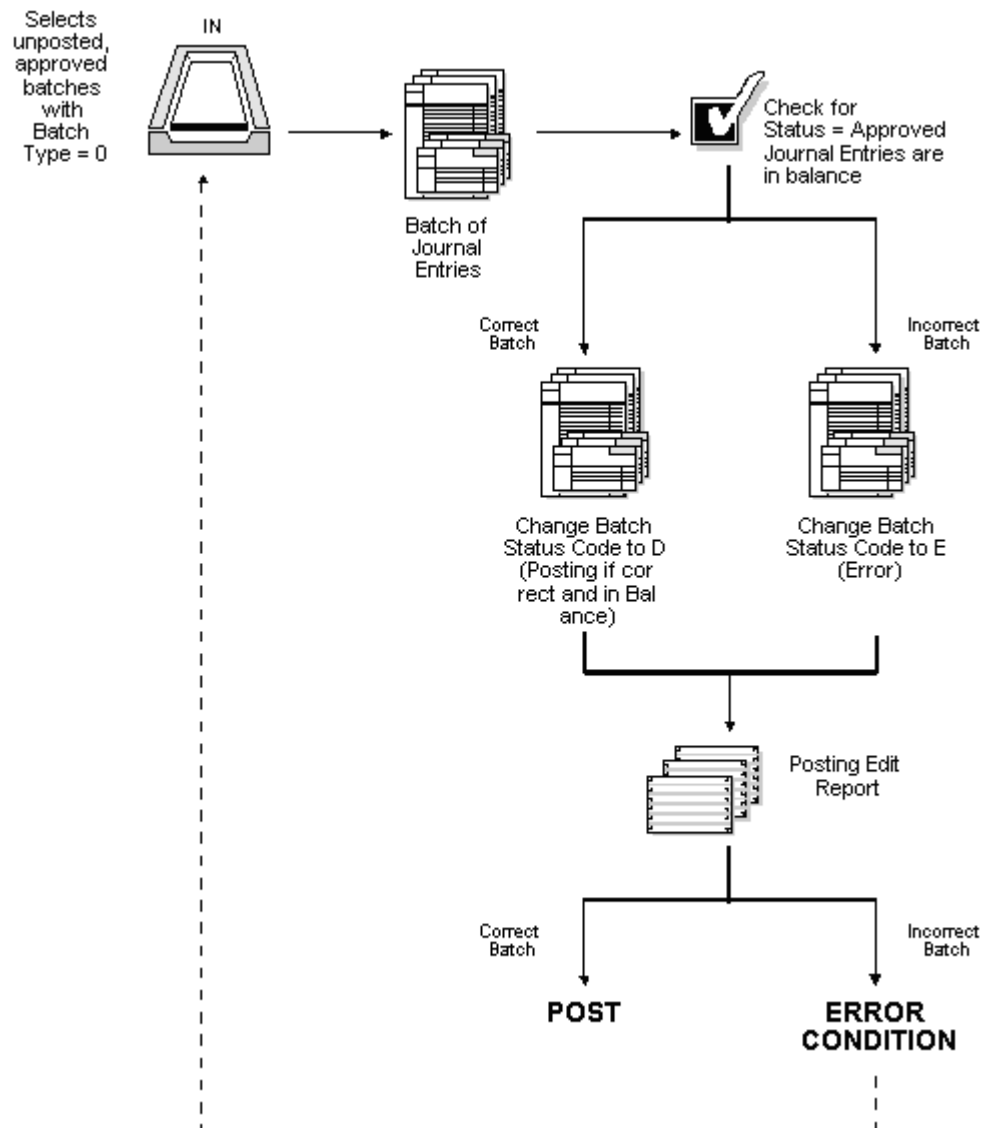

Post Process

The Post General Journal program only posts batches when no errors are found in the pre-post process. In general, the program:

- Posts transactions to the Account Balances table (F0902) and marks each transaction and the batch header as posted in the Account Ledger table and the Batch Control table (F0011)
- Changes the batch status for the Batch Control table to D
- Marks each transaction with a status of P (posted)
- Performs intercompany settlements for ledger types AA (actual amounts), XA, YA, CA, AZ, and ZA (detailed currency restatement amounts), if requested
- Creates reversing entries, if requested

- Generates two reports:
 - Posting Journal report, which lists the transactions posted to the Account Balances and the Account Ledger tables
 - Detailed Post Error report, which lists the detail transactions in a batch if there is a balancing error.

The following graphic illustrates the post process.

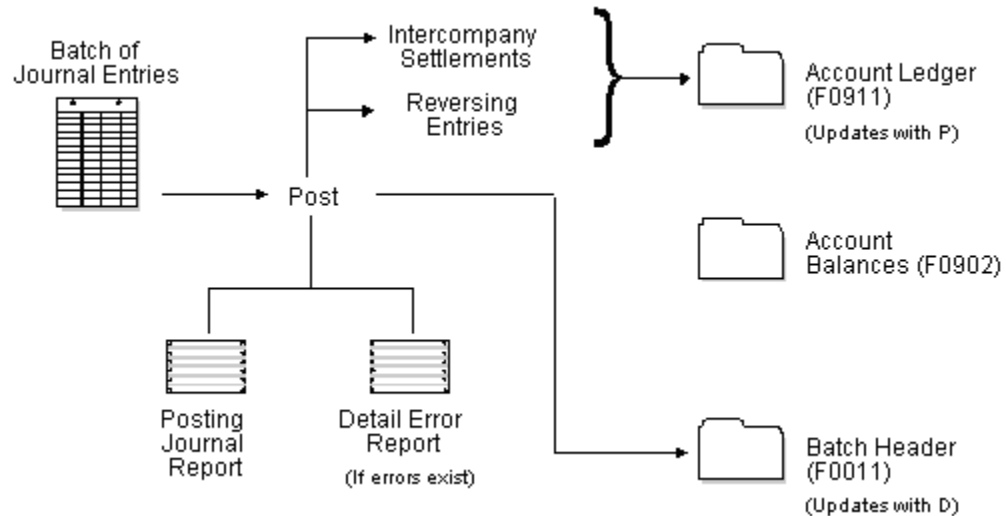

Before You Begin

- Verify that the batch has an approved status. See *Reviewing General Ledger Batches*.
- Verify that the post is submitted to a single-threaded job queue.

See Also

- *Creating Journal Entries (P31802)*
- *Posting Journal Entries (P09800)* in the *General Accounting I Guide*

Processing Options

See [General Ledger Post \(P09800\)](#).

Reviewing the Posting Edit Report for Manufacturing

Each time you run Post General Journal, the program generates the Posting Edit Report. This report lists errors detected during the post. If the program finds errors, it does not post the batch. You must correct all errors in order for the batch to be posted.

09800	JD Edwards World General Ledger Post - General Accounting Posting Edit Report				Page 4 Date 4/24/17	
Create Intercompany Settlements: Y						
Batch Number	Batch Date	Account Number - Input Account ID	G/L Date Subldgr	Do Ty	Document JE Line Number Number	Error Messages
83257	04/24/17					***NO ERRORS*** Batch will post. *

Common Posting Errors

Error	Description
Batch not approved for posting	This error message is caused by a batch with a pending or error status.
Account not set up in Account Master table (F0901)	Two situations can cause this error message: <ul style="list-style-type: none"> An undefined account number (designated as # during journal entry) was entered. To correct this, locate the document number and line number on the Journal Entries form. Change the # on the detail line to the valid account number. An undefined account number was not set up prior to posting, or it does not meet the model account criteria to be automatically created by the system. Add the G/L account number on Accounts by Object.
Batch journal entries out-of-balance	This error message occurs when debits do not equal credits. If the out-of-balance journal entry was entered in error, correct the error and post the batch again. <p>Other situations can cause a journal entry to be out-of-balance. For example:</p> <ul style="list-style-type: none"> A power failure might have occurred during entry or posting. A valid, one-sided journal entry might have been entered to correct a conversion error made during setup. <p>For information about how to enter an out-of-balance transaction, see <i>Correcting Out-of-Balance Batches</i> in the <i>General Accounting II Guide</i>.</p>

Reviewing the Posting Journal Report

Each time you run Post General Journal, the program generates the Posting Journal report during the post process. This report lists the transactions posted to the Account Balances and Account Ledger tables.

09801				JD Edwards World	Page	1		
Batch Type	- G	General Ledger Post - General Accounting			Date	4/24/17		
Batch Number	- 83257							
Batch Date	- 04/24/17							
Posting Journal								
Post Out of Balance :								
Create Intercompany Settlements: Y								
Do Document Ty	G/L Date	Co	Account Description	G/L Account Subldgr-Ty/Asset Number	Amounts		LT	Units
					Debit	Credit		
JE	1522 03/31/17	00100	Miscellaneous Expense Bank Service Charge	USD 90.9250	1,000.00		AA	
JE	1522 03/31/17	00100	Bear Creek National B Bank Service Charge	USD 100.1110.BEAR		1,000.00	AA	
JE	1522 03/31/17	00100	Miscellaneous Expense Bank Service Charge	USD 90.9250		1,000.00	AA	
VOID JOURNAL ENTRY								
JE	1522 03/31/17	00100	Bear Creek National B Bank Service Charge	USD 100.1110.BEAR	1,000.00		AA	
VOID JOURNAL ENTRY								
JE	10418 03/31/17	00001	Other Expense Bank Service Charge	USD 9.9200	1,000.00		AA	
JE	10418 03/31/17	00001	Bear Creek National B Bank Service Charge	USD 1.1110.BEAR		1,000.00	AA	
JE	10418 03/31/17	00100	Miscellaneous Expense Bank Service Charge	USD 90.9250	1,000.00		AA	
JE	10418 03/31/17	00100	Bear Creek National B Bank Service Charge	USD 100.1110.BEAR		1,000.00	AA	
Batch Total					4,000.00	4,000.00	AA	

Reviewing the Item Ledger/Account Integrity Report

	From Inventory Master/Transactions (G4111), choose Inventory Reports From Inventory Reports (G41111), choose Item Ledger/Account Inquiry
---	---

The Item Ledger/Account Integrity report lists discrepancies between the Item Ledger and Account Ledger tables. If the data in the two files is in agreement, no lines print.

The lines that print are summary lines, that is, the amounts on a line represent the total for a specific document type, document number, and key company. No other total lines print. You can run this report as many times as needed because no tables are updated.

If you use summarized journal entries for work orders, the program uses the Work Order Cross-Reference table (F3106) to locate the material issue transactions (IM), completions (IC), and scrap transactions (IS) against those summarized work orders.

The system uses next numbering for the GL doc number rather than using the work order number. The system implements Work Order Cross-Reference (P3106) in order to cross-reference the work order number to the G/L document number. You can review this cross-reference on the Work Order Processing menu (G3116), using the GL Review by WO Number menu (option 22).

Following is a grid of the files and fields that are relevant to manufacturing work order cross-referencing:

File name	File number	Order number	Order Type	Document number	Document type	Batch number
Cardex/Item Ledger	F4111	ILDOCO	ILDCTO	ILDOC	ILDCT	ILICU
		Assigned by Next Numbers. "Document number" in Cardex Detail	Header level transaction type, like WO for work order.	Work order number. "Document" in Cardex detail.	Detail level transaction type, like IM or IC.	G/L batch number.
W.O. Cross Ref	F3106	SDDOCO	SDDCT	SDDOC		SDICU
		Work Order Number		Assigned by Next Numbers.		G/L batch number.
G/L Detail	F0911	GLSBL		GLDOC	GLDCT	GLICU
		Work order number if detail JEs.		Assigned by Next Numbers.		G/L batch number.

If you determine that there is not a true integrity issue between the F4111 and F0911 files, but the report is showing a discrepancy, do the following:

- Determine which number (per the report) is inaccurate by reviewing the related Cardex transaction and journal entry.
- If the Item Ledger (F4111) amount is wrong, check the data selection and sequencing. Try testing with the exact setup from the demo version.
- If the Account Ledger (F0911) amount is wrong, check the UDC table 41/IN and the related AAI table setup.

Before You Begin

- Verify that you have set up exception rules (41/IN).

Document Type/Number		Key Co	Amount		Variance	G/L Date	Error Number	Error Message
			Item Ledger	Account Ledger				
IA	8	100	60,000.00		60,000.00	01/01/16	3036	No existing General Ledger records
IA	9	100	180,000.00		180,000.00	01/01/16	3036	No existing General Ledger records
IA	10	100	33,600.00		33,600.00	01/01/16	3036	No existing General Ledger records
IA	11	100	273,600.00		273,600.00	01/01/16	3036	No existing General Ledger records
IA	12	100	30,000.00		30,000.00	01/01/16	3036	No existing General Ledger records
IA	653	200	2,048,212.61		2,048,212.61	01/30/17	3036	No existing General Ledger records
IA	4144	200	104,938.00-	104,938.00-		06/30/17	3038	Item Ledger and G/L do not balance
IB	1918	50	4,184.83-		4,184.83-	10/13/13	3036	No existing General Ledger records
IB	2240	200	24,394.53	24,394.54	0.01-	11/22/14	3038	Item Ledger and G/L do not balance
IB	2242	200	8,347.96	8,347.97	0.01-	11/22/14	3038	Item Ledger and G/L do not balance
IB	2243	200	22,467.04	22,467.05	0.01-	11/22/14	3038	Item Ledger and G/L do not balance
IB	2247	200	18,592.68	18,592.69	0.01-	11/22/14	3038	Item Ledger and G/L do not balance
IC	109954	200	281,405.45	562,810.90	281,405.45-	12/01/14	3038	Item Ledger and G/L do not balance
IC	109971	200	255,261.97	485,215.94	229,953.97-	12/01/14	3038	Item Ledger and G/L do not balance
IC	109989	200	319,531.34	639,062.68	319,531.34-	12/01/14	3038	Item Ledger and G/L do not balance
IC	109997	200	245,458.17	490,916.34	245,458.17-	12/01/14	3038	Item Ledger and G/L do not balance
IC	110023	200	314,810.99	629,621.98	314,810.99-	12/01/14	3038	Item Ledger and G/L do not balance
IC	110040	200	261,071.63	464,623.26	203,551.63-	12/01/14	3038	Item Ledger and G/L do not balance
IC	110058	200	269,423.02	512,134.04	242,711.02-	12/01/14	3038	Item Ledger and G/L do not balance
IC	110066	200	327,882.73	655,765.46	327,882.73-	12/01/14	3038	Item Ledger and G/L do not balance
IC	110074	200	288,304.42	548,024.84	259,720.42-	12/01/14	3038	Item Ledger and G/L do not balance
IC	110082	200	344,222.40	688,444.80	344,222.40-	12/01/14	3038	Item Ledger and G/L do not balance
IC	110091	200	276,321.99	519,159.98	242,837.99-	12/01/14	3038	Item Ledger and G/L do not balance

See Also

- Printing the Item Ledger/Account Integrity Report (P41543) in the Inventory Management Guide
- *Creating Journal Entries (P31802)* for more information on summarized journal entries

Processing Options

See [Item Ledger/Account Integrity \(P41543\)](#).

Reviewing World Writer Reports for Manufacturing Accounting

	From Master Directory (G), choose World Writer Reporting From World Writer Reporting (G82), choose Manufacturing
---	---

When you access the Manufacturing World Writer menu, locate the World Writer reports for Group Q31.

These reports help you review your production costs and variances. You might want to run them before you run Journal Entries for Variances, or you can run them after Journal Entries for Variances to verify the accuracy of the journal entries.

Complete the following tasks:

- Review Work Order Activity (Amounts)
- Review Work Order Activity (Units)
- Review Engineering Variance
- Review Planned Variance (to Current)
- Review Planned Variance (to Standard)
- Review Material Usage Variances
- Review Efficiency Variances
- Review Total/WIP and Other Variances
- Review Open Work Order Valuation
- Review Completed Work Order Valuation
- Review Work Order Amount Variances
- Review Manufacturing Accounting Tables

Reviewing Work Order Activity (Amounts)

This report lists standard, current, planned, actual, and completed amounts of work orders.

Work Order Activity Amounts							Page	2
Order Number	2nd Item Number	Cost Type	P	Standard Amount	Current Amount	Planned Amount	Actual Amount	Completed Amount
422 333		A1	P	16,178.9200	18,806.9400	19,206.9400	20,826.5230	16,178.9200
422 333		A2	P	525.6000	1,051.2080	1,051.2080		525.6000
422 333		B1	P	37.2800	37.2750	37.2750	55.1200	37.2800
422 333		B2	P		3.1875	3.1875	3.1800	
422 333		B3	P		8.1250	11.3750	11.3700	
422 333		B4	P	8.6700	8.6625	8.6625	12.8625	8.6700
422 333		C1	P		10.1563	14.2188	14.2125	
422 333		C2	P		8.5313	11.9438	11.9385	
422 333		C3	P	27.5600	29.4750	29.4750	42.6975	27.5600
422 333		C4	P	22.9700	24.5626	24.5626	35.5813	22.9700
422 333		D1	P	478.0000	478.0000	478.0000	478.0000	478.0000
422 333		X2	P	85.2600	85.2600	85.2600	85.2600	85.2600
422 333		X3	P	3.3000	3.3000	3.3000	3.3000	3.3000
422 333		X5	P	2.0000	2.0000	2.0000	2.0000	2.0000
422 333		X6	P	1,608.4000	1,608.4000	1,608.4000	1,608.4000	1,608.4000
Parent Child Relationship. . .								
Total				18,977.9600	22,165.0832	22,575.8082	23,190.4453	18,977.9600
490 1007					84.4000			
Parent Child Relationship. . .								
Total					84.4000			

Reviewing Work Order Activity (Units)

This report lists standard, current, planned, actual, and completed units of work orders.

Work Order Activity Units							Page	2
Order Number	2nd Item Number	Cost Type	P	Standard Units	Current Units	Planned Units	Actual Units	Completed Units
422 333		A1	P	100.0000	100.0000	100.0000	100.0000	100.0000
422 333		A2	P	100.0000	100.0000	100.0000		100.0000
422 333		B1	P	100.0000	7.1000	7.1000	10.5000	100.0000
422 333		B2	P	100.0000	.7500	.7500	.7500	
422 333		B3	P	100.0000	2.5000	3.5000	3.5000	
422 333		B4	P	100.0000	7.1000	7.1000	10.5000	100.0000
422 333		C1	P	100.0000	2.5000	3.5000	3.5000	
422 333		C2	P	100.0000	2.5000	3.5000	3.5000	
422 333		C3	P	100.0000	9.5000	9.5000	13.7000	100.0000
422 333		C4	P	100.0000	9.5000	9.5000	13.7000	100.0000
422 333		D1	P	100.0000	100.0000	100.0000	100.0000	100.0000
422 333		X2	P	100.0000	100.0000	100.0000	100.0000	100.0000
422 333		X3	P	100.0000	100.0000	100.0000	100.0000	100.0000
422 333		X5	P	100.0000	100.0000	100.0000	100.0000	100.0000
422 333		X6	P	100.0000	100.0000	100.0000	100.0000	100.0000
Parent Child Relationship. . .								
Total				1,500.0000	741.4500	744.4500	659.6500	1,100.0000
490 1007					2,000.0000			
Parent Child Relationship. . .								
Total					2,000.0000			
490 1001				2,000.0000				
490 1001				2,000.0000	37.1000			
490 1001				2,000.0000	4.0000			
490 1001				2,000.0000	16.0000			
490 1001				2,000.0000	37.1000			
490 1001				2,000.0000	16.0000			
490 1001				2,000.0000	16.0000			
490 1001				2,000.0000	48.1200			
490 1001				2,000.0000	48.1200			
490 3991				2,000.0000	2,000.0000			
490 3991				2,000.0000	2,000.0000			
490 3991				2,000.0000	80.0000			
490 3991				2,000.0000	32.0000			
490 3991				2,000.0000	32.0000			
490 3991				2,000.0000	32.0000			
Parent Child Relationship. . .								
Total				28,000.0000	4,398.4400			

Reviewing Engineering Variance

This report lists work orders, their standard and current amounts, and their engineering variances.

Engineering Variance Amounts						Page	-	1
						Date	-	02/21/17
Order Number	2nd Item Number	Cost Type	P C	Standard Amount	Current Amount	Engineering Variance		
406 5120		B1	P	5,701.8000	5,701.5000	.3000-		
406 5120		B2	P	2,337.6000	11.6875	2,325.9125-		
406 5120		B4	P	1,108.8000	1,108.8000			
406 5120		C3	P	5,488.8000	4,093.1925	1,395.6075-		
406 5120		C4	P	4,573.8000	3,410.9938	1,162.8062-		
Parent Child Relationship. . .								
Total				19,210.8000	14,326.1738	4,884.6262-		
414 333		A1	P	16,178.9200	16,178.9200			
414 333		A2	P	525.6000	525.6040	.0040		
414 333		B1	P	37.2800	37.2750	.0050-		
414 333		B4	P	8.6700	8.6625	.0075-		
414 333		C3	P	27.5600	27.5625	.0025		
414 333		C4	P	22.9700	22.9688	.0012-		
414 333		D1	P	478.0000	478.0000			
414 333		X2	P	85.2600	85.2600			
414 333		X3	P	3.3000	3.3000			
414 333		X5	P	2.0000	2.0000			
414 333		X6	P	1,608.4000	1,608.4000			
Parent Child Relationship. . .								
Total				18,977.9600	18,977.9528	.0072-		
422 333		A1	P	16,178.9200	18,806.9400	2,628.0200		
422 333		A2	P	525.6000	1,051.2080	525.6080		
422 333		B1	P	37.2800	37.2750	.0050-		
422 333		B2	P		3.1875	3.1875		
422 333		B3	P		8.1250	8.1250		
422 333		B4	P	8.6700	8.6625	.0075-		
422 333		C1	P		10.1563	10.1563		
422 333		C2	P		8.5313	8.5313		
422 333		C3	P	27.5600	29.4750	1.9150		
422 333		C4	P	22.9700	24.5626	1.5926		
422 333		D1	P	478.0000	478.0000			
422 333		X2	P	85.2600	85.2600			
422 333		X3	P	3.3000	3.3000			
422 333		X5	P	2.0000	2.0000			
422 333		X6	P	1,608.4000	1,608.4000			
Parent Child Relationship. . .								
Total				18,977.9600	22,165.0832	3,187.1232		

Reviewing Planned Variance (to Current)

This report lists all work orders and their planned variances (current amounts compared to planned amounts). Journal entries for planned variances are calculated in the same way.

Order Number	2nd Item Number	Cost P Type C	Planned Variance Amounts		Planned Variance	Page	1
			Current Amount	Planned Amount		Date	- 02/21/17
422 212		C	5,256.0400	5,256.0400			
422 121		C	2,609.5000	2,609.5000			
422 424		C	5,256.6000	5,256.6000			
422 444		C	5,200.8000	5,200.8000			
422 123		C	400.0000	800.0000	400.0000		
422 122		C	84.0000	84.0000			
Parent Child Relationship. . .							
Total			18,806.9400	19,206.9400	400.0000		
422 333		A1 P	18,806.9400	19,206.9400	400.0000		
422 333		A2 P	1,051.2080	1,051.2080			
422 333		B1 P	37.2750	37.2750			
422 333		B2 P	3.1875	3.1875			
422 333		B3 P	8.1250	11.3750	3.2500		
422 333		B4 P	8.6625	8.6625			
422 333		C1 P	10.1563	14.2188	4.0625		
422 333		C2 P	8.5313	11.9438	3.4125		
422 333		C3 P	29.4750	29.4750			
422 333		C4 P	24.5626	24.5626			
422 333		D1 P	478.0000	478.0000			
422 333		X2 P	85.2600	85.2600			
422 333		X3 P	3.3000	3.3000			
422 333		X5 P	2.0000	2.0000			
422 333		X6 P	1,608.4000	1,608.4000			
Parent Child Relationship. . .							
Total			22,165.0832	22,575.8082	410.7250		
490 1007		C	84.4000		84.4000-		
Parent Child Relationship. . .							
Total			84.4000		84.4000-		
490 1001		B1 P	195.7750		195.7750-		
490 1001		B2 P	24.8000		24.8000-		
490 1001		B3 P	67.6800		67.6800-		
490 1001		B4 P	36.6550		36.6550-		
490 1001		C1 P	54.1440		54.1440-		
490 1001		C2 P	58.8816		58.8816-		
490 1001		C3 P	164.7680		164.7680-		
490 1001		C4 P	143.5150		143.5150-		
490 3991		A1 P	84.4000		84.4000-		
490 3991		B1 P	4.2000		4.2000-		
490 3991		B3 P	1.0400		1.0400-		
490 3991		C1 P	1.3000		1.3000-		
490 3991		C2 P	1.0920		1.0920-		
Parent Child Relationship. . .							
Total			838.2506		838.2506-		

Reviewing Planned Variance (to Standard)

This report lists work orders and their planned variances (standard amounts compared to planned amounts). These variances are informational only. Journal entries are not created from these amounts. Journal entries for planned variances come from comparing current amounts to planned amounts.

				Planned Variance		Page	-	1
				Amounts		Date	-	02/21/17
Order Number	2nd Item Number	Cost Type	P C	Standard Amount	Planned Amount	Planned Variance		
110040	1122	A1	P	2,323.1163	2,323.1163			
110040	1122	A2	P	2,323.1163		2,323.1163-		
110040	1122	B1	P					
110040	1122	B2	P					
110040	1122	B3	P					
110040	1122	B4	P					
110040	1122	C1	P					
110040	1122	C2	P					
110040	1122	C3	P					
110040	1122	C4	P					
Parent Child Relationship. . .								
Total				4,646.2326	2,323.1163	2,323.1163-		
110058	1122	A1	P	2,560.6702	2,560.6702			
110058	1122	A2	P	2,560.6702		2,560.6702-		
110058	1122	B1	P					
110058	1122	B2	P					
110058	1122	B3	P					
110058	1122	B4	P					
110058	1122	C1	P					
110058	1122	C2	P					
110058	1122	C3	P					
110058	1122	C4	P					
Parent Child Relationship. . .								
Total				5,121.3404	2,560.6702	2,560.6702-		
110066	1122	A1	P	3,278.8273	3,278.8273			
110066	1122	A2	P	3,278.8273		3,278.8273-		
110066	1122	B1	P					
110066	1122	B2	P					
110066	1122	B3	P					
110066	1122	B4	P					
110066	1122	C1	P					
110066	1122	C2	P					
110066	1122	C3	P					
110066	1122	C4	P					
Parent Child Relationship. . .								
Total				6,557.6546	3,278.8273	3,278.8273-		

Reviewing Material Usage Variances

This reports lists the planned and actual material (A1) quantities, extended by standard cost, and a total dollar variance for items on your work orders.

Material Usage Variances						Page	-	1
Amounts						Date	-	02/21/17
Order Number	2nd Item Number	Cost P Type C	Planned Amount	Actual Amount	Material Usage Variance			
3390		A1 P						
Parent Child Relationship. . .								
Total								
347	INSPECT FAN BLADES	A1 P						
347	INSPECT FAN BLADES	A2 P						
Parent Child Relationship. . .								
Total								
406	5120	A1 P						
Parent Child Relationship. . .								
Total								
414	333	A1 P						
414	333	A2 P						
Parent Child Relationship. . .								
Total								
422	333	A1 P	19,206.9400	20,826.5230	1,619.5830			
422	333	A2 P	1,051.2080		1,051.2080-			
Parent Child Relationship. . .								
Total						20,258.1480	20,826.5230	568.3750

Reviewing Efficiency Variances

This report shows planned and actual labor hours (all cost components except A1), extended by standard rates, and the dollar amount of variance by work order and item number.

Efficiency Variances						Page	-	1
Amounts						Date	-	02/21/17
Order Number	2nd Item Number	Cost P Type C	Planned Amount	Actual Amount	Efficiency Variance			
422	212	C	5,256.0400	6,307.2480	1,051.2080			
422	121	C	2,609.5000	3,261.8750	652.3750			
422	424	C	5,256.6000	5,256.6000				
422	444	C	5,200.8000	5,200.8000				
422	123	C	800.0000	800.0000				
422	122	C	84.0000		84.0000-			
Parent Child Relationship. . .								
Total						19,206.9400	20,826.5230	1,619.5830
422	333	B1 P	37.2750	55.1200	17.8450			
422	333	B2 P	3.1875	3.1800	.0075-			
422	333	B3 P	11.3750	11.3700	.0050-			
422	333	B4 P	8.6625	12.8625	4.2000			
422	333	C1 P	14.2188	14.2125	.0063-			
422	333	C2 P	11.9438	11.9385	.0053-			
422	333	C3 P	29.4750	42.6975	13.2225			
422	333	C4 P	24.5626	35.5813	11.0187			
422	333	D1 P	478.0000	478.0000				
422	333	X2 P	85.2600	85.2600				
422	333	X3 P	3.3000	3.3000				
422	333	X5 P	2.0000	2.0000				
422	333	X6 P	1,608.4000	1,608.4000				
Parent Child Relationship. . .								
Total						2,317.6602	2,363.9223	46.2621

Reviewing Total/WIP and Other Variances

This report shows the standard, actual, and completed amounts, and total and other variances by cost component and item for your work orders.

Total/WIP and Other Variances Amounts							Page	-	1
							Date	-	02/21/17
Order Number	2nd Item Number	Cost P Type C	Standard Amount	Actual Amount	Completed Amount	Total/WIP Variance	Other Variance		
414 333		A1 P	16,178.9200				16,178.9200		
414 333		A2 P	525.6000				525.6000		
414 333		B1 P	37.2800				37.2800		
414 333		B2 P							
414 333		B3 P							
414 333		B4 P	8.6700				8.6700		
414 333		C1 P							
414 333		C2 P							
414 333		C3 P	27.5600				27.5600		
414 333		C4 P	22.9700				22.9700		
414 333		D1 P	478.0000				478.0000		
414 333		X2 P	85.2600				85.2600		
414 333		X3 P	3.3000				3.3000		
414 333		X5 P	2.0000				2.0000		
414 333		X6 P	1,608.4000				1,608.4000		
Parent Child Relationship . . .									
Total			18,977.9600				18,977.9600		
422 333		A1 P	16,178.9200	20,826.5230	16,178.9200	4,647.6030			
422 333		A2 P	525.6000		525.6000	525.6000-			
422 333		B1 P	37.2800	55.1200	37.2800	17.8400			
422 333		B2 P		3.1800		3.1800			
422 333		B3 P		11.3700		11.3700			
422 333		B4 P	8.6700	12.8625	8.6700	4.1925			
422 333		C1 P		14.2125		14.2125			
422 333		C2 P		11.9385		11.9385			
422 333		C3 P	27.5600	42.6975	27.5600	15.1375			
422 333		C4 P	22.9700	35.5813	22.9700	12.6113			
422 333		D1 P	478.0000	478.0000	478.0000				
422 333		X2 P	85.2600	85.2600	85.2600				
422 333		X3 P	3.3000	3.3000	3.3000				
422 333		X5 P	2.0000	2.0000	2.0000				
422 333		X6 P	1,608.4000	1,608.4000	1,608.4000				
Parent Child Relationship . . .									
Total			18,977.9600	23,190.4453	18,977.9600	4,212.4853			

Reviewing Open Work Order Valuation

This report shows the standard, actual, completed, and outstanding balance of amounts by cost component and item for your open work orders. The program calculates the total for each type of cost by work order and a grand total of each cost for all of the work orders listed.

Open Work Order Valuation for Status Less Than 97							Page	-	1
							Date	-	02/21/17
Order Number	Item Number	Cost P Type C	Standard Amount	Actual Amount	Completed Amount	Balance (Actual-Complete)			
347	INSPECT FAN BLADES	A1 P	.00	.00	.00	.00			
		A2 P	.00	.00	.00	.00			
Order Number									
Total			.00	.00	.00	.00			
698	SHAFT MAINT PM KIT	A1 P	.00	.00	.00	.00			
		A2 P	.00	.00	.00	.00			
Order Number									
Total			.00	.00	.00	.00			
844	200-001	A1 P	19750.49	19750.49	.00	19750.49			
		B1 P	3254.50	.00	.00	.00			
		B3 P	86.60	16.92	.00	16.92			
		C1 P	129.90	13.54	.00	13.54			
		C2 P	69.28	14.72	.00	14.72			
		C3 P	3599.75	.00	.00	.00			
		C4 P	3519.45	.00	.00	.00			
Order Number									
Total			30409.97	19795.67	.00	19795.67			

Reviewing Completed Work Order Valuation

This report shows the standard, actual, completed, and outstanding balance amounts by cost component and item for your completed work orders. The Journal Entries for Work in Process or Completions and Journal Entries for Variances programs have already been run for these work orders. The program calculates the total for each type of cost by work order and a grand total of each cost for all of the work orders listed.

Completed Work Order Valuation for Status Greater Than or Equal To 97							Page	3
							Date	- 02/21/17
Order Number	Item Number	Cost Type	P C	Standard Amount	Actual Amount	Completed Amount	Balance (Actual-Complete)	
112328	12706	A1	P	2.33	2.33	2.33	.00	
		A2	P	.00	.00	.00	.00	
		B1	P	.39	.39	.39	.00	
		B2	P	.19	.00	.19	.19-	
		B3	P	1.41	1.41	1.41	.00	
		B4	P	.08	.08	.08	.00	
		C1	P	1.77	1.77	1.77	.00	
		C2	P	1.48	1.48	1.48	.00	
		C3	P	.40	.28	.40	.12-	
		C4	P	.33	.24	.33	.09-	
Order Number								
Total				8.38	7.99	8.38	.39-	
112344		A1	P	2.33	2.33	2.33	.00	
		A2	P	.00	.00	.00	.00	
		B1	P	.39	.39	.39	.00	
		B2	P	.19	.00	.19	.19-	
		B3	P	1.41	1.41	1.41	.00	
		B4	P	.08	.08	.08	.00	
		C1	P	1.77	1.77	1.77	.00	
		C2	P	1.48	1.48	1.48	.00	
		C3	P	.40	.28	.40	.12-	
		C4	P	.33	.24	.33	.09-	
Order Number								
Total				8.38	7.99	8.38	.39-	
112352		A1	P	2.33	2.33	2.33	.00	
		A2	P	.00	.00	.00	.00	
		B1	P	.39	.39	.39	.00	
		B2	P	.19	.00	.19	.19-	
		B3	P	1.41	1.41	1.41	.00	
		B4	P	.08	.08	.08	.00	
		C1	P	1.77	1.77	1.77	.00	
		C2	P	1.48	1.48	1.48	.00	
		C3	P	.40	.28	.40	.12-	
		C4	P	.33	.24	.33	.09-	
Order Number								
Total				8.38	7.99	8.38	.39-	

Reviewing Work Order Amount Variances

This report shows detailed production costs and variance amounts for your work orders.

Work Order Variances										Page	-	1
Amounts										Date	-	02/21/17
Cost Type	Standard Amount	Current Amount	Engineering Variance	Planned Amount	Planned Variance	Actual Amount	Actual Variance	Other Variances	Total Variance			
A1	16178.92	18806.94	2628.02	19206.94	400.00	20826.52	1619.58	.00	4647.60			
A2	525.60	1051.21	525.61	1051.21	.00	.00	1051.21-	.00	525.60-			
B1	37.28	37.28	.01-	37.28	.00	55.12	17.85	.00	17.84			
B2	.00	3.19	3.19	3.19	.00	3.18	.01-	.00	3.18			
B3	.00	8.13	8.13	11.38	3.25	11.37	.01-	.00	11.37			
B4	8.67	8.66	.01-	8.66	.00	12.86	4.20	.00	4.19			
C1	.00	10.16	10.16	14.22	4.06	14.21	.01-	.00	14.21			
C2	.00	8.53	8.53	11.94	3.41	11.94	.01-	.00	11.94			
C3	27.56	29.48	1.92	29.48	.00	42.70	13.22	.00	15.14			
C4	22.97	24.56	1.59	24.56	.00	35.58	11.02	.00	12.61			
D1	478.00	478.00	.00	478.00	.00	478.00	.00	.00	.00			
X2	85.26	85.26	.00	85.26	.00	85.26	.00	.00	.00			
X3	3.30	3.30	.00	3.30	.00	3.30	.00	.00	.00			
X5	2.00	2.00	.00	2.00	.00	2.00	.00	.00	.00			
X6	1608.40	1608.40	.00	1608.40	.00	1608.40	.00	.00	.00			
Order Totals												
Total	18977.96	22165.08	3187.12	22575.81	410.73	23190.45	614.64	.00	4212.49			
Order Totals												
A1	19750.49	975049.00	955298.51	19750.49	955298.51-	19750.49	.00	19750.49	19750.49			
B1	3254.50	3254.50	.00	3254.50	.00	.00	3254.50-	3254.50	.00			
B3	86.60	86.60	.00	42.30	44.30-	16.92	25.38-	86.60	16.92			
C1	129.90	129.90	.00	33.84	96.06-	13.54	20.30-	129.90	13.54			
C2	69.28	69.28	.00	36.80	32.48-	14.72	22.08-	69.28	14.72			
C3	3599.75	3599.75	.00	3608.00	8.25	.00	3608.00-	3599.75	.00			
C4	3519.45	3519.45	.00	3526.38	6.93	.00	3526.38-	3519.45	.00			
Order Totals												
Total	30409.97	1985708.48	1955298.51	30252.31	1955456.17-	19795.67	10456.64-	30409.97	19795.67			

Reviewing Manufacturing Accounting Tables

This report lists the manufacturing AAs used by your companies.

Manufacturing Accounting Tables										Page	-	4
										Date	-	02/21/17
M Co	G/L	Do	Description	V Cost	Description	Cost	Obj	Sub				
C	Cat	Ty		T Type		Center	Acct					
3	0	IN20	IC Completed W.O.'s To Inventory	A1	Material		48 1510	A1				
		IN20	IC	A2	Scrap		48 1510	A2				
		IN20	IC	B1	Direct Labor		48 1520	B1				
		IN20	IC	B2	Setup Labor		48 1520	B2				
		IN20	IC	B3	Machine Run		48 1520	B3				
		IN20	IC	B4	Labor Efficiency		48 1520	B4				
		IN20	IC	C1	Machine Variable Overhead		48 1535	C1				
		IN20	IC	C2	Machine Fixed Overhead		48 1535	C2				
		IN20	IC	C3	Labor Variable Overhead		48 1533	C3				
		IN20	IC	C4	Labor Fixed Overhead		48 1533	C4				
		IN20	IC	D1	Outside Operation		48 1510	D1				
		IN20	IC	X1	Taxes and Duty		48 1540	X				
		IN20	IC	X2	Electricity		48 1540	X				
		IN20	IC	X3	Freight Out		48 1540	X				
		IN20	IC	X4	Royalties		48 1540	X				
		IN20	IC	X5	R&D		48 1540	X5				
		IN20	IC	X6	Warehouse Charge		48 1540	X				
		IN20	IC	X7	Cooling Unit		48 1540	X				
		IN20	IS Scrapped W.O.'s To Inventory	A1	Material		48 1511	A1				

5 Manufacturing Accounting in ERPx Environments

Overview to Manufacturing Accounting in ERPx Environments

Objectives

- To understand what happens when completions are reported against co- and by-products

About Manufacturing Accounting in ERPx Environments

If you use the Manufacturing Accounting system in any special environment (using rate schedules or processes), there are differences in how the system calculates variances and creates journal entries. Actual cost is not supported for Process or Repetitive manufacturing.

Understanding manufacturing accounting in ERPx environments requires the following:

- Understanding process industry accounting

Understand Process Industry Accounting

About Process Industry Accounting

The main difference between discrete manufacturing accounting and process manufacturing accounting is that with a process, completions are reported against the co- and by-products themselves and not against the parent process. You can set a processing option to allow completions of unplanned co- and by-products. Variances are still reported against the process.

About Unaccounted Units in Process Industry Accounting

Unaccounted units represent the quantities and dollar amounts of transactions that occur against a work order when you issue parts, or record labor or completions. You cannot view unaccounted units. They are stored by the system until you run the Journal Entries for Work in Process or Completions program. This program creates journal entries for the unaccounted units and then purges the unaccounted units.

In the process industry, unaccounted units are stored in the same tables as in the discrete industry. Unaccounted units are stored in the following tables:

Table	Description
Work Order Master (F4801)	When you complete a work order or record scrap against a work order, unaccounted units are stored in the Work Order Master table.
Parts List (F3111)	When you issue material to a work order, unaccounted units are stored in the Parts List table.
Routing Instructions (F3112)	When you record hours against a work order, unaccounted units are stored in the Routing Instructions table.

About Calculated Amounts in Process Industry Accounting

Variance Inquiry can display small engineering variances because the frozen amounts differ slightly from the current amounts. However, Journal Entries for Variances rounds the amounts, and no variances print on the report.

Amounts are calculated in the process industry as follows:

Amount	Description
Frozen amounts	Frozen amounts are based on the cost of the process, from the Cost Components table (F30026).

Amount	Description
Actual amounts	The actual costs of the ingredients issued are added to calculate the actual A1 cost of the process.
Completed amounts	For each cost component, the completed costs of the co- and by-products are added to calculate the completed cost of the process for that cost component. For example, the completed B1 cost of all co- and by-products are added. Their sum is the completed B1 cost of the process.

6 Processing Options

Product Costing Processing Options

Item Cost Level Conversion - Final (P41815)

Processing Option	Processing Options Requiring Further Description
<p>PROCESS CONTROL:</p> <ol style="list-style-type: none"> 1. Enter the cost level to update to. 2. If updating to cost level '1', enter the branch to default the costs from. If updating from a cost level '3', the costs will default from the primary location. 3. Enter a '1' to run in final mode and update files. If blank, no file updates will occur. 	
<ol style="list-style-type: none"> 4. Enter a '1' to print only exceptions on the edit report. A blank will print all items. 	

Item Cost Revisions (P4105)

Processing Option	Processing Options Requiring Further Description
<p>DISPLAY CONTROL:</p> <ol style="list-style-type: none"> 1. Enter a '1' for Speed Cost Update. If left blank, the screen will default to Item Cost Revisions. 	
<p>DEFAULT VALUES:</p> <ol style="list-style-type: none"> 2. Enter the default cost method to display when the Speed Cost Update format is selected. 	
<p>PROCESS CONTROL:</p>	

Processing Option	Processing Options Requiring Further Description
<p>3. Enter a '1' to prevent the standard cost from being changed.</p> <p>4. Enter a '1' to write Subledger Information based on Item Number, into Journal Entries. If left blank, no Subledger Information will be written in Journal Entries</p> <p>5. Enter '1' to use 15 character lot, leave blank to default to 12 characters.</p>	

Costing Exceptions (P30801)

Processing Option	Processing Options Requiring Further Description
<p>ERROR MESSAGES:</p> <p>1. Enter the minimum message level to appear on the report. Error messages are defined in the Vocabulary Overrides file (F0020).</p> <p>2. Enter the Cost Method to base costing errors on. If left blank, '07' will be used.</p>	

Cost Simulation (P30820)

Processing Option	Processing Options Requiring Further Description
<p>DATE EFFECTIVITY:</p> <p>1. Enter the As Of Date. If left blank, the system date will be used.</p>	<p>This relates to the As Of date on the BOM and Routing. It can be utilized to simulate costs for items in the future.</p>
<p>COST ROLLUP MODE:</p> <p>2. Enter the Cost Method to use for the roll up. If left blank, '07' will be used.</p>	<p>This is the OUTPUT. This is the cost method you want simulated.</p>

Processing Option	Processing Options Requiring Further Description
3. Enter a '1' to simulate only the items selected and not explode the bill of material.	Works in conjunction with processing option 6 and 7. If this is a 1, then 6 and 7 are input from P30026. If this is a blank, then 6 and 7 are input from P4105.
COST SIMULATION PRINT INFORMATION:	
4. Enter one of the following: 1 = Print all items 2 = Print changed items If left blank, no report will be printed.	
ROUTING CALCULATION INFORMATION:	
5. Enter one of the following: 1 = Clear and recalculate labor and overhead for manufactured items only 2 = Clear and recalculate labor and overhead for all items 3 = Clear Labor and Overhead for all items, but recalculate labor and overhead for manufactured items only If left blank, labor and overhead will not be recalculated.	
SUBCONTRACTED ITEMS:	
6. Enter the Cost Method to move from the Cost Ledger file (F4105) to the Cost Components file (F30026). If left blank, no cost will be moved.	The file read is dependent on the value in processing option 3.
PURCHASED ITEMS:	
7. Enter the Cost Method to move from the Cost Ledger file (F4105) to the Cost Components file (F30026). If left blank, no cost will be moved.	The file read is dependent on the value in processing option 3.
PROCESS MANUFACTURING:	
8. Enter a '1' to calculate costs of Co/By-Products.	
DEFAULT DISPLAY DECIMALS:	
9. Enter the number of decimals to use for display (0-4) in the Cost Simulation report (P30825). If left blank, 4 decimals will be used.	
CO/BY PRODUCT RECALCULATION:	

Processing Option	Processing Options Requiring Further Description
10. Enter a '1' to indicate that the costs of Co/By Products used as Ingredients/Components should not be cleared and recalculated.	

Item Cost Components (P30026)

Processing Option	Processing Options Requiring Further Description
<p>COST TYPES:</p> <p>1. Enter a '1' to allow input into the Calculated Cost Types for routings (B1-B4 and C1-C4).</p>	
<p>SUBCONTRACT PURCHASE ORDERS:</p> <p>2. Enter the cost method to be used for subcontracted items *OPxx (i.e., 01, 02, 03). If left blank, parent item's method will be used.</p>	
<p>DEFAULT DECIMALS:</p> <p>3. Enter the number of decimals to use for display (0-4). If left blank, 4 decimals will be used.</p>	
<p>AS OF DATE:</p> <p>4. Enter the As of Date for which Operation sequences will be picked up from Routing (F3003) for Cost Type Calculations Detail Window. If left blank, this will default to today's System Date.</p>	

Costed Bill of Material Inquiry (P30206)

Processing Option	Processing Options Requiring Further Description
DEFAULT VALUES:	

Processing Option	Processing Options Requiring Further Description
<p>1. Enter the number of decimals to use for display (0-4). If left blank, 4 decimals will be used.</p> <p>2. Enter a '1' to show Calculated totals as default. If left blank, Standard totals will be shown.</p> <p>3. Enter a '1' to base fixed costs on the requested quantity. If left blank, fixed costs will be based on the Accounting cost quantity.</p>	

Costed Routing Inquiry (P30208)

Processing Option	Processing Options Requiring Further Description
<p>SUBCONTRACT PURCHASE ORDERS:</p> <p>1. Enter the cost method to be used for subcontracted items. If left blank, '01' will be used.</p>	
<p>PURCHASED ITEMS:</p> <p>2. Enter the cost method to be used for purchased items. If left blank, '07' will be used.</p>	
<p>OPERATION SEQUENCE DISPLAY:</p> <p>3. Enter a '1' to display the costs up to and including the operation sequence entered in the 'Skip To' field. If left blank, the costs will be displayed beginning with the entered operation's costs.</p>	
<p>TOTALING OPTIONS:</p> <p>4. Enter a '1' to include cost buckets 1 and 2 in the total. If left blank, the total will only include cost buckets 3-6.</p>	
<p>COSTED RESOURCES/CO/BY-PRODUCTS:</p>	

Processing Option	Processing Options Requiring Further Description
<p>5. Enter the number of decimals to display (0-4) in the Costed Resources/Co/By-Products window.</p> <p>If left blank, 4 decimals will be used.</p>	

Item Cost Update (P30835)

Processing Option	Processing Options Requiring Further Description
<p>PROCESSING CONTROL:</p> <p>1. Enter a '1' to update costs.</p> <p>If left blank, Proof mode is assumed and costs will not be updated.</p> <p>2. Enter the Cost Method to update in the Cost Components and Item Cost Ledger files.</p> <p>If left blank, '07' will be used.</p> <p>3. Enter a '1' to simulate only the items selected and not explode the bill of material.</p> <p>4. Enter a '1' to update the Work Center Rates in the Work Center Rates file.</p> <p>If left blank, rates will not be updated.</p>	<p>This is the OUTPUT. This is the cost method that will be updated in final mode.</p> <p>If this is set to 1, only the items in the data selection will update. If blank, then all items on all levels of the Bill of material will be updated.</p>
<p>PROCESS MANUFACTURING:</p> <p>5. Enter a '1' to update costs of Co/By-Products.</p>	
<p>ACCOUNT LEDGER INFORMATION:</p> <p>6. Enter one of the following:</p> <p>1 = Write Detailed G/L transactions (by Item)</p> <p>2 = Write Summarized G/L transactions (by Account).</p> <p>If left blank, no G/L transactions will be written.</p> <p>7. Enter the General Ledger Date.</p> <p>If left blank, the system date will be used.</p>	

Processing Option	Processing Options Requiring Further Description
<p>REPORT FORMAT:</p> <p>8. Enter one of the following:</p> <p> 1 = Print all items</p> <p> 2 = Print changed items</p> <p> If left blank, all items will be printed.</p>	
<p>WIP RE-VALUATION:</p> <p>9. Enter a '1' to adjust WIP according to new costs.</p> <p>10. Enter the document type.</p> <p> If left blank, 'IB' will be used.</p> <p>11. Enter one of the following:</p> <p> 1 = Write Detailed G/L transactions (by document)</p> <p> 2 = Write Summarized G/L transactions (by Account).</p> <p> If left blank, no G/L transactions will be written.</p> <p>12. Enter a '1' to move the Production Document Number into the Sub-Ledger field.</p>	<p>This cannot be set to 1 if processing option 11 is set to 2.</p>
<p>DEFAULT DISPLAY DECIMALS:</p> <p>13. Enter the number of decimals to use for display (0-4) in the Item Cost Rollup Report(P30835).</p> <p> If left blank, 4 decimals will be used.</p>	

Item Ledger - Costs (P4111)

Processing Option	Processing Options Requiring Further Description
<p>DISPLAY OPTIONS:</p>	

Processing Option	Processing Options Requiring Further Description
<p>1. Enter the format to be displayed:</p> <p>1 = Running Quantity Balance format.</p> <p>2 = Running Dollar Balance format.</p> <p>3 = Cost Item Ledger format.</p> <p>4 = Location Item Ledger format.</p> <p>5 = Lot Status/Grade/Potency Item Ledger format.</p> <p>If left blank, the Cost Item Ledger format will be displayed.</p>	
<p>DEFAULT VALUES:</p> <p>2. Enter the default document type upon entering the video.</p> <p>If left blank, a '*' will default for all document types.</p> <p>3. Enter a '1' to display Item Ledger entries in ascending date and time order.</p> <p>If left blank, the entries will be displayed in descending date and time order.</p> <p>(This option does NOT apply to Running Balance formats.)</p> <p>4. Enter a '1' to search by Original Document Type.</p> <p>If left blank, the search will be done by G/L Document Type.</p>	
<p>DREAM WRITER VERSIONS:</p> <p>Enter a DREAM Writer Version for the following programs.</p> <p>(ZJDE0001) is the default.</p> <p>5. Load & Delivery Ledger Inq P49511</p>	

Costed Bill (P30440)

Processing Option	Processing Options Requiring Further Description
<p>BILL EFFECTIVITY:</p> <p>1. Enter the As Of Date for the bill of material.</p> <p>If left blank, the system date will be used.</p>	

Processing Option	Processing Options Requiring Further Description
<p>COSTING OPTIONS:</p> <p>2. Enter the Cost Method to use. If left blank, '07' will be used.</p> <p>3. Enter the costs to be printed. 1 = Simulated 2 = Frozen</p> <p>4. Enter the number of units to cost (e.g., 10000).</p> <p>5. Enter a '1' to base fixed costs on the requested quantity. If left blank, fixed costs will be based on the Accounting cost quantity.</p>	
<p>AMOUNT DECIMAL POSITIONS:</p> <p>6. Enter a '1' to display 2 decimal positions in the amount fields. If left blank, 4 decimal positions will be displayed in the amount fields.</p>	

Multi-Level Costed Bill (P30445)

Processing Option	Processing Options Requiring Further Description
<p>BILL EFFECTIVITY:</p> <p>1. Enter the As Of Date for the bill of material. If left blank, the system date will be used.</p>	
<p>COSTING OPTIONS:</p> <p>2. Enter the Cost Method to use. If left blank, '07' will be used.</p> <p>3. Enter the costs to be printed. 1 = Simulated 2 = Frozen</p> <p>4. Enter the number of units to cost (e.g., 10000).</p>	
<p>PRINT FORMAT:</p>	

Processing Option	Processing Options Requiring Further Description
5. Enter a '1' to print an indented bill of material. 6. Enter a '1' to print a Unit Cost line of detail. If left blank, only one line of detail will be printed for each item.	

Cost Components (P30026P)

Processing Option	Processing Options Requiring Further Description
REPORT FORMAT: 1. Enter the Cost to print: 1 - Simulated Cost 2 - Frozen Cost	

Cost Component/Ledger Integrity (P30543)

Processing Option	Processing Options Requiring Further Description
REPORT FORMAT: 1. Enter a '1' to see report detail for all items processed. If left blank, only items with cost discrepancies will be printed.	

Copy Component Cost Values (P30890)

Processing Option	Processing Options Requiring Further Description
COPY FROM INFORMATION: 1. Branch/Plant (Required) 2. Cost Method (Required)	

Processing Option	Processing Options Requiring Further Description
3. Select the Costs to be copied: 1 = Simulated 2 = Frozen	
COPY TO INFORMATION: 4. Branch/Plant (Required) 5. Cost Method (Required)	

Cost Simulation Reset (P30850)

Processing Option	Processing Options Requiring Further Description
PROCESSING CONTROL: 1. Enter the Branch/Plant to be processed or '*' to process all Branch/Plants. 2. Enter a '1' to reset rates for Cost Centers for the selected Cost Method(s).	

Update Sales Cost, Price, or Exchange Rate (P42950)

Processing Option	Processing Options Requiring Further Description
UPDATE OPTIONS: 1. Enter '1' to update Sales Order with the most current unit cost. If left blank, will not update cost. 2. Enter '1' to update the currency exchange rate. Please note that only the domestic amounts will be re-calculated, the foreign amounts will remain the same. If left blank the currency exchange rate will remain the same. 3. Enter '1' to update the inter-company currency exchange rate. Foreign amounts will not be re-calculated. If left blank, will not update the inter-company exchange rate.	

Processing Option	Processing Options Requiring Further Description
<p>UPDATE PRICE OPTIONS:</p> <ol style="list-style-type: none"> 4. Enter '1' to recalculate the unit price of the sales order. If left blank, the unit price will remain the same. 5. Enter '1' to recalculate the Transfer Price for inter-branch sales. The pricing method specified when the order was entered will be used. 6. Specify the date on which all base price and advanced price adjustment recalculations will be based: <ul style="list-style-type: none"> ' ' - Transaction/Order Date '1' - Requested Ship Date '2' - Promised Ship Date '3' - Original Promised Date '4' - Actual Ship Date '5' - System Date '6' - Invoice Date '*' - Use System Constants value 'P' - Use Based-on Date Preference <p>NOTE: Processing options 7 thru 9 are supported only by the Advanced Price Adjustment Module (45).</p> 7. Enter the Line Type of the new sales detail line item. This line item will contain the difference between the old sales price and the newly recalculated price. If left blank, will update the new price directly to the item. This must be a non-inventory Line Type. 8. If you have specified in the last processing option to create a sales detail record to record the price difference, enter the override next status of the detail line. If left blank, will use the original detail line's next status. 9. Enter '1' to base recalculation on the original order quantity. If left blank, the system will recalculate based on the current quantities of the order. 	

Item Cost Revisions (P4105)

Processing Option	Processing Options Requiring Further Description
<p>DISPLAY CONTROL:</p> <ol style="list-style-type: none"> 1. Enter a '1' for Speed Cost Update. If left blank, the screen will default to Item Cost Revisions. 	
<p>DEFAULT VALUES:</p> <ol style="list-style-type: none"> 2. Enter the default cost method to display when the Speed Cost Update format is selected. 	
<p>PROCESS CONTROL:</p> <ol style="list-style-type: none"> 3. Enter a '1' to prevent the standard cost from being changed. 4. Enter a '1' to write Subledger Information based on Item Number, into Journal Entries. If left blank, no Subledger Information will be written in Journal Entries 5. Enter '1' to use 15 character lot, leave blank to default to 12 characters. 	

Product Costing in ERPx Environments

Processing Options

Costed Routing Inquiry (P30208)

Processing Option	Processing Options Requiring Further Description
<p>SUBCONTRACT PURCHASE ORDERS:</p> <p>1. Enter the cost method to be used for subcontracted items. If left blank, '01' will be used.</p>	
<p>PURCHASED ITEMS:</p> <p>2. Enter the cost method to be used for purchased items. If left blank, '07' will be used.</p>	
<p>OPERATION SEQUENCE DISPLAY:</p> <p>3. Enter a '1' to display the costs up to and including the operation sequence entered in the 'Skip To' field. If left blank, the costs will be displayed beginning with the entered operation's costs.</p>	
<p>TOTALING OPTIONS:</p> <p>4. Enter a '1' to include cost buckets 1 and 2 in the total. If left blank, the total will only include cost buckets 3-6.</p>	
<p>COSTED RESOURCES/CO/BY-PRODUCTS:</p> <p>5. Enter the number of decimals to display (0-4) in the Costed Resources/Co/By-Products window. If left blank, 4 decimals will be used.</p>	

Manufacturing Accounting Processing Options

AAI Revisions (P40901)

Processing Option	Processing Options Requiring Further Description
DEFAULT INFORMATION: 1. Enter the default skip to AAI Number:	

Generate and Print Work Orders (P31410)

Processing Option	Processing Options Requiring Further Description
GENERATION INFORMATION: 1A. Enter one of the following: 1 = Parts List only 2 = Routing only 3 = Both Parts List and Routing If left blank, neither parts list nor routing will be generated. 1B. Enter a '1' to prevent the update of existing parts list and routing instructions. Commitment and substitute processing of parts lists will occur as usual. If left blank, existing parts list and/or routing will be rewritten. 2. Enter a '1' to use the W.O. Date for effectivity checking. If left blank, the W.O. Start Date is used.	<p>Note: If using Backflush to Work Center location in Manufacturing Constants, then routings must be attached first for commitments to be made correctly.</p> <p>Note: If transactions have occurred against the order the parts list and routing should be protected from update.</p>
UPDATE INFORMATION:	

Processing Option	Processing Options Requiring Further Description
<p>3. Enter the new Status Code for the work order/rate header. If left blank, status will not be changed.</p>	
<p>WORK ORDER PRINT INFORMATION:</p> <p>4. Enter a '1' to print work orders. If printing work orders:</p>	
<p>PARTS LIST PRINT INFORMATION:</p> <p>5. Enter a '1' to print Parts List</p> <p>6. Enter a '1' to print the 2nd line of information, which is scrap and related work center.</p> <p>7. Enter a '1' to print Parts List on a new page.</p> <p>8. Enter the version of the Parts List program (P31415). If left blank, 'ZJDE0001' will be used.</p> <p>9. Enter a '1' to print a consolidated Parts List.</p>	
<p>ROUTING PRINT INFORMATION:</p> <p>10. Enter a '1' to print the Routing.</p> <p>11. Enter a '1' to print Routing on a new page.</p> <p>12. Enter the version of the Routing Instructions program (P314151). If left blank, the operation sequence is used.</p>	
<p>BACKSCHEDULING INFORMATION:</p> <p>13. Enter the Unit of Measure for backscheduling.</p>	<p>Note: Hours is the standard unit of measure for backscheduling. If this option is left blank, backscheduling will not calculate correctly.</p>
<p>SHOP PACKET SUMMARY INFORMATION:</p> <p>14. Enter a '1' to print the Shop Packet Summary.</p>	
<p>SHORTAGE REPORT INFORMATION:</p> <p>15. Enter the version of the Shortage Report program (P31418). If left blank, no shortage report will be printed.</p>	

Processing Option	Processing Options Requiring Further Description
<p>BAR CODE INFORMATION:</p> <p>16. Enter the version of the Bar Code Print program (P31413) for the desired print overrides.</p>	
<p>INVENTORY ISSUE INFORMATION:</p> <p>17. Enter the version of Batch Inventory Issues program (P31420). If left blank, Inventory Issues will not be called.</p>	
<p>PURCHASE ORDER INFORMATION:</p> <p>18. Enter the version of Write Purchase Orders program (P3420). If left blank, 'ZJDE0002' will be used.</p>	
<p>SALES ORDER INFORMATION:</p> <p>19. Enter the new Line Type for kit and configured components. This is used to avoid issuing inventory from Sales Order processing. The Line Type used should be inventory interface 'N'. If left blank, Line Type will not be changed.</p> <p>20. Enter the Next Status for Sales Order kit and configured component lines. (This is used to bypass the normal flow of the order, i.e., Pick Slip.) If left blank, next status will not be changed.</p> <p>21. Enter a '1' to delete the existing Work Order Text and copy the Sales Order Text to the Work Order. Enter a '2' to append the Sales Order Text to the end of the existing Work Order Text. If left blank (default) the Work Order Text will not be updated.</p>	
<p>CONFIGURED ITEM COSTS:</p>	

Processing Option	Processing Options Requiring Further Description
<p>22. Enter one of the following options for calculating the standard cost for configured items in the Work Order Variance file (F3102).</p> <p>1 = Always calculate the standard cost</p> <p>2 = Only calculate the standard cost if it has not already done (no variance records exist)</p> <p>If left blank, standard cost will not be calculated.</p>	
<p>BOM SUBSTITUTES:</p> <p>23. Enter '1' to allow the use of Bill of Material substitutes in case of a shortage.</p>	
<p>PURCHASING JOURNAL ENTRIES:</p> <p>24. Enter a '1' to load the Work Order Number into the Subledger field of the purchasing J/E's.</p>	
<p>BLANKET/QUOTE PROCESSING:</p> <p>25. Enter a '1' for automatic blanket order release processing.</p>	
<p>BUILD AGAINST PRIOR REVISIONS:</p> <p>26. Enter a '1' to permit building work orders against prior revision levels. The revision level in the work order header (F4801) will be used to select the parts list to attach to the work order.</p> <p>If left blank, prior revision level bills will not be selected.</p>	
<p>WAREHOUSE PROCESSING:</p> <p>27. Enter the request processing mode:</p> <p>1 = Generate requests only</p> <p>2 = Generate requests and process using the subsystem.</p> <p>If left blank, requests will not be generated.</p> <p>28. If processing pick requests using the subsystem, enter the version of Process Pick Requests (P46171) to call.</p> <p>If left blank, 'XJDE0002' will be used.</p> <p>29. Enter the default staging location for moving goods out of the warehouse.</p>	

Processing Option	Processing Options Requiring Further Description
<p>30. Enter a '1' if the default staging location should be checked for availability. If the part is available at the staging location a request will NOT be generated.</p> <p>Note: This option only applies to parts with no work center locations.</p>	
<p>GENERIC TEXT PRINT OPTIONS:</p> <p>31. Enter a '1' to print the component's generic text on the Parts List.</p> <p>32. Enter a '1' to print the operation's generic text on the Routing.</p>	
<p>BAR CODE INFORMATION:</p> <p>34. Enter the format for bar code printing.</p> <p>1 = Code 3 of 9 (Code 39)</p> <p>2 = Code 128</p> <p>If left blank, bar codes will not print.</p>	
<p>COMMITMENT PROCESSING:</p> <p>35. Enter a '1' to bypass commitment processing when creating the Parts List.</p> <p>If left blank, commitments will be processed per Commitment Control in Manufacturing Constants (P3009).</p>	
<p>QUALITY MANAGEMENT:</p> <p>36. Enter '1' to print Manufacturing Specifications.</p> <p>37. Enter the version of the Manufacturing Specifications print program to call (P37470).</p> <p>If left blank, 'ZJDE0001' will be used.</p>	
<p>PHANTOM OPERATION SEQUENCE NUMBER:</p> <p>38. Enter a '1' to default the phantom's (parent) operation sequence for the components on the parts list.</p> <p>If left blank, the component's operation sequence will be used.</p>	
<p>WORK ORDER START DATE UPDATE:</p>	

Processing Option	Processing Options Requiring Further Description
<p>39. Enter a '1' to update the Work order Start Date with the Start Date of the first routing operation for variable lead time. If left blank no updating will be performed</p>	
<p>LOT EXPIRATION DATE:</p> <p>40. Select the date that will be used to determine the eligibility of lot/ /serial numbered components. Only lots with effective dates less than or equal to the date specified AND expiration dates (based on the item's commitment date method) greater than or equal to the date specified will be considered. ' ' = Parts list required date (default) '1' = Work order start date '2' = Work order requested (completion) date</p>	
<p>AUTOMATIC LOT NUMBER GENERATION:</p> <p>41. Enter a '1' to automatically generate a lot number upon co/by products creation for items with a lot process type of 1 or 2.</p>	

Component Scrap Transactions (P31116)

Processing Option	Processing Options Requiring Further Description
<p>DEFAULT FORMAT:</p> <p>1. Enter a '1' for Item Number entry. If left blank, Work Order Number entry will be used.</p>	
<p>DEFAULT VALUES:</p> <p>2. Enter the Item Ledger Transaction date. If left blank, the system date will be used.</p> <p>3. Reason Code (Optional)</p> <p>4. Enter the Document Type associated with the Component Scrap Transaction.</p>	
<p>SERIAL NUMBER PROCESSING:</p>	

Processing Option	Processing Options Requiring Further Description
5. Enter the Document Type to use for Serial Number Issues. If left blank, 'IM' will be used.	

Manufacturing WIP Journal Entries (P31802)

Processing Option	Processing Options Requiring Further Description
PROCESSING CONTROL: 1. Enter the G/L Date. If left blank, the system date will be used. 2. Enter a '1' to create journal entries. If left blank, Proof mode is assumed.	
JOURNAL ENTRY SUMMARIZATION: 3. Enter a '1' to summarize Material Issues by Account within a document. 4. Enter a '1' to summarize by Account ACROSS documents. WARNING: This option will reduce the number of journal entries.	NOTE: If you summarize ACROSS work orders you cannot activate processing option 9 to default the Work Order Number into the Subledger field
REPORT OPTIONS: 5. Enter a '1' to print an Accounting Journal. 6. Enter a '1' to print subtotals by Document Type and Document.	
REPORT SUMMARIZATION: 7. Enter a '1' to summarize Material Issues within a document. 8. Enter a '1' to summarize by Account ACROSS documents. WARNING: This option will reduce the report output. 9. Enter a '1' to default the document number into the Subledger field. 10. Enter the new Status Code for the document. If left blank, the status will not be changed.	NOTE: If you summarize ACROSS work orders you cannot activate processing option 9 to default the Work Order Number into the Subledger field.

Processing Option	Processing Options Requiring Further Description
<p>11. Enter the Document Type associated with Inventory Scrap.</p> <p>12. Enter the Document Type to default for Shop Floor Activity.</p> <p>NOTE: This will only be used if no Document Type exists in the Routing file (F3112).</p>	
<p>ISSUES OF MATERIAL:</p> <p>13. Enter a '1' to use the Charge to Business Unit for the Credit Side of IM Transactions.</p> <p>If left blank, Component Branch/Plant is used.</p>	
<p>CARDEX USER-ID UPDATE:</p> <p>14. Enter a '1' to update the User ID in the Cardex File (F4111).</p> <p>If left blank, the User ID will not be changed.</p>	

Manufacturing Variance Journal Entries (P31804)

Processing Option	Processing Options Requiring Further Description
<p>PROCESSING CONTROL:</p> <p>1. Enter the G/L date.</p> <p>If left blank, the system date will be used.</p>	
<p>JOURNAL ENTRY SELECTIONS:</p> <p>2. Enter '1' to create journal entries.</p> <p>If left blank, program will run in Proof mode and no journal entries will be created.</p> <p>3. Enter '1' to summarize by account ACROSS documents.</p> <p>WARNING: This option will reduce the number of journal entries.</p>	<p>NOTE: If you summarize ACROSS work orders you cannot activate processing option 7 to default the Work Order Number into the Subledger field</p>
<p>REPORT SELECTIONS:</p> <p>4. Enter '1' to print an accounting journal.</p> <p>5. Enter '1' to print subtotals by document.</p>	

Processing Option	Processing Options Requiring Further Description
<p>6. Enter '1' to summarize by account ACROSS documents. WARNING: This option will reduce the report output.</p> <p>7. Enter '1' to default the Document Number into the Subledger field. If left blank, the Subledger field will be left blank.</p> <p>8. Enter the Document Type associated with manufacturing variances.</p> <p>9. Enter the new status code for the document. If left blank, the status will not be updated.</p>	<p>NOTE: If you summarize ACROSS work orders you cannot activate processing option 7 to default the Work Order Number into the Subledger field</p>
<p>OVER/UNDER COMPLETIONS:</p> <p>10. Enter '1' to re-state the standard, current, and planned production costs based on completed + scrapped quantity. NOTE: This will eliminate the variance caused by the over/under completion.</p> <p>11. Enter the status beyond which documents should not be allowed to have additional activity. If left blank, '99' will be used.</p>	<p>NOTE: This will eliminate the Other variance caused by the over/under completion.</p>

Work Order Closing and Clear WIP (P31806)

Processing Option	Processing Options Requiring Further Description
<p>1. Enter the G/L Date. If left blank, the current date will be used.</p> <p>JOURNAL ENTRY SELECTIONS:</p> <p>2. Enter a '1' to create journal entries. If left blank, 'Proof' mode is assumed.</p> <p>3. Enter a '1' to summarize by Account ACROSS work orders. WARNING: This option will reduce the number of journal entries. See Helps.</p>	<p>Checking with Feimo in Development about this one.</p> <p>NOTE: If you summarize ACROSS work orders you cannot activate processing option 7 to default the Work Order Number into the Subledger field.</p>
<p>REPORT SELECTIONS:</p>	

Processing Option	Processing Options Requiring Further Description
<p>4. Enter a '1' to print an Accounting Journal.</p> <p>5. Enter a '1' to print subtotals by Document.</p> <p>6. Enter a '1' to summarize by Account ACROSS work orders. WARNING: This option will reduce the report output. See Helps.</p> <p>7. Enter a '1' to default the Work Order Number into the Subledger field.</p> <p>8. Enter the Document Type for Completion. If left blank, 'IC' will be used.</p> <p>9. Enter the Document Type for Scrap. If left blank, 'IS' will be used.</p> <p>10. Enter the new Status Code for the Work Order. If left blank, the status will not be changed.</p>	<p>NOTE: If you summarize ACROSS work orders you cannot activate processing option 7 to default the Work Order Number into the Subledger field.</p>

Gain/Loss Analysis Report (P415402)

Processing Option	Processing Options Requiring Further Description
<p>1. Enter the range of transaction dates for inclusion of records. (Blanks will default to system date) From Date Thru Date</p> <p>2. Enter the relation to use for the variance selection. GT=greater than LT=less than EQ=equal to</p> <p>3. Enter the quantity to compare the variance to for selection.</p> <p>4. Enter one of the following: A = compare the volume difference % = compare the percent variance</p>	

General Ledger Post (P09800)

Processing Option	Processing Options Requiring Further Description
<p>BATCH SELECTION:</p> <ol style="list-style-type: none"> 1. Enter Batch Number or Batch Date or Batch User ID 	
<p>PRINT SELECTION:</p> <ol style="list-style-type: none"> 2. Identify how to print amount fields on Post Journal: <ul style="list-style-type: none"> '1' = to Millions (w/ commas) '2' = to Billions (w/o commas) Blank (Default) = No Journal Printed. 3. Identify which account number to print on report: <ul style="list-style-type: none"> '1' = Account Number '2' = Short Account ID '3' = Unstructured Account '4' = (Default) Number Entered During Input 	
<p>FIXED ASSETS:</p> <ol style="list-style-type: none"> 4. Enter a '1' to post F/A entries to Fixed Assets. <p>Note: DREAM Writer version ZJDE0001 of Post G/L Entries to Assets (P12800) is executed when this option is selected. All transactions selected from that DREAM Writer will be posted rather than just the current entries being posted to G/L.</p> <ol style="list-style-type: none"> 5. Enter a 'Y' if you wish to explode parent item time down to the assembly component level. Component billing rates will be used. (This applies to batch type 'T' only.) 	
<p>CASH BASIS ACCOUNTING:</p> <ol style="list-style-type: none"> 6. Enter a '1' to create and post Cash Basis accounting entries. (Applies to batch type G, K, M, W, & R only.) 7. Enter units ledger type for Cash Basis Accounting entries. (Default of blank will use "ZU" ledger type.) 	
<p>ACCOUNTING FOR 52 PERIODS:</p>	

Processing Option	Processing Options Requiring Further Description
<p>8. Enter a '1' for 52 Period Post.</p> <p>Note: DREAM Writer data selection is used for 52 period posting ONLY. It is NOT used for the standard post to the F0902. Additionally, 52 period date patterns must be set up.</p>	
<p>TAX FILE UPDATE:</p> <p>9. Identify when to update the Tax Work file (F0018):</p> <p>'1' = V.A.T. or Use Tax only '2' = for All Tax Amounts '3' = for All Tax Explanation Codes Blank (Default) = No Update to File</p> <p>Note: When using Vertex Taxes the Vertex Tax Register file will be updated instead of the Tax Work file for methods '1', '2', and '3'.</p> <p>10. Adjust VAT Account for Cash Receipt Adjustments and Write Offs. Tax explanation must be a 'V'.</p> <p>'1' = update VAT amount only '2' = update VAT amount, extended price and taxable amount</p> <p>11. Adjust VAT Account for Discount Taken. The Tax Rules file must be set to Calculate Tax on Gross Amount, including Discount and Calculate Discount on Gross Amount, including Tax. Tax explanation must be a 'V'.</p> <p>'1' = update VAT amount only '2' = update VAT amount, extended price and taxable amount</p>	
<p>PROPERTY MANAGEMENT:</p> <p>12. Enter DREAM Writer version of Property Management G/L Transaction Creation to be executed.</p> <p>Default is version ZJDE0001. (This applies to batch types '2' and '/')</p>	
<p>UPDATE OPTION:</p>	

Processing Option	Processing Options Requiring Further Description
<p>13. Enter '1' to update short ID number, company, fiscal year/period number, century, and fiscal quarter in unposted transaction records selected for posting. (May be required for custom input programs.)</p>	
<p>REPORT FORMAT:</p> <p>14. Enter a '1' to print the Posting Journal in a 198 character format. The default of blank will print the format with 132 characters.</p>	
<p>DETAILED CURRENCY RESTATEMENT:</p> <p>15. Enter a '1' to create currency restatement entries. This creates records in the XA, YA, and/or ZA ledgers depending on the version you are running.</p> <p>16. Enter the version of the Detailed Currency Restatement (P11411) to execute. Default of blank will execute ZJDE0001.</p>	
<p>RECONCILIATION FILE PROCESSING:</p> <p>17. Enter a '1' to update the Cross-Environment Reconciliation file. Blank will not update the reconciliation file.</p> <p>Note: The Cross-Environment Reconciliation file can also be updated through the stand-alone Cross-Environment File Creation program.</p>	
<p>REVERSING JOURNAL ENTRIES:</p> <p>18. When normal number of periods = 12 or 13 and posting a reversing entry into period 12 or 13, enter a '1' to create reversing journal entries to the first period of the following year. This is to avoid posting reversing entries to an adjusting period.</p> <p>Example: Normal number of periods = 12. Period 12 ends 12/30/xx and period 13 ends 12/31/xx. Journal Entry date of 12/30/xx will post reversing entry to period 01 of next year if processing option is set to '1'.</p>	
<p>BATCH TYPE SELECTION:</p> <p>Note: This option should NOT be changed by User.</p>	

Item Ledger/Account Integrity (P41543)

Processing Option	Processing Options Requiring Further Description
<p>REPORT DISPLAY:</p> <ol style="list-style-type: none"> 1. Enter the beginning Item Ledger date. 2. Enter the ending Item Ledger date. 	
<p>SUMMARIZED MANUFACTURING J/E's:</p> <ol style="list-style-type: none"> 3. Enter a '1' to indicate that Manufacturing J/E's are summarized by account. 	
<p>Enter Document Types associated with:</p> <ol style="list-style-type: none"> 4. Inventory Issues 5. Inventory Completions 6. Parent Scrap 	
<p>LOAD AND DELIVERY DOCUMENT TYPE:</p> <ol style="list-style-type: none"> 7. Enter the Load and Delivery document type. (This should be same value as used in the Load and Delivery Transaction Server XT49799 document type.) 'CT' is the default. 	
<p>DIRECT SHIP LINE TYPE:</p> <ol style="list-style-type: none"> 8. Enter the Line Type for Direct Ship Sales Order lines. If left blank, there will not be a check for direct ship lines. 	

7 Appendices

Appendix A – Calculations in Cost Rollup

The following provides information about how hard-coded cost components are generated in the cost rollup process. These calculations can vary according to your manufacturing constants and your processing option choices.

The program adjusts direct labor hours and direct machine hours by time basis, crew size, and cumulative yield, as appropriate. The program adjusts component material quantities by operation scrap. Hours and quantities are also converted to the primary unit of measure.

This section contains the following:

- [Material Cost Components](#)
- [Routing Cost Components](#)
- [Outside Operation Cost Components \(Usually Dx\)](#)

See Also

- [Assigning Values to User Defined Cost Components \(P30026\)](#)

Material Cost Components

A1 (Purchased Material Cost)

- If you enter a cost method in the Purchased Item processing option on the Simulate Cost Rollup program, the program uses that cost method to retrieve the cost from the Cost Ledger table.
- If you leave the processing option blank, the program uses the values entered manually on Enter/Change Cost Components.

A2 (Material Scrap)

- Used for items that have a percent of scrap defined in their bill of material.
- Net added cost comes from scrap incurred when the components are assembled.
- Component material scrap cost = % of scrap from bill of material x quantity per parent item x the total cost of the component.

Routing Cost Components

Routing cost components (cost components B and C) can be controlled manually or through the Simulate Cost Rollup program.

B1 (Direct Labor)

- Parent direct labor costs = sum of direct labor calculations for all operations on the item's routing.
- Operation direct labor cost = $((\text{operation direct labor hours} / \text{operation time basis}) \times \text{operation crew size}) / (\text{operation cumulative yield \%} / 100) \times \text{work center direct labor rate}$.

B2 (Setup Labor)

- Parent setup labor cost = sum of all setup labor calculations for all operations on the item's routing.
- Operation setup labor cost = $(\text{operation setup labor hours} \times \text{work center setup labor rate}) / \text{accounting cost quantity}$ (if the accounting cost quantity is not zero).

B3 (Machine Run)

- Parent machine run cost = sum of machine run calculations for all operations on the item's routing.
- Operation machine run cost = $(\text{operation machine run hours} / \text{operation time basis}) \times (\text{operation cumulative yield} / 100) \times \text{work center machine run rate}$.

B4 (Labor Efficiency)

- Increases or decreases the cost of the labor required to produce an item. If you have set the manufacturing constants to modify costs by work center efficiency, the program creates a cost component (B4) for labor efficiency when you run Simulate Cost Rollup. In addition, if the efficiency for a work center is equal to zero, then no calculation is performed for that work center. Labor efficiency is only calculated for direct labor hours.
- Parent labor efficiency cost = sum of all efficiency calculations for all operations on the item's routing.
- Operation labor efficiency cost = $\text{operation direct labor hours} - (\text{operation direct labor hours} \times (\text{work center efficiency} / 100)) \times \text{work center direct labor rate}$.

C1, C2 (Variable/Fixed Machine Overhead)

- Calculated only if you have set the Manufacturing Constants table (F3009) to include variable and fixed machine overhead in the cost. In this table, you must also determine whether machines' overhead costs are calculated from manually entered rates in the Work Center Master table (F30006) or as a percent of machine run costs.

- Parent variable/fixed machine overhead cost = sum of all variable/fixed machine overhead calculations for the item's routing.
- Operation variable/fixed machine overhead cost by percent = machine run hours x (work center variable/fixed machine overhead percent / 100) x work center machine run rate.
- Operation variable/fixed machine overhead cost by rate = machine run hours x work center variable/fixed machine overhead rate.

C3, C4 (Variable/Fixed Labor Overhead)

The following calculations are displayed as rates. If you indicate on Work Center Master that variable/fixed labor overhead costs should be calculated as a percent of labor costs, multiply the work center labor rate by the percent / 100 to obtain the labor overhead rate. For example:

Operation variable labor overhead rate = (work center variable labor overhead percent / 100) x work center direct labor rate

- Calculated only if you have set the Manufacturing Constants table (F3009) to include variable and fixed labor overhead in the cost. In this table, you must also determine whether labor overhead costs are calculated from manually entered rates in the Work Center Master table (F3006) or as a percent of labor costs. In addition, you can set the manufacturing constants to factor labor overhead by work center efficiency.
- Parent variable/fixed labor overhead cost = sum of all variable/fixed labor overhead calculations for all operations on the item's routing.
- Variable/fixed labor overhead cost = direct labor overhead cost + setup labor overhead cost:
 - Direct labor overhead cost by rate:
 - Without labor efficiency: direct labor hours x work center variable/fixed labor overhead rate
 - With labor efficiency: (direct labor hours + work center efficiency) x work center variable/fixed labor overhead rate

Work center efficiency = labor hours - ((work center efficiency percent / 100) x labor hours)
 - Setup labor overhead cost by rate = (operation setup labor hours / accounting cost quantity) x work center variable/fixed labor overhead rate. Accounting cost quantity is factored if it is not equal to zero.

Outside Operation Cost Components (Usually Dx)

An outside operation is Manufacturing's vehicle to interface with Accounts Payable. When the vendor sends an Invoice for their services, there is a purchase order in the system to use in the voucher match procedure. It is important to remember that an outside operation is nothing more than the payment for services rendered. It is not an inventoried item. The following tips relate to cost components as they relate to outside operations.

- Can be entered manually on Enter/Change Cost Components or retrieved from the Cost Ledger table (F4105) when you run Simulate Cost Rollup.
- The Simulate Cost Rollup program creates item numbers for outside operations as follows:
 - Parent*OPxx. Parent = the parent item number and xx = the whole-number portion of the outside operation's operation sequence number.
For example, for item 333, an outside operation at operation sequence number 30 receives an item number of 333*OP30.
- If you enter a cost method in the Outside Operations processing option on the Simulate Cost Rollup program, the program uses that cost method to retrieve the cost from the Cost Ledger table. If the value is zero and a value previously existed in the Cost Components table, the original value remains.
- If you leave the processing option blank, the program uses the values entered manually on Enter/Change Cost Components.
- Outside operation cost components require a special handling code to segregate them from extra costs. Verify that UDC 30/CA contains a value of 1 in the special handling code (SHC) for any Dx cost component.
- Use inventory cost level 1 or 2 (CLEV). Inventory Cost Level 3 is not supported because outside operations are not inventory items, but rather the payment for services rendered. As a result of this, the functionality for Multi-Location, Lot Numbers or Serial Numbers is not included.

Caution: Do not make the *OP item lot controlled because at Purchase Order Receipt the system writes an OV to the Cardex. This OV location is in the fold of the Purchase Order (LOCN), but the corresponding IM will always be written to the Primary Location.

- You can key in a valid P4105 cost method (that has a cost value associated with it for outside operation) in processing option 6 for Standard Cost Simulation (P30820). The result of a successful completion of P30820 will then yield an A1 cost for the *OP item and a Dxx cost type on the parent item for the outside operations.
- When a receipt of purchase order is processed in P4312, the 4335 Standard Cost AAI is generally used along with the Inventory 4310 AAI and Received not Vouchered 4320 AAI.

Manufacturing WIP Journal Entries (P31802)

After an outside operation purchase order has been received in all or in part, you can run the Manufacturing WIP Journal Entries (P31802) to produce IH Journal Entries that relate to the outside operation. The AAI's that are generally used by P31802 for the Outside Operation are 3120 Work in Process and 3401 Accruals. The system debits 3120 and credits 3401 (an off-setting account of the 4310).

The 3120 AAI table is the value of the Outside Operation and is incorporated into the parent cost. It is the value of WIP. The 3401 balances the journal entry for 3120. The 3401 should be the same account number as the 4310, because other than balancing the 3120 and 4320, they are relatively meaningless.

The P31802 performs the following calculation: $(SOQS - CLUN) * F30026$ of the outside operation.

SOQS = Quantity shipped from F3112

CLUN = Actual Units from the F3102

(These fields are internal to the system and cannot be viewed on a video.)

An IH document type journal entry is created for the amount generated by the calculation. After the calculation takes place, the system updates the CLUN in the F3102 to match the SOQS in the F3112. This ensures that duplicate IH Journal Entries are not created for the Outside Operation.

Note: The Batch Number, G/L Date, User ID, and Program ID are not updated in the Cardex for the IM entry that correspond to the Outside Operation.

Appendix B – Calculations for Variances

Variance Inquiry displays costs from the Work Order Variance table (F3102). How the system calculates each cost component is explained here.

Standard Costs

Cost Component	Description
A1	Sum of rolled costs minus sum of net added costs = component material cost. Component material cost multiplied by work order quantity.
All other cost components	Net added cost x work order quantity These costs are created under the following conditions: <ul style="list-style-type: none">▪ When you run Order Processing▪ When the Parts List Revisions program copies the bill of material▪ When the Work Order Routing program copies the routings▪ When you generate journal entries for work order activity

Current Costs

Cost Component	Description
A1	The sum of total rolled costs for each item in the current bill of material. The cost of components is based on the quantity before scrap is added. This value is created under the following conditions: <ul style="list-style-type: none">▪ When you generate a parts list with Process Work Orders▪ When you generate journal entries for work order activity
A2	The sum of the total rolled costs for each item that is scrapped. This value is created under the following conditions: <ul style="list-style-type: none">▪ When you generate a parts list with Process Work Orders▪ When Parts List Revisions copies the bill of material

Cost Component	Description
B1-C4	<p>Calculated in the same manner as the Simulate Cost Rollup using the hours from the current routing.</p> <p>This value is created under the following conditions:</p> <ul style="list-style-type: none"> ▪ When you generate a parts list with Process Work Orders ▪ When Work Order Routing copies the routing
All other cost components	<p>Net added cost x work order quantity</p> <p>These costs are created under the following conditions:</p> <ul style="list-style-type: none"> ▪ When you generate work order routing with Process Work Orders ▪ When Work Order Routing copies the routing

Planned Costs

Planned costs are updated to the 3102 file with Manufacturing Accounting (P31802) is run in Proof or Final mode.

Cost Component	Description
A1	The sum of total rolled costs for each item in the current parts list.
A2	The sum of the total rolled costs for each item that is scrapped.
B1-C4	Calculated in the same manner as the Simulate Cost Rollup using the hours from the work order routing.
All other cost components	<p>The net added cost x work order quantity.</p> <p>This value is created when you generate journal entries for work order activity.</p>

Actual Costs

You must run Manufacturing Accounting in Final mode to update these values.

Cost Component	Description
A1	<p>Generated based on actual work order issues.</p> <p>This value is created when you generate journal entries for work order activity.</p>
A2	<p>The cost of the components actually scrapped using the Component Scrap form.</p> <p>See <i>Recording Component Scrap</i>.</p>

Cost Component	Description
B1-C4	<p>Calculated in the same manner as Simulate Cost Rollup using the hours from the work order routing.</p> <p>This value is created when you generate journal entries for work order activity.</p>
All other cost components	<p>The net added cost x work order quantity</p> <p>This value is created when you generate journal entries for work order activity.</p>

Completed/Scrapped Costs

You must run Manufacturing Accounting in Final mode to update these values.

Cost Component	Description
A1	<p>Sum of rolled costs - sum of net added costs = component material cost.</p> <p>This amount includes completed and scrapped quantities.</p>
All other cost components	<p>Net added cost x work order quantity.</p> <p>This value is created when you generate journal entries for work order activity.</p>

Appendix C – Purchase Price Variance

For purchased items, if the standard cost differs from the actual purchase price, you have a purchase price variance (PPV). If you use extra costs on purchased items, the total standard cost might differ from the A1 (material) cost. This difference is the material burden cost.

When you receive a purchase order, the system updates the accounts payable account using the price on the purchase order. The system updates the inventory account with the standard item cost from the Cost Ledger table (F4105). Any difference between the two costs is made up of PPV and material burden. PPV is the difference between the frozen A1 cost and the purchase order cost. Material burden cost is the difference between the total standard cost from the Cost Ledger table and the A1 cost, as follows:

$$\text{PPV} = \text{A1 cost} - \text{purchase order unit cost}$$

$$\text{Material burden cost} = \text{total standard cost} - \text{A1 cost}$$

Example: Purchase Price Variance and Material Burden

Cost Ledger Table (F4105)

Average cost = \$14

Standard cost = \$16

Cost Components Table (F30026)

A1 cost = \$13

X1 cost = \$3

Material Inventory	Material Re ceived (AP)	Material Burden	PPV
\$16	\$12	\$3	\$1
total standard cost	Purchase Order cost		

Material issued to the work order relieves the inventory account and posts to the WIP account with the fully loaded standard cost for the item.



At period end, a manual journal entry closes the PPV to the Cost of Goods Sold account.

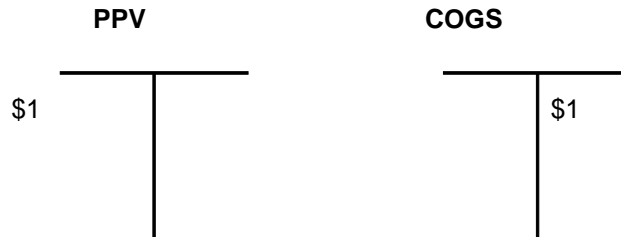

There is an additional AAI table (4337) to handle posting of the material overhead.

If you have multiple cost extras and you want to post to different accounts for each of them, you must use landed cost.

See Also

- *Setting Up Landed Costs (P41291) in the Procurement Guide*

Appendix D – Functional Servers

About Functional Servers

Several JD Edwards World programs access functional servers. The purpose of functional servers is to provide a central location for standard business rules about entering documents, such as vouchers, invoices, and journal entries. These business rules establish the following:

- Data dictionary default values
- Field edits and valid values
- Error processing
- Relationships between fields or applications

The advantages of a functional server are:

- It reduces maintenance of entry programs because edit rules reside in one central location.
- You can standardize documents across all applications because you create them using the same business rules.
- Generally, the user interface (appearance and interaction) of a form is now separate from how a program works.

To set up business rules for an entry program

The steps for setting up business rules for an entry program are:

1. Create a DREAM Writer version for a specific functional server program (for example, XT0411Z1 for voucher entry).
2. Set the processing options within the version according to your company requirements.
3. Specify the version you want the entry program to use in the processing options for that entry program.

You can have all your entry programs use the same DREAM Writer version (and thus, use the same rules) or you can set up different DREAM Writer versions. JD Edwards World provides DREAM Writer version ZJDE0001 as the default functional server version for your entry programs.

Caution: Only the person responsible for system-wide setup should make changes to the functional server version. For more information about how to set up DREAM Writer versions, see the *Technical Foundation Guide*.

Example: Voucher Processing Functional Server

The following graphic shows the programs that use the voucher processing functional server. JD Edwards World provides two demo versions of the functional server, ZJDE0001 and ZJDE0002.

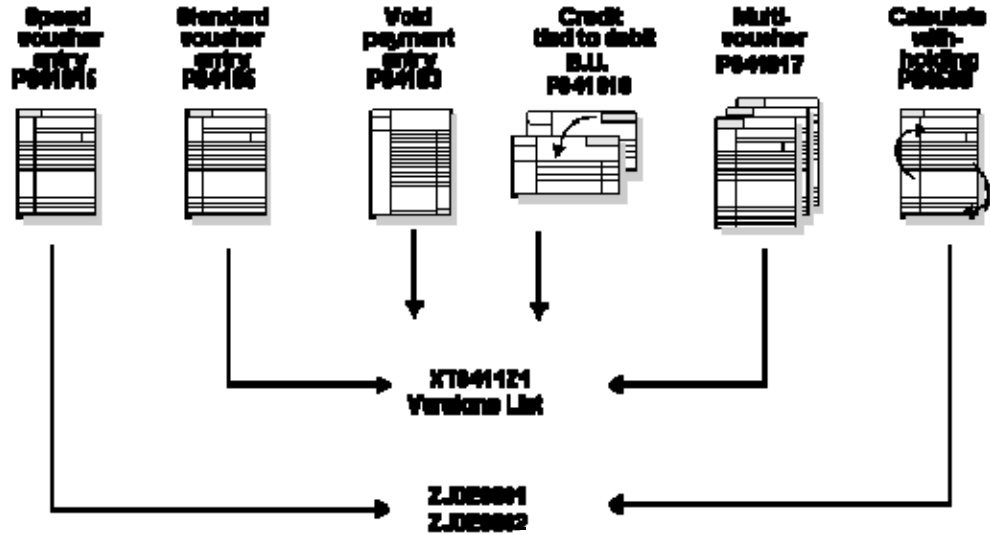

Appendix E – Files and Fields Updated

The following chart generally shows the files and fields that are updated by various product costing and manufacturing accounting programs:

Manufacturing Program Executed	Work Order Header F4801	Parts List F3111	Routing Hours F31122	Routing File F3112	Variances F3102	General Ledger F8911	Account Balances F8902	Item Ledger F4111
Process Work Orders P31410	Quantity on Order Updated	Required Quantity Updated		Required Hours Updated	Standard & Current Units and Amounts			
Material Issues P31113		Quantity Issued (WMTRQT) & Unaccounted Units Updated (WMCTS1)						IM Transaction Written (no batch # or G/L Date)
Hours and Quantities P311221			Hours Reported Updated					
Hours and Quantities Update P31422*			Processed Flag Updated (WLYST)	Unaccounted Units Updated (WLCYTS1 - WLCT36)				
Work Order Completions P31114	Quantity Completed (WASQCS) & Unaccounted Units Updated (WACTS1)							IC Transaction Written (no batch # or G/L Date)
Manufacturing Accounting P31302	Unaccounted Units Reset to Blank	Unaccounted Units Reset to Blank		Unaccounted Units Reset to Blank	Planned, Actual Completed and Scraped Units and Amounts	Journal Entries Created for IM, IC & IH Transactions		IM & IC Batch # and G/L date Updated
Variance Accounting P31304	Variance Flag Updated (WAPPPG)					Journal Entries Created for IV Transactions		
Journal Entry Foot P09200							Account Balances Updated	

Appendix F – Troubleshooting Techniques for Product Costing

The following includes some troubleshooting techniques to try when costs may not roll correctly when simulating and freezing standard costs:

- [Run the Integrity Analysis Program \(P30601\).](#)
- [Verify the Processing Options for P30820.](#)
- [Review A1 Cost Setup](#)
- [Review Batch Quantity Setup](#)
- [Adjust Primary Unit of Measure](#)
- [Adjust the B1 or B2 Costs](#)
- [Adjust the B3 through C4 Costs](#)
- [Adjust the D1, D2, D3 Costs](#)

Run the Integrity Analysis Program (P30601)

Anytime there is a problem with the cost roll up, the Integrity Analysis program (P30601) is a good program to run. This will:

- Verify that all items in the F3002 have a corresponding F4101 and F4102 record.
- Look for any and all recursive bills of material (any BOM that is an item going into itself).
- Reset the Low level Codes, if all the F3002 items have a corresponding F4101 and F4102 record, and there are no recursive bills of material.

Note: This program has no processing options or data selection. It is launched when selected from the menu. You cannot access the Item Master, Item Branch or Bills of Material files while this program is running.

Verify the Processing Options for P30820

Go through all of the processing options for P30820, and verify that they have been input correctly.

Review A1 Cost Setup

If an A1 cost is not being generated check for the following:

- A "Purchased" item has something other than a "P" in the second description of UDC Table 41/I
- The A1 cost type was deleted from the 30/CA UDC Table
- The Cost of the product is less than .0001
- No Bill of Material (BOM) exists
- The Feature Cost % is either "0" or blank
- It is a Non-Stock Product
- Valid Effectivity Dates

Review Batch Quantity Setup

If you are not using a "0" BOM (default) and the Batch Quantity does not match the Accounting Cost Quantity, review the batch quantity setup. See *Understand Batch Product Costing*.

Adjust Primary Unit of Measure

Your Primary Unit of Measure may not be the smallest. See the *Inventory Management Guide* for more information.

Adjust the B1 or B2 Costs

If there are no B1 or B2 costs being generated, check the following:

- There are no work center rates.
- The effectivity dates are correct.
- You are rolling a routing other than a "M" type routing.
- The Time Basis Codes in the fold of the Routing are correct.
- B1 was not taken out of the UDC Table 30/CA.
- The value of the B1 is not less than .0001.
- You are not using "0" routings (default) and that the Batch Quantity does not match the Accounting Cost Quantity
- The Crew Size in the fold of the routing is not blank.
- The Accounting Cost Quantity is either "0" or Blank..

Adjust the B3 through C4 Costs

If there are no B3 thru C4 costs being generated, check the Manufacturing Constants and verify that the client has asked the system to calculate these costs.

Adjust the D1, D2, D3 Costs

If there are no D1 or D2, D3 etc. costs being generated, check the following:

- The Routing Type is correct
- A D1, D2 etc; is in the Cost type field in the fold of the Routing

Appendix G – Routing Cost Type Calculations

These are the detail calculations for each cost type (B1 - C4). This appendix also gives examples on the calculations.

B1 Direct Labor

Direct Labor Hours / Time Basis * Crew Size * Direct Labor Rate = Direct Labor Cost

Example:

1.0 Direct Labor Hours / 1 Time Basis * 1.0 Crew Size * 5.25 Direct Labor Rate = 5.25
Direct Labor Cost

B2 Setup Labor

Setup Labor Hours / Accounting Cost Quantity * Setup labor Rate = *Setup Labor Cost*

Example:

1.00 Setup Labor Hours / 100 Accounting Cost Quantity * 4.25 Setup Labor Rate =
.0425 *Setup Labor Cost*

B3 Machine Run

Machine Run Hours / Time Basis * Machine Run Rate = *Machine Run Cost*

Example:

1.00 Machine Run Hours / 1 Time Basis * 3.25 Machine Run Rate = 3.25 *Machine Run Cost*

B4 Labor Efficiency Cost

Direct Labor Hours / Time Basis * Crew Size = *Factored Labors Hours*

Work Center Efficiency / 100 Percentage Conversion * Factored labors Hours =
Factored Efficiency

Factored Labors Hours – Factored Efficiency * Direct Labor Rate = *Labor Efficiency Cost*

Example:

1,000 Direct Labor Hours / 1 Time Basis * 1.0 Crew Size = 1.0000 Factored Labor Hours

50.00 Work Center Efficiency / 100 Percentage Conversion * 1,0000 Factored Labor Hrs = .5000 Factored Efficiency

1.0 factored Labors Hours – 5000 Factored Efficiency * 5.25 Direct Labor Rate = *2.6250 Labor Efficiency Cost*

C1 Machine (Mach) Variable (Var) Overhead (O/H) Cost

Var. Mach.O/H Percent / 100 Percentage Conversion * Machine Run Rate = *Var. Mach. O/H Rate*

Machine Run Hours / Time Basis = *Var. Mach. O/H Run Hours*

Var. Mach. O/H Run Hours * Var. Mach. O/H Rate = *Var. Mach. O/H Cost*

Example:

125.00 Var. Mach. O/H Percent / 100 Percentage Conversion * 3.25 Machine Run Rate = *4.06 Var. Machine O/H Rate*

1.00 Machine Run Hours / 1 Time Basis = *1.0000 Var. Machine O/H Run Hours*

1.00 Var. Mach. O/H Run Hours * 4.06 Var. Machine O/H Rate = *4.0625 Var. Mach O/H Cost*

C2 Machine Fixed Overhead Cost

Fixed Mach O/H Percent / 100 Percentage Conversion * Machine Run Rate = *Fixed Mach O/H Rate*

Machine Run Hours / Time Basis = *Fix Mach. O/H Run Hours*

Fix Mach. O/H Run Hours * Fixed Mach O/H Rate = *Fixed Mach. O/H Cost*

Example:

105.00 Fixed Mach. O/H Percent / 100 Percentage Conversion * 3.25 Machine Run Rate = *3.41 Fixed Machine O/H Rate*

1.00 Machine Run Hours / 1 Time Basis = *1.0000 fixed Machine O/H Run Hours*

1.0000 Fixed Mach. O/H Run Hours * 3.41 Fixed Mach O/H Rate = *3.4125 Fixed Machine O/H Cost*

C3 Labor Variable Overhead

Var. Labor O/H Percent / 100 Percentage Conversion * Direct Labor Rate = *Var. Labor O/H Rate*

Direct Labor Hours / Time Basis * Crew Size = *Factored Labor Hours*

Work Center (WC) Efficiency / 100 Percentage Conversion * Factored Labor Hours = *Factored Efficiency*

Factored Labor Hours – Factored Efficiency = *WC Efficiency Hours*

Factored Labor Hours + WC Efficiency Hours * Var. Labor O/H Rate = *Direct Labor O/H Cost*

Var. Labor O/H Percent / 100 Percentage Conversion * Setup Labor Rate = *Var. Labor O/H Rate*

Setup Labor Hours * Var. Labor Hours O/H Rate / Accounting Cost Quantity = *Setup Labor O/H Cost*

Direct Labor O/H Cost + Setup labor O/H Cost = *Var. labor O/H Cost*

Example:

60.00 Var. Labor O/H Percent / 100 Percentage Conversion * 5.25 Direct Labor Rate = *3.15 Var. Labor O/H Rate*

1.00 Direct Labor Hours / 1 Time Basis * 1.0 Crew Size = *1.0000 Factored Labor Hours*

50.00 Work Center Efficiency / 100 Percentage Conversion * 1.0000 Factored Labor Hrs = *.5000 Factored Efficiency*

1.0000 Factored Labor Hours - .5000 Factored Efficiency = *.5000 WC Efficiency Hrs.*

1.0000 Factored Labor Hours + .5000 WC Efficiency Hrs * 3.15 Var. Labor O/H Rate = *4.7250 Direct Labor O/H Cost*

60.00 Var. Labor O/H Percent / 100 Percentage Conversion * 4.25 Setup Labor Rate = *2.55 Var. Labor O/H Rate*

Setup Labor Hours * 2.55 Var. Labor O/H Rate / 100 Accounting Cost Quantity = *.0255 Setup labor O/H Cost*

4.7250 Direct Labor O/H Cost + .0255 Setup labor O/H Cost = *4.7505 Var. Labor O/H Cost*

C4 Labor Fixed Overhead

Fixed labor O/H Percent / 100 Percentage Conversion * Direct Labor Rate = *Fixed Labor O/H Rate*

Direct Labor Hours / Time Basis * Crew Size = *Factored Labor Hours*

Work Center Efficiency / 100 Percentage Conversion * Factored labor Hours = *Factored Efficiency*

Factored labor Hours – Factored Efficiency = *WC Efficiency Hours*

Factored labors Hours + WC Efficiency Hours * Fixed Labor O/H Rate = *Direct Labor O/H Cost*

Fixed Labor O/H Percent / 100 Percentage Conversion * Setup labor Rate = *Fixed Labor O/H Rate*

Setup labor Hours * Fixed labor O/H Rate / Accounting Cost Quantity = *Setup Labor O/H Cost*

Direct Labor O/H Cost + Setup labor O/H Cost = *Fixed labor O/H Cost*

Example:

50.00 Fixed Labor O/H Percent / 100 Percentage Conversion * 5.25 Direct Labor Rate = *2.63 Fixed labor O/H Rate*

1.00 Direct labor Hours / 1 Time Basics * 1.0 Crew Size = *1.00 Factored labor Hours*

50.00 Work Center Efficiency / 100 Percentage Conversion * 1.0000 Factored Labors Hrs = *.5000 Factored Efficiency*

1.0000 Factored Labors Hours - .5000 Factored Efficiency = *.5000 WC Efficiency Hrs.*

1.0000 Factored Labors Hours + .5000 WC Efficiency Hours * 2.63 Fixed Labor O/H Rate = *3.9375 Direct Labor O/H Cost*

50.00 Fixed Labor O/H Percent / 100 Percentage Conversion * 4.25 Setup Labor Rate = *2.13 Fixed Labor O/H Rate*

1.00 Setup Labor Hours * 2.13 Fixed Labor O/H Rate / 100 Accounting Cost Quantity = *.0213 Setup labor O/H Cost*

3.9375 Direct labor O/H Cost + .0213 Setup labor O/H Cost = *3.9588 Fixed labor O/H Cost*

Index

A

- A7.3
 - costed process, 3-21
 - enter/change cost components
 - defining extra cost components, 2-49
 - reset simulated costs
 - processing options, 2-84
 - summarized journal entries, 4-57
- About batch product costing, 3-3
- About calculated amounts in process industry accounting, 5-3
- About manufacturing accounting, 4-1
- About manufacturing accounting in ERPx environments, 5-1
- About process industry accounting, 5-3
- About product costing, 2-1
- About product costing for kit items, 3-5
- About product costing in ERPx environments, 3-1
- About unaccounted units in process industry accounting, 5-3
- About work orders in accounting, *See* About unaccounted units, *See* What are work order variances?
- Account numbers, 4-9
- Accounting, 1-7
- Accounting Cost Quantity
 - setting up, 2-5
- Accounting fundamentals, 4-5
- Accounts and accounting numbers, 4-7
- Achieving effective cost management, 1-7
- Actual amounts, 5-4
- Additional costing features
 - copying costs, 2-83
 - working with, 2-83
- Alternate formats
 - item ledger, 2-75
- Assigning cost method
 - without specifying a cost, 2-15
- Assigning values to user defined cost components, 2-47, *See* Setting up cost components, *See* What are cost components? (P30026)
- Attaching a parts lists and routing instruction, 4-28
- Automatic Accounting Instructions (AAIs)
 - reviewing, 4-15, 4-17
 - tables
 - user defined, 1-3

- Automatic Accounting Instructions form (P40901), 4-19

B

- Batch product costing, 3-3
- Bill of material
 - inquiry, 2-52
 - multi-level costed report, 2-73, 2-79
 - rollup, user defined, 1-3
- Bills of material
 - reviewing for product costing, 2-25
- Bills of material and routings
 - reviewing for product costing, 2-25
- Bulk Manufacturing
 - creating journal entries for gains and losses, 4-41, 4-56
- Business units, 4-8
- By-products
 - defined, 3-7

C

- Changing unit costs, 2-15
- Chart of accounts, 4-12
- Co-/by-products
 - in product costing
 - reviewing, 3-8, 3-14
- Co-/By-Products Planning table
 - setting up, 3-16
- Co-/By-Products Planning Table form (P3404), 3-17, 3-18
- Completed amounts, 5-4
- Completions
 - journal entries, 4-44
- Component scrap
 - recording, 4-25, 4-34
- Component Scrap form (P31116), 4-35, 4-36
- Configured items
 - journal entries, 4-46
 - product costing, 3-31
 - variances, 4-49
- Converting item cost levels, 2-10, *See* Setting up item cost levels
 - before you begin, 2-10
- Co-products
 - defined, 3-7
- Copying

- frozen costs to simulated costs, 2-83, 2-84
- Copying costs, 2-83
 - additional costing features, 2-83
 - caution, 2-83
- Copying frozen costs to simulated costs, 2-84
- Cost bucket codes
 - costed bill of material
 - setting up, 2-41, 2-50
 - setting up
 - costed bill of material, 2-41, 2-50
- Cost components, 2-3
 - assigning values to user defined, 2-41, 2-47
 - setting up, 2-5, 2-16
 - user defined, 1-3
- Cost Components report
 - reviewing, 2-73, 2-80
- Cost factors and rates
 - user defined, 1-3
- Cost Integrity Report
 - reviewing, 2-73, 2-81
- Cost methods
 - user defined, 1-3
- Cost Revisions form (P4105), 2-14
- Cost simulation
 - user defined, 1-3
- Cost variances
 - user defined, 1-3
- Costed Bill Inquiry form (P30206), 2-53
- Costed bill of material
 - reviewing, 2-41, 2-52
- Costed Bucket Key form (P30CB), 2-55
- Costed process
 - reviewing, 3-8, 3-21
- Costed Process form (P30208), 3-22
- Costed Resources form (P30206P), 3-23, 3-24
- Costed routing
 - operation bucket codes, 2-60
 - reviewing, 2-41, 2-61
- Costed Routing Inquiry Detail form (P30208W), 2-63
- Costed Routing Inquiry form (P30208), 2-62
- Costing Exceptions report
 - creating, 2-35, 2-36
- Costing information
 - reviewing, 2-73
- Creating
 - journal entries, 4-41
 - bulk manufacturing gains and losses, 4-41, 4-56
 - variances, 4-41, 4-52
 - work in process or completions, 4-41, 4-44
 - work orders, 4-25
- Creating a simulated rollup, 2-38. *See* Assigning values to user defined cost components. *See* Updating frozen costs. *See* Updating frozen costs (P30835)
 - before you begin, 2-39
- Creating journal entries, 4-41. *See* Appendix C - Purchase price variance

- Creating Journal Entries for Bulk Manufacturing Gains and Losses, 4-56
- Creating journal entries for variances, 4-52
- Creating journal entries for work in process or completions, 4-44
- Creating simulated costs, 2-35
- Creating the costing exceptions report, 2-36
- Cumulative yield
 - simulated rollup, 2-38
- Cumulative Yield
 - simulated rollup, 2-38

D

- Data Sequence Setup form (P98303)
 - for configured items, 3-33
- Design engineering, 1-7
- Detail and summary
 - journal entries, 4-43
- Detail journal entries, 4-43
- Detailed calculation, 2-43
- Distribution Automatic Account form (P40950), 4-20
 - memo text, 4-21

E

- Edit report
 - posting, 4-69, 4-72
- Effective cost management
 - achieving, 1-7
- Efficiency variances, 4-81
- Engineering
 - design, 1-7
 - manufacturing, 1-7
- Engineering variance, 4-78
- Enter/Change Bill form (P3002), 2-27, 3-28
- Enter/Change Cost Components form (P30026), 2-74
- Enter/Change Order form (P48013), 4-26
- Enter/Change Process form (P3003), 3-9, 3-10
- Enter/Change Routing form (P3003), 2-30
- Enter/Change Work Center Rate form (P30061), 2-22
- ERPx environments
 - manufacturing accounting, 5-1
 - product costing, 3-1
- Example
 - chart of accounts, 4-13
 - costing a configured item, 3-32
 - feature cost percent effect
 - co-/by-product costing, 3-14
 - process work orders data sequence setup for configured items, 3-33
- Exceptions report
 - invalid account numbers, 4-53

F

Factor codes
 setting up, 2-41, 2-45

Fast Path Commands table
 manufacturing accounting, 1-12
 product costing, 1-11

Forms
 Automatic Accounting Instructions, 4-19
 Co-/By-Products Planning Table, 3-17, 3-18
 Component Scrap, 4-35, 4-36
 Cost Bucket Key, 2-55
 Cost Revisions, 2-14
 Costed Bill Inquiry, 2-53
 Costed Process, 3-22
 Costed Resources, 3-23, 3-24
 Costed Routing Inquiry, 2-62
 Costed Routing Inquiry Detail, 2-63
 Data Sequence Setup, 3-33
 Distribution Automatic Account, 4-20
 memo text, 4-21
 Enter/Change Bill, 2-27, 3-28
 Enter/Change Cost Components, 2-74
 Enter/Change Order, 4-26
 Enter/Change Process, 3-9, 3-10
 Enter/Change Routing, 2-30
 Enter/Change Work Center Rate, 2-22
 Full Completion, 4-39
 G/L Review, 4-60
 General Ledger Batch Review, 4-62
 Hours & Quantities, 4-32
 Intermediate Product Revisions, 3-11
 Inventory Issues, 4-30
 Item Branch/Plant Information, 4-16
 Item Ledger, 2-76
 Item Master Information, 2-7
 Journal Entries, 4-64, 4-65
 Manufacturing Constants, 2-18
 Manufacturing Data, 2-6
 Operation Bucket Key, 2-63
 Operation Bucket Key Window, 3-23
 Process Resource Revisions, 3-13, 3-15
 Speed Cost Maintenance, 2-85
 Standard Factor Codes, 2-45
 Standard Rate Codes, 2-46
 Summarized Batch Selection, 4-58
 Summarized Work Orders, 4-57
 User Defined Code Revisions, 2-12, 2-17, 2-51, 2-60
 Variance Inquiry, 4-50

Frozen amounts, 5-3

Frozen cost components
 reviewing, 2-73

Frozen costs
 copying to simulated costs, 2-83, 2-84
 updating, 2-67
 versus simulated, 2-2

Frozen Standard Update report, 2-70

Full Completion form (P31114), 4-39

G

G/L batch detail
 to review, 4-62

G/L batches
 to review all or specific, 4-60

G/L class codes
 setting up, 4-15

G/L Review form (P00201), 4-60

General ledger
 posting to, 4-69

General Ledger Batch Review form (P09202), 4-62

General ledger batches
 reviewing, 4-59

General ledger transactions, 4-7

Graphic
 manufacturing accounting menu overview, 1-11
 post process, 4-72
 pre-post process, 4-71
 product costing menu overview, 1-10
 standard cost, 2-2
 three tier process, 4-41

H

Hours & Quantities form (P311221), 4-32

I

Ingredients
 in product costing, 3-8, 3-13

Intercompany settlements, 4-71

Intermediate
 defined, 3-7

Intermediate Product Revisions form (P3002), 3-11

Intermediates in product costing
 reviewing, 3-8, 3-11

Invalid account numbers
 exceptions report, 4-53

Inventory Issues form (P31113), 4-30

Issuing parts to work orders, 4-29

Item Branch/Plant Information form (P41026), 4-16

Item Cost Ledger Exception report, 2-70

Item cost levels
 converting, 2-5, 2-10
 setting up, 2-5, 2-6

Item costs
 setting up, 2-11

Item ledger
 alternate formats, 2-75
 reviewing, 2-73, 2-75

Item Ledger form (P4111), 2-76

Item Ledger/Account Integrity report
 reviewing, 4-69, 4-74

Item Master Information form (P4101), 2-7

J

- Journal
 - posting, 4-69, 4-73
- Journal entries, 4-69
 - completions, 4-44
 - creating, 4-41
 - work in process or completions, 4-41, 4-44
 - detail, 2-68, 2-69
 - detail and summary, 4-43
 - entering transactions, 4-41
 - for configured items, 4-46
 - posting transactions, 4-41
 - reviewing transactions, 4-41
 - status codes, 4-59
 - summarized, 4-43
 - summary, 2-69
 - three-tier process, 4-41
 - work in process, 4-44
- Journal entries for work order variances
 - user defined, 1-3
- Journal Entries form (P09101), 4-64, 4-65

K

- Kit items
 - product costing, 3-5

L

- Ledger Type
 - optional, 4-11
- Level of detail, 4-9

M

- Manufacturing, 1-7
- Manufacturing journal entries
 - posting, 4-69
- Manufacturing accounting
 - account numbers, 4-9
 - accounting equation, 4-5
 - accounts and account numbers, 4-7
 - automatic accounting instructions, 4-15, 4-17
 - business units, 4-8
 - chart of accounts, 4-12
 - fast path commands table, 1-12
 - general accounting system overview, 4-1
 - general ledger transactions, 4-7
 - level of detail, 4-9
 - menu overview, 1-11
 - graphic, 1-11
 - object and subsidiary accounts, 4-8
 - prerequisites, 1-3
 - relationship with product costing, 1-3
 - setting up, 4-15
 - subledger accounting, 4-10

- system overview graphic, 4-3
 - work order variances, 4-13
- Manufacturing accounting tables
 - reviewing, 4-84
- Manufacturing constants
 - setting up, 2-5, 2-17
- Manufacturing Constants form (P3009), 2-18
- Manufacturing Data form (P41027), 2-6
- Manufacturing engineering, 1-7
- Master routings, 2-39
- Material Usage Variances
 - World Writer report, 4-81
- Menu overview, 1-10
 - manufacturing accounting, 1-11
 - product costing, 1-10
- Multi-facility costing
 - user defined, 1-3
- Multi-level costed bill of material report
 - reviewing, 2-73, 2-79

N

- Net added cost, 2-2

O

- Object and subsidiary accounts, 4-8
 - object - major, 4-8
 - subsidiary - minor, 4-8
- Open work order valuation, 4-82
- Operation bucket codes
 - setting up
 - costed routing, 2-60
- Operation Bucket Key form (P30CO), 2-63
- Operation Bucket Key Window form (P30CO), 3-23
- Operation scrap
 - simulated rollup, 2-38
- Original journal entry document
 - to review, 4-64

P

- Percent bills of material
 - reviewing product costing, 3-8
- Planned variance, 4-79, 4-80
- Post process, 4-71
- Posting
 - edit report, 4-69, 4-72
 - general ledger, 4-69
 - journal, 4-69, 4-73
 - manufacturing journal entries, 4-69
 - post process, 4-71
- Posting edit codes
 - setting up, 4-12
 - subledgers, 4-12

- Posting manufacturing journal entries, 4-69, *See*
 - Creating journal entries (P31802), *See* Reviewing general ledger batches (P00201)
 - before you begin, 4-72
 - Posting to the general ledger, 4-69
 - Process industry
 - accounting, 5-3
 - calculated amounts, 5-3
 - unaccounted units, 5-3
 - costing
 - working with, 3-7
 - Process industry accounting
 - calculated amounts, 4-49
 - Process Resource Revisions form (P3002P), 3-13, 3-15
 - Process work orders
 - for configured items, 3-31
 - Processes in product costing
 - reviewing, 3-8, 3-9
 - Product costing
 - accounting fundamentals, 4-5
 - configured items, 3-31
 - ERPx environments, 3-1
 - ingredients, 3-8, 3-13
 - kit items, 3-5
 - menu overview, 1-10
 - graphic, 1-10
 - overview, 2-1
 - prerequisites, 1-3
 - relationship with manufacturing accounting, 1-3
 - setting up, 2-5
 - Product costing and manufacturing accounting
 - overview, 1-1
 - Product costing and manufacturing accounting integration, 1-4
 - Product costing for kit items
 - feature costing percentages, 3-5
 - simulate cost rollup program, 3-5
 - Product costs
 - updating, 2-83, 2-84
 - Programs and IDs
 - P00051 (user defined code revisions), 2-12, 2-17, 2-51, 2-60
 - P00191 (standard factors), 2-45
 - P00191 (standard rates), 2-46
 - P00201 (G/L review), 4-60
 - P09101 (journal entries), 4-64, 4-65
 - P09202 (general ledger batch review), 4-62
 - P3002 (enter/change bill), 2-27, 3-28
 - P3002 (intermediate product revisions), 3-11
 - P30026 (enter/change cost components), 2-74
 - P3002P (process resource revisions), 3-13, 3-15
 - P3003 (enter/change process), 3-9, 3-10
 - P3003 (enter/change routing), 2-30
 - P30061 (enter/change work center rate), 2-22
 - P3009 (manufacturing constants), 2-18
 - P30206 (costed bill inquiry), 2-53
 - P30206P (costed resources), 3-23, 3-24
 - P30208 (costed process), 3-22
 - P30208 (costed routing inquiry), 2-62
 - P30208W (costed routing inquiry detail), 2-63
 - P30CB (cost bucket key), 2-55
 - P30CO (operation bucket key window), 3-23
 - P30CO (operation bucket key), 2-63
 - P3102 (variance inquiry), 4-50
 - P3108 (summarized work orders), 4-57
 - P3108W (summarized batch selection), 4-58
 - P31113 (inventory issues), 4-30
 - P31114 (full completion), 4-39
 - P31116 (component scrap), 4-35, 4-36
 - P311221 (hours & quantities), 4-32
 - P3404 (co-/by-products planning table), 3-17, 3-18
 - P40901 (automatic accounting instructions), 4-19
 - P40950 (distribution automatic account), 4-20
 - memo text, 4-21
 - P4101 (item master information), 2-7
 - P41026 (item branch/plant information), 4-16
 - P41027 (manufacturing data), 2-6
 - P4105 (cost revisions), 2-14
 - P4105 (speed cost maintenance), 2-85
 - P4111 (item ledger), 2-76
 - P48013 (enter/change order), 4-26
 - P98303 (data sequence setup), 3-33
 - Purchasing, 1-7
- ## R
- Rates
 - work center, 2-21
 - Recording
 - completions to work orders, 4-25, 4-37
 - component scrap, 4-25, 4-34
 - hours and quantities used, 4-25, 4-31
 - Recording completions to work orders, 4-37
 - Recording component scrap, 4-34
 - Recording hours and quantities used, 4-31
 - Removing a cost method, 2-15
 - Reports
 - Completed Work Order Valuation, 4-83
 - Cost Components, 2-80
 - Cost Integrity, 2-81
 - Costed Bill, 2-79
 - Efficiency Variances, 4-81
 - Engineering Variances - Amounts, 4-78
 - Frozen Standard Update, 2-70
 - General Ledger Post - General Accounting, 4-73
 - Item Cost Ledger Exception, 2-70
 - Item Ledger/Account Integrity, 4-75
 - Manufacturing Accounting Tables, 4-84
 - Manufacturing WIP Journal Entries
 - for Work Orders in Process, 4-46
 - Material Usage Variances World Writer, 4-81
 - Multi-Level Costed Bill, 2-80
 - Open Work Order Valuation, 4-82
 - Planned Variance - Amounts, 4-79, 4-80

- Standard Cost Simulation, 2-41, 2-50
 - Total/WIP and Other Variances - Amounts, 4-82
 - user defined, 1-3
 - Work Order Activity - Amounts, 4-77
 - Work Order Activity - Units, 4-77
 - Work Order Variances - Amounts, 4-84
 - World Writer, for Manufacturing Accounting, 4-69, 4-76
 - Reviewing
 - automatic accounting instructions, 4-15, 4-17
 - co-/by-products in product costing, 3-8, 3-14
 - costed process, 3-8, 3-21
 - general ledger batches, 4-59
 - manufacturing accounting tables, 4-84
 - product costing for intermediates, 3-8, 3-11
 - product costing for percent bills of material, 3-8
 - product costing for processes, 3-8, 3-9
 - summarized work orders, 4-57
 - variances, 4-41, 4-47
 - Reviewing a costed bill of material, *See* Setting up cost bucket codes for a costed bill of material
 - Reviewing a costed process, 3-21
 - Reviewing a costed routing, 2-61, *See* Appendix A - Calculations in cost rollup, *See* Setting up operation bucket codes for a costed routing
 - Reviewing a multi-level costed bill of material report, 2-79
 - Reviewing a single level costed bill of material report, 2-78
 - Reviewing and revising simulated cost components, 2-41, *See* Creating a simulated rollup
 - Reviewing Automatic Accounting Instructions (AAIs), 4-17
 - Reviewing bills of material and routings, 2-25
 - Reviewing completed work order valuation, 4-83
 - Reviewing costed bills of material, 2-52
 - Reviewing costing information, 2-73
 - Reviewing efficiency variances, 4-81
 - Reviewing engineering variance, 4-78
 - Reviewing frozen cost components, 2-73
 - Reviewing general ledger batches, 4-59, *See* Creating journal entries (P31802) before you begin, 4-59
 - Reviewing manufacturing accounting tables, 4-84
 - Reviewing open work order valuation, 4-82
 - Reviewing percent bills of material, 3-28
 - Reviewing planned variance (to current), 4-79
 - Reviewing planned variance (to standard), 4-80
 - Reviewing product costing for co-/by-products, 3-14
 - Reviewing Product Costing for Ingredients, 3-13
 - Reviewing product costing for intermediates, 3-11
 - Reviewing product costing for processes, 3-9
 - Reviewing routing information, 2-30
 - Reviewing summarized work orders, 4-57
 - Reviewing the cost components report, 2-80
 - Reviewing the cost integrity report, 2-81
 - Reviewing the item ledger, 2-75
 - Reviewing the Item Ledger/Account Integrity report, 4-74, *See* Creating journal entries before you begin, 4-75
 - Reviewing the posting edit report for manufacturing, 4-72
 - Reviewing the posting journal report, 4-73
 - Reviewing the Standard Cost Simulation report, 2-50
 - Reviewing total/WIP and other variances, 4-82
 - Reviewing variances, 4-47, *See* Appendix B - Calculations for variances
 - Reviewing work order activity (amounts), 4-77
 - Reviewing work order activity (units), 4-77
 - Reviewing work order amount variances, 4-84
 - Reviewing World Writer reports, 4-76
 - Routings
 - reviewing for product costing, 2-25, 2-30
- ## S
- Sales, 1-7
 - Sales order price/cost
 - updating, 2-83, 2-84
 - Sales/inventory cost method, 2-10
 - Setting up
 - co-/by-product planning table, 3-16
 - factor codes, 2-41, 2-45
 - G/L class codes, 4-15
 - manufacturing accounting, 4-15
 - optional ledger types, 4-11
 - posting edit codes, 4-12
 - standard rate codes, 2-41, 2-45
 - subledger types, 4-11
 - Setting up accounting cost quantities, 2-5
 - Setting up cost bucket codes for costed bills of material, 2-51
 - Setting up cost components, *See* Appendix A - Calculations in cost rollup, *See* Assigning values to user defined cost components, *See* Appendix A - Calculations in cost rollup, *See* Assigning values to user defined cost components (P30026), *See* What are cost components? (P30026)
 - Setting up General Ledger (G/L) Class Codes, 4-15
 - Setting up item cost levels, 2-7
 - Setting up item costs, 2-11, *See* Updating product costs (P4105), *See* Updating product costs (P4105)
 - Setting up manufacturing accounting, 4-15
 - Setting up manufacturing constants for product costing, 2-17
 - Setting up operation bucket codes for costed routings, 2-60
 - Setting up product costing, 2-5
 - Setting up simulated rates for a work center, 2-21

Setting up standard rate and factor codes, 2-45, *See*
 Assigning values to user defined cost
 components
 Simulate cost rollup program, 2-45
 Simulated cost components, 2-42
 reviewing and revising, 2-41
 working with, 2-41
 Simulated costs
 creating, 2-35
 Simulated rates for a work center
 setting up, 2-5, 2-21
 Simulated rollup
 creating, 2-35, 2-38
 cumulative yield, 2-38
 operation scrap, 2-38
 Simulated versus frozen costs, 2-2
 Single level costed bill of material report
 reviewing, 2-73, 2-78
 Speed Cost Maintenance form (P4105), 2-85
 Standard cost
 graphic, 2-2
 Standard cost simulation report, 2-41, 2-50
 Standard costs, 2-1
 Standard Factor Codes form (P00191), 2-45
 Standard rate codes
 setting up, 2-41, 2-45
 Standard Rate Codes form (P00191), 2-46
 Status codes
 journal entries, 4-59
 Subledger accounting, 4-10
 Subledger types
 setting up, 4-11
 Summarized Batch Selection form (P3108W), 4-58
 Summarized work orders
 reviewing, 4-57
 Summarized Work Orders form (P3108), 4-57
 Summary journal entries, 4-43
 System integration, 1-1

T

Tables

Account Balances (F0902), 1-9
 Account Ledger (F0911), 1-9
 Account Master (F0901), 1-9
 Address Book (F0101), 1-10
 Automatic Accounting Instruction (AAI) Values
 (F4095), 1-9
 Batch Control (F0011), 1-9
 Bill of Material Master (F3002), 1-8, 2-35
 Branch/Plant Master (F4102), 1-10
 Business Unit Master (F0006), 1-10
 Cost Components (F30026), 1-8
 Cost Ledger (F4105), 1-8, 2-35
 Item Ledger (F4111), 1-9
 Item Master (F4101), 1-10
 Manufacturing Constants (F3009), 1-8, 2-35

Manufacturing Data (F4102), 1-8
 Parts List (F3111), 1-9
 Routing Instructions (F3112), 1-10
 Routing Master (F3003), 1-8, 2-35
 User Defined Codes (F0005), 1-9
 Work Center Master (F30006), 1-8
 Work Center Rates (F30008), 1-8, 2-35
 Work Order Master (F4801), 1-9
 Work Order Variances (F3102), 1-10

T-accounts, 4-6

Total cost, 2-2

Total/WIP and other variances, 4-82

Transactions

with variances, 4-44

U

Unaccounted units

in process industry accounting, 5-3

Update sales price/cost program

caution, 2-84

overview, 2-84

Updating

product costs, 2-83, 2-84

sales order price/cost, 2-83, 2-84

Updating frozen costs, 2-67

before you begin, 2-69

Updating product costs, 2-84, *See* Setting up item

costs (P4105)

Updating sales order price/cost, 2-84

Updating unit costs, 2-15

User defined

automatic accounting instruction tables, 1-3

bill of material rollup, 1-3

cost components and add-ons, 1-3

cost components, assigning values to, 2-41, 2-47

cost factors and rates, 1-3

cost methods, 1-3

cost simulation, 1-3

cost variances, 1-3

journal entries for work order variances, 1-3

multi-facility costing, 1-3

reports, 1-3

variances, 1-3

work order journal entries, 1-3

User Defined Code Revisions form (P00051), 2-12,

2-17, 2-51, 2-60

V

Variance Inquiry form (P3102), 4-50

Variances

configured items, 4-49

creating journal entries, 4-41, 4-52

reviewing, 4-41, 4-47

user defined, 1-3

W

- What are cost components?, 2-3
- What are standard costs?, 2-1
- What are work order variances?, 4-13
- What is subledger accounting?, 4-10
- What is the chart of accounts, 4-12
- Why maintain standard costs?, 2-2
- Work center
 - rates, 2-21
- Work in process
 - journal entries, 4-44
- Work order
 - attaching parts lists and routing instructions, 4-25, 4-28
 - issuing parts to, 4-25, 4-29
 - recording completions, 4-25, 4-37
 - recording hours and quantities used, 4-25, 4-31
 - working with, 4-25
- Work order activity
 - amounts, 4-77
 - units, 4-77
- Work order journal entries
 - user defined, 1-3
- Work order valuation
 - completed, 4-83
- Work order variances, 4-13, 4-84
- Work orders
 - creating, 4-25
- Working with
 - additional costing features, 2-83
 - process industry costing, 3-7
 - work orders, 4-25
- Working with additional costing features, 2-83
- Working with process industry costing, 3-7
- Working with simulated cost components, 2-41
- Working with work orders, 4-25
- World Writer reports for Manufacturing
 - Accounting, 4-69, 4-76