

PRODUCT ENGINEERING/ DEVELOPMENT TOOLS & METHODS

GD&T RESOURCES GUIDE

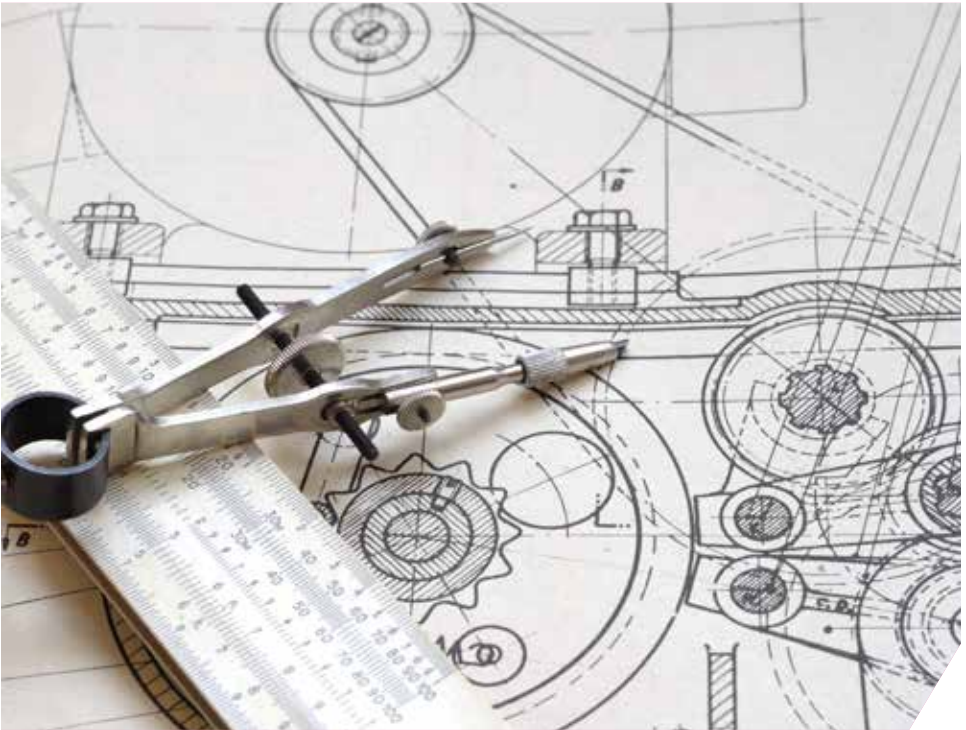

PRODUCT ENGINEERING TOOLS & METHODS GD&T RESOURCES GUIDE

Get critical GD&T training and education from Effective Training Inc. (ETI), an SAE International Company. Included in this Product Engineering Tools & Methods GD&T Resources Guide are learning options related to GD&T fundamentals, advanced concepts, and tolerance stack ups.

FIND GD&T RESOURCES ON THE FOLLOWING TOPICS:

- Fundamentals of GD&T
- Advanced Concepts
- Tolerance Stack Ups
- ISO Standards
- ASME Standards

NOW AVAILABLE—AN EVEN BROADER ARRAY OF GD&T EDUCATION

We are very pleased to offer you an even broader array of GD&T resources. Take advantage of professional development seminars and learning tools developed by globally recognized GD&T expert and ETI Founder Alex Krulikowski. Mr. Krulikowski is a member of ASME and ISO standards activities and a leader in the definition and application of GD&T principles.

Train your whole team. Bring an expert instructor to your site to conduct hands-on GD&T training for your whole team. All of our classroom courses can be customized to include your drawings and parts. Contact ETI Sales to learn more about bring GD&T training to your location - +1.800.886.0909 or sales@etinews.com

Thousands of professionals have learned GD&T through ETI's resources—textbooks, self-study courses, computer-based training, and the online learning center. Performance-based applications oriented GD&T learning from SAE and ETI provide real skills and knowledge you can use immediately on-the-job.

COURSE REGISTRATION AND PRODUCT ORDERING

To place a product order or register for a course:

- Visit etinews.com or follow the links at the bottom of each product or course page
- Contact ETI Sales at +1.800.886.0909 or sales@etinews.com;
- Call SAE Customer Service at +1.877.606.7323 (US or Canada), +1.724.776.4970, or email CustomerService@sae.org.

The content in this resource guide reflects the most accurate information available at the time of publication. Rarely, unforeseen circumstances may force a change to the availability and/or description of these products. For the most up-to-date listing of products and learning resources, visit etinews.com. ETI and its parent company SAE International reserve the right to cancel product offerings.

THE LEVELS OF GD&T PROFICIENCY

We recommend taking GD&T training in this order. Utilize our mentoring and consulting services to reinforce training on-the-job.

Contact ETI for more information on GD&T training and resources +1.800.886.0909 or visit etinews.com.

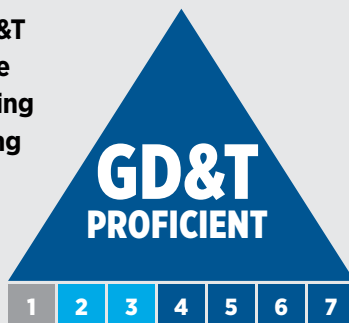

CRITICAL CONCEPTS OF TOLERANCE STACKS

Understand the six critical concepts of tolerance stacks. Analyze the cumulative effect of tolerances to create tolerances on parts and assemblies. Learn an in-depth explanation of how to use tolerance stacks to analyze product designs and how to use geometric tolerances in stacks. Learn the essential methods and concepts used for creating 1D part and assembly tolerance stacks.

GD&T APPLICATIONS USING COMPANY DRAWINGS

Apply GD&T to drawing and convert product requirements into GD&T specifications. Learn how to do a design function analysis on a part assembly and specify GD&T on assembly components.

GD&T FUNDAMENTALS

Understand part requirements and interpret common GD&T specifications on drawings using critical thinking skills. An in-depth explanation of geometric tolerancing symbols, their tolerance zones, applicable modifiers, common applications, and limitations.

PREREQUISITES: Engineering Drawing Requirements

7

MENTORING

6

STATISTICAL TOLERANCE STACKS

Apply statistical methods (RSS, realistic, RPL and Monte Carlo methods) to tolerance stacks.

PREREQUISITES: Critical Concepts of Tolerance Stacks

5

GD&T ADVANCED CONCEPTS

Understand part requirements and interpret complex GD&T specifications on drawings. An emphasis on non-rigid parts; learn to create statements of complex relationships through simultaneous requirements, composite and multiple single-segment tolerances. In-depth explanation of geometric tolerancing symbols, their tolerance zones, applicable modifiers, common applications, and limitations.

4

3

ENGINEERING DRAWING REQUIREMENTS

A basic class that is useful for all drawing creators and users. Overview course teaches correct interpretation of engineering drawings and covers drawing standards, drawing types, format, views and surface textures.

PREREQUISITES: Basic understanding of engineering drawings

2

1

TABLE OF CONTENTS

03 TEXTBOOKS

- 03 Fundamentals of Geometric Dimensioning and Tolerancing Using Critical Thinking Skills (based on ASME Y14.5-2009)
- 04 Fundamentals of Geometric Dimensioning and Tolerancing (based on ASME Y14.5M-1994)
- 05 Advanced Concepts of Geometric Dimensioning and Tolerancing
- 06 Tolerance Stacks Using Geometric Dimensioning and Tolerancing

07 SOFTWARE

- 07 The GD&T Trainer: Fundamentals 2009
- 08 The GD&T Trainer: Fundamentals 1994
- 09 The ETI eLearning System
- 10 ISO GPS Quick Reference

11 WORKBOOKS

- 11 Fundamentals of Geometric Dimensioning and Tolerancing Video Training Program – Video Workbook
- 12 GD&T Workbook with Engineering Drawings
- 13 Fundamentals of GD&T Self-Study Workbook
- 14 Tolerance Stacks Self-Study Course

15 REFERENCE

- 15 Alex Krulikowski's ISO Geometrical Tolerancing Reference Guide
- 16 ASME Y14.5M-1994 to ASME Y14.5-2009 New Features Comparison Chart
- 16 ASME Y14.5M-1994 Reference Chart
- 17 The Ultimate GD&T Pocket Guide (based on ASME Y14.5-2009)
- 17 The Ultimate GD&T Pocket Guide (based on ASME Y14.5M-1994)
- 17 ISO GPS Ultimate Pocket Guide (based on 1101:2012)

18 PROFESSIONAL DEVELOPMENT SEMINARS

- 18 Critical Concepts of Tolerance Stacks - Based on ASME Y14.5-2009
- 19 Introduction to Statistical Tolerance Stacks Seminar
- 20 Applications of GD&T Seminar
- 21 Fundamentals of GD&T 2009 Seminar
- 22 Functional Gaging and Measurement Seminar
- 23 Fundamentals of GD&T 1994 Seminar
- 24 Engineering Drawing Requirements Seminar
- 26 GD&T for Manufacturing Seminar
- 28 Advanced Concepts of GD&T 1994 Seminar
- 30 Tolerance Stacks Using GD&T 1994 Seminar
- 32 Fundamentals of GD&T For Inspectors Seminar
- 34 Solid Model Tolerancing Seminar
- 35 ASME/ISO Standards Comparison Seminar
- 36 ISO Geometrical Tolerancing Seminar
- 38 Fundamentals of GD&T 2009 Seminar
- 40 ASME Y14.5 1994-2009 Comparison Seminar

TEXTBOOKS

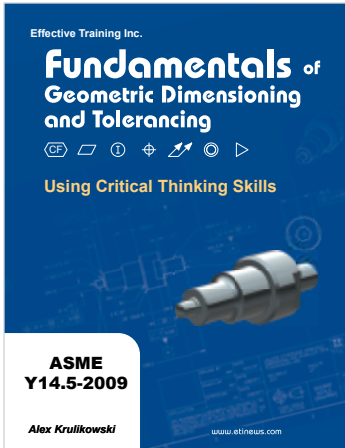

Fundamentals of Geometric Dimensioning and Tolerancing Using Critical Thinking Skills

(based on ASME Y14.5-2009)

3rd Edition

By Alex Krulikowski

A unique book that meets the needs of readers studying industrial technology, CAD, engineering technology, or manufacturing technology.

This book clearly organizes geometric dimensioning and tolerancing fundamentals into small, logical units for step-by-step understanding.

Measurable performance objectives help readers assess their progress. Discussion questions promote interaction and higher-order thinking, and practice problems ensure thorough understanding of the concepts presented.

Fundamentals of Geometric Dimensioning and Tolerancing Using Critical Thinking Skills (based on ASME Y14.5-2009) 3rd Edition defines and fully encompasses the ASME Y14.5-2009 Standard to keep readers current on these important industry standards.

ISBN: 978-1111129828

448 pp.

Paperbound 2013

\$133.00 List

Product Code PD021101

THIS BOOK IS A VALUABLE TOOL FOR:

- Designers
- Product, Manufacturing, and Quality Engineers
- CMM Operators
- Checkers

SKILL LEVEL

A basic understanding of engineering drawings is required.

[etineus.com/
products/textbooks/](http://etineus.com/products/textbooks/)

TEXTBOOKS

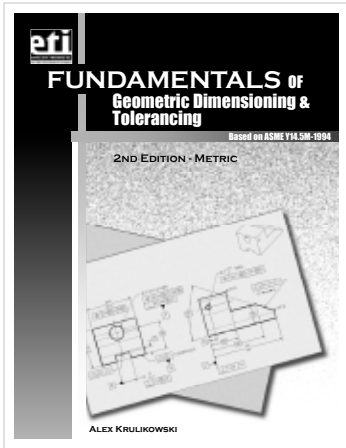

A unique book that meets the needs of readers studying industrial technology, CAD, engineering technology, or manufacturing technology.

This book clearly organizes geometric dimensioning and tolerancing fundamentals into small, logical units for step-by-step understanding.

Measurable performance objectives help readers assess their progress. Discussion questions promote interaction and higher-order thinking, and practice problems ensure thorough understanding of the concepts presented.

Fundamentals of Geometric Dimensioning and Tolerancing (*based on ASME Y14.5M-1994*) 2nd Edition defines and fully encompasses ASME Y14.5M-1994 to keep readers current on this important industry standard.

Fundamentals of Geometric Dimensioning and Tolerancing

(*based on ASME Y14.5M-1994*)

2nd Edition

By Alex Krulikowski

391 pp.
Spiral Bound 2012
\$91.50 List
Product Code PD024001

THIS BOOK IS A VALUABLE TOOL FOR:

- Designers
- Product, Manufacturing, and Quality Engineers
- CMM Operators
- Checkers

SKILL LEVEL

A basic understanding of engineering drawings is required.

[etnews.com/
products/textbooks/](http://etnews.com/products/textbooks/)

TEXTBOOKS



Advanced Concepts of Geometric Dimensioning and Tolerancing

(based on ASME Y14.5M-1994)

2nd Edition

By Alex Krulikowski

This reference book stresses the application of GD&T in today's industrial workplace, and it's the perfect resource to expand and deepen your understanding of GD&T.

Advanced Concepts of Geometric Dimensioning and Tolerancing includes examples and explanations of tolerancing concepts that are often problematic in real world applications.

This must-have text features 26 chapters that cover a broad range of tolerancing practices common in industry, but not well documented in national standards. Topics include:

- Tolerancing non-rigid parts
- Position, profile, and datums
- Functional dimensioning
- Drawing interpretation
- Advantages and misconceptions of the datum system
- Relating tolerance applications to a loss function curve
- Tolerancing of threaded holes
- Composite position tolerancing
- Profile applications

ISBN: 0-924520-25-6

360 pp.

Spiral Bound 2007

\$83.50 List

Product Code PD024016

THIS BOOK IS A VALUABLE TOOL FOR:

- Designers
- Product, Manufacturing, and Quality Engineers
- CMM Operators
- Checkers

SKILL LEVEL

It is intended for those who have mastered the fundamental concepts of GD&T and are ready to take this knowledge into a more applications-oriented setting.

[etinews.com/
products/textbooks/](https://www.etinews.com/products/textbooks/)

TEXTBOOKS

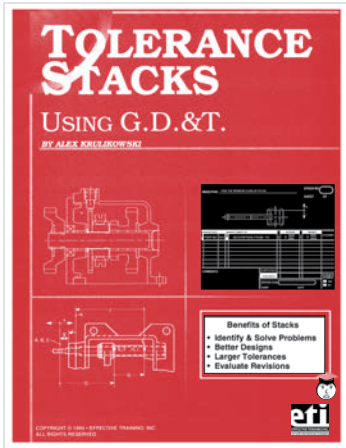

Tolerance Stacks Using Geometric Dimensioning and Tolerancing with Drawing Package

By Alex Krulikowski

Proficiency in tolerance accumulation studies (also called stacks) separates the exceptional engineers from the rest.

More than simply the study of dimensional relationships within assemblies, tolerance stacks are the key to creating robust, efficient, and successful designs.

Tolerance Stacks Using Geometric Dimensioning and Tolerancing covers the techniques used to assess and convey the effects of variation and stresses typical applications found in real-world industrial situations.

In addition to the textbook, this unique package includes the Tolerance Stacks Drawing Package, a spiral-bound booklet containing two complete product designs to analyze and reinforce information provided in the text.

Tolerance Stacks Using Geometric Dimensioning and Tolerancing is intended as a course in geometric tolerancing.

ISBN: 0-924520-05-1

276 pp.

Spiral Bound 1994

\$105.00 List

Product Code PD021019

THIS BOOK IS A VALUABLE TOOL FOR:

- Engineers
- Designers
- Inspectors
- Process Engineers
- Machine Builders
- Similar job functions

SKILL LEVEL

Basic blueprint reading skills are required; must have also completed courses in GD&T fundamentals and advanced concepts.

[etinews.com/
products/textbooks/](http://etinews.com/products/textbooks/)

SOFTWARE



The GD&T Trainer: Fundamentals 2009 is a comprehensive training program consisting of 29 lessons covering basic rules, definitions, and concepts of GD&T.

This software package contains newly updated course administration tools with enhanced student progress tracking capabilities as well as:

- Student/course records storage
- Learning assessments
- 2,000 student maximum capacity on LAN seat and multi-user versions
- Simultaneous record access for multiple administrators
- Report generator to track student and course progression
- Password protection for student records
- And much more

COURSE FORMATS

- A complete course in GD&T including quizzes, final exam, and certificate of completion
- A geometric tolerancing seminar
- A supplement or review for live training
- An internal GD&T certification
- An on-the-job reference

The GD&T Trainer: Fundamentals 2009

(based on ASME Y14.5-2009)

Starting at \$755.00 List

Product Code PD021249

SKILL LEVEL

Users should have completed ETI's Engineering Drawing Requirements course or use drawings regularly on the job.

VERSIONS

- Single-User
- Multi-User
- LAN (local area network)
- Corporate

SYSTEM REQUIREMENTS

- Pentium 4-based computer with a 2GHz or higher CPU
- 512 MB RAM minimum, 1024 MB or higher recommended
- 500 MB or more of free hard drive space
- Sound card with speakers
- Video card capable of displaying 24-bit color at a resolution of 1024x768
- Windows 7/8
- Adobe Flash Player 13.0 or higher
- Visual Basic 6 Runtime (Admin and Reporter only)
- .NET Framework 2.0

[etinews.com/
products/software/](http://etinews.com/products/software/)

SOFTWARE



The GD&T Trainer: Fundamentals 1994 is a comprehensive training program consisting of 28 lessons covering basic rules, definitions, and concepts of GD&T.

This software package features newly updated administration tools for tracking student progress as well as:

- Student course record storage
- Learning assessments
- 2,000 student maximum capacity on LAN seat and multi-user versions
- Simultaneous records access for multiple administrators
- Report generator and database access to track student progression
- Password protection for student records
- And much more

COURSE FORMATS

- A complete course in GD&T including quizzes, final exam, and certificate of completion
- A geometric tolerancing seminar
- A supplement or review for live training
- An internal GD&T certification
- An on-the-job reference

The GD&T Trainer: Fundamentals 1994

(based on ASME Y14.5M-1994)

Starting at \$775.00 List
Product Code PD025073

SKILL LEVEL

Users should have completed ETI's Engineering Drawing Requirements course or use drawings regularly on the job.

VERSIONS

- Single User
- Multi-User
- LAN (local area network)
- Corporate

SYSTEM REQUIREMENTS

- Pentium III-based computer with a 1GHz or higher CPU
- 256 MB RAM minimum/512 MB or higher recommended
- 1 GB minimum of free hard drive space
- Sound card with speakers
- Video card capable of displaying 24-bit color at a resolution of 1024x768
- Windows XP (SP2)/XP/64-bit/Vista/7
- Adobe Flash Player 10.0 or higher
- Visual Basic 6 Runtime (Admin and Reporter only)
- .NET Framework 2.0

NOTE: Windows 3.x/98/ME/2000 are not supported

[etinews.com/
products/software/](http://etinews.com/products/software/)

SOFTWARE



The ETI eLearning System is the ideal software package for anyone considering or currently operating in a multi-standard environment.

Users will receive all the same benefits as each of our individual GD&T trainer packages as well as:

- Three fully interactive, narrated courses
 - Fundamentals of GD&T (2009)
 - Fundamentals of GD&T (1994)
 - ASME Y14.5 Standard Comparison
- Over 60 significant revisions, additions, and deletions
- Student/course record storage
- Digital Design Dictionary
- A copy of the Ultimate GD&T Pocket Guide
- And much more.

COURSE FORMATS

- A complete course in GD&T including quizzes, final exam, and certificate of completion
- A geometric tolerancing seminar
- A supplement or review for live training
- Post training content review
- An internal GD&T certification
- An on-the-job reference

The ETI eLearning System

(based on ASME Y14.5M-1994 & ASME Y14.5-2009)

Call for your custom quote

Product Code PD021201

SKILL LEVEL

Users should have completed ETI's Engineering Drawing Requirements course or use drawings regularly on the job.

VERSIONS

- LAN (local area network)
- Corporate

SYSTEM REQUIREMENTS

- Pentium 4-based computer with a 2GHz or higher CPU
- 512 MB RAM minimum/1024 MB or higher recommended
- 4 GB or more of free hard drive space
- Sound card with speakers
- Video card capable of displaying 24-bit color at a resolution of 1024x768
- Windows XP/XP Professional/64-bit/Vista/7
- Adobe Flash Player 10.0 or higher
- Visual Basic 6 Runtime (Admin and Reporter only)
- .NET Framework 2.0

[www.etinews.com/
products/software/](http://www.etinews.com/products/software/)

SOFTWARE



The ISO GPS Quick Reference software is a valuable on-the-job resource for locating technical drawing information without navigating through multiple standards.

The ISO GPS Quick Reference software covers more than 250 related topics with full-color drawings and illustrations, and user-friendly navigation for easy transition between topics.

The program is based on four major ISO GPS standards:

- ISO 8015:1985
- ISO 1101: 2004
- ISO 2768-1: 1989
- ISO 2768-2: 1998

plus more than 40 related standards.

The ISO GPS Quick Reference software is a valuable tool for anyone who creates or interprets engineering drawings.

Site and corporate licenses are available.

ISO GPS Quick Reference

(based on ISO 8015:1985, ISO 1101:2004, ISO 2768-1:1989, ISO 2768-2:1998, plus over 40 additional related standards)

Starting at \$1200.00 List
Product Code PD027201

SKILL LEVEL

Users should have completed ETI's Engineering Drawing Requirements course or use drawings regularly on the job.

VERSIONS

- LAN 2-seat (up to 10 seats)
- Corporate

SYSTEM REQUIREMENTS

- Pentium 4-based computer with a 2GHz or higher CPU
- 512 MB RAM minimum/1024 MB or higher recommended
- 4 GB minimum of free hard drive space
- Video card capable of displaying 24-bit color at a resolution of 1024x768
- Windows XP (SP2)/XP/Professional 64-bit/Vista/7
- Adobe Flash Player 10.0 or higher

[www.etinews.com/
products/software/](http://www.etinews.com/products/software/)

WORKBOOKS

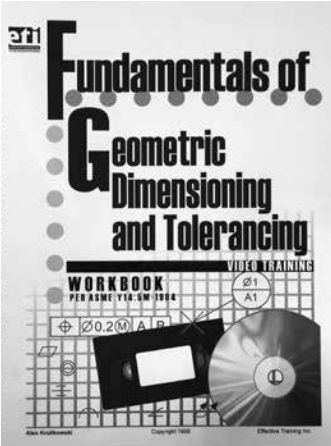

This unique self-study course is designed as a supplement to the Fundamentals of GD&T Video Training Package (ask your ETI sales representative for details).

The GD&T Video Workbook contains 30 exercises and over 300 questions on the fundamentals of geometric tolerancing. Diagrams, tips, charts, and key points correspond to its companion video to provide reinforcement of concepts learned in each section. Users can gauge their comprehension through assessments included at the conclusion of each lesson.

The GD&T Video Workbook can be used as an ongoing practice and reference guide well after the initial training is complete.

Fundamentals of Geometric Dimensioning and Tolerancing Video Training Program – Video Workbook (based on ASME Y14.5M-1994)

By Alex Krulikowski

ISBN: 0-924520-35-3
Spiral Binder
Starting at \$64.00 List
Product Code PD024051

THIS BOOK IS A VALUABLE TOOL FOR:

- Designers
- Product, Manufacturing, and Quality Engineers
- CMM Operators
- Checkers

SKILL LEVEL

A basic understanding of engineering drawings is required.

[etinews.com/
products/workbooks/
gdt_workbook.html](http://etinews.com/products/workbooks/gdt_workbook.html)

WORKBOOKS

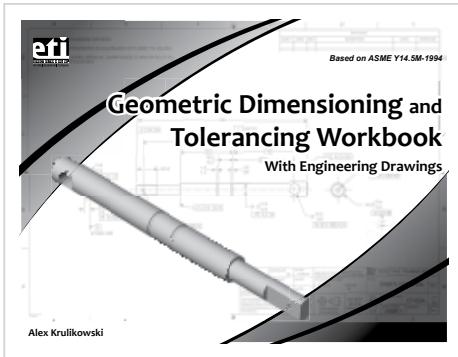

The GD&T Workbook enhances student skills through instruction and exercises on topics learned via ETI's training practicum.

A perfect companion to the Fundamentals of GD&T textbook, the GD&T Workbook can be used in the classroom as reinforcement to the ETI Fundamentals of GD&T training course, and as an ongoing practice guide after classroom training is complete.

For instructors, the Workbook is designed for use with the Fundamentals of GD&T Digital Instructor's Kit to complement lesson plans and teaching aids.

Users will gain practical experience from the GD&T Workbook with typical industrial engineering drawings through insightful questions and examples covering key terms, concepts, and interpretations.

Learning goals and objectives are clearly outlined making the GD&T Workbook the perfect supplement to your live or e-learning GD&T training.

GD&T Workbook with Engineering Drawings *(based on ASME Y14.5M-1994)*

By Alex Krulikowski

ISBN: 978-0-924520-13-6
204 pp.
Spiral Bound
\$36.00 List
Product Code PD024030

THIS BOOK IS A VALUABLE TOOL FOR:

- Designers
- Product, Manufacturing, and Quality Engineers
- CMM Operators
- Checkers

SKILL LEVEL

Student should have taken ETI's Engineering Drawing Requirements course or have a basic understanding of engineering drawings.

[etinews.com/
products/workbooks/
gdt_workbook.html](http://etinews.com/products/workbooks/gdt_workbook.html)

WORKBOOKS

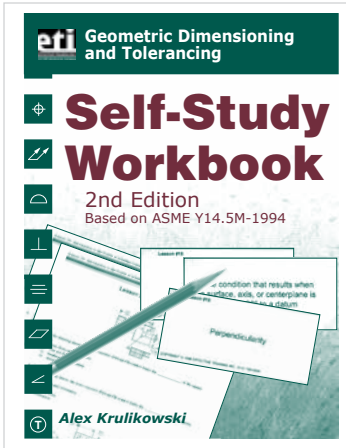

The Fundamentals of GD&T Self-Study Workbook is a popular cost-effective option for learning GD&T at your own pace.

Practical examples incorporating real world applications separate this workbook from all competitors.

The Fundamentals Self-Study Workbook's versatility goes beyond self-study and can be multi-purposed for team learning.

Users will find useful charts, diagrams, innumerable tips and suggestions, assessments, and other learning resources to maximize your learning objectives.

The Fundamentals of GD&T Self-Study Workbook package also comes complete with 30 targeted lessons, self-study flash cards, and pre- and post tests to measure and track learning goals.

The Fundamentals of GD&T Self-Study Workbook 2nd Edition is also available in Spanish.

Fundamentals of GD&T Self-Study Workbook *(based on ASME Y14.5-1994)*

2nd Edition
By Alex Krulikowski

also available
Fundamentals of GD&T Self-Study Workbook
Spanish Edition
Product Code PD024004

ISBN: 09245420-01-9,
Part 4002
570 pp.
Spiral Bound
Starting at \$170.00 List
Product Code PD024002

THIS BOOK IS A VALUABLE TOOL FOR:

- Designers
- Product, Manufacturing, and Quality Engineers
- Technicians
- Purchasers
- Checkers

SKILL LEVEL

A basic understanding of engineering drawings is required.

[etinews.com/
products/workbooks/
self_study_workbook.html](http://etinews.com/products/workbooks/self_study_workbook.html)

WORKBOOKS

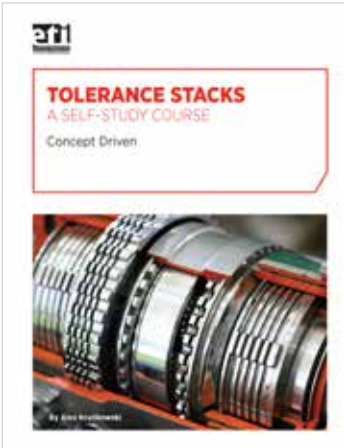

This unique all-in-one self-study course comes delivered in a multi-volume package and is intended as a course in geometrical tolerancing.

Each unique volume stresses applications that are found on the job in real world industrial situations. Practice tools replicate actual drawings to maximize knowledge transfer from the training room to the jobsite.

Volume 1 formally outlines the importance of stacks as it relates to product design, the course format, and also offers useful tips on setting personal goals to maximize user's learning habits.

Volume 2 contains 25 practice stacks based on the ETI Drawing Package (included), progress charts, helpful tips, and solutions to gauge user's learning progression.

Additional package items include a Stacks Summary Chart and blank stacks forms for use in documenting practice content.

Tolerance Stacks Self Study Course - Concept Driven

By Alex Krulikowski

ISBN: 0-924520-03-5
Part 1005
Multiple Packaging
Starting at \$210.00 List
Product Code PD021005

THIS BOOK IS A VALUABLE TOOL FOR:

- Designers
- Product, Manufacturing, and Quality Engineers
- Inspectors
- Machine Builders

SKILL LEVEL

Basic understanding of engineering drawings is required; must have also completed courses in GD&T fundamentals and advanced concepts.

[etinews.com/
products/workbooks/
tolerance_self_study_
course.html](http://etinews.com/products/workbooks/tolerance_self_study_course.html)

REFERENCE

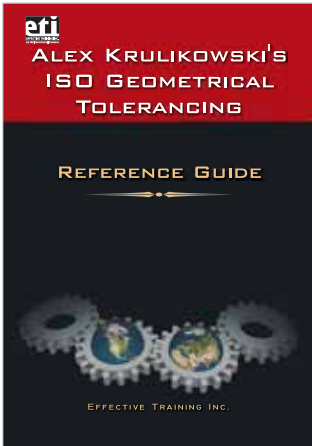

Alex Krulikowski's ISO Geometrical Tolerancing Reference Guide

By Alex Krulikowski

The ISO Geometrical Tolerancing Reference Guide clarifies interpreting standard-compliant technical drawings that use ISO 1101:2004 and its companion published standards.

It guides the user as to which ISO standards should be referenced on a drawing and what the standards cover.

The book includes several features to help the reader find information quickly:

- A visual index inside the front cover
- Individual table of contents for each section
- Indexed page edges for each section
- Numerous cross-references
- A comprehensive alphabetical index
- A glossary of more than 100 terms
- More than 250 endnotes that reference ISO standards with clauses that support concepts
- Numerous authors' comments provide insights about concepts
- Hidden spiral binding allows it to lay flat for ease of use
- Comprehensive reference charts and drawings inside the foldout covers offer easy access to critical often-used information

ISBN: 978-0-924520-17-4
376 pp.
Spiral Bound 2010
\$110.00 List
Product Code PD027101

THIS BOOK IS A VALUABLE TOOL FOR:

- Engineers
- Designers
- Inspectors
- Machinists

[etinews.com/
products/reference/](http://etinews.com/products/reference/)

REFERENCE



ASME Y14.5M-1994 to
ASME Y14.5-2009 New
Features Comparison Chart



ASME Y14.5M-1994
Reference Chart

Compare the features of ASME Y14.5M-1994 and ASME Y14.5-2009 quickly and easily with the New Features Comparison Chart Set.

Each chart contains a fully illustrated breakdown of changes in the standard for quick, on-the-job drawing interpretation.

These easy-to-read charts are the ideal tools for the working designer, engineer and design manager.

Order one or multiple copies for your home, office and/or remote jobsite.

ASME Y14.5M-1994 to ASME Y14.5-2009 New Features Comparison Chart

(based on ASME Y14.5-2009)

ISBN: 978-0-924520-22-8

(2) 11"x17"

\$13.00 List

Product Code PD021030

ASME Y14.5M-1994 Reference Chart

ISBN: 0-924520-12-4

(1) 11"x17"

\$5.50 List

Product Code PD024012

[etinews.com/
products/charts/](http://etinews.com/products/charts/)

GEOMETRIC DIMENSIONING AND TOLERANCING (GD&T) TRAINING, PRODUCTS, AND SERVICES

GD&T is an international language used on engineering drawings. By providing uniformity in drawing specifications and interpretation, geometric tolerancing reduces controversy, guesswork, and assumptions throughout the manufacturing and inspection process. GD&T used properly improves communication, results in better product design, and increases product tolerances. It can save your organization time and money.

Let ETI provide GD&T training and materials for your organization.

Contact ETI Sales at +1.800.886.0909 or sales@etinews.com or SAE Customer Service at +1.877.606.7323 (US or Canada), +1.724.776.4970, or CustomerService@sae.org.

REFERENCE

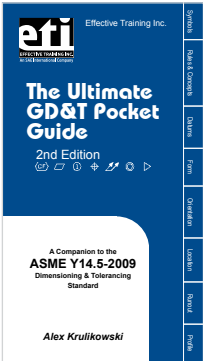

The Ultimate GD&T Pocket Guide based on ASME Y14.5-2009

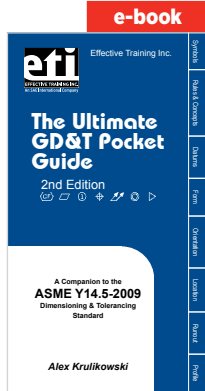

The Ultimate GD&T Pocket Guide (based on ASME Y14.5-2009) Kindle Edition (e-book)

The Ultimate GD&T Pocket Guide
(based on ASME Y14.5-2009)
 2nd Edition
 ISBN: 978-0-924520-23-5
 Spiral Bound
 122 pp.
\$20.00 List
 Product Code PD024070

Kindle Edition (e-book)
 ISBN: 978-0-924520-23-5
\$9.99 List

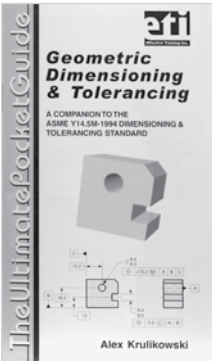

The Ultimate GD&T Pocket Guide (based on ASME Y14.5M-1994)



The Ultimate GD&T Pocket Guide (based on ASME Y14.5M-1994) - Spanish Edition

The Ultimate GD&T Pocket Guide
(based on ASME Y14.5M-1994)
 ISBN: 0-924520-14-0 Part 4071
 Saddlestich
 77 pp.
\$12.00 List
 Product Code PD024071

Spanish Edition
 ISBN: 0-924520-14-0 Part 4072
\$12.00 List
 Product Code PD024072

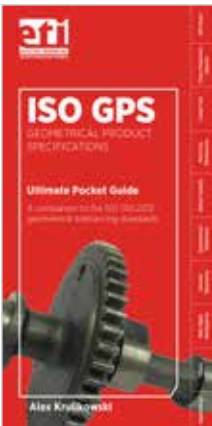

ISO GPS Ultimate Pocket Guide (based on ISO 1101:2012)

The Ultimate GD&T Pocket Guides are the perfect on-the-job reference tools for anyone who uses GD&T on the job or in the classroom.

Each guide delivers a wealth of concise practical information on current ASME Standards and GD&T topics through helpful tips, charts and detailed illustrations for easy reference.

Use The Ultimate GD&T Pocket Guides to reference datum applications, conversion charts, formulas, tolerancing, and much more.

The ISO GPS Ultimate GD&T Pocket Guide
(A companion to the ISO 1101:2012 geometrical tolerancing standards)
 ISBN: 978-0-7680-8258-6
 Spiral Bound
\$39.95 List
 Product Code PD027104

eBook Edition
\$39.95 List

etinews.com/products/reference/

NEW! CRITICAL CONCEPTS OF TOLERANCE STACKS - BASED ON ASME Y14.5-2009



Get an in-depth explanation in the use of tolerance stacks in analysis of product designs and the use of geometric tolerances in stacks. Learn essential methods and concepts used for creating 1D part and assembly stacks. This course uses the expertise of world-renowned GD&T expert Alex Krulikowski and features practice problems and in-depth coverage of tolerance stacks applications. A good understanding of GD&T based on the ASME Y14.5-2009 through work experience or participation in a GD&T training course is a must. Basics of GD&T will not be covered in this course.

LEARNING OBJECTIVES

By attending this seminar, you will be able to:

- Describe how virtual condition affects the assembly of parts
- Explain the importance of tolerance stacks and be familiar with stack methods, the stack form and the stack spreadsheet
- Calculate part stacks using coordinate dimensions, runout and concentricity, profile tolerances, multiple geometric tolerances, position tolerances at RFS and MMC/MMB
- Calculate assembly stacks using coordinate dimensions, runout and concentricity, bilateral and unilateral profile tolerances, multiple geometric tolerances, position tolerances at MMC/MMB
- Calculate stacks using form and orientation applied to features and features of size

WHO SHOULD ATTEND

Individuals who create or interpret engineering drawings; product and gage designers; process, product, and manufacturing engineers; supplier quality engineers/professionals; CMM operators; and checkers.

CONTENT HIGHLIGHTS

- Introduction to Tolerance Stacks
- Introduction to 1D Stack Methods
- ETI Stack Form and Spreadsheet
- Position tolerances at MMB - Basics of datum shift & datum shift exceptions
- Part Stacks and Assembly Stacks Using: coordinate dimensions; runout tolerances; profile tolerances; position tolerances
- Six critical concepts of tolerance stacks

INSTRUCTOR

See course web page for instructor information.

Each attendee receives a robust collection of learning resources including:

- A copy of *Critical Concepts of Tolerance Stacks* course book
- A Tolerance Stacks Drawing Package
- An Excel tolerance stack spreadsheet template
- A Tolerance Stacks Summary Chart and Exercise Workbook

I.D.# ET1701

SCHEDULE

View scheduled offerings at the course web page.

FEES

List \$1,280

Members

Classic \$1,152

Premium \$1,088

Elite \$1,024

TWO-DAYS /1.3 CEUS

Get the complete course description and register:
training.sae.org/seminars/et1701/

INTRODUCTION TO STATISTICAL TOLERANCE STACKS



This course teaches an introduction to statistical tolerance stacks, a crucial skill in today's competitive workplace. Utilizing the expertise of world-renowned GD&T expert Alex Krulikowski, the course includes a brief overview of several terms used in statistical stacks. It explains four methods for applying statistics to tolerance stacks and covers precautions about when and how to use statistics in stacks. Newly acquired learning is reinforced throughout the class with stacks that allow the student to practice applying statistical methods.

LEARNING OBJECTIVES

By participating in this seminar, you will be able to:

- Define the terminology used with statistical tolerance stacks
- Describe common statistical tolerance stacks methods
- Calculate statistical tolerance stacks using the RSS method
- Calculate statistical tolerance stacks using the realistic method
- Apply the RPL method to statistical tolerance stacks
- Apply the Monte Carlo method to tolerance stacks
- Describe precautions needed when using statistical tolerance stacks

WHO SHOULD ATTEND

This course is valuable for individuals who create or interpret engineering drawings, product and gage designers; process, product, and manufacturing engineers; supplier quality engineers/professionals; CMM operators; buyers/purchasers; checkers; inspectors; technicians; and sales engineers/professionals.

CONTENT HIGHLIGHTS

- Importance of statistical stacks
- Statistical stacks terminology
- Common statistical tolerance stacks methods
- The ETI statistical stack form
- The RPL statistical stack method
- The Six Sigma DRSS statistical method
- The Monte Carlo statistical simulation method
- Statistical tolerance stacks precautions
- DRSS and RPL statistical stack calculations

INSTRUCTOR

See course web page for instructor information.

Each attendee receives a robust collection of learning resources including:

- A copy of *Introduction to Statistical Tolerance Stacks* workbook, by Alex Krulikowski
- Class handouts

I.D.# ET2055

SCHEDULE

View scheduled offerings at the course web page.

FEES

List	\$770
Members	
Classic	\$693
Premium	\$655
Elite	\$616

ONE-DAY/.7 CEUS

Get the complete course description and register:
training.sae.org/seminars/et2055/



APPLICATIONS OF GD&T



Learn the thought processes involved in assigning GD&T to components. This course focuses on what constitutes good and poor drawing practices, common dimensioning methods used in industry, using GD&T to communicate system functions on component dimensions, and the logic of applying GD&T to components. Performing a design function analysis on a part assembly drawing then specifying GD&T on assembly components will reinforce newly acquired learning.

LEARNING OBJECTIVES

By participating in this seminar, you will be able to:

- Describe the importance of technically correct drawings
- List three major areas that affect the creation and interpretation of technically correct drawings
- Explain the common approaches to part tolerancing
- Identify and specify datum features based on the fit and functional requirements of the part
- Use GD&T to communicate functional requirements of a component
- Describe how to specify nonfunctional dimensions
- Explain the five-step approach to functionally dimensioning a component
- Apply the five-step method to functionally dimensioning a component to your company product

WHO SHOULD ATTEND

This course is designed for product engineers, designers, checkers, and engineering managers, and supplier quality engineers.

CONTENT HIGHLIGHTS

- Importance of technically correct drawings
- Principles and guidelines for making technically correct drawings
- Common approaches to part tolerancing
- Specifying datums based on mounting and performing features
- Using GD&T to describe functional relationships on a component
- Specifying secondary (nonfunctional) dimensions
- The five-step approach to functionally dimensioning a component
- Applying the five-step approach to functionally dimensioning a component

INSTRUCTOR

See course web page for instructor information.

Each attendee receives a robust collection of learning resources including:

- A copy of *Applications of GD&T Exercise Workbook*, by Alex Krulikowski
- Class handouts incl. course notes & drawing handouts
- 30-day access to 1994 Fundamentals of GD&T web training

PREREQUISITES

In order to understand the course content, students should have complete 16 hours of formalized classroom training in GD&T or ETI's Fundamentals of GD&T course. You should also have experience interpreting or applying GD&T in an industrial setting and working knowledge of the ASME Y14.5-2009 Standard.

I.D.# ET2512

SCHEDULE

View scheduled offerings at the course web page.

FEES

List	\$1,280
Members	
Classic	\$1,152
Premium	\$1,088
Elite	\$1,024

TWO-DAYS/1.3 CEUS

Get the complete course description and register:
training.sae.org/seminars/et2512/



FUNDAMENTALS OF GD&T 2009



This course teaches the terms, rules, symbols, and concepts of GD&T as prescribed in the ASME Y14.5-2009 Standard. It offers an in-depth explanation of geometric tolerancing symbols, their tolerance zones, applicable modifiers, common applications, and limitations. The class includes a comparison of GD&T to coordinate tolerancing; Rules #1 and #2; form and orientation controls; tolerance of position; runout and profile controls. It is up to date with the new 2009 standard and explains all the new rules and symbols.

LEARNING OBJECTIVES

By participating in this seminar, you will be able to:

- Explain the importance of standards on engineering drawings
- Describe the types of dimensions, tolerances, and notes
- Explain why geometric tolerancing is superior to coordinate tolerancing
- Interpret the general dimensioning symbols
- Define the key terms used in GD&T
- Recognize the symbols and modifiers used in GD&T
- Explain the rules used in GD&T
- Describe the concepts of worst-case boundary, virtual condition, and bonus tolerance
- Interpret the various types of tolerance (flatness, circularity, cylindricity, straightness, perpendicularity, parallelism, angularity, position, runout, and profile)
- Describe the datum system
- Interpret applications of datum targets, size datum features (RMB), and size datum features (MMB)

WHO SHOULD ATTEND

This course is valuable for individuals who create or interpret engineering drawings, product and gage designers; process, product, and manufacturing engineers; supplier quality engineers/professionals; CMM operators; buyers/purchasers; checkers; inspectors; technicians; and sales engineers/professionals.

CONTENT HIGHLIGHTS

- Fundamentals
- Form
- Datum System
- Orientation
- Position
- Runout, Concentricity, Symmetry
- Profile

INSTRUCTOR

See course web page for instructor information.

Each attendee receives a robust collection of learning resources including:

- The *Fundamentals of GD&T Using Critical Thinking Skills* (ASME Y14.5-2009) textbook by Alex Krulikowski
- A GD&T Ultimate Pocket Guide (2009)
- 30-day access to Fundamentals of GD&T 2009 web training course to practice and reinforce what was learned in the classroom

I.D.# ET1150

SCHEDULE

View scheduled offerings at the course web page.

FEES

List	\$1,280
Members	
Classic	\$1,152
Premium	\$1,088
Elite	\$1,024

TWO-DAYS/1.3 CEUS

Get the complete course description and register:
training.sae.org/seminars/et1150/



FUNCTIONAL GAGING AND MEASUREMENT



Get an introduction to functional gaging design and how to verify part dimensional requirements using functional gages and other measurement methods. This course offers an explanation of metrology, the roles of the metrologist and inspector, measurement uncertainty, inspection tools, functional gages, inspection planning and reporting, and simulating datums.

LEARNING OBJECTIVES

By participating in this seminar, you will be able to:

- Describe the functions of inspection in an organization
- Define what measurement uncertainty is.
- Explain the basic operating principles, strengths, and weaknesses of the three major categories of inspection tools
- List the types, uses, and tolerance methods for attribute gages
- Explain attribute gage design fundamentals
- Develop a measurement / inspection plan
- Describe the purpose and content of an inspection report
- Inspect and report size dimensions
- Describe the basic concepts of datums related to inspection
- Understand how to simulate datums for inspection
- Verify flatness, straightness, circularity, cylindricity, orientation, position, runout, profile of a surface, and profile of a line tolerance requirements

WHO SHOULD ATTEND

This seminar is a valuable tool for individuals who inspect parts, create inspection plans, or approve inspection methods.

CONTENT HIGHLIGHTS

- Inspection in an Organization
- Introduction to Measurement Uncertainty
- Three Major Categories of Inspection Equipment
- Attribute Gaging Concepts and Design Fundamentals
- Benefits of RMB Datum Feature Simulation
- Inspection Reporting
- Inspecting and Reporting Size Dimensions
- Datums Related to Inspection
- Simulating Datums for Inspection
- Verifying Tolerance Requirements for:
Straightness, Circularity & Cylindricity,
Orientation, Position, Circularity & Total Runout,
and Profile of a Surface and Profile of a Line

INSTRUCTOR

See course web page for instructor information.

PREREQUISITES

Please be aware that this is not an introductory course. In order to understand the course content, you should have:

1. Completed 16 hours of formalized classroom training in GD&T
2. Experience interpreting or applying GD&T in an industrial setting
3. Have a working knowledge of the ASME Y14.5-2009 Standard

A certificate from the GD&T Trainer: Fundamentals 2009 or ETI's Fundamentals of GD&T course is acceptable.

I.D.# ET8200

SCHEDULE

View scheduled offerings at the course web page.

FEES

List \$1,250

Members

Classic \$1,125

Premium \$1,063

Elite \$1,000

TWO-DAYS/1.3 CEUS

Get the complete course description and register:

training.sae.org/seminars/et8200/



FUNDAMENTALS OF GD&T 1994



This course teaches the terms, rules, symbols, and concepts of GD&T as outlined in the ASME Y14.5M-1994 Standard; and offers an in-depth explanation of geometric symbols, including each symbol's requirements, tolerance zones, and limitations. It also includes a comparison of GD&T to coordinate tolerancing; an explanation of tolerance zones; Rules #1 and #2; form and orientation controls; tolerance of position; runout and profile controls. Newly acquired learning is reinforced throughout the class with more than 300 practice problems.

LEARNING OBJECTIVES

By participating in this seminar, you will be able to:

- Describe what dimensioning and tolerancing is
- Describe the key terms used in geometric tolerancing
- Recognize the modifiers and symbols used in GD&T
- Explain the rules used in GD&T
- Describe the concepts of basic dimensions, worst-case boundary, virtual condition, inner and outer boundary, and bonus tolerance
- Interpret the various types of tolerances (flatness, straightness, circularity, cylindricity, perpendicularity, angularity, parallelism, position, runout, and profile)
- Describe the datum system
- Interpret applications of datum targets, feature of size datum specifications (RFS & MMC)
- Calculate tolerance of position tolerance values using the fixed and floating fastener formulas

WHO SHOULD ATTEND

Valuable for individuals who create or interpret engineering drawings, product and gage designers; process, product, and manufacturing engineers; supplier quality engineers/professionals; CMM operators; buyers/purchasers; checkers; inspectors; technicians; and sales engineers/professionals.

CONTENT HIGHLIGHTS

- Terminology
- Form Controls
- Datums
- Orientation Controls
- Tolerance of Position Controls
- Concentricity / Symmetry Controls
- Runout Controls
- Profile Controls

INSTRUCTOR

See course web page for instructor information.

Each attendee receives a robust collection of learning resources including:

- *The Fundamentals of GD&T* (ASME Y14.5M-1994) textbook, by Alex Krulikowski
- A GD&T Ultimate Pocket Guide ('94)
- *Fundamentals of GD&T Exercise Workbook* ('94)
- 30-day access to the Fundamentals of GD&T '94 web training course to practice and reinforce what was learned in the classroom

I.D.# ET2401

SCHEDULE

View scheduled offerings at the course web page.

FEES

List \$1,280

Members

Classic \$1,152

Premium \$1,088

Elite \$1,024

TWO-DAYS/1.3 CEUS

Get the complete course description and register:

training.sae.org/seminars/et2401/



ENGINEERING DRAWING REQUIREMENTS



This course teaches how to correctly interpret engineering drawings. It will improve a student's understanding of print reading and result in more effective communication on the job. Utilizing the expertise of world-renowned GD&T expert Alex Krulikowski, the course focuses on practical application of print interpretation. It will give you a better understanding of the view representation, dimensions, tolerances, and symbols used on prints.

LEARNING OBJECTIVES

By attending this class, you will be able to:

- Describe the types of engineering drawings
- Recognize common drawing formats
- Explain line conventions and lettering used on drawings
- Recognize types of drawing views
- Recognize the section views on drawings
- Describe dimensioning and tolerancing practices on drawings
- Explain surface texture standards and symbols
- Describe how weld symbols are used on drawings
- Recognize the symbols and conventions used on electronic diagrams

WHO SHOULD ATTEND

This course is valuable for individuals who create or interpret engineering drawings, product and gage designers; process, product, and manufacturing engineers; supplier quality engineers/professionals; CMM operators; buyers/purchasers; checkers; inspectors; technicians; and sales engineers/professionals.

CONTENT HIGHLIGHTS

- Engineering Drawings
- Drawing Formats
- Line Conventions and Lettering
- Drawing Views
- Section Views
- Dimensioning and Tolerancing
- Surface Texture
- Weld Symbols
- Electric and Electronic Diagrams

INSTRUCTOR

See course web page for instructor information.

Each attendee receives a robust collection of learning resources including:

- A copy of *Engineering Drawing Requirements: How to Interpret Engineering Drawings*, by Alex Krulikowski
- A GD&T Ultimate Pocket Guide
- 30-day access to Engineering Drawing Requirements based on ASME Y14.100-2004 and ASME Y14.24-1999 online training course, to practice and reinforce what was learned in the classroom

I.D.# ET2701

SCHEDULE

View scheduled offerings at the course web page.

FEES

List	\$750
Members	
Classic	\$675
Premium	\$638
Elite	\$600

ONE-DAY/.7 CEUS

Get the complete course description and register:
training.sae.org/seminars/et2701/



NEED TO TRAIN YOUR WHOLE TEAM?

Bring SAE education and training to your location. Get variety, customization, quality and convenience. SAE International Corporate Learning advisors work with you to determine the best options to meet YOUR specific training challenge AND develop solutions to fit your budget and your schedule.

Through SAE Corporate Learning Solutions you can:

- Select a SAE course for delivery at your site
- Purchase a corporate subscription for a few courses or the entire library of over 50 online courses (350+ hours of content available)

Contact SAE Corporate Learning Solutions today to discuss how SAE can best meet your training needs.

training.sae.org/corplearning

**SAE INTERNATIONAL
CORPORATE LEARNING SOLUTIONS**

training.sae.org/corplearning

Contact SAE Corporate Learning:

+1.724.772.8529 or corplearn@sae.org

GD&T FOR MANUFACTURING



Providing you have an understanding of GD&T fundamentals, this course teaches an introduction to geometric dimensioning and tolerancing and its impact on the manufacturing process. Utilizing the expertise of world-renowned GD&T expert Alex Krulikowski, the course focuses on the basic requirements of engineering drawings, size dimensions, form tolerances, and the datum system, as well as the impact of tolerancing requirements on production. Newly acquired learning is reinforced with numerous practice problems.

LEARNING OBJECTIVES

By attending this class, you will be able to:

- Understand the basic facts about engineering drawings
- Recognize the types of dimensions and tolerances used on engineering drawings
- Explain the basic concepts and requirements of size dimensions
- Answer five basic questions for interpreting form tolerances
- Describe the basic concepts of the datum system and planar datums
- Describe the basic concepts of datum targets and size datums
- Answer five basic questions for interpreting orientation, position, runout, and profile of a surface tolerances
- Explain the purpose and limitations of in-process inspection methods
- Assess the GD&T on a typical drawing and determine the impact to manufacturing

WHO SHOULD ATTEND

This course is designed for product engineers, designers, checkers, and engineering managers, and supplier quality engineers.

PREREQUISITES

Students should have completed ETI's Engineering Drawing Requirements course or equivalent.

Each attendee receives a robust collection of learning resources including:

- A copy of GD&T for Manufacturing course book, by Alex Krulikowski
- A GD&T Ultimate Pocket Guide
- Class handouts
- 30-day access to Engineering Drawing Requirements based on ASME Y14.100-2004 and ASME Y14.24-1999, to practice and reinforce what was learned in the classroom

CONTENT HIGHLIGHTS

- Engineering Drawings
- Dimensions and Tolerances
- Size Dimensions
- Form Tolerances
- Datum System and Planar Datums
- Datum Targets and Size Datums
- Orientation Tolerances
- Position Tolerances
- Runout Tolerances
- Effects of a runout tolerance
- Profile of surface tolerance interpretation
- Correct specification of a profile of a surface tolerance
- In-Process Inspection
- Assessing GD&T on Your Drawings

INSTRUCTOR

See course page for more information.

YOUR CONNECTION TO THE MOBILITY ENGINEERING COMMUNITY

The Member Connection is an online community providing multiple engagement opportunities:

- Join the conversation about SAE standards development and leverage timely technical discussions and topics that affect you on the job
- Build your professional network, and seek and share advice among industry experts
- Learn about the latest volunteer opportunities all in one place
- Access the Career Counselor series—ten minute videos on soft-skill enhancement such as time management and goal setting strategies

And more...

The Member Connection is available exclusively to SAE Members at connection.sae.org. Not a member? Explore the Member Connection at connection.sae.org and join for complete access.

I.D.# ET2726

SCHEDULE

Additional dates are being scheduled. Check the course web page for the most up-to-date course information.

FEES

List \$750

Members

Classic \$675

Premium \$638

Elite \$600

ONE-DAY / .7 CEUS

Get the complete course description and register:
training.sae.org/seminars/ety135/

**CONTACT SAE CORPORATE
LEARNING SOLUTIONS TO TRAIN
YOUR WHOLE TEAM.**

+1.724.772.8529

training.sae.org/corplearning



ADVANCED CONCEPTS OF GD&T 1994



This course offers an in-depth explanation of advanced GD&T topics like composite tolerancing, tolerance analysis, datum selection, non-rigid part dimensioning, and many more key dimensioning topics, including the system approach for part dimensioning. Newly acquired learning is reinforced throughout the class with more than 250 practice problems.

LEARNING OBJECTIVES

By participating in this seminar, you will be able to:

- Explain the importance of product design and functional dimensioning
- Define the terms “feature” and “feature of size”
- Recognize which dimensioning standards apply to an engineering drawing
- Explain the fundamentals of drawing interpretation and how to handle substandard drawings
- Recognize the difference between a rigid and a flexible (non-rigid) part
- State the requirements for tolerancing parts measured in the restrained state
- Identify the two special considerations for datum usage on restrained (non-rigid parts)
- Calculate advanced applications of form controls
- Describe uses, advantages, misconceptions, and common errors of the datum system
- List nine common datum feature types
- Describe advanced datum target concepts
- Explain how to specify / interpret specialized datum feature applications
- Describe modifier usage in tolerance of position applications
- Describe the effects of simultaneous and separate requirements with tolerance of position
- Explain composite position tolerancing and multiple single-segment position tolerancing
- Interpret tolerance of position applications with a conical tolerance zone
- Explain composite profile tolerancing and multiple single-segment profile tolerancing
- Describe profile applications

Each attendee receives a robust collection of learning resources including:

- *Advanced Concepts of GD&T* (ASME Y14.5M-1994) textbook by Alex Krulikowski
- A GD&T Ultimate Pocket Guide (1994)
- *Fundamentals of GD&T Exercise Workbook*
- 30-day access to Fundamentals of GD&T 2009 web training course to reinforce and practice what was learned in the classroom

WHO SHOULD ATTEND

This course is valuable for individuals who create or interpret engineering drawings, product and gage designers; process, product, and manufacturing engineers; supplier quality engineers/professionals; CMM operators; buyers/purchasers; checkers; inspectors; technicians; and sales engineers/professionals.

PREREQUISITES

Please be aware that this is not an introductory course. In order to understand the course content, students should have completed ETI's GD&T Fundamentals course or equivalent.

CONTENT HIGHLIGHTS

- GD&T Fundamentals Review
- Importance of Product Design
- Functional Dimensioning
- Interpretation of Feature
- Interpretation of Feature of Size
- Applicable Drawing Standards
- Drawing Interpretation
- Using Substandard Drawings
- Rigid/Non-Rigid Parts Definitions
- Tolerancing Non-Rigid Parts
- Restrained Part Datum Usage
- Form Controls
- The Datum System
- Datum Feature Types
- Datum Targets
- Specialized Datum Applications
- Tolerance of Position Usage
- Simultaneous and Separate Requirements
- Composite Position Tolerancing
- Multiple Single-Segment Tolerance of Position Tolerancing
- Conical Tolerance Zones
- Profile Tolerances
- Profile and Simultaneous Requirements
- Composite Profile Tolerancing
- Multiple Single-Segment Profile Tolerancing

INSTRUCTOR

See course web page for instructor information

I.D.# ET2411

SCHEDULE

View scheduled offerings at the course web page.

FEES

List \$1,280

Members

Classic \$1,152

Premium \$1,088

Elite \$1,024

TWO-DAYS /1.3 CEUS

Get the complete course description and register: training.sae.org/seminars/et2411/



TOLERANCE STACKS USING GD&T 1994



This course teaches how to calculate tolerance stacks, a crucial skill in today's competitive workplace. This course offers an in-depth explanation of how to use tolerance stacks to establish part tolerances, analyze design, create process designs, and how to use geometric tolerances in stacks. Newly acquired learning is reinforced throughout the class with numerous practice problems and in-depth coverage of tolerance stacks applications.

LEARNING OBJECTIVES

By attending this class, you will be able to:

- Explain the importance of tolerance stacks
- Explain the concepts of virtual condition
- Describe a tolerance stack
- Recognize part stacks using coordinate tolerancing
- Calculate assembly stacks using coordinate tolerancing
- Recognize the symbols and modifiers used in geometric dimensioning and tolerancing
- Explain how to assemble stacks
- Calculate part stacks using profile, position (RFS, bonus, & shift), and multiple geometric tolerances
- Calculate assembly stacks using profile, position, and multiple geometric tolerances

WHO SHOULD ATTEND

This course is valuable for individuals who create or interpret engineering drawings, product and gage designers; process, product, and manufacturing engineers; supplier quality engineers/professionals; CMM operators; buyers/purchasers; checkers; inspectors; technicians; and sales engineers/professionals.

PREREQUISITES

Please be aware that this is not an introductory course. In order to understand the course content, students should have completed ETI's GD&T Fundamentals and Advanced Concepts courses or equivalent.

Each attendee receives a robust collection of learning resources including:

- *Tolerance Stacks* textbook by Alex Krulikowski
- A Tolerance Stacks Drawing Package, Exercise Workbook, & Summary Chart
- A Tolerance Stacks Excel Worksheet
- A Tolerance Stacks Application Workbook with Solution Set

CONTENT HIGHLIGHTS

- Major Benefits of Stacks
 - The importance of stacks
 - Calculating the virtual condition of part features
 - Determining if parts will fit by comparing virtual condition
 - Determining if clearance/interference exists between parts
 - The definition of a stack
 - Three purposes of stacks
 - Four benefits of stacks
 - Determining when stacks should be calculated
 - The difference between part and assembly stacks
 - The difference between linear and radial stacks
- The Two-Column Stack Method
 - The four basic steps in a stack
 - The three benefits of the stack form
 - Completing the stack form
 - Calculating part stacks using coordinate dimensioning
 - Calculating assembly stacks using coordinate dimensioning
- Making Stacks That Use All Part Tolerances
 - Calculating part stacks and assembly stacks: using circular and total runout; using concentricity; using profile of a surface with bilateral and unilateral tolerances
 - Calculating part stacks using position tolerances (RFS)
 - Calculating stacks using form tolerances applied to a feature
 - Calculating stacks using straightness applied to a feature of size
 - Calculating stacks using orientation controls applied to a feature and feature of size
 - Calculating part stacks and assembly stacks using multiple geometric tolerances
 - Three ways to document stacks
 - Using a stack matrix chart
- Optimizing Part Tolerances
 - Evaluating a stack answer
 - Choosing a design goal for a stack
 - Using stacks to optimize part tolerances

INSTRUCTOR

See course web page for instructor information

I.D.# ET2421

SCHEDULE

View scheduled offerings at the course web page.

FEES

List \$1,280

Members

Classic \$1,152

Premium \$1,088

Elite \$1,024

TWO-DAYS /1.3 CEUS

Get the complete course description and register:
training.sae.org/seminars/et2421/



FUNDAMENTALS OF GD&T FOR INSPECTORS



This course offers an explanation of the geometric symbols, rules, and concepts, the datum system, and how to inspect GD&T requirements using tools from the four categories of inspection tools (CMM; comparison instruments and fixed gages; hand tools and open set up; and production gaging systems). Newly acquired learning is reinforced throughout the class with numerous practice problems.

The scope of the seminar does not include how to use the various inspection tools. For example, the seminar will discuss how to locate a part for inspection on a CMM, but it will not cover how to program the CMM to gather the data point.

LEARNING OBJECTIVES

By attending this class, you will be able to:

- Describe inspection and engineering drawings
- Explain key terms used in GD&T and how they affect interpretation and inspection
- Recognize the modifiers and symbols used in geometric tolerancing
- Interpret and inspect Rule #1, Rule #2, flatness, straightness, circularity, cylindricity, perpendicularity, angularity, parallelism, concentricity, symmetry, circular and total runout
- Explain the concepts of basic dimensions, virtual condition, inner and outer boundary and bonus tolerance and their effects on inspection
- Interpret and simulate planar datums and datum targets for inspection
- Interpret and inspect feature of size datums RFS and MMC
- Explain the fundamental concepts of tolerance of position: definitions, conventions, advantages and interpretations and their effects on inspection
- Interpret and inspect tolerance of position RFS, MMC, and special applications
- Describe functional gages for tolerance of position (MMC) applications
- Explain profile tolerancing
- Interpret and inspect profile of a surface and profile of a line applications

WHO SHOULD ATTEND

This course is valuable for those who create or interpret engineering drawings, product and gage designers; process, product, and manufacturing engineers; supplier quality engineers/professionals; CMM operators; buyers/purchasers; checkers; inspectors; technicians; and sales professionals.

Each attendee receives a robust collection of learning resources including:

- A copy of *The Fundamentals of GD&T Using Critical Thinking Skills (ASME Y14.5-2009)*, by Alex Krulikowski
- A GD&T Ultimate Pocket Guide (2009)
- *Fundamentals of GD&T for Inspectors Workbook*
- Class handouts
- 30-day access to Engineering Drawing Requirements based on ASME Y14.100-2004 and ASME Y14.24-1999 online training course, to practice and reinforce what was learned in the classroom.

CONTENT HIGHLIGHTS

- Inspection
- The Engineering Drawing
- Key Terms and Their Effect on Interpretation and Inspection
- Modifiers and Symbols
- Interpreting and Inspecting Rule #1 and Rule #2
- Basic Concepts
- Interpreting and Inspecting Flatness
- Interpreting and Inspecting Straightness
- Interpreting and Inspecting Circularity
- Interpreting and Inspecting Cylindricity
- Interpreting and Simulating Planar Datums for Inspection
- Interpreting and Simulating Datum Targets for Inspection
- Interpreting and Inspecting Feature of Size Datums (RFS)
- Interpreting and Inspecting Feature of Size Datums (MMC)
- Interpreting and Inspecting Perpendicularity
- Interpreting and Inspecting Angularity
- Interpreting and Inspecting Parallelism
- The fundamental Concepts of Tolerance of Position: Definitions, Conventions, Advantages and Interpretations and Their Effects on Inspection
- Interpreting and Inspecting Tolerance of Position RFS and MMC Applications
- Functional Gages for Tolerance of Position (MMC) Applications
- Interpreting and Inspecting Tolerance of Position Special Applications
- Interpreting and Inspecting Concentricity
- Interpreting and Inspecting Symmetry
- Interpreting and Inspecting Circular Runout
- Interpreting and Inspecting Total Runout
- Profile Tolerancing
- Interpreting and Inspecting Profile of a Surface Applications
- Interpreting and Inspecting Profile of a Line Applications

INSTRUCTOR

See course web page for instructor information.

I.D.# ET2053

SCHEDULE

View scheduled offerings at the course web page.

FEES

List \$1,280

Members

Classic \$1,152

Premium \$1,088

Elite \$1,024

TWO-DAYS /1.3 CEUS

Get the complete course description and register:
training.sae.org/seminars/et2053/



SOLID MODEL TOLERANCING



This course explains the fundamental definitions, concepts, and methods from the ASME Y14.41 Standard on Digital Product Definition Data Practices. Utilizing the expertise of world-renowned GD&T expert and former Chairman of the Y14.41 Committee, Alex Krulikowski, the course focuses on understanding the benefits of a math-based product development process.

LEARNING OBJECTIVES

By attending this class, you will be able to:

- Explain the benefits of a math-based product development process (PDP)
- Describe the history, basic information, and definitions from the Y14.41 standard
- Explain how to create product definition data sets
- Describe data set requirements
- List drawing model data set requirements
- Explain various requirements that apply to annotated model data sets
- List the requirements when using the annotated model method
- Recognize the gaps, issues, and challenges of implementing a math-based PDP

WHO SHOULD ATTEND

This course is valuable for designers, engineers, and managers who are considering implementation of a math-based product development process.

CONTENT HIGHLIGHTS

- The Product Development Process
- General Information on the ASME Y14.41 Standard
- The Data Set Concept
- Common Requirements for Data Sets
- Requirements for the Drawing Data Set Method
- Requirements for the Annotated Model Method
- Tolerancing Using the Annotated Model Method
- Gaps, Issues, and Challenges of Implementing a Math-Based Development Process

INSTRUCTOR

See course web page for instructor information.

Each attendee receives a robust collection of learning resources including:

- A copy of the *Digital Product Definition Workbook*, by Alex Krulikowski
- 30-day access to Engineering Drawing Requirements based on ASME Y14.100-2004 and ASME Y14.24-1999 online training course, to practice and reinforce what was learned in the classroom

I.D.# ET2501

SCHEDULE

View scheduled offerings at the course web page.

FEES

List \$750

Members

Classic \$675

Premium \$638

Elite \$600

ONE-DAY/.7 CEUS

Get the complete course description and register:
training.sae.org/seminars/et2501/



ASME/ISO STANDARDS COMPARISON



This course explains the major differences between the ASME and ISO standards in a concise, easily understood manner. Utilizing the expertise of world-renowned GD&T expert Alex Krulikowski, the course focuses on how the standards compare when dealing with symbols, feature control frames, tolerances, form controls, datums, and more.

LEARNING OBJECTIVES

By attending this class, you will be able to:

- Explain how ASME and ISO standards are developed
- Recognize the advantages and cautions of using ASME and ISO standards
- List the major differences in technical drawing presentation
- Recognize the major differences between ASME and ISO geometric tolerancing terms and symbols
- Recognize the major differences between ASME and ISO datum systems
- Identify the differences in ASME and ISO drawings

WHO SHOULD ATTEND

This course is valuable for individuals who work with ISO standards on drawings, designers, engineers, inspectors, and machinists.

CONTENT HIGHLIGHTS

- Standards and Technical Drawings
- Advantages and Cautions
- Technical Drawing Presentation Differences
- Tolerancing Term Differences
- Datum System Differences
- Geometric Tolerancing Symbol Differences
- ASME and ISO Drawing Differences

INSTRUCTOR

See course web page for instructor information.

Each attendee receives a robust collection of learning resources including:

- A copy of *ASME/ISO Exercise Workbook*, by Alex Krulikowski
- Class handouts

I.D.# ET2025

SCHEDULE

View scheduled offerings at the course web page.

FEES

List	\$770
Members	
Classic	\$693
Premium	\$655
Elite	\$616

ONE-DAY/.7 CEUS

Get the complete course description and register:
training.sae.org/seminars/et2025/



ISO GEOMETRICAL TOLERANCING



This course teaches how to use engineering drawings that use the International Standards Organization (ISO) standards. Utilizing the expertise of world-renowned GD&T expert Alex Krulikowski, this course will teach you to recognize what is required on a standard-compliant drawing and recognize geometrical tolerances based on the ISO standards. The course combines information from dozens of ISO standards into a logical understandable topic.

LEARNING OBJECTIVES

By attending this class, you will be able to:

- Describe the ISO standards system on technical drawings
- Recognize ISO drawing practices
- Explain the structure of GPS and the domains of features
- Recognize the symbols used in geometrical tolerancing
- Describe linear size and size conditions
- Explain the principle of independency and the envelope requirement
- Explain geometrical tolerancing concepts: MMR, LMR, RPR, virtual conditions, and collective requirements
- Describe the ISO 286 system of limits and fits
- Describe the datum system (planar datums)
- Interpret datum target and size datum specifications
- Interpret the flatness, straightness, roundness, cylindricity, perpendicularity, angularity, and parallelism tolerances
- Explain the fundamental concepts of position tolerances
- Interpret the position tolerance at MMR and special applications
- Interpret the coaxiality, concentricity, symmetry, circular and total run-out tolerances
- Interpret the profile any surface and profile any line tolerances
- Explain the ISO system for general tolerances
- Interpret work piece edge specifications
- Interpret surface texture and surface imperfection requirements

Each attendee receives a robust collection of learning resources including:

- Alex Krulikowski's *ISO Geometrical Tolerancing Reference Guide*
- *ISO Geometrical Tolerancing Workbook*
- Class handouts

WHO SHOULD ATTEND

This course is valuable for individuals who create or interpret engineering drawings, product and gage designers; process, product, and manufacturing engineers; supplier quality engineers/professionals; CMM operators; buyers/purchasers; checkers; inspectors; technicians; and sales engineers/professionals

CONTENT HIGHLIGHTS

- ISO Standards and Drawing Conventions
- GPS Basics
- Limits and Fits
- The Datum System
- Form Controls
- Orientation Controls
- Location Controls
- General Tolerances
- Workpiece Edges
- Surface Texture and Surface Imperfections
- ISO/ASME Comparison

INSTRUCTOR

See course web page for instructor information.

I.D.# ET7103

SCHEDULE

View scheduled offerings at the course web page.

FEES

List \$1,280

Members

Classic \$1,152

Premium \$1,088

Elite \$1,024

TWO-DAYS/1.3 CEUS

Get the complete course description and register:

training.sae.org/seminars/et7103/



FUNDAMENTALS OF GD&T 2009



Providing you have a basic understanding of mechanical drawings, this course teaches the terms, rules, symbols, and concepts of GD&T as prescribed in the ASME Y14.5-2009 Standard. Utilizing the expertise of world-renowned GD&T expert Alex Krulikowski, this course offers an in-depth explanation of geometric tolerancing symbols, their tolerance zones, applicable modifiers, common applications, and limitations. The class includes a comparison of GD&T to coordinate tolerancing; Rules #1 and #2; form and orientation controls; tolerance of position; runout and profile controls. It is up to date with the new 2009 standard and explains all the new rules and symbols. Newly acquired learning is reinforced throughout the class with more than 150 practice problems.

LEARNING OBJECTIVES

By attending this class, you will be able to:

- Explain the importance of standards on engineering drawings
- Describe the types of dimensions, tolerances, and notes
- Explain why geometric tolerancing is superior to coordinate tolerancing
- Interpret the general dimensioning symbols
- Define the key terms used in GD&T
- Recognize the symbols and modifiers used in GD&T
- Explain the rules used in GD&T
- Describe the concepts of worst-case boundary, virtual condition, and bonus tolerance
- Interpret the various types of tolerance (flatness, circularity, cylindricity, straightness, perpendicularity, parallelism, angularity, position, runout, and profile)
- Describe the datum system
- Interpret applications of datum targets, size datum features (RMB), and size datum features (MMB)

WHO SHOULD ATTEND

This course is valuable for individuals who create or interpret engineering drawings, product and gage designers; process, product, and manufacturing engineers; supplier quality engineers/professionals; CMM operators; buyers/purchasers; checkers; inspectors; technicians; and sales engineers/professionals

Each attendee receives a robust collection of learning resources including:

- *Fundamentals of GD&T Using Critical Thinking Skills (ASME Y14.5-2009)* textbook by Alex Krulikowski
- A GD&T Ultimate Pocket Guide (2009)
- 30-day access to Fundamentals of GD&T 2009 web training course to practice and reinforce what was learned in the classroom

PREREQUISITES

Students should have completed ETI's Engineering Drawing Requirements course or equivalent.

CONTENT HIGHLIGHTS

- Introduction
 - Drawing standards
 - Dimensions, tolerances, and notes
 - Coordinate tolerancing and GD&T
 - General dimensioning symbols
- Fundamentals
 - Key GD&T terms
 - Symbols and modifiers
 - GD&T rules
 - GD&T concepts
- Form
 - Flatness tolerance
 - Straightness tolerance
 - Circularity tolerance
 - Cylindricity tolerance
- Datum System
 - Datum system
 - Datum targets
 - Size datum features (RMB)
 - Size datum features (MMB)
- Orientation
 - Perpendicularity tolerance
 - Parallelism tolerance
 - Angularity tolerance
- Position
 - Position tolerance introduction
 - Position tolerance - RFS and MMC
 - Position tolerance - special applications
 - Position tolerance - calculations
- Runout, Concentricity, Symmetry
 - Circular and total runout tolerances
 - Concentricity and symmetry tolerance
- Profile
 - Profile tolerance basic concepts
 - Profile tolerance applications

INSTRUCTOR

See course web page for instructor information.

I.D.#ET1151

SCHEDULE

View scheduled offerings at the course web page.

FEES

List \$1,635

Members

Classic \$1,472

Premium \$1,390

Elite \$1,308

THREE-DAYS/2.0 CEUS

Get the complete course description and register:

training.sae.org/seminars/et1151/



ASME Y14.5 1994-2009 COMPARISON



This course teaches the significant revisions, additions, and deletions prescribed in the new ASME Y14.5-2009 Standard.

Utilizing the expertise of world-renowned GD&T expert Alex Krulikowski, the course offers an in-depth explanation of new features in the 2009 standard and compares them to the 1994 Standard. Newly acquired learning is reinforced throughout the class with numerous practice problems, and a set of comprehensive comparison charts that highlight itemized changes in the standard are included in the seminar price.

LEARNING OBJECTIVES

The seminar covers these major changes to the standard:

- More than thirty new or revised terms
- Sixteen new or revised symbols
- Revisions and additions to the fundamental rules
- Revisions and additions to the concept of feature of size
- Revisions and new symbols for datum specifications
- Revisions to composite position tolerances
- Surface boundaries and axis methods of interpretation
- Revisions and new additions to profile tolerances

WHO SHOULD ATTEND

This course is valuable for individuals who create or interpret engineering drawings, product and gage designers; process, product, and manufacturing engineers; supplier quality engineers/professionals; CMM operators; buyers/purchasers; checkers; inspectors; technicians; and sales engineers/professionals.

CONTENT HIGHLIGHTS

- 24 revised terms in ASME Y14.5-2009
- 16 new terms in ASME Y14.5-2009
- Revised and new modifying symbols
- The datum system
- Revisions to geometric symbols
- 3-D digital data sets
- Summary of major changes
- Implementing a new standard

INSTRUCTOR

See course web page for instructor information.

Each attendee receives a robust collection of learning resources including:

- *ASME Y14.5 1994-2009 Comparison Workbook*, by Alex Krulikowski
- Class handouts
- A GD&T Ultimate Pocket Guide (2009)
- An ASME Y14.5 1994-2009 Comparison Chart set
- 30-day access to Engineering Drawing Requirements based on ASME Y14.100-2004 and ASME Y14.24-1999, to practice and reinforce what was learned in the classroom

I.D.# ET8000

SCHEDULE

View scheduled offerings at the course web page.

FEES

List	\$750
Members	
Classic	\$675
Premium	\$638
Elite	\$600

ONE-DAY/.7 CEUS

Get the complete course description and register:
training.sae.org/seminars/et8000/



NEED TO TRAIN YOUR WHOLE TEAM?

Bring SAE education and training to your location. Get variety, customization, quality and convenience. SAE International Corporate Learning advisors work with you to determine the best options to meet YOUR specific training challenge AND develop solutions to fit your budget and your schedule.

Through SAE Corporate Learning Solutions you can:

- Select a SAE course for delivery at your site
- Purchase a corporate subscription for a few courses or the entire library of over 50 online courses (350+ hours of content available)

Contact SAE Corporate Learning Solutions today to discuss how SAE can best meet your training needs.

training.sae.org/corplearning

**SAE INTERNATIONAL
CORPORATE LEARNING SOLUTIONS**

training.sae.org/corplearning

Contact SAE Corporate Learning:

+1.724.772.8529 or corplearn@sae.org

PRODUCT ENGINEERING/DEVELOPMENT TOOLS & METHODS GD&T PRODUCT GUIDE

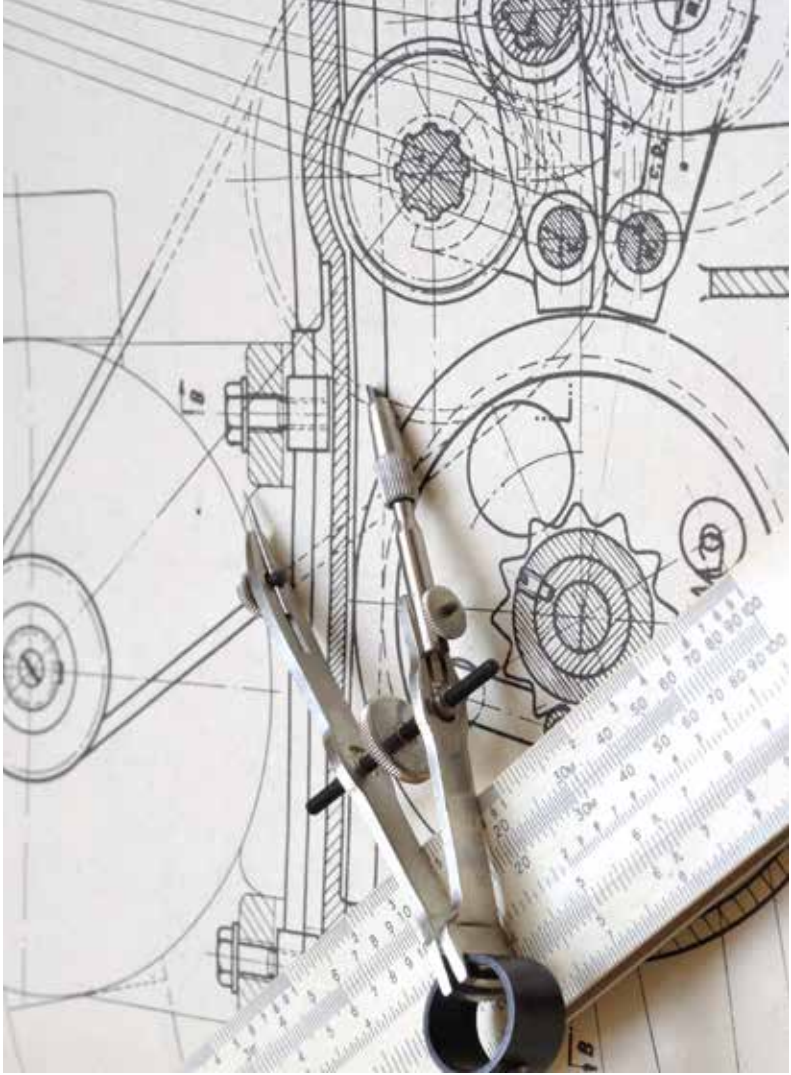

400 Commonwealth Drive
Warrendale, PA 15096

P178-5830