

Product Features:

Can be wall-mounted or floor-mounted
Touch switch dim function



VANITYFUS

Hollywood mirror

Series:

19056

19035-black

19026/19027

Size:

W600XH1650mm

W600XH1800mm

W800XH600mm

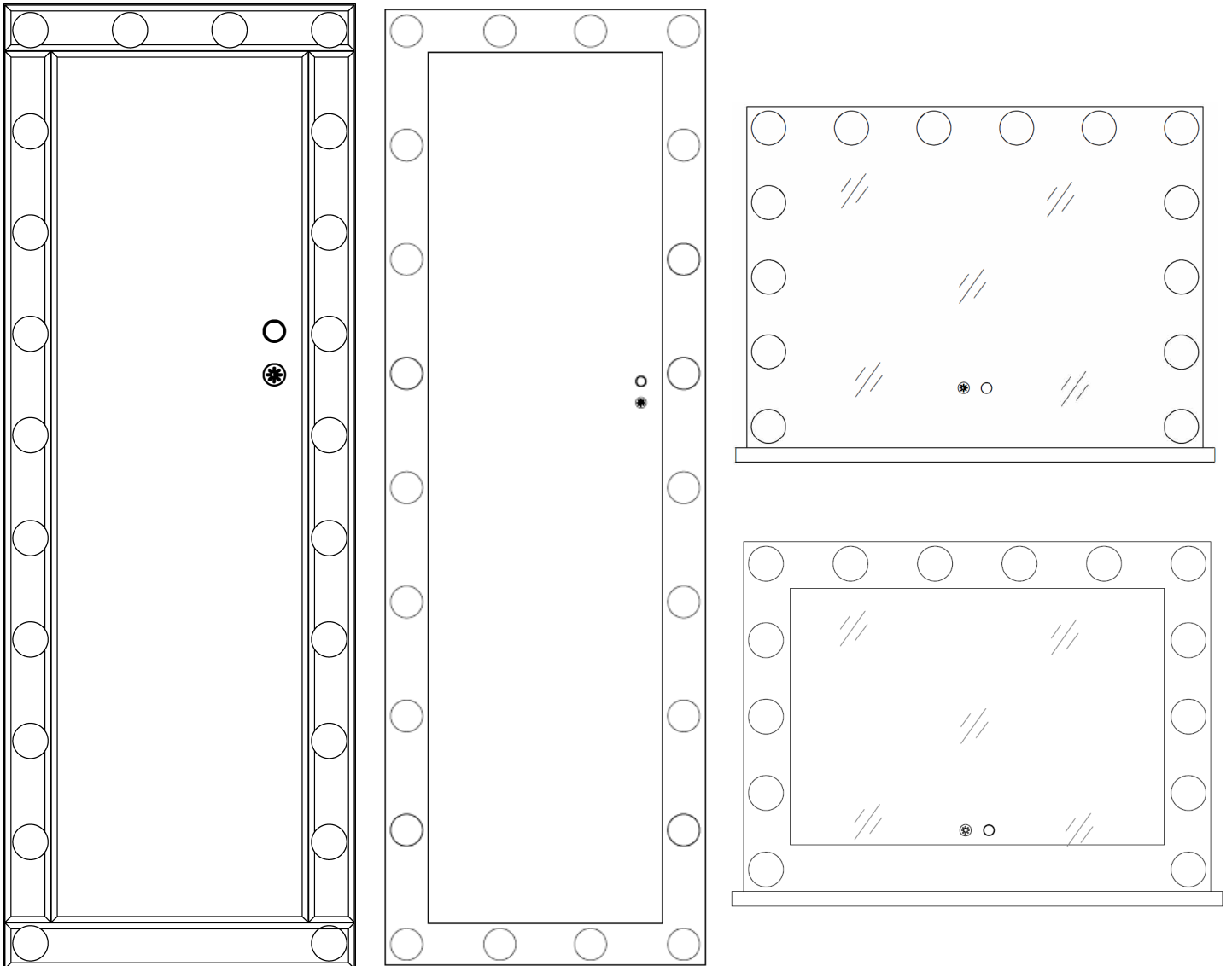

For easy and safe installation, please do the following:

Thoroughly read all instructions before installing the enclosed product.
Read and take note of all safety, care and maintenance information.

**PLEASE KEEP THIS INSTRUCTION MANUAL FOR FUTURE REFERENCE FOR
PRODUCT OPERATION AND MAINTENANCE.**

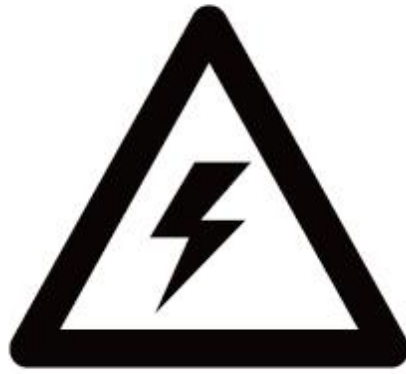

WARNING AND SAFETY INSTRUCTIONS

Before assembling your LED Lighted Mirror fixture, please make sure that you carefully read through this instruction sheet, refer back to them during installation to ensure your product is fitted safely and correctly. Keep these instructions for future use.

WARNING Risk of Fire and Electric Shock

- All fittings must be installed in accordance with current IEE wiring regulations. If in doubt, consult a qualified electrician.
- Switch off the electrical supply at the main circuit board BEFORE installation and maintenance.
- Suitable for indoor use only. This product should be positioned well away from curtains and fabrics. Never cover the mirror.
- Regularly check the cord, the transformer and all other parts for damage, if any part is damaged the product should not be used.

INSTALLATION SAFETY

- Inspect the product immediately upon receipt for the transit damage or missing parts. Handle the product with care and protect against knocks to all sides and edges of the glass.
- Ensure there are no hidden pipes or cables in the wall before drilling.
- Wear suitable eye protection when drilling. Take care if drilling on tiled surfaces in case the drill slips.

CAUTION

The light source of this product is non-changeable light diodes (LED). Do not disassemble the product, as the light diodes can cause damage to the eyes.

NOTE: The important safeguards and instructions that appear in this manual are not meant to cover all possible conditions and situations that may occur. It must be understood that common sense, caution and care are factors that can't be built into any product. These factors must be supplied by the person(s) caring for and operating the fixture. Do not install this fixture in hazardous locations.

PRODUCT DESCRIPTION

CHECK PRODUCT LIST AFTER OPENING THE PACKAGE

- Hollywood Mirror --1 pcs
- Installation Manual --1 pcs
- Z-bar --1 pcs
- LED blub --22 pcs
- Wall Mount Screw --4 pcs(One as spare parts)
- Drywall Anchor --4 pcs(One as spare parts)
- Plug wire --1 pcs

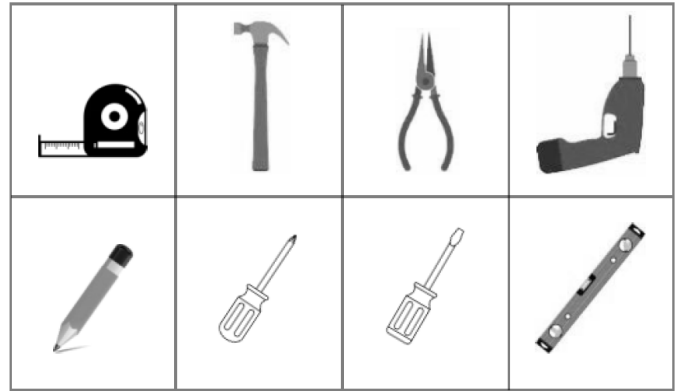

(TOOLS YOU MAY NEED)

Series: Size:
19056 W600XH1650mm
19035-black W600XH1800mm

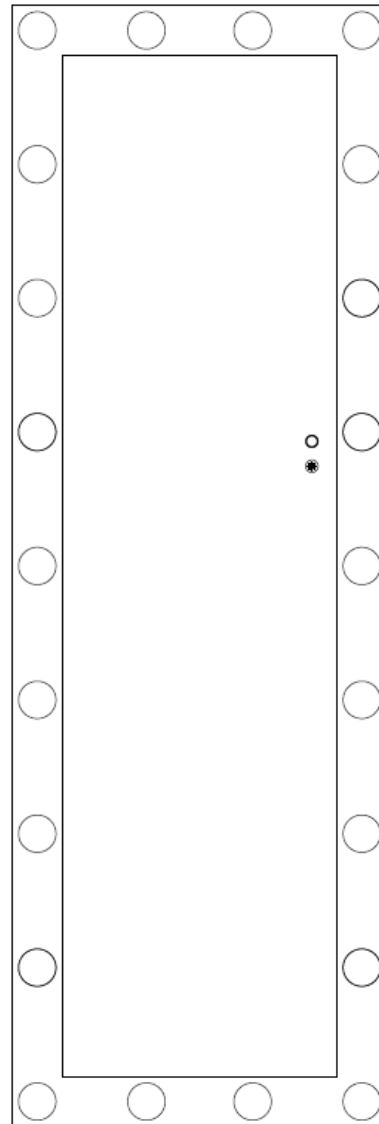
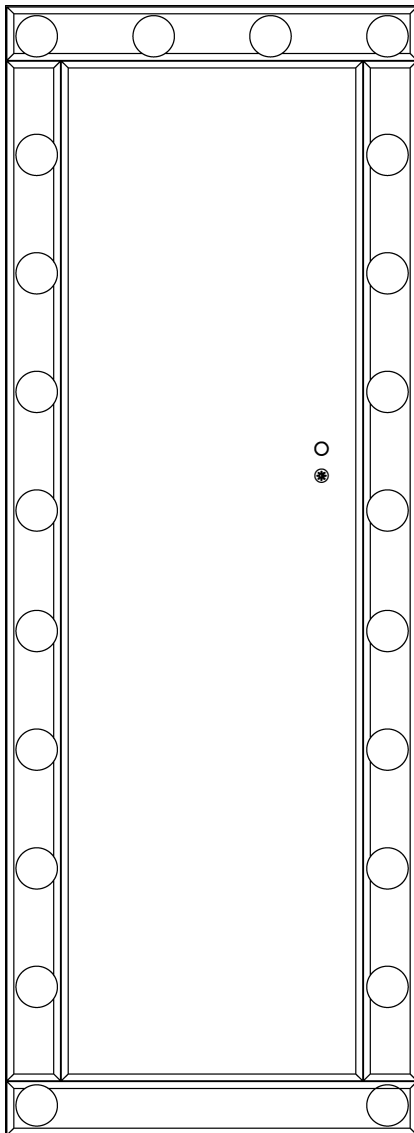

** All diagrams are for reference only. All model dimensions and proportions will vary.*

PRODUCT DESCRIPTION & INFORMATION

Model: 19056

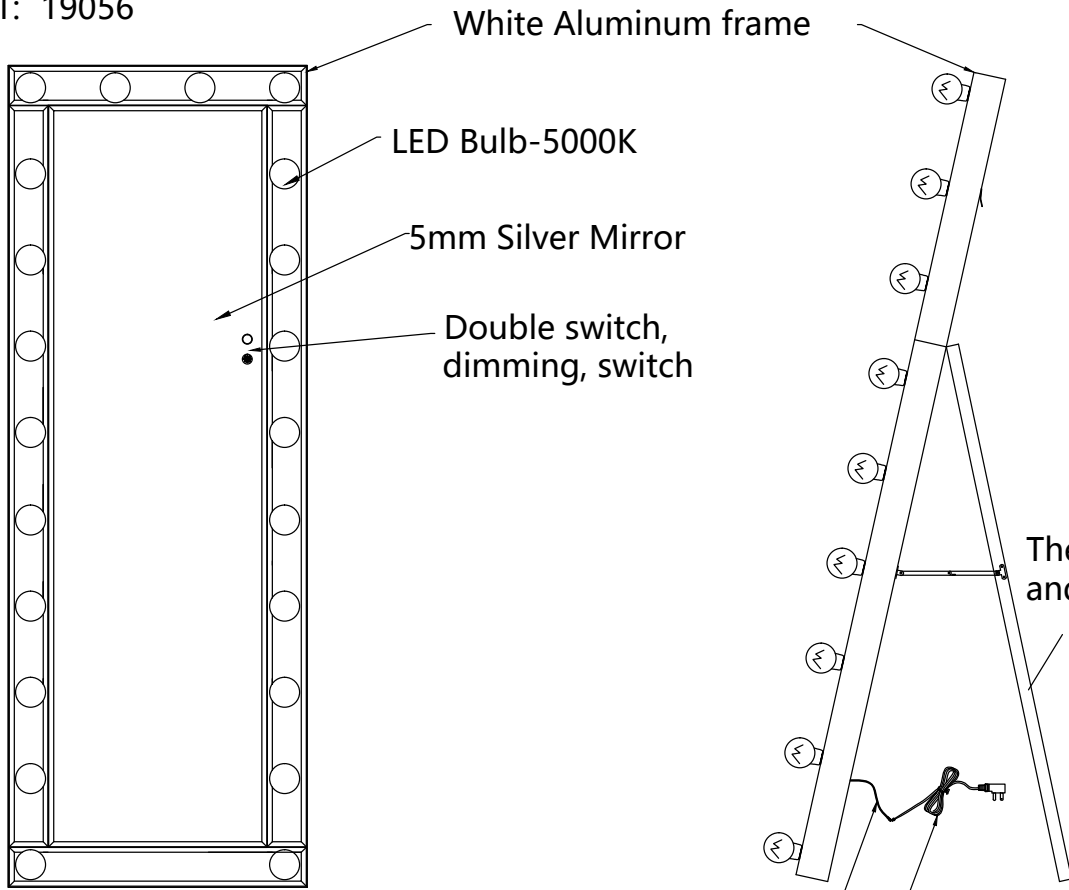

Model: 19035-black

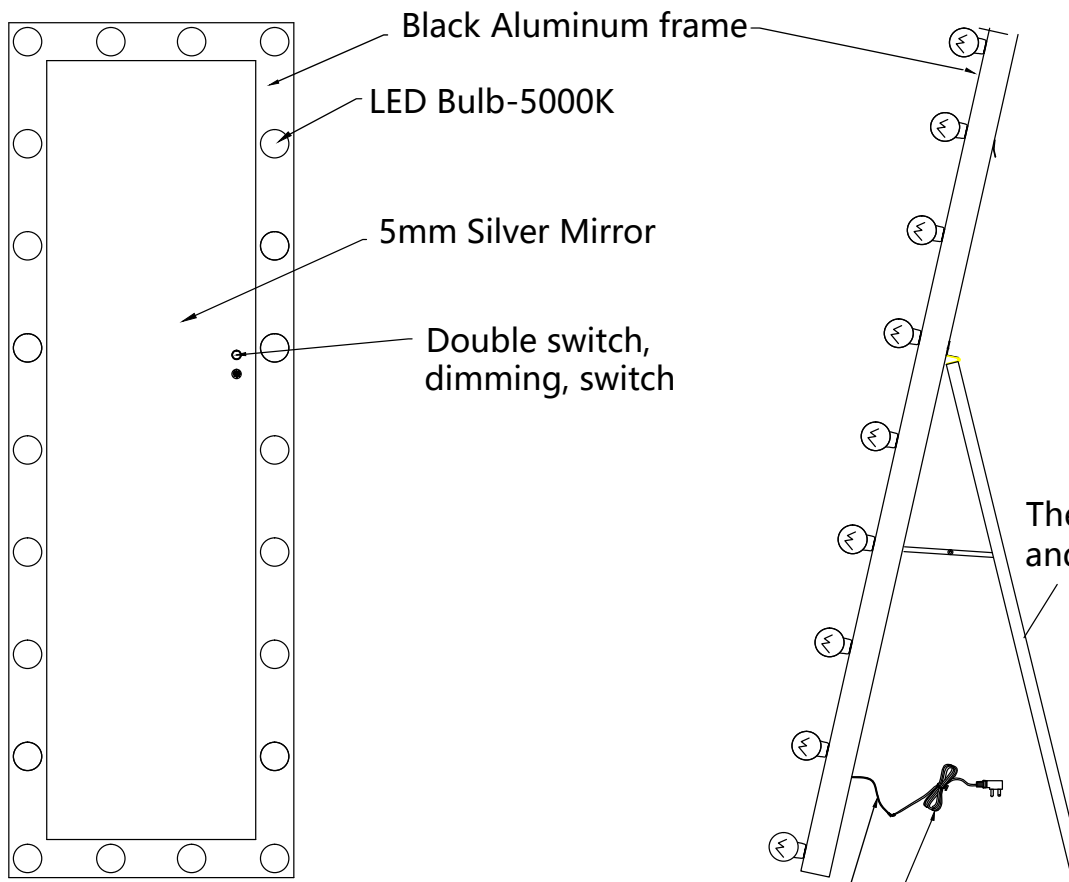

INSTALLATION PROCESS

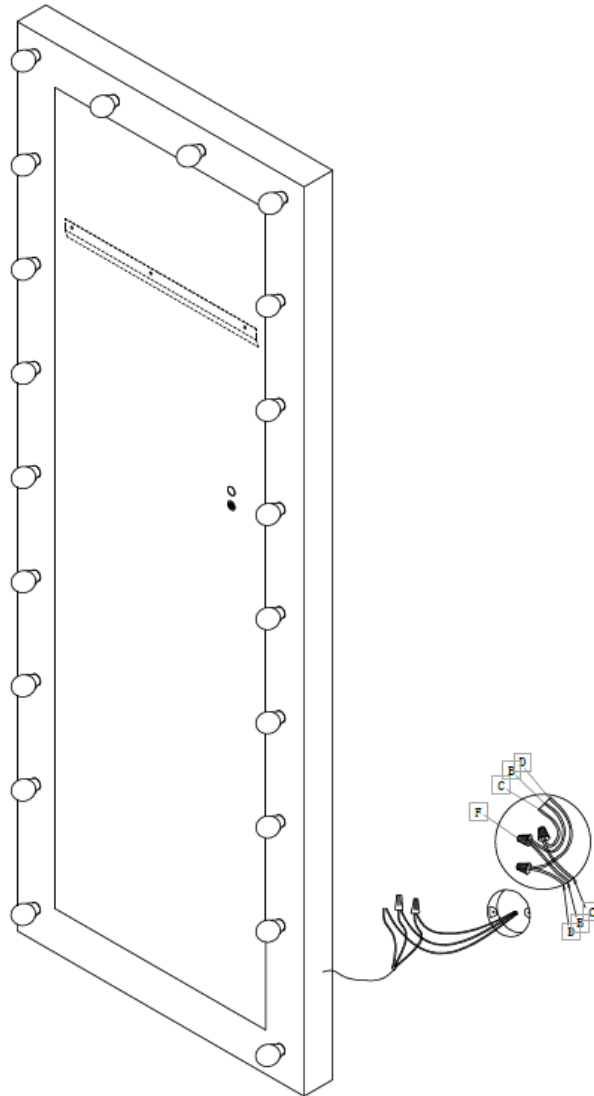
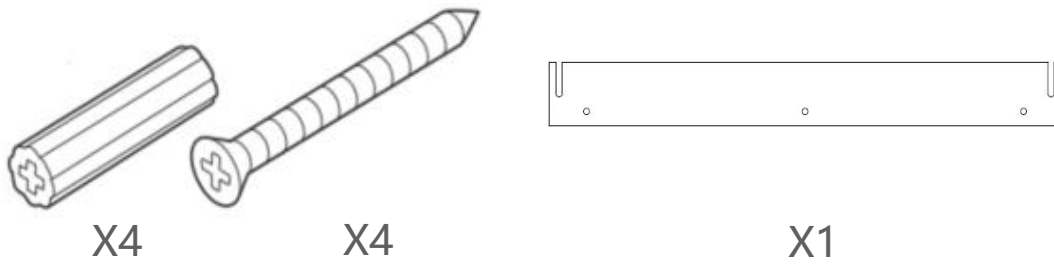

Wall-mounted installation

- Step 1:** Mark the position of the hanging screw.
- Step 2:** Fix the screw.
- Step 3:** Hang up the Hollywood mirror on the wall.
- Step 4:** Fixing bulbs.
- Step 5:** Directly screw the LED bulb into the lamp holder.

Floor type installation

- Step 1:** Open the floor stand.
- Step 2:** Directly screw the LED bulb into the lamp holder.
- Step 3:** Connect the plug wire to the hard wire.

Warning: Always switch off the electrical supply at the mains during installation and maintenance.

Do not switch on the electrical supply at the mains until installation completed.

PRODUCT DESCRIPTION

CHECK PRODUCT LIST AFTER OPENING THE PACKAGE

- Hollywood Mirror --1pcs
- Installation Manual --1pcs
- LED blub --12pcs
- Wall Mount Screw --4pcs
- Drywall Anchor --4pcs
- Gasket (for base assembly) --4pcs

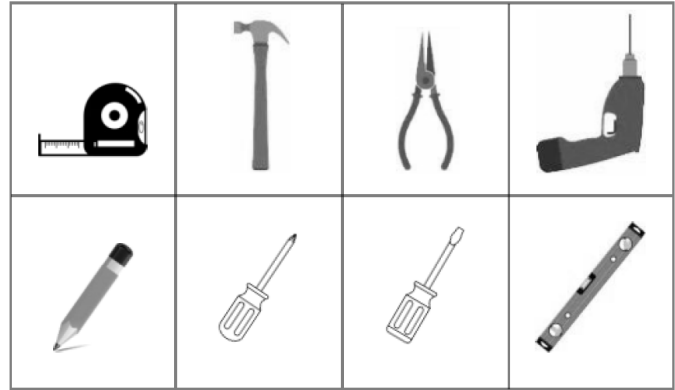

(TOOLS YOU MAY NEED)

Series:
19026
19027

Size:
W800XH600mm
W800XH600mm

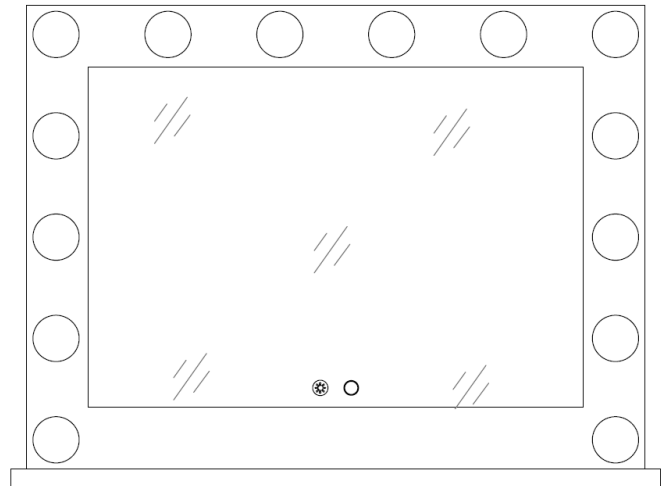
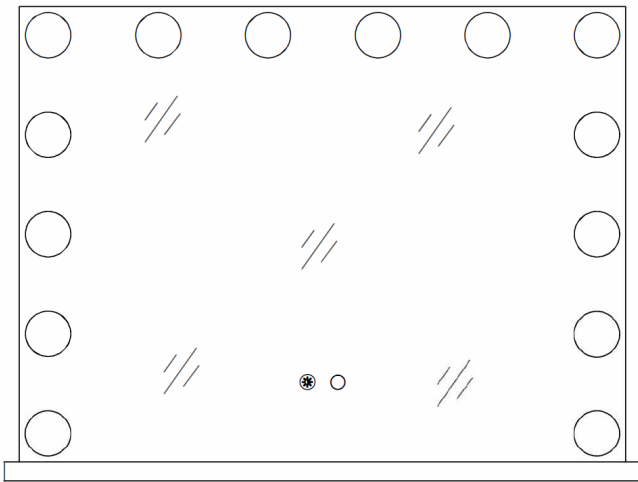

** All diagrams are for reference only. All model dimensions and proportions will vary.*

PRODUCT DESCRIPTION & INFORMATION

Model: 19026

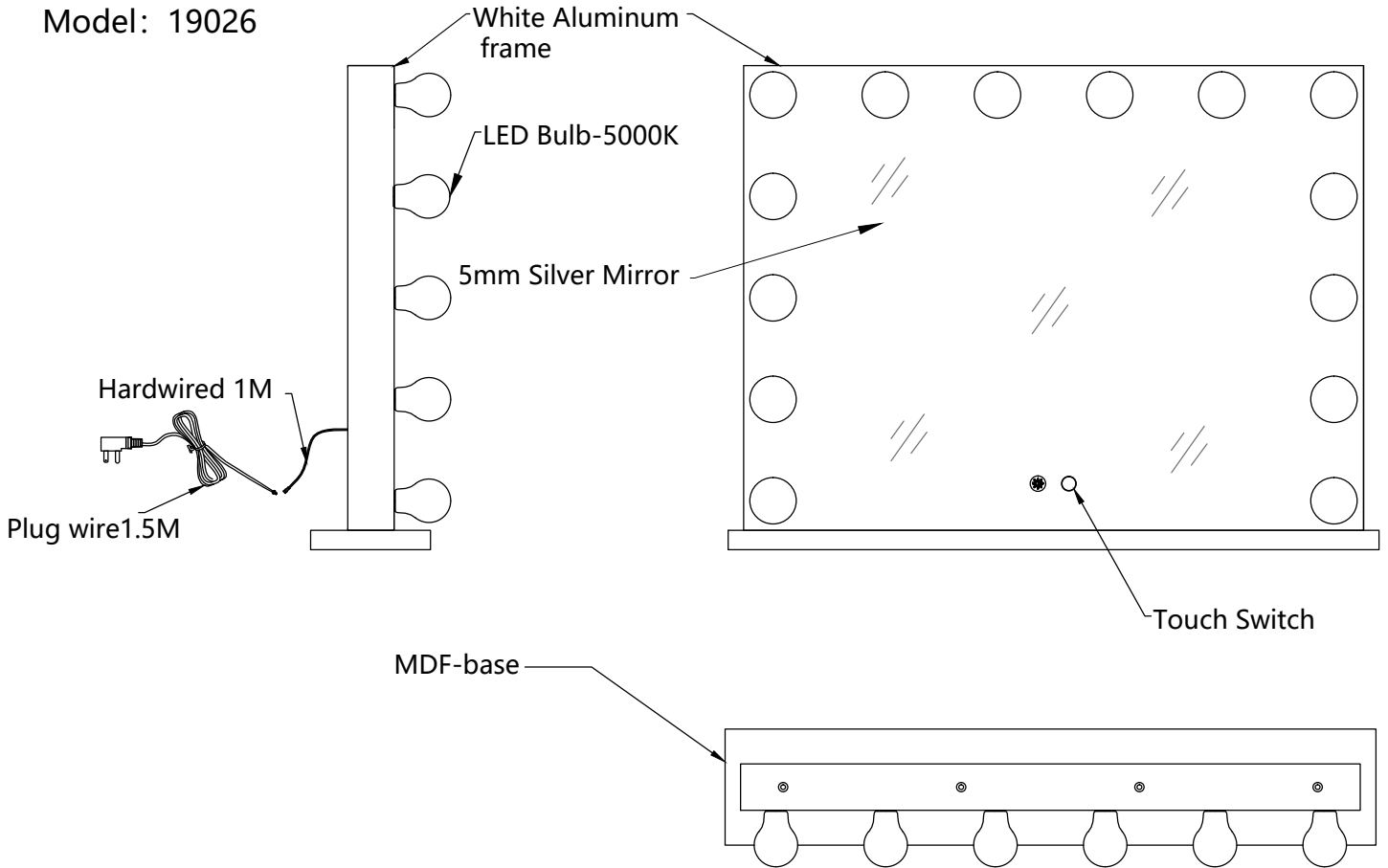

Model: 19027

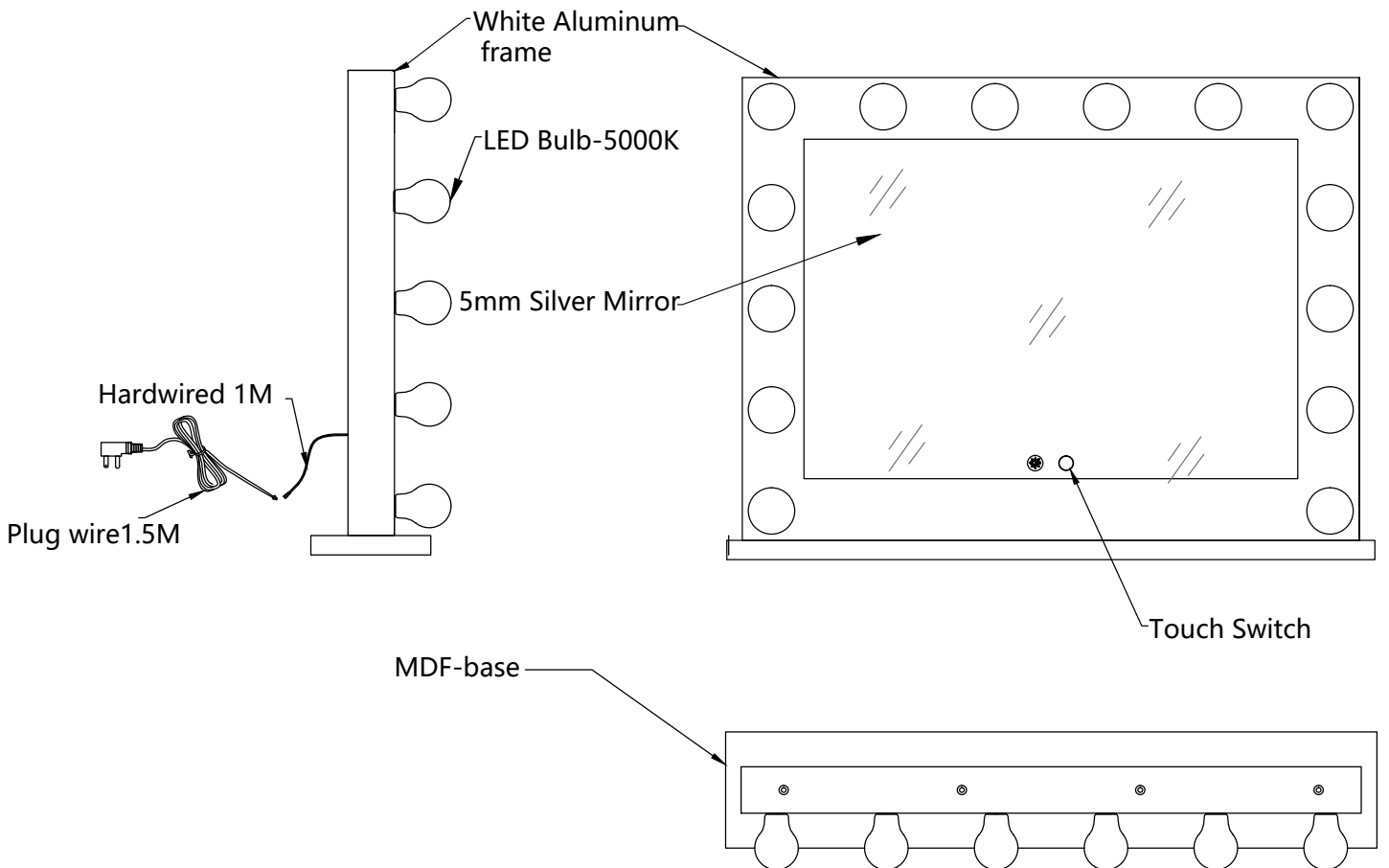

INSTALLATION PROCESS

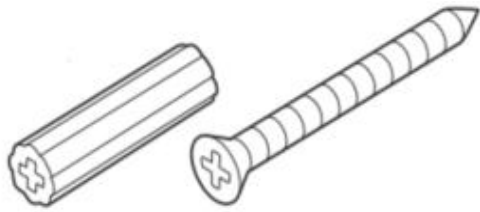

X4

X4



X1

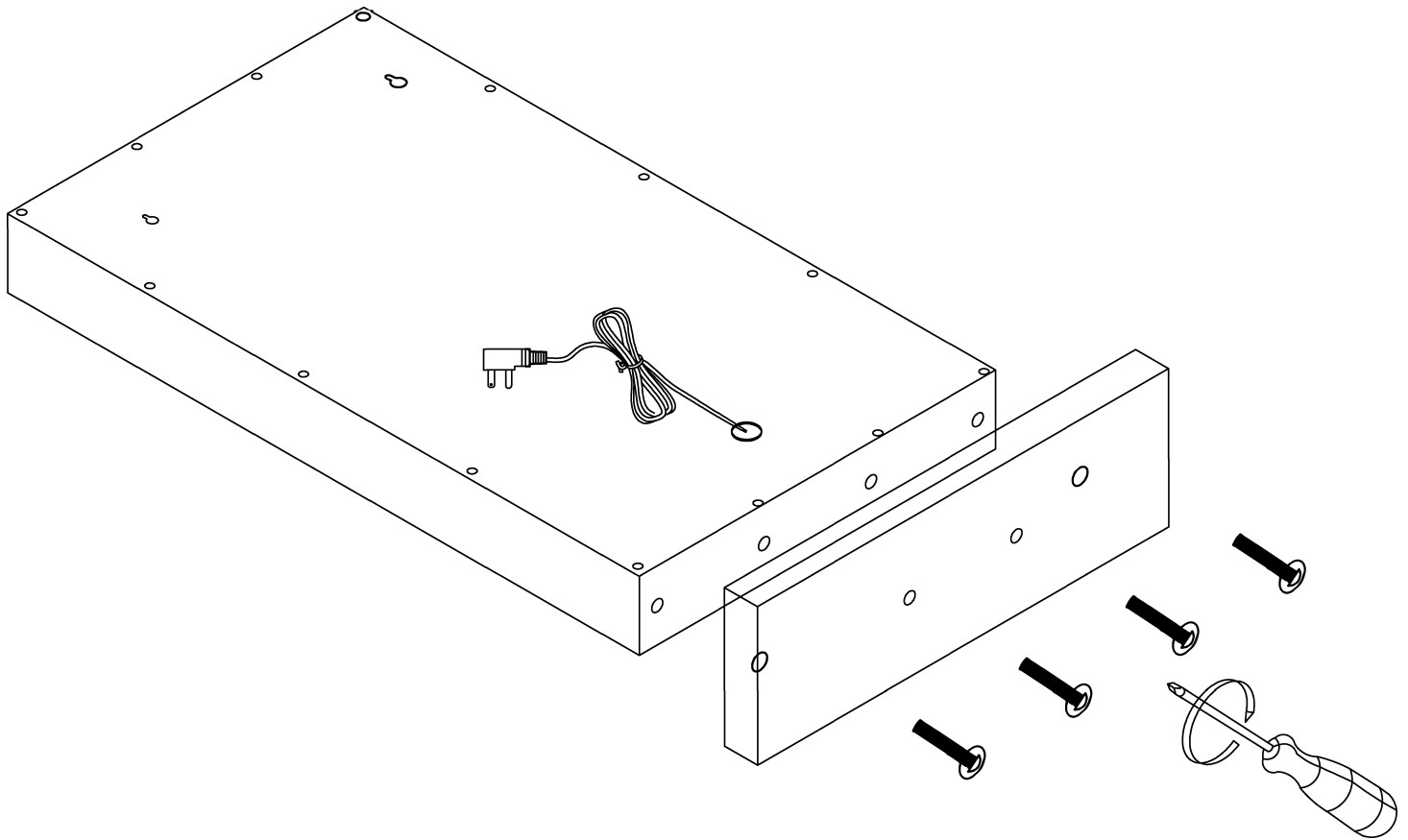

Warning: Always switch off the electrical supply at the mains during installation and maintenance.

Do not switch on the electrical supply at the mains until installation completed.

Wall-mounted installation

Step 1: Mark the position of the hanging screw.

Step 2: Fix the screw.

Step 3: Hang up the Hollywood mirror on the wall.

Step 4: Fixing LED bulbs.

Step 5: Directly screw LED bulb into the lamp holder.

Desk-type installation

Step 1: Using a screwdriver attach the base to bottom of the mirror through pre-drilled holes.

Step 2: Directly screw LED bulb into the lamp holder.

Step 3: Connect the plug wire to the hard wire.

Step 4: Once all screws have been tightened, you can place your mirror into your desired position.

Internal Power Flow Diagram

Scenario 1

(Direct Wired)

This is the most common way to connect the mirror. The LED light & anti fog pad are both controlled by the built-in touch switch on the mirror.

*The LED light is dimmable.

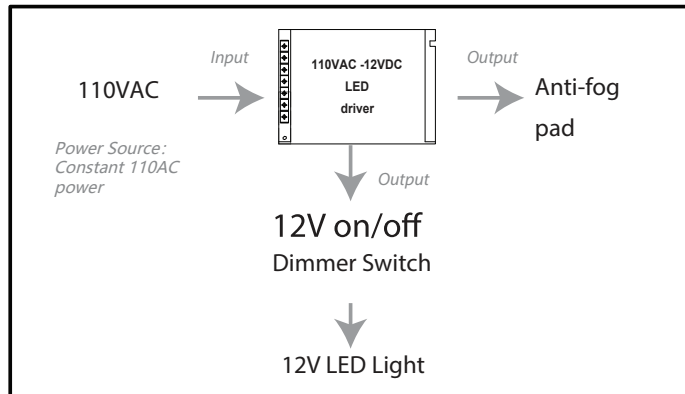

Scenario 2

(Wall Switch)

By doing so, the mirror is now bridged to the wall switch. In order to turn on the mirror, the wall switch needs to be on. The touch switch can be used to turn on the LED mirror and anti-fog pad. The mirror shuts down once the wall switch is flipped to OFF.

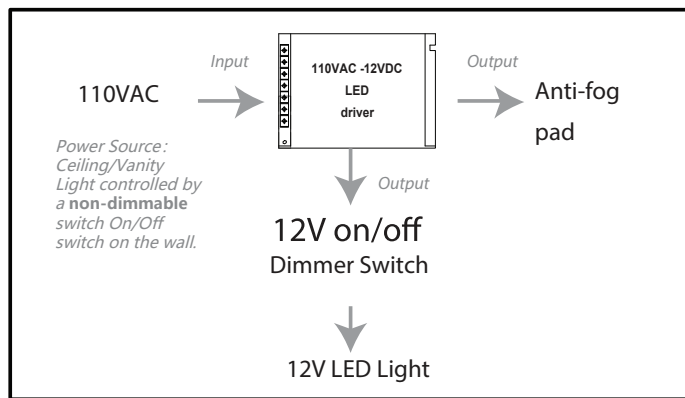

Scenario 3

(Wall Dimmer Switch – Not Accepted)

This is a scenario that is not acceptable. There is no work around for our mirror.

Do not try this way as it will damage the LED driver.

