



# Product Overview

---

This chapter provides an overview of the features available for the Cisco 812, Cisco 819, Cisco 860, 880, 890 Integrated Services Router (ISR) and contains the following sections:

- [Cisco 810 Series, page 1-1](#)
- [Cisco 860, 880, 890 Series, page 1-42](#)



Note

---

For compliance and safety information, see [Regulatory Compliance and Safety Information for Cisco 800 Series Routers](#).

---

## Cisco 810 Series

This section contains the following:

- [Cisco 812 Series, page 1-1](#)
- [Cisco 819 Series, page 1-10](#)

## Cisco 812 Series

This section provides an overview of the features available for the Cisco 812 Integrated Services Router (ISR) and contains the following sections:

- [General Description, page 1-1](#)
- [Hardware Features, page 1-4](#)
- [SKU Information, page 1-9](#)



Note

---

For compliance and safety information, see [Regulatory Compliance and Safety Information for Cisco 800 Series and SOHO Series Routers](#).

---

## General Description

The Cisco 812 ISR is a new router that looks like an Access Point with 3G, WLAN, and routing capabilities.

The 3rd Generation (3G) is a generation of standards for mobile technology that facilitates growth, increased in bandwidth, and supports more diverse applications.

The Cisco 812 ISR can be powered by an (included) external AC adapter or by a PoE+ capable Ethernet source using an optional Cisco PoE splitter C810-POE-SPL.

A Wireless Local Area Network (WLAN) implements a flexible data communication system frequently augmenting rather than replacing a wired LAN within a building or campus. WLANs use radio frequency to transmit and receive data over the air, minimizing the need for wired connections. [Figure 1-1](#) shows the Cisco 812 ISR.

**Figure 1-1** Cisco 812 ISR

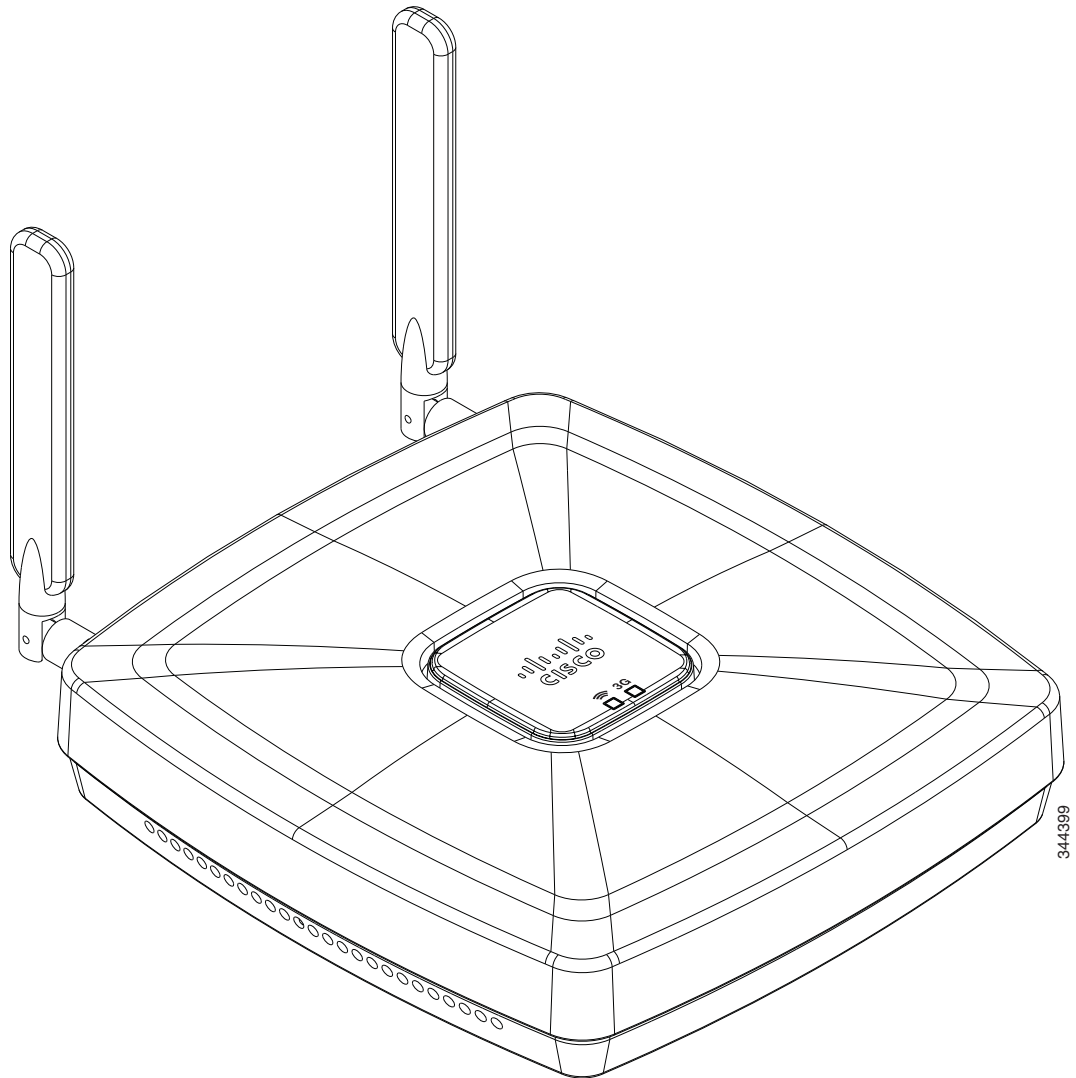

344399

Figure 1-2 shows the 3G antenna and LEDs display.

Figure 1-2 Cisco 812 ISR 3G and LEDs Display

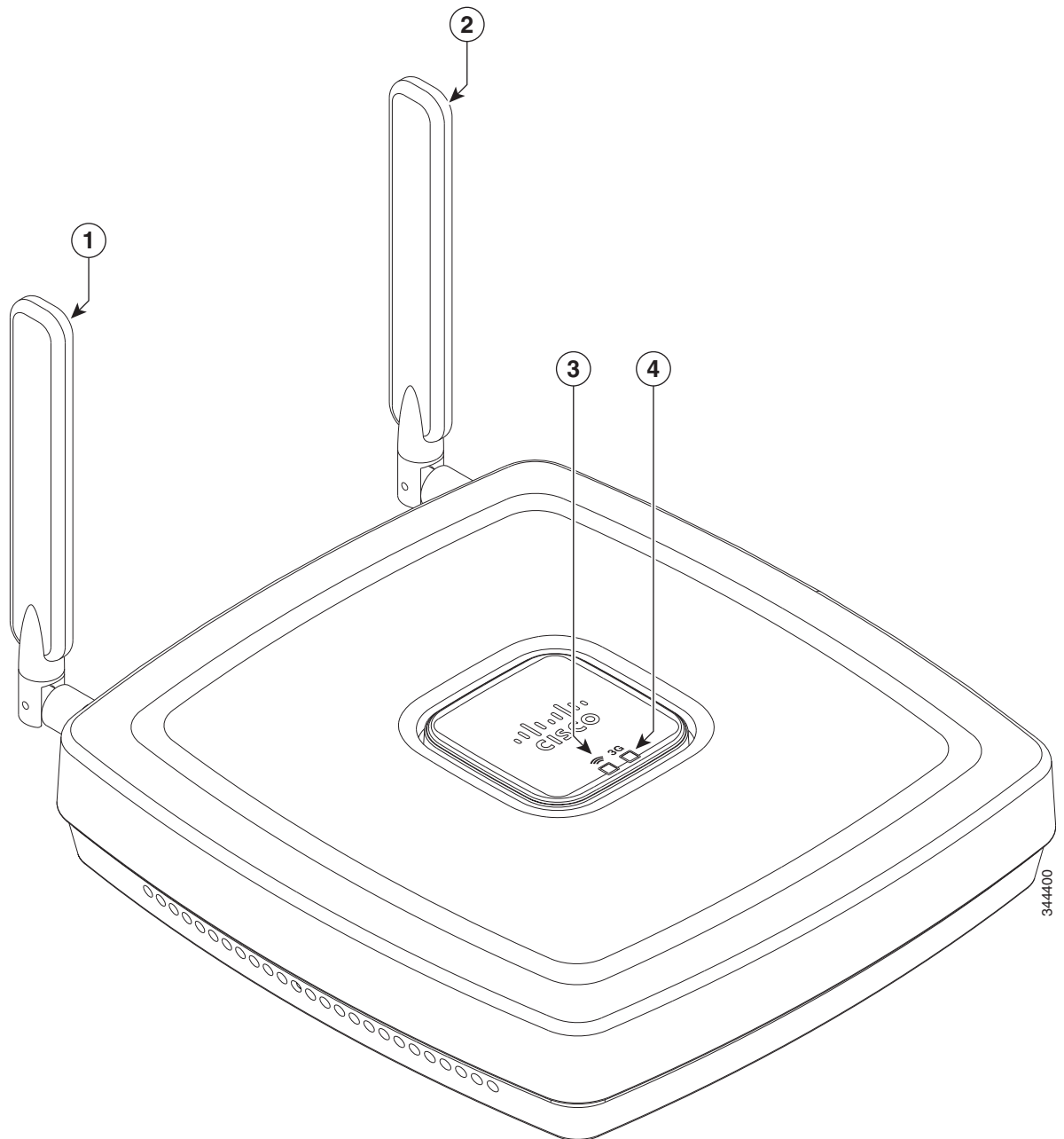

1	3G diversity antenna	3	WiFi LED
2	3G main antenna	4	3G LED

Figure 1-3 shows the I/O side of the Cisco 812 ISR.

Figure 1-3 Cisco 812 ISR I/O Side

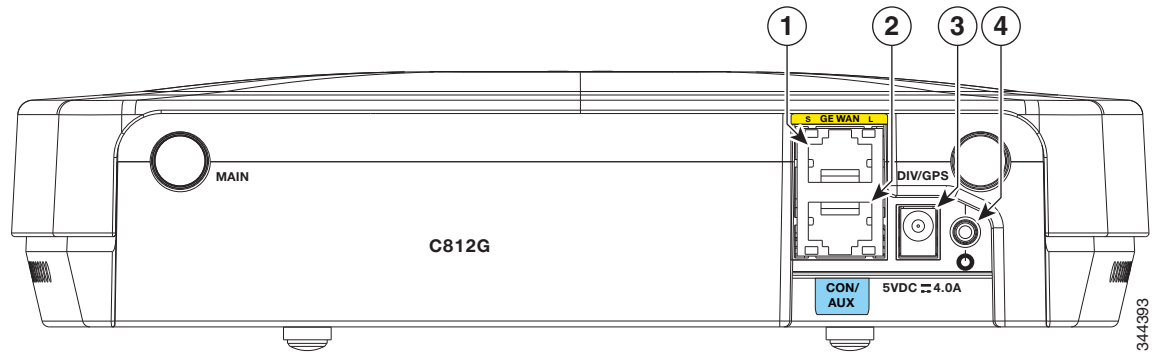

1	GE WAN port	3	Power connection port
2	Console/Aux port	4	Power switch

## Hardware Features

The Cisco 812 ISR supports the following hardware features:

- [Platform Features, page 1-4](#)
- [Antenna, page 1-5](#)
- [LEDs, page 1-5](#)
- [Memory, page 1-8](#)
- [Power Supply, page 1-8](#)



### Note

The WAAS Express feature is not supported. This feature will be supported for 3G and 4G interfaces with later IOS releases.

## Platform Features

The Cisco 812 ISR has the following platform features:

- 1x GE Enabled WAN (1000/100/10 Base T)
- 2 TNC connectors for 3G main and diversity antenna (diversity antenna multiplexed with GPS)
- 512 MB Compact Flash Memory
- 512 MB DRAM
- AC Power Brick (100–264 V and max 0.5 A)
- Optional PoE+ (802.3at Class 4) Power Splitter
- Built-in Grounding

- Ceiling and Wall Mounting Option
- LED indicators for the platform

## Antenna

The Cisco 812 ISR supports 3G external antenna and WiFi embedded antenna.

### 3G External Antenna

The Cisco 812 ISR provides two standard panel-mount TNC connectors to support 3G. The main antenna is used for the primary 3G antenna. The second can be used as a diversity receive only 3G antenna or an amplified GPS antenna. See [Figure 1-2](#) for the location of the antennas.

### WiFi Embedded Antenna

The Cisco 812 ISR supports Dual ports WiFi radios (802.11 a/b/g/n) with embedded 2x3 MIMO.

For compliance and safety information, see the [Regulatory Compliance and Safety Information for the Cisco 800 Series and SOHO Series Routers](#).

## LEDs

The Cisco 812 ISR has two LEDs located on the top side of the router. The 3G LED is located on the lower right side with respect to the Cisco logo. 3G LED supports multiple functions and colors. The WiFi LED is located on lower left side with respect to the Cisco logo. [Table 1-1](#) describes the 3G LED for the Cisco 812 ISR.

**Table 1-1 Cisco 812 3G LED Descriptions**

ROMMON Mode		
3G LED	LED Color	Description
System	Yellow	FPGA download is complete.
	Green (four blinks)	ROMMON is running.
	Off	No power. Incomplete FPGA download.
IOS 3G Mode		
3G Service Type	White	MC8700—2G (GPRS/EDGE) MC5728—1xRTT
	Green	MC8700—3G (UMTS) MC5728—EVDO Rev 0
	Light Blue	MC8700—3.5G (HSPA) MC5728—EVDO Rev A
	Blue	MC8700—3.7G (HSPA+) MC5728—N/A
	Off (solid)	No service.

**Table 1-1 Cisco 812 3G LED Descriptions (continued)**

ROMMON Mode		
3G LED	LED Color	Description
RSSI <sup>1</sup>	White, Green, Light Blue, or Blue (solid)	Signal > -60 dBm Very strong signal
	White, Green, Light Blue, or Blue (three blinks and then a long pause)	Signal <= -60 to 74 dBm Strong signal.
	White, Green, Light Blue, or Blue (two blinks and then a long pause)	Signal <= -75 to -89 dBm Fair signal.
	White, Green, Light Blue, or Blue (one blink and then a long pause)	Signal <= -90 to -109 dBm Marginal signal.
	Off	Signal <= -110 dBm Unusable signal.
Fault / Alarm	Amber (solid)	Fault detected.
	Red (four blinks)	Temperature alert.
	Red (solid)	Software failure. Power cycle.

1. The LED colors of RSSI can be any of the four colors (White, Green, Light Blue, or Blue) listed under 3G service type.

Table 1-2 describes the WiFi LED for the Cisco 812 ISR.

**Table 1-2 Cisco 812 ISR WiFi LED Descriptions**

Message Type	Color	Description
Boot loader status sequence	Blinking Green	DRAM memory test in progress.
		DRAM memory test is OK.
		Board initialization in progress.
		Initializing FLASH file system.
		Initializing Ethernet.
		Ethernet is OK.
		Starting Cisco IOS.
Association status	Green	Normal operating condition with no wireless client associated.
	Blue	Normal operating condition with at least one wireless client associated.
Operating status	Blinking Blue	Software upgrade in progress.
	Rapidly cycling through Blue, Green, Red, and White	Access point location command invoked.
	Blinking Red	Ethernet link not operational.
	Yellow	Router is powered up. FPGA download is complete.
	Blinking Green	LED blinks four times when ROMMON is up.
Boot loader warnings	Blinking Blue	Configuration recovery in progress. (MODE button pushed for 2 to 3 seconds)
	Red	Ethernet failure.
	Blinking Green	Image recovery in progress (MODE button released).
Boot loader errors	Red	DRAM memory test failure.
	Blinking Red and Blue	FLASH file system failure.
	Blinking Red and Off	Environment variable failure.
		Bad MAC address.
		Ethernet failure during image recovery.
		Boot environment failure.
		No Cisco image file.
Boot failure.		

**Table 1-2 Cisco 812 ISR WiFi LED Descriptions (continued)**

Message Type	Color	Description
Cisco IOS errors	Red	Software failure. Try to disconnect and reconnect the unit power.
	Cycling through Blue, Green, Red, and Off	General warning.

## Memory

The Cisco 812 ISR supports 512 MB DRAM and 512 MB compact flash memory. The Host router software runs on the first core. The second core runs the WLAN Access Point software.

If WLAN is not supported in an SKU, all 512 MB DRAM memory is allocated to the first core. For the SKUs that support WLAN, 128 MB out of the 512 MB main memory is allocated to the second core.

If WLAN is not supported in an SKU, all 512 MB DRAM compact flash memory is allocated to the first core. For the SKUs that support WLAN, 64 MB out of the 512 MB main memory is allocated to the second core.

## Power Supply

The following are power adapters supported in the Cisco 812 ISR:

- [AC Power Adapter, page 1-8](#)
- [PoE+ Splitter, page 1-8](#)

### AC Power Adapter

The default configuration is AC adapter that supports up to 4 A of 5 VDC current. The supported AC power adapter is PWR2-20W-AC that has a nominal input voltage of 100 to 240 VAC.

### PoE+ Splitter

The Cisco PoE+ splitter (C810-POE-SPL) splits PoE+ into power and GE. It has connectors built into the power supply at both input and output so cables can be used at desired length as an option. [Figure 1-4](#) shows the I/O side of the PoE+ splitter.



Figure 1-4 PoE+ Splitter I/O Side

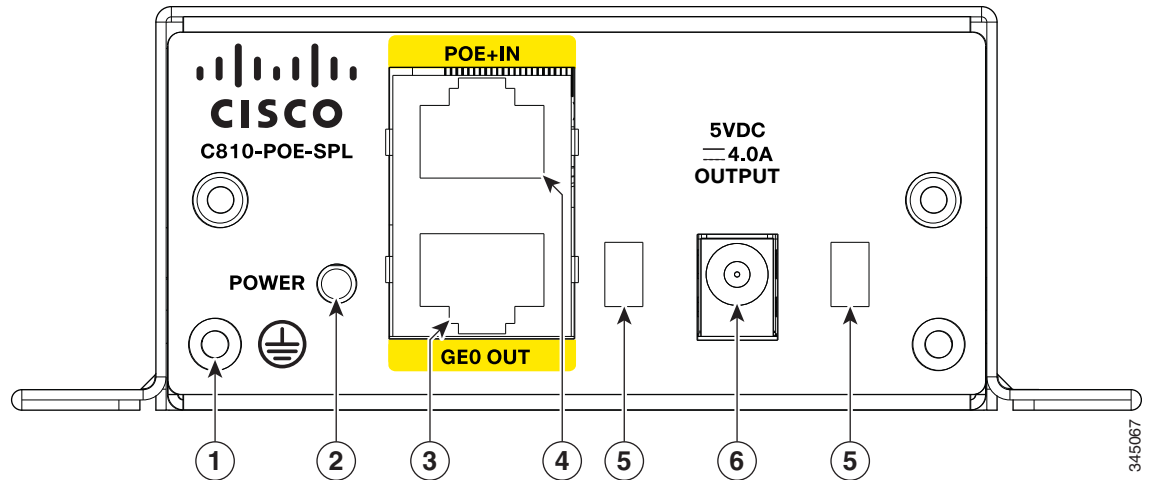

1	Grounding location	4	PoE+ input
2	Power status LED	5	Openings for power cord latch to lock into enclosure
3	GEO output	6	Input power connection

## SKU Information

Table 1-3 lists the different SKUs available for the Cisco 812 ISR. The AP802-AGN-X-K9 (WLAN PID) is integrated as part of the router for the SKUs that support WLAN and is not orderable separately.

Table 1-3 Supported SKUs

SKU ID	WLAN PID	Description
C812G+7-K9	—	C812 Secure Router Standalone Unit (non-US) 3.7G HSPA + Release 7 with SMS/GPS WLAN is not supported.
C812G-CIFI+7-E-K9	AP802-AGN-E-K9	C812 Secure Router (non-US) 3.7G HSPA + Release 7 with SMS/GPS and Dual WiFi Radio with ETSI
C812G-CIFI+7-N-K9	AP802-AGN-N-K9	C812 Secure Router (non-US) 3.7G HSPA + Release 7 with SMS/GPS and Dual WiFi Radio with ANZ
C812G-CIFI-V-A-K9	AP802-AGN-A-K9	C812 Secure Router for Verizon EV-DO Rev A with SMS/GPS and Dual WiFi Radio with FCC
C812G-CIFI-S-A-K9	AP802-AGN-A-K9	C812 Secure Router for Sprint EV-DO Rev A with SMS/GPS and Dual WiFi Radio with FCC

## Cisco 819 Series

This section provides an overview of the features available for the Cisco 819 and Cisco 819H Integrated Services Routers (ISRs) and contains the following sections:

- [General Description, page 1-10](#)
- [SKU Information, page 1-14](#)
- [Hardware Features, page 1-27](#)



Note

---

Cisco 819 is used to refer to Cisco 819HG, Cisco 819G, Cisco 819H, Cisco 819GW, Cisco 819HGW, Cisco 819HWD, Cisco 819HG-4G, and Cisco 819G-4G ISRs unless specifically called out otherwise.

---



Note

---

This product is a Class 1 Outside Plant (OSP) as per Telcordia GR-3108.

---



Note

---

For compliance and safety information, see *Regulatory Compliance and Safety Information Roadmap* that ships with the router and [Regulatory Compliance and Safety Information for Cisco 800 Series and SOHO Series Routers](#).

---

## General Description

The Cisco 819 Integrated Services Router, part of the Cisco Integrated Services Routers Generation 2 (ISR G2) Family designed in compact hardened and non-hardened form factors, is the smallest Cisco IOS Software router with support for integrated fourth-generation (4G LTE) and third-generation (3G) wireless WAN (mobile broadband backhaul). The Cisco 819GW now supports Dual 802.11 a/b/g/n radios WiFi. The Cisco 819 ISR machine-to-machine gateway provides a rapidly deployable, highly available, reliable, and secure solution into machine-to-machine applications for financial, telemetry, utility, retail, industrial automation, and transportation with comprehensive management capability. Transparently integrated into Cisco IOS Software as an enterprise-class feature, the Cisco 819 Hardened ISR provides highly secure data, voice, and video communications to stationary and mobile network nodes across wired and wireless links.

Available in both non-hardened (Cisco 819G) and hardened (Cisco 819HG) versions, the Cisco 819 supporting 4G LTE and 3G wireless WAN (WWAN) speeds offers a cost-effective, rapidly deployable, reliable, and secure primary or backup solution. With support for industrial-grade components, the hardened Cisco 819HG extends the ISR machine-to-machine gateway footprint and provides the flexibility for deployment in many different stationary and mobile environments where space, heat dissipation, exposure to extreme temperatures, harsher environments, and low power consumption are critical factors. For mobile applications, Mobile IP delivers transparent roaming across multiple wireless networks capable of covering wide geographic areas.

The Cisco 819 ISR is a standard form factor with a commercial operating range. The 3G Cisco 819 ISRs support the 3G speeds (High-Speed PacketAccess Plus [HSPA+] enabling up to 4G speeds and Evolution Data Optimized [EVDO Rev A]). They are backward-compatible with High-Speed Packet Access (HSPA), Universal Mobile Telecommunications Service (UMTS), Enhanced Data Rates for Global Evolution (EDGE), General Packet Radio Service (GPRS), and EVDO Rev 0/1xRTT.

The 4G LTE C819 supports the latest Third-Generation Partnership Project (3GPP) Release 8 LTE standards. The Cisco 4G multimode LTE WWAN C819 provides persistent and reliable LTE connectivity with fallback and transparent handoff to earlier technologies. The Cisco 819HG-4G and Cisco 819G-4G support multimode 4G LTE and have embedded Sierra Wireless multimode modem.

The Cisco 819 ISR is a desktop form factor with built-in wall-mount features, floor mount, and DIN rail mount features in selected SKUs. These routers are powered by an external AC power or optional DC adapter. [Figure 1-5](#) shows the Cisco 819HG ISR.

The Cisco 819GW ISRs support WiFi radios with a higher memory density and a new barrel-type power connector. A Wireless Local Area Network (WLAN) implements a flexible data communication system frequently augmenting rather than replacing a wired LAN within a building or campus. WLANs use radio frequency to transmit and receive data over the air, minimizing the need for wired connections. [Figure 1-6](#) shows the Cisco 819GW ISR.

The Cisco 819GW ISRs have the following additional features:

- Dual 802.11 a/b/g/n radios
- External WiFi antenna
- WLAN LED

**Figure 1-5** Cisco 819HG Integrated Services Router

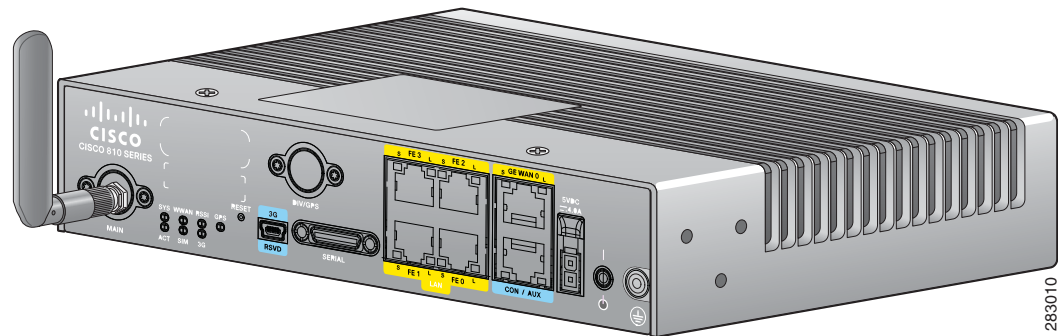

Figure 1-6 Cisco 819HGW Integrated Services Router

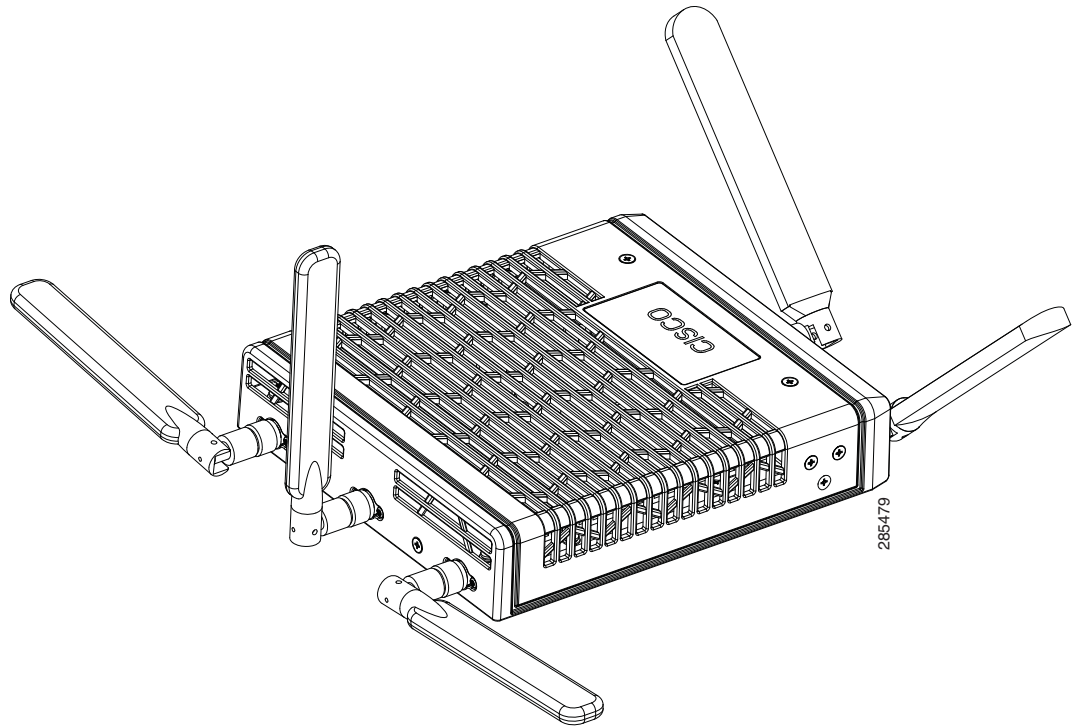
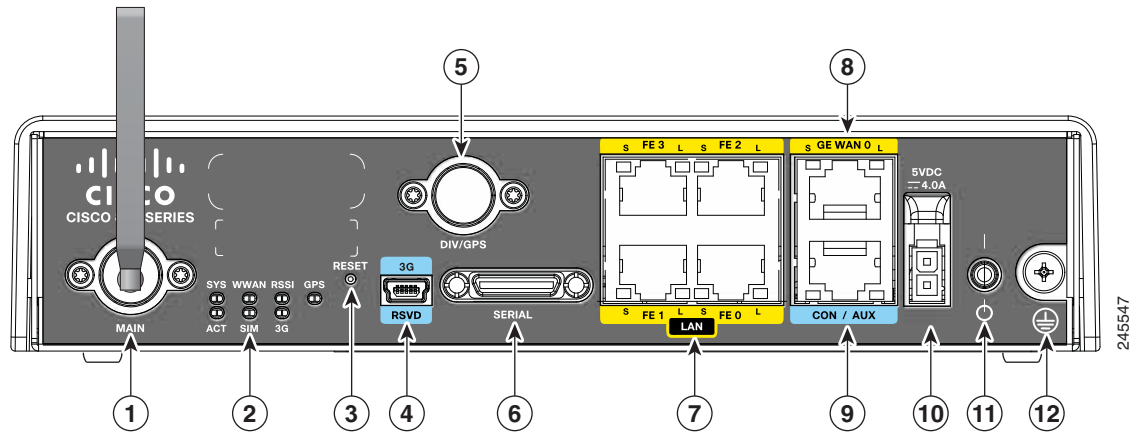

Figure 1-7 shows the front panel details of the Cisco 819HG ISR.

Figure 1-7 Cisco 819HGW ISR Front Panel



1	3G main antenna	7	FE ports
2	LEDs	8	GE WAN port
3	Reset button	9	Console/Aux port

4	3G mini-USB diagnostic port	10	5 VDC molex power input
5	Diversity/GPS antenna	11	Power switch
6	12-in-1 serial port	12	Ground

Figure 1-8 shows the front panel details of the Cisco 819HGW ISR.

Figure 1-8 Cisco 819HGW ISR Front Panel

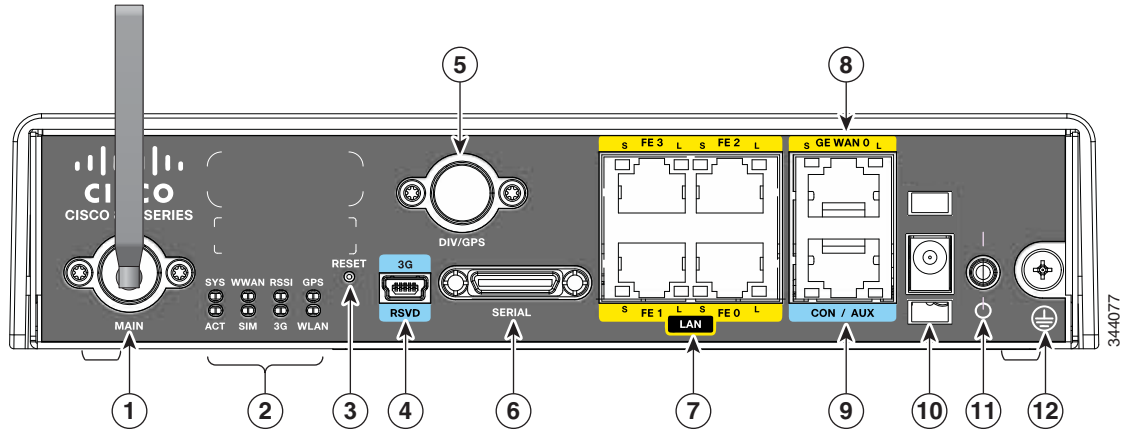

1	3G main antenna	7	FE ports
2	LEDs	8	GE WAN port
3	Reset button	9	Console/Aux port
4	3G mini-USB diagnostic port	10	5 VDC barrel-type power input
5	Diversity/GPS antenna	11	Power switch
6	12-in-1 serial port	12	Ground

Figure 1-9 shows the front panel details of the Cisco 819 4G LTE ISR.

Figure 1-9 Cisco 819 4G LTE ISR Front Panel

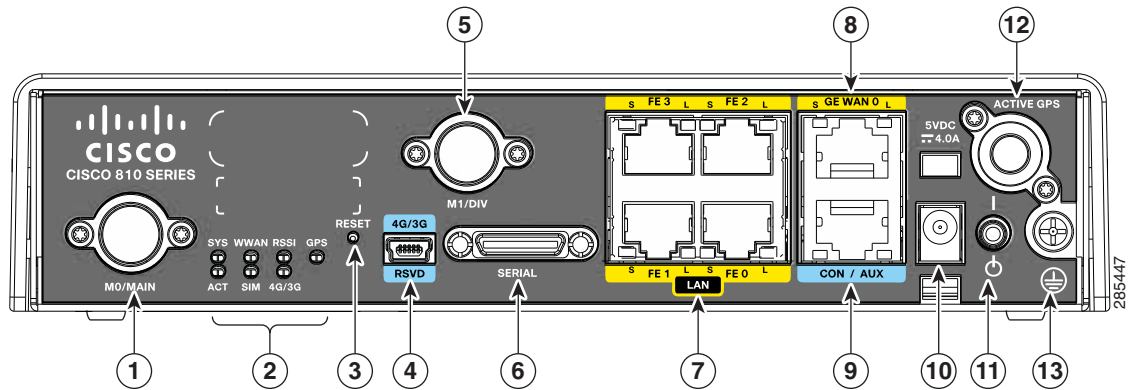

1	4G antenna connector—M0/MAIN	8	GE WAN port
2	LEDs	9	Console/Aux port
3	Reset button	10	Power input
4	4G/3G port	11	Power switch
5	4G antenna connector—M1/DIV	12	Active GPS antenna connector
6	Serial port	13	Ground
7	FE ports		

## SKU Information

Table 1-4 lists the different 3G SKUs available for the Cisco 819HG and Cisco 819G ISRs. All SKUs support external antenna.



### Note

WLAN is not supported.

Table 1-4 Supported 3G SKUs for Cisco 819HG and Cisco 819G ISRs

SKU ID	Description
C819HG+7-K9	Compact Hardened 3G IOS Router with Global HSPA + Release 7 based on MC8705
C819HG-U-K9	Compact Hardened 3G IOS Router with GLOBAL HSPA Release 6 based on MC8795V
C819HG-V-K9	Compact Hardened 3G IOS Router with Verizon EVDO Rev A based on MC5728V
C819HG-S-K9	Compact Hardened 3G IOS Router with Sprint EVDO Rev A based on MC5728V

**Table 1-4 Supported 3G SKUs for Cisco 819HG and Cisco 819G ISRs (continued)**

SKU ID	Description
C819HG-B-K9	Compact Hardened 3G IOS Router with Bharat generic EVDO Rev A based on MC5728V
C819G+7-K9	Compact Non-hardened 3G IOS Router with Global HSPA + Release 7 based on MC8705
C819G-U-K9	Compact Non-hardened 3G IOS Router with GLOBAL HSPA Release 6 based on MC8795V
C819G-V-K9	Compact Non-hardened 3G IOS Router with Verizon EVDO Rev A based on MC5728V
C819G-S-K9	Compact Non-hardened 3G IOS Router with Sprint EVDO Rev A based on MC5728V
C819G-B-K9	Compact Non-hardened 3G IOS Router with Bharat generic EVDO Rev A based on MC5728V

Table 1-5 lists the different SKUs available for the Cisco 819HGW, Cisco 819H, and Cisco 819HWD ISRs.

Table 1-5 Supported SKUs for Cisco 819HGW, Cisco 819H, and Cisco 819HWD ISRs

SKU ID	WLAN ID	WiFi External Antenna Support	Description
C819HGW+7-E-K9	AP802H-AGN-E-K9	Yes	Cisco 819 Secure Hardened M2M GW (non-US) 3.7G HSPA + Release 7 with SMS/GPS and Dual WiFi Radio with ETSI
C819HGW+7-N-K9	AP802H-AGN-N-K9	Yes	Cisco 819 Secure Hardened M2M GW (non-US) 3.7G HSPA + Release 7 with SMS/GPS and Dual WiFi Radio with ANZ
C819HGW+7-A-A-K9	AP802H-AGN-A-K9	Yes	Cisco 819 Secure Hardened M2M GW (North America) 3.7G HSPA + Release 7 with SMS/GPS and Dual WiFi Radio with FCC for ATT
C819HGW-V-A-K9	AP802H-AGN-A-K9	Yes	Cisco 819 Secure Hardened Router for Verizon EV-DO Rev A with SMS/GPS and Dual WiFi Radio with FCC
C819HGW-S-A-K9	AP802H-AGN-A-K9	Yes	Cisco 819 Secure Hardened Router for Sprint EV-DO Rev A with SMS/GPS and Dual WiFi Radio with FCC
C819H-K9	—	—	Cisco 819 Secure Hardened Router with Serial WLAN and 3G are not supported
C819HWD-E-K9	AP802H-AGN-E-K9	Yes	Cisco 819 Secure Hardened Router and Dual WiFi Radio with ETSI 3G is not supported
C819HWD-A-K9	AP802H-AGN-A-K9	Yes	Cisco 819 Secure Hardened Router and Dual WiFi Radio with FCC 3G is not supported



Table 1-6 lists the different 4G LTE SKUs available for the Cisco 819HG and Cisco 819G ISRs.

**Table 1-6 Supported 4G LTE SKUs for Cisco 819HG-4G and Cisco 819G-4G ISRs**

SKU ID	Mode	Operating Regions	Frequency Band	Description
C819HG-4G-V-K9	LTE—DOrA	North America	700 MHz (band 13) or LTE 800/1900 MHz for CDMA 1xRTT, 1xEVDO Rev A	Compact Hardened Cisco 819 router with multi mode LTE feature dedicated to Verizon Wireless networks. This comes with a Sierra Wireless MC7750 modem.
C819G-4G-V-K9	LTE—DOrA	North America	700 MHz (band 13) for LTE 800/1900 MHz for CDMA 1xRTT, 1xEVDO Rev A	Compact Non-hardened Cisco 819 router with multi mode LTE feature dedicated to Verizon Wireless networks. This comes with a Sierra Wireless MC7750 modem.
C819HG-4G-A-K9	LTE—HSPA+/ HSPA/UMTS/ EDGE/GPRS	North America	700 MHz (band 17)/AWS (band 4)/2100MHz (band 1) for LTE 800/850/1900/2100 MHz for UMTS/ HSPA+/HSPA 850/900/1800/1900 MHz for GSM/EDGE/GPRS	Compact Hardened Cisco 819 router with multi mode LTE feature dedicated to AT&T Wireless networks. This comes with a Sierra Wireless MC7700 modem.
C819G-4G-A-K9	LTE—HSPA+/ HSPA/UMTS/ EDGE/GPRS	North America	700 MHz(band 17)/AWS(band 4)/2100MHz(band 1) for LTE 800/850/1900/2100 MHz for UMTS/ HSPA+/HSPA 850/900/1800/1900 MHz for GSM/EDGE/GPRS	Compact Non-hardened Cisco 819 router with multi mode LTE feature dedicated to AT&T Wireless networks. This comes with a Sierra Wireless MC7700 modem.
C819HG-4G-G-K9	LTE—HSPA+/ HSPA/UMTS/ EDGE/GPRS	Global	800 MHz (band 20)/900 MHz (band 8)/1800 MHz (band 3)/2100 MHz (band 1)/2600 MHz (band 7) for LTE 900/2100 MHz for UMTS/ HSPA+/HSPA 900/1800/1900 MHz for GSM/EDGE/GPRS	Hardened Cisco 819 router with multi-mode LTE feature for global wireless networks. This comes with a Sierra Wireless MC7710 modem.

Table 1-6 Supported 4G LTE SKUs for Cisco 819HG-4G and Cisco 819G-4G ISRs (continued)

SKU ID	Mode	Operating Regions	Frequency Band	Description
C819G-4G-GA-K9	LTE—HSPA+/ HSPA/UMTS/ EDGE/GPRS	Global (Europe, Australia and New Zealand)	LTE—800 MHz (band 20)/900 MHz (band 8)/1800 MHz (band 3)/2100 MHz (band 1)/2600 MHz (band 7)  3G—800 MHz (band 6)/850 MHz (band 5)/900 MHz (band 8) /1900 MHz (band 2) 2100 MHz (band 1) for UMTS/ HSPA+/HSPA  2G—850/900/1800/1900 MHz for GSM/EDGE/GPRS	Non-hardened Cisco 819 router with multi-mode LTE feature for global wireless networks. This comes with a Sierra Wireless MC7304 modem.
C819G-4G-NA-K9	<ul style="list-style-type: none"> <li>• LTE</li> <li>• HSPA+</li> <li>• HSPA</li> <li>• UMTS</li> <li>• EDGE</li> <li>• GPRS</li> </ul>	North America (AT&T, Bell-Canada, Roger, Telus, and other GSM/LTE operators in USA and Canada)	LTE: <ul style="list-style-type: none"> <li>• AWS (band 4)</li> <li>• 700 MHz (band 5)</li> <li>• 850 MHz (band 17)</li> <li>• 1900 MHz (band 2)</li> <li>• 2600 MHz (band 7)</li> </ul> UMTS, HSPA+, HSPA: <ul style="list-style-type: none"> <li>• 1900 MHz (band 2)</li> <li>• AWS (band 4)</li> <li>• 850 (band 5)</li> </ul> GSM, EDGE, GPRS: <ul style="list-style-type: none"> <li>• 850 MHz</li> <li>• 900 MHz</li> <li>• 1800 MHz</li> <li>• 1900 MHz</li> </ul>	Non-hardened Cisco 819 router with multi-mode LTE feature for AT & T wireless networks. This comes with a Sierra Wireless MC7354 modem

Table 1-6 Supported 4G LTE SKUs for Cisco 819HG-4G and Cisco 819G-4G ISRs (continued)

SKU ID	Mode	Operating Regions	Frequency Band	Description
C819G-4G-ST-K9	<ul style="list-style-type: none"> <li>• LTE</li> <li>• EVDO Rev-A</li> <li>• 1xRTT</li> </ul>	North America (Sprint)	LTE: <ul style="list-style-type: none"> <li>• AWS (band 4)</li> <li>• 700 MHz (band 13)</li> <li>• PCS 1900 MHz (band 25)</li> </ul> 3G: <ul style="list-style-type: none"> <li>• 800 MHz (band class 0)</li> <li>• 1900 MHz (band class 1)</li> <li>• 800 MHz (band class 10)</li> </ul> 2G: <ul style="list-style-type: none"> <li>• 800 MHz (band class 0)</li> <li>• 1900 MHz (band class 1)</li> <li>• 800 MHz (band class 10)</li> </ul>	Non-hardened Cisco 819 router with multi-mode LTE feature for Sprint wireless networks. This comes with a Sierra Wireless MC7350 modem.
C819G-4G-VZ-K9	<ul style="list-style-type: none"> <li>• LTE</li> <li>• EVDO Rev-A</li> <li>• 1xRTT</li> </ul>	North America (Verizon)	LTE: <ul style="list-style-type: none"> <li>• AWS (band 4)</li> <li>• 700 MHz (band 13)</li> <li>• PCS 1900 MHz (band 25)</li> </ul> 3G: <ul style="list-style-type: none"> <li>• 800 MHz (band class 0)</li> <li>• 1900 MHz (band class 1)</li> <li>• 800 MHz (band class 10)</li> </ul> 2G: <ul style="list-style-type: none"> <li>• 800 MHz (band class 0)</li> <li>• 1900 MHz (band class 1)</li> <li>• 800 MHz (band class 10)</li> </ul>	Non-hardened Cisco 819 router with multi-mode LTE feature for Verizon wireless networks. This comes with a Sierra Wireless MC7350 modem.

Table 1-6 Supported 4G LTE SKUs for Cisco 819HG-4G and Cisco 819G-4G ISRs (continued)

SKU ID	Mode	Operating Regions	Frequency Band	Description
C819GW-LTE-MNA-AK9	<ul style="list-style-type: none"> <li>• LTE</li> <li>• HSPA+</li> <li>• EVDO Revision A (DOrA)</li> <li>• CDMA</li> <li>• EDGE/GPRS/GSM</li> </ul>	North America	<p>For LTE:</p> <ul style="list-style-type: none"> <li>• 700 MHz (Band 13)</li> <li>• 700 MHz (Band 17)</li> <li>• 800 MHz (Band 5)</li> <li>• 1900 MHz (Band 2)</li> <li>• 1900 MHz (Band 25)</li> <li>• AWS 1700/2100 MHz (Band 4)</li> </ul> <p>For HSPA+:</p> <ul style="list-style-type: none"> <li>• 850 MHz (Band 5)</li> <li>• 900 MHz (Band 8)</li> <li>• 1900 MHz (Band 2)</li> <li>• 2100 MHz (Band 1)</li> <li>• AWS 1700/2100 MHz (Band 4)</li> </ul> <p>For CDMA and EVDO Revision A:</p> <ul style="list-style-type: none"> <li>• 800 MHz (Band Class 0)</li> <li>• 1900 MHz (Band Class 1)</li> <li>• 800 MHz (Band Class 10)</li> </ul> <p>For EDGE/GPRS/GSM:</p> <ul style="list-style-type: none"> <li>• 850 MHz</li> <li>• 900 MHz</li> <li>• 1800 MHz</li> <li>• 1900 MHz</li> </ul>	<p>C819GW-LTE-MNA-AK9 is a dedicated Multimode LTE SKU for North American wireless networks and comes with a Sierra Wireless MC7354MNA modem.</p> <p>C819GW-LTE-MNA-AK9 is a non-hardened Cisco 819 Series Router.</p> <p>For 3GPP compliance, the extended temperature range for this SKU is -15 to 50C. For non-3GPP compliance, it is -15 to 55C.</p> <p>Dual SIMs in this SKU provide high reliability and cellular multihoming support for LTE and HSPA-based networks using the common FW technology within the same region. Dual SIMs in the North American SKUs provide switchover with different FW technology.</p> <p><b>Note</b> This is a 4G+ WiFi SKU. This SKU supports all North American carriers like Verizon, ATT, Sprint, and Canada using MC7354MNA modems.</p>

Table 1-6 Supported 4G LTE SKUs for Cisco 819HG-4G and Cisco 819G-4G ISRs (continued)

SKU ID	Mode	Operating Regions	Frequency Band	Description
C819G-LTE-MNA-K9	<ul style="list-style-type: none"> <li>• LTE</li> <li>• HSPA+</li> <li>• EDGE/GPRS/GSM</li> <li>• CDMA</li> <li>• EVDO</li> </ul>	North America	<p>LTE:</p> <ul style="list-style-type: none"> <li>• 850MHz(band 19)</li> <li>• 1500MHz(band 21)</li> <li>• 2100MHz(band 1)</li> </ul> <p>3G(UMTS,HSPA+,HSPA):</p> <ul style="list-style-type: none"> <li>• 800MHz(band 6)</li> <li>• 850MHz(band 5)</li> <li>• 850MHz(band 19)</li> <li>• 2100MHz(band 1)</li> </ul> <p>2G(GSM,EDGE,GPRS):</p> <ul style="list-style-type: none"> <li>• 850MHz</li> <li>• 900MHz</li> <li>• 1800MHz</li> <li>• 1900MHz</li> </ul>	<p>C819G-LTE-MNA-K9 is a dedicated Multimode LTE SKU for global wireless network and comes with a Sierra Wireless MC7354-MNA modem.</p> <p>C819G-LTE-MNA-K9 is a non-hardened Cisco 819 Series Router.</p> <p>For 3GPP compliance, the extended temperature range for this SKU is -15 to 50C. For non-3GPP compliance, it is -15 to 55C.</p> <p>Dual SIMs in this SKU provide high reliability and cellular multihoming support for LTE and HSPA-based networks using the common FW technology within the same region. Dual SIMs provide switchover with different FW technology.</p> <p><b>Note</b> This SKU does not have a WiFi module.</p>

Table 1-6 Supported 4G LTE SKUs for Cisco 819HG-4G and Cisco 819G-4G ISRs (continued)

SKU ID	Mode	Operating Regions	Frequency Band	Description
C819HG-LTE-MNA-K9	<ul style="list-style-type: none"> <li>• LTE</li> <li>• HSPA+</li> <li>• EDGE/GPRS/GSM</li> <li>• CDMA</li> <li>• EVDO</li> </ul>	North America	<p>LTE:</p> <ul style="list-style-type: none"> <li>• AWS (band 4)</li> <li>• 850MHz(band 19)</li> <li>• 1500MHz(band 21)</li> <li>• 2100MHz(band 1)</li> </ul> <p>3G(UMTS,HSPA+,HSPA):</p> <ul style="list-style-type: none"> <li>• 800MHz(band 6)</li> <li>• 850MHz(band 5)</li> <li>• 850MHz(band 19)</li> <li>• 2100MHz(band 1)</li> </ul> <p>2G(GSM,EDGE,GPRS):</p> <ul style="list-style-type: none"> <li>• 850MHz</li> <li>• 900MHz</li> <li>• 1800MHz</li> <li>• 1900MHz</li> </ul>	<p>C819HG-LTE-MNA-K9 is a dedicated Multimode LTE SKU for North American wireless networks and comes with a Sierra Wireless MC7354-MNA modem.</p> <p>C819G-LTE-MNA-K9 is a hardened Cisco 819 Series Router.</p> <p>For 3GPP compliance, the extended temperature range for this SKU is -15 to 50C. For non-3GPP compliance, it is -15 to 55C.</p> <p>Dual SIMs in this SKU provide high reliability and cellular multihoming support for LTE and HSPA-based networks using the common FW technology within the same region. Dual SIMs provide switchover with different FW technology.</p> <p><b>Note</b> This SKU does not have a WiFi module.</p>

Table 1-6 Supported 4G LTE SKUs for Cisco 819HG-4G and Cisco 819G-4G ISRs (continued)

SKU ID	Mode	Operating Regions	Frequency Band	Description
C819G-LTE-LA-K9	<ul style="list-style-type: none"> <li>• LTE</li> <li>• HSPA+</li> <li>• HSPA</li> <li>• UMTS</li> </ul>	Latin America/APAC	<p>For FDD LTE:</p> <ul style="list-style-type: none"> <li>• 700 MHz (band 28)</li> <li>• 850 MHz (band 5)</li> <li>• 800 MHz (band 19)</li> <li>• 800 MHz (band 18)</li> <li>• 900 MHz (band 8)</li> <li>• 1800 MHz (band 3)</li> <li>• 2100 MHz (band 1)</li> <li>• 2600 MHz (band 7)</li> </ul> <p>For TDD LTE:</p> <ul style="list-style-type: none"> <li>• 1900 MHz (Band 39)</li> <li>• 2300 MHz (Band 40)</li> <li>• 2500 MHz (Band 41)</li> <li>• 2600 MHz (Band 38)</li> </ul> <p>For UMTS, HSPA+, HSPA:</p> <ul style="list-style-type: none"> <li>• 800 MHz (band 6)</li> <li>• 800 MHz (band 19)</li> <li>• 850 MHz (band 5)</li> <li>• 900 MHz (band 8)</li> <li>• 1700 MHz (band 9)</li> <li>• 2100 MHz (band 1)</li> </ul>	C819G-LTE-LA-K9 is a dedicated Multimode LTE SKU for Latin American wireless networks and comes with a Sierra Wireless MC7430 modem.

Table 1-6 Supported 4G LTE SKUs for Cisco 819HG-4G and Cisco 819G-4G ISRs (continued)

SKU ID	Mode	Operating Regions	Frequency Band	Description
C819GW-LTE-LA-CK9	<ul style="list-style-type: none"> <li>• LTE</li> <li>• HSPA+</li> <li>• HSPA</li> <li>• UMTS</li> </ul>	Latin America/APAC	<p>For FDD LTE:</p> <ul style="list-style-type: none"> <li>• 700 MHz (band 28)</li> <li>• 850 MHz (band 5)</li> <li>• 800 MHz (band 19)</li> <li>• 800 MHz (band 18)</li> <li>• 900 MHz (band 8)</li> <li>• 1800 MHz (band 3)</li> <li>• 2100 MHz (band 1)</li> <li>• 2600 MHz (band 7)</li> </ul> <p>For TDD LTE:</p> <ul style="list-style-type: none"> <li>• 1900 MHz (Band 39)</li> <li>• 2300 MHz (Band 40)</li> <li>• 2500 MHz (Band 41)</li> <li>• 2600 MHz (Band 38)</li> </ul> <p>For UMTS, HSPA+, HSPA:</p> <ul style="list-style-type: none"> <li>• 800 MHz (band 6)</li> <li>• 800 MHz (band 19)</li> <li>• 850 MHz (band 5)</li> <li>• 900 MHz (band 8)</li> <li>• 1700 MHz (band 9)</li> <li>• 2100 MHz (band 1)</li> </ul>	<p>C819G-LTE-LA-CK9 is a dedicated Multimode LTE SKU for Latin American/APAC wireless networks and comes with a Sierra Wireless MC7430 modem.</p> <p>C819GW-LTE-LA-CK9 comes with WiFi-C 802.11n dual radio.</p>



Table 1-6 Supported 4G LTE SKUs for Cisco 819HG-4G and Cisco 819G-4G ISRs (continued)

SKU ID	Mode	Operating Regions	Frequency Band	Description
C819GW-LTE-LA-QK9	<ul style="list-style-type: none"> <li>• LTE</li> <li>• HSPA+</li> <li>• HSPA</li> <li>• UMTS</li> </ul>	Latin America/APAC	<p>For FDD LTE:</p> <ul style="list-style-type: none"> <li>• 700 MHz (band 28)</li> <li>• 850 MHz (band 5)</li> <li>• 800 MHz (band 19)</li> <li>• 800 MHz (band 18)</li> <li>• 900 MHz (band 8)</li> <li>• 1800 MHz (band 3)</li> <li>• 2100 MHz (band 1)</li> <li>• 2600 MHz (band 7)</li> </ul> <p>For TDD LTE:</p> <ul style="list-style-type: none"> <li>• 1900 MHz (Band 39)</li> <li>• 2300 MHz (Band 40)</li> <li>• 2500 MHz (Band 41)</li> <li>• 2600 MHz (Band 38)</li> </ul> <p>For UMTS, HSPA+, HSPA:</p> <ul style="list-style-type: none"> <li>• 800 MHz (band 6)</li> <li>• 800 MHz (band 19)</li> <li>• 850 MHz (band 5)</li> <li>• 900 MHz (band 8)</li> <li>• 1700 MHz (band 9)</li> <li>• 2100 MHz (band 1)</li> </ul>	<p>C819GW-LTE-LA-QK9 is a dedicated Multimode LTE SKU for Latin American / APAC wireless networks and comes with a Sierra Wireless MC7430 modem.</p> <p>C819GW-LTE-LA-QK9 comes with WiFi-Q 802.11n dual radio.</p>

Table 1-6 Supported 4G LTE SKUs for Cisco 819HG-4G and Cisco 819G-4G ISRs (continued)

SKU ID	Mode	Operating Regions	Frequency Band	Description
C819GW-LTE-LA-NK9	<ul style="list-style-type: none"> <li>• LTE</li> <li>• HSPA+</li> <li>• HSPA</li> <li>• UMTS</li> </ul>	Latin America / APAC	<p>For FDD LTE:</p> <ul style="list-style-type: none"> <li>• 700 MHz (band 28)</li> <li>• 850 MHz (band 5)</li> <li>• 800 MHz (band 19)</li> <li>• 800 MHz (band 18)</li> <li>• 900 MHz (band 8)</li> <li>• 1800 MHz (band 3)</li> <li>• 2100 MHz (band 1)</li> <li>• 2600 MHz (band 7)</li> </ul> <p>For TDD LTE:</p> <ul style="list-style-type: none"> <li>• 1900 MHz (Band 39)</li> <li>• 2300 MHz (Band 40)</li> <li>• 2500 MHz (Band 41)</li> <li>• 2600 MHz (Band 38)</li> </ul> <p>For UMTS, HSPA+, HSPA:</p> <ul style="list-style-type: none"> <li>• 800 MHz (band 6)</li> <li>• 800 MHz (band 19)</li> <li>• 850 MHz (band 5)</li> <li>• 900 MHz (band 8)</li> <li>• 1700 MHz (band 9)</li> <li>• 2100 MHz (band 1)</li> </ul>	C819GW-LTE-LA-NK9 is a dedicated Multimode LTE SKU for Latin American / APAC wireless networks and comes with a Sierra Wireless MC7430 modem. C819GW-LTE-LA-NK9 comes with WiFi-N 802.11n dual radio.

### Re-branding of C8xx-B and EHWIC-3G-EVDO-B

The C881G-B-K9, C819G-B-K9, and EHWIC-EVDO-B (Bharat) SKUs are introduced as an umbrella SKU to cover BSNL, Tata, and Reliance service providers in India.

Software based mechanism is introduced to identify specific carrier.

Carrier ID and name are displayed under "*show cellular <unit> hardware*".

The software mechanism is backward compatible with other existing CDMA SKUs such as HWIC-3G-CDMA(-S,-V) and PCEX-3G-CDMA(-S,-V).

#### Cisco IOS Requirement

15.3(2)T, 15.3(3)M or later. New MIB objects for carrier ID and name will be introduced in later release.

#### Sample CLI Output

```
Router#show cellular 0/0/0 hardware
Modem Firmware Version = p2813301
Modem Firmware built = 06-24-10
Hardware Version = MC5728V Rev 1.0
```

```
Electronic Serial Number (ESN) = 0x60E62C87 [09615084679] Preferred Roaming List (PRL)
Version = 10 PRI SKU ID = 535479 Carrier ID = 19 Carrier Name = Reliance Current Modem
Temperature = 30 degrees Celsius Endpoint Port Map = 75
Router#
```

```
Router#show cellular 0/1/0 hardware
Modem Firmware Version = p2813301
Modem Firmware built = 06-24-10
Hardware Version = MC5728V Rev 1.0
Electronic Serial Number (ESN) = 0x60E62431 [09615082545] Preferred Roaming List (PRL)
Version = 10 PRI SKU ID = 535479 Carrier ID = 29 Carrier Name = Tata Current Modem
Temperature = 30 degrees Celsius Endpoint Port Map = 75
Router#
```

## Hardware Features

This section provides an overview of the following hardware features for the Cisco 819 ISR.

- [Platform Features for Cisco 819 ISRs, page 1-27](#)
- [Antennas, page 1-29](#)
- [Power Switch, page 1-29](#)
- [Reset Button, page 1-30](#)
- [LEDs, page 1-30](#)
- [Memory, page 1-34](#)
- [Embedded 3G Modem, page 1-34](#)
- [Embedded 4G LTE Modem, page 1-34](#)
- [SIM Card, page 1-34](#)
- [Supported Cisco Antennas and Cables, page 1-35](#)
- [Serial Port, page 1-40](#)
- [Power Supply, page 1-41](#)
- [Accessories, page 1-42](#)

**Note**

---

The WAAS Express feature is not supported in 3G and 4G interfaces. However, the WAAS Express feature is supported on the Cisco 819H platform with other type of interfaces.

---

### Platform Features for Cisco 819 ISRs

[Table 1-7](#) lists the platform features comparison for the Cisco 819 ISRs.

Table 1-7 Cisco 819 ISRs Platform Features

Platform Features	Cisco 819HG Cisco 819G (with 3G)	Cisco 819HGW Cisco 819HWD (with 3G and WiFi)	Cisco 819HG-4G Cisco 819G-4G (with 4G LTE)	Cisco 819GW (with 4G LTE and WiFi)
512 MB DRAM	Yes	—	—	—
1 GB DRAM	—	Yes	Yes	Yes
1 Gigabit Ethernet WAN port	Yes	Yes	Yes	Yes
12-in-1 serial interface	Yes	Yes	Yes	Yes
256 KB of NVRAM storage	Yes	Yes	Yes	Yes
256 Compact Flash support in IDE mode (internal)	Yes	—	—	—
1 GB Compact Flash support in IDE mode (internal)	—	Yes	Yes	Yes
Cisco EnergyWise	Yes	Yes	—	Yes
Dual 802.11 a/b/g/n Radios with Cisco DFS, CleanAir, and Client Link support	—	Yes	—	Yes
Embedded 3G modem	Yes	Yes	—	—
Embedded 4G LTE modem	—	—	Yes	Yes
Environmental monitoring and temperature logging	Yes	Yes	—	Yes
Four ports FE interconnect switch support	Yes	Yes	Yes	Yes
LED indicators for the platform	Yes	Yes	Yes	Yes
Onboard crypto acceleration	Yes	Yes	Yes	Yes
Power cord retention lock	—	Yes	Yes	Yes
Power switch lock	—	Yes	Cisco 819HG-4G ISRs only	Yes
Reset button	Yes	Yes	Yes	Yes

Table 1-7 Cisco 819 ISRs Platform Features (continued)

Platform Features	Cisco 819HG Cisco 819G  (with 3G)	Cisco 819HGW Cisco 819HWD  (with 3G and WiFi)	Cisco 819HG-4G Cisco 819G-4G  (with 4G LTE)	Cisco 819GW   (with 4G LTE and WiFi)
Real Time Clock (RTC) <sup>1</sup>	Yes	Yes	Yes	Yes
ScanSafe	Yes	Yes	—	Yes
Single console/AUX port	Yes	Yes	Yes	Yes
SNMP	Yes	Yes	—	Yes
TFTP support with Ethernet WAN interface	—	Yes	—	Yes
Warm reload	Yes	Yes	—	Yes

1. A real-time clock (RTC) with battery backup provides date and time when the system is powered on. The RTC is used to verify the validity of the Certification Authority stored on the router.

## Antennas

The Cisco 819 3G routers provide two standard panel-mount TNC connectors to support the 3G antenna and the diversity and GPS external antenna. The main antenna is used for the primary 3G antenna. The second can be used as a diversity receive only 3G antenna or GPS antenna that does not require power supply from the router.

The Cisco 819 4G routers provide two standard panel-mount TNC connectors on the router front panel for the main and diversity antennas. The main antenna connector is used for the primary 4G antenna. The second antenna connector can be used as a diversity receive only 4G antenna. An SMA connector for active GPS antenna is also available on the front panel of the router.

The Cisco 819HGW and Cisco 819HWD ISRs also support Cisco WiFi external antennas. See the [“Supported Cisco Antennas and Cables”](#) section on page 1-35 for more information.

### WiFi External Antenna

The external WiFi antenna is used to support better WiFi coverage. All external antenna supports the following:

- Dual 802.11 a/b/g/n radios
- 2x3 MIMO
- Omnidirectional

## Power Switch

The power switch shuts down the router. A power switch lock is available to prevent accidental turning off of the router in the hardened SKUs.

## Reset Button

The Reset button resets the router configuration to the default configuration set by the factory. To restore the router configuration to the default configuration set by the factory, use a standard size #1 paper clip with wire gauge 0.033 inch or smaller and simultaneously press the reset button while applying power to the router.

## LEDs

The LEDs are located on the front panel of the router. [Table 1-8](#) describes the 3G LEDs for the Cisco 819 ISR.

**Table 1-8 3G LED Descriptions**

LED	Color	Description
SYS	Yellow	FPGA download is complete.
	Green (blinking)	ROMMON is operational.
	Green (solid)	IOS is operational.
	Green (four blinks during bootup)	Reset button has been pushed during the bootup.
	Off	After powering up, when FPGA is being downloaded (in ROMMON).
ACT	Green (blinking)	Network activity on FE Switch ports, GE WAN port, 3G cellular interface, and serial interfaces.
	Off	No network activity.
WWAN	Green	Module is powered on and connected but not transmitting or receiving.
	Green (slow blinking)	Module is powered on and searching for connection.
	Green (fast blinking)	Module is transmitting or receiving.
	Off	Module is not powered.
GPS	Green (solid)	Standalone GPS.
	Green (slow blinking)	GPS is acquiring.
	Yellow (solid)	Assisted GPS.
	Yellow (slow blinking)	Assisted GPS is acquiring.
	Off	GPS is not configured.

Table 1-8 3G LED Descriptions (continued)

LED	Color	Description
RSSI	Green (solid)	Signal > -60 dBm Very strong signal
	Green (three blinks and then a long pause)	Signal <= -60 to 74 dBm Strong signal
	Green (two blinks and then a long pause)	Signal <= -75 to -89 dBm Fair signa
	Green (one blink and then a long pause)	Signal <= -90 to -109 dBm Marginal signal
	Off	Signal <= -110 dBm Unusable signal
SIM <sup>1,2</sup>	Green / Yellow (one green blink followed by two yellow blinks)	SIM in slot 0 active, SIM in slot 1 is not.
	Yellow / Green (one yellow blink followed by two green blinks)	SIM in slot 1 active, SIM in slot 0 is not.
	Off / Green (two green blinks and then a pause)	No SIM in slot 0, SIM present in slot 1.
	Green / Off (Slow single green blink and then a pause)	SIM present in slot0, no SIM in slot 1.
	Off / Off	No SIM present in either slots.
3G	Green (one blink and then a pause)	For 1xRTT, EGPRS, or GPRS service.
	Green (two blinks and then a pause)	For EVDO, EVDO/1xRTT, or UMTS.
	Green (three blinks and then a pause)	For EVDO/1xRTT RevA, HSPA, or HSUPA/HSDPA.
	Green (solid)	For HSPA PLUS.
	Off	No Service.

1. Not applicable to Verizon and Sprint EVDO modems.
2. There is only one LED to indicate the status of two SIMs. A one-blink pattern represents the status of the SIM in slot 0, followed by a two-blink pattern for the SIM in slot 1.

Table 1-9 describes the WLAN LEDs for the Cisco 819HGW and Cisco 819HWD ISRs.

**Table 1-9 WLAN LED Descriptions**

WLAN LED	Color	Description
Boot loader status sequence	Blinking Green	Board initialization in progress.
		Initializing FLASH file system.
		Initializing Ethernet.
		Ethernet is OK.
		Starting Cisco IOS.
		Initialization is successful.
Association status	Green	Normal operating condition with no wireless client associated.
	Blue	Normal operating condition with at least one wireless client associated.
Operating status	Blinking Blue	Software upgrade in progress.
	Rapidly cycling through Green, Red, and White	Access point location command invoked.
	Blinking Red	Ethernet link is not operational.
Boot loader errors	Blinking Red and Blue	FLASH file system failure.
	Blinking Red and Off	Environment variable failure.
		Bad MAC address.
		Ethernet failure during the image recovery.
		Boot environment failure.
	No Cisco image file.	
	Boot failure.	
Cisco IOS errors	Red	Software failure. Try to disconnect and reconnect the unit power.

[Table 1-10](#) describes the 4G LTE LEDs for the Cisco 819 ISR.

**Table 1-10 4G LTE LED Descriptions**

LED	Color	Description
SYS	Yellow	FPGA download is complete.
	Green (blinking)	ROMMON is operational.
	Green (solid)	IOS is operational.
	Green (four blinks during bootup)	Reset button has been pushed during the bootup.
	Off	After powering up, when FPGA is being downloaded (in ROMMON).



Table 1-10 4G LTE LED Descriptions (continued)

LED	Color	Description
ACT	Green (blinking)	Network activity on FE Switch ports, GE WAN port, 3G cellular interface, and serial interfaces.
	Off	No network connectivity.
WWAN	Green	Module is powered on and connected but not transmitting or receiving.
	Green (slow blinking)	Module is powered on and searching for connection.
	Green (fast blinking)	Module is transmitting or receiving.
	Off	Module is not powered.
GPS	Green (solid)	Standalone GPS.
	Green (slow blinking)	GPS is acquiring.
	Yellow (solid)	Assisted GPS.
	Yellow (slow blinking)	Assisted GPS is acquiring.
	Off	GPS is not configured.
RSSI	Green (solid)	Signal > -60 dBm Very strong signal
	Green (three blinks and then a long pause)	Signal <= -60 to 74 dBm Strong signal
	Green (two blinks and then a long pause)	Signal <= -75 to -89 dBm Fair signal
	Green (one blink and then a long pause)	Signal <= -90 to -109 dBm Marginal signal
	Off	Signal <= -110 dBm Unusable signal
SIM	Green / Yellow (one green blink followed by two yellow blinks)	SIM in slot 0 is active, SIM in slot 1 is not.
	Yellow / Green (one yellow blink followed by two green blinks)	SIM in slot 1 is active, SIM in slot 0 is not.
	Off / Green (two green blinks and then a pause)	No SIM in slot 0, SIM present in slot 1.
	Green / Off (Slow single green blink and then a pause)	SIM present in slot 0, no SIM in slot 1.
	Off / Off	No SIM present in either slots.

**Table 1-10 4G LTE LED Descriptions (continued)**

LED	Color	Description
3G/4G	Green (one blink and then a pause)	For 1xRTT, EGPRS, or GPRS service.
	Green (two blinks and then a pause)	For EVDO, EVDO/1xRTT, or UMTS service.
	Green (three blinks and then a pause)	For EVDO/1xRTT RevA, HSPA, or HSUPA/HSDPA service.
	Green (four blinks and then a pause)	For HSPA+ service.
	Green (Solid)	For 4G/LTE service.
	Off	No Service.

## Memory

The Cisco 819HG and Cisco 819G ISRs uses non-upgradable flash memory and main memory. The onboard flash memory contains the Cisco IOS software image and the boot flash contains the ROMMON boot code. [Table 1-11](#) lists the memory requirements for Cisco 819 ISRs.

**Table 1-11 Memory Requirements for Cisco 819 ISRs**

Memory Requirements	Cisco 819HG Cisco 819G (with 3G)	Cisco 819HGW Cisco 819HWD (with WiFi)	Cisco 819HG-4G Cisco 819G-4G (with 4G LTE)
256 Compact Flash support in IDE mode (internal)	Yes	—	—
1 GB Compact Flash support in IDE mode (internal)	—	Yes	Yes
512 MB DRAM	Yes	—	—
1 GB DRAM	—	Yes	Yes

## Embedded 3G Modem

The 3G cellular interface is the primary WAN data link, but it can also be used as a backup data link. The 3G technology is third-generation wide-area cellular technology that is used in broadband wireless data in a mobile environment.

## Embedded 4G LTE Modem

The Cisco 819HG-4G and Cisco 819G-4G routers have an embedded 4G LTE modem provided by Sierra Wireless. The Verizon SKUs come with an MC7750 modem, the AT&T SKUs come with an MC7700 modem, and the Global SKUs come with an MC7710 modem.

## SIM Card

[Table 1-12](#) lists the SIM Card slots available for Cisco the 819 ISRs.

Table 1-12 SIM Card Slot

Two Internal SIM Card Slots	One Internal SIM Card Slot	No SIM Card Slot
C819G-U-K9	C819HG-4G-V-K9	C819HG-V-K9
C819G+7-K9	C819G-4G-V-K9	C819HG-S-K9
C819HG-U-K9	C819HG-4G-A-K9	C819G-V-K9
C819HG+7-K9	C819G-4G-A-K9	C819G-S-K9
C819HGW+7-A-A-K9	C819G-4G-VZ-K9	C819HGW-V-A-K9
C819HGW+7-E-K9	C819G-4G-ST-K9	C819HGW-S-A-K9
C819HGW+7-N-K9	C819G-4G-NA-K9	C819HG-B-K9
C819HG-4G-G-K9		C819G-B-K9
C819G-4G-G-K9		
C819GW-LTE-MNA-AK9		
C819GW-LTE-GA-EK9		
C819G-LTE-LA-K9		
C819G-4G-GA-K9		
C819G-LTE-MNA-K9		
C819HG-LTE-MNA-K9		
C819GW-LTE-LA-CK9		
C819GW-LTE-LA-QK9		
C819GW-LTE-LA-NK9		

### Supported Cisco Antennas and Cables

The Cisco 819 ISR provides two standard panel-mount TNC connectors to support the 3G antenna and the diversity and GPS external antenna. The main antenna is used for the primary 3G antenna. The second can be used as a diversity receive only 3G antenna or GPS antenna that does not require power supply from the router.



#### Note

A Lightning Arrestor must be used when you install antenna outdoor. Note that the center conductor is not protected under 200V (sparkover voltage nominal value).

Table 1-13 lists the Cisco 3G antennas that are supported for use on Cisco 819 ISRs.

**Table 1-13 Supported Cisco 3G Antennas**

Cisco Part Number	Antenna Type	Maximum Gain and Frequency Range	Description
3G-ANTM1919D	Dipole omnidirectional	0 dBi (806–960 MHz) 0 dBi (1710–2170 MHz)	This is the default antenna with dual faceplate mount. Multiband faceplate-mounted dipole antenna. For more information, see <a href="#">Cisco Multiband Swivel Mount Dipole Antenna (3G-ANTM1919D)</a> .
3G-ANTM1916-CM	High-gain ceiling-mount omnidirectional	1.5 dBi (806–960 MHz) 2.5 dBi (1710–2170 MHz)	Multiband ceiling-mounted omnidirectional antenna. For more information, see <a href="#">Cisco Multiband Omnidirectional Ceiling Mount Antenna (3G-ANTM1916-CM)</a> .
3G-AE015-R (Antenna Extension)	Extension base	0.8–6.0 GHz	This antenna extension is a base with a 15-foot cable included for use with a dipole omnidirectional antenna. For more information, see <a href="#">Cisco Single-Port Antenna Stand for Multiband TNC Male-Terminated Portable Antenna (3G-AE015-R)</a> .
3G-ANTM-OUT-OM	Outdoor Omnidirectional	+2 dBi 800/900 MHz +4 dBi 1800/1900/2100 MHz	This is an outdoor low-profile omnidirectional mast antenna. For more information, see <a href="#">Cisco 3G Omnidirectional Outdoor Antenna (3G-ANTM-OUT-OM)</a> .
3G-ANTM-OUT-LP	Low Profile Stick Antenna	–1.5 dBi 850, 900 MHz –2.5 dBi 1800, 1900, 2100 MHz	This is an omnidirectional stick antenna. For more information, see <a href="#">Cisco 3G Low Profile Outdoor Antenna (3G-ANTM-OUT-LP)</a> .
3G-ACC-OUT-LA (Lightning Arrestor)	Lightning Arrestor	800–2200 MHz	This is a quarter-wave lightning protector with integrated high-pass filter. For more information, see <a href="#">Cisco 3G Lightning Arrestor (3G-ACC-OUT-LA)</a> .

Table 1-14 lists the supported Cisco WiFi antenna for Cisco 819HGW and Cisco 819HWD ISRs.

**Table 1-14** Supported Cisco WiFi Antenna

Antenna	Frequency band(s)	Mounting Mechanical	IP Rating	Peak Gain 2.4 GHz (dBi)	Peak Gain 5 GHz (dBi)	Description
AIR-ANTM2050D-R	2.4–2.5 GHz 4.9–5.9 GHz	Faceplate Dipole	IP 41	1.4	4.5	This is the default antenna. For more information, see <a href="#">Cisco Multiband Swivel-Mount Dipole Antenna (AIR-ANTM2050D-R)</a> .
AIR-ANT2430V-R	2.4 GHz	Ceiling	IP 41	3	—	For more information, see <a href="#">Cisco Aironet 3-dBi Omnidirectional Antenna (AIR-ANT2430V-R)</a> .
AIR-ANT5140V-R	5 GHz	Ceiling	IP 41	—	4	For more information, see <a href="#">Cisco Aironet 4-dBi Omnidirectional Antenna (AIR-ANT5140V-R)</a> .
AIR-ANT2440NV-R	2.4 GHz	Multi-mount (Wall/Ceiling/Mast)	IP 54	4	—	For more information, see <a href="#">Cisco Aironet 2.4-GHz MIMO Wall-Mounted Omnidirectional Antenna (AIR-ANT2440NV-R)</a> .
AIR-ANT5140NV-R	5 GHz	Multi-mount (Wall/Ceiling/Mast)	IP 54	—	4	For more information, see <a href="#">Cisco Aironet 5-GHz MIMO Wall Mount Omnidirectional Antenna (AIR-ANT5140NV-R)</a> .

Table 1-15 lists the Cisco 4G LTE antennas that are supported for use on Cisco 819 ISRs.

Table 1-15 Supported 4G LTE Antennas

Cisco Part Number	Description	Maximum Gain and Frequency Ranges	Description
4G-LTE-ANTM-D	Indoor 4G dipole omnidirectional antenna	<ul style="list-style-type: none"> <li>• 2 dBi               <ul style="list-style-type: none"> <li>– 698 to 806 MHz</li> <li>– 824 to 894 MHz</li> <li>– 925 to 960 MHz</li> <li>– 1710 to 1885 MHz</li> <li>– 1920 to 1980 MHz</li> <li>– 2110 to 2170 MHz</li> <li>– 2500 to 2690 MHz</li> </ul> </li> </ul>	Multiband dipole antenna. For more information, see <a href="#">Cisco 4G/3G Omnidirectional Dipole Antenna (4G-LTE-ANTM-D)</a> .
4G-ANTM-OM-CM	Indoor ceiling-mount omnidirectional antenna	698 to 2690 MHz	Multiband omnidirectional ceiling-mount antenna. For more information, see <a href="#">Cisco 4G Indoor Ceiling-Mount Omnidirectional Antenna (4G-ANTM-OM-CM)</a> .
ANT-4G-OMNI-OUT-N	Multiband outdoor omnidirectional stick antenna	<ul style="list-style-type: none"> <li>• 1.5 dBi               <ul style="list-style-type: none"> <li>– 698 to 960 MHz</li> </ul> </li> <li>• 3.5 dBi               <ul style="list-style-type: none"> <li>– 1710 to 2710 MHz</li> <li>– 2300 to 2700 MHz</li> </ul> </li> </ul>	Multiband outdoor omnidirectional stick antenna. For more information, see <a href="#">Cisco Outdoor Omnidirectional Antenna for 2G/3G/4G Cellular (ANT-4G-OMNI-OUT-N)</a> .
ANT-4G-SR-OUT-TNC	Multiband outdoor omnidirectional saucer antenna	<ul style="list-style-type: none"> <li>• 1.5 dBi (peak gain with 10-foot cable) or 0.8 dBi (peak gain with 15-foot cable)               <ul style="list-style-type: none"> <li>– 698 to 960 MHz</li> </ul> </li> <li>• 3.7 dBi (peak gain with 10-foot cable) or 0.2 dBi (peak gain with 15-foot cable)               <ul style="list-style-type: none"> <li>– 1710 to 2700 MHz</li> </ul> </li> </ul>	Low-profile outdoor saucer antenna. For more information, see <a href="#">Cisco Integrated 4G Low-Profile Outdoor Saucer Antenna (ANT-4G-SR-OUT-TNC)</a> .
CGR-LA-NF-NF	Lightning Arrestor	800 to 2200 MHz	4G lightning arrestor kit for use on Cisco 4G wireless devices. For more information, see <a href="#">Lightning Arrestor for the Cisco 1240 Connected Grid Router</a> .
4G-ACC-OUT-LA	Lightning Arrestor	800 to 2200 MHz	4G lightning arrestor kit for use on Cisco 4G wireless devices. For more information, see <a href="#">Cisco 4G Lightning Arrestor (4G-ACC-OUT-LA)</a> .

Table 1-16 to Table 1-18 list the extension cables for use with 3G, WiFi, and 4G LTE antennas. The tables include the insertion loss information for the ultra-low-loss (ULL) LMR 400 extension cables.

**Table 1-16 Cisco Extension Cables for Use with 3G Antennas**

Cisco Product Number	Cable Length	Insertion Loss	Frequency (MHz)
3G-CAB-ULL-20	20 ft (6 m)	1.50 dB max	2100
3G-CAB-ULL-50	50 ft (15 m)	3.50 dB max	2100
3G-CAB-LMR240-25	25 ft (7.5 m)	3.50 dB max	2200
3G-CAB-LMR240-50	50 ft (15 m)	6.90 dB max	2200
3G-CAB-LMR240-75	75 ft (23 m)	10.5 dB max	2200

**Table 1-17 Cisco Extension Cables for Use with WiFi Antennas**

Cisco Product Number	Cable Length	Insertion Loss	Frequency (MHz)
AIR-CAB005LL-R	5 ft (1.524 m)	0.5 dB	2400
	(one RP-TNC plug, one RP-TNC jack)	0.8 dB	5800
AIR-CAB020LL-R	20 ft (6 m)	1.3 dB	2400
	(one RP-TNC plug, one RP-TNC jack)	2.5 dB	5800
AIR-CAB050LL-R	50 ft (15.24 m)	3.4 dB	2400
	(one RP-TNC plug, one RP-TNC jack)	5.75 dB	5800

**Table 1-18 Cisco Extension Cables for Use with 4G LTE Antennas**

Cisco Product Number	Cable Length	Maximum Insertion Loss	Frequency (MHz)	Color	Plenum Rated? <sup>1</sup>
4G-AE010-R	10 ft (3 m)	1.4 dB at 700 MHz 2.0 dB at 1.9 GHz 2.1 dB at 2.1 GHz 2.3 dB at 2.5 GHz	700 to 2600 MHz	Black	No
4G-AE015-R	15 ft (4.6 m)	2.3 dB at 700 MHz 3.3 dB at 1.9 GHz 3.7 dB at 2.1 GHz 4.0 dB at 2.5 GHz	700 to 2600 MHz	Black	No
4G-CAB-LMR240-25	25 ft (7.6 m)	2.1 dB at 700 MHz	700 to 1000 MHz	Black	Yes
		4.0 dB at 2.6 GHz	1700 to 2600 MHz		

**Table 1-18 Cisco Extension Cables for Use with 4G LTE Antennas (continued)**

Cisco Product Number	Cable Length	Maximum Insertion Loss	Frequency (MHz)	Color	Plenum Rated? <sup>1</sup>
4G-CAB-LMR240-50	50 ft (15 m)	4.1 dB at 700 MHz 7.4 dB at 2.6 GHz	700 to 1000 MHz 1700 to 2600 MHz	Black	Yes
4G-CAB-LMR240-75	75 ft (23 m)	6.1 dB at 700 MHz 11.0 dB at 2.6 GHz	700 to 1000 MHz 1700 to 2600 MHz	Black	Yes
4G-CAB-LMR240-25N	25 ft (7.6 m)	2.1 dB at 700 MHz 4.0 dB at 2600 MHz	700 to 1000 MHz 1700 to 2600 MHz	Black	No
4G-CAB-ULL-20	20 ft (6 m)	1.8 dB	700 to 2600 MHz	Black	Yes
4G-CAB-ULL-50	50 ft (15 m)	4.2 dB	700 to 2600 MHz	Black	Yes
CAB-L400-20-TNC-N	20 ft (6 m)	1.75 dB	700 to 2600 MHz	Black	No
CAB-L400-50-TNC-N	50 ft (15 m)	4.0 dB	700 to 2600 MHz	Black	No
CAB-L400-20-N-N	20 ft (6 m)	2.75 dB	700 to 2600 MHz	Black	No

1. Cable can be routed within building plenum spaces.

## Serial Port

The Cisco standard High Speed Smart Serial 12-in-1 connector allows the highest flexibility of connections to various DTE/DCE devices. The 12-in-1 serial interface pins connect to the FPGA. The FPGA configures the pin directions based on the cable type used. [Figure 1-10](#) shows the magnified view of the 12-in-1 serial port. For more information, see [About Serial Connections](#).



Figure 1-10 12-in-1 Serial Port

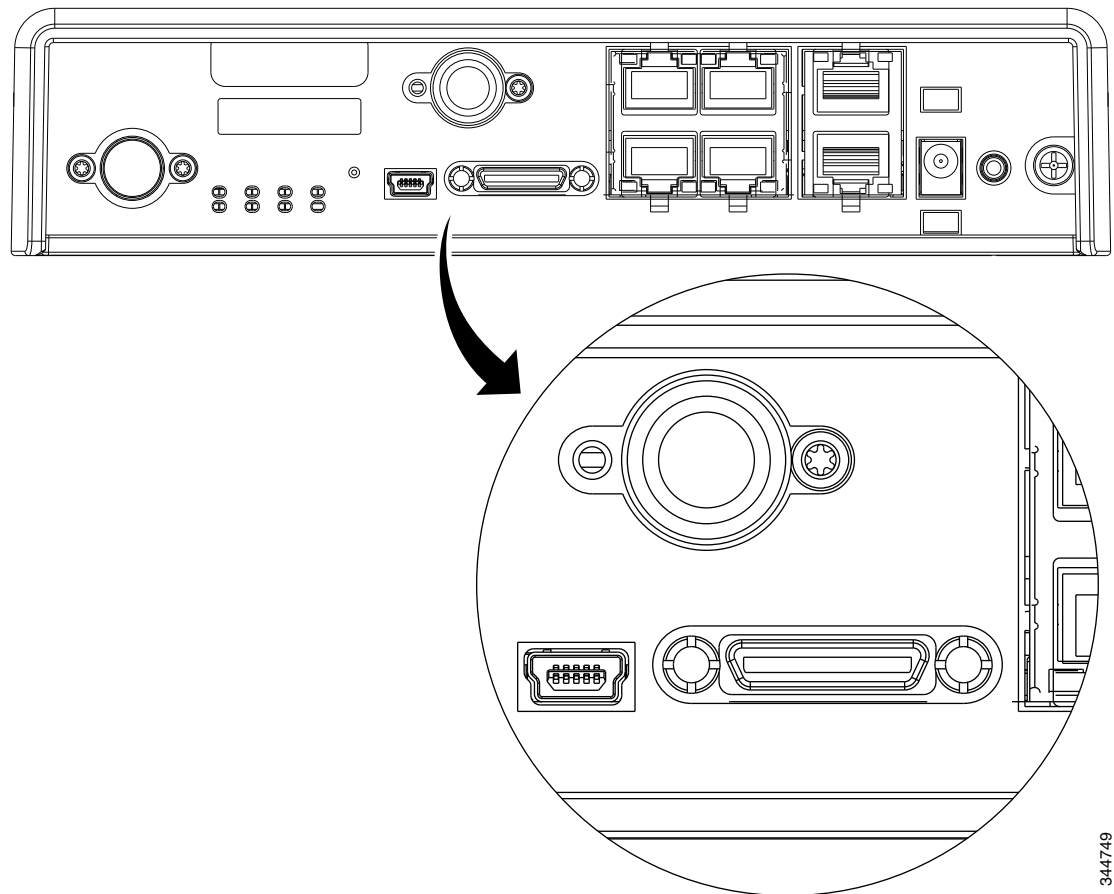

344749

## Power Supply

All SKUs require a 5 VDC power source. Cisco 819HG and Cisco 819G ISRs have a self-locking Molex mini-fit connector. Cisco 819HGW and Cisco 819HWD ISRs use a 5.5 mm barrel-type connector with separate locking clip. An external AC power adapter is supported by default. The optional external power adapters are available to support a variety of DC power sources, suitable for fixed, vehicle, or railway installations. The 5 VDC power input of the router is protected from over-voltage up to 20 VDC. The router will not power up if excessive voltage (for example, a 12 VDC adapter) is connected.

### AC Power Adapter

The default configuration includes an external AC adapter that supplies up to 20 W of power. The AC power connection is a two-pin IEC 320 C8 receptacle. A mating AC power cord is supplied. The AC adapter does not provide chassis grounding to the router. A 1.3-meter long output cable connects to the router.

### DC Power Adapters

The optional external DC power adapters are available for 12 VDC and 24 VDC nominal vehicle power.

- 12 VDC vehicle adapter has a 10 VDC to 36 VDC operating range
- 24 VDC vehicle adapter has an 18 VDC to 75 VDC operating range
- 48 VDC vehicle adapter has an 20 VDC to 60 VDC operating range

The vehicle power adapters may be used for fixed or mobile installations. They do not provide electrical isolation; the input negative is connected to the output negative (chassis ground). Input cable is 350 millimeter long with stripped and tinned bare wire connections. The input positive connection is a white wire and the input negative is a black wire.

### Railway Power Adapters

The optional external power adapters meeting Railway Standards are available from a third-party supplier, Martek Power. Contact Martek Power directly to order and for detailed specifications. The use of Martek Power adapters listed in the “Supported Power Adapters” section on page A-9 will maintain Cisco warranty and support of the router; the power adapter itself is covered by Martek warranty. Input connection to the railway adapters is by a 350 millimeter long wire with stripped and tinned bare wire connection. A 1.3-meter long output cable connects to the router.

## Accessories

Table 1-19 lists the accessories available for the Cisco 819 ISRs. For a complete list of SKUs that support these accessories, see the “Platform Features for Cisco 819 ISRs” section on page 1-27.

**Table 1-19** Cisco 819 ISR Accessories

Cisco Part Number	Accessory
69-2453-01	Power cord retention lock
69-2454-01	Power switch lock cover

## Cisco 860, 880, 890 Series

This section provides an overview of the features available for the Cisco 860 series, Cisco 880 series, and Cisco 890 series Integrated Services Routers (ISRs), and contains the following sections:

- [General Description, page 1-43](#)
- [Cisco 860 Series ISRs, page 1-43](#)
- [Cisco 860VAE Series ISRs, page 1-45](#)
- [Cisco 860VAE-W-A-K9, Cisco 860VAE-W-E-K9, and Cisco 860VAE-POE-W-A-K9 ISRs, page 1-50](#)
- [Cisco 880 Series ISRs, page 1-53](#)
- [Cisco C881, C886, and C887 Series ISRs, page 1-66](#)
- [Cisco C880 Series and Cisco C890 Series 4G LTE Integrated Services Routers, page 1-76](#)
- [Cisco 890 Series Integrated Service Routers, page 1-114](#)
- [Cisco C891 Series ISRs, page 1-127](#)
- [Hardware Features, page 1-132](#)



### Note

For compliance and safety information, see *Regulatory Compliance and Safety Information Roadmap* that ships with the router and [Regulatory Compliance and Safety Information for Cisco 800 Series](#).

**Note**

Some illustrations in this document show a wireless router. Both wireless and nonwireless models are available in the Cisco 860 series, Cisco 880 series, and Cisco 890 series ISRs. Port and feature locations are similar for both wireless and nonwireless routers.

**Note**

Throughout this document the term VDSL refers to support for VDSL2 (ITU G.993.2) and ADSL refers to support for ADSL, ADSL2, & ADSL2+ (ITU G.992.1, G.992.3, & G.992.5).

## General Description

The Cisco 860 series, Cisco 880 series, and Cisco 890 series ISRs provide data, voice, Wi-Fi CERTIFIED™ wireless access point (AP), integrated Virtual Private Network (VPN), and backup capabilities to corporate teleworkers and to remote and small offices with fewer than 20 users. These routers are capable of bridging and multiprotocol routing between LAN and WAN ports. The routers provide advanced features, such as high speed DSL (G.SHDSL, ADSL, or VDSL), 802.11n, quality of service (QoS), firewall, antivirus protection, and Secure Socket Layer (SSL). The Cisco 860VAE, 886VA and 887VA series routers have the additional capability of DSL Multi-mode (VDSL/ADSL).

The Cisco 860 series, Cisco 880 series, and Cisco 890 series ISRs have a desktop form factor with built-in wall-mount features. The Cisco 890 series ISRs also have optional rack-mount features. These ISRs are powered by an external power supply adapter. The various models differ in the WAN interface and features that they support.

## Cisco 860 Series ISRs

The Cisco 860 series ISRs are fixed-configuration data routers that support the following features:

- An integrated 4-port 10/100 Ethernet switch for connecting to the LAN
- A 10/100 Fast Ethernet (FE) port for connecting to the WAN.
- Optional, embedded Wi-Fi CERTIFIED™, 802.11b/g/n-compliant wireless AP

Figure 1-7 shows the front panel details of the Cisco 860 wireless router.

Figure 1-11 Front Panel of the Cisco 860 Series Wireless ISR

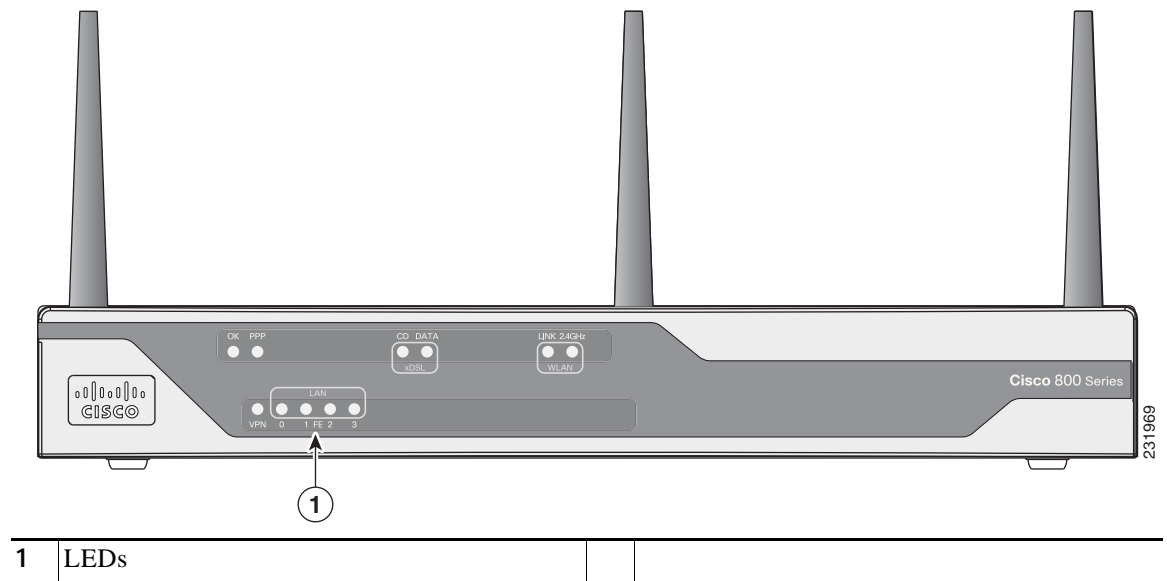
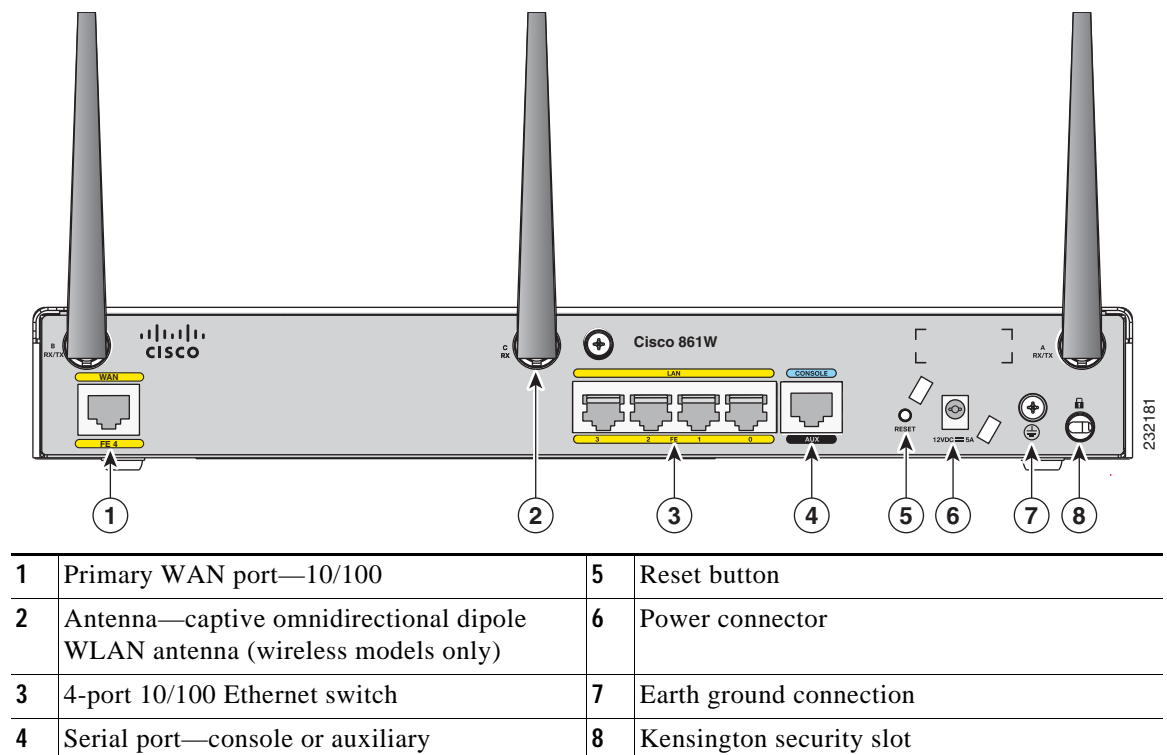

Figure 1-12 shows the back panel details of the Cisco 861 wireless (861W) ISR. Nonwireless routers do not have antennas on the back panel. However, the feature locations are similar for all Cisco 860 series routers.

Figure 1-12 Back Panel of the Cisco 861W ISR



## Cisco 860VAE Series ISRs

The Cisco 860VAE series ISRs are fixed-configuration data routers. This section describes the features of the products in this series.

### Interfaces

Table 1-20 describes the interfaces of the Cisco 860VAE series routers.

**Table 1-20** Interfaces of the Cisco 860VAE Series ISRs

Interfaces	Model			
	Cisco 866VAE	Cisco 867VAE	Cisco 866VAE-K9	Cisco 867VAE-K9
4 FE <sup>1</sup> switch ports	x	x	x	x
1 GE <sup>2</sup> switch port	—	—	x	x
1 GE WAN port	x	x	x	x
1 VDSL/ADSL over POTS port	—	x	—	x
1 VDSL/ADSL over ISDN port	x	—	x	—

1. FE = Fast Ethernet
2. GE = Gigabit Ethernet



#### Note

The Cisco 866VAE, 867VAE, 866VAE-K9, and 867VAE-K9 routers each have two WAN ports. Only one of the two ports can be active at any given time.

Table 1-21 describes the interfaces of the C860VAE series routers.

**Table 1-21** Interfaces of the C860VAE Series ISRs

Interfaces	Model		
	C867VAE	C866VAE-K9	C867VAE-K9
3 FE <sup>1</sup> switch ports	x	x	x
2 GE <sup>2</sup> switch port	x	x	x
1 GE WAN port	x	x	x
1 VDSL/ADSL over POTS port	x	—	x
1 VDSL/ADSL over ISDN port	—	x	—

1. FE = Fast Ethernet
2. GE = Gigabit Ethernet

## IOS Images

Table 1-22 describes the IOS images included in Cisco 860VAE series routers.

**Table 1-22** *IOS Images of the Cisco 860VAE Series ISRs*

IOS Image	Model			
	Cisco 866VAE	Cisco 867VAE	Cisco 866VAE-K9	Cisco 867VAE-K9
c860vae-ipbasek9-mz	x	x	—	—
c860vae-advsecurityk9-mz	—	—	x	x
c860vae-advsecurityk9_npe-mz	—	—	x	x

Table 1-23 describes the IOS images included in C860VAE series routers.

**Table 1-23** *IOS Images of the C860VAE Series ISRs*

IOS Image	Model		
	C867VAE	C866VAE-K9	C867VAE-K9
c860vae-ipbasek9-mz	x	—	—
c860vae-advsecurityk9-mz	—	x	x
c860vae-advsecurityk9_npe-mz	—	x	x

Figure 1-13 shows the front panel details of the Cisco 866VAE, Cisco 867VAE, Cisco 866VAE-K9, and Cisco 867VAE-K9 integrated services routers (ISRs).

**Figure 1-13** *Front Panel of the Cisco 860VAE series ISR*



1	LEDs		
---	------	--	--

Figure 1-14 shows the front panel details of the C867VAE, C866VAE-K9, and C867VAE-K9 integrated services routers (ISRs).

Figure 1-14 Front Panel of the C860VAE series ISR



1	LEDs	
---	------	--

Figure 1-15 shows the back panel details of the Cisco 866VAE ISR.

Figure 1-15 Back Panel of the Cisco 866VAE ISR

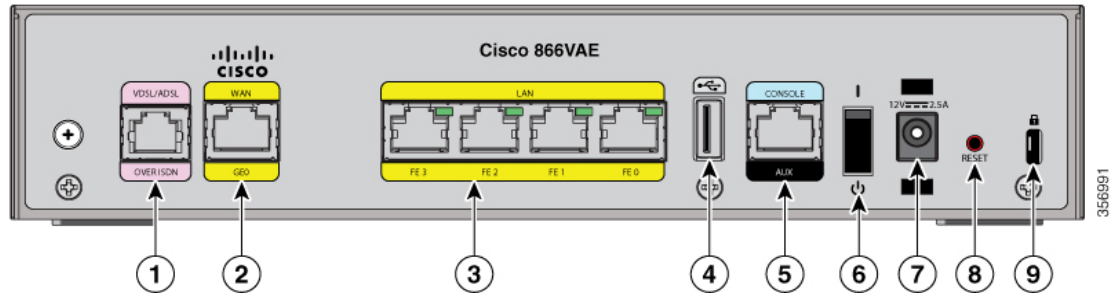

1	xDSL port <sup>1</sup>	6	On/Off switch
2	GE WAN interface	7	Power connector
3	Ethernet LAN FE interfaces (FE0 through FE3 interfaces)	8	Reset button
4	USB port	9	Kensington security slot
5	Serial port—console or auxiliary		

1. Using RJ-11.

Figure 1-16 shows the back panel details of the C867VAE ISR.

Figure 1-16 Back Panel of the C867VAE ISR

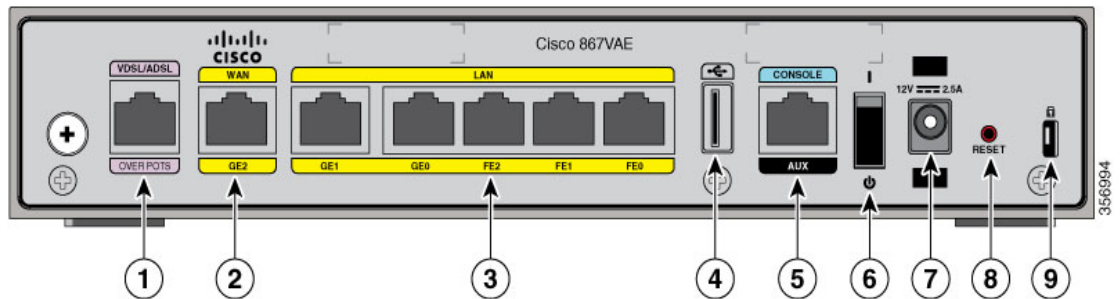

1	xDSL port <sup>1</sup>	6	On/Off switch
2	GE WAN interface	7	Power connector
3	Ethernet LAN GE and FE interfaces (GE0, GE1 interfaces and FE0 through FE2 interfaces)	8	Reset button
4	USB port	9	Kensington security slot
5	Serial port—console or auxiliary		

1. Using RJ-11.

Figure 1-17 shows the back panel details of the Cisco 867VAE-K9.

Figure 1-17 Back Panel of the Cisco 867VAE-K9 ISR

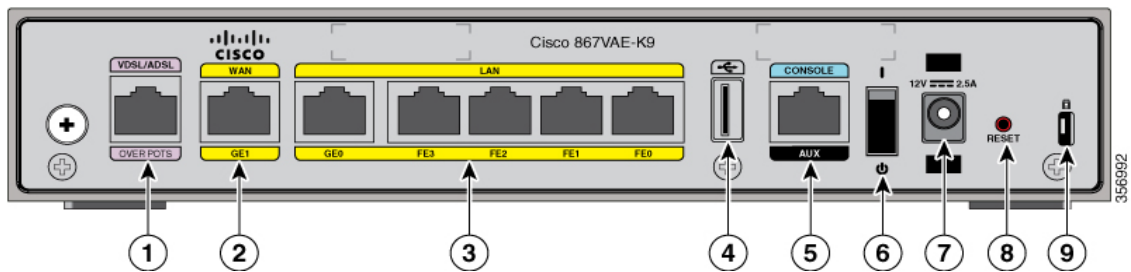

1	xDSL port	6	On/Off switch
2	GE WAN interface	7	Power connector
3	Ethernet LAN GE and FE interfaces (GE0 interface and FE0 through FE3 interfaces)	8	Reset button
4	USB port	9	Kensington security slot
5	Serial port—console or auxiliary		



Figure 1-18 shows the back panel details of the C866VAE-K9.

Figure 1-18 Back Panel of the C866VAE-K9 ISR

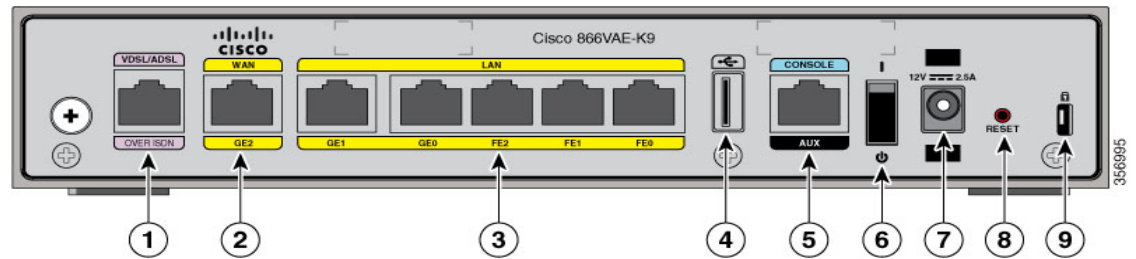

1	xDSL port	6	On/Off switch
2	GE WAN interface	7	Power connector
3	Ethernet LAN GE and FE interfaces (GE0, GE1 interfaces and FE0 through FE2 interfaces)	8	Reset button
4	USB port	9	Kensington security slot
5	Serial port—console or auxiliary		

Figure 1-19 shows the back panel details of the C867VAE-K9.

Figure 1-19 Back Panel of the C867VAE-K9 ISR

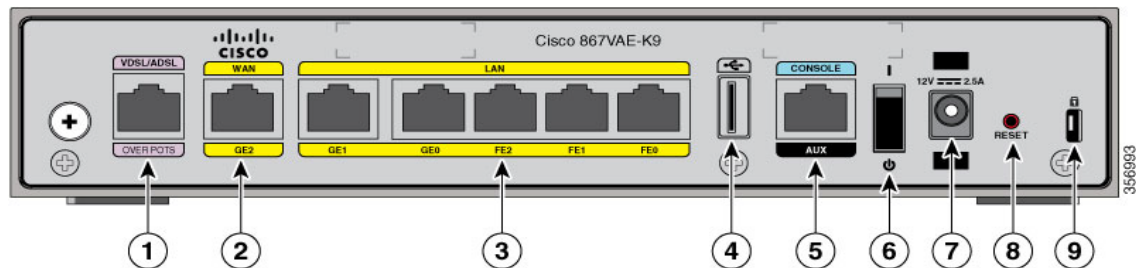

1	xDSL port	6	On/Off switch
2	GE WAN interface	7	Power connector
3	Ethernet LAN GE and FE interfaces (GE0, GE1 interfaces and FE0 through FE2 interfaces)	8	Reset button
4	USB port	9	Kensington security slot
5	Serial port—console or auxiliary		

## Cisco 860VAE-W-A-K9, Cisco 860VAE-W-E-K9, and Cisco 860VAE-POE-W-A-K9 ISRs

This section provides a hardware overview of the following Cisco 860VAE Series Integrated Services Routers (ISRs):

- C866VAE-W-E-K9
- C867VAE-W-A-K9
- C867VAE-W-E-K9
- C867VAE-POE-W-A-K9

### Model-Specific Features

Table 1-24 describes the features specific to each of these router models:

**Table 1-24 Model-Specific Router Features**

Feature	C866VAE-W-E-K9	C867VAE-W-A-K9	C867VAE-W-E-K9	C867VAE-POE-W-A-K9
WAN interface and mode	One GE port, DSL over ISDN, Europe WiFi	One GE port, DSL over POTS, America WiFi	One GE port, DSL over POTS, Europe WiFi	One GE port, DSL over POTS, America WiFi
Power-over-Ethernet (PoE)	No	No	No	Yes

### Common Features

The following key features are common to each of these router models:

- Dual WAN interface (Gigabit Ethernet [GE] and dual-mode ADSL2+ /VDSL2)
- 2.4 GHz wireless LAN (WLAN) interface
- Five Layer 2 LAN switches: two Gigabit Ethernet and three Fast Ethernet
- One USB 2.0 port in high-speed host mode
- One RJ-45 console port (RS-232 interface)
- Support for up to 512 MB DRAM using DDR in 16-bit mode
- Support for 8 MB Serial Peripheral Interface Bus (SPI) flash memory for boot and 128 MB NAND flash memory for storing IOS
- Reset/Recovery switch
- Silent convection cooling—no fan

### External Interfaces

Figure 1-20 shows the back I/O panel of the Cisco 867VAE-POE-W-A-K9 series router.

Figure 1-20 Back I/O Panel

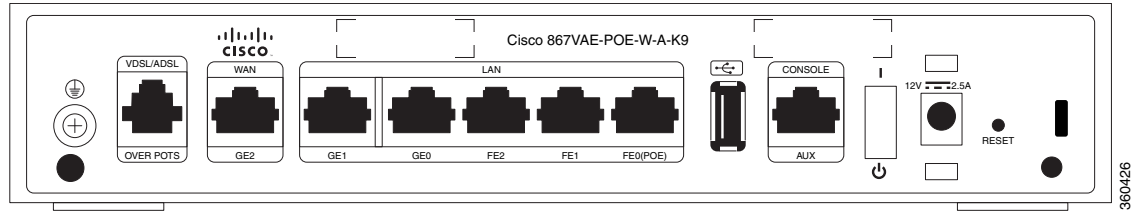

Table 1-25 describes the external interfaces included with these router models.

Table 1-25 External Interfaces

Interface	Connector	Quantity	Port	Port Label
FE LAN port	RJ-45	3	FE LAN PORT 0	FE0 <sup>1</sup>
			FE LAN PORT 1	FE1
			FE LAN PORT 2	FE2
GE LAN port	RJ-45	2	GE LAN PORT 0	GE0
			GE LAN PORT 1	GE1
GE WAN port (10/100/1000 Base-T)	RJ-45	1	GE WAN PORT	GE2
ADSL2+/VDSL2 WAN port	RJ-11	1	—	—
Host USB port	USB 2.0	1	—	—
Console port	RJ-45	1	—	—

1. Provides Power-over-Ethernet (PoE) for the Cisco C867VAE-POE-W-A-K9.



Note

For the Cisco C867VAE-POE-W-A-K9, Power-over-Ethernet (PoE) is available using port FE0, with a 60-W power supply.

## USB Interface

The USB 2.0 interface enables:

- Transferring data using a USB flash token (USB memory stick) for system recovery and other tasks.
- Cisco IOS software boot from USB.

Use only the following Cisco USB 2.0 flash tokens:

- MEMUSB-128FT (128 MB)
- MEMUSB-256FT (256 MB)
- MEMUSB-1024FT (1 GB)



Note

The USB 2.0 port cannot be used for connecting external devices or as a console for devices other than those specified in the *USB eToken Device and USB Flash Features Support Data Sheet*, available at: [http://www.cisco.com/en/US/prod/collateral/modules/ps6247/product\\_data\\_sheet0900aecd80232473.html](http://www.cisco.com/en/US/prod/collateral/modules/ps6247/product_data_sheet0900aecd80232473.html)

## LED Indicators

These router models include LED indicators on the back panel for each LAN port, and additional LED indicators on the front panel of the unit.

### LED Indicators for LAN Ports

On the back panel of the unit, each LAN port includes an LED indicator. [Table 1-26](#) describes the LED indicators.

**Table 1-26** Back Panel LED Indicators for LAN Ports

Port	LED Color	Description
<b>FE Ports</b>		
FE LAN 0	Green	Off—No link. Faster flashing indicates heavier traffic.
FE LAN 1	Green	Off—No link. Faster flashing indicates heavier traffic.
FE LAN 2	Green	Off—No link. Faster flashing indicates heavier traffic.
<b>GE Ports</b>		
GE LAN 0	Green	Off—No link. Faster flashing indicates heavier traffic.
GE LAN 1	Green	Off—No link. Faster flashing indicates heavier traffic.

### LED Indicators on Front Panel

The front panel includes several LED indicators. [Figure 1-21](#) shows the location of the LED indicators.

**Figure 1-21** Front Panel LED Indicators

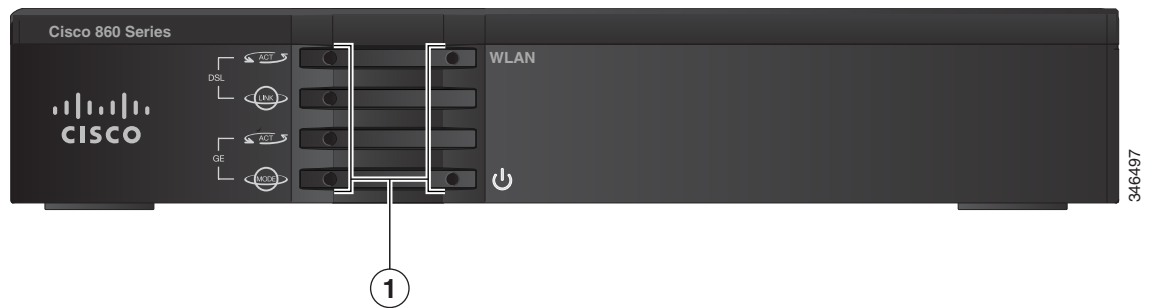

1	LED indicators		
---	----------------	--	--

Table 1-27 describes the LED indicators.

**Table 1-27 Front Panel LED Indicators**

LED	LED Color	LED Activity	Description
<b>Left Side</b>			
DSL ACT	Green	Flashing	DSL WAN activity. Faster flashing indicates heavier traffic.
	Off	—	Device is powered off. or No DSL WAN activity.
DSL LINK	Green	Solid	DSL WAN mode is selected and DSL training is complete.
		Flashing	DSL WAN mode is selected but DSL LinkUp state is incomplete, such as in-training (slow initially, fast when almost connected).
	Off	—	Device is powered off. or GE WAN mode is selected.
GE ACT	Green	Flashing	GE WAN activity (traffic in either direction). Faster flashing indicates heavier traffic.
	Off	—	Device is powered off. or No GE WAN activity. or No link.
GE MODE	Green	Solid	GE WAN mode is selected.
	Off	—	Device is powered off. or DSL WAN mode is selected.
<b>Right Side</b>			
WLAN	Green	Solid	WLAN enabled.
		Flashing	Indicates WLAN activity (traffic in either direction).
	Off	—	Device is powered off. or WLAN is disabled.
Power	Green	Solid	On—The device is powered on.
	Off	—	Device is powered off.

## Cisco 880 Series ISRs

The Cisco 880 series ISRs have data and voice capabilities. They have the following features:

- Integrated 4-port 10/100 Ethernet switch for connecting to the LAN
- 10/100 FE, VDSL<sub>o</sub>POTS, ADSL over POTS, ADSL over ISDN, DSL Multi-mode (VDSL/ADSL<sub>o</sub>POTS, VDSL/ADSL<sub>o</sub>ISDN Cisco VA models only), or G.SHDSL port for connecting to the WAN
- Optional embedded Wi-Fi CERTIFIED™, 802.11b/g/n-compliant wireless AP
- Optional 2-port Power over Ethernet (PoE)



---

**Note** The Cisco 880 series ISRs can include an optional PoE module that provides power to 802.3af-compliant devices connected to ethernet ports 0 and 1. If this feature was not configured with the factory order, you must order and install it to enable the PoE function.

---

- DIMM expansion socket that can accept up to 512 MB of additional memory, for a total of 768 MB system memory

The following features are located on the front panel:

- USB 1.1 port
- Express card slot for third-generation (3G) cellular data WAN connectivity, available only on the Cisco 880G models

This section contains the following topics:

- [Cisco 880 Series Data Routers, page 1-54](#)
- [Cisco 880 Series Voice and Data Routers, page 1-57](#)
- [Cisco 880 Series with Embedded WLAN Antennas, page 1-63](#)
- [C881G-B/S/V-K9 ISRs, page 1-65](#)
- [C881GW-S/V-A-K9 ISRs, page 1-65](#)
- [C881G-U-K9 ISRs, page 1-66](#)
- [HSPA+ Versions of the Fixed-Platform ISRs, page 1-66](#)

## Cisco 880 Series Data Routers

The Cisco 880 series data routers provide integrated VPN, embedded Wi-Fi CERTIFIED™, 802.11b/g/n-compliant wireless AP, 3G, and backup capabilities. [Figure 1-22](#) through [Figure 1-25](#) show the features available on Cisco 880 series data routers. Some of the features shown may not be available on your router.

Depending on the router model, the primary WAN port can be G.SHDSL, VDSL<sub>o</sub>POTS, VDSL/ADSL over ISDN, VDSL/ADSL over POTS, or 10/100 FE. See the [Cisco 880 Series Integrated Services Routers](#) data sheet for the WAN interface that is supported on your router.

[Figure 1-22](#) shows the front panel details of the Cisco 880 wireless data router. The USB port and the 3G card slot are located on the front panel.

Figure 1-22 Front Panel of the Cisco 880 Series Wireless Data Router

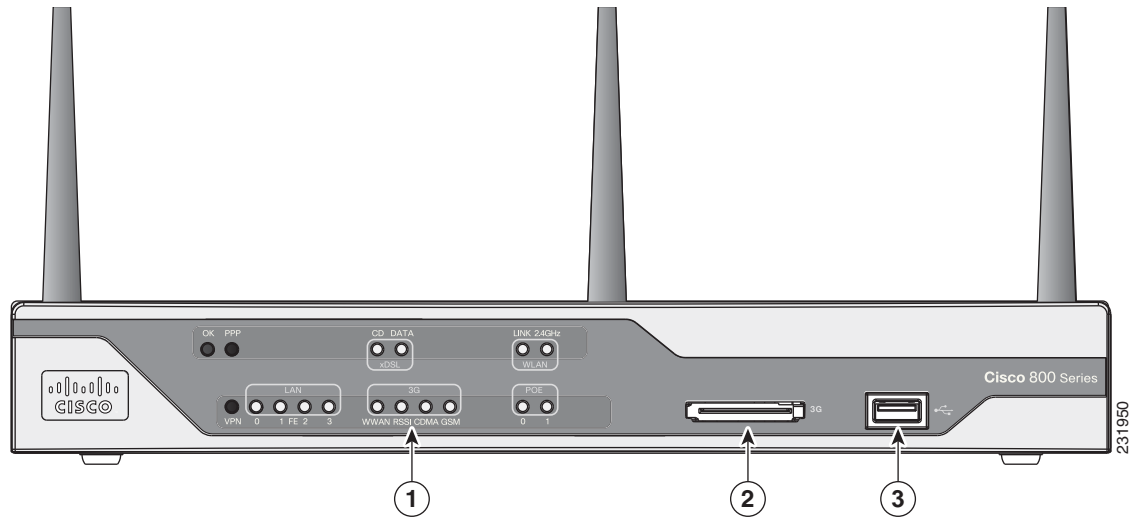

1	LEDs	3	USB port
2	3G express card slot—Supports third-party <sup>1</sup> 3G card (Cisco 880G models only)		

1. See the [Cisco 880 Series Integrated Services Routers](#) data sheet for supported vendors.

Figure 1-23 shows the back panel details of the Cisco 886VA data router.

Figure 1-23 Back Panel of the Cisco 886VA Router

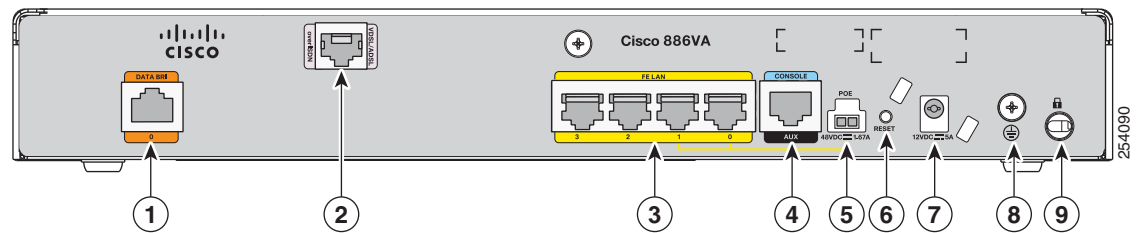

1	Data BRI <sup>1</sup> 0	6	Reset button
2	Primary WAN port—VDSL/ADSL over ISDN	7	Power connector
3	4-port 10/100 Ethernet switch <sup>2</sup>	8	Earth ground connection
4	Serial port—console or auxiliary	9	Kensington security slot
5	PoE power connector—optional		

1. BRI = Basic rate interface.

2. Ports 0 and 1 provide PoE with the optional PoE module installed.



The primary WAN port is designed for an RJ-45 connector only. Damage to the primary WAN port may occur if a non-RJ-45 connector is inserted.

Figure 1-24 shows the back panel details of the Cisco 887VA and 886VA-M data router.

Figure 1-24 Back Panel of the Cisco 887VA and 887VA-M Router

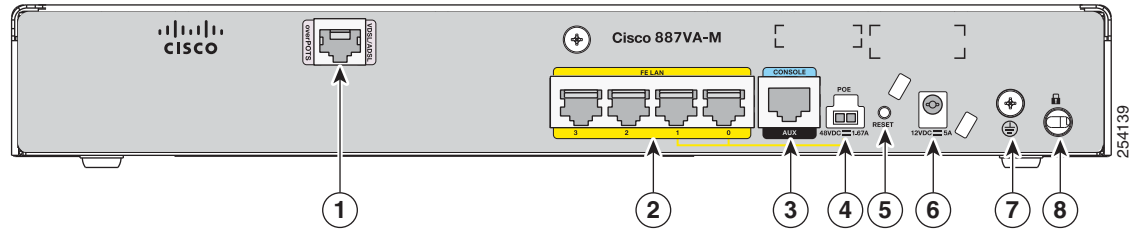

1	Primary WAN port—VDSL/ADSL over POTS <sup>1</sup>	5	Reset button
2	4-port 10/100 Ethernet switch <sup>2</sup>	6	Power connector
3	Serial port—console or auxiliary	7	Earth ground connection
4	PoE power connector—optional	8	Kensington security slot

1. 887VA-M has Annex M support.
2. Ports 0 and 1 provide PoE with the optional PoE module installed.



For the Cisco 887VA, the primary WAN port is designed for an RJ-11 connector only. Damage to the primary WAN port may occur if a non-RJ-11 connector is inserted.

Figure 1-25 shows the back panel details of the Cisco 888W data router. Nonwireless routers do not have antennas on the back panel. However, the feature locations are similar across all Cisco 880 series data routers.

Figure 1-25 Back Panel of the Cisco 888W Data Router

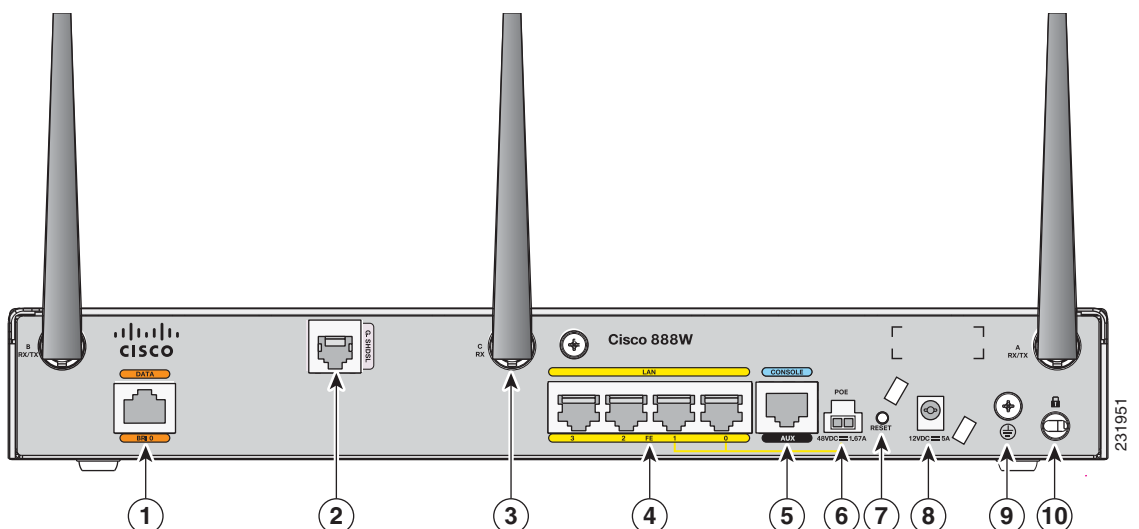



1	ISDN port—not available on 3G models	6	PoE power connector for optional PoE module <sup>1</sup>
2	Primary WAN port <sup>2</sup> —G.SHDSL, VDSL <sub>o</sub> POTS, ADSL <sub>o</sub> POTS, ADSL <sub>o</sub> ISDN, or 10/100 FE	7	Reset button
3	Antenna—captive omnidirectional dipole WLAN antenna (wireless models only)	8	Power connector
4	4-port 10/100 Ethernet switch	9	Earth ground connection
5	Serial port—console or auxiliary	10	Kensington security slot

1. The Cisco 880 series ISRs can include an optional PoE module that provides power to 802.3af-compliant devices connected to ethernet ports 0 and 1. If this feature was not configured with the factory order, you must order and install it to enable the PoE function.
2. Depending on the router model, the primary WAN port can be G.SHDSL, VDSL<sub>o</sub>POTS, or 10/100 FE. The VDSL<sub>o</sub>POTS port is in the same location as the G.SHDSL port. The 10/100 FE WAN port is located at the bottom left corner. See [Figure 1-12](#) for the location of the 10/100 FE WAN port.

## Cisco 880 Series Voice and Data Routers

The Cisco 880 series voice and data routers provide both voice and data ports. The voice ports managed voice services that interface with Foreign Exchange Station (FXS), Foreign Exchange Office (FXO), or BRI connections.

### Cisco 881 SRST and Cisco 888 SRST

[Figure 1-26](#), [Figure 1-27](#), and [Figure 1-28](#) show the features available on the Cisco 881 SRST and Cisco 888 SRST routers. The features available vary, depending on the router model. Some features may not be available on your router.

Depending on the router model, the primary WAN port can be either G.SHDSL or 10/100 FE. See the [Cisco 880 Series Integrated Services Routers](#) data sheet for the WAN interface and voice ports that are supported on your router.

Figure 1-26 shows the front panel details of the Cisco 881 SRST and Cisco 888 SRST wireless voice router.

Figure 1-26 Front Panel of the Cisco 881 SRST and Cisco 888 SRST Wireless Voice Router

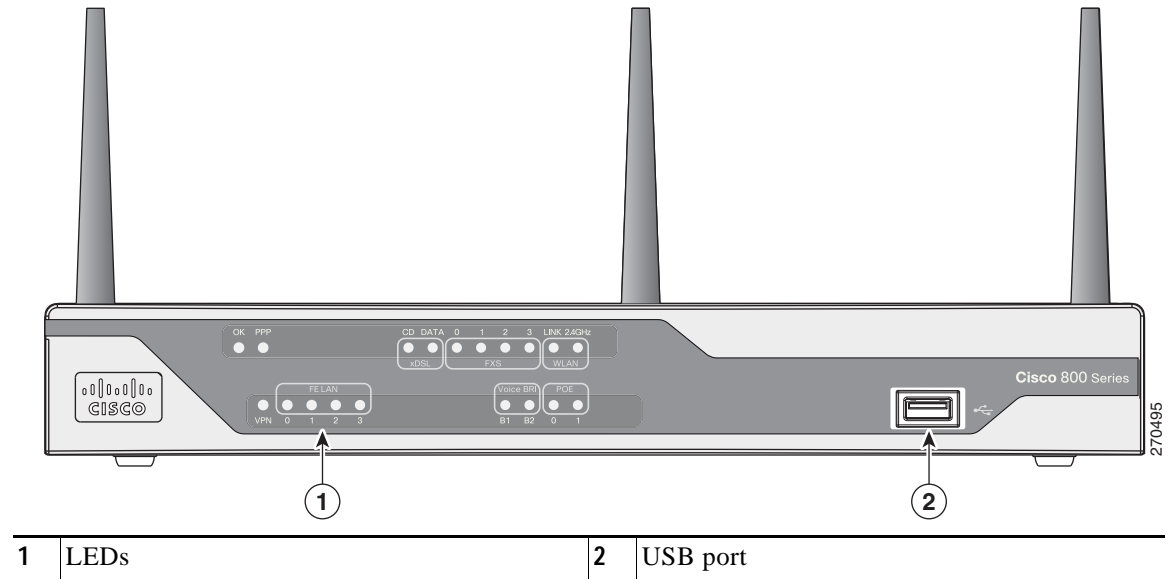
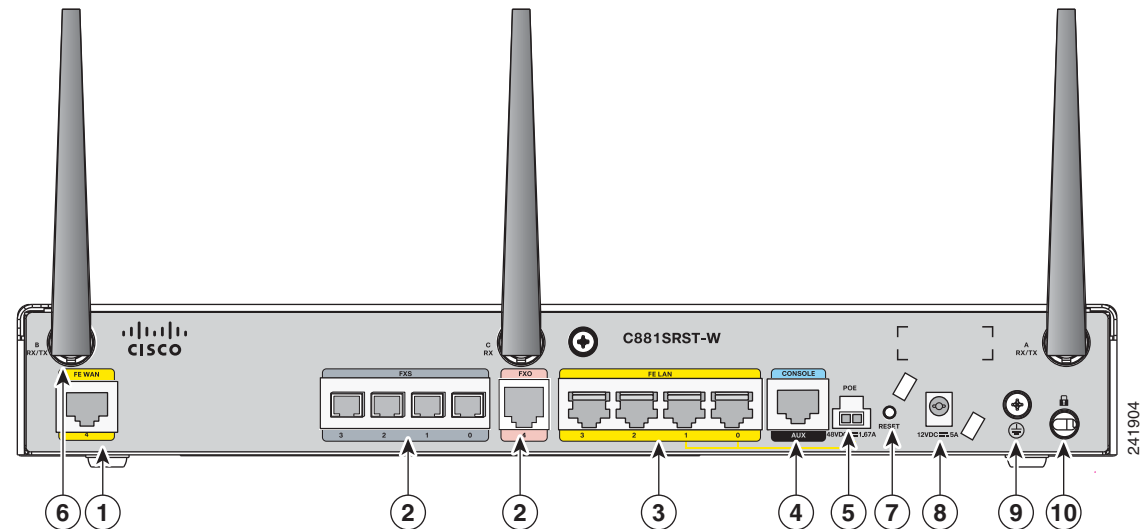

Figure 1-27 shows the back panel details of the Cisco 881SRST-W voice router.

Figure 1-27 Back Panel of the Cisco C881SRST-W Voice Router



1	Primary WAN port <sup>1</sup> —10/100 FE	6	Antenna—captive wireless omnidirectional dipole WLAN antenna (wireless models only)
2	Voice ports—four FXS <sup>2</sup> /DID <sup>3</sup> ports, one FXO <sup>4</sup> port with TBP <sup>5</sup> power failover	7	Reset button
3	4-port 10/100 Ethernet switch <sup>6</sup>	8	Power connector
4	Serial port—console or auxiliary	9	Earth ground connection
5	PoE power connector for optional PoE module <sup>7</sup>	10	Kensington security slot

- Depending on the router model, the primary WAN port can be either G.SHDL or 10/100 FE.
- FXS = Foreign Exchange Station.
- DID = Direct Inward Dialing.
- FXO = Foreign Exchange Office.
- TBP = trunk bypass.
- Ports 0 and 1 provide PoE with the optional PoE module installed.
- The Cisco 880 series ISRs can include an optional PoE module that provides power to 802.3af-compliant devices connected to ethernet ports 0 and 1. If this feature was not configured with the factory order, you must order and install the Field Replaceable Unit (FRU) to enable the PoE function. For this you either need the FRU “800-IL-PM=2” or “800G2-POE-2”. If your device has a separate PoE inlet, use the 800-IL-PM=2, if it has one combined inlet (a description saying “POE OPTION REQUIRES 5A POWER ADAPTOR”), then use the 800G2-POE-2.

Figure 1-28 shows the back panel details of the Cisco 888SRST-W voice router.

Figure 1-28 Back Panel of the Cisco C888SRST-W Voice Router

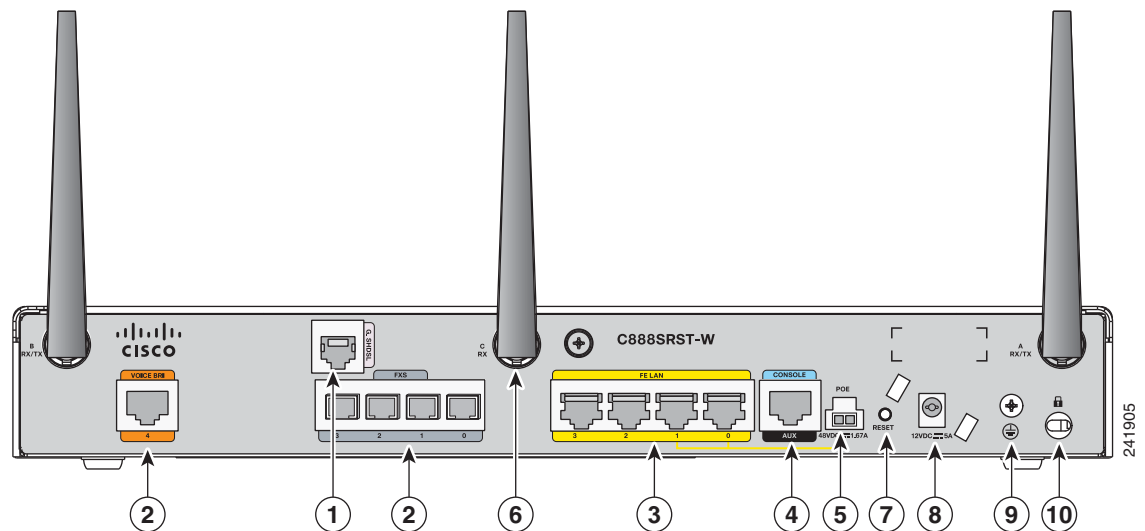

1	Primary WAN port <sup>1</sup> —G.SHDSL	6	Antenna—captive wireless omnidirectional dipole WLAN antenna (wireless models only)
2	Voice ports—four FXS/DID ports and one voice BRI port	7	Reset button
3	4-port 10/100 Ethernet switch <sup>2</sup>	8	Power connector
4	Serial port—console or auxiliary	9	Earth ground connection
5	PoE power connector for optional PoE module <sup>3</sup>	10	Kensington security slot

1. Depending on the router model, the primary WAN port can be either G.SHDL or 10/100 FE.

2. Ports 0 and 1 provide PoE with the optional PoE module installed.

3. The Cisco 880 series ISRs can include an optional PoE module that provides power to 802.3af-compliant devices connected to ethernet ports 0 and 1. If this feature was not configured with the factory order, you must order and install the Field Replaceable Unit (FRU) to enable the PoE function. For this you either need the FRU “800-IL-PM=2” or “800G2-POE-2”. If your device has a separate PoE inlet, use the 800-IL-PM=2, if it has one combined inlet (a description saying “POE OPTION REQUIRES 5A POWER ADAPTOR”), then use the 800G2-POE-2.



The primary WAN port on all 888E models is designed for an RJ-45 connector only. Damage to the primary WAN port may occur if a non-RJ-45 connector is inserted.

## Cisco 881-V, Cisco 887VA-V, and Cisco 887VA-V-W

Figure 1-29, Figure 1-30, and Figure 1-31 show the features available on the Cisco 881-V and Cisco 887VA-V routers. The features available vary, depending on the router model. Some features may not be available on your router.

The Cisco 881-V and Cisco 887VA-V voice and data series gives you the flexibility to use either FXS or BRI voice ports. However, the number of concurrent calls that can be supported by the router is limited by the codec complexity setting on the router. Table 1-28 lists the maximum number of calls that is supported when the **codec complexity** command is configured for Flexible, Medium or High complexity.



**Note**

Configuring the codec complexity setting to support secure calls uses DSP resources, but does not affect the maximum number of supported calls.

**Table 1-28** Maximum Number of Supported Calls

	Flexible Complexity	Medium Complexity	High Complexity
C881-V	9	8	6
C887VA-V	8	8	6
C887VA-V-W	8	8	6

Figure 1-29 shows the front panel details of the Cisco 881-V, Cisco 887VA-V, and Cisco 887VA-V-W.

**Figure 1-29** Front Panel of the Cisco 881-V, Cisco 887VA-V, and Cisco 887VA-V-W Routers

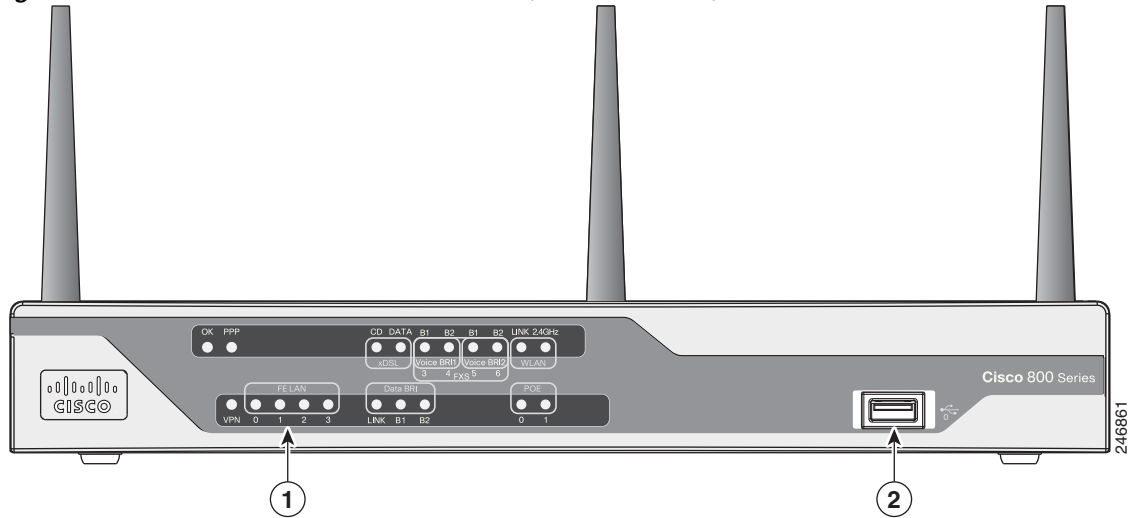

<b>1</b>	LEDs	<b>2</b>	USB port
----------	------	----------	----------

Figure 1-30 shows the back panel for the Cisco 887VA-V-W router. The Cisco 887VA-V (non-wireless) router does not have the antennas on the back panel.

Figure 1-30 Back Panel of the Cisco 887 VA-V Router

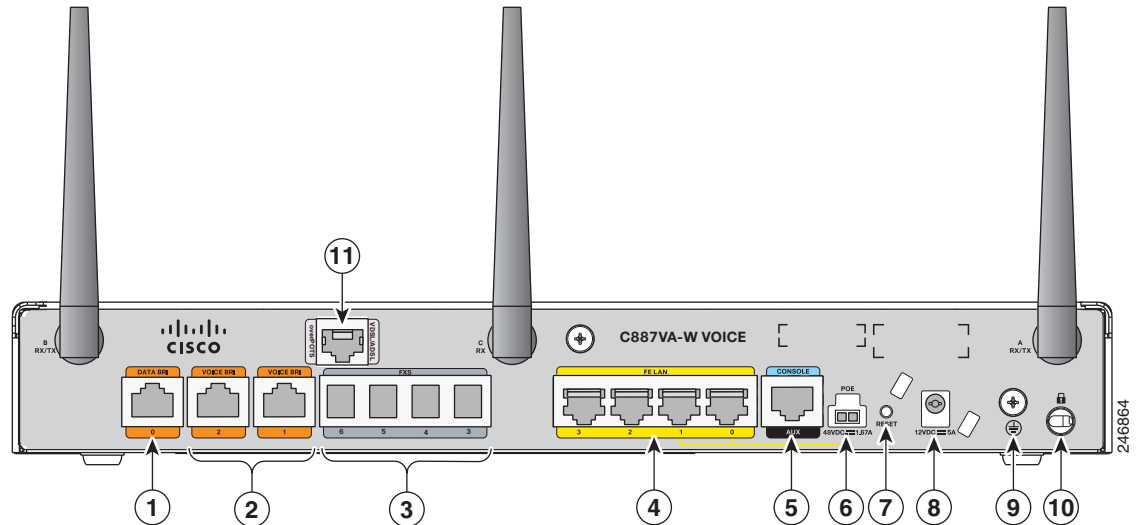

1	Data BRI	7	Reset Button
2	Voice BRI	8	Power connector
3	Voice ports—four FXS/DID ports	9	Earth ground connection
4	Fast Ethernet LAN—four ports	10	Kensington security slot
5	Console Port	11	Primary WAN port—VDSL/ADSL over POTS
6	PoE power connector (optional)		

Figure 1-31 shows the back panel for the Cisco 881-V router.

Figure 1-31 Back Panel of the Cisco 881-V Router

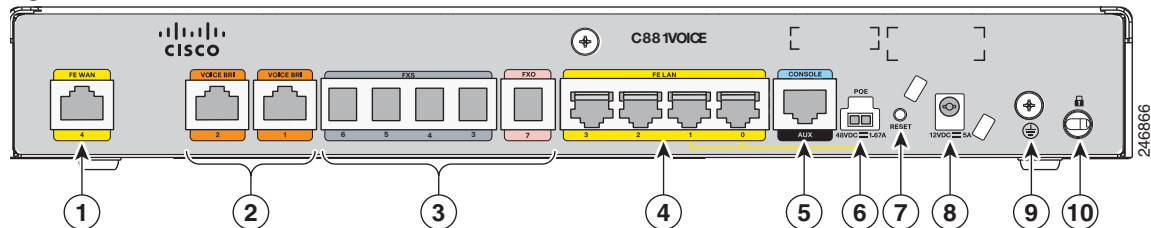

1	Fast Ethernet WAN port	6	PoE power connector (optional)
2	Voice BRI ports	7	Reset button
3	Voice ports—four FXS/DID ports and one FXO port.	8	Power connector
4	Fast Ethernet LAN—four ports	9	Earth ground connection
5	Console Port	10	Kensington security slot

## Cisco 880 Series with Embedded WLAN Antennas

Some Cisco 880W, 880WD, and 880-WD ISRs have three embedded WLAN antennas.

These ISRs are fixed-platform routers that:

- Provide integrated VPN, embedded Wi-Fi CERTIFIED™, 802.11b/g/n-compliant wireless AP, and backup capabilities.
- Use single-band (2.4 GHz) WLAN cards or dual-band (2.4 GHz and 5 GHz) WLAN cards.
- Require a single external power supply: a 30-W power supply for non-POE-enabled routers or a 60-W power supply for POE-enabled routers.
- Have a fixed 512 MB of system memory.

For information on configuring the Cisco 880 series ISRs, see [Cisco 880 Series Integrated Services Router Software Configuration Guide](#).

### Cisco 887VA-WD

[Figure 1-32](#) shows the front panel details of the C887VA-WD-A-K9 and C887VA-WD-E-K9 ISRs. The front panel has LEDs only. All the ports are in the back panel.

**Figure 1-32** Front Panel of the C887VA-WD-A-K9 and C887VA-WD-E-K9 ISRs

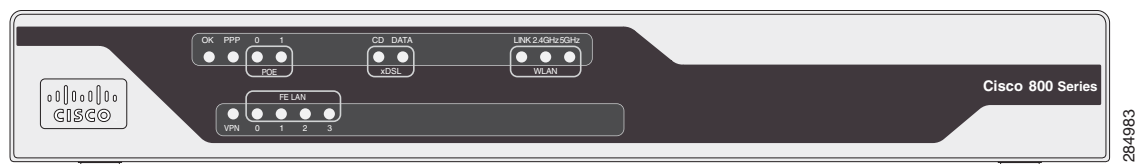
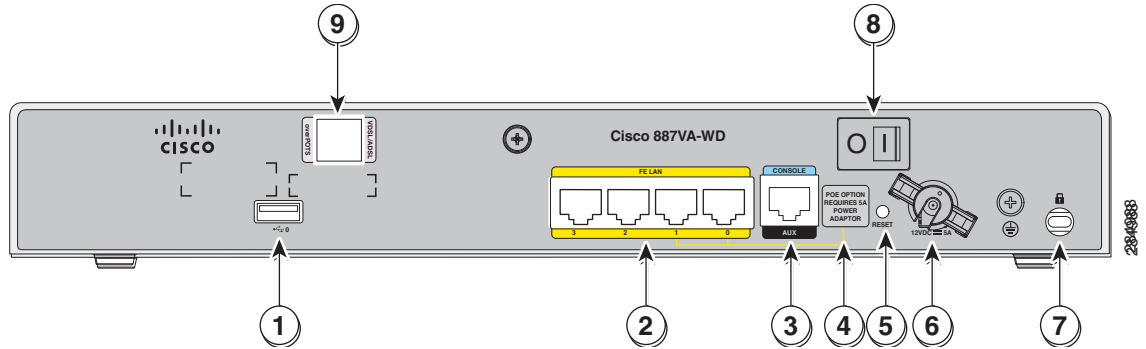

Figure 1-33 shows the back panel details of the C887VA-WD-A-K9 and C887VA-WD-E-K9 ISRs.

Figure 1-33 Back Panel of the C887VA-WD-A-K9 and C887VA-WD-E-K9 ISRs



1	USB port	6	Power connector
2	4-port 10/100 Ethernet switch	7	Kensington security slot
3	Serial port—console or auxiliary	8	Power switch
4	<b>Note</b> No separate PoE power supply is required for routers with embedded WLAN antennas. For information on system power supply requirements when PoE is enabled, see the <a href="#">“Power over Ethernet Module”</a> section on page 1-143.	9	VDSL/ADSL port
5	Reset button		

C881WD

Figure 1-34 shows the front panel details of the C881WD-A-K9 and C881WD-E-K9 ISRs. The front panel has LEDs only. All the ports are in the back panel.

Figure 1-34 Front Panel of the C881WD-A-K9 and C881WD-E-K9 ISRs

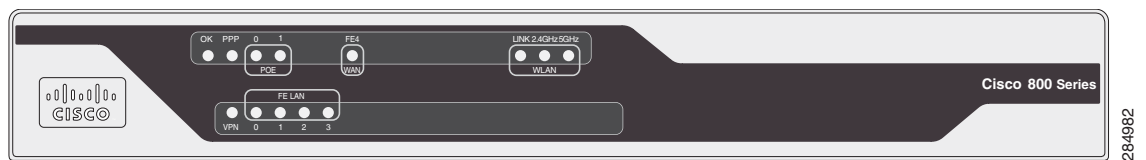
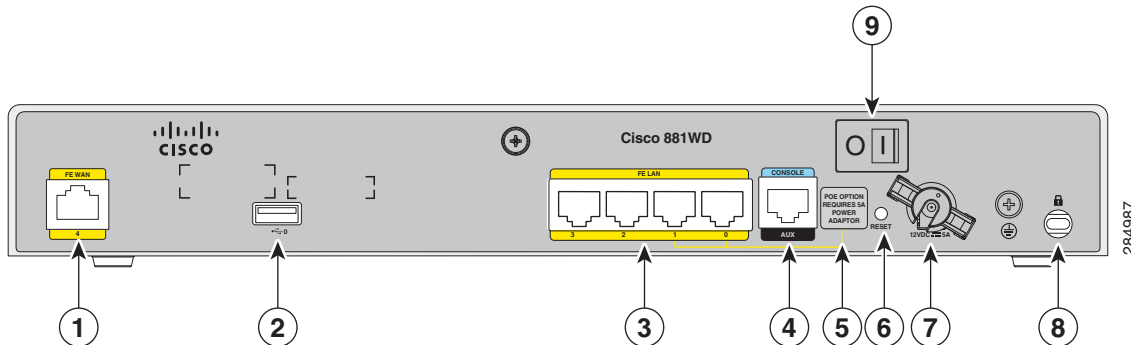



Figure 1-35 shows the back panel details of the C881WD-A-K9 and C881WD-E-K9 ISRs.

Figure 1-35 Back Panel of the C881WD-A-K9 and C881WD-E-K9 ISRs



1	Primary WAN port—10/100 FE	6	Reset button
2	USB port	7	Power connector
3	4-port 10/100 Ethernet switch	8	Kensington security slot
4	Serial port—console or auxiliary	9	Power switch
5	<b>Note</b> No separate PoE power supply is required for routers with embedded WLAN antennas. For information on system power supply requirements when PoE is enabled, see the “ <a href="#">Power over Ethernet Module</a> ” section on page 1-143.		

## C881G-B/S/V-K9 ISRs

The C881G-B-K9, C881G-S-K9, and C881G-V-K9 ISRs are members of the Cisco 880 series data routers. These routers provide integrated Virtual Private Network (VPN), 802.11b/g/n-compliant wireless Access Point (AP), 3G, and backup capabilities.

For information on configuring Cisco 880 Series ISRs, see [Cisco 880 Series Integrated Services Router Software Configuration Guide](#).

## C881GW-S/V-A-K9 ISRs

The C881GW-S-A-K9 and C881GW-V-A-K9 ISRs are members of the Cisco 880G series data routers. These routers provide integrated VPN, embedded Wi-Fi CERTIFIED™, 802.11b/g/n-compliant wireless AP, 3G, and backup capabilities.

For information on configuring Cisco 880 Series ISRs, see [Cisco 880 Series Integrated Services Router Software Configuration Guide](#).

## C881G-U-K9 ISRs

The C881G-U-K9 ISR is a member of the Cisco 880 series data routers. These routers provide integrated Virtual Private Network (VPN), embedded Wi-Fi CERTIFIED™, 802.11b/g/n-compliant wireless Access Point (AP), 3G, and backup capabilities.

For information on configuring Cisco 880 Series ISRs, see [Cisco 880 Series Integrated Services Router Software Configuration Guide](#).

## HSPA+ Versions of the Fixed-Platform ISRs

The C881G+7-K9, C886VAG+7-K9, C887VAG+7-K9, C887VAMG+7-K9, C888EG+7-K9, C881GW+7-A-K9, C881GW+7-E-K9, C887VAGW+7-A-K9, and C887VAGW+7-E-K9 ISRs are members of the Cisco 880G series data routers. These routers provide integrated VPN, embedded Wi-Fi CERTIFIED™, 802.11b/g/n-compliant wireless AP, 3G, and backup capabilities.

For information on configuring Cisco 880 Series ISRs, see [Cisco 880 Series Integrated Services Router Software Configuration Guide](#).

## Cisco C881, C886, and C887 Series ISRs

Cisco C881, C886, and C887 Series ISRs offer broadband speed and simplified management to small businesses, small enterprise branches, and teleworkers. The Cisco C881, C886, and C887 Series ISR models have a lead-free, fanless chassis and are updated versions of the previous Cisco 881, 886, and 887 series (excluding 3G and wireless models).

Information provided in this section is applicable for the following models:

- Cisco C881
- Cisco C886VA, Cisco C886VAJ (Annex J)
- Cisco C887VA, Cisco C887VAM (Annex M)

[Table 1-29](#) provides information about important hardware specifications pertaining to Cisco C881, C886, and C887 Series Routers.

**Table 1-29** *Hardware Specifications of Cisco C881, C886, and C887 Series Routers*

Hardware	Description
Flash Memory	256 MB
Main Memory	1 GB DDR RAM; fixed and not extendable
USB port	A USB 2.0-compliant port located at the back panel
FAN	Fanless chassis
PoE	Two internal PoE ports
WAN	<ul style="list-style-type: none"> <li>• C881— FE</li> <li>• C886—VDSL/ADSL over ISDN with ISDN back up</li> <li>• C887—VDSL/ADSL over POTS</li> </ul>

Hardware	Description
Console or auxiliary port	RJ-45
LAN switch	4-port 10/100BASE-T

For detailed hardware specifications, see the Cisco 880 Series hardware data sheet at:

[http://www.cisco.com/en/US/prod/collateral/routers/ps380/data\\_sheet\\_c78\\_459542\\_ps380\\_Products\\_Data\\_Sheet.html](http://www.cisco.com/en/US/prod/collateral/routers/ps380/data_sheet_c78_459542_ps380_Products_Data_Sheet.html)

## Cisco C881 Router

Figure 1-36 shows the front panel of the Cisco C881 Router.

**Figure 1-36** Front Panel of the Cisco C881 Router

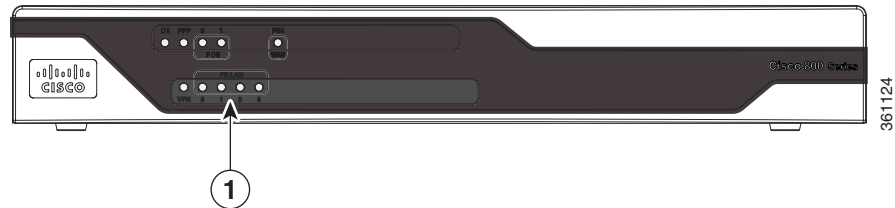

1	LEDs		
---	------	--	--

For detailed description about the LEDs on the Cisco C880 Series Routers, see the “LEDs” section on page 1-30.

Figure 1-37 shows the back panel of the Cisco C881 Router.

**Figure 1-37 Back Panel of the Cisco C881 Router**

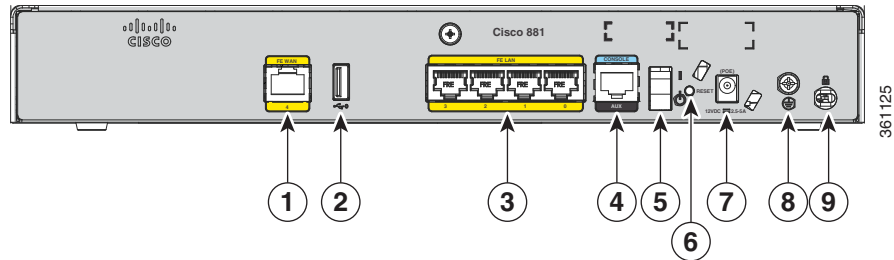

1	Primary WAN port—FE	6	Reset button
2	USB port	7	Power connector
3	4-port 10/100 Ethernet switch	8	Earth ground connection
4	Serial port—Console or auxiliary	9	Kensington security slot
5	On/Off switch		

For information on installing the Cisco C880 Series Routers, see :

<http://www.cisco.com/en/US/docs/routers/access/800/860-880-890/hardware/installation/guide/2Instal1880-860.html>

## Cisco C886VA Router

Figure 1-38 shows the front panel of the Cisco C886VA Router.

**Figure 1-38 Front Panel of the Cisco C886VA Router**

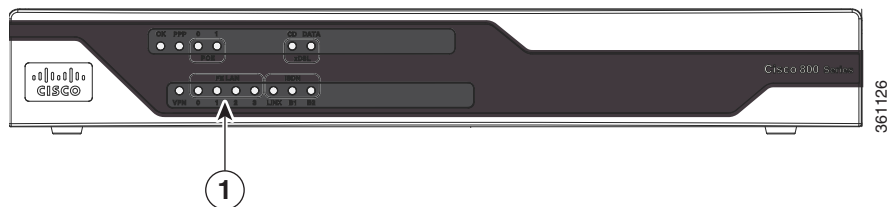

1	LEDs		
---	------	--	--

For detailed description about the LEDs on the Cisco C880 Series Routers, see the “LEDs” section on page 1-30.

Figure 1-39 shows the back panel of the Cisco C886VA Router.

Figure 1-39 Back Panel of the Cisco C886VA Router

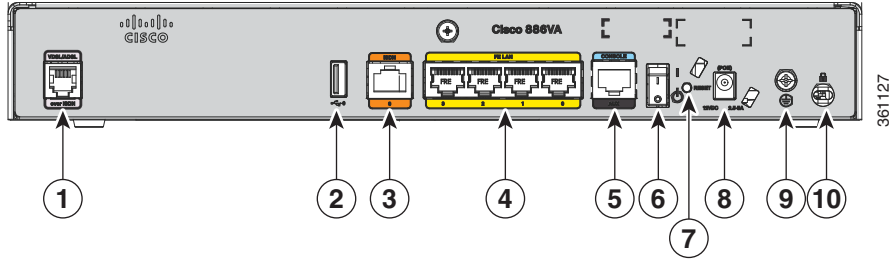

1	Primary WAN port—VDSL/ADSL over ISDN	6	On/Off switch
2	USB port	7	Reset button
3	ISDN	8	Power connector
4	4-port 10/100 Ethernet switch	9	Earth ground connection
5	Serial port—Console or auxiliary	10	Kensington security slot

For information on installing Cisco C880 Series Routers, see:

<http://www.cisco.com/en/US/docs/routers/access/800/860-880-890/hardware/installation/guide/2Instal1880-860.html>

## Cisco C886VAJ Router

Figure 1-40 shows the front panel of the Cisco C886VAJ Router.

Figure 1-40 Front Panel of the Cisco C886VAJ Router

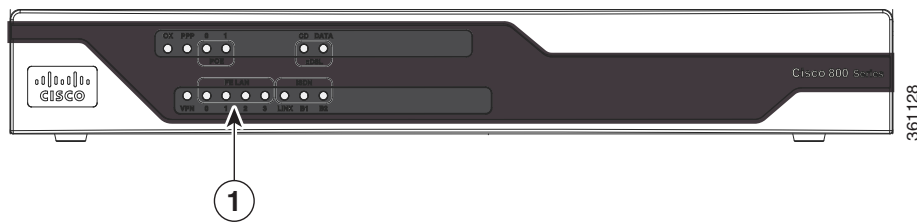

1	LEDs		
---	------	--	--

For detailed description about LEDs on the Cisco 880 Series Router, see the “LEDs” section on page 1-30.

Figure 1-41 shows the back panel of the Cisco C886VAJ Router.

Figure 1-41 Back Panel of the Cisco C886VAJ Router

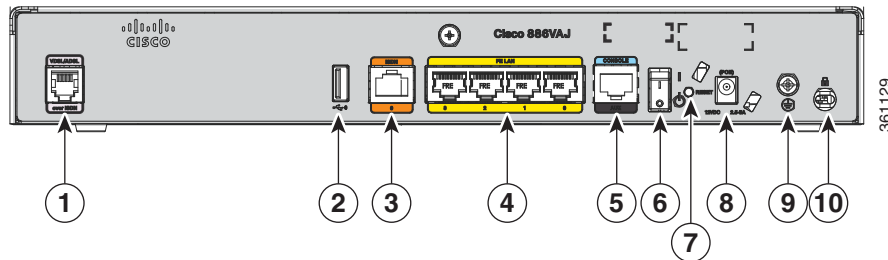

1	Primary WAN port—VDSL/ADSL over ISDN	6	On/Off switch
2	USB port	7	Reset button
3	ISDN	8	Power connector
4	4-port 10/100 Ethernet switch	9	Earth ground connection
5	Serial port—Console or auxiliary	10	Kensington security slot

For information on installing Cisco C880 Series Routers, see:

<http://www.cisco.com/en/US/docs/routers/access/800/860-880-890/hardware/installation/guide/2Instal1880-860.html>

## Cisco C887VA Router

Figure 1-42 shows the front panel of the Cisco C887VA Router.

Figure 1-42 Front Panel of the Cisco C887VA Router

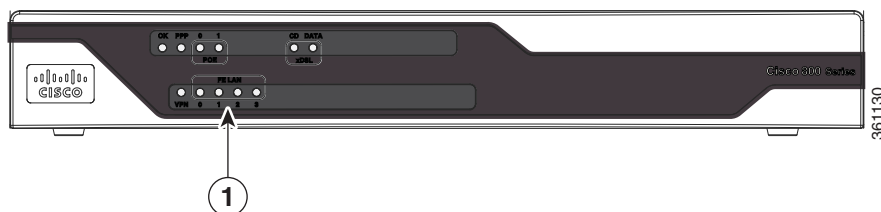

1	LEDs		
---	------	--	--

For detailed description about the LEDs on Cisco C880 Series Router, see the “LEDs” section on page 1-30.

Figure 1-43 shows the back panel of the Cisco C887VA Router.

Figure 1-43 Back Panel of the Cisco C887VA Router

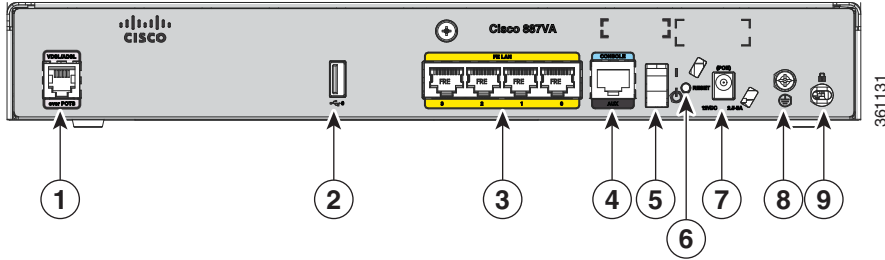

1	Primary WAN port—VDSL/ADSL over POTS	6	Reset button
2	USB port	7	Power connector
3	4-port 10/100 Ethernet switch	8	Earth ground connection
4	Serial port—console or auxiliary	9	Kensington security slot
5	On/Off switch		

For information on installing Cisco C880 series routers, see the following link:

<http://www.cisco.com/en/US/docs/routers/access/800/860-880-890/hardware/installation/guide/2Instal1880-860.html>

### Cisco C887VAM Router

Figure 1-44 shows the front panel of the Cisco C887VAM router:

Figure 1-44 Front Panel of the Cisco C887VAM Router

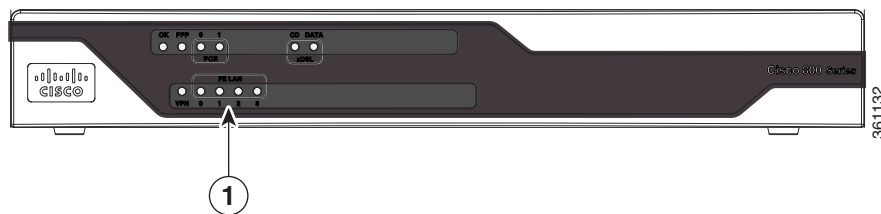

1	LEDs		
---	------	--	--

For detailed description about LEDs on Cisco C880 series router, see “LEDs” section on page 1-30.

Figure 1-45 shows the back panel of the Cisco C887VAM router.

Figure 1-45 Back Panel of the Cisco C887VAM Router

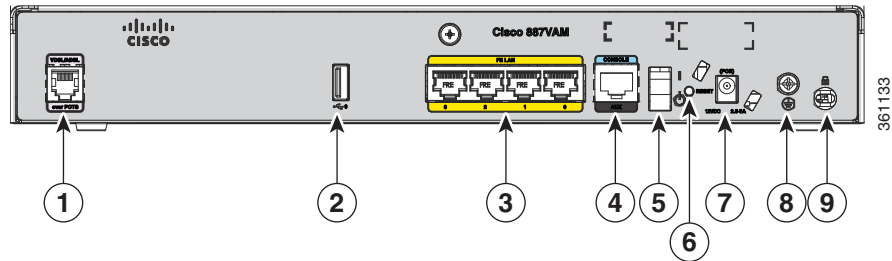

1	Primary WAN port—VDSL/ADSL over POTS	6	Reset button
2	USB port	7	Power connector
3	4-port 10/100 Ethernet switch	8	Earth ground connection
4	Serial port—Console or auxiliary	9	Kensington security slot
5	On/Off switch		

For information on installing the Cisco C880 Series Routers, see:

<http://www.cisco.com/en/US/docs/routers/access/800/860-880-890/hardware/installation/guide/2Instal1880-860.html>



## Cisco C888 Integrated Services Router

The Cisco C888 Integrated Services Router (ISR) offers broadband speeds and simplified management to small businesses, enterprise small branches, and teleworkers. The Cisco C888 ISR supports multi mode G.SHDSL (EFM+ATM) WAN connectivity. The Cisco C888 ISR has a lead free, fanless chassis and it is an updated version of the previous Cisco 888 (888 A and 888 EA) ISR models.

Table 1-30 provides information about important hardware specifications pertaining to the Cisco C888 ISR.

**Table 1-30** Hardware Specifications for Cisco C888 ISR

Hardware	Description
Flash Memory	256 MB
Main Memory	1-GB DDR RAM ; fixed, and not extendable
USB port	A USB 2.0-compliant port located at the back panel
FAN	Fanless chassis.
PoE	Two internal PoE ports
WAN	4-pair multimode G.SHDSL (EFM+ATM) with ISDN backup.
Console or auxiliary port	RJ-45
LAN switch	4-port 10/100BASE-T



**Note** If you change G.SHDSL mode from EFM to ATM or from ATM to EFM, you should reload the router.



**Note** EFM auto mode is supported only on the first pair. EFM manual mode can be supported on all the 4 pairs.



**Note** Cisco C888 ISR does not support Inverse Multiplexing over ATM (IMA) mode.

For detailed hardware specifications, see the Cisco 880 Series hardware data sheet at:

[http://www.cisco.com/en/US/prod/collateral/routers/ps380/data\\_sheet\\_c78\\_459542\\_ps380\\_Products\\_Data\\_Sheet.html](http://www.cisco.com/en/US/prod/collateral/routers/ps380/data_sheet_c78_459542_ps380_Products_Data_Sheet.html)

Figure 1-46 shows the front panel of the Cisco C888 Router:

Figure 1-46 Front Panel of the Cisco C888 Router

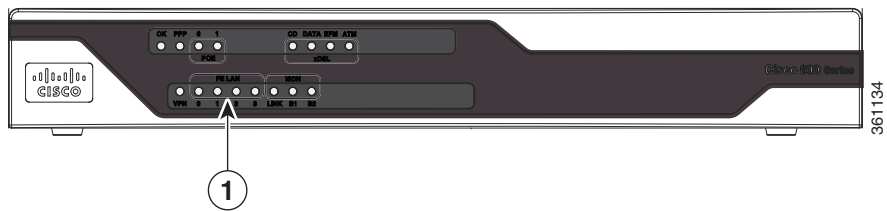

1	LEDs	
---	------	--

For detailed description about the LEDs on the Cisco 880 Series Routers, see information available at: <http://www.cisco.com/en/US/docs/routers/access/800/860-880-890/hardware/installation/guide/1Overview880-860.html#wp1147924>

Figure 1-47 shows the back panel of the Cisco C888 Router.

Figure 1-47 Back Panel of the Cisco C888 Router

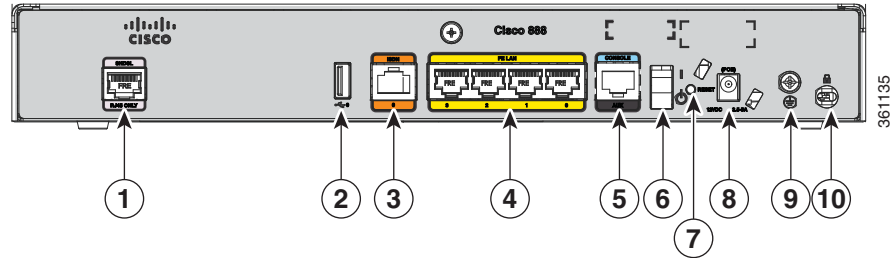

1	Primary WAN port—G.SHDSL	6	On/Off switch
2	USB port	7	Reset button
3	ISDN	8	Power connector
4	4-port 10/100 Ethernet switch	9	Earth ground connection
5	Serial port—console or auxiliary	10	Kensington security slot

For information on installing Cisco 800 Series Routers, see the information available at:

<http://www.cisco.com/c/en/us/td/docs/routers/access/800/hardware/installation/guide/800HIG/installing.html#pgfId-1098019>

## Cisco C880 Series and Cisco C890 Series 4G LTE Integrated Services Routers

Cisco C880 Series and Cisco C890 Series 4G LTE Integrated Services Routers (ISRs) extend 4G LTE support to the existing Cisco 880 Series and Cisco 890 Series ISRs. The Cisco C880 Series and Cisco C890 Series 4G LTE ISRs are based on the Sierra Wireless MC7304 modem and Cisco C880 Series and Cisco C890 4G LTE Series ISRs can support higher data rates compared to 3G in both up link and down link directions with 4G LTE support.

This section provides information about the following models:

- Cisco C881G-4G ISR
- Cisco C887VAG-4G ISR
- Cisco C896VAG-LTE ISR
- Cisco C897VAG-LTE ISR
- Cisco C898EAG-LTE ISR
- Cisco C899G-LTE ISR

[Table 1-31](#) provides information about important hardware specifications pertaining to Cisco C880 4G LTE Series ISRs.

**Table 1-31** Hardware Specifications for Cisco C880 4G LTE Series ISRs

Hardware	Description
Flash Memory	1GB
Main Memory	1-GB DDR RAM
USB port	A USB 2.0-compliant port located at the back panel
PoE	Two PoE ports
WAN	<ul style="list-style-type: none"> <li>• C881G-4G— FE</li> <li>• C887VAG-4G—VDSL or ADSL over POTS</li> </ul>
Console or auxiliary port	RJ-45
LAN switch	4-port 10/100BASE-T

[Table 1-32](#) provides information about important hardware specifications pertaining to Cisco C890 4G LTE Series ISRs.

**Table 1-32** Hardware Specifications for Cisco C890 4G LTE Series ISRs

Hardware	Description
Flash Memory	1 GB
Main Memory	1-GB DRAM
USB port	A USB 2.0-compliant port located at the back panel.
PoE	Four PoE ports

**Table 1-32** Hardware Specifications for Cisco C890 4G LTE Series ISRs

Hardware	Description
WAN	<ul style="list-style-type: none"><li>• C896VAG-LTE—VDSL or ADSL over ISDN, GE</li><li>• C897VAG-LTE—VDSL or ADSL over POTS, GE</li><li>• C898EAG-LTE—G.SHDSL over POTS, GE</li><li>• C899G-LTE—GE, SFP</li></ul>
Console or auxiliary port	RJ-45
LAN switch	8-port 10/100/1000 BASE-T

[Table 1-33](#) lists the different 4G LTE SKUs available for the Cisco 880 and Cisco 890 series ISRs.

Table 1-33 Supported 4G LTE SKUs for the Cisco 880 and Cisco 890 Series ISRs

SKU ID	Mode	Operating Region	Frequency Band	Description
C881G-4G-GA-K9	<ul style="list-style-type: none"> <li>• LTE</li> <li>• HSPA+</li> <li>• HSPA</li> <li>• UMTS</li> <li>• EDGE</li> <li>• GPRS</li> </ul>	Global (Europe, New Zealand, and Australia)	LTE: <ul style="list-style-type: none"> <li>• 800 MHz (band 20)</li> <li>• 900 MHz (band 8)</li> <li>• 1800 MHz (band 3)</li> <li>• 2100 MHz (band 1)</li> <li>• 2600 MHz (band 7)</li> </ul> 3G (UMTS, HSPA+, HSPA): <ul style="list-style-type: none"> <li>• 800 MHz (band 6)</li> <li>• 850 MHz (band 5)</li> <li>• 900 MHz (band 8)</li> <li>• 1900 MHz (band 2)</li> <li>• 2100 MHz (band 1)</li> </ul> 2G (GSM, EDGE, GPRS): <ul style="list-style-type: none"> <li>• 850 MHz</li> <li>• 900 MHz</li> <li>• 1800 MHz</li> <li>• 1900 MHz</li> </ul>	Cisco 880 Series ISR Multimode LTE feature for global wireless networks. C881G-4G-GA-K9 comes with a Sierra Wireless MC7304 modem.
C886VAG-LTE-GA-K9	<ul style="list-style-type: none"> <li>• LTE</li> <li>• HSPA+</li> <li>• HSPA</li> <li>• UMTS</li> <li>• EDGE</li> <li>• GPRS</li> </ul>	Global (Europe, New Zealand, and Australia)	LTE: <ul style="list-style-type: none"> <li>• 800 MHz (band 20)</li> <li>• 900 MHz (band 8)</li> <li>• 1800 MHz (band 3)</li> <li>• 2100 MHz (band 1)</li> <li>• 2600 MHz (band 7)</li> </ul> 3G (UMTS, HSPA+, HSPA): <ul style="list-style-type: none"> <li>• 800 MHz (band 6)</li> <li>• 850 MHz (band 5)</li> <li>• 900 MHz (band 8)</li> <li>• 1900 MHz (band 2)</li> <li>• 2100 MHz (band 1)</li> </ul> 2G (GSM, EDGE, GPRS): <ul style="list-style-type: none"> <li>• 850 MHz</li> <li>• 900 MHz</li> <li>• 1800 MHz</li> <li>• 1900 MHz</li> </ul>	Cisco 880 series ISR with Multimode LTE feature for global wireless networks. C886VAG-LTE-GA-K9 comes with a Sierra Wireless MC7304 modem.

Table 1-33 Supported 4G LTE SKUs for the Cisco 880 and Cisco 890 Series ISRs (continued)

SKU ID	Mode	Operating Region	Frequency Band	Description
C887VAG-4G-GA-K9	<ul style="list-style-type: none"> <li>• LTE</li> <li>• HSPA+</li> <li>• HSPA</li> <li>• UMTS</li> <li>• EDGE</li> <li>• GPRS</li> </ul>	Global (Europe, New Zealand, and Australia)	LTE: <ul style="list-style-type: none"> <li>• 800 MHz (band 20)</li> <li>• 900 MHz (band 8)</li> <li>• 1800 MHz (band 3)</li> <li>• 2100 MHz (band 1)</li> <li>• 2600 MHz (band 7)</li> </ul> 3G (UMTS, HSPA+, HSPA): <ul style="list-style-type: none"> <li>• 800 MHz (band 6)</li> <li>• 850 MHz (band 5)</li> <li>• 900 MHz (band 8)</li> <li>• 1900 MHz (band 2)</li> <li>• 2100 MHz (band 1)</li> </ul> 2G (GSM, EDGE, GPRS): <ul style="list-style-type: none"> <li>• 850 MHz</li> <li>• 900 MHz</li> <li>• 1800 MHz</li> <li>• 1900 MHz</li> </ul>	Cisco 880 series ISR with Multimode LTE feature for global wireless networks. C887VAG-4G-GA-K9 comes with a Sierra Wireless MC7304 modem.
C896VAG-LTE-GA-K9	<ul style="list-style-type: none"> <li>• LTE</li> <li>• HSPA+</li> <li>• HSPA</li> <li>• UMTS</li> <li>• EDGE</li> <li>• GPRS</li> </ul>	Global (Europe, New Zealand, and Australia)	LTE: <ul style="list-style-type: none"> <li>• 800 MHz (band 20)</li> <li>• 900 MHz (band 8)</li> <li>• 1800 MHz (band 3)</li> <li>• 2100 MHz (band 1)</li> <li>• 2600 MHz (band 7)</li> </ul> 3G (UMTS, HSPA+, HSPA): <ul style="list-style-type: none"> <li>• 800 MHz (band 6)</li> <li>• 850 MHz (band 5)</li> <li>• 900 MHz (band 8)</li> <li>• 1900 MHz (band 2)</li> <li>• 2100 MHz (band 1)</li> </ul> 2G (GSM, EDGE, GPRS): <ul style="list-style-type: none"> <li>• 850 MHz</li> <li>• 900 MHz</li> <li>• 1800 MHz</li> <li>• 1900 MHz</li> </ul>	Cisco 890 series ISR with Multimode LTE feature for global wireless networks. C896VAG-LTE-GA-K9 comes with a Sierra Wireless MC7304 modem.



Table 1-33 Supported 4G LTE SKUs for the Cisco 880 and Cisco 890 Series ISRs (continued)

SKU ID	Mode	Operating Region	Frequency Band	Description
C897VAG-LTE-GA-K9	<ul style="list-style-type: none"> <li>• LTE</li> <li>• HSPA+</li> <li>• HSPA</li> <li>• UMTS</li> <li>• EDGE</li> <li>• GPRS</li> </ul>	Global (Europe, New Zealand, and Australia)	<p>4G:</p> <ul style="list-style-type: none"> <li>• 800 MHz (band 20)</li> <li>• 900 MHz (band 8)</li> <li>• 1800 MHz (band 3)</li> <li>• 2100 MHz (band 1)</li> <li>• 2600 MHz (band 7)</li> </ul> <p>3G (UMTS, HSPA+, HSPA):</p> <ul style="list-style-type: none"> <li>• 800 MHz (band 6)</li> <li>• 850 MHz (band 5)</li> <li>• 900 MHz (band 8)</li> <li>• 1900 MHz (band 2)</li> <li>• 2100 MHz (band 1)</li> </ul> <p>2G (GSM, EDGE, GPRS):</p> <ul style="list-style-type: none"> <li>• 850 MHz</li> <li>• 900 MHz</li> <li>• 1800 MHz</li> <li>• 1900 MHz</li> </ul>	Cisco 890 series ISR with Multimode LTE feature for global wireless networks. C897VAG-LTE-GA-K9 comes with a Sierra Wireless MC7304 modem.
C897VAMG-LTE-GA-K9	<ul style="list-style-type: none"> <li>• LTE</li> <li>• HSPA+</li> <li>• HSPA</li> <li>• UMTS</li> <li>• EDGE</li> <li>• GPRS</li> </ul>	Global (Europe, New Zealand, and Australia)	<p>LTE:</p> <ul style="list-style-type: none"> <li>• 800 MHz (band 20)</li> <li>• 900 MHz (band 8)</li> <li>• 1800 MHz (band 3)</li> <li>• 2100 MHz (band 1)</li> <li>• 2600 MHz (band 7)</li> </ul> <p>3G (UMTS, HSPA+, HSPA):</p> <ul style="list-style-type: none"> <li>• 800 MHz (band 6)</li> <li>• 850 MHz (band 5)</li> <li>• 900 MHz (band 8)</li> <li>• 1900 MHz (band 2)</li> <li>• 2100 MHz (band 1)</li> </ul> <p>2G (GSM, EDGE, GPRS):</p> <ul style="list-style-type: none"> <li>• 850 MHz</li> <li>• 900 MHz</li> <li>• 1800 MHz</li> <li>• 1900 MHz</li> </ul>	Cisco 890 series ISR with Multimode LTE feature for global wireless networks. C897VAMG-LTE-GA-K9 comes with a Sierra Wireless MC7304 modem.

Table 1-33 Supported 4G LTE SKUs for the Cisco 880 and Cisco 890 Series ISRs (continued)

SKU ID	Mode	Operating Region	Frequency Band	Description
C897VAG-LTE-LA-K9	<ul style="list-style-type: none"> <li>• LTE</li> <li>• HSPA+</li> <li>• HSPA</li> <li>• UMTS</li> </ul>	Latin America	<p>For FDD LTE:</p> <ul style="list-style-type: none"> <li>• 700 MHz (band 28)</li> <li>• 850 MHz (band 5)</li> <li>• 800 MHz (band 19)</li> <li>• 800 MHz (band 18)</li> <li>• 900 MHz (band 8)</li> <li>• 1800 MHz (band 3)</li> <li>• 2100 MHz (band 1)</li> <li>• 2600 MHz (band 7)</li> </ul> <p>For TDD LTE:</p> <ul style="list-style-type: none"> <li>• 1900 MHz (Band 39)</li> <li>• 2300 MHz (Band 40)</li> <li>• 2500 MHz (Band 41)</li> <li>• 2600 MHz (Band 38)</li> </ul> <p>For UMTS, HSPA+, HSPA:</p> <ul style="list-style-type: none"> <li>• 800 MHz (band 6)</li> <li>• 800 MHz (band 19)</li> <li>• 850 MHz (band 5)</li> <li>• 900 MHz (band 8)</li> <li>• 1700 MHz (band 9)</li> <li>• 2100 MHz (band 1)</li> </ul>	C897VAG-LTE-LA-K9 is a dedicated Multimode LTE SKU for Latin American wireless networks and comes with a Sierra Wireless MC7430 modem.

Table 1-33 Supported 4G LTE SKUs for the Cisco 880 and Cisco 890 Series ISRs (continued)

SKU ID	Mode	Operating Region	Frequency Band	Description
C898EAG-LTE-GA-K9	<ul style="list-style-type: none"> <li>• LTE</li> <li>• HSPA+</li> <li>• HSPA</li> <li>• UMTS</li> <li>• EDGE</li> <li>• GPRS</li> </ul>	Global (Europe, New Zealand, and Australia)	LTE: <ul style="list-style-type: none"> <li>• 800 MHz (band 20)</li> <li>• 900 MHz (band 8)</li> <li>• 1800 MHz (band 3)</li> <li>• 2100 MHz (band 1)</li> <li>• 2600 MHz (band 7)</li> </ul> 3G (UMTS, HSPA+, HSPA): <ul style="list-style-type: none"> <li>• 800 MHz (band 6)</li> <li>• 850 MHz (band 5)</li> <li>• 900 MHz (band 8)</li> <li>• 1900 MHz (band 2)</li> <li>• 2100 MHz (band 1)</li> </ul> 2G (GSM, EDGE, GPRS): <ul style="list-style-type: none"> <li>• 850 MHz</li> <li>• 900 MHz</li> <li>• 1800 MHz</li> <li>• 1900 MHz</li> </ul>	Cisco 890 series ISR with Multimode LTE feature for global wireless networks. C898EAG-LTE-GA-K9 comes with a Sierra Wireless MC7304 modem.

Table 1-33 Supported 4G LTE SKUs for the Cisco 880 and Cisco 890 Series ISRs (continued)

SKU ID	Mode	Operating Region	Frequency Band	Description
C898EAG-LTE-LA-K9	<ul style="list-style-type: none"> <li>• LTE</li> <li>• HSPA+</li> <li>• HSPA</li> <li>• UMTS</li> </ul>	ASEAN	<p>For FDD LTE:</p> <ul style="list-style-type: none"> <li>• 700 MHz (band 28)</li> <li>• 850 MHz (band 5)</li> <li>• 800 MHz (band 19)</li> <li>• 800 MHz (band 18)</li> <li>• 900 MHz (band 8)</li> <li>• 1800 MHz (band 3)</li> <li>• 2100 MHz (band 1)</li> <li>• 2600 MHz (band 7)</li> </ul> <p>For TDD LTE:</p> <ul style="list-style-type: none"> <li>• 1900 MHz (Band 39)</li> <li>• 2300 MHz (Band 40)</li> <li>• 2500 MHz (Band 41)</li> <li>• 2600 MHz (Band 38)</li> </ul> <p>For UMTS, HSPA+, HSPA:</p> <ul style="list-style-type: none"> <li>• 800 MHz (band 6)</li> <li>• 800 MHz (band 19)</li> <li>• 850 MHz (band 5)</li> <li>• 900 MHz (band 8)</li> <li>• 1700 MHz (band 9)</li> <li>• 2100 MHz (band 1)</li> </ul>	C898EAG-LTE-LA-K9 is a dedicated Multimode LTE SKU for Asean wireless networks and comes with a Sierra Wireless MC7430 modem.

Table 1-33 Supported 4G LTE SKUs for the Cisco 880 and Cisco 890 Series ISRs (continued)

SKU ID	Mode	Operating Region	Frequency Band	Description
C899G-LTE-LA-K9	<ul style="list-style-type: none"> <li>• LTE</li> <li>• HSPA+</li> <li>• HSPA</li> <li>• UMTS</li> </ul>	Latin America and APAC	<p>For FDD LTE:</p> <ul style="list-style-type: none"> <li>• 700 MHz (band 28)</li> <li>• 850 MHz (band 5)</li> <li>• 800 MHz (band 19)</li> <li>• 800 MHz (band 18)</li> <li>• 900 MHz (band 8)</li> <li>• 1800 MHz (band 3)</li> <li>• 2100 MHz (band 1)</li> <li>• 2600 MHz (band 7)</li> </ul> <p>For TDD LTE:</p> <ul style="list-style-type: none"> <li>• 1900 MHz (Band 39)</li> <li>• 2300 MHz (Band 40)</li> <li>• 2500 MHz (Band 41)</li> <li>• 2600 MHz (Band 38)</li> </ul> <p>For UMTS, HSPA+, HSPA:</p> <ul style="list-style-type: none"> <li>• 800 MHz (band 6)</li> <li>• 800 MHz (band 19)</li> <li>• 850 MHz (band 5)</li> <li>• 900 MHz (band 8)</li> <li>• 1700 MHz (band 9)</li> <li>• 2100 MHz (band 1)</li> </ul>	C899G-LTE-LA-K9 is a dedicated Multimode LTE SKU for Latin American and APAC wireless networks and comes with a Sierra Wireless MC7430 modem.

Table 1-33 Supported 4G LTE SKUs for the Cisco 880 and Cisco 890 Series ISRs (continued)

SKU ID	Mode	Operating Region	Frequency Band	Description
C899G-LTE-GA-K9	<ul style="list-style-type: none"> <li>• LTE</li> <li>• HSPA+</li> <li>• HSPA</li> <li>• UMTS</li> <li>• EDGE</li> <li>• GPRS</li> </ul>	Global (Europe, New Zealand, and Australia)	<p>LTE:</p> <ul style="list-style-type: none"> <li>• 800 MHz (band 20)</li> <li>• 900 MHz (band 8)</li> <li>• 1800 MHz (band 3)</li> <li>• 2100 MHz (band 1)</li> <li>• 2600 MHz (band 7)</li> </ul> <p>3G (UMTS, HSPA+, HSPA):</p> <ul style="list-style-type: none"> <li>• 800 MHz (band 6)</li> <li>• 850 MHz (band 5)</li> <li>• 900 MHz (band 8)</li> <li>• 1900 MHz (band 2)</li> <li>• 2100 MHz (band 1)</li> </ul> <p>2G (GSM, EDGE, GPRS):</p> <ul style="list-style-type: none"> <li>• 850 MHz</li> <li>• 900 MHz</li> <li>• 1800 MHz</li> <li>• 1900 MHz</li> </ul>	Cisco 890 series ISR with Multimode LTE feature for global wireless networks. C899G-LTE-GA-K9 comes with a Sierra Wireless MC7304 modem.
C899G-LTE-VZ-K9	<ul style="list-style-type: none"> <li>• LTE</li> <li>• EVDO Rev-A</li> <li>• 1xRTT</li> </ul>	North America (Verizon)	<p>LTE:</p> <ul style="list-style-type: none"> <li>• AWS (band 4)</li> <li>• 700 MHz (band 13)</li> <li>• PCS 1900 MHz (band 25)</li> </ul> <p>3G:</p> <ul style="list-style-type: none"> <li>• 800 MHz (band class 0)</li> <li>• 1900 MHz (band class 1)</li> <li>• 800 MHz (band class 10)</li> </ul> <p>2G:</p> <ul style="list-style-type: none"> <li>• 800 MHz (band class 0)</li> <li>• 1900 MHz (band class 1)</li> <li>• 800 MHz (band class 10)</li> </ul>	Cisco 890 series ISR with Multimode LTE feature for Verizon wireless networks. C899G-LTE-VZ-K9 comes with a Sierra Wireless MC7350 modem.

Table 1-33 Supported 4G LTE SKUs for the Cisco 880 and Cisco 890 Series ISRs (continued)

SKU ID	Mode	Operating Region	Frequency Band	Description
C899G-LTE-NA-K9	<ul style="list-style-type: none"> <li>• LTE</li> <li>• HSPA+</li> <li>• HSPA</li> <li>• UMTS</li> <li>• EDGE</li> <li>• GPRS</li> </ul>	North America (AT&T, Bell-Canada, Roger, Telus, and other GSM/LTE operators in USA and Canada)	LTE: <ul style="list-style-type: none"> <li>• AWS (band 4)</li> <li>• 700 MHz (band 5)</li> <li>• 850 MHz (band 17)</li> <li>• 1900 MHz (band 2)</li> <li>• 2600 MHz (band 7)</li> </ul> 3G (UMTS, HSPA+, HSPA): <ul style="list-style-type: none"> <li>• 1900 MHz (band 2)</li> <li>• AWS (band 4)</li> <li>• 850 (band 5)</li> </ul> 2G (GSM, EDGE, GPRS): <ul style="list-style-type: none"> <li>• 850 MHz</li> <li>• 900 MHz</li> <li>• 1800 MHz</li> <li>• 1900 MHz</li> </ul>	Cisco 890 series ISR with Multimode LTE feature for wireless networks in USA and Canada. C899G-LTE-NA-K9 comes with a Sierra Wireless MC7354 modem.

Table 1-33 Supported 4G LTE SKUs for the Cisco 880 and Cisco 890 Series ISRs (continued)

SKU ID	Mode	Operating Region	Frequency Band	Description
C899G-LTE-ST-K9	<ul style="list-style-type: none"> <li>• LTE</li> <li>• EVDO Rev-A</li> <li>• 1xRTT</li> </ul>	North America (Sprint)	LTE: <ul style="list-style-type: none"> <li>• AWS (band 4)</li> <li>• 700 MHz (band 13)</li> <li>• PCS 1900 MHz (band 25)</li> </ul> 3G: <ul style="list-style-type: none"> <li>• 800 MHz (band class 0)</li> <li>• 1900 MHz (band class 1)</li> <li>• 800 MHz (band class 10)</li> </ul> 2G: <ul style="list-style-type: none"> <li>• 800 MHz (band class 0)</li> <li>• 1900 MHz (band class 1)</li> <li>• 800 MHz (band class 10)</li> </ul>	Cisco 890 series ISR with Multimode LTE feature for Sprint wireless networks. C899G-LTE-ST-K9 comes with a Sierra Wireless MC7350 modem.
C899G-LTE-JP-K9	<ul style="list-style-type: none"> <li>• LTE</li> <li>• HSPA+</li> <li>• HSPA</li> <li>• UMTS</li> <li>• EDGE</li> <li>• GPRS</li> </ul>	Global (Japan)	LTE: <ul style="list-style-type: none"> <li>• 800 MHz (band 20)</li> <li>• 850 MHz (band 19)</li> <li>• 900 MHz (band 8)</li> <li>• 1500 MHz (band 21)</li> <li>• 1800 MHz (band 3)</li> <li>• 2100 MHz (band 1)</li> <li>• 2600 MHz (band 7)</li> </ul> 3G (UMTS, HSPA+, HSPA): <ul style="list-style-type: none"> <li>• 800 MHz (band 6)</li> <li>• 850 MHz (band 5)</li> <li>• 900 MHz (band 8)</li> <li>• 1900 MHz (band 2)</li> <li>• 2100 MHz (band 1)</li> </ul> 2G (GSM, EDGE, GPRS): <ul style="list-style-type: none"> <li>• 850 MHz</li> <li>• 900 MHz</li> <li>• 1800 MHz</li> <li>• 1900 MHz</li> </ul>	Cisco 890 series ISR with Multimode LTE feature for global wireless networks. C899G-LTE-JP-K9 comes with a Sierra Wireless MC7330 modem.



## Cisco C881G-4G Integrated Services Router

Figure 1-48 shows the front panel of the Cisco C881G-4G ISR.

Figure 1-48 Front Panel of the Cisco C881G-4G ISR

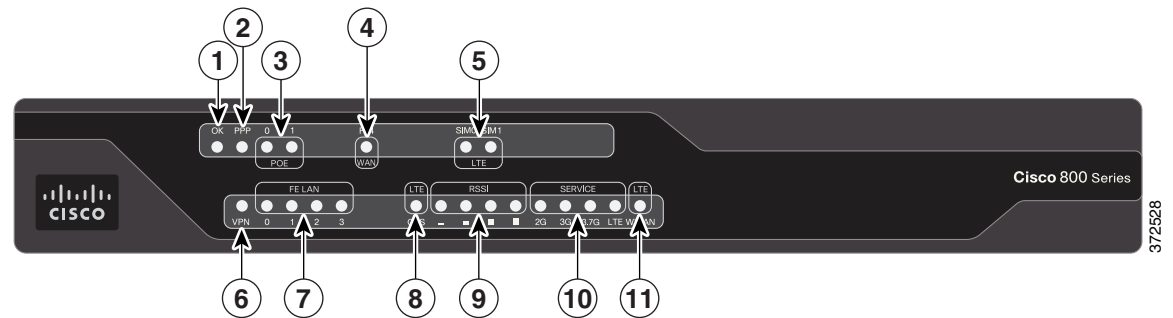

1	Power OK	7	FE LAN
2	PPP	8	GPS
3	PoE	9	RSSI
4	FE WAN Port	10	4G
5	SIM	11	WWAN
6	VPN		

Table 1-34 describes the LEDs of the Cisco C881G-4G ISR.

Table 1-34 LED Descriptions for the Cisco C881G-4G ISR

Number	LED	Color	Description
1	Power OK	Green	On—DC power is being supplied to the router and the Cisco IOS software is running. Blinking—Boot up is in process, or the router is in ROMMON mode. Off—Power is not supplied to the router.
2	PPP	Green	On—At least one PPP session is established.
3	PoE	Green	On—PoE is connected and powered. Off—PoE is not installed.
		Amber	On—Fault with the PoE.
4	FE WAN Port Link	Green	On—Port is connected.
			Blinking—Data is either being received or transmitted.
			Off—Port is not connected.

**Table 1-34 LED Descriptions for the Cisco C881G-4G ISR**

Number	LED	Color	Description
5	SIM	Green / Yellow (one green blink followed by two yellow blinks)	SIM in slot 0 is active, SIM in slot 1 is not.
		Yellow / Green (one yellow blink followed by two green blinks)	SIM in slot 1 active, SIM in slot 0 is not.
		Off / Green (two green blinks and then a pause)	No SIM in slot 0, SIM present in slot 1.
		Green / Off (slow blink once and then a pause)	SIM is present in slot0, no SIM in slot 1.
		Off / Off	No SIM present in either slots.
6	VPN	Green	On—VPN is connected.
7	FE LAN Port Links Status	Green	On—Ethernet port is connected. Blinking—Data is either being received or being transmitted. Off—Ethernet port is not connected.
8	GPS	Green (solid)	Standalone GPS.
		Green (slow blinking)	GPS is acquiring signals.
		Yellow (solid)	Assisted GPS.
		Yellow (slow blinking)	Assisted GPS is acquiring signals.
		Off	GPS is not configured.
9	RSSI	Green (solid)	Signal strength bars are indicated by the corresponding LEDs.
10	Service	Green (solid)	Service is active and the corresponding LED is lit based on the service level that is active (2G, 3G,3.7G, LTE).
		Off	No service.

**Table 1-34 LED Descriptions for the Cisco C881G-4G ISR**

Number	LED	Color	Description
11	WWAN	Green	Module is powered on and connected but not transmitting or receiving.
		Green (slow blinking)	Module is powered on and searching for connection.
		Green (fast blinking)	Module is transmitting or receiving.
		Off	Module is not powered.

Figure 1-49 shows the back panel of the Cisco C881G-4G ISR.

Figure 1-49 Back Panel of the Cisco C881G-4G ISR

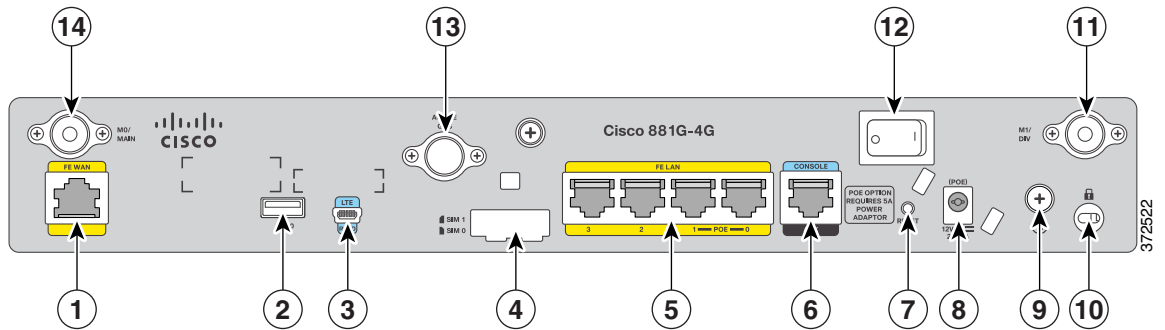

1	Primary WAN port—FE	9	Earth ground connection
2	USB port	10	Kensington security slot
3	4G port	11	4G Antenna connector—M1/DIV
4	SIM slots	12	Power switch
5	4-port 10/100 Ethernet switch	13	Active GPS antenna connector
6	Serial port—Console or auxiliary	14	4G Antenna connector—M0/MAIN
7	Reset button		
8	Power connector		

For information on installing the Cisco C880 Series Routers, see:

<http://www.cisco.com/c/en/us/td/docs/routers/access/800/hardware/installation/guide/800HIG.html>

## Cisco C886VAG-LTE

Figure 1-50 shows the front panel of the Cisco C886VAG-LTE ISR.

Figure 1-50 Front Panel of the Cisco C886VAG-LTE ISR

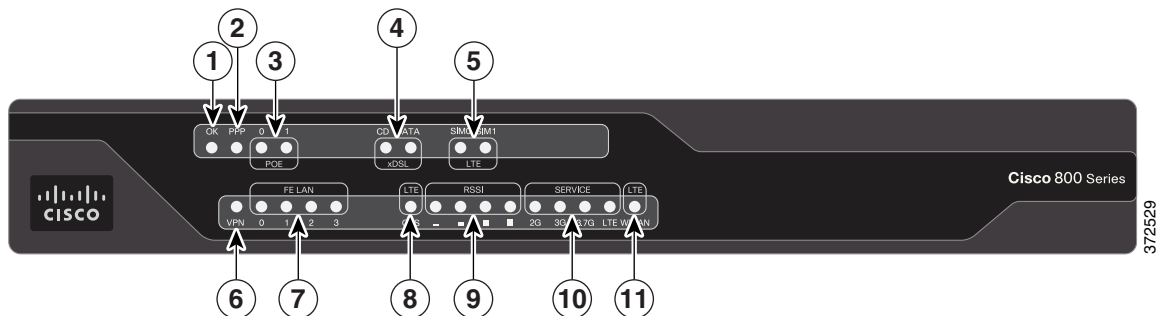

Table 1-35 describes the LEDs for Cisco C886VAG-LTE ISR.

**Table 1-35 LED Descriptions for the Cisco C886VAG-LTE ISR**

Number	LED	Color	Description
1	Power OK	Green	On—DC power is being supplied to the router and the Cisco IOS software is running. Blinking—Boot up is in process, or the router is in ROMMON mode. Off—Power is not supplied to the router.
2	PPP	Green	On—At least one PPP session is established.
3	PoE	Green	On—PoE is connected and powered. Off—PoE is not installed.
		Amber	On—Fault with the PoE.
4	xDSL CD	Green	On—The xDSL interface is connected to the DSLAM. Blinking—Training the line. Off—Indicates that a connection has not been established or the port is shut down.
	xDSL Data	Green	Blinking—The xDSL interface is either receiving or transmitting data. Off—No data is being transmitted or received.
5	SIM	Green / Yellow (one green blink followed by two yellow blinks)	SIM in slot 0 is active, SIM in slot 1 is not.
		Yellow / Green (one yellow blink followed by two green blinks)	SIM in slot 1 is active, SIM in slot 0 is not.
		Off / Green (two green blinks and then a pause)	No SIM in slot 0, SIM present in slot 1.
		Green / Off (slow blink once and then a pause)	SIM present in slot0, no SIM in slot 1.
		Off / Off	No SIM present in either slots.
6	VPN	Green	On—VPN is connected.
7	FE LAN Port Links Status	Green	On—Ethernet port is connected. Blinking—Data is either being received or transmitted. Off—Ethernet port is not connected.

**Table 1-35 LED Descriptions (continued) for the Cisco C886VAG-LTE ISR**

Number	LED	Color	Description
8	GPS	Green (solid)	Standalone GPS.
		Green (slow blinking)	GPS is acquiring signals.
		Yellow (solid)	Assisted GPS.
		Yellow (slow blinking)	Assisted GPS is acquiring signals.
		Off	GPS is not configured.
9	RSSI	Green (solid)	Signal strength bars are indicated by the corresponding LEDs.
10	Service	Green (Solid)	Service is active and the corresponding LED is lit based on the service level that is active (2G, 3G, 3.7G, LTE).
		Off	No service.
11	WWAN	Green	Module is powered on and connected but not transmitting or receiving.
		Green (slow blinking)	Module is powered on and searching for connection.
		Green (fast blinking)	Module is transmitting or receiving.
		Off	Module is not powered.

Figure 1-51 shows the back panel of the Cisco C886VAG-LTE ISR.

Figure 1-51 Back Panel of the Cisco C886VAG-LTE ISR

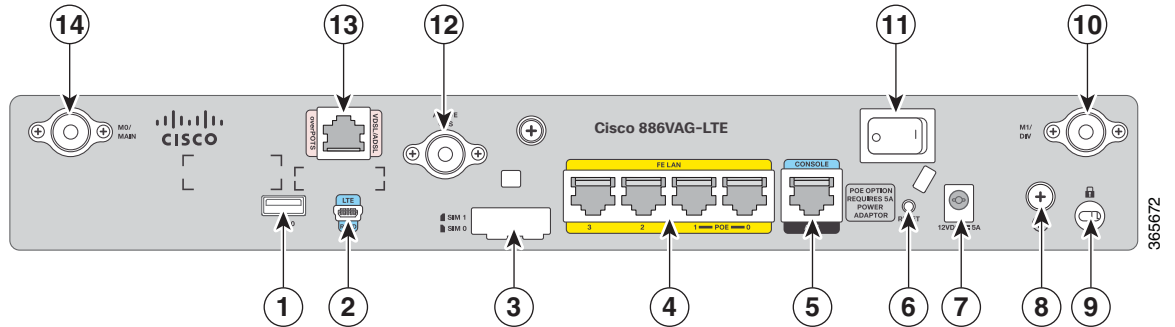

1	USB port	8	Earth ground connection
2	LTE port	9	Kensington security slot
3	SIM slots	10	LTE antenna connector—M1/DIV
4	4-port 10/100 Ethernet switch	11	Power switch
5	Serial port—Console or auxiliary	12	Active GPS antenna connector
6	Reset button	13	Primary WAN port—VDSL or ADSL over ISDN
7	Power connector	14	LTE antenna connector—M0/MAIN

## Cisco C887VAG-4G Integrated Services Router

Figure 1-52 shows the front panel of the Cisco C887VAG-4G ISR.

Figure 1-52 Front Panel of the Cisco C887VAG-4G ISR

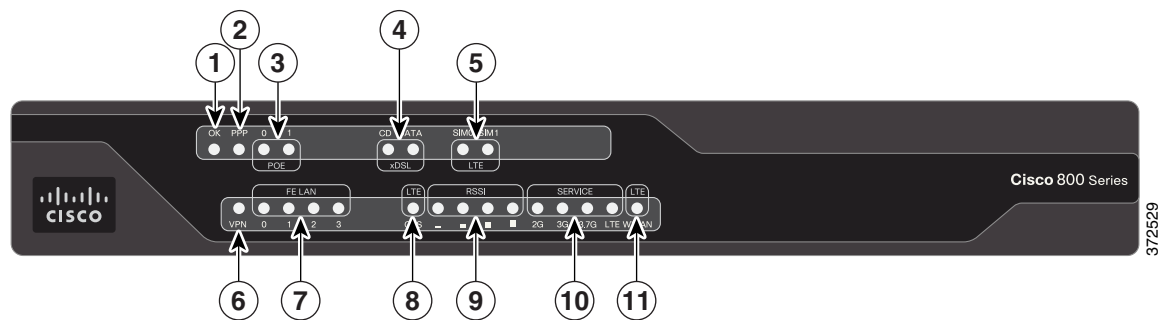

Table 1-36 describes the LEDs for Cisco C887VAG-4G ISR.

**Table 1-36 LED Descriptions for the Cisco C887VAG-4G ISR**

Number	LED	Color	Description
1	Power OK	Green	On—DC power is being supplied to the router and the Cisco IOS software is running. Blinking—Boot up is in process, or the router is in ROMMON mode. Off—Power is not supplied to the router.
2	PPP	Green	On—At least one PPP session is established.
3	PoE	Green	On—PoE is connected and powered. Off—PoE is not installed.
		Amber	On—Fault with the PoE.
4	xDSL CD	Green	On—The xDSL interface is connected to the DSLAM. Blinking—Training the line. Off—Indicates that a connection has not been established or the port is shut down.
	xDSL Data	Green	Blinking—The xDSL interface is either receiving or transmitting data. Off—No data is being transmitted or received.
5	SIM	Green / Yellow (one green blink followed by two yellow blinks)	SIM in slot 0 is active, SIM in slot 1 is not.
		Yellow / Green (one yellow blink followed by two green blinks)	SIM in slot 1 is active, SIM in slot 0 is not.
		Off / Green (two green blinks and then a pause)	No SIM in slot 0, SIM present in slot 1.
		Green / Off (slow blink once and then a pause)	SIM present in slot0, no SIM in slot 1.
		Off / Off	No SIM present in either slots.
6	VPN	Green	On—VPN is connected.
7	FE LAN Port Links Status	Green	On—Ethernet port is connected. Blinking—Data is either being received or transmitted. Off—Ethernet port is not connected.

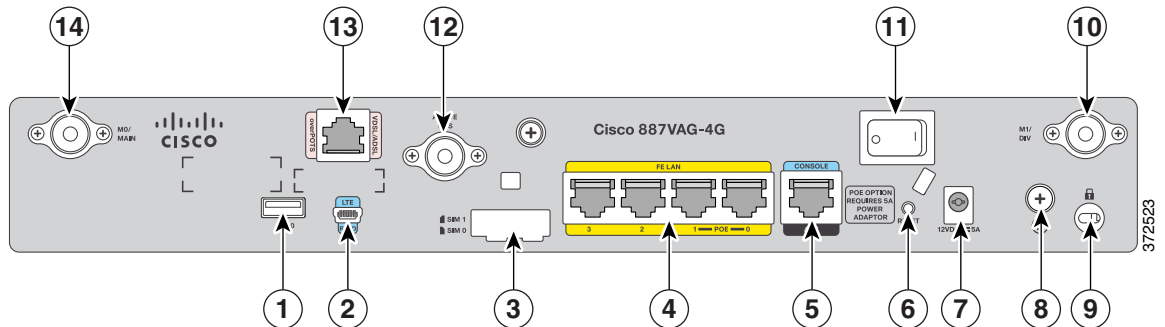

**Table 1-36 LED Descriptions (continued)for the Cisco C887VAG-4G ISR**

Number	LED	Color	Description
8	GPS	Green (solid)	Standalone GPS.
		Green (slow blinking)	GPS is acquiring signals.
		Yellow (solid)	Assisted GPS.
		Yellow (slow blinking)	Assisted GPS is acquiring signals.
		Off	GPS is not configured.
9	RSSI	Green (solid)	Signal strength bars are indicated by the corresponding LEDs.
10	Service	Green (Solid)	Service is active and the corresponding LED is lit based on the service level that is active (2G, 3G, 3.7G, LTE).
		Off	No service.
11	WWAN	Green	Module is powered on and connected but not transmitting or receiving.
		Green (slow blinking)	Module is powered on and searching for connection.
		Green (fast blinking)	Module is transmitting or receiving.
		Off	Module is not powered.

Figure 1-53 shows the back panel of the Cisco C887VAG-4G ISR.

Figure 1-53 Back Panel of the Cisco C887VAG-4G ISR



1	USB port	8	Earth ground connection
2	4G port	9	Kensington security slot
3	SIM slots	10	4G antenna connector—M1/DIV
4	4-port 10/100 Ethernet switch	11	Power switch
5	Serial port—Console or auxiliary	12	Active GPS antenna connector
6	Reset button	13	Primary WAN port—VDSL or ADSL over POTS
7	Power connector	14	4G antenna connector—M0/MAIN

## Cisco C896VAG-LTE Integrated Services Router

Figure 1-54 shows the front panel of the Cisco C896VAG-LTE ISR.

Figure 1-54 Front Panel of the Cisco C896VAG-LTE ISR

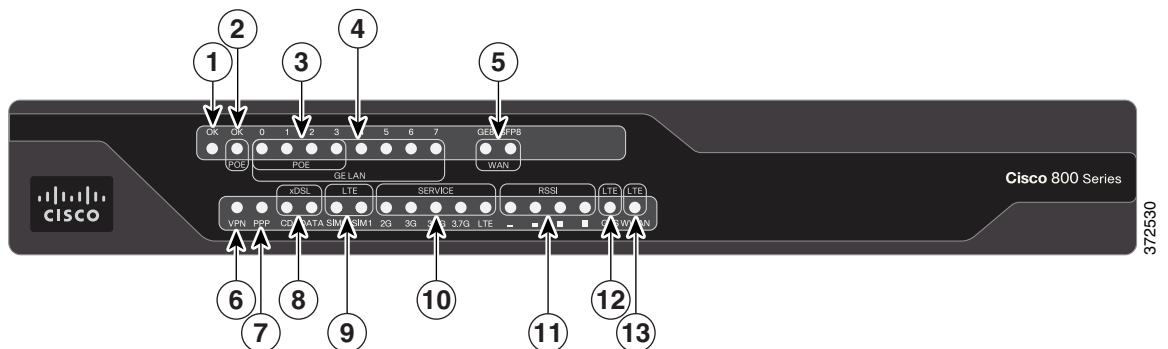

Table 1-37 describes the LEDs for Cisco C896VAG-LTE ISR.

**Table 1-37 LED Descriptions for Cisco C896VAG-LTE ISR**

Number	LED	Color	Description
1	Power OK	Green	On—DC power is being supplied to the router and the Cisco IOS software is running. Blinking—Boot up is in process, or the router is in ROMMON mode Off—Power is not supplied to the router.
2	PoE	Green	On—PoE is connected and powered. Off—PoE is not installed.
		Amber	On—Fault with the PoE.
3	GE LAN PoE Ports	Green/Amber	Green On—Ethernet port is connected. Amber On—Fault with PoE. There is a fault with the in-line power supply. Green/Amber Blinking—Data is either being received or being transmitted. Green/Amber Off—Ethernet port is not connected.
4	GE LAN Ports	Green	On—Ethernet port is connected. Blinking—Data is either being received or being transmitted. Off—Ethernet port is not connected.
5	GE WAN Ports	Green	On—Port is connected. Blinking—Data is either being received or transmitted. Off—Port is not connected.
	SFP WAN port	Green	On—Port is connected. Blinking—Data is either being received or transmitted. Off—No link
6	VPN	Green	On—VPN is connected.
7	PPP	Green	On—At least one PPP session is established.
8	xDSL CD	Green	On—The xDSL interface is connected to the DSLAM. Blinking—Training the line. Off—Indicates that a connection has not been established or the port is shut down.
	xDSL Data	Green	Blinking—The xDSL interface is either receiving or transmitting data. Off—No data is being transmitted or received.

Table 1-37 LED Descriptions (continued) for Cisco C896VAG-LTE ISR

Number	LED	Color	Description
9	SIM	Green / Yellow (one green blink followed by two yellow blinks)	SIM in slot 0 is active, SIM in slot 1 is not.
		Yellow / Green (one yellow blink followed by two green blinks)	SIM in slot 1 is active, SIM in slot 0 is not.
		Off / Green (two green blinks and then a pause)	No SIM in slot 0, SIM is present in slot 1.
		Green / Off (slow green blink once and then a pause)	SIM is present in slot0, no SIM in slot 1.
		Off / Off	No SIM present in either slots.
10	Service	Green (Solid)	Service is active and the corresponding LED is lit based on the service level that is active (2G, 3G, 3.5G, 3.7G, LTE).
		Off	No service.
11	RSSI	Green (solid)	Signal strength bars are indicated by the corresponding LEDs.
12	GPS	Green (solid)	Standalone GPS.
		Green (slow blinking)	GPS is acquiring signals.
		Yellow (solid)	Assisted GPS.
		Yellow (slow blinking)	Assisted GPS is acquiring signals.
		Off	GPS is not configured.

Table 1-37 LED Descriptions (continued) for Cisco C896VAG-LTE ISR

Number	LED	Color	Description
13	WWAN	Green	Module is powered on and connected but not transmitting or receiving.
		Green (slow blinking)	Module is powered on and searching for connection.
		Green (fast blinking)	Module is transmitting or receiving.
		Off	Module is not powered.

Figure 1-55 shows the back panel of the Cisco C896VAG-LTE ISR.

Figure 1-55 Back Panel of the Cisco C896VAG-LTE ISR

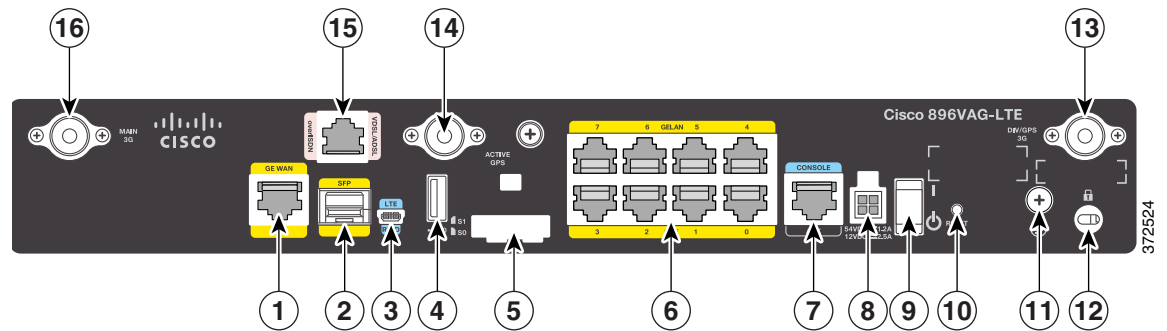

1	GE WAN interface	9	On/Off switch
2	SFP port	10	Reset button
3	4G port	11	Earth ground connection
4	USB port	12	Kensington security slot
5	SIM slots	13	4G antenna connector—M1/DIV
6	8-port Gigabit Ethernet switch	14	Active GPS antenna connector
7	Console / Auxiliary port	15	VDSL or ADSL over ISDN
8	Power connector	16	4G antenna connector—M0/MAIN

For information on installing Cisco C890 Series Routers, see the following link:

<http://www.cisco.com/c/en/us/td/docs/routers/access/800/hardware/installation/guide/800HIG.html>

## Cisco C897VAG-LTE Integrated Service Router

Figure 1-56 shows the front panel of the Cisco C897VAG-LTE ISR.

**Figure 1-56** Front Panel of the Cisco C897VAG-LTE ISR

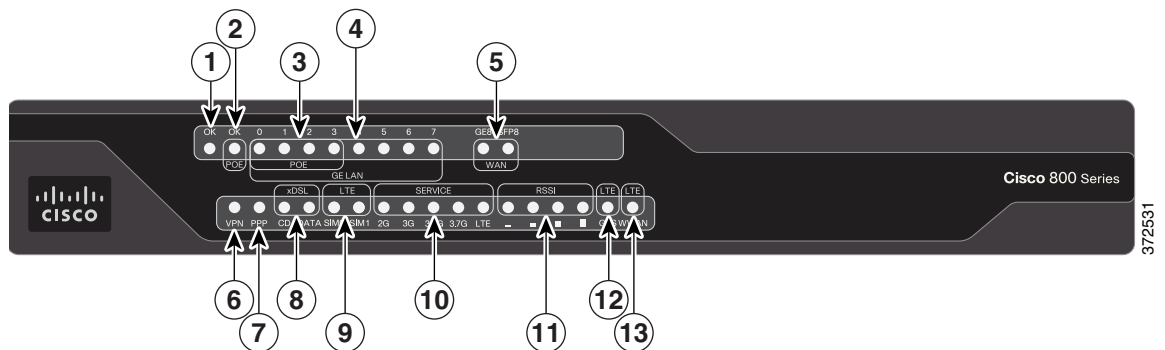

Table 1-38 describes the LEDs for the Cisco C897VAG-LTE ISR.

**Table 1-38 LED Descriptions for the Cisco C897VAG-LTE ISR**

Number	LED	Color	Description
1	Power OK	Green	On—DC power is being supplied to the router and the Cisco IOS software is running. Blinking—Boot up is in process, or the router is in ROMMON mode. Off—Power is not supplied to the router.
2	PoE	Green	On—PoE is connected and powered. Off—PoE is not installed.
		Amber	On—Fault with the PoE.
3	GE LAN PoE Ports	Green/Amber	Green On—Ethernet port is connected. Amber On—Fault with PoE. There is a fault with the in-line power supply. Green/Amber Blinking—Data is either being received or being transmitted. Green/Amber Off—Ethernet port is not connected.
4	GE LAN Ports	Green	On—Ethernet port is connected. Blinking—Data is either being received or transmitted. Off—Ethernet port is not connected.
5	GE WAN Ports	Green	On—Port is connected. Blinking—Data is either being received or transmitted. Off—Port is not connected.
	SFP WAN port	Green	On—Port is connected. Blinking—Data is either being received or transmitted. Off—No link
6	VPN	Green	On—VPN is connected.
7	PPP	Green	On—At least one PPP session is established.
8	xDSL CD	Green	On—The xDSL interface is connected to the DSLAM. Blinking—Training the line. Off—Indicates that a connection has not been established or the port is shut down.
	xDSL Data	Green	Blinking—The xDSL interface is either receiving or transmitting data. Off—No data is being transmitted or being received.

**Table 1-38 LED Descriptions (continued) for the Cisco C897VAG-LTE ISR**

Number	LED	Color	Description
9	SIM	Green / Yellow (one green blink followed by two yellow blinks)	SIM in slot 0 is active, SIM in slot 1 is not.
		Yellow / Green (one yellow blink followed by two green blinks)	SIM in slot 1 is active, SIM in slot 0 is not.
		Off / Green (two green blinks and then a pause)	No SIM in slot 0, SIM is present in slot 1.
		Green / Off (slow green blink once and then a pause)	SIM is present in slot0, no SIM in slot 1.
		Off / Off	No SIM present in either slots.
10	Service	Green (solid)	Service is active and the corresponding LED is lit based on the service level that is active (2G, 3G, 3.5G, 3.7G, LTE).
		Off	No service.
11	RSSI	Green (solid)	Signal strength bars are indicated by the corresponding LEDs.
12	GPS	Green (solid)	Standalone GPS.
		Green (slow blinking)	GPS is acquiring signals.
		Yellow (solid)	Assisted GPS.
		Yellow (slow blinking)	Assisted GPS is acquiring signals.
		Off	GPS is not configured.



**Table 1-38 LED Descriptions (continued) for the Cisco C897VAG-LTE ISR**

Number	LED	Color	Description
13	WWAN	Green	Module is powered on and connected, but not transmitting or receiving.
		Green (slow blinking)	Module is powered on and searching for connection.
		Green (fast blinking)	Module is transmitting or receiving.
		Off	Module is not powered.

Figure 1-57 shows the back panel of the Cisco C897VAG-LTE ISR.

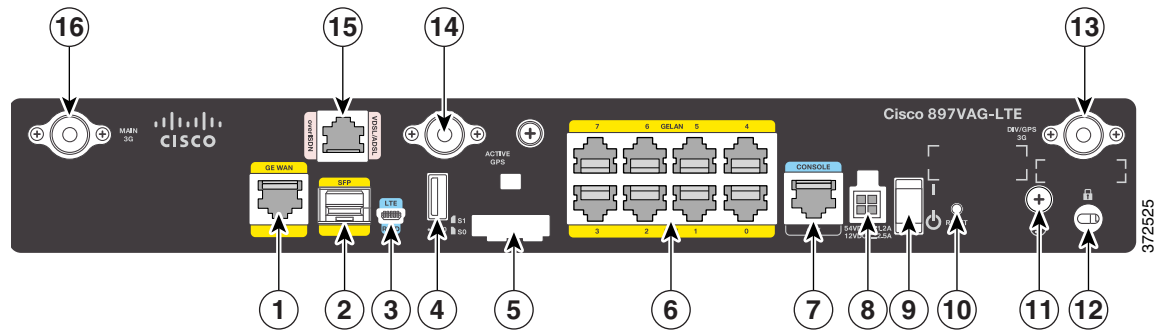
**Figure 1-57 Back Panel of the Cisco C897VAG-LTE ISR**

1	GE WAN interface	9	On/Off switch
2	SFP port	10	Reset button
3	4G port	11	Earth ground connection
4	USB port	12	Kensington security slot
5	SIM slots	13	4G antenna connector—M1/DIV
6	8-port Gigabit Ethernet switch	14	Active GPS antenna connector
7	Console/Auxiliary port	15	VDSL or ADSL over POTS
8	Power connector	16	4G antenna connector—M0/MAIN

## Cisco C898EAG-LTE Integrated Service Router

Figure 1-58 shows the front panel of the Cisco C898EAG-LTE ISR.

**Figure 1-58 Front Panel of the Cisco C898EAG-LTE ISR**

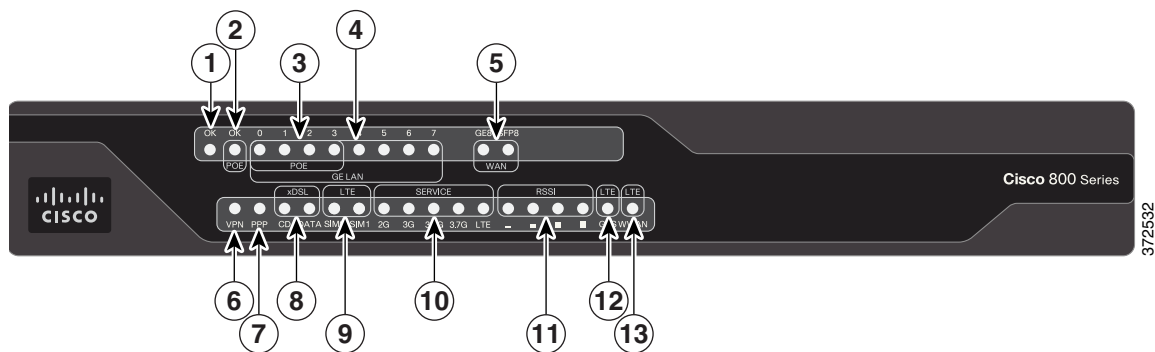

Table 1-39 describes the LEDs for the Cisco C898EAG-LTE ISR.

**Table 1-39 LED Descriptions for the Cisco C898EAG-LTE ISR**

Number	LED	Color	Description
1	Power OK	Green	On—DC power is being supplied to the router and the Cisco IOS software is running. Blinking—Boot up is in process, or the router is in ROMMON mode. Off—Power is not supplied to the router.
2	PoE	Green	On—PoE is connected and powered. Off—PoE is not installed.
		Amber	On—Fault with the PoE.
3	GE LAN PoE Ports	Green/Amber	Amber On—Ethernet port is connected. Amber On—Fault with PoE. There is a fault with the in-line power supply. Green/Amber Blinking—Data is either being received or transmitted. Green/Amber Off—Ethernet port is not connected.
4	GE LAN Ports	Green	On—Ethernet port is connected. Blinking—Data is either being received or transmitted. Off—Ethernet port is not connected.
5	GE WAN Ports	Green	On—Port is connected. Blinking—Data is either being received or being transmitted. Off—Port is not connected.
	SFP WAN port	Green	On—Port is connected. Blinking—Data is either being received or transmitted. Off—No link
6	VPN	Green	On—VPN is connected.

Table 1-39 LED Descriptions (continued) for the Cisco C898EAG-LTE ISR

Number	LED	Color	Description
7	PPP	Green	On—At least one PPP session is established.
8	xDSL CD	Green	On—The xDSL interface is connected to the DSLAM40. Blinking—Training the line. Off—Indicates that a connection has not been established or the port is shut down.
	xDSL Data	Green	Blinking—The xDSL interface is either receiving or transmitting data. Off—No data is being transmitted or being received.
	xDSL EFM	Green	Blink—The router is operating in EFM mode. Off—Not operating in EFM mode.
9	SIM	Green / Yellow (one green blink followed by two yellow blinks)	SIM in slot 0 is active, SIM in slot 1 is not.
		Yellow / Green (one yellow blink followed by two green blinks)	SIM in slot 1 is active, SIM in slot 0 is not.
		Off / Green (two green blinks and then a pause)	No SIM in slot 0, SIM present in slot 1.
		Green / Off (slow green blink once and then a pause)	SIM is present in slot0, no SIM in slot 1.
		Off / Off	No SIM present in either slot.
10	Service	Green (Solid)	Service is active and the corresponding LED is lit based on the service level which is active (2G, 3G, 3.5G, 3.7 G, LTE).
		Off	No service.
11	RSSI	Green (solid)	Signal strength bars are indicated by the corresponding LEDs.

**Table 1-39 LED Descriptions (continued) for the Cisco C898EAG-LTE ISR**

Number	LED	Color	Description
12	GPS	Green (solid)	Standalone GPS
		Green (slow blinking)	GPS is acquiring signals.
		Yellow (solid)	Assisted GPS.
		Yellow (slow blinking)	Assisted GPS is acquiring signals.
		Off	GPS is not configured.
13	WWAN	Green	Module is powered on and connected, but not transmitting or receiving.
		Green (slow blinking)	Module is powered on and searching for connection.
		Green (fast blinking)	Module is transmitting or receiving.
		Off	Module is not powered.

Figure 1-59 shows the back panel of the Cisco C898EAG-LTE ISR.

Figure 1-59 Back Panel of the Cisco C898EAG-LTE ISR

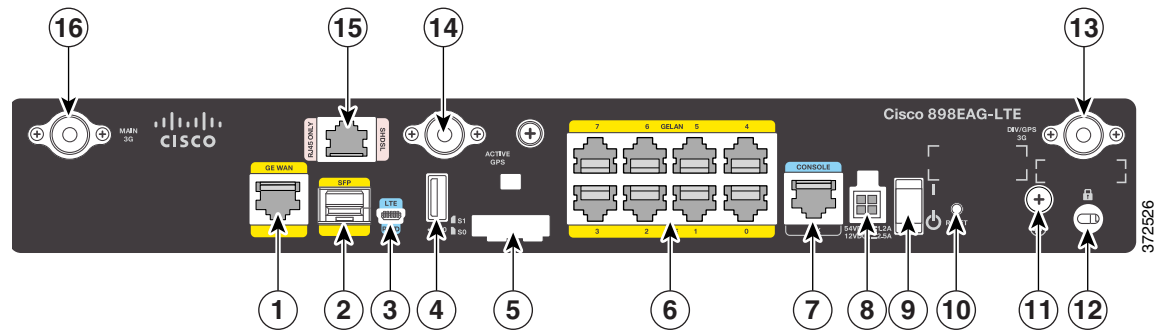

1	GE WAN interface	9	On/Off switch
2	SFP port	10	Reset button
3	4G port	11	Earth ground connection
4	USB port	12	Kensington security slot
5	SIM slots	13	4G antenna connector—M1/DIV
6	8-port Gigabit Ethernet switch	14	Active GPS antenna connector
7	Console/Auxiliary port	15	G.SHDSL over POTS
8	Power connector	16	4G antenna connector—M0/MAIN

## Cisco C899G-LTE Integrated Service Router

Figure 1-60 shows the front panel of the Cisco C899G-LTE ISR.

Figure 1-60 Front Panel of the Cisco C899G-LTE ISR

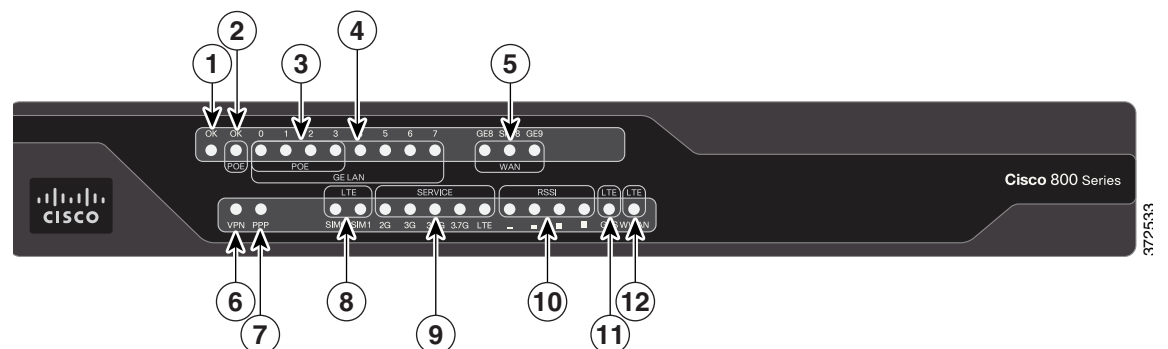

Table 1-40 describes the LEDs for the Cisco C899G-LTE ISR.

**Table 1-40 LED Descriptions for the Cisco C899G-LTE ISR**

Number	LED	Color	Description
1	Power OK	Green	On—DC power is being supplied to the router and the Cisco IOS software is running. Blinking—Boot up is in process, or the router is in ROMMON mode. Off—Power is not supplied to the router.
2	PoE	Green	On—PoE is connected and powered. Off—PoE is not installed.
		Amber	On—Fault with the PoE.
3	GE LAN PoE Ports	Green	Green On—Ethernet port is connected. Amber On—Fault with PoE. There is a fault with the in-line power supply. Green/Amber Blinking—Data is either being received or transmitted. Green/Amber Off—Ethernet port is not connected.
4	GE LAN Ports	Green	On—Ethernet port is connected. Blinking—Data is either being received or being transmitted. Off—Ethernet port is not connected.
5	GE WAN Ports	Green	On—Port is connected. Blinking—Data is either being received or transmitted. Off—Port is not connected.
	SFP WAN port	Green	On—Port is connected. Blinking—Data is either being received or being transmitted. Off—No link
6	VPN	Green	On—VPN is connected.
7	PPP	Green	On—At least one PPP session is established.

Table 1-40 LED Descriptions for the Cisco C899G-LTE ISR (continued)

Number	LED	Color	Description
8	SIM	Green / Yellow (one green blink followed by two yellow blinks)	SIM in slot 0 is active, SIM in slot 1 is not.
		Yellow / Green (one yellow blink followed by two green blinks)	SIM in slot 1 is active, SIM in slot 0 is not.
		Off / Green (two green blinks and then a pause)	No SIM in slot 0, SIM present in slot 1.
		Green / Off (slow green blink once and then a pause)	SIM is present in slot0, no SIM in slot 1.
		Off / Off	No SIM present in either slots.
9	Service	Green (Solid)	Service is active and the corresponding LED is lit based on the service level which is active (2G, 3G, 3.5G, 3.7G, LTE).
		Off	No service.
10	RSSI	Green (solid)	Signal strength bars are indicated by the corresponding LEDs.
11	GPS	Green (solid)	Standalone GPS.
		Green (slow blinking)	GPS is acquiring signals.
		Yellow (solid)	Assisted GPS.
		Yellow (slow blinking)	Assisted GPS is acquiring signals.
		Off	GPS is not configured.
12	WWAN	Green	Module is powered on and connected, but not transmitting or receiving.
		Green (slow blinking)	Module is powered on and searching for connection.
		Green (fast blinking)	Module is transmitting or receiving.
		Off	Module is not powered.

Figure 1-61 shows the back panel of the Cisco C899G-LTE ISR.

*Figure 1-61 Back Panel of the Cisco C899G-LTE ISR*



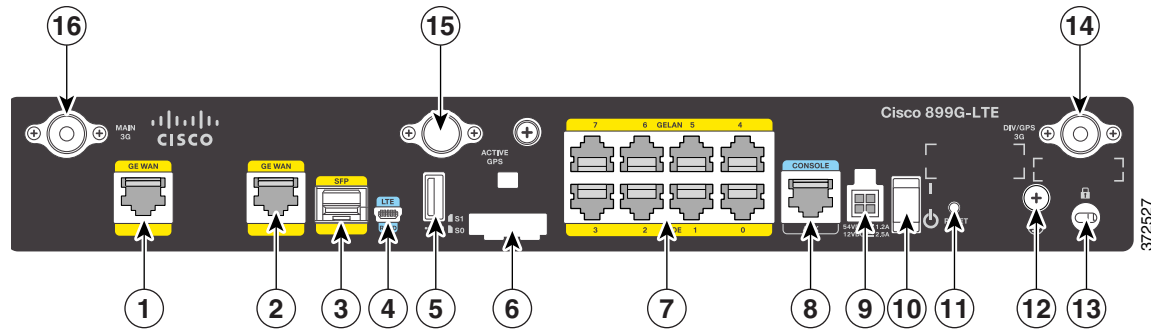

1	GE WAN interface	9	Power connector
2	GE WAN interface	10	On/Off switch
3	SFP port	11	Reset button
4	4G port	12	Earth ground connection
5	USB port	13	Kensington security slot
6	SIM slots	14	4G antenna connector—M1/DIV
7	8-port Gigabit Ethernet switch	15	Active GPS antenna connector
8	Console/Auxiliary port	16	4G antenna connector—M0/MAIN

## Cisco 890 Series Integrated Service Routers

This section contains the following topics:

- [Cisco 891, Cisco 892, and Cisco 892F, page 1-114](#)
- [Cisco C897VAB-K9, page 1-124](#)

### Cisco 891, Cisco 892, and Cisco 892F

The Cisco 891, Cisco 892, and Cisco 892F ISRs have the following features:

- Integrated 8-port 10/100 Ethernet switch for connecting to the LAN
- 10/100 FE and 10/100/1000 Gigabit Ethernet (GE) port for connecting to the WAN
- Separate console and auxiliary ports
- (Optional) embedded Wi-Fi certified dual-radio 802.11a/b/g/n-compliant wireless AP
- Optional 4-port PoE



---

**Note** The Cisco 890 Series ISRs can include an optional PoE module that provides power to 802.3af-compliant devices connected to Ethernet ports 0 through 3. If this feature was not configured with the factory order, you must order and install it to enable the PoE function.

---



---

**Note** On a Cisco 891 series router, due to TCAM limitation, you can apply an ACL configuration on maximum 9 ports. If you apply the ACL configuration beyond 9 ports, the configuration will not be applied, and the router will display an error message.

---



---

**Note** Layer 2 FastEthernet ports of Cisco 800 series routers do not support Downloadable ACL(dACL). Layer 2 GigabitEthernet ports support downloadable ACL(dACL).

---

- Security feature card (SFC) socket
- DIMM expansion socket that can accept up to 512 MB of additional memory, for a total of 768 MB system memory in Cisco 891 and Cisco 892 ISRs, and a total of 1 GB system memory in Cisco 892F series ISRs
- Three reverse-polarity Threaded Neill-Concelman (RP-TNC) connectors on the back panel for non-captive dual-band WLAN antenna (wireless models only)
- Support for the AIM2-CUE-K9 and AIM2-APPRE-104-K9
- GE small-form-factor pluggable (SFP) port (Cisco 892F series ISRs only)

The following feature is located on the front panel of

- Two USB 2.0 ports

Figure 1-62 shows the front panel details of the Cisco 890 Series router.

Figure 1-62 Front Panel of the Cisco 890 Series ISR

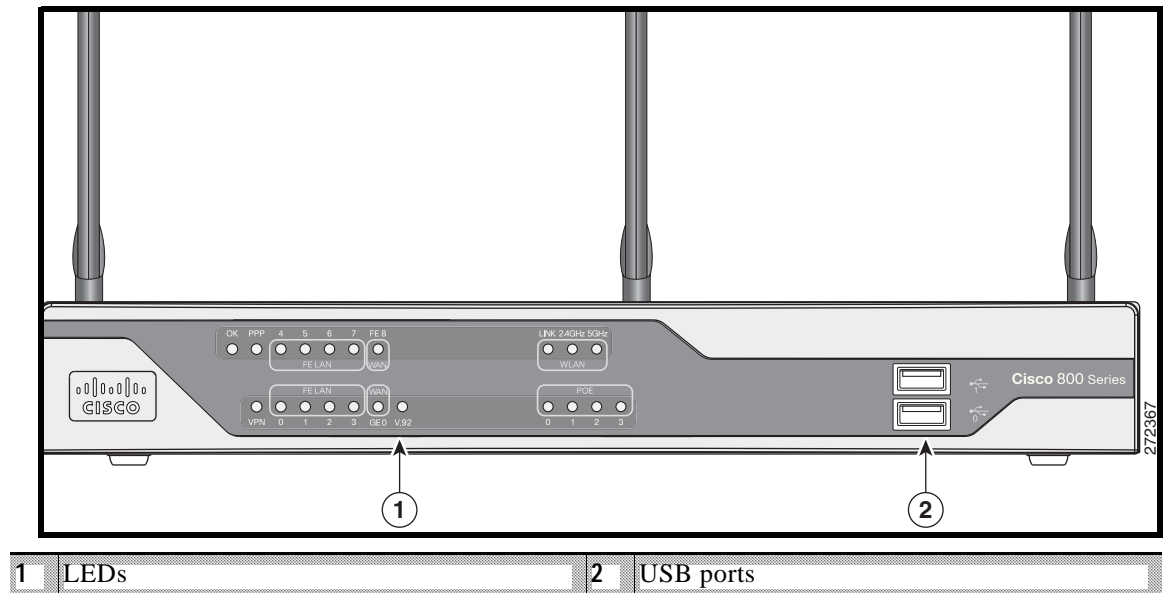

1 LEDs	2 USB ports
--------	-------------

Figure 1-63 shows the back panel details of the Cisco 892W router. Non wireless routers do not have RP-TNC antennas or connectors on the back panel. Some of the features that are shown may not be available on your router. However, the feature locations are similar across all Cisco 890 series routers.

Figure 1-63 Back Panel of the Cisco 892W Router

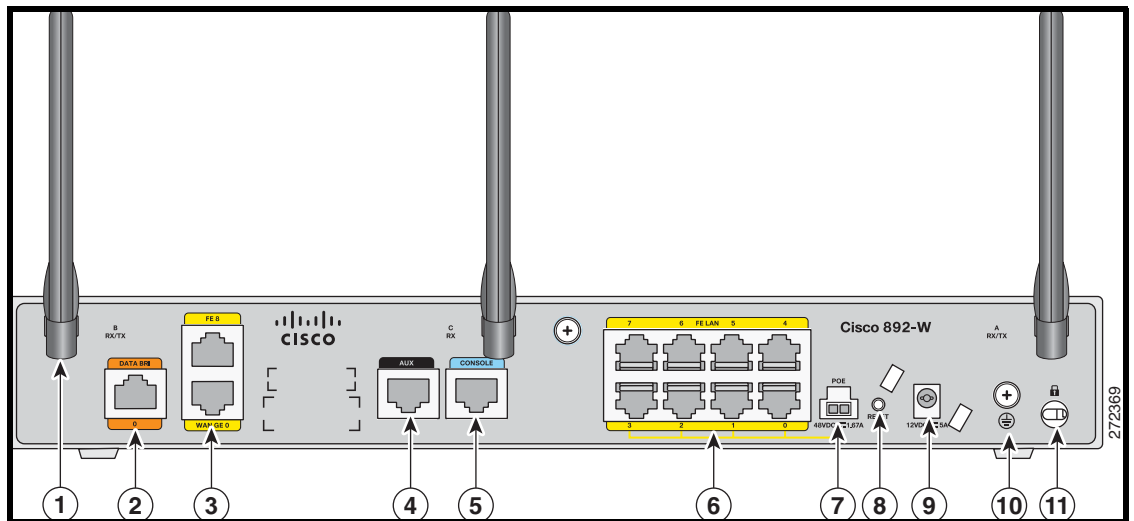

1 Antenna—Dipole swivel antenna attached to RP-TNC connectors (wireless models only)	7 PoE power connector for optional PoE module <sup>1</sup>
2 Backup—Data BRI <sup>2</sup> or V.92 <sup>3</sup> port	8 Reset button
3 Primary WAN port—FE and GE	9 Power connector

4	Auxiliary port	10	Earth ground connection
5	Console port	11	Kensington security slot
6	8-port 10/100 Ethernet switch		

1. The Cisco 890 Series ISRs can include an optional PoE module that provides power to 802.3af-compliant devices connected to Ethernet ports 0 through 3. If this feature was not configured with the factory order you must order and install it to enable the PoE function.
2. The Data BRI port is available only on the Cisco 892 Router models.
3. The V.92 port (not shown) is available only on the Cisco 891 Router models and is located between the console port and the Ethernet switch.

Figure 1-64 shows the location of the SFP port on a Cisco 892FW router.

Figure 1-64 SFP Port Location on a Cisco 892FW Router

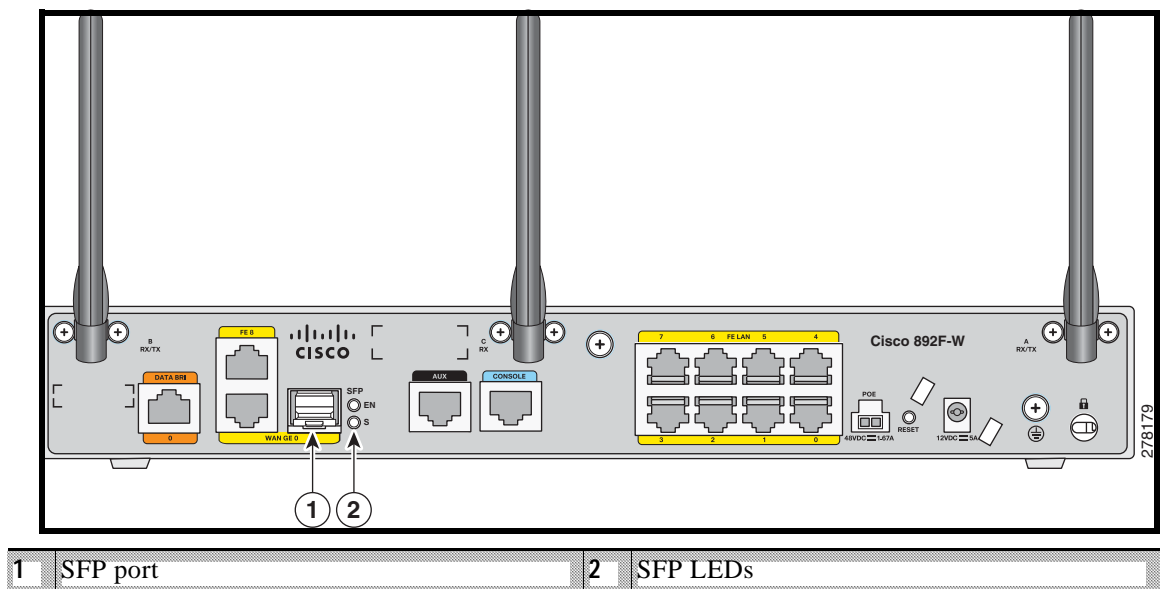

### Cisco 892FSP, Cisco 896VA, Cisco 897VA, and Cisco 898EA

The Cisco 892FSP, Cisco 896VA, Cisco 897VA (includes Cisco 897VA, Cisco 897VAM, Cisco 897VAW, Cisco 897VAMW), and Cisco 898EA routers have the following features:

- Integrated 8-port 10/100/1000 Gigabit Ethernet switch for connecting to the LAN
- Two 10/100/1000 GE ports for Cisco 892FSP
- One 10/100/1000 GE port for Cisco 896VA, 897VA, and the Cisco 898EA. Either the SFP socket or the 10/100/1000 GE port can be active at a given time, but not both.
- Single console and auxiliary ports for configuration and management
- 512 MB of on-board memory (upgrade option to 1 GB)
- 256 MB flash memory for Cisco 896VA, Cisco 897VA, and Cisco 898EA
- One USB 2.0 port
- Optional internal adapter for inline PoE on four switch ports for IP phones or external wireless access points for Cisco 896VA, Cisco 897VA, and Cisco 898EA models only. No PoE support on Cisco 892FSP.

**Note**

---

The Cisco 892FSP does not support AIM2-CUE-K9 and AIM2-APPRE-104-K9 because it does not have an SFC socket.

---

**Note**

---

To upgrade DRAM memory from 512 MB to 1 GB on the Cisco 892FSP, Cisco 896VA, Cisco 897VA, and Cisco 898EA routers, you should enable the FL-8XX-512U1GB license.

---

Figure 1-65 shows the back panel of the Cisco 892FSP Router.

Figure 1-65 Back Panel of the Cisco 892FSP Router

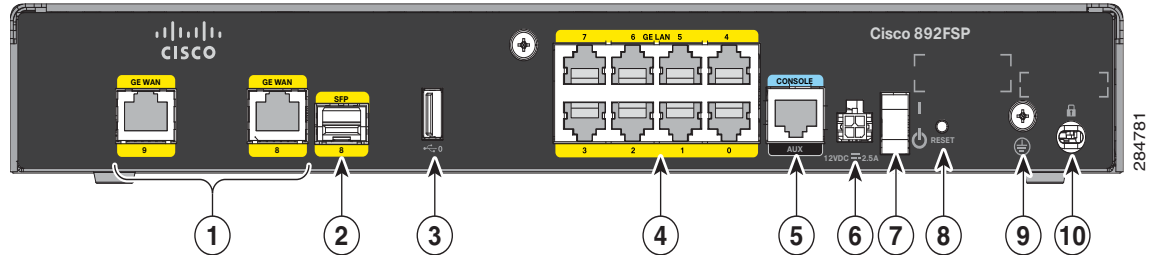

1	GE WAN interface	6	Power connector
2	SFP port	7	On/Off switch
3	USB port	8	Reset button
4	8-port Gigabit Ethernet switch	9	Earth ground connection
5	Console/Auxiliary port	10	Kensington security slot

Figure 1-66 shows the front panel of the Cisco 892FSP Router.

Figure 1-66 Front Panel of the Cisco 892FSP Router

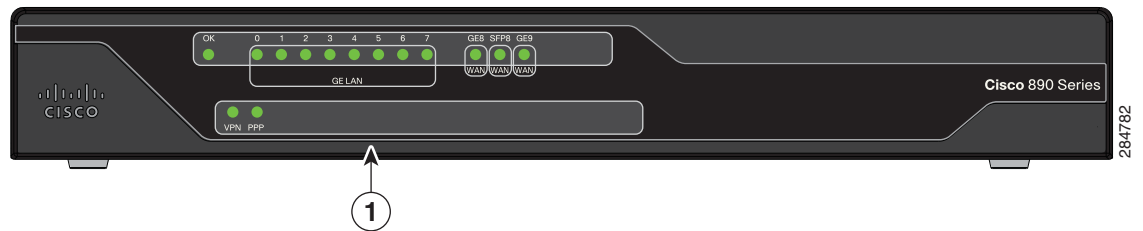

1	LEDs
---	------

Figure 1-67 shows the back panel of the Cisco 896VA Router.

Figure 1-67 Back Panel of the Cisco 896VA Router

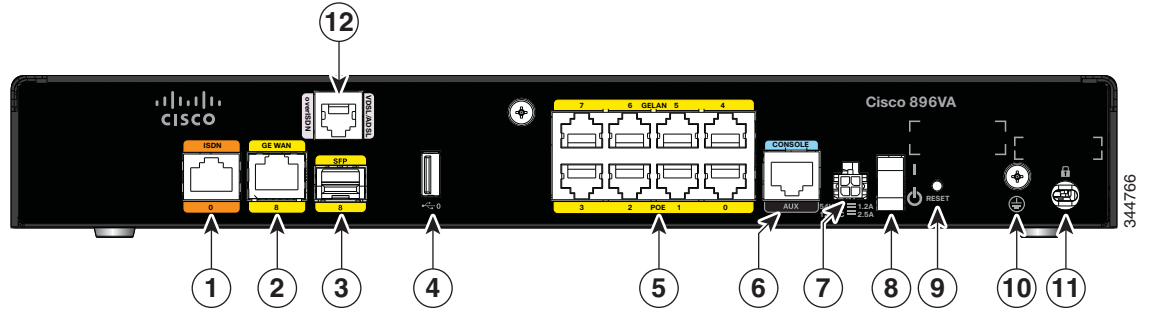

1	ISDN	7	Power connector
2	GE WAN interface	8	On/Off switch
3	SFP port	9	Reset button
4	USB port	10	Earth ground connection
5	8-port Gigabit Ethernet switch <sup>1</sup>	11	Kensington security slot
6	Console/Auxiliary port	12	VDSL / ADSL over ISDN

1. Ports 0 through 3 can be configured as POE, which is an optional feature for this model. If this feature is not configured with the factory order, you must order and install it to enable the PoE function.

Figure 1-68 shows the front panel of the Cisco 896VA and the Cisco 897VA routers.

Figure 1-68 Front Panel of the Cisco 896VA and Cisco 897VA Routers



1	LEDs
---	------

Figure 1-69 shows the back panel of the Cisco 897VA Router.

Figure 1-69 Back Panel of the Cisco 897VA Router

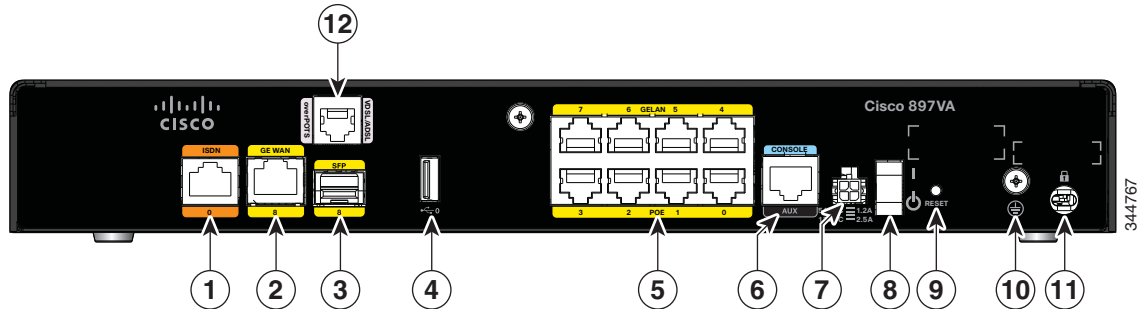

1	ISDN	7	Power connector
2	GE WAN interface	8	On/Off switch
3	SFP port	9	Reset button
4	USB port	10	Earth ground connection
5	8-port Gigabit Ethernet switch <sup>1</sup>	11	Kensington security slot
6	Console/Auxiliary port	12	VDSL/ADSL over POTS

1. Port 0 through 3 can be configured as POE. POE is an optional feature for this model. If this feature was not configured with the factory order, you must order and install it to enable the PoE function.

Figure 1-70 shows the back panel of the Cisco 897VAM Router.

Figure 1-70 Back Panel of the Cisco 897VAM Router

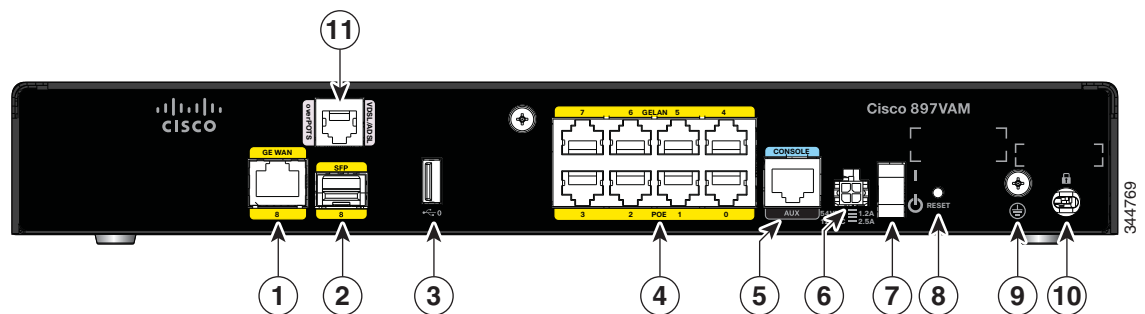

1	GE WAN interface	7	On/Off switch
2	SFP port	8	Reset button
3	USB port	9	Earth ground connection



4	8-port Gigabit Ethernet switch <sup>1</sup>	10	Kensington security slot
5	Console / Auxiliary port	11	VDSL / ADSL over POTS
6	Power connector		

1. Ports 0 through 3 can be configured as POE, which is an optional feature for this model. If this feature was not configured with the factory order, you must order and install it to enable the PoE function.

Figure 1-71 shows the front panel of the Cisco 897VAM router.

Figure 1-71 Front Panel of the Cisco 897VAM Router



1	LEDs
---	------

Figure 1-72 shows the back panel of the Cisco 897VAW router.

Figure 1-72 Back Panel of the Cisco 897VAW Router

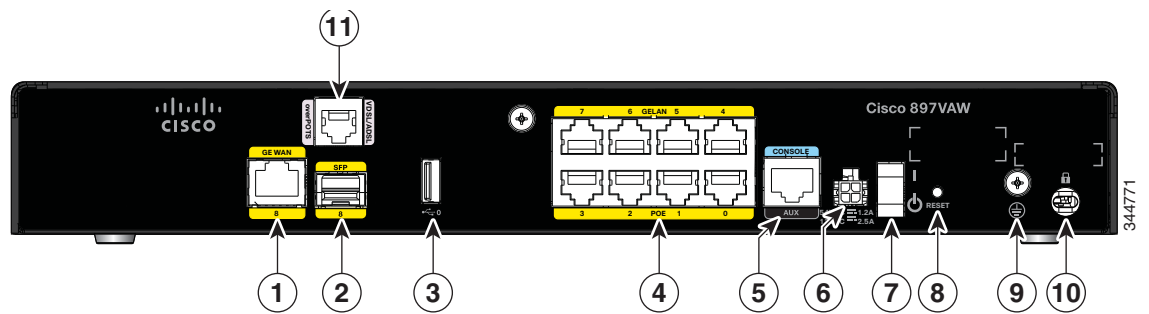

1	GE WAN interface	7	On/Off switch
2	SFP port	8	Reset button
3	USB port	9	Earth ground connection
4	8-port Gigabit Ethernet switch <sup>1</sup>	10	Kensington security slot
5	Console / Auxiliary port	11	VDSL / ADSL over POTS
6	Power connector		

1. Port 0 through 3 can be configured as POE. POE is an optional feature for this model. If this feature was not configured with the factory order, you must order and install it to enable the PoE function.

Figure 1-73 shows the front panel of the Cisco 897VAW and the Cisco 897VAMW routers.

Figure 1-73 Front Panel of the Cisco 897VAW and the Cisco 897VAMW Routers

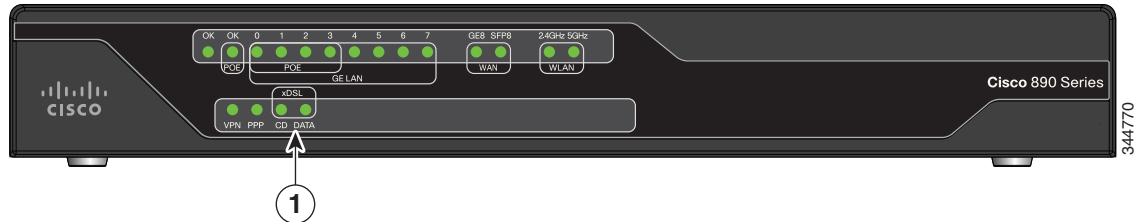

1	LEDs
---	------

Figure 1-74 shows the back panel of the Cisco 897VAMW Router.

Figure 1-74 Back Panel of the Cisco 897VAMW Router

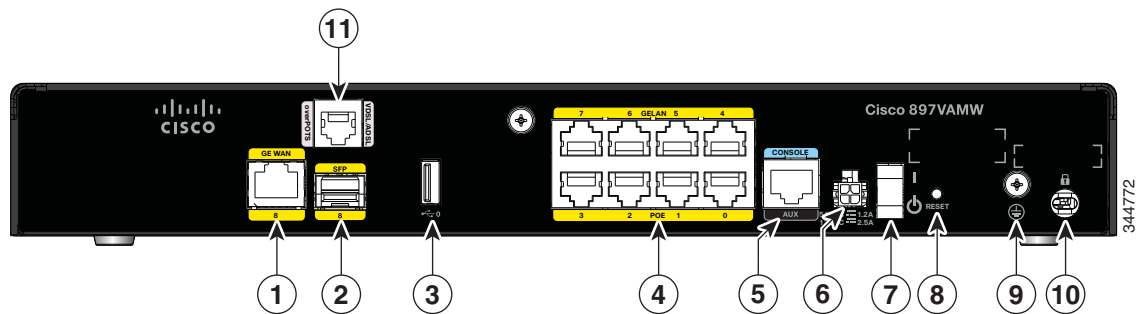

1	GE WAN interface	7	On/Off switch
2	SFP port	8	Reset button
3	USB port	9	Earth ground connection
4	8-port Gigabit Ethernet switch <sup>1</sup>	10	Kensington security slot
5	Console/Auxiliary port	11	VDSL / ADSL over POTS
6	Power connector		

1. Port 0 through 3 can be configured as POE. POE is an optional feature for this model. If this feature was not configured with the factory order, you must order and install it to enable the PoE function.

Figure 1-75 shows the back panel of the Cisco 898EA router.

Figure 1-75 Back Panel of the Cisco 898EA Router

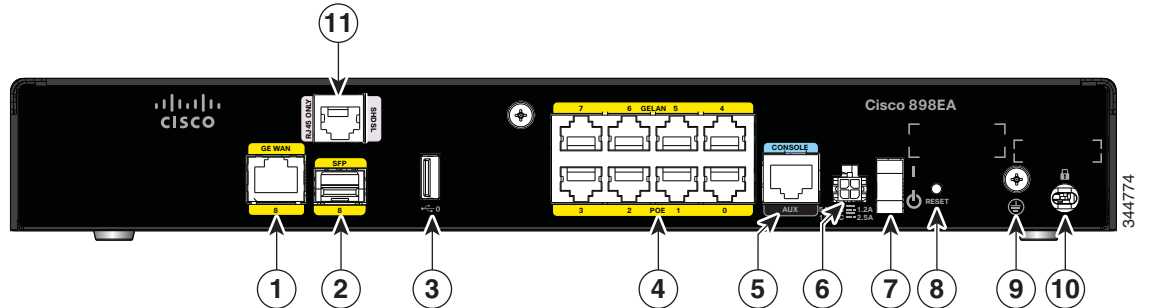

1	GE WAN interface	7	On/Off switch
2	SFP port	8	Reset button
3	USB port	9	Earth ground connection
4	8-port Gigabit Ethernet switch <sup>1</sup>	10	Kensington security slot
5	Console/Auxiliary port	11	SHDSL (RJ45 only)
6	Power connector		

- Ports 0 through 3 can be configured as POE, which is an optional feature for this model. If this feature is not configured with the factory order, you must order and install it to enable the PoE function.

**Caution**  The primary WAN port is designed for an RJ-45 connector only. Damage to the primary WAN port may occur if a non-RJ-45 connector is inserted.

Figure 1-76 shows the front panel of the Cisco 898EA Router.

Figure 1-76 Front Panel of the Cisco 898EA Router

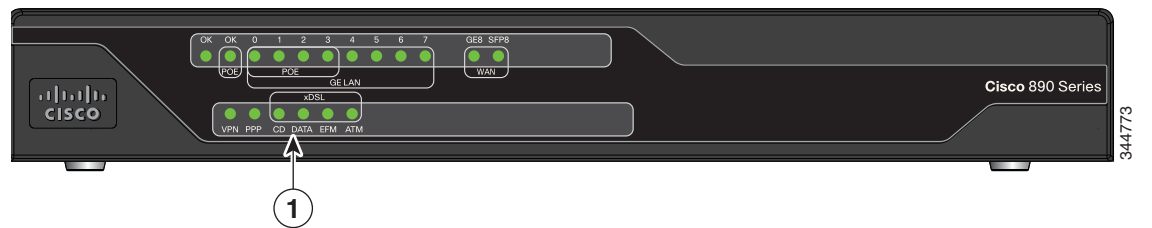

1	LEDs
---	------

## Cisco C897VAB-K9

The Cisco 897VAB-K9 ISR is designed to support 2-pair VDSL2 bonding up to the 17a profile and single pair support for ADSL/VDSL over POTS up to the 30a profile.

Table 1-41 provides information about important hardware specifications pertaining to Cisco C897VAB-K9 ISR.

**Table 1-41 Hardware Specifications of Cisco C897VAB-K9 ISR**

Hardware	Description
Flash Memory	256 MB
Main Memory	1-GB DDR RAM; fixed and not extendable
USB port	A USB 2.0-compliant port located on the back panel
FAN	Fanless chassis
PoE	(Optional) Four internal PoE ports
Primary WAN	VDSL/ADSL over POTS
Backup WAN	10/100/1000 GE port (RJ-45/SFP)
Console or auxiliary port	RJ-45
LAN switch	8-port 10/100/1000 GE Switch

Figure 1-77 shows the back panel of the Cisco 897VAB-K9 ISR.

**Figure 1-77 Back panel of the Cisco 897VAB-K9 ISR**

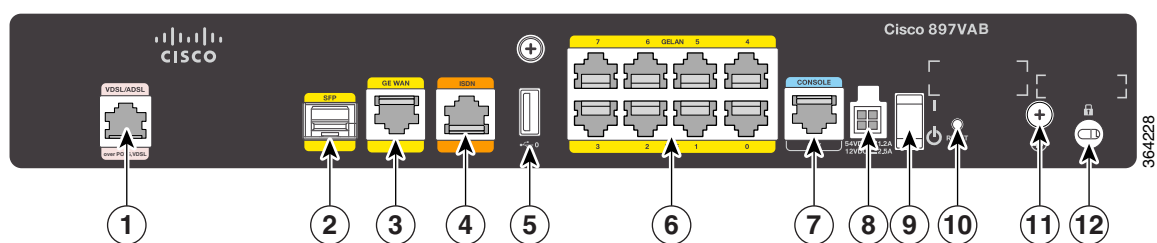

1	Primary WAN VDSL / ADSL over POTS, VDSL2 Bonding <sup>1</sup>	7	Console/Auxiliary Port
2	SFP port	8	Power Connector
3	GE WAN Interface	9	On/Off Switch
4	ISDN	10	Reset Button
5	USB Port	11	Earth Ground connection
6	8-port Gigabit Ethernet Switch <sup>2</sup>	12	Kensington Security slot

1. ADSL and VDSL (up to 17a) single-pair functionality uses the center pair of pins in the RJ-11 connector. VDSL 30a single pair functionality makes use of the pins just adjacent to the center pins. VDSL Bonding makes use of both the center pair pins & those just adjacent to the center pair to provide the 2 bonded VDSL lines. For more information, see [Cisco 890 Series Integrated Services Routers Data Sheet](#).
2. Ports 0 through 3 can be configured as POE, which is an optional feature for this model. If this feature is not configured with the factory order, you must order and install it to enable the PoE function.

**Caution**

The primary WAN port is designed for an RJ-11 or RJ-14 connector only. Damage to the primary WAN port may occur if a non-RJ-11 or RJ-14 connector is inserted.

Figure 1-78 shows the front panel of the Cisco 897VAB-K9 ISR.

**Figure 1-78** Front panel of the Cisco 897 VAB-K9 ISR

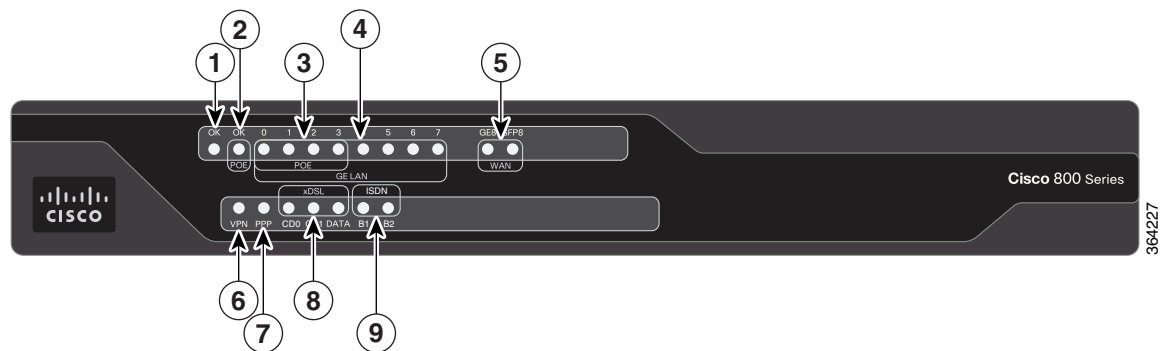

Table 1-42 describes the LEDs for the Cisco 897VAB-K9 ISR.

**Table 1-42** LED Descriptions for the Cisco 897VAB-K9 ISR

Number	LED	Color	Description
1	Power OK	Green	On—DC power is being supplied to the router and the Cisco IOS software is running. Blinking—Boot up is in process, or the router is in ROM Monitor (ROMMON) mode. Off—Power is not supplied to the router.
2	PoE OK	Green/Yellow	Off—Both POE card & POE power supply are not present. Yellow On—Either POE card or POE power supply is not present. Green On—Both POE card & POE power supply are present.

**Table 1-42 LED Descriptions for the Cisco 897VAB-K9 ISR (continued)**

Number	LED	Color	Description
3	GE LAN 0	Green/Yellow	Off—No link.
	GE LAN 1		Green On—Link.
	GE LAN 2		Yellow On—Fault with PoE. Implies no link.
	GE LAN 3		Green Blinking—Data is either being received or transmitted.
4	GE LAN 4	Green	Off—No link.
	GE LAN 5		On—Link.
	GE LAN 6		Blinking—Data is either being received or being transmitted.
	GE LAN 7		
5	GE WAN 8	Green	Off—No link. On—Link. Blinking—Data is either being received or being transmitted.
	SFP WAN 8		Off—No link. On—Link. Blinking—Data is either being received or being transmitted.
6	VPN	Green	Off—No tunnel. On—At least one tunnel is up.
7	PPP	Green	Off—No PPP session. On—At least one PPP session established.
8	xDSL CD0	Green	Off—Interface is shutdown.
	xDSL CD1		On—Showtime, Link up. Slow Blinking—Modem initialization. Fast Blinking—Training up the line. If both CD0 & CD1 are ON then VDSL Bonding is active.
	xDSL DATA	Green	Off—No Data. Blinking—Data is either being received or transmitted.
9	ISDN B1	Green	Blinking—Data is either being received or transmitted.
	ISDN B2		Off—No Data.

## Cisco C891 Series ISRs

Cisco C891 Series ISRs are designed to deliver secure broadband, metro Ethernet, wireless LAN (WLAN) connectivity, and business continuity. Cisco C891 Series ISRs also provide a 1-port Gigabit Ethernet SFP socket for WAN connectivity.

This section includes the hardware information for the following models:

- Cisco C891F
- Cisco C891FW

[Table 1-43](#) provides information about the hardware specifications of the Cisco C891 Series Routers.

**Table 1-43** Hardware Specifications of Cisco C891 Series ISR

Hardware	Description
Flash Memory	256 MB
Main Memory	1-GB DDR RAM; fixed and not extendable
USB port	A USB 2.0-compliant port located on the back panel
FAN	Fanless chassis
PoE	4 PoE ports
WAN	1-port GE or 1-port SFP
Data Backup	<ul style="list-style-type: none"> <li>• 1-port FE</li> <li>• 1-port ISDN</li> <li>• 1-port V.92</li> </ul>
Console or auxiliary port	RJ-45
LAN switch	8-port Gigabit Ethernet
Embedded Wireless AP	Dual 802.11b/g/n and 802.11a/n radios for C891FW

For detailed hardware specifications, see the Cisco C890 Series hardware data sheet at:

[http://www.cisco.com/en/US/prod/collateral/routers/ps380/data\\_sheet\\_c78-519930.html](http://www.cisco.com/en/US/prod/collateral/routers/ps380/data_sheet_c78-519930.html)

### Cisco C891F Router

[Figure 1-79](#) shows the front panel of the Cisco C891F Router.

**Figure 1-79** Front Panel of the Cisco C891F Router

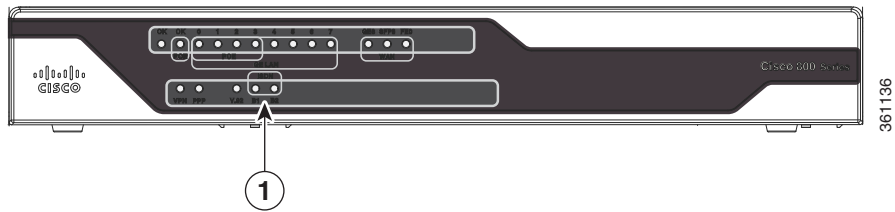

1	LEDs	
---	------	--

For detailed description about the LEDs on the Cisco C890 Series Routers, see the [“LEDs” section on page 1-30](#).



Figure 1-80 shows the back panel of the Cisco C891F Router.

Figure 1-80 Back Panel of the Cisco C891F Router

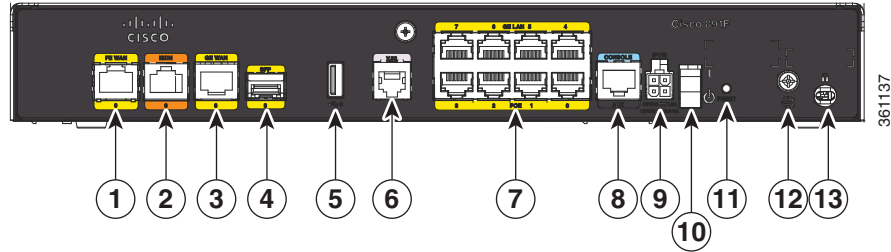

1	Back up WAN port—FE WAN	8	Console/Auxiliary port
2	ISDN	9	Power connector
3	Primary WAN port—GE WAN	10	On/Off switch
4	SFP	11	Reset button
5	USB port	12	Earth ground connection
6	V.92 backup	13	Kensington security slot
7	8-port 10/100/1000 Ethernet switch		

For information on installing the Cisco C890 Series Routers, see:

<http://www.cisco.com/en/US/docs/routers/access/800/860-880-890/hardware/installation/guide/2Instal1880-860.html>

## Cisco C891FW Router

Figure 1-81 shows the front panel of the Cisco C891FW Router.

Figure 1-81 Front Panel of the Cisco C891FW Router

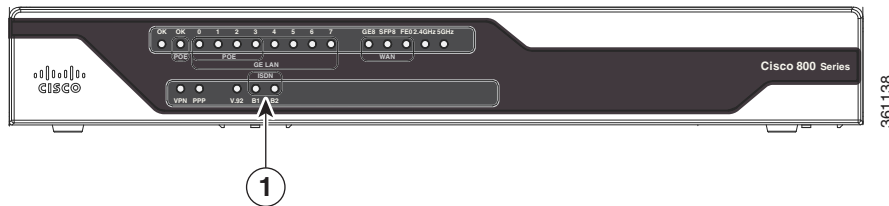

1	LEDs		
---	------	--	--

For detailed description about the LEDs on Cisco C890 Series Router, see “LEDs” section on page 1-30.

Figure 1-82 shows the back panel of the Cisco C891FW Router.

Figure 1-82 Back Panel of the Cisco C891FW Router

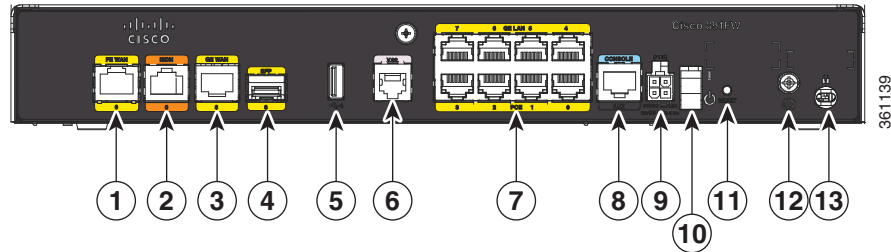

1	Back up WAN port—FE	8	Serial port—Console or auxiliary
2	ISDN	9	Power connector
3	Primary WAN port—GE	10	On/Off switch
4	SFP port	11	Reset button
5	USB port	12	Earth ground connection
6	V.92 backup port	13	Kensington security slot
7	8-port 10/100/1000 Ethernet switch		

For information on installing the Cisco C890 Series Routers, see:

<http://www.cisco.com/en/US/docs/routers/access/800/860-880-890/hardware/installation/guide/2Instal1880-860.html>

## Cisco C891-24X/K9 Integrated Services Router

Cisco C891-24X/K9 Integrated Services Router (ISR) is a fixed Cisco 890 Series ISR that supports 24 port GE LAN. Cisco C891-24X/K9 ISR provides more switch port options compared to other 890 Series ISRs and Cisco C891-24X/K9 ISR is useful in deployment scenarios where more switching capability is required. Cisco C891-24X/K9 ISR also supports PoE on 8 switch ports. Cisco C891-24X/K9 ISR supports WAN connectivity through dual GE or SFP ports.

Table 1-44 provides information about important hardware specifications pertaining to Cisco C891-24X/K9 ISR.

**Table 1-44** Hardware Specifications for Cisco C891-24X/K9 ISR

Hardware	Description
Flash Memory	256 MB Flash and 8 MB serial boot flash
Main Memory	1-GB DDR RAM
USB port	A USB 2.0-compliant port located at the back panel
PoE	8 PoE ports
WAN	2-port GE WAN (copper or SFP)
Console or auxiliary port	RJ-45
LAN switch	24-port 10/100/1000 BASE-T
Fan	Fan less Chassis

Figure 1-83 shows the front panel of the Cisco C891-24X/K9 ISR.

**Figure 1-83** Front Panel of the Cisco C891-24X/K9 ISR



Figure 1-84 shows the back panel of the Cisco C891-24X/K9 ISR.

Figure 1-84 Back Panel of the Cisco C891-24X/K9 ISR

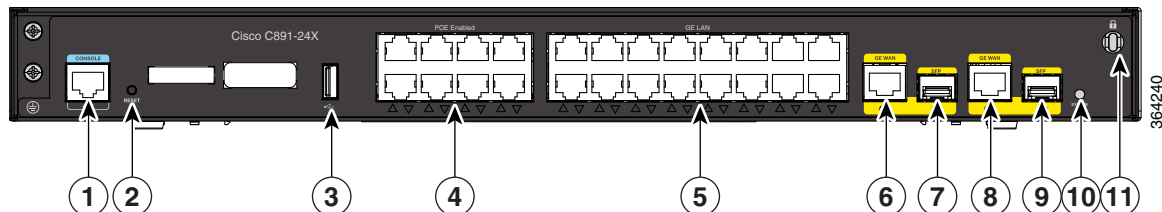

1	Console or auxiliary port	7	SFP port
2	Reset Button	8	GE WAN port
3	USB port	9	SFP port
4	PoE enabled GE LAN ports	10	System LED
5	GE LAN ports	11	Kensington security slot
6	GE WAN port		

For information on installing the C891-24X/K9 ISR see the following link:

<http://www.cisco.com/c/en/us/td/docs/routers/access/800/hardware/installation/guide/800HIG/installing.html>

## Hardware Features

This section provides an overview of the following hardware features for the Cisco 860 Series, 880 Series, and 890 Series ISRs. A feature summary is available at the end of this section.

- [Kensington Lock](#)
- [Reset Button](#)
- [LEDs](#)
- [Memory](#)
- [USB Port](#)
- [Fan](#)
- [Power Supply](#)
- [Power over Ethernet Module](#)
- [3G Cellular Data WAN Connectivity](#)
- [Small Form-Factor Pluggable Port](#)
- [Feature Summary](#)

## Kensington Lock

A Kensington security slot is located on the router back panel. To secure the router to a desktop or other surface, use the Kensington lockdown equipment.

## Reset Button

The Reset button is used to restore the router to the factory default configuration or to load a custom configuration file.

There are two different ways to do this:

- By pressing the Reset button within 5 seconds of powering up the router.
- By pressing the Reset button for 5 seconds while running IOS software.



### Note

If you execute a **CLI reboot** command while the embedded wireless AP is running Cisco Unified Wireless Network software, the router reboots, but the AP continues to run. Clients with Cisco Unified Wireless Network software are controlled by a wireless LAN controller (WLC) and can be reset only by the controller.

## Cisco 860VAE Routers—Custom Configuration File

On the Cisco 860VAE routers, the reset button can be used to load a custom configuration file without having to use the CLI. The configuration file can be located on an external USB flash drive or on the router's compact flash.

The custom configuration file must be named one of the following:

- customer-config
- SN-customer-config (where “SN” is the unique hardware serial number)

When the system attempts to load a custom configuration file, configuration files on a USB flash drive have priority over configuration files on the router's flash drive and the SN-customer-config file name has priority over the customer-config file name. The priority for loading a configuration file is as follows:

1. USB flash0—SN-customer-config
2. USB flash0—customer-config
3. Router flash—SN-customer-config
4. Router flash—customer-config

If the router does not find a valid custom configuration file, the system aborts the process.

To reset the router to the factory default configuration, follow these steps:

- 
- Step 1** Verify that Cisco IOS is running correctly by checking that the system status LED is on.

- Step 2** Press and hold the **Reset** button until the system status LED begins to flash. Typically, this occurs within 5 seconds.

The router reloads itself after the startup configuration has been replaced with the new customer configuration.

---

### Custom Configuration File for Cisco 892FSP, Cisco 896VA, Cisco 897VA, and Cisco 898EA

In the first method, the configuration file can be located on the router's compact flash or on the router's NVRAM. The custom configuration file must use **cfg** as the filename extension.

When the system attempts to load a custom configuration file, configuration files on NVRAM have priority over configuration files on the router's compact flash.

The priority for loading a configuration file is as follows:

1. nvram: \*.cfg
2. Router flash: \*.cfg

If the router does not find a valid custom configuration file, the system aborts the process. To reset the router to the factory default configuration or to load a custom configuration file, follow these steps:

---

- Step 1** Turn the power on.
- Step 2** Press and hold the **Reset** button until the system status LED begins to flash. Typically, this occurs within 5 seconds.

The router reloads itself after the startup configuration has been replaced with the new customer configuration.

---

In the second method, the configuration file can be located on an external USB flash drive or on the router's compact flash.

The custom configuration file must be named one of the following:

- customer-config
- customer-config.SN, where "SN" is the unique hardware serial number.

When the system attempts to load a custom configuration file, configuration files on a USB flash drive have priority over configuration files on the router's flash drive and the "customer-config.SN" file name has priority over the **customer-config** file name.

The priority for loading a configuration file is as follows:

1. usbflash0:customer-config.SN
2. usbflash0:customer-config
3. Router flash:customer-config.SN
4. Router flash:customer-config

If the router does not find a valid custom configuration file, the system aborts the process.

To reset the router to the factory default configuration or to load a custom configuration file, follow these steps:

---

- Step 1** Verify that Cisco IOS is running correctly by checking that the system status LED is on.

- Step 2** Press and hold the Reset button until the system status LED begins to flash. Typically, this occurs within 5 seconds.

The router reloads itself after the startup configuration has been replaced with the new customer configuration.

## LEDs

The LEDs are located on the front panel of the router.

- [Table 1-45](#) describes the LEDs for the Cisco 860 Series, Cisco 880 Series, and Cisco 890 Series ISRs.
- [Table 1-46](#) lists the LED descriptions for the Cisco 866VAE, Cisco 867VAE, Cisco 866VAE-K9, and Cisco 867VAE-K9 ISRs.
- [Table 1-47](#) lists the LED description for the Cisco 892FSP, Cisco 896VA, Cisco 897VA, and Cisco 898EA ISRs.
- For a description of LEDs for Cisco 860VAE-W-A-K9, Cisco 860VAE-W-E-K9, and Cisco 860VAE-POE-W-A-K9 ISRs models, see the “[Cisco 860VAE-W-A-K9, Cisco 860VAE-W-E-K9, and Cisco 860VAE-POE-W-A-K9 ISRs](#)” section on page 1-50.

**Table 1-45** LED Descriptions for the Cisco 860 Series, Cisco 880 Series, and Cisco 890 Series ISRs

LED	Color	Description	860 Series	880 Series	890 Series
Power OK	Green	On—DC power is being supplied to the router and the Cisco IOS software is running. Blinking—Bootup is in process, or the router is in Rommon monitor mode. Off—Power is not supplied to the router.	All models	All models	All models
Link Status FE0	Green	On—Ethernet port is connected.	All models	All models	All models
Link Status FE1		Blinking—Data is either being received or being transmitted.			
Link Status FE2					
Link Status FE3		Off—Ethernet port is not connected.			
Link Status FE4	Green	On—Ethernet port is connected.	—	—	All models
Link Status FE5		Blinking—Data is either being received or being transmitted.			
Link Status FE6					
Link Status FE7		Off—Ethernet port is not connected.			
FE WAN Port Link Status	Green	On—Port is connected. Blinking—Data is either being received or being transmitted. Off—Port is not connected.	861 models	881 models	All models
GE WAN Port Link Status	Green	On—Port is connected. Blinking—Data is either being received or being transmitted. Off—Port is not connected.	—	—	All models

Table 1-45 LED Descriptions for the Cisco 860 Series, Cisco 880 Series, and Cisco 890 Series ISRs (continued)

LED	Color	Description	860 Series	880 Series	890 Series
WLAN (2.4 GHz)	Green	On—Radio is connected, SSID <sup>1</sup> is configured, and client is associated, but no data is being received or being transmitted.  Slow blinking—Radio is connected, SSID is configured, and beacons are being transmitted.  Fast blinking—Data is either being received or being transmitted.  Off—Radio is shut down, and no SSID is configured.	Wireless models	Wireless models	Wireless models
WLAN (5 GHz)	Green	On—Radio is connected, SSID is configured, and client is associated, but no data is being received or being transmitted.  Slow blinking—Radio is connected, SSID is configured, and beacons are being transmitted.  Fast blinking—Data is either being received or being transmitted.  Off—Radio is shut down, and no SSID is configured.	—	Wireless models	Wireless models
WLAN LINK (Autonomous Mode)	Green	On—Wireless link is up.  Blinking—Ethernet link is up, and data is either being received or being transmitted.  Off—Wireless link is down.	Wireless models	Wireless models	Wireless models
WLAN LINK (Unified Mode)	Green	On—Ethernet link is up, and wireless access point (AP) is communicating with LWAPP <sup>2</sup> controller.  Blinking—Ethernet link is up, but wireless AP is not communicating with LWAPP controller.  Off—Ethernet link is down.	—	Wireless models	Wireless models
PoE	Green	On—PoE is connected and powered.  Off—PoE is not installed.	—	Models with PoE	Models with PoE
	Amber	On—Fault with the PoE.			
VPN	Green	On—VPN is connected.	—	All models	All models
PPP <sup>3</sup>	Green	On—At least one PPP session is established.	—	All models	All models
xDSL <sup>4</sup> CD	Green	On—The xDSL interface is connected to the DSLAM <sup>5</sup> .  Blinking—Training to the line.  Off—Indicates that a connection has not been established or the port is shut down.	—	886, 886VA, 887, 887VA, 887VA-M 888 models	896VA, 897VA, 898EA, 897VAB



Table 1-45 LED Descriptions for the Cisco 860 Series, Cisco 880 Series, and Cisco 890 Series ISRs (continued)

LED	Color	Description	860 Series	880 Series	890 Series
xDSL Data	Green	Blinking—The xDSL interface is either receiving or transmitting data. Off—No data is being transmitted or being received.	—	886, 886VA, 887, 887VA, 887VA-M 888 models	896VA, 897VA, 898EA, 897VAB
xDSL ATM	Green	On—The router is operating in ATM <sup>6</sup> mode. Off—Not operating in ATM mode.	—	888E	—
xDSL EFM	Green	Blink—The router is operating in EFM <sup>7</sup> mode. Off—Not operating in EFM mode.	—	—	898EA
Data BRI LINK	Green	On—ISDN D channel is connected.	—	887, 888 models	892 models
Data BRI B1	Green	Blinking—B1 channel is either receiving or sending data, or data is passing through ISDN channel 1.	—	887, 888 models	892 models
Data BRI B2	Green	Blinking—B2 channel is receiving or sending data, or data is passing through ISDN channel 2.	—	887, 887V, 888 models	892 models
3G <sup>8</sup> WWAN <sup>9</sup>	Green	On—Service is established. Slow Blinking—Searching for service. Fast Blinking—Data is either being received or being transmitted.	—	3G models	—
3G RSSI <sup>10</sup>	Green	Off—Low signal strength (lower than -100 dBm). On—High RSSI (-69 dBm or higher). Slow Blinking—Low or medium RSSI (-99 to -90 dBm). Fast Blinking—Medium RSSI (-89 to -70 dBm).	—	3G models	—
	Amber	On—No service.	—	3G models	—
3G GSM <sup>11</sup>	Green	On—Service is established. Off—No service.	—	3G models	—
3G CDMA <sup>12</sup>	Green	On—Service is established. Off—No service.	—	3G models	—
FXO Voice	Green	On—FXO port is connected. Blinking—FXO port is either receiving or transmitting data.	—	881 <sup>13</sup>	—
BRI Voice LNK	Green	On—BRI interface is connected.	—	—	—
BRI Voice B1	Green	On—BRI B1 channel is connected. Blinking—BRI B1 channel is either receiving or transmitting data.	—	—	—

**Table 1-45** LED Descriptions for the Cisco 860 Series, Cisco 880 Series, and Cisco 890 Series ISRs (continued)

LED	Color	Description	860 Series	880 Series	890 Series
BRI Voice B2	Green	On—BRI B2 channel is connected. Blinking—BRI B2 channel is either receiving or transmitting data.	—	—	—
FXS/DID Voice	Green	On—FXS/DID port is connected. Blinking—FXS/DID port is either receiving or transmitting data.	—	SRST models	—
V.92 Modem	Green	On—Modem is connected. Blinking—V.92 port is either receiving or transmitting data.	—	—	891 models
SFP <sup>14</sup> EN	Off	Not present.	—	—	892F models
	Green	Present and enabled.	—	—	
	Amber	Present with failure.	—	—	
SFP S	Green	Blinking—Blinking frequency indicates port speed.	—	—	892F models

1. SSID = service set identifier.
2. LWAPP = Lightweight Access Point Protocol.
3. PPP = Point-to-Point Protocol.
4. xDSL = General term referring to various forms of DSL, including ADSL (asymmetric digital subscriber line) and VDSL (very-high-data-rate digital subscriber line).
5. DSLAM = digital subscriber line access multiplexer.
6. ATM = Asynchronous Transfer Mode.
7. EFM = Ethernet in the First Mile.
8. 3G = Third-Generation.
9. WWAN = wireless WAN.
10. RSSI = Received Signal Strength Indicator.
11. GSM = Global System for Mobile Communication.
12. CDMA = code division multiple access.
13. SRST = Survivable Remote Site Telephony.
14. SFP = small-form-factor pluggable.

[Table 1-46](#) describes the LEDs for the Cisco 866VAE, Cisco 867VAE, Cisco 866VAE-K9, and Cisco 867VAE-K9 ISRs.

**Table 1-46 LED Descriptions for the Cisco 866VAE, Cisco 867VAE, Cisco 866VAE-K9, and Cisco 867VAE-K9 ISRs**

LED	Activity	Description
Power/System	Power/System LED: Solid GE_MODE LED: Off DSL_LINK LED: Off	Power is on and system running in the ROMMON mode.  <b>Note</b> During the early booting stage, both Power/System, GE_MODE, and DSL_LINK LED will be turned on temporarily for the power on test. DSL_LINK and GE_MODE LED will be turned off later after booting into ROMMON.
	Power/System LED: Solid GE_MODE LED: Solid DSL_LINK LED: Off	Cisco IOS functioning in GE WAN mode.
	Power/System LED: Solid GE_MODE LED: Off DSL_LINK LED: Solid or flashing	Cisco IOS functioning in DSL_WAN mode.  <b>Note</b> In Cisco IOS DSL_WAN mode, DSL_LINK LED will be solid after DSL training complete or flashing during training.
xDSL <sup>1</sup> ACT	Green	On—DSL interface is up. Blinking—DSL WAN activity (traffic in either direction). Faster blinking—Heavier traffic Off—Device is powered off or the DSL WAN interface is down.
xDSL Link	Green	On—DSL WAN Mode is selected and DSL training complete. Blinking—DSL WAN Mode is selected but incomplete DSL Link Up state, such as in-training, or controller “OFF,” or no cable attached to DSL connector. Off—Device is powered off or GE WAN mode is selected.
GE ACT	Green	On—GE WAN interface is up. Blinking—GE WAN activity (traffic in either direction). Off—Device is powered off or GE WAN interface is down.
GE Mode	Green	On—GE WAN Mode is selected. Off—Device is powered off or DSL WAN mode is selected.

1. xDSL = General term referring to various forms of DSL, including ADSL (asymmetric digital subscriber line) and VDSL (very-high-data-rate digital subscriber line).

Table 1-47 describes the LEDs for the Cisco 892FSP.

**Table 1-47 LED description for Cisco 892FSP ISR, 896VA, 897VA, and 898EA Routers**

LED	Color	Activity	Description
PWR_OK	Green	Power Status	Off—No power. Steady on—Normal operation. Blink—Boot up phase or in ROM Monitor mode.
GE0	Green/Amber	Link Status	Green On—Ethernet port is connected.
GE1			Amber On—Fault with PoE. There is a fault with the inline power supply.
GE2			Green/Amber Blinking—Data is either being received or being transmitted.
GE3			
GE4			
GE5	Green	Link Status	On—Ethernet port is connected.
GE6			Blinking—Data is either being received or being transmitted.
GE7			Off—Ethernet port is not connected.
GE WAN ports	Green	Link Status	On—Port is connected. Blinking—Data is either being received or being transmitted. Off—No link.
SFP WAN ports	Green	Link Status	On—Port is connected. Blinking—Data is either being received or being transmitted. Off—No link.
VPN_OK	Green	—	Off—No tunnel. Steady on—At least one tunnel is up.
PPP_OK	Green	—	Off—No PPP session. Steady on—At least one PPP established.

### Shared LEDs on the Cisco 881-V and Cisco 887VA-V Voice and Data Routers

On the Cisco 881-V, Cisco 887VA-V, and Cisco 887VA-V-W routers, the BRI1, BRI2 and the FXS ports share LED indicators. The following ports share an LED indicator:

- BRI 1B1 channel and FXS 3
- BRI 1B2 channel and FSX 4
- BRI 2B1 channel and FXS 5
- BRI 2 B2 channel and FXS 6

Because the LED indicators are shared, the LED illuminates (green) when either port is active. For example, the LED indicator labeled BRI 1 B1 illuminates when either the BRI1 B1 channel is active or when the FXS port is active. You can determine the activity status on each interface by using the following commands.

- For activity status on the FXS ports, use the **show port summary** command.
- For activity status on the BRI ISDN port, use the **show isdn status** command.

Figure 1-85 shows a close-up view of the LED indicators.

**Figure 1-85** Close-up of the BRI and FXS LED Indicators

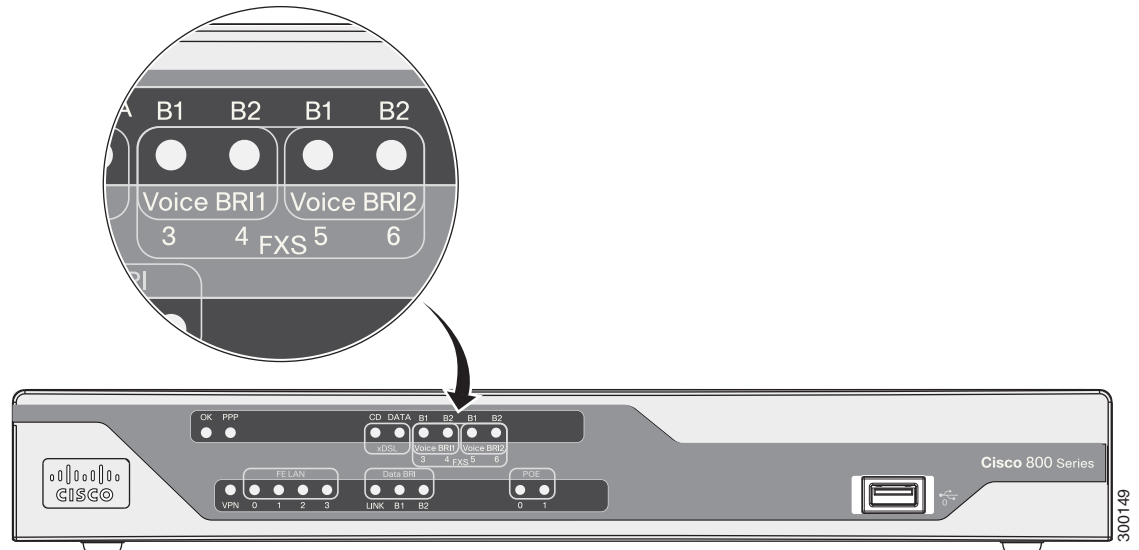

## Memory

The Cisco 860 series, 880 series, and 890 series routers contain flash memory and main memory.

### Flash Memory

The Cisco 860 series, 880 series, and 890 series ISRs use non-upgradable flash memory storage. The onboard flash memory contains the Cisco IOS software image, the boot flash contains the ROMMON boot code, and a separate non-volatile flash contains the cookie configuration.

Table 1-48 describes the default flash memory storage.

**Table 1-48** Flash Memory Storage

Models	Flash Memory Storage
Cisco 860 series and 880 series routers	128 MB
Cisco 880 series voice routers and Cisco 890 series routers	256 MB
Cisco 880 series routers with embedded WLAN antennas	256 MB
Cisco 860VAE routers	8 MB boot flash, 128 MB for IOS
Cisco 860VAE-K9	64 MB boot flash and IOS

**Note**

Flash memory is not upgradable. An external USB flash memory module may be used if additional flash memory is needed.

**Main Memory**

[Table 1-49](#) describes the main onboard memory storage for different router models.

**Table 1-49 Main Onboard Memory Storage**

Models	Onboard Memory Storage	Expandability
Cisco 860 series routers	256 MB	Not expandable.
Cisco 860VAE series routers	256 MB	Not expandable.
Cisco 880 series routers	256 MB (expandable to 768 MB)	A memory expansion slot accommodates a PC2-4200, 256-MB or 512-MB double data rate 2 (DDR2) SODIMM, for a maximum of 768 MB.
Cisco 880 series routers with embedded WLAN antennas	512 MB	Not expandable.
Cisco 892FSP, 896VA, 897VA, 898EA routers	512 MB	Expandable to 1 GB.

**USB Port**

[Table 1-50](#) describes the USB ports for different router models.

**Table 1-50 USB Ports**

Models	USB
Cisco 860 series (non-VAE)	No USB ports.
Cisco 860VAE series	One USB 1.1-compliant port located on the back panel. The USB port does not support eToken.
Cisco 860VAE-W-A-K9, Cisco 860VAE-W-E-K9, and Cisco 860VAE-POE-W-A-K9 series	For more information, refer to the <a href="#">“Cisco 860VAE-W-A-K9, Cisco 860VAE-W-E-K9, and Cisco 860VAE-POE-W-A-K9 ISRs”</a> section on page 1-50.
Cisco 880 series	One USB 1.1-compliant port located on the front panel. The USB port provides connection for USB devices such as security tokens and flash memory.
Cisco 890 series <sup>1</sup>	Two USB 2.0-compliant ports located on the front panel.
Cisco 892FSP, Cisco 896VA, Cisco 897VA, Cisco 898EA	One USB 2.0-compliant port located on the back panel.

1. Except for Cisco 892FSP, Cisco 896VA, Cisco 897VA, and Cisco 898EA.

## Fan

Some router models do not have a fan, while other models have either one or two fans.

The fans spin at full speed, as a diagnostic aid, immediately after the router is powered up. After the router has booted, the fans spin as fast as necessary to minimize fan noise while maintaining a safe internal operating temperature.

The following models have no fan:

- Cisco 892FSP
- Cisco 896VA
- Cisco 897VA
- Cisco 898EA

## Power Supply

The Cisco 892FSP has a single +12V power supply input. The Cisco 892FSP power connector is different from the barrel-type connector on other 890 series models. The AC adapter cable connector has four pins and a built-in locking mechanism. [Figure 3-33](#) shows the power adapter connector.

The Cisco 896VA, 897VA, and Cisco 898EA use PoE (12 VDC 43 W, -54 VDC 80 W) and non-PoE (12 VDC 60 W) power supplies.

## Power over Ethernet Module

The Cisco 880 series ISRs can include an optional Power over Ethernet (PoE) module that provides power to 802.3af-compliant devices connected to FE ports 0 and 1.

The Cisco 890 series ISRs can include an optional PoE module that provides power to 802.3af-compliant devices connected to FE ports 0, 1, 2, and 3.

The PoE module is an option available only for the Cisco 880 series and 890 series ISRs and requires a 48 V external power adapter.

This function can be added to an 880 or 890 series router by installing the PoE adapter card in the router and inserting the PoE 48 V external power adapter.



### Note

The Cisco 880 series ISRs with embedded WLAN antennas require a single external power supply: a 30 W power supply for non-POE-enabled routers or a 60 W power supply for POE-enabled routers. For the back panels of some of these routers, see [Figure 1-33](#) and [Figure 1-35](#).

The following PoE budget is available:

- C867VAE-POE-W-A-K9: 15.4 W (one port PoE)
- Cisco 880 series: 30.8 W (2 ports each 15.4 W)
- Cisco 890 series: 61.6 W (4 ports each 15.4 W)

## 3G Cellular Data WAN Connectivity

The 3G (Evolution Data Only [EVDO], Universal Mobile Telecommunications Systems [UMTS]) cellular interface is intended for use as a backup data link, but it can also be used as a primary WAN data link. The 3G technology is third-generation wide-area cellular technology that is used in voice telephony and broadband wireless data in a mobile environment.

Some Cisco 880G models come with a 34-mm express card slot ready for use with a commercial 3G card radio. The 3G express card slot is located on the front panel. For a list of supported 3G cards, see the [Cisco 880 Series Integrated Services Routers Data Sheet](#).

Other Cisco 880G models come with embedded WAN modems for use over GSM or CDMA networks. These routers have antenna connectors on the back panel. GSM routers have two SIM card slots. For information on configuring Cisco 880 series ISRs for 3G, see [Configuring Cisco EHWIC and 880G for 3G \(EV-DO Rev A\)](#) and [Configuring Cisco EHWIC and 880G for 3.7G \(HSPA+\)/3.5G \(HSPA\)](#).

## Wireless LAN Connectivity

The embedded Wi-Fi CERTIFIED™, 802.11a/b/g/n-compliant wireless AP is preinstalled in the router as an optional feature. The Cisco 860 series routers support autonomous features and network configurations. The Cisco 880 series and 890 series routers support both autonomous and unified features and network configurations.

The wireless AP does not have an external Console port. Use the router's Console port as described in [Chapter 3, "Connecting the Router."](#) To configure the wireless device, use the Cisco IOS command-line interface (CLI).

[Table 1-51](#) describes the radios and antennas for the Cisco 860 series, 880 series, and 890 series routers.



### Note

Cisco 860VAE ISRs do not support wireless LAN connectivity.

The 5-GHz radio operates in the Unlicensed National Information Infrastructure (UNII) 1, 2, 3, 5-GHz frequency bands.

**Table 1-51** Wireless Device Radios and Antennas

Radio Module	Platform	Radio Band	Maximum Data Throughput <sup>1</sup>	Mode	Antenna
Single-band 802.11b/g/n draft 2.0 radio module	Cisco 860 and 880 series routers  <b>Note</b> Cisco 860VAE ISRs do not support wireless LAN connectivity.	2.4 GHz	Up to 100 Mb/s	Cisco 860 series: autonomous only  Cisco 880 series: autonomous and unified	Three captive, omnidirectional dipole antennas: 2 dBi at 2.4 GHz



Table 1-51 Wireless Device Radios and Antennas

Radio Module	Platform	Radio Band	Maximum Data Throughput <sup>1</sup>	Mode	Antenna
Single-band 802.11b/g/n radio module	Cisco 880 series routers with embedded WLAN antennas	2.4 GHz	100 Mb/s per radio, up to 200 Mb/s total	Autonomous and unified	Three embedded, omnidirectional antennas: 2 dBi at 2.4 GHz
Dual-band 802.11a/n and 802.11b/g/n radio modules		2.4 GHz and 5 GHz			Three embedded, dual-band, omnidirectional antennas: 2 dBi at 2.4 GHz and 5 dBi at 5 GHz
Dual-band simultaneous 802.11a/n and 802.11b/g/n radio modules	Cisco 890	2.4 GHz and 5 GHz	100 Mb/s per radio, up to 200 Mb/s total	Autonomous and unified	Three dual-band, removable, 2.4-GHz/5-GHz omnidirectional dipole RP-TNC antenna <sup>2</sup>

- Actual data rate is highly dependent on your wireless environment.
- The antennas require some minor installation. They must be screwed onto the RP-TNC antenna connectors on the I/O side of the chassis. See the following document on Cisco.com for feature information: <http://www.cisco.com/en/US/docs/routers/access/wireless/hardware/notes/antdip.html>

### Supported Cisco Radio Antennas

The Cisco 891, Cisco 892, and Cisco 892F come with three removable dipole antennas that can be replaced using the Cisco approved antenna extenders listed in Table 1-52.



**Note** Cisco supports only the antennas listed in Table 1-52 with the Cisco 890 series dual-band radio module.

Table 1-52 Cisco Antennas Supported on the Cisco 890 Series ISRs

Cisco Part Number	Antenna Type	Maximum Gain	Description
AIR-ANTM2050D-R	Omnidirectional	2.0 dBi at 2.4 GHz 5.0 dBi at 5 GHz	This is the default antenna. It is a swivel-mount dipole dual-band blade antenna. For more information, see <a href="#">Cisco Multiband Swivel-Mount Dipole Antenna (AIR-ANTM2050D-R)</a> .
AIR-ANTM4050V-R	Omnidirectional	4.0 dBi at 2.4 GHz 5.0 dBi at 5 GHz	Ceiling-mount dual-band antenna. This antenna has a clip that allows it to be mounted on a drop-ceiling cross member. For more information, see <a href="#">Cisco Multiband Diversity Omnidirectional Ceiling-Mount Antenna</a> .
AIR_ANTM5560P-R	Patch	5.5 dBi at 2.4 GHz 6.0 dBi at 5 GHz	Wall-mount dual-band antenna. For more information, see <a href="#">Cisco Multiband Wall-Mount, Corner-Mount, or Mast-Mount Antenna</a> .

## Small Form-Factor Pluggable Port

The SFP port supports auto-media-detection, auto-failover, and remote fault indication (RFI), as described in the IEEE 802.3ah specification.

See the Cisco 892F data sheet for a list of supported SFPs.

## Feature Summary

[Table 1-53](#) summarizes the hardware features available in the Cisco 860 series, Cisco 880 series, and Cisco 890 series ISRs.

**Table 1-53** Hardware Features Available in Cisco 860 Series, Cisco 880 Series, and Cisco 890 Series ISRs

Feature	Description	860 Series	880 Series	890 Series
Reset button	Resets the router configuration to the factory default.	All models	All models	All models
	Resets the router configuration to customer configuration.	866VAE, 867VAE, 866VAE-K9, 867VAE-K9	—	—
FE <sup>1</sup> built-in switch ports	Provides connection to 10/100BASE-T (10/100-Mb/s) Fast Ethernet networks. The autosensing function in these routers eliminates the need for a crossover cable and enables the router to detect MDI <sup>2</sup> or MDIX <sup>3</sup> in any other PC or hub with a straight-through cable or a crossover cable.	All models	All models	891, 892, 892F
GE <sup>4</sup> built-in switch port	Provides connection to 10/100/1000BASE-T (10/100/1000-Mb/s) Gigabit Ethernet networks. The autosensing function in these routers eliminates the need for a crossover cable and enables the router to detect MDI <sup>5</sup> or MDIX <sup>6</sup> in any other PC or hub with a straight-through cable or a crossover cable.	866VAE-K9, 867VAE-K9	—	892FSP, 896VA, 897VA, 897VAB, 897VAM, 897VAW, 897VAMW, 898EA
Console or AUX port	Provides a connection to the terminal or PC for software configuration or troubleshooting. The Console port may be configured as a virtual auxiliary port for dial backup and remote management.  Cisco 891, Cisco 892, and Cisco 892F have separate console and auxiliary ports.  Cisco 892FSP has combined console and auxiliary port.	All models	All models	All models
Security features	Provides support for VPNs <sup>7</sup> , Cisco IOS Firewall, and IPSec <sup>8</sup> . The Cisco 880 series routers also provide URL filtering.	861, 867, 866VAE-K9, 867VAE-K9	All models	All models

Table 1-53 Hardware Features Available in Cisco 860 Series, Cisco 880 Series, and Cisco 890 Series ISRs (continued)

Feature	Description	860 Series	880 Series	890 Series
Embedded wireless AP	Provides Wi-Fi CERTIFIED™ 802.11a/b/g/n compliance. The Cisco 860 series routers contain a single 802.11b/g/n radio. Some Cisco 880 series routers contain a single 802.11b/g/n radio while others contain dual 802.11a/n and 802.11b/g/n radios. The Cisco 890 series routers contain dual 802.11b/g/n and 802.11a/n radios.	Wireless models 802.11b/g/n	Wireless models 802.11b/g/n <sup>9</sup> and 802.11a/n <sup>10</sup>	Wireless models 802.11b/g/n and 802.11a/n
FE WAN port	Provides connection to 10/100BASE-T. Can be connected to other network devices, such as a cable modem, an xDSL <sup>11</sup> modem, or router. The router is capable of bridging and multiprotocol routing between the LAN and WAN ports.	861	881	891, 892, 892F
GE WAN port	10/100/1000 GE WAN Port.	866VAE, 867VAE, 866VAE-K9, 867VAE-K9	—	All models
VDSL <sub>o</sub> POTS <sup>12</sup> port	Provides connection to a VDSL network.	—	887V	—
ADSL <sub>o</sub> POTS	Provides ADSL connection over basic telephone service with Annex A and Annex B ITU G. 992.1 (ADSL), G.992.3 (ADSL2), and G.992.5 (ADSL).	—	—	—
ADSL <sub>o</sub> ISDN	Provides ADSL connection over ISDN.	—	—	—
DSL Multi-mode (VDSL and ADSL2/2+)	Provides ADSL2/2+ or VDSL connection over POTS or ISDN (ISDN on 886VA only).	866VAE, 867VAE, 866VAE-K9, 867VAE-K9	886VA, 887VA,887V A-M	892FSP, 896VA, 897VA, 897VAB, 897VAM, 897VAW, 897VAMW, 898EA
Real-time clock (RTC)	RTC provides nonvolatile date and time when the router is powered on. The RTC is used for verifying the validity of the Certification Authority stored on the router. It is backed up by a nonreplaceable lithium battery.	866VAE, 867VAE, 866VAE-K9, 867VAE-K9	All models	All models

Table 1-53 Hardware Features Available in Cisco 860 Series, Cisco 880 Series, and Cisco 890 Series ISRs (continued)

Feature	Description	860 Series	880 Series	890 Series
USB port,	<p>Supports USB 1.1. Provides connection for USB devices such as security tokens and flash memory.</p> <p>The Cisco 880 series routers have a single USB port; the Cisco 890 series routers have two USB ports.</p> <p>Cisco 880 series routers with embedded WLAN antennas have one USB 2.0 port.</p> <p>Cisco 892FSP and Cisco 860VAE series routers have one USB 2.0 port on the rear panel for temporary installation of a Cisco-approved USB memory device for maintenance purposes only. The port supports only USB 2.0. Refer to the product datasheet for the list of supported USB flash memory devices.</p> <p><b>Note</b> Cisco 860VAE series router USB port does not support eToken.</p>	866VAE, 867VAE, 866VAE-K9, 867VAE-K9	All models	All models
PoE <sup>13</sup>	<p>(Optional) Provides power for 802.3af-compliant devices (such as phones) that are connected to the router.</p> <p>The Cisco 880 series routers support a 2-port PoE module; the Cisco 890 series routers support a 4-port PoE module.</p>	—	Models with PoE	Models with PoE
G.SHDSL <sup>14</sup> port	Provides 2-wire or 4-wire connection to a G.SHDSL network.	—	888	898EA
3G <sup>15</sup> card slot	Provides backup data link.	—	3G models	—
Dying gasp	Detects when the router is losing power, and sends a power-fail signal to warn the DSLAM <sup>16</sup> about the impending line drop.	866VAE, 867VAE, 866VAE-K9, 867VAE-K9, xDSL models	888EA, xDSL models	892FSP, 896VA, 897VA, 897VAB, 897VAM, 897VAW, 897VAMW, 898EA
Data BRI port	Provides backup and remote management functions by connecting to the ISDN service provider if the main VDSL or G.SHDSL link fails.	—	xDSL models, except for the 3G and SRST <sup>17</sup> models	892, 897VAB
V.92 modem	Provides dial backup and remote management functions if the main WAN link fails.	—	—	891
FXO <sup>18</sup> port	An FXO interface connects local calls to a central office or PBX. This is the interface a standard telephone provides.	—	881 SRST	—
FXS <sup>19</sup> /DID <sup>20</sup> port	An FXS interface connects directly to a standard telephone, fax machine, or similar device. This interface supplies ringing voltage and dial tone to the station.	—	SRST models	—

**Table 1-53** Hardware Features Available in Cisco 860 Series, Cisco 880 Series, and Cisco 890 Series ISRs (continued)

Feature	Description	860 Series	880 Series	890 Series
BRI voice port	The ISDN BRI S/T voice interface provides a client-side (TE) ISDN S/T physical interface for connection to an NT1 device that terminates an ISDN telephone network.	—	887V	—
SFP <sup>21</sup> port	Supports auto-media-detection, auto-failover, and remote fault indication (RFI), as described in the IEEE 802.3ah specification. See the Cisco 892F data sheet for a list of supported SFPs.	—	—	892F models, 892FSP, 896VA, 897VA, 897VAB, 897VAM, 897VAW, 897VAMW, 898EA

1. FE = Fast Ethernet.
2. MDI = media-dependent interface in normal mode.
3. MDIX = media-dependent interface in crossover mode.
4. GE = Gigabit Ethernet.
5. MDI = media-dependent interface in normal mode.
6. MDIX = media-dependent interface in crossover mode.
7. VPN = Virtual Private Network.
8. IPsec = IP security.
9. This applies to most models of the Cisco 880 series routers.
10. This applies to Cisco 880 series routers with embedded, wireless antennas.
11. xDSL = General term referring to various forms of DSL, including ADSL (asymmetric digital subscriber line), VDSL (very-high-data-rate digital subscriber line), and G.SHDSL.
12. VDSL<sub>o</sub>POTS = very-high-data-rate digital subscriber line 2 over plain old telephone service.
13. PoE = Power over Ethernet. This function can be added to an 880 or 890 series router by installing the PoE adapter card in the router and inserting the PoE 48-V external power adapter.
14. G.SHDSL = (global industry standard) symmetrical high-speed DSL.
15. 3G = Third-Generation.
16. DSLAM = digital subscriber line access multiplexer.
17. SRST = Survivable Remote Site Telephony.
18. FXO = Foreign Exchange Office.
19. FXS = Foreign Exchange Station.
20. DID = Direct Inward Dialing.
21. SFP = small-form-factor pluggable.

