

Product Sampler:

# Modular Cleanrooms

## Pre-Tested Turnkey Systems



# System Overview

## Modular Cleanrooms

Manufactured by  
Terra Universal

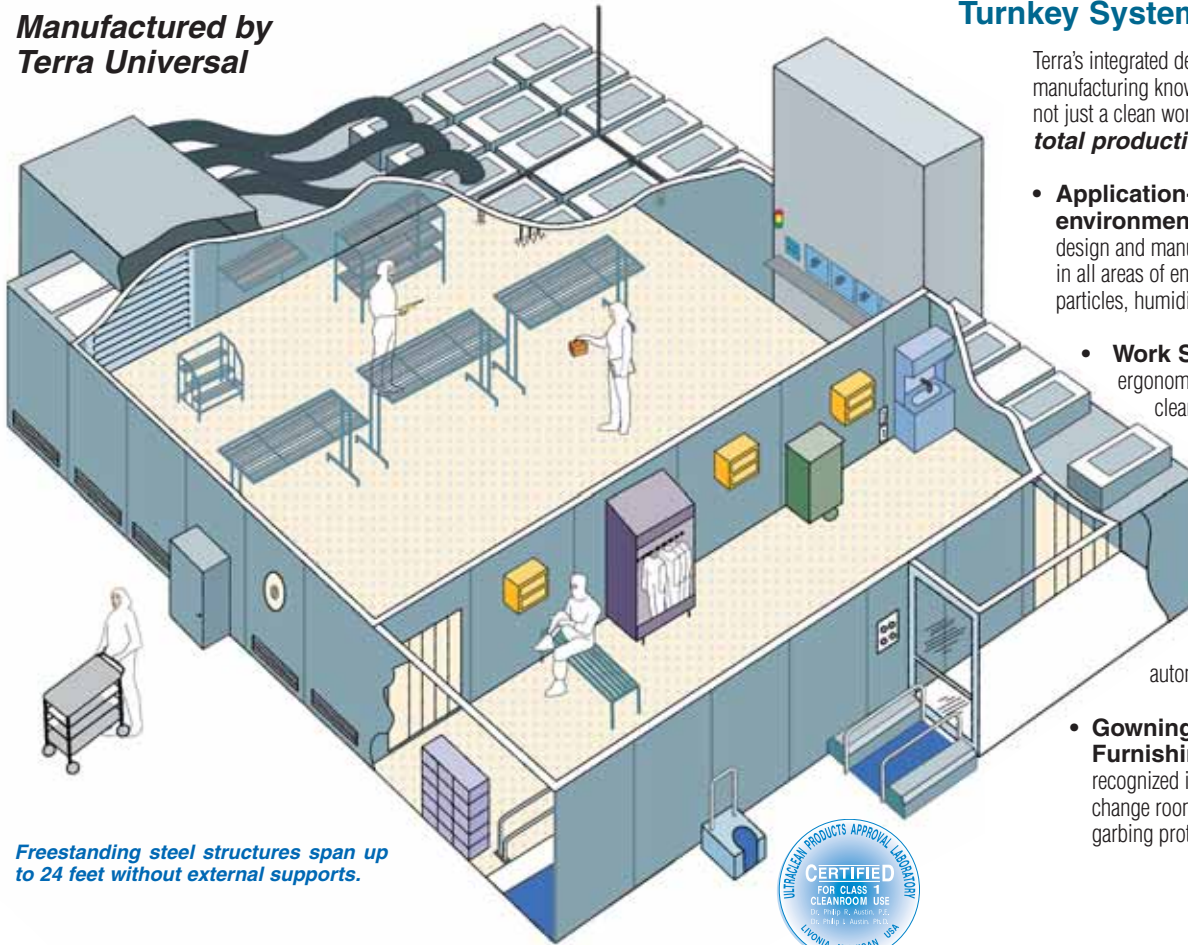

Freestanding steel structures span up to 24 feet without external supports.

## Fully Integrated, Pre-Tested Turnkey Systems

Terra's integrated design and manufacturing know-how lets you specify not just a clean work environment, but a **total production solution**:

- **Application-appropriate environment**—Over 25 years of design and manufacturing experience in all areas of environmental control: particles, humidity, static, temperature
- **Work Stations**—ergonomic, space-saving, ultra-clean designs, including laminar flow and exhaust purification systems
- **Storage Solutions**—from wall-mount and benchtop dry boxes to high-volume automated stockers
- **Gowning Area Furnishings**—from the recognized industry leader in change room design and garbing protocol



Convert Any Space into a Clean Environment!

# Configuration Guidelines

Use this overview to help you select the Terra Modular Cleanroom design for your application.

**USP <797> Compliant!**

See page 40 for systems configured for sterile compounding



Terra's online **QuickQuote Planner** configures a room to your specifications: [www.TerraUniversal.com](http://www.TerraUniversal.com)  
Just click on [Modular Cleanrooms](#)

Selection Guide

Hardwall Plastic

All-Steel BioSafe™

Powder Containment

Softwall Plastic

Accessories

Gowning Products

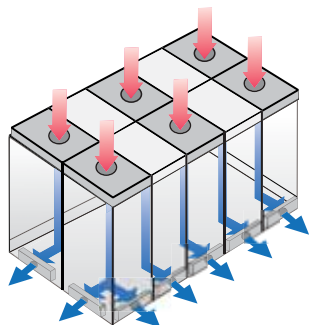

## Hardwall or Softwall Cleanrooms, Full-View Plastic Panels

**Hardwall** (page 2) – Select transparent acrylic, dissipative PVC, Lexan® or polypropylene panels, which mount either externally or internally to create smooth, easy-clean surfaces. All-steel support frame for strength and easy installation — requires no external bracing.

**Softwall** (page 12) – Many panel options, including anti-static vinyl and clear or frosted strip shields. All-steel supports available with casters.

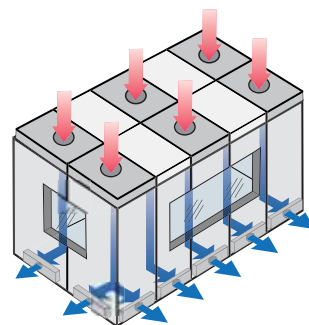

## All-Steel BioSafe™ Modular Cleanroom (page 6)

The most effective design for bio-tech and pharmaceutical applications.

304/316 stainless or powder-coated steel construction resists most solvents, disinfectants and other cleaning solutions. Antimicrobial coatings and panel gaskets create a germ-free environment. Radius corners and raised, drained flooring available for disinfectant wash-down. Configure as a positive- or negative-pressure room, with A/C and humidity control.

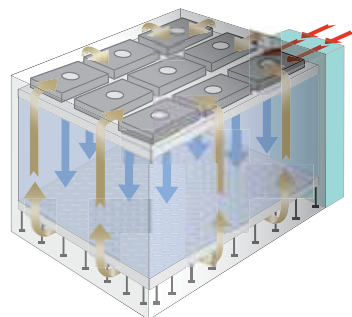

## Double-wall, Raised-floor Plastic Cleanroom

Ideal for applications that require raised flooring for true laminar flow. Double-wall structure allows air to circulate through the inter-wall plenum, increasing filtration and A/C efficiency.

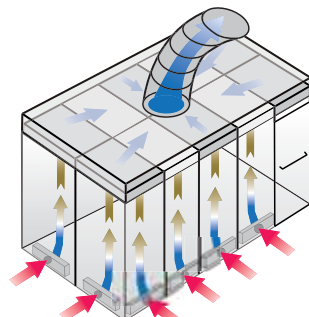

## Ventilation Room (page 16)

Ideal for safe removal of fine powders or chemical vapors. Adjustable ceiling ventilator draws air upward through HEPA filters and/or exhaust ductwork. Inlet filters ensure a clean working environment. Available for plastic or all-steel cleanrooms.

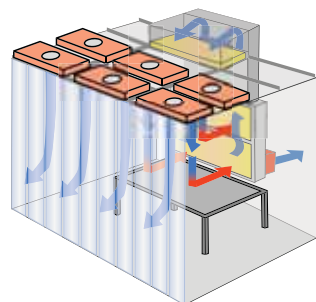

## Powder-Containment Room (page 10)

Air recirculation zone draws powders away from work station into a dual HEPA filtration system that protects both product and personnel. Adjustable air handler creates overall negative pressure to protect the external environment.

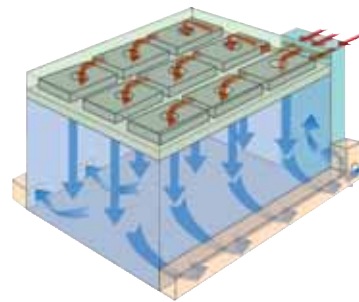

## Negative-Pressure Cleanroom (page 8)

Ceiling filter/fan units create laminar flow of particle-free air. Exhaust ductwork and adjustable air handlers create overall negative pressure to protect external environment from pharmaceutical powders and biohazards.

# Hardwall Cleanrooms

**Terra's Hardwall Modular Cleanrooms provide the rigidity and durability of a freestanding room. All components are factory-assembled and tested before shipping, and on-site installation is usually completed in less than a day.**

**Unlike other modular cleanrooms on the market which require complex suspended ceiling supports, Terra cleanrooms are completely free-standing structures.**

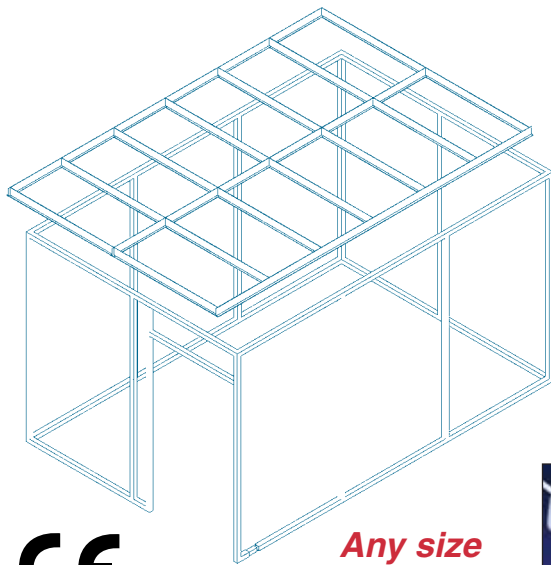

**Any size or floor plan!**

**New Door Options—**

- Electronic Sliders
- Rapid-action cloth doors
- Segmented aluminum roll-ups

See page 4



**IonBar™— for a cleaner cleanroom**  
Eliminates surface charges that attract particles. See page 17.



## Ordering Information

Use the catalog numbers below to specify the cleanroom style for your application. Specified rooms include powder-coated steel frame, control panel, and wall panels of material specified. Select access door(s), ceiling modules and other accessories to complete your system.

Plastic Hardwall Cleanrooms				
Panel Material: (see description at right)	Acrylic*	Dissipative PVC	Polycarbonate (Lexan®)	Polypropylene
	Cat. #	Cat. #	Cat. #	Cat. #
External Mount Panels	6600-00	6600-01	6600-02	6600-03
Internal Mount Panels	6600-05	6600-06	6600-07	6600-08

## Select Panel Mounts For Your Requirement —



**Internal-Mount Panels**  
Smooth internal surface is easy to disinfect (shown: interior polypropylene panels).



**External-Mount Panels**  
Includes mirror-finish 304 stainless steel control panel and mounting strips for a showcase room that's also durable and easy to clean.



Terra's online **QuickQuote Planner** configures a room to your specifications: [www.TerraUniversal.com](http://www.TerraUniversal.com)  
Just click on [Modular Cleanrooms](#)

Recommended Filter/Fan Configurations (see pg. 5)							
Nominal Dimensions	No. of Ceiling Bays	No. of Filter Modules to meet Fed Std 209 Class Standards					
		1	10	100	1,000	10,000	100,000
8' x 8'	8	5-8	4-8	3-6	2-3	1-2	1
8' x 12'	12	7-12	6-12	4-8	3-5	2-3	1-2
8' x 16'	16	10-16	8-16	6-11	4-6	2-4	1-3
12' x 12'	18	11-18	9-18	6-13	5-7	3-5	1-3
12' x 16'	24	14-24	12-24	8-17	6-10	4-6	2-4
16' x 16'	32	19-32	16-32	11-22	8-13	5-8	2-5
20' x 20'	50	30-50	25-50	18-35	13-20	8-13	3-8

\* Acrylic is damaged by alcohol and other cleaning agents.

## Cleanroom accessories begin on page 16

- Filter/Fan Units – HEPA/ULPA, low noise & vibration
- Lighting – fluorescent, teardrop, flow-through, UV
- Ionizing Modules – control ESD
- Air Conditioning and Dehumidification Modules
- Ceiling Ventilation Modules – for negative-pressure applications

## Other Modular Cleanroom Styles

- Softwall Plastic Cleanrooms – see page 12
- BioSafe™ All-Steel Cleanrooms – see page 6
- BioSafe™ Powder-Containment Rooms – see page 10

**USP <797> compliant models for sterile compounding—pg 40**

# Hardwall Options



*IsoVent™ ensures adequate positive pressure, independent of filter configuration*

## Cleanroom Support Frame

The support frame is fabricated of interlocking 1¼" powder-coated square steel uprights and cross sections. Ceiling members are welded to steel 3" x 1½" T-bars, forming the 2' x 4' bays that support filters and lights. Vertical finishing strips, fabricated of mirror-finished 304 stainless steel, hold hardwall panels securely in place. Standard height is 7' measured from filter face to floor (8'3" with filter/fan unit), allowing installation beneath a standard 9' ceiling. Other heights are available.

## Hardwall Panels

Standard 4'W x 7'H panels are available in three rigid materials:

**Acrylic Panels** offer visibility and tensile strength. Black and amber panels are also available (tinted panels may extend lead time). Not recommended for use with alcohol or other strong cleaning agents.

**Static-Dissipative PVC Panels** safely remove surface charges caused by the laminar airflow, protecting against potentially damaging ESD (electrostatic discharge) as well as particulate attraction. Dissipative layers are molecularly embedded for optimal durability. Surface resistivity: 10<sup>6</sup> - 10<sup>8</sup> ohms/sq. (ASTM-D257).

**Polycarbonate (Lexan®)** resists many common acids, solvents and cleaning solutions. Its high tensile strength makes it shatter resistant.

**Polypropylene** provides superb resistance to acids and other chemicals (see photo on page 4).



Standard Swing Door



Sliding Door



Touchplate-activated Automatic Door

## Standard Door (See page 4 for other door options)

Aluminum frame with choice of acrylic or static-dissipative PVC panel and pneumatic closure. Standard mounting is on right panel of shorter wall; specify other desired location. Standard swing is outward (away from room).

Door Panel Material	Single Door (81"H x 36"W)		Double Door (81"H x 72"W)	
	Cat. #	\$/Each	Cat. #	\$/Each
Acrylic*	6710-14	902.00	6704-00	1,802.00
Static-Dissipative PVC	6710-15	1,199.00	6704-01	2,042.00

## Sliding Door

This aluminum-frame door slides open along an extruded aluminum track to an opening of 36". Requires two 4-foot panels for installation. Standard model slides open from right to left; specify left to right slide, if desired. Overall dimensions: 40" W x 82" H

Door Panel Material	Cat. #	\$/Each
Acrylic*	6704-02	2,059.00
Static-Dissipative PVC	6704-03	2,202.00

## Automatic Door

Similar to standard swing doors above, but adds a touchpad activated opening mechanism for easy operation.

Door Panel Material	Cat. #	\$/Each
Acrylic*	6711-08	2,103.00
Static-Dissipative PVC	6711-07	2,400.00

## Strip Shield Door

Strip shields can be mounted in place of a standard door or 4-foot hardwall panel at any location along the perimeter of the cleanroom. See page 15 for ordering information.

## Control Panel (included standard)

Mounted to the right of the access door, this panel allows convenient control of filter/fan units, lights, ionizing modules, and other environmental monitoring equipment selected for your cleanroom. Fabricated of stainless steel. Included with each hardwall cleanroom.



## Removable Service Panel

Allows convenient servicing of equipment installed inside the enclosure, with minimal disruption of the internal environment.

Cat. #	\$/Each
6704-04	576.00

## Partitions & Ante-Chambers

**Antechambers** serve as contamination buffer zones; as staging areas; or as gowning areas. **Partitions** create multiple clean zones to meet varying cleanliness requirements inside a single cleanroom. Call to specify configuration.

	Acrylic* PVC	Dissipative (Lexan®)	Polycarbonate	Polypropylene
	Cat. #	Cat. #	Cat. #	Cat. #
Partition	6600-10	6600-11	6600-12	6600-13
Antechamber	6600-15	6600-16	6600-17	6600-18

**Note: Partitions and antechambers must be specified when cleanroom is ordered.**



## Cleanroom Talk-Through

Model shown	Cat. #	\$/Each
	5050-50	264.00

\* Acrylic is not recommended for use with alcohol and other cleaning agents.

# Hardwall Options



Hardwall cleanroom with internal-mount polypropylene panels for easy cleaning, A/C, and fast-response Pharma-Seal® Rolling Doors.

## Cleanroom Doors

- High-speed operation – up to 100"/second
- Ideal for loading and unloading large containers in a high-cycle cleanroom

Terra offers several alternatives to our standard modular cleanroom access doors (see page 3) for unique applications requiring rapid operation, large clearance and cleanroom compatibility.

### Electronic Doors

This photoeye-activated unit is integrated with Terra's standard single or double sliding door for rapid, hands-free operation. Order sliding door separately (see page 3).

	Cat. #	\$/Each
For Single Door	6710-37	2,800.00
For Double Door	6710-38	2,950.00



### Pharma-Seal® Rolling Door

Designed to meet pharmaceutical GMP guidelines, this is the tightest sealing, most reliable high-performance rolling door available. Its unique RyBeam™ light curtain safety system eliminates external photo eyes and other hardware. Opens at up to 50 inches/second, with adjustable closing speed. Door size: 6' wide x 7' high.

Cat. #	\$/Each
6710-47	16,294.00



### Spiral® HS Rigid Roll Door

Unique spiral technology keeps this rigid aluminum door whisper-quiet even at an opening speed up to 100 inches/second. Polycarbonate panels eliminate metal-on-metal contact for cleanliness and visibility. Door size: 6' wide x 7' high

Cat. #	\$/Each
6710-52	18,917.00

## How Clean is Clean? Guidelines for FFU Selection

Class 1 and Class 10 applications require near-100% ceiling coverage of filter/fan units (FFUs), producing a laminar flow of clean air traveling downward at a velocity of about 90 feet/minute (measured 6" below the filter face). This design ensures a positive pressure inside the cleanroom, which blocks the influx of contaminants and guarantees swift removal of particles generated by people or process equipment.

For less critical contamination requirements, experts correlate ventilation efficiency (i.e., the ability to remove contaminants and meet a cleanliness standard) with both the velocity of filtered air passing through the room and

**Table 1:  
Recommended Air Velocity Rates**

Class	Average Airflow Velocity	Air Changes Per Hour
ISO 14644-1 (Standard 209E)		
ISO 8 (Class 100,000)	0.005 - 0.041 m/sec (1 - 8 ft/min)	5 - 60
ISO 7 (Class 10,000)	0.051 - 0.076 m/sec (10 - 15 ft/min)	60 - 150
ISO 6 (Class 1,000)	0.127 - 0.203 m/sec (25 - 40 ft/min)	150 - 240
ISO 5 (Class 100)	0.203 - 0.406 m/sec (40 - 80 ft/min)	240 - 600
ISO 4 (Class 10)	0.254 - 0.457 m/sec (50 - 90 ft/min)	400 - 750
ISO 3 (Class 1)	0.305 - 0.457 m/sec (60 - 90 ft/min)	500 - 750
ISO 1-2	0.305 - 0.508 m/sec (60 - 100 ft/min)	500 - 750

**Note:** Actual average velocity and air changes required may vary depending on the application and floor plan.

also the number of air changes completed in a given time. The air-change figures are usually expressed as a range (see table).

Low-end figures within each contamination class generally indicate air velocity and air change requirements for an "as built" or "at rest" facility. In the presence of higher degrees of contamination more air changes are required to maintain the desired cleanliness standard. In fact, many manufacturers insist on as many as 720 air changes per hour to meet Class 10 or cleaner requirements. Once you have established the required air change figure, use this formula to calculate the number of FFUs required:

$$\text{No. of FFUs} = (\text{Air Changes/Hour} \div 60) \times (\text{Cubic ft. in room} \div 650^*)$$

\*CFM output of a loaded 2' x 4' FFU.

See [TerraUniversal.com](http://TerraUniversal.com) for full application guidelines.

**Table 2:  
Recommended Ceiling Filter Coverage**

Class	Ceiling Coverage
ISO 8 (Class 100,000)	5 - 15%
ISO 7 (Class 10,000)	15 - 20%
ISO 6 (Class 1,000)	25 - 40%
ISO 5 (Class 100)	35 - 70%
ISO 4 (Class 10)	50 - 90%
ISO 3 (Class 1)	60 - 100%*
ISO 1-2	80 - 100%*

**Note:** Actual average velocity and air changes required may vary depending on the application and floor plan.

\* ULPA filters required in Class 1/10 applications. HEPA filters required for all others.

## Cleanroom Flooring

Standard Terra cleanrooms are designed for placement on existing floors. However, Terra also provides several flooring solutions to meet various requirements:

- **Raised Flooring** — Stainless steel or encapsulated aluminum (solid and perforated panels), see page 8.
- **Contamination-Control Floor Coverings** — remove even the finest particles of foot-borne contamination simply and effectively, without tacky carry-over. The renewable polyester-compound surface, available in blue or gray, holds up to years of use and can be cleaned with standard cleaning solutions (general purpose and bactericides available from Terra). Call for a quotation for your facility.
- **Other Solutions:** Call to discuss your requirements of other floor materials.



**Static-Dissipative Clean-Zone  
Floor Covering, Cat. # 3801-16**



## Let Terra Help With —

### Engineering/Design

Engineers work closely with your technical staff at every phase, from design to final testing. Every cleanroom is assembled and tested before shipment to ensure that you receive a turnkey system, ready for operation.

### Installation

Our trained technician teams erect and test your system at your facility, to your schedule.

### Certification and Compliance

**(ISO 14644 particle count, FDA, cGMP, USP <797>)**

Terra understands the performance criteria you face for certification and designs your system accordingly. We arrange third-party certifications, cleanroom audits, compliance training and SOP development, including viable and non-viable particle monitoring.

### Cleaning and Sterilization Services

In select regions, we arrange ongoing cleaning and sterilization programs, using ISO-certified micro-cleaning specialists working to the most rigorous cleanliness standards. Call to discuss your requirements.

# BioSafe™ All-Steel Cleanroom

## Cleaner Than Clean!

Terra provides an integrated processing environment to meet your most critical requirements, from pharmaceutical process validation to nanofiltration.

See page 5 for information on cleaning and certification services.

### VHP® Biodecontamination Systems

- Proven efficacy against a wide variety of microorganisms
- By-products are safe, environmentally friendly (water vapor and oxygen)
- Ideal for clean rooms, isolators, glove boxes and other enclosures
- Available in integrated or stand-alone, portable configurations



First-of-its-kind system removes nanocontaminants, including viruses and molecular DNA

### Vaporized Hydrogen Peroxide Decontamination Technology – The Proven Industry Standard

VHP® Biodecontamination systems are ideal for process validation in pharmaceutical and biological applications. They employ a four-stage operation cycle to ensure safe, effective decontamination of an enclosure:

- Dehumidification**—to reduce relative humidity and prevent condensation
- Condition**—rapid increase to the desired hydrogen peroxide vapor concentration
- Biodecontamination**—at the desired hydrogen peroxide vapor concentration
- Aeration**—to achieve rapid reduction of hydrogen peroxide vapor

The process is fully automated, and all cycle parameters are monitored and recorded for process validation.

Call Terra to discuss your application. Systems start at \$30,000.

### IonBar™ Ceiling Ionization Modules

- Eliminate surface static charges that attract and hold contaminants
- Intrinsically safe power system ensures balanced output of ion streams, generates no EMI or ozone
- Can be integrated into ceiling FFUs or retrofitted onto existing ceiling grids

Laminar air flow creates surface charges. Surface charges attract and hold particles. Terra's IonBar™ solves both problems.



See page 17

### Ionizing Blow-off Gun

This gun emits a burst of ionized air or nitrogen to safely neutralize surfaces. It also helps remove surface contaminants by eliminating static attraction. Designed for use with either filtered air or nitrogen at 12-30 psi. Includes 0.4-micron filter and transformer. Low-voltage operation (24V) is intrinsically safe and minimizes EMI/FRI.

Ionizing Air Gun	Cat. #	\$/Each
110VAC	2005-55	689.00
220VAC	2005-55-220	689.00
Capsule Filters (Replacement)		
0.04µm retention	2005-52	156.00
0.40µm retention	2005-53	107.00



## BioSafe™ All-Steel Designs

Complex Cleanrooms or Containment Labs with Modular Versatility and Economy

Terra's modular BioSafe™ Cleanrooms give you the flexibility to configure a floor plan and environmental controls to your requirements – without the high cost, long lead times, special permitting, and other project complexity associated with fixed installations.

Terra's unique panel design allows fast installation in existing facilities, even with tight wall clearances.

- Rigid double-wall steel panels require no external bracing
- Easy to integrate into existing HVAC system, or select optional A/C modules
- Smooth surfaces and coved corners for easy cleaning and disinfection

See following pages for more details and ordering information





Shown at right —  
316 Stainless Steel BioSafe™ Cleanroom,  
Configured for Bio-hazard Processing —

- Smooth interior surfaces with rounded corners for easy sterilization
- Raised, sloped flooring drains to disinfectant reclamation reservoir
- HVAC system maintains constant temperature between 60°F and 140°F
- Ceiling HEPA filter/fan units meet Class 100 cleanliness conditions
- Adjustable high-volume air handlers create negative pressure (-0.05" WG) to protect outside environment
- Polystyrene insulation enhances A/C efficiency and temperature stability
- Standard fluorescent, 254nm UV germicidal, and 365nm fluorescence detection lighting
- Wall-mount utilities: 120/240VAC power, water and gas



**316 BioSafe™ Cleanroom configured for Bio-hazard Processing**

# BioSafe™ All-Steel Cleanroom

**Terra's unique all-steel BioSafe Cleanrooms provide smooth surfaces, inside and out. They stand up to standard disinfectants and sterilization procedures and can be specified with anti-microbial surface coatings.**

The BioSafe Cleanroom creates a rigid, self-supporting structure without a separate frame or external bracing — a key advantage over competitor designs that require special permitting and contractor installation.

The modular design of these rooms makes them easy to assemble, disassemble, and reconfigure as needs change. The double-wall panels create a convenient installation zone for electrical conduit, gas and vacuum service lines, enhancing system cleanliness and appearance. In controlled temperature applications, this void can be insulated to optimize thermal stability and reduce energy costs.

The ceiling grid creates standard 2' x 4' bays for installation of Terra's standard HEPA or ULPA filter/fan units and lights, including UV sterilization and fluorescence detection modules. These rooms accommodate the full range of cleanroom configuration options, including air conditioning, dehumidification modules, and ventilation equipment (see sidebar below).



**Powder-Coated Steel BioSafe™ Cleanroom**



## The Bio-Safe Advantage – Standard Features

### Strong, Durable Materials

Select powder-coated cold-rolled steel, or 304/316 stainless steel panels and ceiling grid. Double-wall design creates a completely free-standing structure.

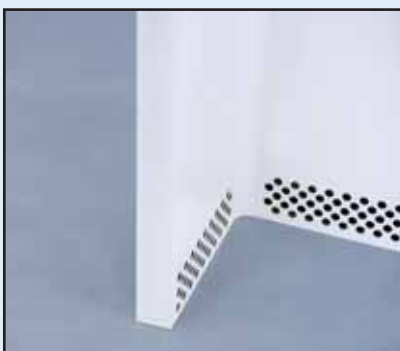

**Double-wall design provides smooth interior and exterior surfaces with rounded corners to minimize cracks. Noncontaminating gasket creates a smooth, cleanable surface (anti-microbial formulation available).**

### Smooth, Easy-Clean Surfaces

Panels are precision-joined to create ultra-smooth surfaces that are easy to wipe down and disinfect. Closed-cell, non-outgassing gaskets seal adjacent panels and eliminate cracks and voids that harbor germs and other contaminants. Radius corners further simplify cleaning.

### Double-Wall Panel Construction

Unique panel design creates strong, rigid structure without external bracing and accommodates flush-mount control panel and optional utilities – electrical outlets, gas and vacuum ports – without dirty, unsightly conduit.

### Modular, Versatile Design

The versatile Bio-Safe design accommodates most of Terra's standard cleanroom components:

- Filter/fan units** (page 16)
- Lights** (page 17)
- Access doors** (pages 3, 4)
- Pass-throughs** (page 20)
- Strip shields** (page 15)
- Ionizers** (pg 17)
- Fire Detection** (page 19)
- Gas and Vacuum Utilities** (page 19)

See facing page for other system options.



**Shown at left — 304 Stainless Steel BioSafe™ Cleanroom, 16'W x 12'D x 10'H. Base price: \$28,574.00 for panels, single access door and ceiling grid (no FFUs or lights). As shown: \$46,653.45, including —**

- Double-wall 304 stainless steel, precision-joined panels with smooth interior surfaces and rounded corners for easy cleaning and disinfection
- 304 stainless steel ceiling grid that forms 2' x 4' bays for filter/fans, lights and blank panels
- Three low-vibration, low-energy HEPA filter/fan units, producing a Class 100,000 (ISO 8) processing environment (upgradeable to Class 1/ISO 3)
- Three fluorescent light modules
- Double sliding doors (72"W x 96"H) with polycarbonate panels for introducing large equipment, and opposing double swing doors (72" x 80"H) for personnel entry
- 57,000 BTU AC system with SS return and distribution plenums to maintain constant sub-ambient temperature
- Seven polycarbonate viewing windows, two custom transfer ports

#### Ordering Information

Use the catalog numbers below to specify the material for your application. A Terra application specialist works with you to develop the floor plan, panel heights and other configuration details you require. Standard 7'-high panels create a room that fits beneath a standard 9' ceiling. Select access door(s), ceiling modules and other standard Terra cleanroom modules to complete your system (see inside cover for overview).



Terra's online **QuickQuote Planner** configures a room to your specifications: [www.TerraUniversal.com](http://www.TerraUniversal.com)  
Just click on [Modular Cleanrooms](#)

BioSafe	Cleanroom	Antechamber	Internal Wall
Panel/Grid Material	Cat. #	Cat. #	Cat. #
Powder-Coated CR Steel	<b>6600-30</b>	<b>6600-35</b>	<b>6600-40</b>
304 Stainless Steel	<b>6600-31</b>	<b>6600-36</b>	<b>6600-41</b>
316 Stainless Steel	<b>6600-32</b>	<b>6600-37</b>	<b>6600-42</b>

Windows (specify quantity, size, location)	
Material	Cat. #
Tempered Glass	<b>6600-45</b>
Fire-Rated Glass	<b>6600-46</b>
Static-Dissipative PVC	<b>6600-47</b>
Lexan® (Polycarbonate)	<b>6600-48</b>

## Specialized Configurations

### Anti-Microbial Panel Coating

This antimicrobial compound suppresses the growth of bacteria, mold, fungi and other microbes. It is ideal for biological and pharmaceutical applications, as well as food processing, medical device manufacturing, and other life-science operations. Surface coatings are available for powder-coated and stainless steel panels.

Coating for Stainless Steel Panels	<b>6600-50</b>
Coating for Powder-Coated Steel Panels	<b>6600-51</b>



### Raised Flooring

Encapsulated aluminum grated panels optimize laminar air flow. Solid aluminum panels can be sloped and covered with a washable liner in disinfectant spray applications. Drains and reclamation reservoirs are available; call Terra to discuss your application.

Raised Grated Panels (shown at left)	<b>6600-53</b>
Raised Solid Panels	<b>6600-54</b>

### Wall Insulation

Standard material is polystyrene foam. Order A/C Modules on page 19.

Cat. #  
**6600-55**

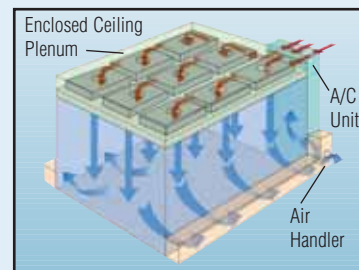

### High-Volume Air Handler

Converts any enclosure into a negative-pressure room that safely contains biological material, pharmaceutical powders, and other potential environmental hazards. See page 18 for specifications and ordering information.

# BioSafe™ Containment Room

The ideal enclosure for pharmaceutical handling —

- ✓ Purity testing
- ✓ Weighing
- ✓ Packaging
- ✓ Chemical analysis

- Recirculation module creates a HEPA-filtered clean zone
- Rear-mounted air vents draw air and powders away from operator and work area
- Rear manifold recirculates air through inlet HEPA filters to ensure a continuous wash of particle-free air to the work area
- Air conditioning and dehumidification modules maintain precise environmental conditions
- Broad access area, with parting vinyl strip shields, allows easy access, even pallet loading of large containers
- BioSafe™ all-steel construction ensures a strong, free-standing structure that is easy to clean and sterilize (see page 8)
- Add ceiling filter/fan units to meet cleanroom conditions throughout the room
- Available in 304/316 stainless or powder-coated steel

Terra's Powder Containment Room combines many benefits of a modular cleanroom and biological safety cabinet, including a filtration system that maintains cleanliness levels to Class 10 (ISO 4).

Unlike conventional cleanrooms, it features a versatile air handling system that lets you configure the working space for your requirements.

**Neutral Pressure Room: 100% Air Recirculation (Fig. A)**  
Configured as a neutral pressure room, this system ensures 100% recirculation of exhausted air and complete protection of the external environment.

An outlet filter/blower module recessed in the wall at the rear of the processing area draws air away from the operator into dual HEPA outlet filters, which contain any airborne chemical powder. These filters can be discarded or processed for chemical reclamation.

Outlet air then passes through a make-up air duct and back into the ceiling filter/fan unit mounted on the ceiling. Filtered air flows downward from above the work area at a speed of about 90 feet/minute, in accord with cleanroom standards.

## Modular Design Adjusts for Your Requirements —

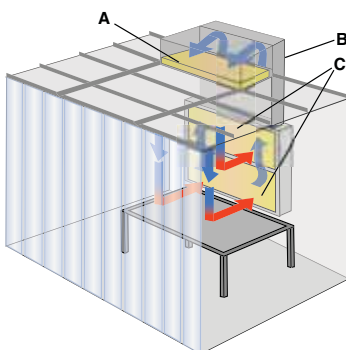

**Fig. A. Neutral Pressure Room: Protects Outside Lab**

CleanZone Recirculation System creates a HEPA-filtered clean zone that captures hazardous powders, protecting the external environment.

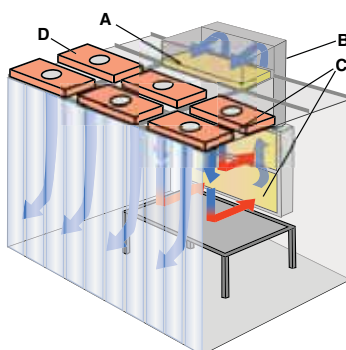

**Fig. B. Positive Pressure Room: Protects Product**

Addition of ceiling HEPA filter/fan units creates a positive pressure of filtered air to prevent airborne contaminants from entering the access area.

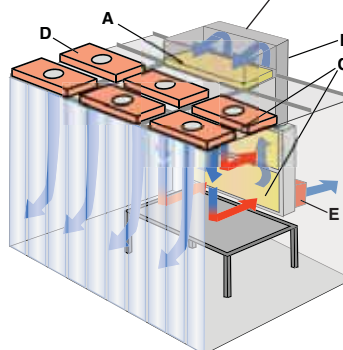

**Fig. C. Negative Pressure Room: Protects Personnel**

Optional Air Handling Module expels air to create a negative pressure that pulls air away from the personnel. Operates with or without ceiling FFUs.



## Positive Pressure Room: Filter/Fan Units (Fig. B)

This additional protection optimizes product purity by controlling airborne aerosols, microbes, and other submicron particles.

Ceiling filter/fan units (FFUs) create a positive pressure inside the room that blocks the inrush of contaminants. FFUs can be positioned at the access area to form a contamination barrier, or uniformly throughout the ceiling grid to create laminar airflow (see inside cover for recommended configurations).

## Negative Pressure Room: Exhaust Ventilation (Fig. C)

For additional protection of personnel inside the room, the CleanZone Recirculation System lets you adjust the percentage of air recirculated into the containment room.

By exhausting a portion of the air drawn into the filtration system, you create a negative pressure that pulls air away from the operator. A flanged adapter panel, either with or without adjustable damper, lets you duct exhausted air to an in-house ventilation system. Terra's Air Handling Modules include a high-volume fan and filter for ductless ventilation.

CleanZone Air Return (see photo at right)

- ➡ HEPA-Filtered Air
- ➡ Contaminated Air

- A\* 99.99% efficient HEPA filter/fan unit
- B\* Return duct directs air flow away from operator
- C\* Exit HEPA filters
- D Filter/Fan Units – create positive pressure of filtered air (order separately)
- E Air Handler – exhausts air to create a negative pressure (order separately)
- \* Standard component of CleanZone System

# BioSafe™ Containment Room



**Powder-coated steel Powder Containment Room equipped with full-width strip shields**

See page 4 for other door options.



**304 Stainless Steel Powder Containment Room, shown with optional Magnehelic® Differential Pressure Gauge**

## Ordering Information

Use the catalog numbers below to indicate the cleanroom material for your application. Each system includes a BioSafe™ all-steel room manufactured to the floor plan you specify, including ceiling grid. Select one or more CleanZone Recirculation Systems (see specifications). Unless otherwise specified, this system is mounted at the center wall opposite the access opening, with filters mounted 33" above floor. Specify multiple zones for larger rooms.

A four-foot opening on the shorter wall accommodates one of Terra's standard door options – refer to page 3 for swing doors and page 15 for strip shields. Standard height is 7' from filter face to floor (8'3" overall, including filter/fan units), allowing placement beneath standard 9' ceilings. Indicate other desired heights.



**Rear-mount manifold draws air away from work area into ceiling HEPA filter unit**



Terra's online **QuickQuote Planner** configures a room to your specifications:  
[www.TerraUniversal.com](http://www.TerraUniversal.com)  
 Just click on [Modular Cleanrooms](#)

## Powder Containment Booth

Powder-Coated Steel	Cat. #	<b>6600-75</b>
304 Stainless Steel		<b>6600-76</b>
316 Stainless Steel		<b>6600-77</b>

## CleanZone Recirculation System

Includes exhaust filter housing, ductwork, and FFU adapter collar, and adjustable fresh air damper. Order outlet filters (2) and FFU separately.	Cat. #	\$/Each
	<b>6600-84</b>	<b>1,639.00</b>

## Outlet HEPA Filter

Two required per CleanZone Module	Cat. #	\$/Each
	<b>1681-02</b>	<b>220.00</b>

## CleanZone Recirculation System Specifications

Power: 115VAC, 50/60Hz; 230VAC (50Hz also available)  
 Airflow: 650 CFM (with HEPA filter)  
 Filters: (2) 99.99% efficient HEPA, 27" x 13" x 2"  
 (rated @ 0.3µm particle diameter)  
 Exhaust Manifold: Aluminum with 304 stainless steel trim

**DIGIHELIC® Differential Pressure Gauge, See page 18**

**Filter/Fan Units, See page 16**

## Exhaust Flange Adapter Panel

3" stainless steel flange available in several diameters to allow connection of exhaust duct. Select model with damper to adjust airflow.

Diameter:	With Damper		Without Damper	
	Cat. #	\$/Each	Cat. #	\$/Each
6"	<b>6600-78</b>	<b>270.00</b>	<b>6600-81</b>	<b>307.00</b>
12"	<b>6600-79</b>	<b>288.00</b>	<b>6600-82</b>	<b>325.00</b>
18"	<b>6600-80</b>	<b>304.00</b>	<b>6600-83</b>	<b>339.00</b>

**Air Handling Module, See page 18**

Selection Guide

Hardwall Plastic

All-Steel BioSafe™

Powder Containment

Softwall Plastic

Accessories

Gowning Products

# Softwall Cleanrooms

**Terra's Softwall Modular Cleanrooms provide an economical, versatile solution to clean manufacturing requirements in semiconductor, medical device, and many other industries. Portable, expandable, and easy to assemble/disassemble, these cleanrooms are also available on an accelerated delivery program to meet your tight production schedule!**

**Unlike other modular cleanrooms on the market which require complex suspended ceiling supports, Terra cleanrooms are completely free-standing structures.**

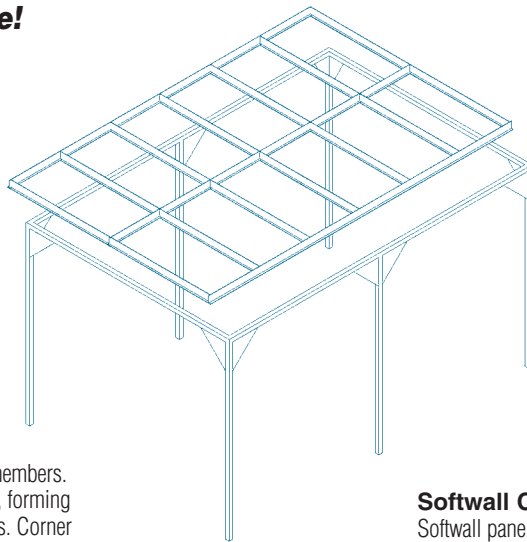

### Softwall Support Frame

The support frame is fabricated of interlocking 2½" powder-coated square steel uprights, cross sections, and ceiling members. Ceiling members are welded to steel T-bars, forming the 2' x 4' bays that support filters and lights. Corner reinforcement gussets ensure a rigid structure. Optional heavy-duty casters allow easy repositioning after installation. Standard height is 7' measured from filter face to floor (8' 3" overall), allowing installation below a standard 9' ceiling.

**Note:** Walls over 8' long require an additional vertical support member.



**Any size or floor plan!**



### Softwall Curtains & Strip Shields

Softwall panels are fabricated of heavy-duty, blur-free 40 mil material—double the industry standard—ensuring enhanced tear resistance and eliminating the need for unsightly sewn sash weights. Strip shields, made of 60-mil material, come standard in 8" widths, with 2" overlap, for easy entrance or exiting. Polyurethane shields are 12"W, 40 mil thick.

Curtains and strips are available in three materials, in either clear or frosted appearance. See pg. 15 for ordering information.

## Ordering Information

Use the catalog numbers below to specify the cleanroom style for your application. Based on your desired floor plan, a Terra application specialist will quote you on a room configured for your application.

### Frame Kit

Includes a powder-coated steel frame of the dimensions you specify. Standard height is 7'; other heights available. Walls over 8' long require an additional vertical support member. Includes a control panel for operation of filter/fan units, lights, and other selected options.

Powder-Coated Steel  
304 Stainless Steel

Cat. #  
**6600-60**  
**6600-61**

### Softwall Curtains and Strip Shields

Order curtains and strip shields from pages 14 - 15. Curtain material is 40-mil thick, clear PVC (anti-static PVC and polyurethane curtains also available). For access doors, select alternating clear and frosted strip shields, which eliminate cling for easy parting.

For 7'-high cleanroom, curtain length of 6'6" is recommended to allow adequate air exhausting. See formula on facing page for more information.



Terra's online **QuickQuote Planner** configures a room to your specifications: [www.TerraUniversal.com](http://www.TerraUniversal.com)  
Just click on [Modular Cleanrooms](#)

### Recommended Filter/Fan Configurations

Nominal Dimensions	No. of Ceiling Bays	No. of Filter Modules to meet Fed Std 209 Class Standards					
		1	10	100	1,000	10,000	100,000
8' x 8'	8	5 - 8	4 - 8	3 - 6	2 - 3	1 - 2	1
8' x 12'	12	7 - 12	6 - 12	4 - 8	3 - 5	2 - 3	1 - 2
8' x 16'	16	10 - 16	8 - 16	6 - 11	4 - 6	2 - 4	1 - 3
12' x 12'	18	11 - 18	9 - 18	6 - 13	5 - 7	3 - 5	1 - 3
12' x 16'	24	14 - 24	12 - 24	8 - 17	6 - 10	4 - 6	2 - 4
16' x 16'	32	19 - 32	16 - 32	11 - 22	8 - 13	5 - 8	2 - 5
20' x 20'	50	30 - 50	25 - 50	18 - 35	13 - 20	8 - 13	3 - 8

### Cleanroom accessories begin on page 16

- Filter/Fan Units – HEPA/ULPA, low noise & vibration
- Lighting – fluorescent, teardrop, flow-through, UV
- Ionizing Modules – control ESD
- Ceiling Ventilation Modules – for negative-pressure applications

### Other Modular Cleanroom Styles

- Hardwall Plastic Cleanrooms – see page 2
- BioSafe™ All-Steel Cleanrooms – see page 6
- BioSafe™ Powder-Containment Rooms – see page 10

**USP <797> compliant models for sterile compounding—page 40**

# Softwall Options



To order curtains, see next page.

**Cleanroom-Grade Vinyl** is non-particulating and low outgassing.

**Static-Dissipative Vinyl** is manufactured with permanent built-in static inhibitors that will not wear off.

**Non-outgassing Panels** are made from inherently static-dissipative polyurethane that provides permanent, humidity-independent ESD protection for sensitive manufacturing conditions. Polyurethane contains no plasticizer, making it non-outgassing.

Softwall panels and strip shields attach to the support frame by means of a unique noncontaminating Grip-Track™ mounting system that eliminates cracks and seams where germs or particles can collect. Other mounting systems are available.

**Note:** Softwall curtains are notched to ensure a snug fit at all corners. In standard installations, curtains are supplied in lengths of four feet. Where two curtains join, the curtain panels overlap by 6". To prevent personnel from parting curtains at these seams, order optional curtain seaming, Dual-Lock Velcro®, magnetic closures, or attachment clips at right. See following pages for more information.

## Strip Doors

Strip shields can be ordered in convenient widths to create access doors for softwall or hardwall cleanrooms. By alternating strips of clear vinyl with frosted vinyl, you eliminate both sticking and air gaps, creating entrances that are cleaner and easier to walk through.

**Note:** Strip doors are free-hanging—standard installations do not include attachment of the two sides to adjacent curtains or frame.



## IonBar™—

### for a cleaner cleanroom

Eliminates surface charges that attract particles. See page 17.

## Casters

Stainless steel swivel casters feature nonshedding polyurethane wheels. Capacity: 300 lbs. each. Order one per vertical post. Price includes installation.

	Cat. #	\$/Each
6"-diameter locking caster (Raises cleanroom 7 <sup>3</sup> / <sub>16</sub> "")	6704-08	96.00



## Dual-Lock Velcro® Strips

For sealing curtains or strip shields to frame supports or overlap areas, Terra offers non-particulating, clear 3M Dual-Lock Velcro® with plasticizer-resistant adhesive. These strips are ideal for application along the vertical frame uprights or along the vertical length of a curtain or strip, allowing corner or overlap attachment that minimizes air leaks. Price includes sewing of mating strips to specified curtains. Use quantity to specify desired number of feet.

	Cat. #	\$/Linear ft.
Dual-Lock Strip	6704-05	10.00

## Flexible Magnet Strip Self-Closures

Flexible, chemical-resistant magnet strips are ideal for a variety of custom closure needs. Price includes sewing to specified curtain. Use quantity to specify desired number of feet.

	Cat. #	\$/Linear ft.
Magnet Closure	6704-06	10.00

## Snap-Tite™ Clips

Ideal for securing two curtains together. Each two-piece plastic clip snaps together through holes in the curtains.

	Cat. #	\$/2-piece set
	6704-07	1.00

## Curtain Seaming

For RF seaming of specified curtain panels.

	Cat. #	\$/Each
	6600-65	23.00

See following pages for other closures and fastening options!

## Adjustable Uprights

Allow up to 18" vertical height adjustment during installation. For rooms up to 8' x 8' only.

	Cat. #	\$/Upright
8' Upright	6600-66	300.00

## Selecting the proper panel length

All softwall cleanrooms require some gap between the curtain and the floor to allow air to escape. If this gap is too narrow to accommodate the flow of air generated by the ceiling filter fans, then curtains and strips will billow outward. If it is too big, the cleanroom will not maintain adequate positive pressure.

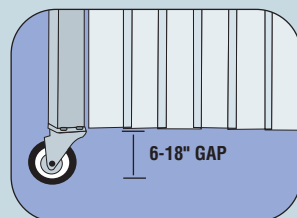

In general this formula helps you determine how long the curtains should be:

$$\text{Gap between curtain and floor} = \frac{\text{Total surface area of filters in ceiling grid}}{\text{Perimeter of cleanroom}}$$

For a 16' x 16' cleanroom with 7 ceiling filter fans, this gap should be about 10.5" (56 sq. ft. of filter ÷ 64 ft. (perimeter) = .875 ft. gap). This is exactly the gap produced when a 6' curtain is installed on a standard cleanroom frame, since the curtain bead is mounted about 1.5" below the filter face (6'10.5" above the floor). If the same cleanroom included casters, which raise the cleanroom about 7", then a 6'6" curtain would be appropriate.

Refer to curtain ordering chart on the following pages to select the curtain height for your application. The plastic curtain material is easy to trim to the exact size you require.



- Grip-Track™ opens and closes without tools for easy panel mounting.
- Smooth profile in closed position won't harbor contaminants
- Cleaner, easier than Velcro®

# Softwall Curtains/Strip Shields

- Industry-leading fabrication and mounting technology gives you the cleanest, most durable curtains and strip panels available
- Ideal for creating partitions inside a hardwall or softwall enclosure
- Suitable for all classes of cleanrooms and all levels of process isolation
- Available in three materials, including nonoutgassing, static-safe polyurethane
- Standard one-piece Grip-Track™ mounting system is easy to clean, eliminates exterior crevices where contaminants can collect
- Heavy-gauge materials hang straight, without the need for sewn hems or cumbersome sash weights
- T-Grid Mounting System allows suspension of curtains or strip shields from existing cleanroom T-grids
- Many additional configurations available, including other colors, thicknesses and strip shield widths—call Terra with your requirements!

These softwall curtains and strip shields are ideal for use with Terra's free-standing Softwall Cleanrooms on the previous pages. They can also be installed directly onto existing walls or ceilings using the versatile Grip-Track™ mounting system.

Either way, you receive the cleanest, most durable panels available. Standard softwall curtains are fabricated of heavy-duty, blur-free 40 mil material—double the industry standard—ensuring enhanced tear resistance and eliminating the need for unsightly sewn sash weights. Strip shields, made of 60 mil vinyl, come standard in 8" widths, with 2" overlap, to form parting doors or reach-throughs. Polyurethane shields are 40 mil x 12" W.

Select the panel material to meet your application requirements. Cleanroom-Grade Vinyl is low-outgassing. Static-Dissipative Vinyl adds permanent built-in static inhibitors that, unlike topical treatments, will not wear off. Tests performed per ASTM D257 show surface resistivity of  $1.8 \times 10^{10}$  ohms/sq.

Terra also offers panels made from static-dissipative polyurethane that provides permanent, humidity-independent ESD protection from sensitive manufacturing conditions. This material contains no plasticizer, making it virtually non-outgassing.

## Ordering Guide

Select the height and material desired for flexible curtain panels. Pricing is per linear foot. Use quantity to indicate the length in feet of the curtain or strip panel (e.g., quantity 8 = an eight-foot run of material of the specified height). Grip-Track™ mounting is standard; specify any other desired mounting system (see top of facing page).

**When ordering with Terra's Softwall Cleanroom**, provide a drawing that shows the nominal dimensions and floor plan of your cleanroom. If you select curtain panels, indicate the location and width of any desired access door.

Based on your drawing, Terra will configure the optimal curtain placement. On a standard basis, an access door, made of alternating clear/frosted strip shields of the curtain panel material specified, will be installed at the location you indicate.

## Please note these construction details:

- Standard curtains come in 4-foot long panels, which are mounted to create the run specified.
- Corners are notched to ensure a snug fit against frame corners.
- Adjacent panels overlap by 6", which generally provides an adequate air barrier.

**Clear Panels**—Grip-Track™ mounting system included in all softwall cleanrooms.



*Other Colors (including black and amber), thicknesses and heights available. Call with your requirements!*

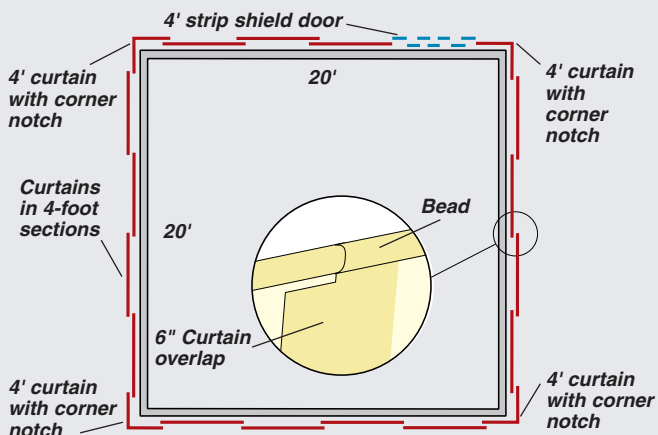

Typical configuration for a 76-foot run of panels, plus a 4-foot strip shield door

Quantity indicates run of curtain (e.g., 10 feet of 6'H curtain=(10) x Cat. # 1320-02A)

Height	40 mil Clear Softwall Curtain Panels					
	Vinyl		Anti-Static Vinyl		Polyurethane (non outgassing)	
	Cat. #	\$/Linear Ft.	Cat. #	\$/Linear Ft.	Cat. #	\$/Linear Ft.
4'	1320-00A	21.00	1320-12A	26.00	1320-24	72.00
5'	1320-01A	22.00	1320-13A	30.00	1320-25	83.00
6'	1320-02A	24.00	1320-14A	33.00	1320-26	94.00
6' 6"	1320-03A	26.00	1320-15A	36.00	1320-27	98.00
7'	1320-04A	26.00	1320-16A	39.00	1320-28	105.00
7' 6"	1320-05A	29.00	1320-17A	40.00	1320-29	109.00
8'	1320-06A	30.00	1320-18A	42.00	1320-30	114.00
8' 6"	1320-07A	30.00	1320-19A	44.00	1320-31	120.00
9'	1320-08A	32.00	1320-20A	46.00	1320-32	124.00
9' 6"	1320-09A	32.00	1320-21A	48.00	1320-33	131.00
10'	1320-10A	33.00	1320-22A	50.00	1320-34	135.00



# Mounting Systems

**Grip-Track™ mounts are included for all panels listed below. Call Terra for pricing on other mounting systems.**



**Cleaner & easier than Velcro® style mounting**

## Grip-Track™ (standard)

Eliminates all cracks and crevices where dust & germs can collect. One-piece mounting track, made of rigid white polyethylene, incorporates flexible hinge and bottom flanges. Snaps open and shut for quick, easy assembly. Compatible with T-Grid Mount for use with existing ceiling T-grids. Non-corrosive and easy to clean.

Cat. #                      \$/Linear Ft.  
Replacement Grip-Track™ **1322-60**      **8.00**

**Smooth profile in closed position won't harbor contaminants**

## Suspended T-Grid Mount

Available for the Grip-Track™, the T-Grid mount allows suspension of a curtain from standard T-grid ceiling without the need for ceiling disassembly. Perfect for partitioning a hardwall or softwall cleanroom into multiple clean zones, or for establishing temporary isolation areas!

Cat. #                      \$/Linear Ft.  
For 2" Ceiling Grid Supports **6704-23A**      **3.00**  
For 1.5" Ceiling Grid Supports **6704-24A**      **3.00**

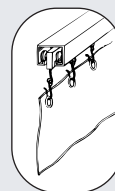

## Bi-Folding Curtain Mount

Available in anodized aluminum or stainless steel, this system allows softwall curtains to be easily retracted or extended along a heavy-duty, smooth rolling track. Contact Terra for ordering information.

## Closures

See page 13 for several ways to fasten curtains and strips together or to attach either to a vertical frame, thereby minimizing air leaks and preventing personnel from using overlaps as entries.

## Curtain Seaming

For RF seaming of specified curtain panels.  
Cat. #                      \$/Seam  
**6600-65**      **23.00**

## Clear Strips



Garments courtesy of W. L. Gore & Associates

## Alternating Clear and Frosted Strips



**Perfect for Access Doors!**

For 4'-wide access panel, specify quantity (4) of desired height.

Height	Clear Strip Shields: 60 mil x 8"W (2" overlap)						Alternating Clear/Frosted Strip Shields: 60 mil x 8" (2" overlap)					
	Vinyl 60 mil x 8"W		Anti-Static Vinyl 60 mil x 8"W		Polyurethane (non outgassing) 40 mil x 12"W		Vinyl 60 mil x 8"W		Anti-Static Vinyl 60 mil x 8"W		Polyurethane (non outgassing) 40 mil x 12"W	
	Cat. #	\$/Linear Ft.	Cat. #	\$/Linear Ft.	Cat. #	\$/Linear Ft.	Cat. #	\$/Linear Ft.	Cat. #	\$/Linear Ft.	Cat. #	\$/Linear Ft.
4'	1320-36A	26.00	1320-48A	39.00	1320-61	78.00	1320-73A	29.00	1320-85A	40.00	1320-97	84.00
5'	1320-37A	30.00	1320-49A	42.00	1320-62	91.00	1320-74A	32.00	1320-86A	45.00	1320-98	96.00
6'	1320-38A	33.00	1320-50A	47.00	1320-63	105.00	1320-75A	34.00	1320-87A	50.00	1320-99	110.00
6' 6"	1320-39A	34.00	1320-51A	50.00	1320-64	111.00	1320-76A	37.00	1320-88A	52.00	1321-00	116.00
7'	1320-40A	37.00	1320-52A	52.00	1320-65	117.00	1320-77A	39.00	1320-89A	54.00	1321-01	122.00
7' 6"	1320-41A	39.00	1320-53A	53.00	1320-66	122.00	1320-78A	40.00	1320-90A	56.00	1321-02	130.00
8'	1320-42A	40.00	1320-54A	55.00	1320-67	130.00	1320-79A	41.00	1320-91A	57.00	1321-03	135.00
8' 6"	1320-43A	41.00	1320-55A	57.00	1320-68	135.00	1320-80A	44.00	1320-92A	61.00	1321-04	142.00
9'	1320-44A	44.00	1320-56A	61.00	1320-69	142.00	1320-81A	45.00	1320-93A	64.00	1321-05	149.00
9' 6"	1320-45A	45.00	1320-57A	63.00	1320-70	147.00	1320-82A	47.00	1320-94A	66.00	1321-06	156.00
10'	1320-46A	47.00	1320-58A	65.00	1320-71	155.00	1320-83A	48.00	1320-95A	68.00	1321-07	162.00

# Ceiling Modules

## Interchangeable Ceiling Modules

The following pages provide ordering information on Filter/Fan Units (FFUs), Fluorescent Light Modules, Ceiling Panels, and Ionizing Bars, which are installed on the cleanroom ceiling T-grid.

Refer to the "Application Guidelines" on inside cover for recommendations on quantities to meet requirements for cleanliness and lighting.

## Power Distribution Modules

Dramatically simplify connection of ceiling-mount devices to your electrical system and allow centralized operation at a single control panel. Each accommodates up to five lights and five FFUs and provides complete overload protection. Price includes installation using NEC-compliant connections.

Cat. # \$/Each  
6600-29 520.00

## Low-Energy Filter/Fan Unit (FFU)

- Provides industry-leading performance in three critical areas: low energy, low noise and low profile
- Runs at only 160 watts (@ 90 FPM) for low operating costs
- Quiet, low-vibration design: only 48 dBA, measured 30" from filter face @ 90 FPM
- Low-profile design allows installation of a 7'-high cleanroom beneath a standard 9' ceiling
- Provides an average air flow velocity of 90 feet per minute (.45 m/sec) and air flow of 640+ CFM under filter load, per cleanroom standards (2' x 4' model)
- Three-speed switch (on 2' x 4' models) provides low, medium and high settings
- Meets IEST Recommended Practices

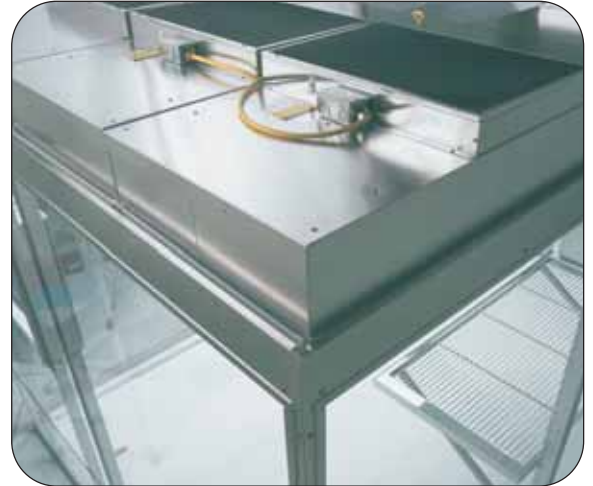

*Now with integrated IonBar™ for cleaner performance. See page 17.*

These reliable, self-powered Filter/Fan Units provide a reliable flow of microfiltered air to meet cleanliness standards down to Class 1 (ISO 3). See inside front cover for filter application guidelines.

Patented baffling technology ensures uniform airflow across the filter face and attenuates sound for the lowest noise level in the industry: approximately 48 dBA. Select HEPA (High-Efficiency Particulate Air) filters, rated 99.99% efficient @ removal of particles 0.3µm and larger, or ULPA (Ultra-Low Penetration Air) filter, rated 99.9995% efficient @ removal of particles 0.128µm and larger.

The durable aluminum lid and body features a snap-in prefilter, for easy replacement and maintenance, and a walkable plenum design (excluding prefilter). The 2 x 4 models use a 3-speed, 1/5#HP centrifugal-type fan/motor with permanently lubricated bearings. Other sizes use a speed control for a full range of settings.

## Specifications

Full-Load Amp: 3.0 (for 120V, 60Hz, 1 phase); 1.5 (for 220V, 50/60Hz, 1 phase)  
Wattage Rating @ 90 fpm (0.45 m/s) – see chart below for other wattage ratings  
2 x 4 Models: 160 Watts @ 90 fpm, 60Hz (145 @ 50Hz)  
2 x 3 Models: 140 Watts @ 90 fpm, 60Hz (113 @ 50Hz)  
2 x 2 Models: 72 Watts @ 90 fpm, 60Hz (67 @ 50Hz)  
To calculate sensible heat (in BTUH), multiply watts by 3.412 (e.g., for a 2' x 4' unit, at low speed, 170W x 3.412 = 580 BTUH)

All prices are for turnkey systems and include wiring and panel-mount on/off control. Gel-sealed, DOP-tested, and CE marked units available; call Terra for pricing.

## Filter Fan Units (HP: high speed; MS: medium speed; LS: low speed)

Model	Dimensions Inches (mm)	Weight Lbs. (Kg)	Avg. CFM CFM (m³/hr)	Airflow ft/min (m/s)			Watts @ 60Hz (50Hz)			Power	With HEPA Filter		With ULPA Filter	
				HS	MS	LS	HS	MS	LS		Cat. #	\$/Each	Cat. #	\$/Each
2 x 4	23.63 x 47.63 x 12.51 (600 x 1210 x 318)	65 (29)	644 (1095)	140	120	100	317	244	170	120VAC, 50/60Hz 220VAC, 50Hz	6701-99A	765.00	6702-01A	884.00
							(256)	(186)	(145)		6701-99A-220	765.00	6702-01A-220	884.00
2 x 3	23.63 x 35.63 x 12.51 (600 x 905 x 318)	52 (24)	477 (811)	188	N/A	N/A	294	N/A	N/A	120VAC, 50/60Hz 220VAC, 50Hz	6702-08A	765.00	6702-12A	875.00
							(248)	N/A	N/A		6702-08A-220	765.00	6702-12A-220	875.00
2 x 2	23.63 x 23.63 x 12.51 (600 x 600 x 318)	41 (19)	310 (527)	260	N/A	N/A	286	N/A	N/A	120VAC, 50/60Hz 220VAC, 50Hz	6702-10A	765.00	6702-13A	875.00
							(224)	N/A	N/A		6702-10A-220	765.00	6702-13A-220	875.00

## Ceiling Ventilation Modules

These ventilation modules convert any Terra modular cleanroom into a negative-pressure ventilation room. They are ideal for operations that generate chemical fumes or airborne contaminants. Exhausted air can be ducted or filtered for release.

Select HEPA/ULPA filters for removal of fine powders and other particles. If ducting is required, specify flange size. Based on your room size and ventilation requirements, a Terra application specialist will help you select the size and quantity of modules below to provide effective ventilation.

Ceiling Ventilation Modules			Corresponding Exit Filters							
Air Flow		Motor Size	120VAC, 60Hz		220VAC, 50/60Hz		HEPA Filter		ULPA Filter	
@ 0" SP	@ 1" SP		Cat. #	\$/Each	Cat. #	\$/Each	Cat. #	\$/Each	Cat. #	\$/Each
2,230 CFM	1,642 CFM	1 HP	6600-70	1,286.00	6600-70-220	1,286.00	1681-02	220.00	1681-10	298.00
3,361 CFM	2,817 CFM	1.5 HP	6600-71	1,538.00	6600-71-220	1,538.00	1681-02	220.00	1681-10	298.00
5,768 CFM	4,117 CFM	2 HP	6600-72	1,791.00	6600-72-220	1,791.00	1681-02	220.00	1681-10	298.00

# Ceiling Modules

## Cleanroom IonBar™

- Provides a continuous stream of static-neutralizing ions to protect sensitive materials against ESD
- Attaches to cleanroom ceiling T-grid without disrupting the laminar flow in the cleanroom
- Eliminates surface charges that attract and hold particles
- Low-voltage design is safe, minimizes EMI/RFI

The Ionizing Bar generates a balanced stream of positive and negative ions to neutralize surface static charges, safeguarding ESD-sensitive materials.

State-of-the-art technology makes it one of the most reliable ionizers available. It emits equal numbers of positive and negative ions and requires no calibration or adjustments.

### Specifications

Input: 24 VAC, (transformer included with IonGrid™), Power Indicator: Red LED, Air flow: 60 fpm (.045 m/s) required at bar for proper operation



*Eliminates surface charges generated by laminar flow for a cleaner cleanroom*

IonGrid™ Ionizing Filter/Fan Unit*					IonBar™ for OEM Applications**			Transformers			
HEPA Filter/Fan Unit with IonBar™					Order transformer separately			Included with IonGrid Ionizing FFUs			
115VAC		220VAC			Length	Cat. #	\$/Each	110VAC		220VAC	
W x D	Cat. #	\$/Each	Cat. #	\$/Each				Cat. #	\$/Each	Cat. #	\$/Each
2' x 4'	6701-97	1,403.00	6701-97-220	1,403.00	22"	2005-06A	461.00	2005-09A	34.00	2005-09A-220	45.00
2' x 3'	6701-95	1,315.00	6701-95-220	1,315.00	33"	2005-16A	563.00				
2' x 2'	6701-93	1,225.00	6701-93-220	1,225.00	44"	2005-07A	663.00				

\* Includes IonBar™ installed beneath HEPA FFU (see specifications on previous page). ULPA filters available.

\*\* Air flow required for effective operation.

## Fluorescent Lights

- Make it easy to configure the optimal lighting for your application
- Select 2 x 4 ceiling module for placement in the ceiling grid, or Teardrop Lights for installation below the grid
- Flow-Through units are ideal with dense FFU ceiling coverage

### A. 2' x 4' Ceiling Module

This 2' x 4' painted steel housing includes four fluorescent light tubes, providing 4,560 foot candles. Price includes installation (specify desired location when ordering).

### B. Teardrop Lights

Ideal for Class 1 or Class 10 cleanrooms, in which near-100% filter coverage of the ceiling leaves no space for standard fluorescent light modules. Aerodynamic design ensures minimal interference of the laminar airflow. Dimensions: 48"L x 2"D x 6"H. Price includes installation (specify desired location when ordering).

### C. Flow-Through Module (not shown)

Low-profile, fluorescent-tube module stacks beneath a 2' x 4' FFU. Adds 4 1/4" to ceiling height. Intensity: 3,150 foot candles.

### Easy-Clean Light Guard

Fits beneath any 2' x 4' ceiling fixture to allow easy cleaning with most disinfectants. Transparent Lexan® (polycarbonate) panel transmits virtually 100% of light. Includes chemical-resistant, noncontaminating gasket.

Cat. #	\$/Each
3800-25	142.00



Ordering Information		Fluorescent Illuminators			
Module Type	Intensity (Foot candles)	115VAC, 60Hz		277VAC, 60Hz	
		Cat. #	\$/Each	Cat. #	\$/Each
A. 2' x 4' Ceiling Module	4,560	3800-80	198.00	3800-80	198.00
B. Teardrop Light (48"L)	1,260	6704-15	286.00	6704-15	286.00
C. 2' x 4' Flow-Through Module	3,150	6704-77	960.00	6704-77-277	975.00

### Germicidal UV Illuminator

2' x 4' fixture contains four 254nm UV tubes for germicidal control. Operates on 115VAC or 277VAC, 60Hz power.

Cat. #	\$/Each
3800-26	527.00

### Fluorescence-Detection UV Illuminator

2' x 4' fixture contains four 365nm UV tubes for fluorescence detection. Operates on 115VAC or 277VAC, 60Hz power..

Cat. #	\$/Each
3800-27	472.00

Yellow filters available; call for pricing

## Ceiling Panels

- Cover unused 2' x 4' bays in the ceiling grid
- Each panel seals against gaskets included in the grid frame

	Cat. #	\$/Each
Clear Acrylic	6704-19	56.00
Clear Static-Dissipative PVC	6704-21	85.00
White Polypropylene	6704-20	56.00
Stainless Steel	6704-79	85.00

# Cleanroom Accessories

## Cleanroom Dehumidification Modules

- Extends shelf life of pharmaceuticals, semiconductor components, food products, and other sensitive materials
- Provides the humidity stability required by FDA and other regulating agencies
- Regenerating silica gel desiccant system produces dry air flow between 50 and 300 CFM
- Horizontal-bed design provides the lowest dry air temperature and most desiccant/CFM of air in the industry
- Corrosion-proof 16 gauge steel and steel bed drive components extend service life

These low-maintenance systems feature silica gel desiccant housed in a rotor. Moisture in the process air passing through the rotor is adsorbed, producing a flow of dry air. Concurrently, reactivation air is heated and passed through the rotor to regenerate the silica gel and ensure continuous operation. The humid regeneration air is then ducted outside the cleanroom.

Select among three sizes to suit your air flow requirements. All feature 16-gauge zinc-coated steel housing. Desiccant material is 2-5 mm spherical silica gel.



Adsorption Rate	No. 6710-60	No. 6710-61	No. 6710-72
70°F @ 50% RH	1.1 lbs./hr.	3.3 lbs./hr.	6.6 lbs./hr.
70°F @ 30% RH	0.8 lbs./hr.	2.5 lbs./hr.	5.0 lbs./hr.
70°F @ 10% RH	0.3 lbs./hr.	0.9 lbs./hr.	1.8 lbs./hr.

### Cleanroom Dehumidification Modules (240/3/60 and 480/3/60 voltages also available)

Dimensions (W x D x H, inches)	Process Air Flow	Reactivation Air Flow	Weight	Full Load Amps	Reactivation Heat	Power Consumption	Voltage	Cat. #	\$/Each
29.75 x 15.25 x 22	50 CFM	15 CFM	85 lbs.	12	3,240 BTUH	1,400 Watts	120/1/60	6710-60	3,289.00
36.375 x 24.5 x 27.25	150 CFM	45 CFM	190 lbs.	18	9,725 BTUH	3,850 Watts	240/1/60	6710-61	5,076.00
44.5 x 33.25 x 32.25	300 CFM	90 CFM	300 lbs.	32.9	19,448 BTUH	6,900 Watts	240/1/60	6710-62	7,620.00

## High-Volume Air Handlers

- Adjustable high-volume fan allows precise regulation of pressure inside a cleanroom or other enclosure
- Optional filter (HEPA or ULPA) removes sub-micron powders and other particles to protect the external environment
- Ideal for operations with hazardous materials that require negative pressure inside the controlled environment
- Three standard sizes available

These high volume air handlers convert any enclosure into a negative-pressure room that safely contains biological materials, pharmaceutical powders, and other potential environmental hazards.

Typically, exhaust air from the laminar-flow cleanroom is passed to the air handler by means of take-up ducts (see illustration). By adjusting the high-volume fan, you can regulate the amount of air exhausted from and recirculated into the room to control the internal pressure. Recirculated air passes back into the room via a ceiling plenum chamber.

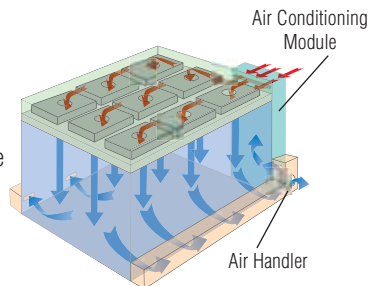

**B. Stainless Steel High-Capacity, HEPA-Filtered Air Handler**  
Provides a high-volume flow of HEPA-filtered air (3000 CFM average) for a wide range of critical environment applications. Rugged, stainless steel housing makes it suitable for outdoor locations. Includes 16"-dia. inlet/outlet flanges.

Cat. #	\$/Each	Cat. #	\$/Each
120VAC 6710-68	5,640.00	208VAC 6710-68-208	5,640.00



### DIGIHELIC® Differential Pressure Gauge

Monitors both positive and negative low air pressure inside a cleanroom (installed).

Pressure Range (in. WC)	Cat. #	\$/Each
0 - 1.0	2625-40	675.00
0 - 5.0	2625-41	650.00
*Bi-directional range. 1.0 - 0 - 1.0*	2625-42	675.00

### A. High-Volume Air Handlers (includes 10"- diameter x 2" flange)

Air Flow			120VAC, 60Hz		220VAC, 50/60Hz		HEPA Filter		ULPA Filter	
@ 0" SP	@ 1" SP	Motor Size	Cat. #	\$/Each	Cat. #	\$/Each	Cat. #	\$/Each	Cat. #	\$/Each
2,230 CFM	1,642 CFM	1 HP	6710-65	1,286.00	6710-65-220	1,286.00	1681-02	220.00	1681-10	298.00
3,361 CFM	2,817 CFM	1.5 HP	6710-66	1,538.00	6710-66-220	1,538.00	1681-02	220.00	1681-10	298.00
5,768 CFM	4,117 CFM	2 HP	6710-67	1,791.00	6710-67-220	1,791.00	1681-02	220.00	1681-10	298.00

\*Registered trademark of Dwyer Instruments.

# Cleanroom Accessories

## Cleanroom Air Conditioning Module

- Ideal for ensuring the comfort and productivity of garbed personnel
- External air baffles allow quick, easy control over percentage of recirculated/make-up air
- Models with humidity control maintain steady RH level
- Low noise and vibration levels

Each A/C unit is mounted to a polypropylene plenum chamber installed on the exterior cleanroom wall. An intake manifold inside the cleanroom recirculates filtered air. An adjustable baffle mounted outside the cleanroom lets you adjust the percentage of fresh make-up air. Cooled air is directed into the filter/fan units for filtration before being introduced into the cleanroom.

A Terra application engineer will help select module size and quantity, based on room size, number of FFUs, temperature outside the room, and heat generated by process equipment.

*Recirculates cooled air through specified FFUs*



**Larger cleanrooms may require externally installed HVAC units and special permitting. Call Terra for help in assessing your requirements.**

**A/C Modules:** Includes air distribution plenum. All models operate on 220VAC, 50/60Hz.

Cooling Net BTUH	Dimensions (W" x D" x H")	AC Control Only		AC and RH Control	
		Cat. #	\$/Each	Cat. #	\$/Each
18,000	33.3 x 17.1 x 70.5	<b>6704-27</b>	<b>4,510.00</b>	—	—
48,000	42 x 22.5 x 85	<b>6704-28</b>	<b>5,610.00</b>	<b>6704-31</b>	<b>6,710.00</b>
57,000	42 x 22.5 x 85	<b>6704-29</b>	<b>6,710.00</b>	<b>6704-32</b>	<b>7,810.00</b>

## Modular Cleanroom Facilities

**DIGIHELIC® Differential Pressure Gauge – See previous page**



### Detection System

Senses all hydrocarbon and non-hydrocarbon fires. Its multiple-band spectrum sensitivity detects even very small flames. Field of view (sensor range) is 120° within 8 feet of fire area. For specifications and ordering information, visit TerraUniversal.com.



### AirGard® Air Velocity Meter

Monitors air velocity to ensure ventilation efficiency. Mounts on Modular Cleanroom Control Panel for easy viewing. High/Low Alarms indicate when air speed falls out of range.

Cat. # **6704-65**    \$/Each **890.00**



### Duplex Power Outlets

Includes wiring (up to a 30' run from ceiling junction box) and installation of one UL-approved outlet box, in conformance with NEC specifications.

110VAC, 50/60Hz  
Cat. # **6704-33**    \$/Each **215.00**  
220VAC, 50/60Hz  
Cat. # **6704-34**    \$/Each **215.00**



### Airborne Particle Counters

Sensitivity to 0.1 microns. Hand-held and benchtop models available, many with built-in printers. See page 41.



### EnviroWatch™ Thermohygrometer

Continuous LED display of temperature (°F or °C) and relative humidity. Mounted on Terra's Modular Cleanroom Control Panel for easy viewing.

Cat. # **5401-30**    \$/Each **193.00**



### Vacuum/Gas Connections

Includes installation of vacuum line and quick connect fitting.

Vacuum (to 29.9"Hg)  
Cat. # **6704-35**    \$/Each **240.00**  
Nitrogen/Compressed Air (100 psi)  
Cat. # **6704-36**    \$/Each **180.00**



### EnergySaver Unit Control

Programmable filter/fan control lets you adjust blowers individually from a central monitor/display panel to cut operating cost and heat generation. "Not-In-Use" setting and Passcode security protection. Controller below for (4) FFUs.



### Ultrasonic Humidifier

This space-saving humidifier fits directly into a standard 2' x 4' ceiling grid, eliminating floor clearance requirements. It uses five ultrasonic transducers to generate mist and uses only 150W, less power than conventional steam canister humidifiers. A 45 CFM fan improves humidification efficiency. Requires DI water source. Power: 120VAC (220 model also available).

Cat. # **6710-29**    \$/Each **4,950.00**

FFUs Control (1 per FFU)    Cat. # **6702-19**    \$/Each **330.00**  
Central Controller\* (one per room)    Cat. # **6702-20**    \$/Each **660.00**

\*Controls up to four FFUs; other capacities available.

# Cleanroom Pass-Throughs

Pass-through chambers below are designed for installation in a wall cut-out of a typical cleanroom, including Terra's BioSafe rooms. For Hardwall Plastic Cleanrooms, see models on the facing page.

**Note:** *Stainless steel models feature partial seam welds and are intended for positive pressure rooms. For smooth, continuous-seam chambers, see BioSafe™ models on page 22.*



Terra's online **QuickQuote Planner** configures a room to your specifications: [www.TerraUniversal.com](http://www.TerraUniversal.com)  
Just click on [Modular Cleanrooms](#)

**304 Stainless Steel Mounting Brace** Cat. # \$/Each  
Two recommended for 36"-deep wall-mount cabinets **1993-60B 265.00**

**Stainless Steel ULPA-Filtered Air Shower**  
Door-activated module provides a wash of filtered air inside pass-through chamber. Installed on top of any chamber 18"D or larger. **1993-11A 1,496.00**

**Fluorescent Illuminator**  
For models up to 18"W **1993-33 233.00**  
For models over 18"W **1993-34 326.00**



No. 1993-12



No. 6705-26

No. 1993-03



No. 1993-18 Convenient Slide-Up Doors

## Pass-Through Chambers (Doors are made of material indicated in parentheses; other designs available.)

Mount Type	Outside Dimensions (W" x D" x H") Add 1/2" to W x H for cut-out	304 Stainless Steel (Stainless Steel Doors/ Dissipative PVC Windows) Internal Access = W x H minus 2"		Nonconductive Laminate (Acrylic Doors) Internal Access = W x H minus 2"		Polypropylene (Nondissipative PVC Doors) Internal Access = W x H minus 1"		Static Dissipative PVC (Dissipative PVC Doors) Internal Access = W x H minus 2"		Acrylic Internal Access = W x H minus 2" Do not clean with alcohol.	
		Cat. #	\$/Each	Cat. #	\$/Each	Cat. #	\$/Each	Cat. #	\$/Each	Cat. #	\$/Each
Wall (1)	12 x 12 x 12	1992-09A	1,063.00	1991-00A	535.00	1992-26A	552.00	1992-37A	532.00	1993-12A	316.00
	12 x 12 x 24	1992-10A	1,484.00	1992-18A	651.00	1992-27A	675.00	1992-38A	831.00	1948-20A	464.00
	18 x 18 x 16	1992-11A	1,607.00	1992-00A	832.00	1992-28A	908.00	1992-39A	1,025.00	1992-48A	530.00
	18 x 18 x 24	1992-12A	1,783.00	1992-19A	959.00	1992-29A	1,041.00	1992-40A	1,170.00	1992-49A	611.00
	24 x 24 x 16	1992-13A	2,024.00	1993-00A	986.00	1992-30A	1,085.00	1992-41A	1,268.00	1992-50A	694.00
	24 x 24 x 24	1992-14A	2,160.00	1992-20A	1,069.00	1992-31A	1,154.00	1992-42A	1,316.00	1992-51A	732.00
	24 x 36 x 24	1992-15A	2,971.00	1992-21A	1,126.00	1992-32A	1,379.00	1992-43A	1,765.00	1992-44A	1,235.00
	24 x 24 x 48	6705-26A	3,002.00	6705-27A	1,186.00	6705-28A	1,498.00	—	—	6705-29A	1,403.00
	36 x 36 x 24	1997-03A	3,311.00	1992-22A	1,167.00	1992-33A	1,439.00	—	—	1992-52A	1,295.00
	24 x 24 x 36	1992-16A	3,170.00	1992-23A	1,129.00	1992-34A	1,397.00	1992-45A	1,779.00	1992-46A	1,253.00
Floor (1)	36 x 36 x 36	1997-06A	3,642.00	1992-24A	1,199.00	1992-35A	1,595.00	—	—	1992-53A	1,451.00
	36 x 36 x 48	1997-08A	3,908.00	1992-25A	1,368.00	1992-36A	1,658.00	—	—	1992-80A	1,514.00
	24 x 24 x 36	1992-84A	3,256.00	1993-01A	1,318.00	1993-04A	1,696.00	1993-07A	3,284.00	1993-08A	1,552.00
	36 x 36 x 36	1992-85A	4,305.00	1993-02A	1,388.00	1993-05A	1,764.00	—	—	1993-09A	1,620.00
	36 x 36 x 48	1992-86A	4,569.00	1993-03A	1,558.00	1993-06A	2,099.00	—	—	1993-10A	1,955.00

- Order installation brackets separately. Floor Mount models include low-profile access ramps for easy transport of carts (subtract 1" from internal vertical clearance to compensate for ramps).
- Sliding doors require vertical overhead clearance equal to the door height, so 36"H model should be mounted no closer than 36" below the cleanroom ceiling.

- Mounting brackets are made of stainless steel. All brackets require 1/4" clearance between wall cut-out and pass-through. Standard mounting is 2" from the front of the cleanroom side (specify other desired location). Price is for one set of four brackets. Two sets are typically required for installation of one pass-through (one set for sliding door models). One is welded on the cleanroom side. For electropolishing, add "-2" to the Cat. number and \$75.00 to the price.

# Cleanroom Pass-Throughs



## For Hardwall Plastic Cleanrooms

Pass-through chambers below are designed for installation in Terra's acrylic, static-dissipative, or polycarbonate hardwall cleanroom. Select desired size and corresponding mounting panel for a standard 7'-H wall (specify other wall height).

## Improved Design! FirmLok™ Pass-Through Interlock

Terra's new FirmLok™ prevents cross-contamination by ensuring that only one pass-through door at a time can open.

The moment a door is opened, the opposing latch engages a stainless steel catch to lock out the opposing door. The highly reliable, interlock design is rated for thousands of trouble-free operations.

The dual heavy-gauge latch mechanisms retract inside the easy-clean stainless steel housing when not engaged, eliminating protruding hardware that collects contaminants and causes snags.

Available for all standard swing-door pass-throughs (see ordering information below).



Rated for millions of operations.  
BioSafe™ easy-clean interlock—see page 22

Pass-Through Chambers for Hardwall Cleanrooms					Accessories							
Outside Dimensions (W" x D" x H") Add 1/2" to W x H for cut-out)	Electropolished Stainless Steel (Stainless Steel Doors/ Dissipative PVC Windows)		Stainless Steel (Stainless Steel Doors/ Dissipative PVC Windows)		Static Dissipative PVC		Acrylic		Mounting Panel For installation on a standard 7'-high Terra Modular Cleanroom		FirmLok™ Mechanical Interlock	
	Cat. #	\$/Each	Cat. #	\$/Each	Cat. #	\$/Each	Cat. #	\$/Each	Cat. #	\$/Each	Cat. #	\$/Each
12 x 12 x 12	6704-80	1,211.00	6704-85	1,027.00	6704-95	532.00	6704-90	316.00	6704-70	475.00	6705-50	481.00
18 x 18 x 16	6704-81	1,855.00	6704-86	1,583.00	6704-96	1,025.00	6704-91	530.00	6704-71	475.00	6705-51	541.00
18 x 18 x 24	6704-82	2,089.00	6704-87	1,755.00	6704-97	1,316.00	6704-92	694.00	6704-72	475.00	6705-51	541.00
24 x 24 x 24	6704-83	2,543.00	6704-88	2,145.00	6704-98	1,436.00	6704-93	732.00	6704-73	475.00	6705-52	601.00
24 x 24 x 36	6704-84	3,475.00	6704-89	2,594.00	6704-99	2,779.00	6704-94	1,253.00	6704-74	475.00	6705-52	601.00

### Corresponding Pass-Through Accessories — for Pass-Through Chambers on facing page.

Sliding Door Pass-Through (2)		Mounting Brackets (3) For Standard Pass-Through: Order 2 Sets For Sliding Door Models: Order 1 Set		FirmLok™ Mechanical Interlocks (4) Cannot be retrofitted				Stainless Steel Shield (5)	Stainless Steel Shelf (5)	Stainless Steel Racks (5) (one pair)	
Cat. #	\$/Each	Cat. #	\$/Set of 4	For Standard Pass-Throughs		For Pass-Throughs With Sliding Door		Cat. #	Cat. #	Cat. #	\$/Pair
—	—	1994-01	106.00	6705-50	481.00	6705-55	481.00	1992-65	1992-70	1993-40	125.00
—	—	1994-02	118.00	6705-50	481.00	6705-55	481.00	1992-65	1992-70	1993-41	125.00
—	—	1994-03	118.00	6705-51	541.00	6705-56	541.00	1992-66	1992-71	1993-42	160.00
1993-16	946.00	1994-04	138.00	6705-51	541.00	6705-56	541.00	1992-66	1992-71	1993-43	160.00
1993-17	946.00	1994-05	144.00	6705-52	601.00	6705-57	601.00	1992-67	1992-72	1993-44	245.00
1993-18	1,074.00	1994-06	153.00	6705-52	601.00	6705-57	601.00	1992-67	1992-72	1993-45	245.00
1993-19	1,074.00	1994-06	153.00	6705-53	721.00	6705-58	721.00	1992-68	1992-73	1993-46	332.00
—	—	6705-30	185.00	6705-52	601.00	6705-57	601.00	1992-67	1992-72	1993-48	245.00
1993-20	1,514.00	1994-07	180.00	6705-53	721.00	6705-58	721.00	1996-69	1992-27	1993-47	463.00
1993-21	1,514.00	1994-08	180.00	6705-52	601.00	6705-57	601.00	1992-67	1992-72	1993-48	245.00
1993-22	1,514.00	1994-09	180.00	6705-53	721.00	6705-58	721.00	1992-69	1993-28	1993-49	463.00
—	—	1994-10	217.00	6705-53	721.00	6705-58	721.00	1992-69	1993-29	1993-50	463.00
1993-24	1,514.00	1994-11	180.00	6705-52	601.00	6705-57	601.00	1992-67	1992-72	1993-51	245.00
1993-25	1,514.00	1994-12	180.00	6705-53	721.00	6705-58	721.00	1992-69	1993-38	1993-52	463.00
1993-26	1,514.00	1994-13	217.00	6705-53	721.00	6705-58	721.00	1992-69	1993-39	1993-53	463.00

(4) All use a fail-proof mechanical design that requires no maintenance. Made of stainless steel. Must be specified when Pass-Through is ordered (cannot be retrofitted). For electropolishing add "-2" to the Cat. number and \$75.00 to the price.

(5) Shields are recommended in all plastic pass-throughs to prevent scratching. Racks allow adjustable shelf placement and are required for use with shelves (their price includes installation). For electropolishing, add "-2" to the part number and 30% to the price (standard racks are electropolished).

# BioSafe Pass-Throughs

## Smooth, Ultra-Clean Surfaces Eliminate Germ Traps, Simplify Cleaning and Disinfection

- Continuous-seam interiors create a hermetically sealed chamber with no cracks or crevices
- 304 stainless steel can be disinfected with common disinfectants (316 SS available)
- One-piece, heat-formed Santoprene™ gaskets will not creep, deform, or outgas like adhesive “weather-stripping”-style gaskets.
- Ergonomic, chrome-plated LiftLatches eliminate rotary strain on hinges
- Choose among several interlock designs, including Terra’s unique BioSafe™ external-mount interlock (see facing page)



### Series 100 BioSafe™ Pass-Through

*An easy-clean, hermetically sealed enclosure designed for versatile configurations.*

These chambers eliminate particle influx when exposed to negative pressure. Continuous-seam welds are ground smooth for easy cleaning and disinfection. Choose FirmLok™ (interior) or BioSafe™ (exterior interlock). Ideal for use with ventilation or ULPA air-shower options (see page 23).



### Interlock Options

These reliable mechanisms prevent both Pass-Through doors from opening at the same time, thereby preventing contamination.



#### FirmLok™ Mechanical Interlock

The instant a door is opened, the FirmLok™ engages a latch that locks the opposing door. The dual heavy-duty latch mechanisms retract inside an easy-clean stainless steel housing when not engaged to eliminate protruding hardware. The highly reliable design is rated for millions of trouble-free operations.

Order from chart below.



#### Electro-Magnetic Interlock

Available on a custom basis, this unit allows interlocking of remote chambers, or activation from a remote keypad. Call to discuss your application.

Cat. #

6705-04

### Series 100 BioSafe™ 304 Stainless Steel Pass Throughs— (For electropolishing, add “-2” to the part number and 20% to the price)

Mount Type	Dimensions W" x D" x H" (Add .5" to W x H for cut-out)	Chamber Only: 304 SS (for use with FirmLok™)		FirmLok™ Interlock (2) (Order corresponding chamber at left)		Mounting Brackets for Chamber Only (3)		Chamber with BioSafe™ External Interlock Adds 3" to nominal width		Mounting Brackets for Chamber with BioSafe™ Interlock (3)	
		Cat. #	\$/Each	Cat. #	\$/Each	Cat. #	\$/Each	Cat. #	\$/Each	Cat. #	\$/Each
Wall (1)	12 x 12 x 12	2636-01A	1,382.00	6705-50	481.00	1994-01	106.00	2636-21	2,373.00	2636-40	127.00
	12 x 12 x 24	2636-02A	1,929.00	6705-50	481.00	1994-02	118.00	2636-22	2,894.00	2636-41	142.00
	18 x 18 x 16	2636-03A	2,089.00	6705-51	541.00	1994-03	118.00	2636-23	3,134.00	2636-42	142.00
	18 x 18 x 24	2636-04A	2,318.00	6705-51	541.00	1994-04	138.00	2636-24	3,477.00	2636-43	166.00
	24 x 24 x 16	2636-05A	2,631.00	6705-52	601.00	1994-05	144.00	2636-25	3,947.00	2636-44	173.00
	24 x 24 x 24	2636-06A	2,808.00	6705-52	601.00	1994-06	153.00	2636-26	4,212.00	2636-45	184.00
	24 x 36 x 24	2636-07A	3,862.00	6705-53	721.00	1994-06	153.00	2636-27	5,793.00	2636-45	184.00
	36 x 36 x 24	2636-08A	4,304.00	6705-53	721.00	1994-07	180.00	2636-28	6,456.00	2636-47	216.00
	24 x 24 x 36	2636-09A	3,903.00	6705-52	601.00	1994-08	180.00	2636-29	5,855.00	2636-48	216.00
	24 x 24 x 48	2636-16A	4,121.00	6705-52	601.00	6705-30	185.00	2636-30	6,182.00	2636-49	219.00
	36 x 36 x 36	2636-10A	4,735.00	6705-53	721.00	1994-09	180.00	2636-31	7,103.00	2636-50	216.00
36 x 36 x 48	2636-11A	5,080.00	6705-53	721.00	1994-10	217.00	2636-32	7,620.00	2636-51	260.00	
Floor (1)	24 x 24 x 36	2636-12A	4,607.00	6705-52	601.00	1994-11	180.00	2636-33	6,910.00	2636-52	216.00
	36 x 36 x 36	2636-13A	5,398.00	6705-53	721.00	1994-12	180.00	2636-34	8,097.00	2636-53	216.00
	36 x 36 x 48	2636-14A	5,743.00	6705-53	721.00	1994-13	217.00	2636-35	8,614.00	2636-54	260.00

(1) Order installation brackets separately. Floor Mount models include low-profile access ramps for easy transport of carts (subtract 1" from internal vertical clearance to compensate for ramps).

(2) All use a fail-proof mechanical design that requires no maintenance. Made of stainless steel. Must be specified when Pass-Through is ordered (cannot be retrofitted). For electropolishing add “-2” to the Cat. number and \$75.00 to the price.



# BioSafe Pass-Throughs



**Series 200 BioSafe™ Pass-Throughs**  
*Unique design provides the optimal pass-through chamber for use with biological or pharmaceutical materials*  
 Continuous-seam welds produce a hermetically sealed enclosure, with covered (3/16" radius) corners that eliminate particle traps and simplify cleaning. Standard units include BioSafe™ external-mount interlock (electromagnetic interlock also available).



**Stainless Steel ULPA-Filtered Air Shower**

Directs streams of high-velocity, ULPA-filtered air through the pass-through to dislodge contaminants from material surfaces. Activated when "dirty"-side door is closed; particles are trapped in exit filter on "dirty"-side vent.

Cat. # **1993-11A** \$/Each **1,496.00**



**BioSafe™ UltraClean Interlock**

This design houses a FirmLok™ mechanism in an external chamber to eliminate cracks and crevices – leaving the internal surfaces smooth and easy to clean. This design also eliminates internal clearance requirements. *Adds 3" to the width of the pass-through chamber (included in dimensions below).*



**Ventilation System**

Ideal for removing solvents, powders, and other environmental hazards. Price includes installation on specified Pass-Through.

6"-dia. Flange **6705-23** \$/Each **222.00**  
 Connects to in-house ventilation system

Inlet ULPA filter **6705-24** **256.00**  
 Remove particles from make-up air.

**Grounding Terminals (not shown)**  
 Recommended on stainless steel and dissipative chambers to prevent electro-static discharge. Price includes installation.

**1686-12** **69.00**

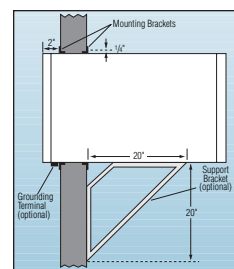

**Support Bracket**  
 Pair recommended for chambers 36"D.  
 Cat. # **1993-60B** \$/Pair **265.00**

**Series 200 BioSafe™ 304 Stainless Steel Pass Throughs**

Mount Type	Dimensions W" x D" x H" (Add .5" to W x H for cut-out)	Rounded Chamber with BioSafe™ External Interlock		Electropolished Rounded Chamber with BioSafe™ External Interlock		Mounting Brackets for Chamber with BioSafe™ Internal Interlock (3)	
		Cat. #	\$/Each	Cat. #	\$/Each	Cat. #	\$/Each
Wall (1)	15 x 12 x 12	<b>2636-59</b>	<b>3,560.00</b>	<b>2636-59-2</b>	<b>4,271.00</b>	<b>2637-20</b>	<b>132.00</b>
	15 x 12 x 24	<b>2636-60</b>	<b>4,340.00</b>	<b>2636-60-2</b>	<b>5,208.00</b>	<b>2637-21</b>	<b>147.00</b>
	21 x 18 x 16	<b>2636-61</b>	<b>4,700.00</b>	<b>2636-61-2</b>	<b>5,640.00</b>	<b>2637-22</b>	<b>147.00</b>
	21 x 18 x 24	<b>2636-62</b>	<b>5,216.00</b>	<b>2636-62-2</b>	<b>6,259.00</b>	<b>2637-23</b>	<b>171.00</b>
	27 x 24 x 16	<b>2636-63</b>	<b>5,525.00</b>	<b>2636-63-2</b>	<b>6,630.00</b>	<b>2637-24</b>	<b>178.00</b>
	27 x 24 x 24	<b>2636-64</b>	<b>5,897.00</b>	<b>2636-64-2</b>	<b>7,076.00</b>	<b>2637-25</b>	<b>189.00</b>
	27 x 36 x 24	<b>2636-65</b>	<b>8,110.00</b>	<b>2636-65-2</b>	<b>9,732.00</b>	<b>2637-25</b>	<b>189.00</b>
	39 x 36 x 24	<b>2636-66</b>	<b>8,716.00</b>	<b>2636-66-2</b>	<b>10,459.00</b>	<b>2637-27</b>	<b>221.00</b>
	27 x 24 x 36	<b>2636-67</b>	<b>8,196.00</b>	<b>2636-67-2</b>	<b>9,836.00</b>	<b>2637-28</b>	<b>221.00</b>
	27 x 24 x 48	<b>2636-68</b>	<b>8,654.00</b>	<b>2636-68-2</b>	<b>10,385.00</b>	<b>2637-29</b>	<b>221.00</b>
	39 x 36 x 36	<b>2636-69</b>	<b>9,588.00</b>	<b>2636-69-2</b>	<b>11,506.00</b>	<b>2637-30</b>	<b>221.00</b>
39 x 36 x 48	<b>2636-70</b>	<b>10,287.00</b>	<b>2636-70-2</b>	<b>12,344.00</b>	<b>2637-31</b>	<b>265.00</b>	
Floor (1)	27 x 24 x 36	<b>2636-71</b>	<b>9,329.00</b>	<b>2636-71-2</b>	<b>11,195.00</b>	<b>2637-32</b>	<b>221.00</b>
	39 x 36 x 36	<b>2636-72</b>	<b>10,930.00</b>	<b>2636-72-2</b>	<b>13,116.00</b>	<b>2637-33</b>	<b>221.00</b>
	39 x 36 x 48	<b>2636-73</b>	<b>11,629.00</b>	<b>2636-73-2</b>	<b>13,955.00</b>	<b>2637-34</b>	<b>265.00</b>

(3) Mounting brackets are made of stainless steel. All brackets require 1/4" clearance between wall cut-out and pass-through. Standard mounting is 2" from the front of the cleanroom side (specify other desired location). Price is for one set of four brackets. Two sets are typically required for installation of one pass-through (one set for sliding door models). One is welded on the cleanroom side. For electropolishing, add "-2" to the cat. number and \$75.00 to the price.

# Cleanroom Accessories



No. 6705-12A



No. 6705-10A



No. 6705-13

- HEPA air showers
- Pushbutton operation
- No clearance requirement

## Roll-Up Pass-Throughs

This unique, space-saving pass-through features dual-side segmented doors that automatically roll up and down at the push of a PLC control pad. This design eliminates door clearance requirements and makes it easy for gloved personnel to operate while holding parts. Motorized lifters are sealed inside a noncontaminating housing, and doors slide up and down a track. The segmented access doors are made of powder-coated insulated aluminum. The door rolls into a stainless steel housing.

### Roll-Up Pass-Throughs

Dimensions		Roll-Up Pass-Through		Corresponding Mounting Brackets (1)		Corresponding Air Shower	
Outside (W" x D" x H") Excluding Hardware	Inside Clearance (W" x D" x H")	Stainless Steel Floor Mount (Includes Ramps)		Stainless Steel For Floor Mount			
		Cat. #	\$/Each	Cat. #	\$/Each	Cat. #	\$/Each
44 x 30 x 61.5	29 x 28 x 44	6705-12A	8,678.00	6705-32	432.00	6705-60	1,694.00
63.5 x 50 x 87	52.75 x 48 x 66.25	6705-10A	14,175.00	6705-33	462.00	6705-61	1,742.00
82.5 x 50 x 78.75	68 x 48 x 61.25	6705-13	16,150.00	6705-34	492.00	6705-62	1,856.00

(1) Mounting brackets are made of stainless steel. All brackets require 1/4" clearance between wall cutout and pass-through. Standard mounting is 2" from the front of the cleanroom side (specify other desired location). Price is for one set of brackets. Two sets are typically required for installation of one pass-through. One is welded on the cleanroom side.



### Other Pass-Through Configurations

Call Terra to discuss your requirements

#### A. Walk-Through Chamber

Made of 304 stainless steel with interlocked doors; 40"W x 36"D x 84"H.

Cat. # 6705-74

#### B. Fire-Rated Pass-Through

Independently certified to meet Warnock Hersey fire safety requirements. Double-wall 304 stainless steel construction with mechanical or electronic interlock. 39.5"W x 28"D x 38.25"H

Cat. # 6705-00A \$/Each 13,515.00

#### C. Walk-Through Chamber with Roller Transfer Platform

Made of 304 stainless steel; 60"W x 60"D x 84"H.

Cat. # 6705-67

#### D. Air Shower Pass-Through

Ideal for removing surface contaminants from carts transferred into the cleanroom. Features high-velocity HEPA-filtered air jets. 36"W x 36"D x 48"H

Cat. # 6705-70 \$/Each 8,788.00

#### E. Air Conditioned Pass-Through

Double-wall, insulated 304 SS chamber features a refrigeration system that maintains temperature to 5°C.

Cat. # 6710-75 \$/Each \$15,030.00

# Cleanroom Accessories

## Cleanroom Air Showers

- Adjustable nozzles direct high velocity HEPA-filtered air stream that dislodges and removes particles
- Interlocking doors minimize contamination, release automatically in the event of power failure

These Air Showers offer an effective way to remove surface-deposited particles from personnel—before they get to the cleanroom.

Each unit is a fully equipped, protected passageway that allows large numbers of personnel to pass into controlled areas without sacrificing convenience or cleanliness.

Nozzles are arranged on walls in a uniform pattern to ensure effective distribution of filtered air. HEPA-filtered air also flows downward from the ceiling. The closed-loop circulation design directs contaminated air downward through grills and hollow walls of the Air Shower and back to the filter, which removes 99.99% of all particles as small as 0.3 microns.

### Powder-Coated Steel Air Showers

Overall Dimen. W" x D" x H"	Inside Dimen.* W" x D" x H"	Cat. #	\$/Each
52 x 44 x 108	37.5 x 39.5 x 84	<b>6010-14A</b>	<b>11,019.00</b>
52 x 56 x 108	37.5 x 51.5 x 84	<b>6010-16A</b>	<b>13,666.00</b>

\*Door clearance: 32"W x 81"H

### 304 Stainless Steel Air Showers

Overall Dimen. W" x D" x H"	Inside Dimen.* W" x D" x H"	Cat. #	\$/Each
52 x 44 x 108	37.5 x 39.5 x 84	<b>6010-00A</b>	<b>17,162.00</b>
52 x 56 x 108	37.5 x 51.5 x 84	<b>6010-02A</b>	<b>21,284.00</b>

\*Door clearance: 32"W x 81"H



Other sizes and configurations available. Refer to [TerraUniversal.com](http://TerraUniversal.com) for complete ordering information.



Garments courtesy of W. L. Gore & Associates

Selection Guide

Hardwall Plastic

All-Steel BioSafe™

Powder Containment

Softwall Plastic

Accessories

Gowning Products

# Cleanroom Accessories

## Wall-Mount Cleanroom Benches and Shelves

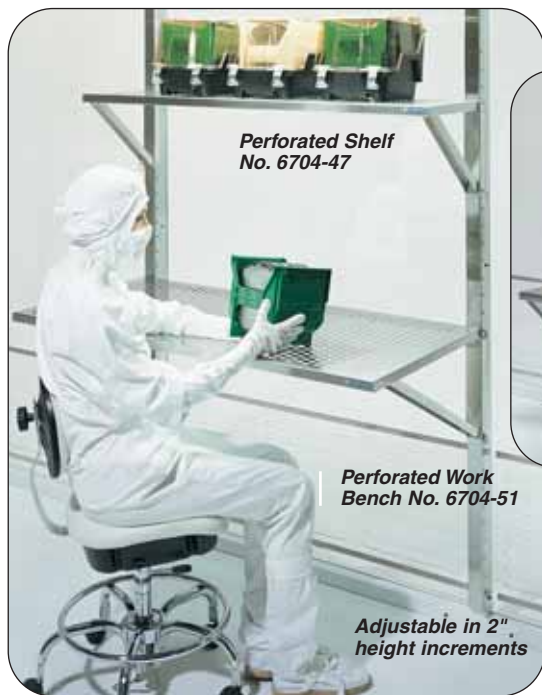

- Adjustable at 2" height increments
- Electropolished for optimal cleanliness
- Leaves floors unobstructed for operator comfort and easy floor cleaning

The rigid wall mounting system supports up to 400 lbs., providing ample strength for heavy process equipment or for a gowning bench. This mounting system leaves the floor clear of support legs for easy cleaning and unrestricted leg movement. Benches can be positioned in 2" increments from 16" to 72" above floor level. Adjustment requires no tools—simply remove and reinsert the fastening pin.

Order Mounting Posts separately.

Dimensions:		Solid Top		Perforated Top*		Rod Top**	
(W x D)	Cat. #	\$/Each	Cat. #	\$/Each	Cat. #	\$/Each	
51.75" x 16"	6704-39	1,097.00	6704-47	1,519.00	6704-55	1,173.00	
99.75" x 16"	6704-40	1,755.00	6704-48	2,213.00	6704-56	1,937.00	
51.75" x 24"	6704-41	1,235.00	6704-49	1,659.00	6704-57	1,311.00	
99.75" x 24"	6704-42	1,893.00	6704-50	2,352.00	6704-58	2,075.00	
51.75" x 30"	6704-43	1,297.00	6704-51	1,590.00	6704-59	1,382.00	
99.75" x 30"	6704-44	1,992.00	6704-52	2,484.00	6704-60	2,192.00	
51.75" x 34"	6704-45	1,382.00	6704-53	1,797.00	6704-61	1,519.00	
99.75" x 34"	6704-46	1,937.00	6704-54	2,567.00	6704-62	2,213.00	

**Mounting Posts**  
Attach to cleanroom frame    Cat. # 6706-00    \$/Pair 301.00

\* 3/4"-diameter holes. \*\* 1/4"-diameter rods on 1" centers.

## Other Cleanroom Accessories

### A-E. Cleanroom Waste Receptacles

Fabricated of 304 electropolished stainless steel, they provide years of constant service without contamination. Their no-spring foot pedal allows hands-free operation, and the tight-fitting, gasketed lid forms a nearly air-tight seal to contain waste safely.

Cleanroom Waste Receptacles			
Type	Capacity (Gallons)	Electropolished Stainless Steel	
		Cat. #	\$/Each
A	3.5	1456-15	276.00
B	7	1456-16	379.00
C	12	1456-17	447.00
D	24	1456-18	577.00
E	40	1456-19	806.00

### F-H. Step Stools and Ladders

Include spring-loaded safety casters that retract under load. Perforations limit particle accumulation. Custom sizes available.

304 Stainless Steel Step Stools and Ladders					
	Top Platform (W' x D')	Overall Dimensions (W' x D' x H')	No. of Steps	Electropolished Stainless Steel	
				Cat. #	\$/Each
F	30 x 14	30 x 20 x 24	2	2805-50A	1,091.00
G	30 x 12	30 x 28 x 34	3	2805-51A	1,458.00
	30 x 12	30 x 28 x 60	3*	2805-53A	1,671.00
	30 x 12	30 x 30 x 70	4*	2805-52A	2,511.00
	30 x 16	30 x 40 x 80	5*	2805-54A	3,178.00
H	30 x 36	30 x 76 x 86	5*	2805-55A	3,460.00

\* Includes safety handrail.



# Change Room Racks & Shelving



**A** More sizes available – [www.TerraUniversal.com](http://www.TerraUniversal.com)

## Cleanroom Shelving



### A. Super Adjustable™ Wire Shelves

Just lift the release on each corner, adjust your shelf at precise 1"-increments, and clamp the release lever shut. In seconds, you can optimize your storage system to changing load requirements, with no tools, no wasted time, and no wasted space. For shelf grounding in static-sensitive applications, select conductive sleeves below.

#### A. Super Adjustable Wire Shelves

Dimensions W x L (inches)	Chrome Plated		Stainless Steel	
	Cat. #	\$/Each	Cat. #	\$/Each
18 x 24	1701-75	41.00	2650-35	135.00
18 x 36	1701-76	41.00	2650-37	139.00
18 x 48	1701-77	41.00	2650-39	164.00
18 x 60	1701-78	59.00	2650-41	208.00
21 x 24	1697-24	47.00	2650-43	158.00
21 x 36	1701-79	53.00	2650-45	158.00
21 x 48	1701-80	58.00	2650-47	183.00
21 x 60	1697-28	67.00	2650-49	241.00
24 x 24	1701-81	49.00	2650-51	167.00
24 x 36	1701-82	53.00	2650-53	171.00
24 x 48	1701-83	63.00	2650-55	205.00
24 x 60	1701-84	74.00	2650-57	251.00

Replacement Sleeves/Wedges (pack of 4)	1571-00	5.00
Conductive Sleeves (pack of 4)	1571-01	4.00

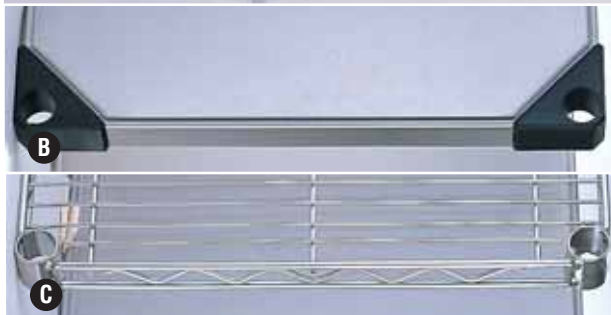

### B-C. Cleanroom Shelving with Split-Sleeve Assembly

This InterMetro shelving is fabricated of noncontaminating, cleanroom-compatible materials. Order aluminum split sleeve for shelf grounding.

Dimens. W x L (in.)	B. Solid Shelves		C. Wire Shelves	
	Flat Stainless Steel	Chrome Plated	Chrome Plated	Stainless Steel
	Cat. #	\$/Each	Cat. #	\$/Each
18 x 24	1301-06	136.00	1300-35	37.00
18 x 36	1301-08	139.00	1300-37	38.00
18 x 48	1301-10	170.00	1300-39	47.00
18 x 60	1301-11	204.00	1300-40	55.00
21 x 24	1301-12	152.00	1300-42	43.00
21 x 36	1301-14	155.00	1300-44	46.00
21 x 48	1301-16	194.00	1300-46	54.00
21 x 60	1301-17	238.00	1300-47	63.00
24 x 24	1301-18	163.00	1300-49	46.00
24 x 36	1301-20	167.00	1300-51	49.00
24 x 48	1301-22	203.00	1300-53	59.00
24 x 60	1301-23	247.00	1300-54	70.00

**Plastic Split Sleeve Assembly**  
Included with each shelf.

**Aluminum Split Sleeve**  
For grounding type B/C shelves and garment racks.

Cat. #	\$/Pkg.
1303-70	7.00

SiteSelect™ Posts								
Height (inches)	Stationary				*Mobile			
	Chrome Plated		Stainless Steel		Chrome Plated		Stainless Steel	
	Cat. #	\$/Each	Cat. #	\$/Each	Cat. #	\$/Each	Cat. #	\$/Each
14 1/2	1300-85	9.00	1300-91	18.00	—	—	—	—
34 1/2	1300-86	11.00	1300-92	28.00	1307-98	11.00	2650-01	28.00
54 9/16	1300-87	13.00	1300-93	32.00	1307-90	13.00	2650-02	32.00
62 9/16	1300-88	14.00	1300-94	35.00	1307-91	14.00	2650-30	35.00
74 5/8	1300-89	15.00	1300-95	40.00	1307-92	16.00	2650-03	40.00
86 5/8	1300-90	19.00	1300-96	46.00	1307-93	19.00	2650-04	46.00

\* **Make it mobile** – Select the mobile post from chart above. Casters available at TerraUniversal.com



### D/E. Upright and Wall-Mount Garment Racks

Electropolished stainless steel construction promotes ultra-clean conditions. Hanger mechanism ensures proper positioning at 3" intervals. Both models include electropolished stainless steel hangers. To meet ESD requirements, select aluminum split sleeves (above). All units are 24"D; upright models are 74"H.

No. of Width Hangers	D. Upright			E. Wall-Mount		
	Cat. #	\$/Each	Cat. #	Cat. #	\$/Each	\$/Each
36"	11	2650-16	905.00	2650-20	544.00	
48"	15	2650-17	1,121.00	2650-21	685.00	
60"	19	2650-18	1,369.00	2650-22	868.00	
72"	23	2650-19	1,619.00	2650-23	942.00	



### F. Gowning Bench

Made of 14-gauge, 304 stainless steel, with stainless steel leveling footplates. To meet ESD requirements, select aluminum split sleeves (below).

Dimensions	Cat. #	\$/Each	Aluminum Split Sleeves (for bench) (order one package per bench)	
			Cat. #	\$/Pkg.
16" x 36"	2650-24	593.00	1571-03	18.00
16" x 48"	2650-25	622.00		
16" x 60"	2650-26	650.00		
16" x 72"	2650-27	705.00		

# Work Benches and Chairs

Top designs for all applications—



**A** Cleanroom laminate





**B** Stainless steel

**C** Dampens 90% of building vibrations

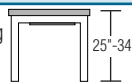

**D** Vibration platform

Work Benches—select desired top (all bases feature a white powder-coated finish)

Base Type (Epoxy Finish)	Width (Depth=30")	A. Nonconductive Laminate		B. Stainless Steel		C. Vibration-Free Laminate Top		D. Vibration-Free Platform			
		Cat. #	\$/Each	Cat. #	\$/Each	Cat. #	\$/Each	Work Surface (W" x D" x H")	Electropolished Stainless Steel Top Cat. #	\$/Each	
Telescoping "A" Base 	48	1722-00	552.00	1521-45	960.00	1570-00	1,554.00	21¾ x 18¼ x 3 23 x 24 x 3	1580-02	2,166.00	
	60	1724-00	608.00	1751-00	1,037.00	1570-01	1,584.00		1580-03	2,430.00	
	72	1726-00	617.00	1752-00	1,088.00	1570-02	1,598.00				
Recessed "C" Base 	48	1521-09	552.00	1521-54	960.00	—	—	Visit <a href="http://TerraUniversal.com">TerraUniversal.com</a> for other bench styles:			
	60	1000-00	608.00	1521-55	1,037.00	—	—		• ErgoHeight™ Adjustable Height Tables		
	72	1000-01	617.00	1521-56	1,088.00	—	—		• Acid-resistant polypropylene tops		
								• Dozens of standard sizes			



**E**



**F**



**G**



**H**



**I**

## E - I. Class 100 and Static Control

Clean vinyl meet Class 100 particle requirements. Static-Control chairs feature dissipative vinyl, conductive casters, and grounding chains.

Specifications		Class 100 Static Control				Class 100					
Height	Color	E		F		G		H		I	
		Cat. #	\$/Each	Cat. #	\$/Each	Cat. #	\$/Each	Cat. #	\$/Each	Cat. #	\$/Each
Desk	Black	2802-61	469.00	2802-67	426.00	2802-73	455.00	2803-01	460.00	2802-93	429.00
	Blue	2802-62*	469.00	2802-68*	426.00	2802-74*	455.00	2803-02	460.00	2802-94	429.00
Bench	Black	2802-64	476.00	2802-70	428.00	2802-76	464.00	2803-05	468.00	2803-09	482.00
	Blue	2802-65*	476.00	2802-71*	428.00	2802-77*	464.00	2803-06	468.00	2803-10	482.00

\* Quick ship models – usually ship within one week!

# Work Benches and Chairs



**QuietTop™  
Rod-Top Benches**

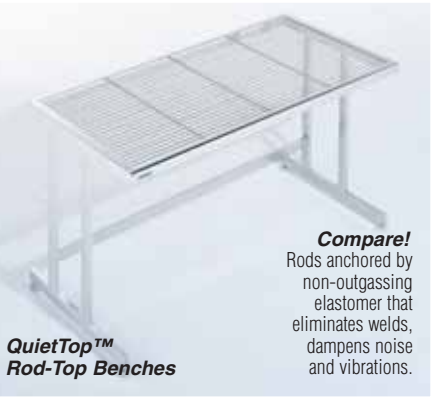

**Compare!**  
Rods anchored by non-outgassing elastomer that eliminates welds, dampens noise and vibrations.

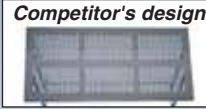

**Open-Top Perf-Top Benches**

Hidden reinforcements minimize dead spots, add strength, and eliminate deflection bounce-back, no matter how large the benchtop.



## HEAVY-DUTY All-Electropolished Stainless Steel Work Stations (800-lb. load capacity)

**QuietTop™ Rods with Full Bullnose**  
ø 1/4" rods on 1" centers

**OpenTop™ Perforated with ErgoEdge™**  
Rounded Front  
ø 1/4" holes

**OpenTop™ Perforated with ErgoEdge™**  
Rounded Front  
ø 3/4" holes

**Solid Top with ErgoEdge™**  
Rounded Front

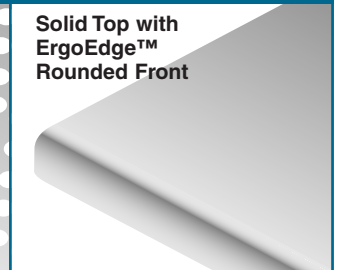
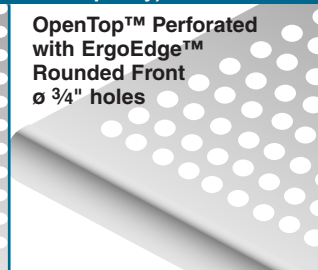
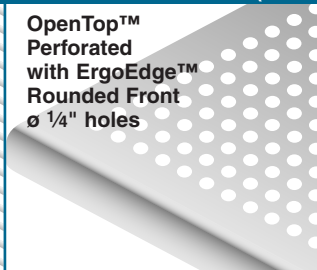

Bench Size (W" x D")	"A" Base "C" Base			"A" Base "C" Base			"A" Base "C" Base			"A" Base "C" Base		
	Cat. #	Cat. #	\$/Each	Cat. #	Cat. #	\$/Each	Cat. #	Cat. #	\$/Each	Cat. #	Cat. #	\$/Each
36 x 30	9601-17	9601-18	1,300.00	9604-59	9604-80	1,513.00	9601-59	9601-60	1,373.00	9603-01	9603-02	1,196.00
48 x 30	9601-19	9601-20	1,448.00	9604-60	9604-81	2,017.00	9601-61	9601-62	1,923.00	9603-03	9603-04	1,360.00
60 x 30	9601-21	9601-22	1,635.00	9604-61	9604-82	2,180.00	9601-63	9601-64	1,948.00	9603-05	9603-06	1,483.00
72 x 30	9601-23	9601-24	1,929.00	9604-62	9604-83	2,452.00	9601-65	9601-66	2,041.00	9603-07	9603-08	1,672.00
84 x 30	9601-25	9601-26	2,064.00	9604-63	9604-84	2,571.00	9601-67	9601-68	2,174.00	9603-09	9603-10	1,877.00
96 x 30	9601-27	9601-28	2,297.00	9604-64	9604-85	2,973.00	9601-69	9601-70	2,603.00	9603-11	9603-12	2,087.00

**Class 1  
#2805-06**



**J**

**Class 10 with Microfiber  
#2803-49**



**K**

**Class 10 with Microfiber  
#2803-57**



**L**

**Class 10 with Breather Lung  
#2803-22**



**M**

**Class 10 with Breather Lung  
#2803-38**



**N**

### J - N. Class 10 and Cleaner!

Select from several base styles. Types J - L feature a microfiber fabric that allows chair to breathe through micropores. Types M and N feature a breather lung that contains contaminants.

Specifications		Class 1 Chair		Class 10 Microfiber				Class 10 Breather Lung			
Height	Color	J.		K. Standard Back		L. Ergo Back		M. Standard Vinyl		N. ESD Vinyl*	
		Cat. #	\$/Each	Cat. #	\$/Each	Cat. #	\$/Each	Cat. #	\$/Each	Cat. #	\$/Each
Desk	Black	—	—	2803-49	470.00	2803-57	464.00	2803-17	418.00	2803-33	447.00
	Blue	—	—	2803-50	470.00	2803-58	464.00	2803-18	418.00	2803-34	447.00
Bench	Black	2805-05	655.00	2803-53	477.00	2803-73	537.00	2803-21	426.00	2803-37	454.00
	Blue	2805-06*	655.00	2803-54	477.00	2803-74	537.00	2803-22	426.00	2803-38	454.00

\* This ESD model includes a grounding chain.

# Cleanroom Accessories

## ErgoHeight™ Work Stations

- Eliminates back stress and injury, enhances productivity
- Provides up to four programmable height settings
- Smooth bench motion — suitable for microscopes and delicate process equipment
- Supports up to 400 pounds net load
- No need to clear work surface for height adjustment!
- Cleanroom-compatible materials

Motorized lifters raise, lower and level the work surface to any of four programmed pre-sets—without disturbing table-top set-ups. Front panel-mounted controls provide pushbutton convenience. Sealed design isolates motor for cleanroom compatibility. Models below feature powder-coated white bases; dozens of other sizes and configurations available. Standard height range: 28" – 48" floor-to-top.

*Turnkey solutions for vibration isolation and exhaust fume removal: TerraUniversal.com*

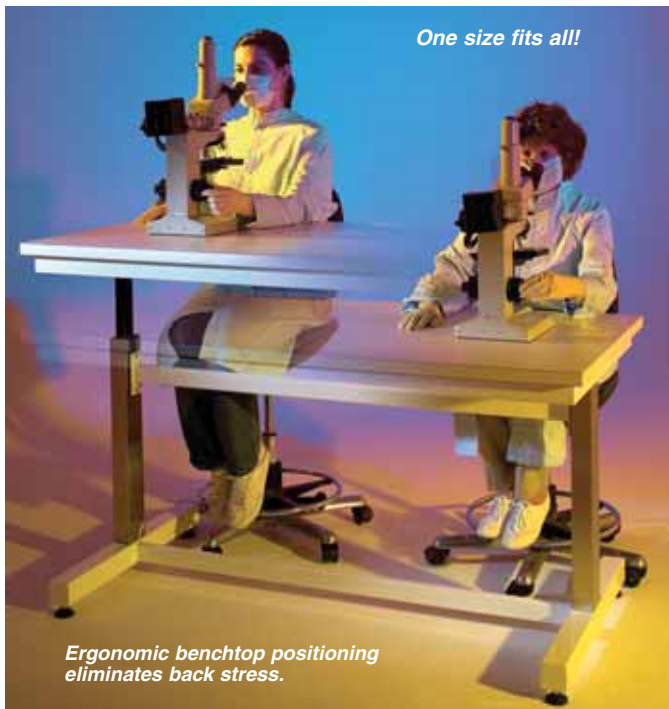

Benchtop Dimensions (W" x D")	ErgoHeight™ Auto-Adjustable Cleanroom Work Stations								Stainless Steel Bases			
	Powder-Coated Steel Bases								Stainless Steel Bases			
	Nonconductive Top		Static-Dissipative Top		Polypropylene Top		Stainless Steel Top		Stainless Steel Top		Electropolished Top and Base	
	Cat. #	\$/Each	Cat. #	\$/Each	Cat. #	\$/Each	Cat. #	\$/Each	Cat. #	\$/Each	Cat. #	\$/Each
36 x 30	3504-16	2,415.00	3504-24	2,671.00	3504-32	2,680.00	3504-04	2,811.00	3504-40	3,155.00	3504-00	3,516.00
48 x 30	3504-17	2,511.00	3504-25	2,768.00	3504-33	2,775.00	3504-05	2,907.00	3504-41	3,269.00	3504-01	3,630.00
60 x 30	3504-18	2,666.00	3504-26	2,924.00	3504-34	2,930.00	3504-06	3,064.00	3504-42	3,390.00	3504-02	3,750.00
72 x 30	3504-19	2,775.00	3504-27	3,032.00	3504-35	3,039.00	3504-07	3,171.00	3504-43	3,500.00	3504-03	3,861.00
36 x 34	3504-20	2,475.00	3504-28	2,732.00	3504-36	2,739.00	3504-08	2,871.00	3504-44	3,215.00	3504-12	3,576.00
48 x 34	3504-21	2,540.00	3504-29	2,796.00	3504-37	2,804.00	3504-09	2,936.00	3504-45	3,330.00	3504-13	3,691.00
60 x 34	3504-22	2,695.00	3504-30	2,952.00	3504-38	2,959.00	3504-10	3,092.00	3504-46	3,451.00	3504-14	3,810.00
72 x 34	3504-23	2,804.00	3504-31	3,060.00	3504-39	3,068.00	3504-11	3,200.00	3504-47	3,560.00	3504-15	3,920.00



### A. Motorized Shoe Cleaner

Internal vacuum system removes contaminants on shoes. Five internal brushes clean deep into seams, welts.

Cat. #	\$/Each	
110VAC/60Hz	1784-00	2,435.00
220VAC/50Hz	1784-00-220	2,651.00

### B. Cleanline® Sticky Mats®

Peel-off sheets eliminate the need for messy cleaning and make it easy to maintain a clean surface. Models are available with full-bottom adhesive surfaces and 2" bottom adhesive strips. Optional mounting frame (shown in photo) provides a sturdy, easy-to-clean edging. Many other sizes and colors, along with high-tack models, are available at TerraUniversal.com.

### Sticky Mats®—All are medium tack (high tack and other sizes, colors available)

Dim. (inches)	Blue				Gray		Corresponding Frame (Adds 3" to each side)	
	Full Bottom		2" Strip Bottom		2" Strip Bottom			
	Cat. #	\$/Each	Cat. #	\$/Each	Cat. #	\$/Each	Cat. #	\$/Each
18 x 36	5601-16	53.00	5601-24	51.00	5602-20	51.00	5602-91	101.00
18 x 45	5601-17	60.00	5601-25	58.00	5602-21	58.00	5602-94	138.00
24 x 36	5601-18	70.00	5601-26	70.00	5602-22	70.00	5602-97	150.00
36 x 45	5601-21	131.00	5601-29	125.00	5602-25	125.00	5603-04	197.00
36 x 60	5601-22	185.00	5601-30	185.00	5602-26	185.00	5603-05	189.00



# Hand, Glove & Shoe Cleaners



Can be mounted on wall or benchtop

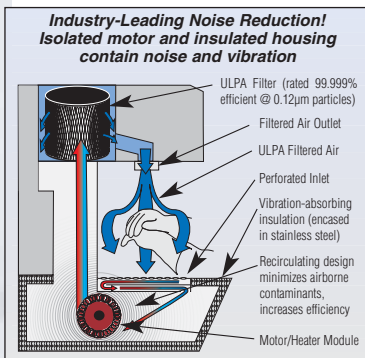

Dimensions: 15"W x 21 1/8"H x 11"D  
Heater: 1600W

PureDry™ Hand/Glove Dryer		
	Cat. #	\$/Each
120VAC/60Hz	3333-33	1,802.00
220VAC/50Hz	3333-34	1,802.00

## PureDry™ Cleanroom Hand/Glove Washers and Dryers

### PureDry™ Dryer

- Provides warm, contamination-free air for drying hands and gloves
- Also ideal for drying tools, bottles, microelectronic components and other small materials
- Eliminates the need for towels that shed particles and harbor germs
- ULPA (Ultra Low Penetration Air) filter captures microcontaminants
- Insulation and motor isolation reduce noise and vibration levels
- Recirculating air design minimizes turbulence for enhanced cleanliness
- Wide exposure area allows complete drying of elbow-length gloves
- Photo-electric cell and adjustable timer allow no-touch operation

### Washing/Drying Station

- Incorporates washing and ULPA-filtered drying modules in one cleanroom-compatible station
- Hands-free, noncontaminating activation
- Optional liquid soap dispenser is ideal for aseptic cleaning



The only cleanroom-compatible, integrated washing/drying station!

Hand/Glove Cleaning Station									
Dimensions (W x D x H) Includes levelers	No. of Sinks	Stainless Steel			Electropolished Stainless Steel			Soap Dispensing Module	
		110VAC/60Hz Cat. #	220VAC/50Hz Cat. #	\$/Each	110VAC/60Hz Cat. #	220VAC/50Hz Cat. #	\$/Each	Order one per sink Cat. #	\$/Each
24" x 22" x 61"	1	9600-60	9600-60-220	4,553.00	9600-05	9600-05-220	5,273.00	9600-64	100.00
48" x 22" x 61"	2	9600-61	9600-61-220	8,998.00	9600-06	9600-06-220	10,439.00	9600-64	100.00
96" x 22" x 61"	4	9600-62	9600-62-220	16,806.00	9600-07	9600-07-220	19,688.00	9600-64	100.00
144" x 22" x 61"	6	9600-63	9600-63-220	24,013.00	9600-08	9600-08-220	28,337.00	9600-64	100.00

## CleanTech® Cleanroom Hand/Glove Washing System

Standardizes control of cycle, duration, and cleansing agent for better compliance with hand-cleaning protocol, cleaner operations

### A. Floor-Mount Station

This free-standing, microprocessor-controlled cleansing station performs wash cycles with reliable, repeatable results. It monitors cycle duration and amount of cleansing agent injected. A self-clean function eliminates bacteria colonization. A cycle counter verifies washing to help meet SSOP, HACCP and GMP programs.

### B. Wall-Mount Station

This unit incorporates all the features of the floor-mount unit except for the self-cleaning cycle. It offers a cycle counter and solutions monitor gauge.



B Wall-Mount



Floor-Mount No. 2121-02

304 Stainless Steel Hand/Glove Cleansing Station					
Water Source	Floor Model		Wall-Mount Model		
	Cat. #	\$/Each	Cat. #	\$/Each	
Tap Water	2121-02	6,950.00	2121-04	2,795.00	
DI Water	2121-03	8,250.00	-	-	

All operate on 120VAC, other voltages available

# Garb and Parts Dispensers



## Garb and Parts Dispensers

### Space-Saving Convenience!

These handy dispensers save space and organize gloves, safety glasses, wipers, hats, and other garb. They're perfect benchtop storage bins for small parts used in cleanroom processing. Select clear acrylic or static-dissipative PVC, which eliminates static charges and the particles they attract.



Item (see photos)	Dimensions W x D x H, in.	Acrylic		Static-Dissipative PVC	
		Cat. #	\$/Each	Cat. #	\$/Each
<b>A. SneezeGuard™</b>	7.12 x 7.75 11 x 11	<b>1601-50</b>	<b>12.00</b>	<b>1601-51</b>	<b>25.00</b>
		<b>1600-25</b>	<b>15.00</b>	<b>1602-75</b>	<b>28.00</b>
<b>B. Wall-Mount Glove Dispenser (single)</b>	16.5 x 12.5 x 17	<b>4950-72</b>	<b>211.00</b>	<b>4950-74</b>	<b>285.00</b>
<b>C. Wall-Mount Glove Dispenser (triple)</b>	16 x 11.5 x 12	<b>4005-56</b>	<b>235.00</b>	<b>4005-57</b>	<b>354.00</b>
<b>D. Benchtop Glove Dispenser*</b>	12 x 6 x 6	<b>4951-03</b>	<b>73.00</b>	<b>4951-04</b>	<b>110.00</b>
<b>E. File Holder (4 slots)</b>	10.5 x 5 x 15	<b>4005-25</b>	<b>85.00</b>	<b>4005-23</b>	<b>151.00</b>
<b>F. Dispensing Bins</b>	5 x 6.25 x 8.25	<b>4950-12</b>	<b>123.00</b>	<b>4950-13</b>	<b>213.00</b>
<b>G. Apparel Dispenser</b>	48.5 x 24.5 x 36	<b>4951-06</b>	<b>3,147.00</b>	<b>4951-07</b>	<b>5,665.00</b>
<b>H. Multi-Chamber Dispenser</b>	15.75 x 8 x 15	<b>4005-51</b>	<b>312.00</b>	<b>4005-50</b>	<b>465.00</b>
<b>I. Wiper Dispenser (enclosed)</b>	12 x 9 x 6	<b>4951-01</b>	<b>80.00</b>	<b>4951-02</b>	<b>142.00</b>
<b>J. Wiper Dispenser (open top)*</b>	10.5 x 14.5 x 4	<b>4950-93</b>	<b>57.00</b>	<b>4950-94</b>	<b>110.00</b>
<b>K. Safety Glasses Dispensers</b> Holds: 8 (all are 5.75"D)	6.75 x 17	<b>4950-45</b>	<b>232.00</b>	<b>4950-46</b>	<b>306.00</b>
	9.75 x 17	<b>4951-15</b>	<b>303.00</b>	<b>4951-16</b>	<b>397.00</b>
	6.75 x 28.25	<b>4951-17</b>	<b>418.00</b>	<b>4951-18</b>	<b>550.00</b>
	13.13 x 17	<b>4951-19</b>	<b>418.00</b>	<b>4951-20</b>	<b>550.00</b>
	9.75 x 28.25	<b>4951-21</b>	<b>543.00</b>	<b>4951-22</b>	<b>714.00</b>
<b>*Now available in stainless steel—see facing page</b>	24 19.5 x 17	<b>4951-23</b>	<b>543.00</b>	<b>4951-24</b>	<b>714.00</b>
	32 13.13 x 28.25	<b>4951-25</b>	<b>751.00</b>	<b>4951-26</b>	<b>990.00</b>
	48 19.5 x 28.25	<b>4951-27</b>	<b>978.00</b>	<b>4951-28</b>	<b>1,284.00</b>

# Stainless Steel Dispensers

*Chemical-resistant • Easy to clean and sterilize*



**L**

Mini-hood provides the ideal equipment enclosure



**M**



**N**



**O**

Catches run-away swabs!



**P**

Ideal for benchtop or wall mounting

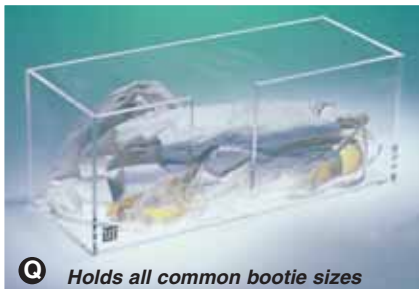

**C**

Holds all common bootie sizes

Plastic models also available



**R**

Ideal for packed sterile gloves



**S**

For loose gloves, hair nets, shoe covers

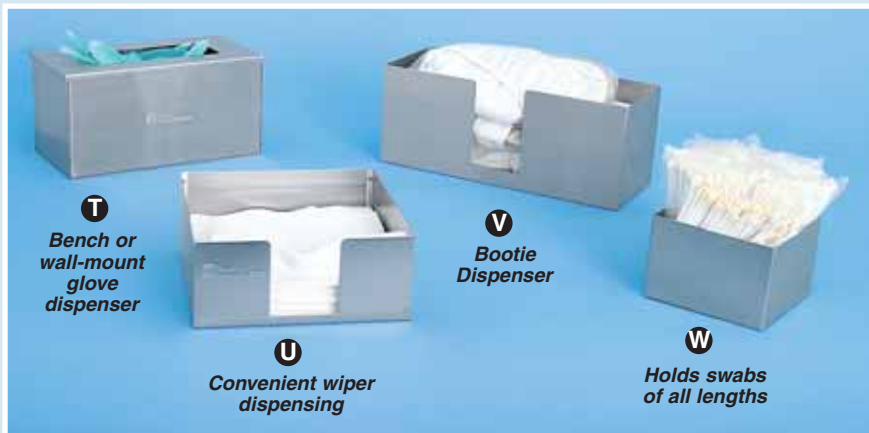

**T**

Bench or wall-mount glove dispenser

**V**

Bootie Dispenser

**U**

Convenient wiper dispensing

**W**

Holds swabs of all lengths

Item (see photos)	Dimensions W x D x H, in.	Acrylic		Static-Dissipative PVC	
		Cat. #	\$/Each	Cat. #	\$/Each
<b>L. Balance Shields</b>	13 x 12 x 12.25	<b>4950-55</b>	<b>166.00</b>	<b>4950-56</b>	<b>264.00</b>
	16.25 x 16.25 x 22	<b>4950-57</b>	<b>213.00</b>	<b>4950-58</b>	<b>355.00</b>
<b>M. Mini-Hood</b>	20 x 16 x 12	<b>4950-89</b>	<b>307.00</b>	<b>4950-90</b>	<b>570.00</b>
<b>N. Mini-Desiccators</b>	8 x 10 x 7.25	<b>4950-06</b>	<b>312.00</b>	<b>4950-08</b>	<b>493.00</b>
	10 x 16 x 9.5	<b>4950-09</b>	<b>432.00</b>	<b>4950-11</b>	<b>686.00</b>
<b>O. Swab Dispenser</b>	6 x 6 x 4	<b>4950-87</b>	<b>37.00</b>	<b>4950-88</b>	<b>61.00</b>
<b>P. Glove Box</b>	one box	<b>4950-81</b>	<b>21.00</b>	<b>4950-82</b>	<b>26.00</b>
	two box	<b>4950-83</b>	<b>36.00</b>	<b>4950-84</b>	<b>51.00</b>
	three box	<b>4950-85</b>	<b>46.00</b>	<b>4950-86</b>	<b>77.00</b>
<b>Q. Bootie Dispenser</b>	15 x 6 x 6	<b>4950-97</b>	<b>65.00</b>	<b>4950-98</b>	<b>92.00</b>

Item (see photos)	Dimensions W x D x H, in.	Electropolished 304 SS	
		Cat. #	\$/Each
<b>R. Glove Dispenser, Wall-mount</b>	34.5 x 7 x 24 (3 compartment)	<b>4951-30-2</b>	<b>1,678.00</b>
	27 x 8 x 24 (4 compartment)	<b>4951-31-2</b>	<b>1,678.00</b>
<b>S. Glove Dispenser, Wall-mount</b>	24 x 8 x 24 (3 compartment)	<b>4951-32-2</b>	<b>1,248.00</b>
	32 x 8 x 24 (4 compartment)	<b>4951-33-2</b>	<b>2,022.00</b>
<b>T. Glove Dispenser</b>	12 x 6 x 6	<b>4951-50-2</b>	<b>88.00</b>
<b>U. Wiper Dispenser</b>	12 x 9 x 6	<b>4951-40-2</b>	<b>96.00</b>
	9.5 x 9.5 x 6	<b>4951-41-2</b>	<b>96.00</b>
	15 x 6 x 6	<b>4951-45-2</b>	<b>110.00</b>
<b>V. Bootie Dispenser</b>	15 x 6 x 6	<b>4951-45-2</b>	<b>110.00</b>
<b>W. Swab Dispenser</b>	6 x 6 x 4	<b>4951-35-2</b>	<b>44.00</b>



# Change Room Racks & Shelving

## Cleanroom Shelving

These economical cleanroom and laboratory shelves use four truss wires for greater strength. Posts allow shelf height adjustment at 1-inch increments. Plastic split sleeves are included with each shelf; for grounding in ESD-sensitive applications, select optional aluminum split sleeves.

### Eaglegard® Hybrid Epoxy: Durability and Microbial Protection

Shelving and posts featuring Eaglegard® hybrid epoxy coatings inhibit the growth of mold, microbes and other organic contaminants. These units carry a 15-year limited warranty.



**Aluminum Split Sleeve**

For grounding. One per shelf required.

1372-38 11.00



Shelves from Eagle								
Dimens* W x L (inches)	Wire Shelves						Solid Shelves	
	Chrome Plated		Stainless Steel		Eaglegard®**		Stainless Steel	
	Cat. #	\$/Each	Cat. #	\$/Each	Cat. #	\$/Each	Cat. #	\$/Each
14 x 36	1370-03	29.00	1370-34	81.00	1372-45	51.00	1370-65	91.00
14 x 48	1370-05	34.00	1370-36	112.00	1372-47	61.00	1370-67	110.00
14 x 60	1370-06	38.00	1370-37	127.00	1372-48	68.00	1370-68	132.00
14 x 72	1370-07	45.00	1370-38	143.00	1372-49	77.00	1370-69	154.00
18 x 36	1370-10	32.00	1370-41	100.00	1372-52	57.00	1370-72	103.00
18 x 48	1370-12	37.00	1370-43	120.00	1372-54	69.00	1370-74	125.00
18 x 60	1370-14	44.00	1370-45	152.00	1372-56	83.00	1370-76	149.00
18 x 72	1370-15	53.00	1370-46	180.00	1372-57	95.00	1370-77	183.00
24 x 36	1370-26	39.00	1370-57	124.00	1372-68	70.00	1370-88	123.00
24 x 48	1370-28	47.00	1370-59	150.00	1372-70	86.00	1370-90	151.00
24 x 60	1370-30	55.00	1370-61	184.00	1372-72	101.00	1370-92	177.00
24 x 72	1370-31	66.00	1370-62	230.00	1372-73	119.00	1370-93	209.00

Each shelf includes 4 pairs of plastic split sleeves. \*\*Hybrid epoxy coating resists growth of microbes.

4-Inch Shelf Ledges for Wire Shelves				
Length* (inches)	Chrome		Stainless Steel	
	Cat. #	\$/Each	Cat. #	\$/Each
14	1371-88	8.00	1371-99	15.00
18	1371-89	9.00	1372-00	17.00
24	1371-91	10.00	1372-02	21.00
36	1371-93	12.00	1372-04	29.00
48	1371-95	15.00	1372-06	36.00
60	1371-97	17.00	1372-08	42.00
72	1371-98	20.00	1372-09	53.00

\* Other sizes available

### Polymer 5" Stem Casters

Use with Mobile Posts (below) to convert your shelves into a mobile shelf cart.

Swivel Caster	1372-41	23.00
Caster with Brake	1372-42	24.00

### Posts—Adjust shelf height at 1" increments

Height (inches)	Stationary						Mobile					
	Chrome Plated		Stainless Steel		Eaglegard®		Chrome Plated		Stainless Steel		Eaglegard®	
	Cat. #	\$/Each	Cat. #	\$/Each	Cat. #	\$/Each	Cat. #	\$/Each	Cat. #	\$/Each	Cat. #	\$/Each
14	1370-94	7.00	1371-01	13.00	1372-74	12.00	1371-08	7.00	1371-15	13.00	1372-81	12.00
18	1370-95	9.00	1371-02	19.00	1372-75	17.00	1371-09	9.00	1371-16	19.00	1372-82	17.00
33	1370-96	9.00	1371-03	21.00	1372-76	17.00	1371-10	10.00	1371-17	23.00	1372-83	17.00
54	1370-97	11.00	1371-04	24.00	1372-77	18.00	1371-11	12.00	1371-18	24.00	1372-84	18.00
63	1370-98	11.00	1371-05	26.00	1372-78	20.00	1371-12	14.00	1371-19	28.00	1372-85	20.00
74	1370-99	12.00	1371-06	30.00	1372-79	21.00	1371-13	17.00	1371-20	30.00	1372-86	21.00
86	1371-00	15.00	1371-07	34.00	1372-80	25.00	1371-14	28.00	1371-21	34.00	1372-87	21.00

For mobile storage, select the correct post and casters above.

## Cleanroom Utility Carts — full line at [www.TerraUniversal.com](http://www.TerraUniversal.com)



Series 200 — Three stainless steel solid shelves



Series 700 — Shown with optional bin. Wire shelves, in a choice of chrome or stainless steel.



Three-Shelf Deep-Ledge Cart Microban® Antimicrobial Formulation Available!

# Controlled Storage

## NitroPlex™ Humidity Control System

**Price Reduction! Unsurpassed %RH control now costs the same as much simpler systems**

- Increases desiccator efficiency up to 400% to minimize nitrogen waste and moisture exposure
- Senses and displays relative humidity in each desiccator chamber independently for more efficient, cost-effective moisture control
- Cuts nitrogen expenses by over 75%
- Prevents moisture and contamination migration from one chamber to another
- Lets you specify a different humidity set point for each chamber
- Automatically delivers a high-flow nitrogen purge only to the chamber where it's needed, and only as long as it's needed to restore RH set point
- Can be integrated into almost any Terra desiccator line

Portable PC docking station  
Sensor/Display Modules (one/chamber). Allow multiplexed humidity control



**Cuts Nitrogen Costs, Increases Efficiency!**

Model shown: No. 3950-36NP, with ten (10) control modules (No. 1911-31) and optional SmartPlex™ computer, stainless steel door frames, and stand.

Miniature LEDs display current humidity and RH set point



Dissipative PVC SmartDesiccator™  
No. 1911-26A (shelves and door frames optional)



Miniaturized LED monitors humidity and displays set point

**Reduces nitrogen cost by 78%!\***



Seconds to install and program!

Electropolished Stainless Steel SmartDesiccator™

Cat. # 1911-02 \$/Each 2,507.00

Automatic RB® (Relief/Bleed) Valve  
One required per cabinet for safe operation.

Cat. # 1600-60B \$/Each 94.00



## SmartDesiccator™ Benchtop Storage System

- Automates dry benchtop storage to eliminate moisture-related degradation and optimize yields
- First-of-its-kind gas control system conserves nitrogen!
- Fully integrated turnkey system takes 30 seconds to install

SmartDesiccators						Shelf		Door Frame	
Chambers	Overall Dimensions (W x D x H)	Materials				Perf. Stainless Steel		Stainless Steel	
		Acrylic		Dissipative PVC		Cat. #	\$/Each	Cat. #	\$/Each
		Cat. #	\$/Each	Cat. #	\$/Each				
1	12" x 12" x 13.25"	1911-15A	821.00	1911-21A	981.00	1935-02	85.00	2200-14	81.00
2	17.12" x 18" x 25.25"	1911-16A	1,299.00	1911-22A	1,960.00	1976-02	121.00	2200-61	127.00
2	22.62" x 18" x 25.25"	1911-17A	1,418.00	1911-23A	2,171.00	1977-02	135.00	2200-60	145.00
2	22.62" x 24" x 25.25"	1911-18A	1,641.00	1911-24A	2,577.00	1978-02	151.00	2200-60	145.00
3	17.12" x 18" x 37.25"	1911-19A	1,901.00	1911-25A	2,585.00	1976-02	121.00	2200-61	127.00
3	22.62" x 18" x 37.25"	1911-20A	2,023.00	1911-26A	3,137.00	1977-02	135.00	2200-60	145.00

\* Performance specifications at TerraUniversal.com

# Garment and Supplies Cabinets

## Garment and Supplies Cabinets

Now in Stainless Steel and Cleanroom Laminate Designs

- Type A:** Garment storage only.
- Type B:** Garment storage and adjustable shelves (order desired type separately).
- Type C:** Adjustable shelves only (order desired type separately).
- Type D:** Includes two chrome-plated wire shelves adjustable in 1" intervals.

All models are fabricated of 304 stainless steel or cleanroom laminated fiberboard. All except type "C" are available with overhead HEPA filter/blower module that showers contents with particle-free air to dislodge and wash away contaminants.



**A** No. 4101-00A with optional hangers



**B** No. 4101-04A with optional hangers and shelves



Model Shown: No. 4205-11  
3,880.00

Custom Configurations to Your Requirements!



**C** No. 4101-09A with optional shelves



**D** No. 4205-00A, two shelves included

## Cleanroom Laminate Garment & Supplies Cabinets

Specifications		Garment Storage Cabinets: Laminate*				Corresponding Shelves				Stands*	
Type	Outside Dimensions (W" x D" x H")	Formica Laminate w/Acrylic Doors		Formica Laminate w/Dissip. PVC Doors		Polypropylene Shelves		Nonconductive Laminate Shelves		Raise cabinet 6" off floor	
		Cat. #	\$/Each	Cat. #	\$/Each	Cat. #	\$/Each	Cat. #	\$/Each	Cat. #	\$/Each
<b>A</b>	Filter/Blower Cabinet Only	36 x 20 x 94	4101-00A 2,811.00	4101-14A 3,441.00	—	—	—	—	4101-45	271.00	
	Cabinet Only	36 x 20 x 78	4101-01A 1,992.00	4101-15A 2,622.00	—	—	—	—	4101-45	271.00	
	Filter/Blower Cabinet Only	36 x 24 x 83	4101-02A 2,578.00	4101-16A 3,210.00	—	—	—	—	4101-46	284.00	
	Cabinet Only	36 x 24 x 67	4101-03A 1,764.00	4101-17A 2,396.00	—	—	—	—	4101-46	284.00	
<b>B</b>	Filter/Blower Cabinet Only	48 x 20 x 94	4101-04A 3,315.00	4101-18A 3,946.00	4101-30	39.00	4101-40	73.00	4101-47	316.00	
	Cabinet Only	48 x 20 x 78	4101-05A 3,022.00	4101-19A 3,652.00	4101-30	39.00	4101-40	73.00	4101-47	316.00	
	Filter/Blower Cabinet Only	48 x 24 x 83	4101-06A 3,000.00	4101-20A 4,261.00	4101-31	39.00	4101-41	73.00	4101-48	328.00	
	Cabinet Only	48 x 24 x 67	4101-07A 2,243.00	4101-21A 2,875.00	4101-31	39.00	4101-41	73.00	4101-48	328.00	
<b>C</b>	Cabinet Only	30 x 14 x 78	4101-09A 1,388.00	4101-23A 1,955.00	4101-32	56.00	4101-42	101.00	4101-50	246.00	
	Cabinet Only	30 x 18 x 78	4101-11A 1,451.00	4101-25A 2,019.00	4101-33	56.00	4101-43	101.00	4101-51	259.00	
	Cabinet Only	36 x 20 x 78	4101-13A 1,577.00	4101-27A 2,144.00	4101-28	56.00	4101-44	101.00	4101-45	271.00	
<b>D</b>	Filter/Blower Cabinet Only	37¾ x 26½ x 86	4205-00A 2,687.00	4205-02A 3,384.00	Additional Wire Shelves (Type D)				Cat. #	\$/Each	
	Cabinet Only	37¾ x 26½ x 72	4205-01A 2,108.00	4205-03A 2,687.00	36"W x 24"D				1300-51	49.00	

\*Height does not include stand. Order stand separately.

# Garment Racks

## A/B. UltraClean™ Cylinder Tube Garment Racks

Made of high-grade electropolished stainless steel, these racks feature sloping 1½"-diameter cylindrical tube frames that are easy to wipe down. Fixed position design keeps garments firmly in place.

See ordering chart below.

## C. UltraClean™ Square Tube Garment Racks

These electropolished racks can be disassembled for easy storage and shipping. They are available with one or two hanger rods, in configurations for closed-loop or detachable hangers (photos C and D).

See ordering chart below.

## D. Fixed Position Hanger Rods

This style is available with square-tube racks. Slots at 3" increments keep garments from bunching together. Requires fixed-position hangers (photo G).

See ordering chart below.

## H. Hook Hanger

This fixed-position hanger includes a hook for hoods, masks and other apparel.

Cat. # \$/Each  
1530-33-2 17.00

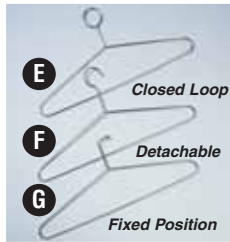

Electropolished Cleanroom Hangers			
Type	For Rack Type	Cat. #	\$/Each
E	C	1530-30-2	13.00
F	A, B or C	1530-31-2	13.00
G	A, B or D	1530-32-2	13.00



**Cylinder Frame Rack**  
(1½"-diameter tubes)  
Overall height: 76"  
For use with detachable hangers.



**Square-Tube Rack**  
Sliding position style  
for use with closed-loop  
or detachable hangers.  
Overall height: 74"



## Electropolished Stainless Steel Garment Storage Racks

Type See photos above	Dimensions	Hanger Capacity (order separately)		A/B. Cylinder Tube Frame (order hanger 1530-32-2 separately)				C/D. Square Tube Frame			
		Single Rack	Dual Rack	A. Single-Rack		B. Dual-Rack		Single-Rack		Dual-Rack	
				Cat. #	\$/Each	Cat. #	\$/Each	Cat. #	\$/Each	Cat. #	\$/Each
C. Sliding Position (order closed loop or detachable hangers)	48"W x 24"D	15	30	—	—	—	—	9230-00-2	827.00	9230-04-2	1,394.00
	60"W x 24"D	19	38	—	—	—	—	9230-01-2	969.00	9230-05-2	1,581.00
	72"W x 24"D	23	46	—	—	—	—	9230-02-2	1,070.00	9230-06-2	1,758.00
	84"W x 24"D	27	54	—	—	—	—	9230-03-2	1,188.00	9230-07-2	1,966.00
A, B, & D. Fixed Position (order fixed position hangers)	48"W x 24"D	15	30	9602-67	1,040.00	9602-75	2,043.00	9230-08-2	993.00	9230-12-2	1,950.00
	60"W x 24"D	19	38	9602-68	1,220.00	9602-76	2,319.00	9230-09-2	1,164.00	9230-13-2	2,213.00
	72"W x 24"D	23	46	9602-69	1,346.00	9602-77	2,580.00	9230-10-2	1,287.00	9230-14-2	2,464.00
	84"W x 24"D	27	54	9602-70	1,494.00	9602-78	2,883.00	9230-11-2	1,427.00	9230-15-2	2,752.00

## Stainless Steel Garment & Supplies Cabinets

Specifications		Garment Storage Cabinets				Shelves		
Type	Outside Dimensions* (W" x D" x H")	Stainless Steel w/Acrylic Doors		Stainless Steel w/Dissip. PVC Doors		Stainless Steel		
		Cat. #	\$/Each	Cat. #	\$/Each	Cat. #	\$/Each	
A	Filter/Blower Cabinet Only	36 x 20 x 100	4101-57A	7,028.00	4101-68A	7,658.00	—	—
	Filter/Blower Cabinet Only	36 x 20 x 84	4101-58A	4,979.00	4101-69A	5,610.00	—	—
	Filter/Blower Cabinet Only	36 x 24 x 89	4101-59A	6,447.00	4101-70A	7,080.00	—	—
	Filter/Blower Cabinet Only	36 x 24 x 73	4101-60A	4,412.00	4101-71A	5,042.00	—	—
B	Filter/Blower Cabinet Only	48 x 20 x 100	4101-61A	8,289.00	4101-72A	8,919.00	4101-83A	265.00
	Filter/Blower Cabinet Only	48 x 20 x 84	4101-62A	7,553.00	4101-73A	8,184.00	4101-83A	265.00
	Filter/Blower Cabinet Only	48 x 24 x 89	4101-63A	6,240.00	4101-74A	8,006.00	4101-84A	265.00
	Filter/Blower Cabinet Only	48 x 24 x 73	4101-64A	5,610.00	4101-75A	6,240.00	4101-84A	265.00
C	Cabinet Only	30 x 14 x 84	4101-65A	3,468.00	4101-76A	4,037.00	4101-85A	265.00
	Cabinet Only	30 x 18 x 84	4101-66A	3,628.00	4101-77A	4,195.00	4101-86A	265.00
	Cabinet Only	36 x 20 x 84	4101-67A	3,944.00	4101-78A	4,511.00	4101-87A	265.00
D	Filter/Blower Cabinet Only	37¼ x 26½ x 94	4101-79A	6,719.00	4101-81A	7,415.00	—	—
	Filter/Blower Cabinet Only	37¼ x 26½ x 78	4101-80A	5,267.00	4101-82A	5,847.00	—	—

\* Height includes built-in stainless steel stand with polypropylene leveling feet.



**Type D Stainless Steel Cabinet**  
(No. 4101-80A, shown with one optional shelf)

See additional construction details on the previous page.

# Gowning Benches



**Tube Top Benches with Easy-Clean Cylinder Frames**



**A Floor-Mounted Solid Top**



**B Free-Standing Solid Top**



**C Free-Standing Tube Top**



**D Free-Standing Tube Top**



**Bootie Racks**  
(available on free-standing benches with square-tube frames)

## UltraClean Stainless Steel Gowning Benches

**Once hands and shoes are cleaned and head gear is in place, you're ready to gown up!**

Terra's UltraClean™ Stainless Steel Gowning Benches provide an ideal gowning surface. Their electropolished 304 stainless steel surfaces won't shed particles or snag wipers during cleaning.

Choose among four designs. Cylinder tube designs eliminate corners for optimal worker comfort, and tube-top designs facilitate vertical laminar air flow (see ordering chart). Free-standing models include polypropylene leveling glides. Floor-mount models ensure that benches remain in a fixed location that supports a designated gowning protocol.

Remember to specify one side of the gowning bench floor as a "clean zone" where operators are not permitted to step with street shoes. This clean zone reduces the number of contaminants passed into the cleanroom. Select the optional bootie rack for convenient, space-saving storage (for use with free-standing models only).

Floor Mounted (see photo A)			Free Standing Design (see photos B, C, D)						Bootie Rack** (see photo E)			
L"x W"x H" Nominal	Solid Top		L"x W"x H"	Solid Top		Tubular Top		D. Tube Top		No. of Slots	Installed	
	Cat. #	\$/Each		Cat. #	(Photo B) \$/Each	Cat. #	(Photo C) \$/Each	Cat. #	(Photo D) \$/Each		Cat. #	\$/Each
36 x 9 x 18	1530-15-2	559.00	36 x 16 x 18	1530-25-2	618.00	1530-10-2	1,098.00	9602-96	1,151.00	12	1560-30-2	603.00
48 x 9 x 18	1530-16-2	613.00	48 x 16 x 18	1530-26-2	722.00	1530-11-2	1,276.00	9602-97	1,329.00	15	1560-31-2	703.00
60 x 9 x 18	1530-17-2	659.00	60 x 16 x 18	1530-27-2	794.00	1530-12-2	1,483.00	9602-98	1,546.00	18	1560-32-2	801.00
72 x 9 x 18*	1530-18-2	730.00	72 x 16 x 18	1530-28-2	854.00	1530-13-2	1,675.00	9602-99	1,744.00	21	1560-33-2	902.00
84 x 9 x 18*	1530-19-2	770.00	84 x 16 x 18	1530-29-2	911.00	1530-14-2	1,834.00	9600-02	1,914.00	24	1560-34-2	1,001.00

\* Includes center leg mount. \*\* Fits on free-standing benches only (order bench separately).



# Gowning Accessories

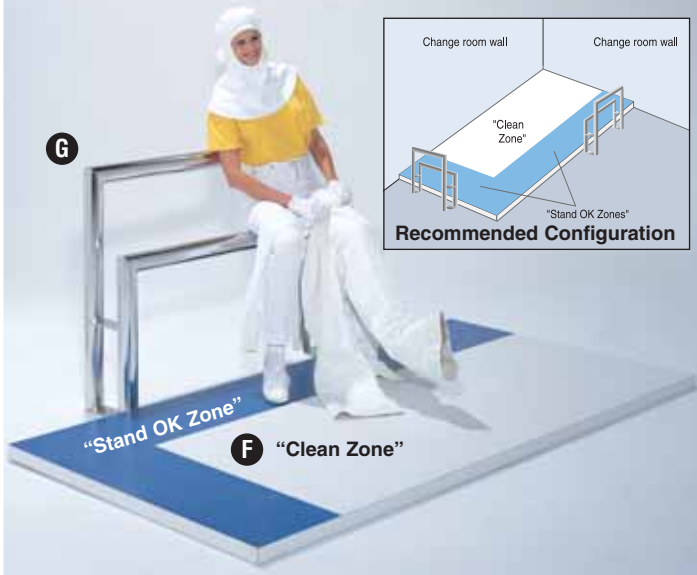

## F. Gowning Platform

The 2" raised platform alerts personnel that they are entering a clean zone with special requirements. Made of composite fiber with a high-grade laminate top and side edges. Dimensions: 48" x 96" x 2".

Cat. # \$/Each  
**9605-49 421.00**

## G. CleanLean™ Lean Rail

Electropolished stainless steel cylinders are positioned at 24" and 36" above floor level. Mounting holes are on 3" centers.

Cat. # \$/Each  
**9605-50 1,074.00**

## H. Cleanroom Mirror

Terra's specially designed Cleanroom Mirror gives personnel a visual self-check to verify proper garmenting before they exit the change room. Sturdy electropolished stainless steel frame mounts flush with wall to prevent particle accumulation.

Size	Cat. #	\$/Each
36" W x 72" H	<b>5252-52A</b>	<b>1,022.00</b>
24" W x 36" H	<b>5252-53</b>	<b>680.00</b>
18" W x 24" H	<b>5252-54</b>	<b>480.00</b>

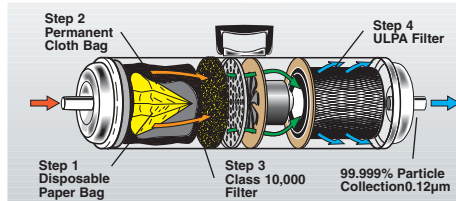

## I. MicroVac™: 3-Way Cleaning

- **Cleans up chemical powder spills**  
ULPA filter captures 99.999% of 0.12µm particles for powder clean-up and collection
- **Clean air blower**  
Nozzles pinpoint ULPA-filtered air stream to clean small parts
- **Clean air ventilator**  
Purges glove boxes, bio cabinets, and other enclosures

	Cat. #	\$/Each
110VAC/60Hz	<b>5100-00</b>	<b>955.00</b>
220VAC/50Hz	<b>5100-00-220</b>	<b>955.00</b>



## J. Gowning Room Shoe/Bootie Cabinet

This electropolished stainless steel cabinet provides clean, organized slots for booties and shoes inside the gowning area. Features ten shelves with 1/4"-diameter perforations—holds up to 60 pairs of booties. Overall dimensions: 48"W x 16"D x 60"H.

Cat. # \$/Each  
**9600-03B 4,084.00**

# Compounding Cleanroom



No. 2900-52A  
(furnishings optional)

## USP <797> Compliant! Pharmaceutical Compounding Clean Room

- Complete turnkey clean room meets Class 100 (ISO 5) cleanliness standards for control of submicron particles, ensuring a clean compounding environment
- Internal sliding curtain creates a separate gowning ante-room, in accord with USP-797 regulations
- Powder-coated steel support frame creates a rigid, durable structure that requires no external bracing or ceiling support
- Mirror-finish electropolished 304 stainless steel trim is easy to clean
- Select softwall or hardwall design, in choice of three materials and two sizes

Terra's Compounding Clean Rooms provide the ideal environment for compounding sterile injectables and other critical operations.

Designed to meet the requirements of USP-797, they include three HEPA filter/fan units that provide a total of 1950 CFM of 99.99% particle-free air (measured at 0.3µm diameter), far exceeding the ISO 8 condition stipulated by USP-797 for compounding clean rooms. In fact, the primary processing area meets ISO 5 (Class 100) cleanliness standards.



Softwall curtains (included on models below) create a separate ante-chamber.

Select between 6'W x 8'L and 6'W x 10'L floor plans. Both rooms include a sliding clean vinyl curtain that creates a separate antechamber for personnel gowning or product staging. In the typical configuration, the primary compounding room accommodates a 6'-long workbench, which provides ample space for a laminar flow hood, as stipulated by ISO-797 requirements (order bench and hood separately).

### Softwall or Hardwall Designs

Terra's softwall clean room features flexible cleanroom vinyl curtains that hang from a quick-install GripTrack™ along the outside perimeter. Curtains come in 4'-wide lengths and hang to about 3" above floor level. A 4'-wide strip shield entry is provided into the antechamber.

Hardwall designs are available with either rigid acrylic or static-dissipative PVC panels. Dissipative PVC offers superior resistance to chemicals, including alcohol and most germicides. By dissipating surface static charges that attract and hold particles, it also enhances contamination control. Two options are available for entry to a hardwall clean room: either parting strip shields or a rigid swing door (order below). All units are 7' high (filter face to floor).

Gauge: 0 – 0.5" WC Magnehelic® Gauge monitors internal positive pressure

Filter/Fan Modules (3 total): Full specifications on page 16.

Filters: 99.99% efficient HEPA filter (rated @ 0.3µm particles)

Power: 120VAC, 50/60 Hz (220VAC available)

Noise: 48 dBA, measured 30" from filter face @ 90 fpm

Light: 120VAC, 50/60Hz fluorescent, 4-tube fixture; generates 4560 foot candles

Curtain: Cleanroom vinyl curtain mounted on roller assembly; adjustable at any point along the 6' width of the clean room to create desired anteroom size

### Casters (For Softwall Clean Rooms Only)

Plate-mount 6"-diameter stainless steel swivel casters feature nonshedding polyurethane wheels. Allow easy positioning of softwall rooms. Set of four.

Cat. # **6704-08** \$/Each **96.00**

### Parting Strip Shields

These 4"-W parting strips provide a convenient entry for hardwall clean rooms (included with softwall rooms listed above). Alternative frosted/clear design minimizes cling for easy parting. Price is per lineal foot; use quantity of (3) to create 3' door for standard hardwall rooms above.

6' 6" Height Cat. # **1320-03A** \$/Each **26.00**

### Swing Doors

Aluminum frame with choice of acrylic or static-dissipative PVC panels and pneumatic closure. Standard mounting is on right side of 6' width, entering the antechamber area. Standard swing is outward (away from room). Dimensions: 80"H x 36"W.

Door Panel Material Cat. # \$/Each  
Acrylic\* **6710-14** **902.00**  
Static-Dissipative PVC **6710-15** **1,199.00**

\*Acrylic is damaged by alcohol and other cleaning agents.

### Compounding Clean Rooms

Panel Type*	Dimensions (nominal)	Cat. #	\$/Each
Softwall	8' x 6'	<b>2900-50A</b>	<b>5,480.00</b>
Softwall	10' x 6'	<b>2900-51A</b>	<b>6,030.00</b>
Hardwall Acrylic**	8' x 6'	<b>2900-52A</b>	<b>8,560.00</b>
Hardwall Acrylic**	10' x 6'	<b>2900-53A</b>	<b>9,220.00</b>
Hardwall SDPVC**	8' x 6'	<b>2900-54A</b>	<b>10,540.00</b>
Hardwall SDPVC**	10' x 6'	<b>2900-55A</b>	<b>11,420.00</b>

Includes (3) filter/fan units, (1) fluorescent light, Magnehelic® gauge and internal roller-mount sliding curtain.

\* See descriptions above.

\*\* Order desired door style (strip shields or swing door) separately (see below). Note: Acrylic is damaged by alcohol and other cleaning agents. Select SDPVC for greater chemical resistance.

# Product Showcase

## Comprehensive Environmental Monitoring!



### Handheld Particle Counters/ RH/Temperature Meters

These NIST-traceable units offer six simultaneous particle-count ranges and display both cumulative and differential particle count data as well as temperature/RH on a touch-screen display. Complete line of options includes printer, air velocity probe, differential pressure probe, and transfer software for data downloading to PC. Meets JIS standards.

Flow rate: 0.1 CFM (2.83 LPM)  
 Concentration limit: 4,000,000/cu. ft.  
 Power: Li-Ion battery  
 Storage memory: 3,000 samples  
 Includes temperature/%RH probe.  
 Two-year warranty.  
 Channel Sizes (µm)

	Cat. #	\$/Each
0.2, 0.3, 0.5, 0.7, 1.0, 2.0	1509-01	5,433.00
0.3, 0.5, 0.7, 1.0, 2.0, 5.0	1509-03	3,277.00
0.3, 0.5, 1.0 3.0, 5.0, 10.0	1509-04	3,277.00
0.5, 0.7, 1.0, 3.0, 5.0, 10.0	1509-08	3,183.00

### Accessories (others available)

Carrying Case	1509-12	169.00
Thermal Printer	1509-13	497.00

### Accessories for Portable Particle Counters \*

	Cat. #	\$/Each
<b>Air Velocity Probe</b> (0 – 200 fpm)	1509-36	534.00
<b>Differential Pressure Probe</b> (0 – 0.5")	1509-37	309.00
<b>Temperature/RH Wand</b>	1509-38	516.00
<b>Filter Scanning Probe</b>		
Models 3100+ / 5100+ (1.0 CFM)	1509-39	394.00
Models 3200+ / 5200+ (2.0 CFM)	1509-40	591.00
<b>Carrying Case with Wheels</b>		
Models 3100+ / 5100+, 3010+ / 5010+	1509-41	539.00
Models 3200+ / 5200+	1509-43	539.00

\* Models 3100+/5100+, 3010+/5010+, 3200+/5200+. Complete information at [TerraUniversal.com](http://TerraUniversal.com).



See accessories chart, below left.

### 3100+/5100+ Portable Particle Counters

These NIST-traceable units display up to six simultaneous particle-count ranges on a 5.7" color touch screen. They store data (up to 3,000 samples) from up to four environmental sensors (4-20 mA). Includes a built-in printer and internal audible alarm. Meets JIS standards. Flow rate: 1.0 CFM (28.3 LPM), Power: Li-Ion battery. Two-year warranty included.

Channel Sizes (µm)	Cat. #	\$/Each
0.3, 0.5, 1.0 3.0, 5.0, 10.0	1509-21	7,922.00
0.5, 0.7, 1.0, 3.0, 5.0, 10.0	1509-23	7,641.00

### 3010+/5010+ Portable Particle Counters — 0.1 CFM Flow Rate

Similar to the 3100+/5100+ models above, these units provide complete environmental monitoring capabilities with a flow rate of 0.1 CFM (2.83 LPM). They allow viewing of up to six particle sizes simultaneously on their large 5.7" color display and include inputs for up to four environmental monitors.

Channel Sizes (µm)	Cat. #	\$/Each
0.3, 0.5, 1.0 3.0, 5.0, 10.0	1509-27	8,766.00
0.5, 0.7, 1.0, 3.0, 5.0, 10.0	1509-29	8,484.00

### 3200+/5200+ Portable Particle Counters — 2.0 CFM Flow Rate

Similar to the 3100+/5100+ models above, these units provide complete environmental monitoring capabilities with a flow rate of 2.0 CFM (50 LPM). They allow viewing of up to six particle sizes simultaneously on their large 5.7" color display and include inputs for up to four environmental monitors.

Channel Sizes (µm)	Cat. #	\$/Each
0.3, 0.5, 1.0 3.0, 5.0, 10.0	1509-31	9,234.00
0.5, 0.7, 1.0, 3.0, 5.0, 10.0	1509-33	9,141.00



### Hand-Held Laser Particle Counter

This NIST-traceable, lightweight unit operates from AC or rechargeable batteries (rechargeable Ni-Mh). The reliable laser sensor provides a long service life. Operates up to 8 hours on a full charge.

Display: Four-line liquid crystal  
 Data Storage: 100 sample records  
 Sample Inlet: Isokinetic Probe  
 Alarms: Low battery, calibration error

### Handheld Laser Particle Counter \*

Particle Size Ranges	Cat. #	\$/Each
0.5µm & 5µm & larger	1506-02	2,693.00
0.3µm & 0.5µm & larger	1506-03	2,805.00

\* Prices on these particle counters are good for domestic (US) orders only.



### Hand-Held Particle Concentration Meter/Particle Counter

**Particle Concentration Meter** – samples air for 6 seconds before displaying particle/cubic foot (or particle/liter) – updates display every 6 seconds.

**Particle Counter** – Continuous count of particles for one minute, providing a count of particles in 0.1 cubic feet of air.

Both models include an isoprobe, power supply, purge filter and calibration certificate.

Display: Seven-digit LED  
 Power: 110 volt charger  
 Battery: Six volt rechargeable NiMH  
 Operating Time: 8 hours continuous

### Handheld Particle Concentration Meter/Particle Counter

Particle Sensitivity	Particle Concentration Meter*	Particle Counter *		
	Cat. #	\$/Each	Cat. #	\$/Each
> 0.5 µm	1506-95	1,876.00	1506-97	1,876.00
> 0.3 µm	1506-96	2,102.00	1506-98	2,102.00

# Terra's Comprehensive Guide to **Critical Environment Solutions**

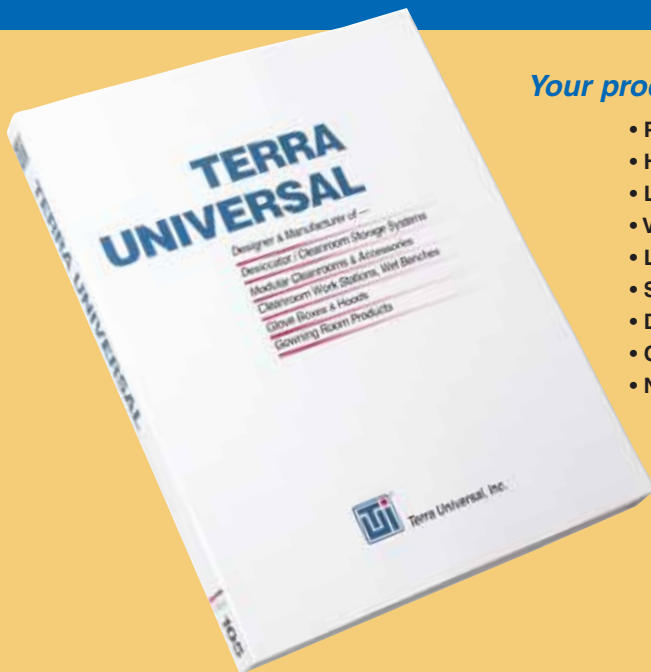

Your product source if you face these challenges –

- Particle Filtration (HEPA, ULPA, Nano)
- Humidification/Dehumidification
- Low/High Temperature
- Vacuum Control
- Laminar Flow Control
- Static Neutralization
- Dissipative Materials
- Chemical Vapor Removal
- Nitrogen & Clean Dry Air Generation
- Antimicrobial Treatments
- Process Gas Conditioning
- Radiation Containment
- Cytotoxin Control
- Ultra-clean Materials
- UV Sterilization
- Ergonomics
- Vibration Isolation

## Get the Complete Story!

Select your free Terra Catalog or download from [www.TerraUniversal.com](http://www.TerraUniversal.com)

Terra's Complete Catalog—688 pages of critical environment solutions

MCAT 10

## Update Mailing Information

### By Fax:

Enter or update data below and fax photocopy to  
**(714) 578-6020**

### By Internet:

**TerraUniversal.com**  
Click on "Contact Terra"  
for an e-mail form

### By Phone:

**(714) 578-6000**

**Add/Correct My Name**  
on your mailing list as shown below.

**Send a FREE Catalog** (select above)  
to the address below.

**Remove the Name**  
printed below from your mailing list.

 **TERRA  
UNIVERSAL.COM**

**Critical Environment Solutions**

800 S. Raymond Ave., Fullerton, CA 92831 USA

**Tel:** 714-578-6000 • **Fax:** 714-578-6020

**TerraUniversal.com • info@TerraUniversal.com**

PRSR STD  
U.S. POSTAGE  
PAID  
TERRA  
UNIVERSAL