

PRODUCT SUMMARY

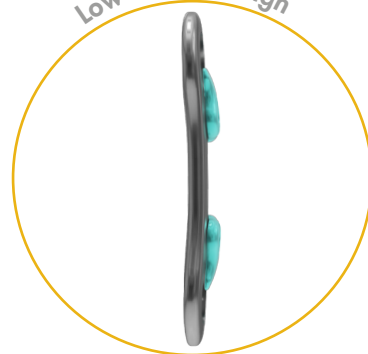

Low Profile Design



Single Step Locking Mechanism



20° Screw Angulation

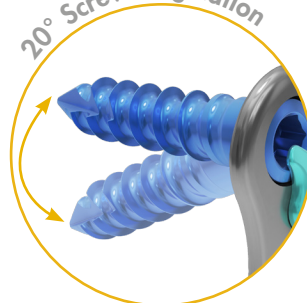

PRECISION SPINE
SLIMPLICITY[®]
ANTERIOR CERVICAL PLATING SYSTEM

Plate (Titanium)

Hybrid Plate (Fixed and Variable Screw Option)

- Size Options (Measurement is conducted from end to end)
- All plate sizes are pre-contoured

Level 1 Lengths	Level 2 Lengths	Level 3 Lengths	Level 4 Lengths
18mm*	33mm*	51mm*	65mm*
20mm	35mm*	54mm	69mm
22mm	37mm	57mm	73mm
24mm	40mm	60mm	77mm
26mm	43mm	63mm	81mm
28mm	46mm	66mm	85mm
30mm	49mm	69mm	89mm
32mm	52mm	72mm	
34mm*	55mm	75mm	

Low Profile Design

- 2mm thickness
- 17mm wide
- 14mm waist
- Radius curvature: 120mm



17mm Wide →

14mm Waist →



Screws (Self-Drilling & Self-Tapping)

- Hex 2.5mm

4.0mm Diameter

Lengths
12mm
14mm
16mm
18mm
20mm*

4.5mm Diameter (Rescue Screw)

Lengths
12mm
14mm
16mm
18mm
20mm*

Variable

Fixed

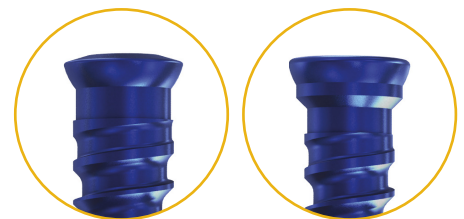

Fixation Pin

- 10mm length
- Hex 2.5mm
- 2mm major diameter

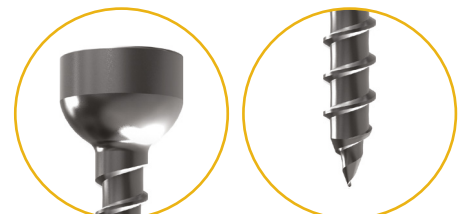

*Upon Request

Screw Angulation

- 20° angulation (4.0mm variable screws)
- 14° angulation (4.5mm variable screws)

4.0mm - 20°

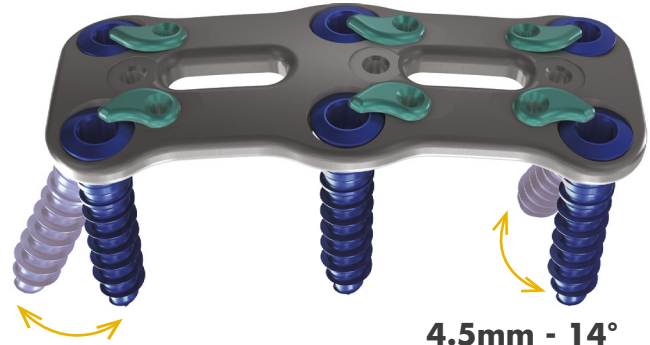

4.5mm - 14°

Kyphotic and Lordotic Plate Bender

Kyphosis



Lordosis



Locking Tool

Lock/Unlock Tool

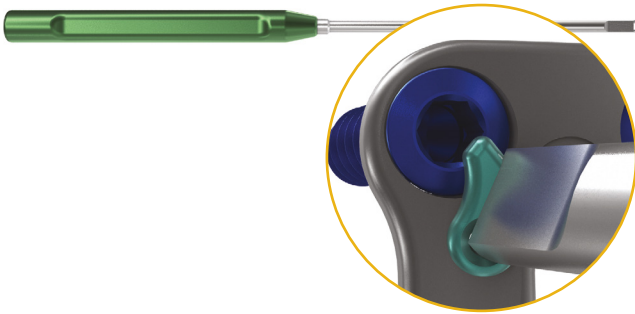

Dual Locking Tool

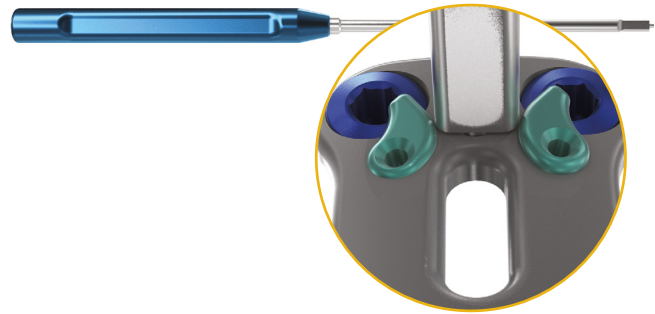

Drill Guide (Fixed and Variable)

Fixed

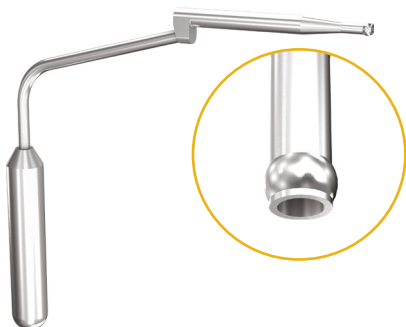

Variable



Simplicity® - Top Tray (Tray Number 21-1015-CA)

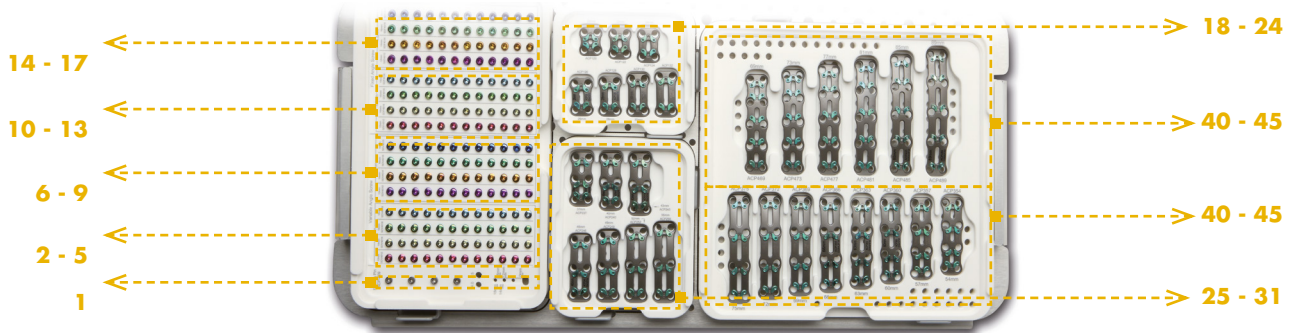

#	Part No.	Description	Qty	#	Part No.	Description	Qty
1	ACP-009	Fixation Pin (Bone Tack)	4	24	ACP132	Anterior Cervical Plate 1-Level 32mm	1
2	SDV4012	4.0mm x 12mm SD Variable	12		ACP134*	Anterior Cervical Plate 1-Level 34mm	
3	SDV4014	4.0mm x 14mm SD Variable	12		ACP233*	Anterior Cervical Plate, 2-Level, 33mm	
4	SDV4016	4.0mm x 16mm SD Variable	12		ACP235*	Anterior Cervical Plate 2-Level 35mm	
5	SDV4018	4.0mm x 18mm SD Variable	12	25	ACP237	Anterior Cervical Plate 2-Level 37mm	1
	SDV4020*	4.0mm x 20mm SD Variable Screw		26	ACP240	Anterior Cervical Plate 2-Level 40mm	1
6	SDV4512	4.5mm x 12mm SD Variable	12	27	ACP243	Anterior Cervical Plate 2-Level 43mm	1
7	SDV4514	4.5mm x 14mm SD Variable	12	28	ACP246	Anterior Cervical Plate 2-Level 46mm	1
8	SDV4516	4.5mm x 16mm SD Variable	12	29	ACP249	Anterior Cervical Plate 2-Level 49mm	1
9	SDV4518	4.5mm x 18mm SD Variable	12	30	ACP252	Anterior Cervical Plate 2-Level 52mm	1
	SDV4520*	4.5mm x 20mm SD Variable Screw		31	ACP255	Anterior Cervical Plate 2-Level 55mm	1
10	SDF4012	4.0mm x 12mm SD Fixed Screw	12		ACP351*	Anterior Cervical Plate, 3-Level, 51mm	
11	SDF4014	4.0mm x 14mm SD Fixed Screw	12	32	ACP354	Anterior Cervical Plate 3-Level 54mm	1
12	SDF4016	4.0mm x 16mm SD Fixed Screw	12	33	ACP357	Anterior Cervical Plate 3-Level 57mm	1
13	SDF4018	4.0mm x 18mm SD Fixed Screw	12	34	ACP360	Anterior Cervical Plate 3-Level 60mm	1
	SDF4020*	4.0mm x 20mm SD Fixed Screw		35	ACP363	Anterior Cervical Plate 3-Level 63mm	1
14	SDF4512	4.5mm x 12mm SD Fixed Screw	12	36	ACP366	Anterior Cervical Plate 3-Level 66mm	1
15	SDF4514	4.5mm x 14mm SD Fixed Screw	12	37	ACP369	Anterior Cervical Plate 3-Level 69mm	1
16	SDF4516	4.5mm x 16mm SD Fixed Screw	12	38	ACP372	Anterior Cervical Plate 3-Level 72mm	1
17	SDF4518	4.5mm x 18mm SD Fixed Screw	12	39	ACP375	Anterior Cervical Plate 3-Level 75mm	1
	SDF4520*	4.5mm x 20mm SD Fixed Screw			ACP465*	Anterior Cervical Plate, 4-Level, 65mm	
	ACP118*	Anterior Cervical Plate, 1-Level, 18mm		40	ACP469	Anterior Cervical Plate 4-Level 69mm	1
18	ACP120	Anterior Cervical Plate 1-Level 20mm	1	41	ACP473	Anterior Cervical Plate 4-Level 73mm	1
19	ACP122	Anterior Cervical Plate 1-Level 22mm	1	42	ACP477	Anterior Cervical Plate 4-Level 77mm	1
20	ACP124	Anterior Cervical Plate 1-Level 24mm	1	43	ACP481	Anterior Cervical Plate 4-Level 81mm	1
21	ACP126	Anterior Cervical Plate 1-Level 26mm	1	44	ACP485	Anterior Cervical Plate 4-Level 85mm	1
22	ACP128	Anterior Cervical Plate 1-Level 28mm	1	45	ACP489	Anterior Cervical Plate 4-Level 89mm	1
23	ACP130	Anterior Cervical Plate 1-Level 30mm	1				

Simplicity - Bottom Tray (Tray Number 21-1015-CA)

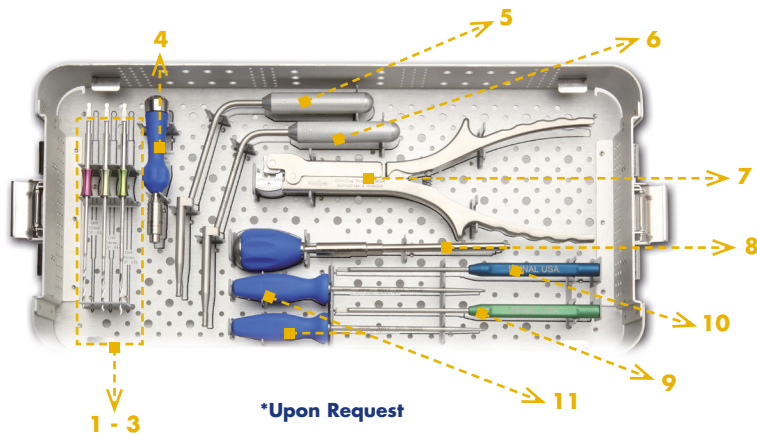

#	Part No.	Description	Qty
1	ACP-012	Drill 3.0 x 12mm	1
2	ACP-014	Drill 3.0 x 14mm	1
3	ACP-016	Drill 3.0 x 16mm	1
4	04-9024	Universal Straight Handle	1
5	ACP-005V	Variable Drill Guide	1
6	ACP-005F	Fixed Drill Guide	1
7	ACP-003	Cervical Plate Bender	1
8	ACP-006	Bone Awl	1
9	00-9023	ACP Lock/Unlock Tool	1
10	00-9021	ACP Locking Tool	1
11	00-9027	2.5mm Tapered Hex Screwdriver	2



Precision Spine, Inc.
2050 Executive Drive, Pearl, MS 39208
Customer Service: 1-888.241.4773
Fax: 601.420.5501

www.precisionspineinc.com

Please refer to package insert (LBLFU-005 Rev.B) for complete system description, indications and warnings.
Caution: Federal (USA) law restricts these devices to sale by or on the order of a physician.
Precision Spine® and Simplicity® are trademarks of Precision Spine, Inc.
Copyright © 2016 Precision Spine, Inc. all rights reserved. LBLFB-043 Rev.B.