



**HAVELLS**



**PROFESSIONAL LUMINAIRES  
INDUSTRIAL / INSTITUTIONAL**

LIST PRICE w.e.f. 1st July, 2018

# Lighting with Innovation at Havells

At Havells, we believe light is the fourth dimension of architecture. It can guide and direct. It can also enhance and show objects in its dynamic and marvelous self.

We understand every space needs lighting that is tailor-made for it, enhances it and brings everything to life; and it is this property that has been the hallmark in every product that comes out of our factory.

Our luminaires are not merely tools of illumination but the torchbearers of a new era in lighting. They stand testimony to our strength in manufacturing, from OPTO electronics to LED technology and integrating them in our state-of-the-art plants.

Our customers can rely on every aspect of safety, performance and reliability from our products.

And now we present our latest offerings, designed taking into consideration the feedback received from clients, customers and designers alike:

**Office Lighting:** Paradigms have been redefined with the advent of open plan offices. We are proud to present our range of lighting products for a brighter and more productive office space.

**Street Lights:** Smart cities evolving in India demand Next-Gen lighting. Havells street lighting range encompasses all the features that are needed for a more efficient lighting system.

**Landscape Lighting:** The Havells range of landscape lighting products have been revamped and new products introduced, to keep in sync with market dynamics and needs.

**Industrial Lighting:** The 'Make in India' initiative has given rise to a new set of high-tech industries all over India. The Havells industrial lighting range aims to provide a wide range of lighting solutions to new and existing industries.

**Retail Lighting:** Retail shopping is all about experience. With Havells retail lighting, deliver new and exciting experiences to customers..

**Solar Lighting:** Ambitious solar growth in India demands light fittings that are rugged, durable and in tune with latest industry standards. Our range of solar lighting goes a step ahead. People and the environmental footprint are central to our approach and form the basis of our sustainable policy.

We combine our innovation and extensive experience to create lighting solutions that makes people feel good not only visually but also emotionally.





QRG TOWERS



HAVELLS

SYLVANIA

GRANITE

SUNBIRD

QRG

QRG Towers  
2D, Sector -126, Noida-

# Introduction of Plant



# CERTIFICATION

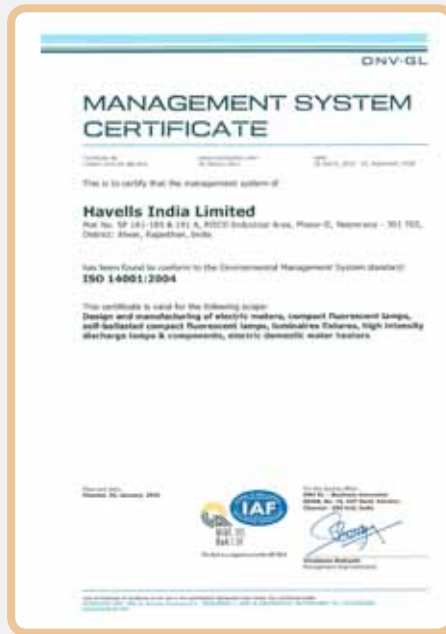

Havells lighting plant in Neemrana is spread over 30 acres of land with over 2,00,000 square feet of working space under a single roof. The plant has been made keeping in mind the global markets of Europe, US and the Middle East. Setting new benchmarks in the industry, this Havells plant will help bridge the technological divide between Europe and India when it comes to manufacturing high-end lighting luminaries.

Japanese flexible CNC controlled steel fabrication process for the accuracy in sheet punching & bending Italian robotised box bending machines to design complex enclosure shapes without human intervention Automated powder coating paint shop to minimize wastage & fast colour change Eco-friendly zero discharge plant Parabolic rolling machine for replicating complex and accurate forms and shapes Flexible assembly line Modern laboratories

Building customer confidence by providing a wide range of quality products and service through team work



“PAN India Illumination-Maruti Nexa Showrooms”

# INDEX

## PROFESSIONAL LUMINAIRES (INDUSTRIAL / INSTITUTIONAL)



### Indoor Commercial LED Luminaires

Architectural Range	12-14
Batten	15
Retrofit Lamps	16-17
Panel Lighting	18-20
Downlight	21-27
Dimmable Luminaires	28

Highbay Lights	32-33
Clean Room Lights	34-35

### Industrial LED Luminaires



### Outdoor LED Luminaires

Flood Lights	38-39
Landscape Lights	40-42
Street Lights	43-44
Solar Street Lights/Mini Mast	45-46



### Conventional Luminaires Portfolio

Luminaires	50-52
Accessories	53-54
Lamps	55-56



# PRODUCT CODE

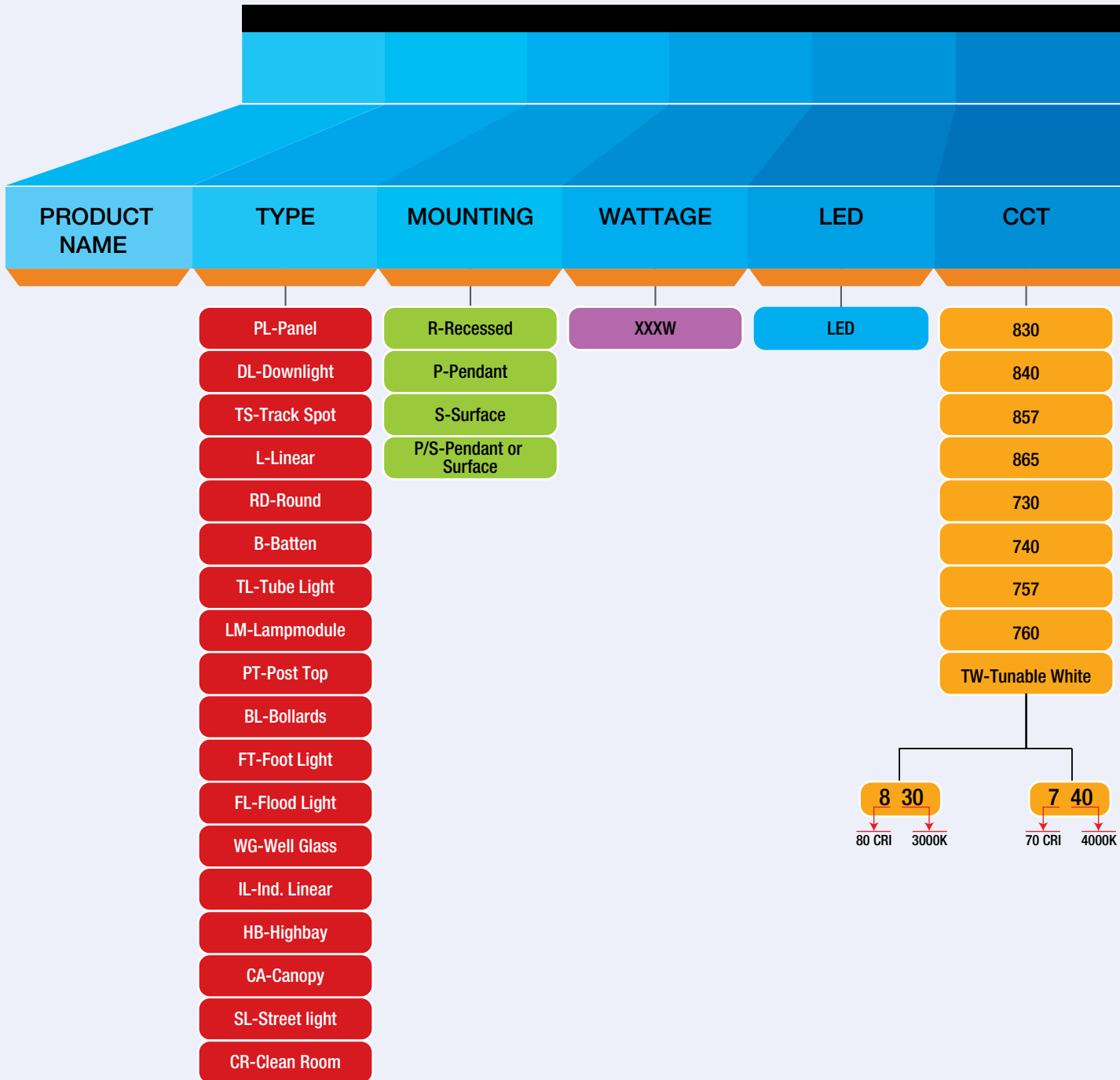

## EXAMPLES:

PRODUCT NAME	TYPE	MOUNTING	WATTAGE	LED	CCT
<b>BAYBRITESAUCERHB200WLED757WBTOLTG</b>					
BAYBRITESAUCER	HB	P	200W	LED	757
<b>ENDURPEARLSL15WLED757SASYTOPC</b>					
ENDURPEARL	SL	-	15W	LED	757
<b>VENUSNEOHE2X2PLR18-42WLED857MOD</b>					
VENUSNEOHE2X2	PL	R	34W	LED	857



# NOMENCLATURE

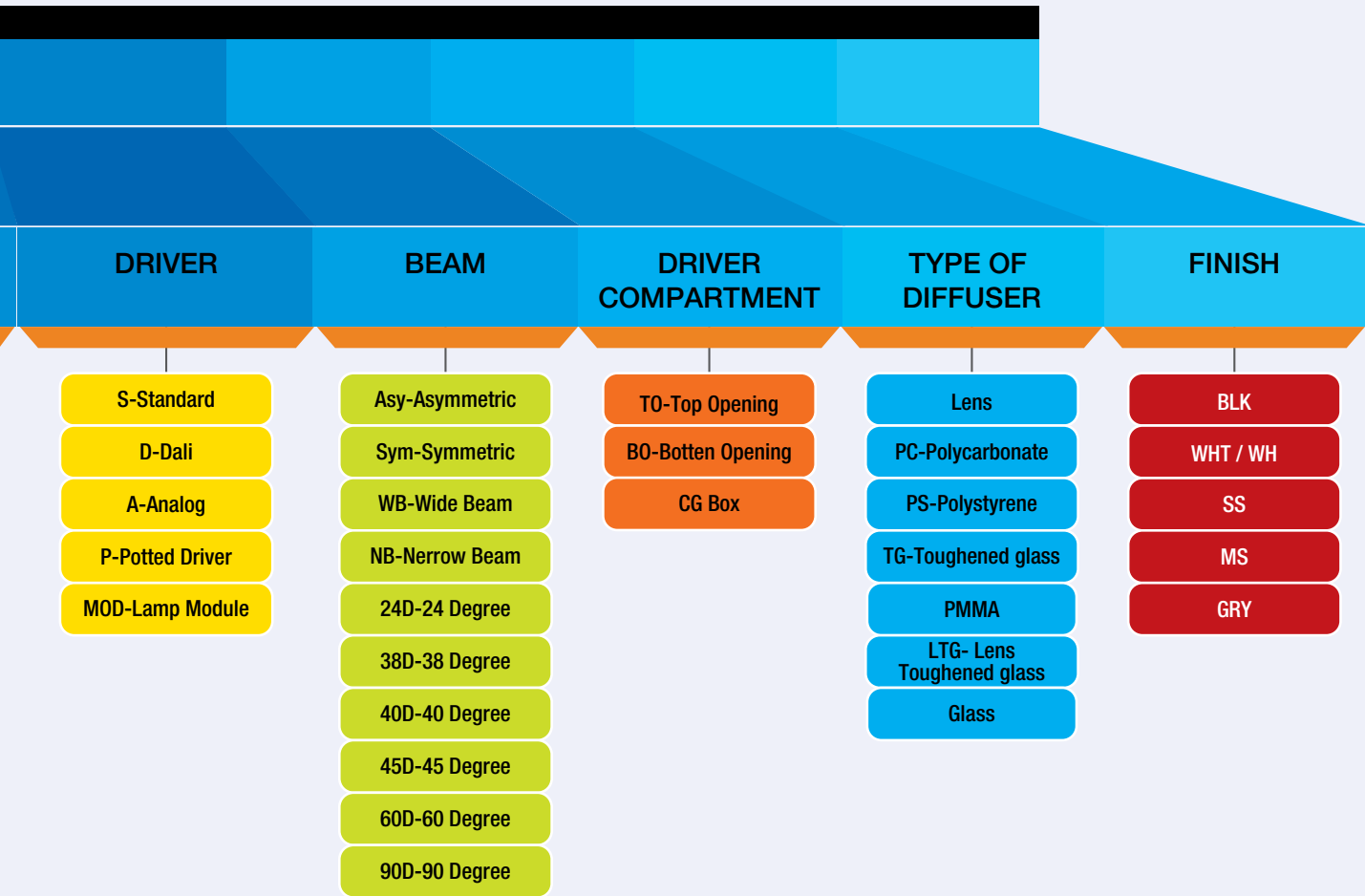

DRIVER	BEAM	DRIVER COMPARTMENT	TYPE OF DIFFUSER	FINISH
-	WB	TO	LTG	-
S	ASY	TO	PC	-
S	-	-	-	-



# Indoor Commercial LED Luminaires

Indoor lighting is an art. Havells understands human centric lighting which improves well-being and increases productivity. Hallmark of every luminaires shipped from Havells factory is a silent whisper of creativity and technology at its best.

### DESTELLO SUSPENDED

Uniquely clean & simple lighting system offering continuous, uniform lines of light across ceilings. The aluminium extruded suspended light gives continuous lines of light distribution with the possibility of various shapes (suspension system included).

Item Description	HSN Code	List Price (₹)	Case Lot (No)
DESTELLO50LP/S25WLED840SPMMAWH	9405	6650/-	04
DESTELLO50LP/S25WLED857SPMMAWH	9405	6650/-	04
DESTELLO50LP/S36WLED840SPMMAWH	9405	7250/-	04
DESTELLO50LP/S36WLED857SPMMAWH	9405	7250/-	04
DESTELLO70LP/S25WLED840SPMMAWH	9405	7650/-	04
DESTELLO70LP/S25WLED857SPMMAWH	9405	7650/-	04
DESTELLO70LP/S36WLED840SPMMAWH	9405	8250/-	04
DESTELLO70LP/S36WLED857SPMMAWH	9405	8250/-	04

Fixture size in mm (LxWxH) 1137x53x76 for (50 mm), 1137x73x86 for (70 mm).

Joining kit and Mains cable to be ordered separately.

Also available in 2 ft and 8 ft length - refer TDS for ordering codes.



### DESTELLO RECESSED

Uniquely clean & simple lighting system offering continuous, uniform lines of light across ceilings. The aluminium extruded recessed light meant for POP/Gypsum ceilings gives continuous lines of light distribution with the possibility of various shapes (recess mounting clamps included).

Item Description	HSN Code	List Price (₹)	Case Lot (No)
DESTELLO50LR25WLED840SPMMAWH	9405	6650/-	04
DESTELLO50LR25WLED857SPMMAWH	9405	6650/-	04
DESTELLO50LR36WLED840SPMMAWH	9405	7250/-	04
DESTELLO50LR36WLED857SPMMAWH	9405	7250/-	04
DESTELLO70LR25WLED840SPMMAWH	9405	7650/-	04
DESTELLO70LR25WLED857SPMMAWH	9405	7650/-	04
DESTELLO70LR36WLED840SPMMAWH	9405	8250/-	04
DESTELLO70LR36WLED857SPMMAWH	9405	8250/-	04

Fixture size in mm (LxWxH) 1148x67x73 for (50 mm), 1148x89x86 for (70 mm).

Joining kit and Mains cable to be ordered separately.

Also available in 2 ft and 8 ft length - refer TDS for ordering codes.



### DESTELLO SUSPENDED DIRECT-INDIRECT

Uniquely clean & simple lighting system offering, uniform lines of light across ceilings. The aluminum extruded direct-indirect light effect gives homogenous light distribution effect & enhances the visual comfort (suspension system included).

Item Description	HSN Code	List Price (₹)	Case Lot (No)
DESTELLODILP36WLED840SPMMAWH	9405	8650/-	04
DESTELLODILP36WLED857SPMMAWH	9405	8650/-	04

Fixture size in mm (LxWxH) 1136x54x74.

Joining kit and Mains cable to be ordered separately.

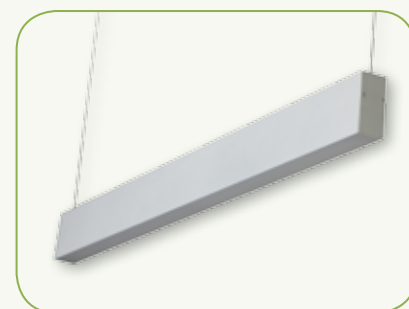

### SABER

SABER LED merges classic styling with cutting edge technology to provide quality illumination and superior optical control. Use of direct/ indirect LED light engines makes it excellent choice for low height ceiling applications and areas where ceiling uniformity and indirect lighting is important (suspension system included).

Item Description	HSN Code	List Price (₹)	Case Lot (No)
SABERLP36WLED840SPMMAWH	9405	10950/-	02
SABERLP36WLED857SPMMAWH	9405	10950/-	02

Fixture size in mm (LxWxH) 1283x163x46.

Joining kit and Mains cable to be ordered separately.



# Indoor Commercial LED Luminaires

## ARCHITECTURAL RANGE

### LICON

LICON LED merges classic styling with cutting edge technology to provide quality illumination and superior optical control. Use of direct/ indirect LED light engines makes it excellent choice for low height ceiling applications and areas where ceiling uniformity and indirect lighting is important (secondary suspension kit included).

Item Description	HSN Code	List Price (₹)	Case Lot (No)
LICONLP36WLED840SPCGRY	9405	8650/-	01
LICONLP36WLED857SPCGRY	9405	8650/-	01

Fixture size in mm (LxWxH) 1206x170x40.

Primary suspension kit with mains cable to be ordered separately.



### TECHZONE

Uniquely clean & simple lighting system offering continuous light for Armstrong Techzone ceiling system. The minimal design offers outstanding visual comfort with end to end seamless integration

Item Description	HSN Code	List Price (₹)	Case Lot (No)
TECHZONELR28WLED840SPMMAWH	9405	6650/-	01
TECHZONELR28WLED857SPMMAWH	9405	6650/-	01

Fixture size in mm (LxWxH) 1196x146x102.



### WINGO

Specially designed direct-indirect transparent optical system which provides sufficient light levels on work plane and at the same time illuminating the ceiling with a harmonious and pleasant appearance.

Item Description	HSN Code	List Price (₹)	Case Lot (No)
WINGOLP40WLED830SPMMABLK	9405	13500/-	01
WINGOLP40WLED840SPMMABLK	9405	13500/-	01
WINGOLP40WLED857SPMMABLK	9405	13500/-	01

Fixture size in mm (LxWxH) 1112x280x48.



### CONSTA LED

Suspended architectural LED luminaire provides soft-light and glare free symmetrical illumination (with continuous mounting end cap).

Item Description	HSN Code	List Price (₹)	Case Lot (No)
CONSTA544LP20WLED830SPMMAWH	9405	2780/-	04
CONSTA544LP20WLED840SPMMAWH	9405	2780/-	04
CONSTA544LP20WLED857SPMMAWH	9405	2780/-	04
CONSTA1144LP40WLED830SPMMAWH	9405	4750/-	04
CONSTA1144LP40WLED840SPMMAWH	9405	4750/-	04
CONSTA1144LP40WLED857SPMMAWH	9405	4750/-	04

Fixture size in mm (LxWxH) 600x106x60 (for 20 W) & 1200x106x60 (for 40 W).

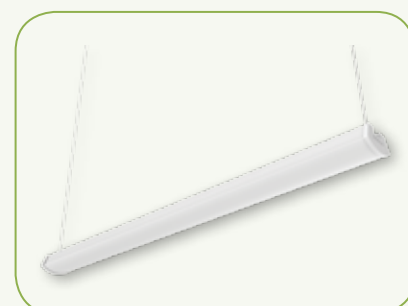

# Indoor Commercial LED Luminaires

ARCHITECTURAL RANGE

## MONDO

Mondo is a suspended LED luminaire that combines uncompromising design with high lighting levels and good ergonomics. The circular model is a good alternative for general lighting purposes.

Item Description	HSN Code	List Price (₹)	Case Lot (No)
MONDO400RDP/S25WLED830SPSWH	9405	7950/-	04
MONDO400RDP/S25WLED840SPSWH	9405	7950/-	04
MONDO400RDP/S25WLED857SPSWH	9405	7950/-	04
MONDO600RDP/S36WLED830SPSWH	9405	13950/-	02
MONDO600RDP/S36WLED840SPSWH	9405	13950/-	02
MONDO600RDP/S36WLED857SPSWH	9405	13950/-	02

Fixture size in mm Dia 400, Height 70 for (400 mm), Dia 600, Height 70 for (600 mm).  
Mounting Kits to be ordered separately.



## ACCESSORIES FOR SUSPENDED LIGHTS (To be ordered separately)

Item Description	HSN Code	List Price (₹)	Case Lot (No)
3COREMAINSABLE1.5MTRWH	7616	220/-	50
JOININGKITFORDESTELLO50P/S/DI	7616	150/-	25
JOININGKITFORDESTELLO50/70R	7616	150/-	25
JOININGKITFORSABER	7616	255/-	25
JOININGKITFORDESTELLO70P/S	7616	150/-	25
MONDOMOUNTINGKITP	7415	450/-	25
MONDOMOUNTINGKITS	7415	450/-	25
LICONSUSKITWITHMAINSABLE	7415	375/-	01



# Indoor Commercial LED Luminaires

## BATTEN

### LUMILINE

Basic all purpose surface and wall mounted LED batten with polycarbonate housing & integrated electronic driver.

Item Description	HSN Code	List Price (₹)	Case Lot (No)
LUMILINEBS9WLED830SPCWH	9405	510/-	10
LUMILINEBS9WLED840SPCWH	9405	510/-	10
LUMILINEBS9WLED865SPCWH	9405	510/-	10
LUMILINEBS18WLED830SPCWH	9405	625/-	10
LUMILINEBS18WLED840SPCWH	9405	625/-	10
LUMILINEBS18WLED865SPCWH	9405	625/-	10
LUMILINEBS20WLED830SPCWH	9405	640/-	10
LUMILINEBS20WLED840SPCWH	9405	640/-	10
LUMILINEBS20WLED865SPCWH	9405	640/-	10

Fixture size in mm (LxWxH) 600x25x40 (for 9 W), 1150x25x40 (for 18 W) & 1150x25x40 (for 20 W).



### ENDURA LINEAR NEO

Surface and wall mounted LED batten, extruded aluminium housing provided for efficient heat dissipation with polycarbonate diffuser & integrated electronic driver.

Item Description	HSN Code	List Price (₹)	Case Lot (No)
ENDURALINEARNEOBS10WLED830SPCWH	9405	975/-	10
ENDURALINEARNEOBS10WLED840SPCWH	9405	975/-	10
ENDURALINEARNEOBS10WLED865SPCWH	9405	975/-	10
ENDURALINEARNEOBS20WLED830SPCWH	9405	1335/-	10
ENDURALINEARNEOBS20WLED840SPCWH	9405	1335/-	10
ENDURALINEARNEOBS20WLED865SPCWH	9405	1335/-	10
ENDURALINEARNEOBS22WLED830SPCWH	9405	1385/-	10
ENDURALINEARNEOBS22WLED840SPCWH	9405	1385/-	10
ENDURALINEARNEOBS22WLED865SPCWH	9405	1385/-	10

Fixture size in mm (LxWxH) 600x108x62 (for 10 W) & 1200x108x62 (for 20 W/22 W).



### STOUT PLUS

Stout Plus LED is a complete range of industrial LED battens to replace traditional T8 battens (600mm & 1200mm). The range is perfect for lighting large areas such as corridors, warehouses & general purpose spaces.

Item Description	HSN Code	List Price (₹)	Case Lot (No)
STOUTPLUS600BS20WLED840SPCWH	9405	2350/-	04
STOUTPLUS600BS20WLED857SPCWH	9405	2350/-	04
STOUTPLUS1200BS40WLED840SPCWH	9405	3250/-	04
STOUTPLUS1200BS40WLED857SPCWH	9405	3250/-	04

Fixture size in mm (LxWxH) 605x66x76 for 20 W, 1205x66x76 for 40 W.



### REGAL BATTEN FOR LED TUBE

Universal batten for T5 and T8 lamps.

Item Description	HSN Code	List Price (₹)	Case Lot (No)
REGALBATTENT8UPTO1X22WSSBSWH	9405*	315/-	10
REGALBATTENT8UPTO2X22WSSBSWH	9405*	370/-	10
REGALBATTENT8UPTO1X22WDSBSWH	9405*	315/-	10
REGALBATTENT8UPTO2X22WDSBSWH	9405*	370/-	10
REGALBATTENT5UPTO1X18WDSBSWH	9405*	315/-	10

LED Tubes to be ordered separately.



### CRYSTAL GLASS LED TUBELIGHT (Double Side Connection)

Ultra bright glass LED Tubelight with very high efficacy suited for installation in existing T8 fitting with G13 lamp holders.

Item Description	HSN Code	List Price (₹)	Case Lot (No)
CRYSTAL1213T8DSTL13WLED865SGLASS	9405	410/-	20
CRYSTAL1213T8DSTL15WLED865SGLASS	9405	410/-	20
CRYSTAL1213T8DSTL18WLED865SGLASS	9405	415/-	20
CRYSTAL1213T8DSTL20WLED865SGLASS	9405	425/-	20



### PHOTON ULTRA LED TUBELIGHT (Single Side Connection)

Ultra bright LED polycarbonate Tubelight with very high efficacy suited for installation in existing T8 fitting with G13 lamp holders.

Item Description	HSN Code	List Price (₹)	Case Lot (No)
PHOTONULTRA603T8SSTL10WLED865SPC	9405	430/-	10
PHOTONULTRA1213T8SSTL13WLED865SPC	9405	615/-	25
PHOTONULTRA1213T8SSTL15WLED865SPC	9405	625/-	25
PHOTONULTRA1213T8SSTL18WLED865SPC	9405	630/-	25
PHOTONULTRA1213T8SSTL20WLED865SPC	9405	640/-	25



### PHOTON ULTRA PLUS LED TUBELIGHT (Single Side Connection)

Ultra bright LED polycarbonate Tubelight with <10% THD with very high efficacy suited for installation in existing T8 fitting with G13 lamp holders.

Item Description	HSN Code	List Price (₹)	Case Lot (No)
PHOTONULTRA+603T8SSTL10WLED865SPC	9405	545/-	10
PHOTONULTRA+1213T8SSTL13WLED865SPC	9405	690/-	25
PHOTONULTRA+1213T8SSTL15WLED865SPC	9405	695/-	25
PHOTONULTRA+1213T8SSTL18WLED865SPC	9405	700/-	25
PHOTONULTRA+1213T8SSTL20WLED865SPC	9405	705/-	25



### TITANIA NEO LED TUBELIGHT (Single Side Connection)

Ultra bright integrated aluminum heat sink LED Tubelight with high efficacy suited for installation in existing T8 fitting with G13 lamp holders.

Item Description	HSN Code	List Price (₹)	Case Lot (No)
TITANIANEO1213T8SSTL18WLED865SPC	9405	725/-	25
TITANIANEO1213T8SSTL20WLED865SPC	9405	735/-	25



### CRYSTAL SLEEK GLASS T5 LED TUBELIGHT (Double Side Connection)

Ultra bright glass LED tubelight with internal driver and high efficacy suited for installation in existing T5 fitting with G5 lamp holders.

Item Description	HSN Code	List Price (₹)	Case Lot (No)
CRYSTAL549T5DSTL8WLED865SGLASS	9405	415/-	30
CRYSTAL1149T5DSTL16WLED865SGLASS	9405	615/-	30





# Indoor Commercial LED Luminaires

## RETROFIT LAMPS

### TITANIA SLEEK NEW T5 LED TUBELIGHT (Double Side Connection)

Ultra bright LED Tubelight with aluminium heat sink & polycarbonate diffuser having high efficacy suited for installation in existing T5 fitting with G5 lamp holders, LED driver outside.

Item Description	HSN Code	List Price (₹)	Case Lot (No)
TITANIASLEEK549T5DSTL9WLED865SPC	9405	645/-	10
TITANIASLEEK1149T5DSTL18WLED865SPC	9405	865/-	25



### PHOTON ULTRA PL-L

Ultra bright LED PL-L with very high efficacy suited for installation in existing 2G11 lamp holders.

Item Description	HSN Code	List Price (₹)	Case Lot (No)
PHOTONULTRAPLL222TL9WLED865SPC	9405	650/-	25
PHOTONULTRAPLL419TL18WLED865SPC	9405	740/-	25



### LED FLEXI STRIP

Flexible LED strip uses high brightness SMD LED as the light source for indoor application only. It is highly suitable for cove-lighting, decorative lighting etc.

Item Description	HSN Code	List Price (₹)	Case Lot (No)
FLEXISTRIP5MTRIP2024WLED830S	9405	1190/-	01
FLEXISTRIP5MTRIP2024WLED860S	9405	1190/-	01
FLEXISTRIP5MTRIP2055WLED830S	9405	1725/-	01
FLEXISTRIP5MTRIP2055WLED860S	9405	1725/-	01
FLEXISTRIPDRIVER24WS	9405	670/-	01
FLEXISTRIPDRIVER72WS	9405	1355/-	01



### VENUS NEO HE 2X2

Ultra modern designed architectural LED luminaire which provides soft-light and glare free symmetrical illumination suitable for Armstrong/Grid ceiling.

Item Description	HSN Code	List Price (₹)	Case Lot (No)
VENUSNEOHE2X2PLR18-42WLED830MOD	9405	2730/-	02
VENUSNEOHE2X2PLR18-42WLED840MOD	9405	2730/-	02
VENUSNEOHE2X2PLR18-42WLED857MOD	9405	2730/-	02
VENUSNEOHE2X2PLR18-42WLED865MOD	9405	2730/-	02
LEDDRIVER36V18WS	9405	570/-	02
LEDDRIVER36V24WS	9405	570/-	02
LEDDRIVER36V28WS	9405	670/-	02
LEDDRIVER36V34WS	9405	670/-	02
LEDDRIVER36V36WS	9405	670/-	02
LEDDRIVER36V42WS	9405	970/-	02

Fixture size in mm (LxWxH) 595x595x65 for 2x2.

Ordering : Module + Driver (driver to be ordered separately).

Driver packed separately.



### VENUS NEO HE 4X1

Ultra modern designed architectural LED luminaire which provides soft-light and glare free symmetrical illumination suitable for Armstrong/Grid ceiling.

Item Description	HSN Code	List Price (₹)	Case Lot (No)
VENUSNEOHE4X1PLR28-36WLED830MOD	9405	2730/-	02
VENUSNEOHE4X1PLR28-36WLED840MOD	9405	2730/-	02
VENUSNEOHE4X1PLR28-36WLED857MOD	9405	2730/-	02
LEDDRIVER36V28WS	9405	670/-	02
LEDDRIVER36V36WS	9405	670/-	02

Fixture size in mm (LxWxH) 1180x280x70 for 4x1.

Ordering : Module + Driver (driver to be ordered separately).

Driver packed separately.



### VENUS NEO TUNABLE WHITE

Light that mimics the pattern of sun from dawn to dusk by changing the colour temperatures. Recessed mounted 2x2 luminaire suitable for Armstrong/Grid ceiling.

Item Description	HSN Code	List Price (₹)	Case Lot (No)
VENUSNEOTW2X2PLR42WLEDTWMOD	9405	3160/-	02
LEDDRIVER30V34WTWA	9405	4600/-	01
BLUETOOTH1-10VCONV42W	9405	2780/-	01

Fixture size in mm (LxWxH) 595x595x65.

**Ordering: Fixture + Bluetooth (1 bluetooth can control upto 4 fixtures).**



### PLUTO NEO PANEL 2X2

Environmental friendly, new generation, aesthetically designed, ultra modern recess mounting luminaire with high brightness SMD LEDs as light source, suitable for Armstrong/Grid ceiling.

Item Description	HSN Code	List Price (₹)	Case Lot (No)
PLUTONEO2X2PLR28WLED840S	9405	4480/-	02
PLUTONEO2X2PLR28WLED857S	9405	4480/-	02
PLUTONEO2X2PLR34WLED840S	9405	4570/-	02
PLUTONEO2X2PLR34WLED857S	9405	4570/-	02
PLUTONEO2X2PLR42WLED840S	9405	4840/-	02
PLUTONEO2X2PLR42WLED857S	9405	4840/-	02

Fixture size in mm (LxWxH) 595x595x70.



# Indoor Commercial LED Luminaires

## PANEL LIGHTING

### PLUTO NEO PANEL 4X1

Environmental friendly, new generation, aesthetically designed, ultra modern recess mounting luminaire with high brightness SMD LEDs as light source, suitable for Armstrong/Grid ceiling.

Item Description	HSN Code	List Price (₹)	Case Lot (No)
PLUTONEO4X1PLR30WLED840S	9405	4750/-	02
PLUTONEO4X1PLR30WLED857S	9405	4750/-	02
PLUTONEO4X1PLR36WLED840S	9405	5020/-	02
PLUTONEO4X1PLR36WLED857S	9405	5020/-	02

Fixture size in mm (LxWxH) 1195x295x70.



### PLUTO 2X1

High efficacy 2x1 recess LED flat panel with high brightness LED for glare-free homogenous illumination. Also for POP ceilings (supplied with wedge brackets)

Item Description	HSN Code	List Price (₹)	Case Lot (No)
PLUTO2X1PLR20WLED840S	9405	3270/-	02
PLUTO2X1PLR20WLED857S	9405	3270/-	02
PLUTO2X1PLR28WLED840S	9405	3630/-	02
PLUTO2X1PLR28WLED857S	9405	3630/-	02

Fixture size in mm (LxWxH) 595x295x70.



### PLUTO 1X1

High efficacy 1x1 recess LED flat panel with high brightness LED for glare-free homogenous illumination. Also for POP ceilings (supplied with wedge brackets).

Item Description	HSN Code	List Price (₹)	Case Lot (No)
PLUTO1X1PLR15WLED840S	9405	2105/-	01
PLUTO1X1PLR15WLED857S	9405	2105/-	01

Fixture size in mm (LxWxH) 295x295x70.

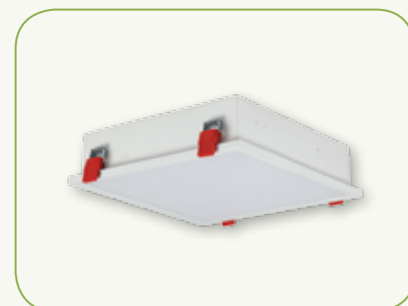

### ENDURA SLIM PRO PLUS 2X2 (Driver to be ordered separately)

LED edge-lit luminaire suitable for armstrong/grid ceiling complete for low ceiling applications.

Item Description	HSN Code	List Price (₹)	Case Lot (No)
ENDURASLIMPROPLUS2X2PLR28/36WLED840MOD	9405	2650/-	04
ENDURASLIMPROPLUS2X2PLR28/36WLED857MOD	9405	2650/-	04
LEDDRIVER36V28WS	9405	670/-	40
LEDDRIVER36V36WS	9405	670/-	40

Fixture size in mm (LxWxH) 595x595x11. **Ordering: Module + Driver.**



### SCOOP

Innovative direct/indirect luminaire suitable for armstrong/grid ceiling with high brightness LEDs and conical de-glaring prism center panel for efficient down light.

Item Description	HSN Code	List Price (₹)	Case Lot (No)
SCOOP2X2PLR34WLED840S	9405	4900/-	02
SCOOP2X2PLR34WLED857S	9405	4900/-	02

Fixture size in mm (LxWxH) 595x595x70.



### PLUTO PANEL (SURFACE)

Aesthetically designed 1x1, 2x2 & 4x1 LED flat panel for surface mounting which provides soft-light and glare free symmetrical illumination.

Item Description	HSN Code	List Price (₹)	Case Lot (No)
PLUTOSURFACE1X1PLS15WLED840S	9405	2240/-	02
PLUTOSURFACE1X1PLS15WLED857S	9405	2240/-	02
PLUTOSURFACE2X2PLS34WLED840S	9405	5020/-	02
PLUTOSURFACE2X2PLS34WLED857S	9405	5020/-	02
PLUTOSURFACE2X2PLS42WLED840S	9405	5380/-	02
PLUTOSURFACE2X2PLS42WLED857S	9405	5380/-	02
PLUTOSURFACE4X1PLS34WLED840S	9405	5020/-	02
PLUTOSURFACE4X1PLS34WLED857S	9405	5020/-	02
PLUTOSURFACE4X1PLS42WLED840S	9405	5380/-	02
PLUTOSURFACE4X1PLS42WLED857S	9405	5380/-	02

Fixture size in mm (LxWxH) 300x300x70 (1x1), 600x600x70 (2x2), 1200x300x70 (4x1).



### ALUMINIUM FRAME FOR POP/GYPSUM BOARD 2X2 PANEL LIGHT

Item Description	HSN Code	List Price (₹)	Case Lot (No)
ALFRAME2X2POP/GBR	7308	950/-	02

Frame size in mm 600x600x70.

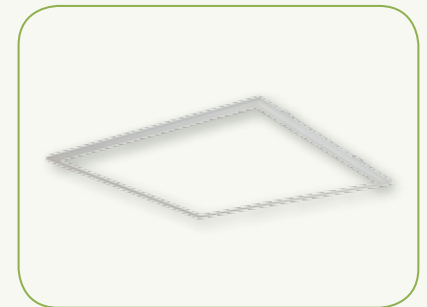

# Indoor Commercial LED Luminaires

## DOWNLIGHTS

### ORBIT

Ultra bright compact 5W LED downlighter with high efficacy LEDs, ideally suited for low ceiling areas to give glare free light (IP44 from front only).

Item Description	HSN Code	List Price (₹)	Case Lot (No)
ORBITDLR5WLED830S	9405	630/-	12
ORBITDLR5WLED840S	9405	630/-	12
ORBITDLR5WLED857S	9405	630/-	12

Ceiling cutout Ø 95 mm, height 83 mm.



### INTEGRA NEO

Recess mounted downlighter with pressure die-cast aluminium heat sink & PC diffuser in white powder coated finish with integrated driver.

Item Description	HSN Code	List Price (₹)	Case Lot (No)
INTEGRANEODLR10WLED830S	9405	780/-	12
INTEGRANEODLR10WLED840S	9405	780/-	12
INTEGRANEODLR10WLED857S	9405	780/-	12
INTEGRANEODLR12WLED840S	9405	1025/-	08
INTEGRANEODLR12WLED857S	9405	1025/-	08
INTEGRANEODLR15WLED830S	9405	1040/-	08
INTEGRANEODLR15WLED840S	9405	1040/-	08
INTEGRANEODLR15WLED857S	9405	1040/-	08
INTEGRANEODLR24WLED830S	9405	1650/-	06
INTEGRANEODLR24WLED840S	9405	1650/-	06
INTEGRANEODLR24WLED857S	9405	1650/-	06

Ceiling cutout Ø 90 mm, height 90 mm Attachment 10 W.

Ceiling cutout Ø 138 mm, height 90 mm for 12 W/15 W. Ceiling cutout Ø 175 mm, height 92 mm for 24 W.



### INTEGRA GRAND

Recess mounted downlighter with pressure die-cast aluminium heat sink & PC diffuser in white powder coated finish with integrated driver.

Item Description	HSN Code	List Price (₹)	Case Lot (No)
INTEGRAGRANDDL10WLED830S	9405	1085/-	12
INTEGRAGRANDDL10WLED840S	9405	1085/-	12
INTEGRAGRANDDL10WLED857S	9405	1085/-	12
INTEGRAGRANDDL15WLED830S	9405	1570/-	12
INTEGRAGRANDDL15WLED840S	9405	1570/-	12
INTEGRAGRANDDL15WLED857S	9405	1570/-	12

Ceiling cutout Ø 175 mm, height 92 mm.



### RISE

Recess mounted pressure die-cast aluminium luminaire in powder coated white finish with drop down PC diffuser with optimized heat sink for efficient heat dissipation and separate replaceable electronic driver.

Item Description	HSN Code	List Price (₹)	Case Lot (No)
RISEDLR15WLED830S	9405	1570/-	12
RISEDLR15WLED840S	9405	1570/-	12
RISEDLR15WLED857S	9405	1570/-	12

Ceiling cutout Ø 155 mm, height 45 mm.



### ENDURA DL NEO 7 W/10 W/12 W/15 W/18 W

Recess mounted pressure die-cast aluminium luminaire in powder coated white finish in round profile with optimized heat sink for efficient heat dissipation and separate replaceable electronic driver.

Item Description	HSN Code	List Price (₹)	Case Lot (No)
ENDURANEODLR7WLED830S	9405	895/-	12
ENDURANEODLR7WLED840S	9405	895/-	12
ENDURANEODLR7WLED857S	9405	895/-	12
ENDURANEODLR10WLED840S	9405	1120/-	12
ENDURANEODLR10WLED857S	9405	1120/-	12
ENDURANEODLR12WLED830S	9405	1390/-	12
ENDURANEODLR12WLED840S	9405	1390/-	12
ENDURANEODLR12WLED857S	9405	1390/-	12
ENDURANEODLR15WLED830S	9405	1570/-	12
ENDURANEODLR15WLED840S	9405	1570/-	12
ENDURANEODLR15WLED857S	9405	1570/-	12
ENDURANEODLR18WLED830S	9405	1695/-	12
ENDURANEODLR18WLED840S	9405	1695/-	12
ENDURANEODLR18WLED857S	9405	1695/-	12

Ceiling cutout Ø 100 mm, height 53 mm for 7 W/10 W.

Ceiling cutout Ø 155 mm, height 45 mm for 12 W/15 W/18 W.



### ENDURA HO

Endura HO is a highly efficient downlight with efficacy of 100 lm/W designed to replace CFL luminaire solutions. With its IP44 rating, the range is perfect for corridors, WCs, high public circulation areas and reception areas. EMI /EMC, CE Compliant Product.

Item Description	HSN Code	List Price (₹)	Case Lot (No)
ENDURAHODLR12WLED830MOD	9405	890/-	12
ENDURAHODLR12WLED840MOD	9405	890/-	12
ENDURAHODLR12WLED857MOD	9405	890/-	12
LEDDRIVER12/15WENDURAHOCO	9405	615/-	12
ENDURAHODLR15WLED830MOD	9405	1055/-	12
ENDURAHODLR15WLED840MOD	9405	1055/-	12
ENDURAHODLR15WLED857MOD	9405	1055/-	12
LEDDRIVER12/15WENDURAHOCO	9405	615/-	12
ENDURAHODLR21WLED830MOD	9405	1340/-	12
ENDURAHODLR21WLED840MOD	9405	1340/-	12
ENDURAHODLR21WLED857MOD	9405	1340/-	12
LEDDRIVER21/25WENDURAHOCO	9405	695/-	12
ENDURAHODLR25WLED830MOD	9405	1530/-	12
ENDURAHODLR25WLED840MOD	9405	1530/-	12
ENDURAHODLR25WLED857MOD	9405	1530/-	12
LEDDRIVER21/25WENDURAHOCO	9405	695/-	12

Ceiling cutout Ø 145 mm, height 45 mm for 12 W. Ceiling cutout Ø 175 mm, height 55 mm for 15 W.

Ceiling cutout Ø 205 mm, height 60 mm for 21 W. Ceiling cutout Ø 225 mm, height 65 mm for 25 W.



# Indoor Commercial LED Luminaires

## DOWNLIGHTS

### ARDOR (Driver to be ordered separately)

Deep recessed antiglare LED downlight for general and accent lighting. The premium white reflector matches the ceiling and accentuates the architecture of the area without compromising the light output.

Item Description	HSN Code	List Price (₹)	Case Lot (No)
ARDORDLR24WLED830MODWHT	9405	3360/-	06
ARDORDLR24WLED840MODWHT	9405	3360/-	06
ARDORDLR24WLED857MODWHT	9405	3360/-	06
LEDDRIVER24WS	9405	575/-	06
ARDORDLR35WLED830MODWHT	9405	4465/-	06
ARDORDLR35WLED840MODWHT	9405	4465/-	06
ARDORDLR35WLED857MODWHT	9405	4465/-	06
LEDDRIVER35WS	9405	945/-	06

Ceiling cutout 180 mm, height 90 mm for 24 W. Ceiling cutout 210 mm, height 98 mm for 35 W.

**Ordering: Module + Driver.**



### EDGEPRO ROUND

The Edgepro range of Slim-Fit low profile downlights are engineered to deliver superior light output and uniformity utilising the latest edge-lit LED technology. An ideal solution where ceiling voids are limited but high lumen output is required.

Item Description	HSN Code	List Price (₹)	Case Lot (No)
EDGEPRORDDL6WLED840S	9405	630/-	01
EDGEPRORDDL6WLED857S	9405	630/-	01
EDGEPRORDDL12WLED840S	9405	960/-	01
EDGEPRORDDL12WLED857S	9405	960/-	01
EDGEPRORDDL15WLED840S	9405	1165/-	01
EDGEPRORDDL15WLED857S	9405	1165/-	01
EDGEPRORDDL18WLED840S	9405	1435/-	01
EDGEPRORDDL18WLED857S	9405	1435/-	01

Ceiling cutout Ø 105 mm, height 16 mm for 6 W. Ceiling cutout Ø 160 mm, height 16 mm for 12 W.  
Ceiling cutout Ø 180 mm, height 16 mm for 15 W. Ceiling cutout Ø 210 mm, height 16 mm for 18 W.



### EDGEPRO SQUARE

The Edgepro range of Slim-Fit low profile downlights are engineered to deliver superior light output and uniformity utilising the latest edge-lit LED technology. An ideal solution where ceiling voids are limited but high lumen output is required.

Item Description	HSN Code	List Price (₹)	Case Lot (No)
EDGEPROSQDLR6WLED840S	9405	630/-	01
EDGEPROSQDLR6WLED857S	9405	630/-	01
EDGEPROSQDLR12WLED840S	9405	960/-	01
EDGEPROSQDLR12WLED857S	9405	960/-	01
EDGEPROSQDLR15WLED840S	9405	1165/-	01
EDGEPROSQDLR15WLED857S	9405	1165/-	01
EDGEPROSQDLR18WLED840S	9405	1435/-	01
EDGEPROSQDLR18WLED857S	9405	1435/-	01

Ceiling cutout 105x105 mm, height 16 mm for 6 W.  
Ceiling cutout 160x160 mm, height 16 mm for 12 W.  
Ceiling cutout 180x180 mm, height 16 mm for 15 W.  
Ceiling cutout 210x210 mm, height 16 mm for 18 W.



### ENDURA NEO DL SURFACE

Surface mounted LED downlighter with white powder coated aluminium housing with integrated electronic driver.

Item Description	HSN Code	List Price (₹)	Case Lot (No)
ENDURANEOSURFACEDLS15WLED840S	9405	1835/-	10
ENDURANEOSURFACEDLS15WLED857S	9405	1835/-	10
ENDURANEOSURFACEDLS21WLED857S	9405	2235/-	10

Fixture size in mm Ø 234, Height 57.



### INTEGRA NEO (SURFACE)

Surface mounted downlight with white powder coated polycarbonate housing and pressure die-cast heat sink having high efficiency.

Item Description	HSN Code	List Price (₹)	Case Lot (No)
INTEGRANEOSURFACEDLS10WLED830S	9405	1235/-	12
INTEGRANEOSURFACEDLS10WLED840S	9405	1235/-	12
INTEGRANEOSURFACEDLS10WLED857S	9405	1235/-	12
INTEGRANEOSURFACEDLS15WLED830S	9405	1320/-	12
INTEGRANEOSURFACEDLS15WLED840S	9405	1320/-	12
INTEGRANEOSURFACEDLS15WLED857S	9405	1320/-	12

Fixture size in mm Ø 200, Height 69.



### SPARKLE PRO SNOOT (Driver to be ordered separately)

Recess mounted LED wall washers, tilted 70° outwards and swivels 360° to offer best illumination on the wall and retail displays.

Item Description	HSN Code	List Price (₹)	Case Lot (No)
SPARKLEPROSNOOTDLR20WLED830MOD38D	9405	4005/-	06
SPARKLEPROSNOOTDLR20WLED840MOD38D	9405	4005/-	06
SPARKLEPROSNOOTDLR20WLED857MOD38D	9405	4005/-	06
LEDDRIVER20WS	9405	575/-	06
SPARKLEPROSNOOTDLR30WLED830MOD38D	9405	5420/-	06
SPARKLEPROSNOOTDLR30WLED840MOD38D	9405	5420/-	06
SPARKLEPROSNOOTDLR30WLED857MOD38D	9405	5420/-	06
LEDDRIVER30WS	9405	845/-	06

Ceiling cutout Ø 140 mm, height 140 mm for 20 W. Ceiling cutout Ø 175 mm, height 170 mm for 30 W.  
**Ordering: Module + Driver.**





# Indoor Commercial LED Luminaires

## DOWNLIGHTS

### SPARKLE PRO ADJUSTABLE (Driver to be ordered separately)

Recess mounted adjustable LED downlights made of extruded Aluminium housing and high power LED as a light source with clear diffuser and separate electronic driver.

Item Description	HSN Code	List Price (₹)	Case Lot (No)
SPARKLEPROADJDLR8W830MOD40D	9405	975/-	06
SPARKLEPROADJDLR8W840MOD40D	9405	975/-	06
SPARKLEPROADJDLR8W857MOD40D	9405	975/-	06
LEDDRIVER8WS	9405	615/-	06
SPARKLEPROADJDLR12W830MOD40D	9405	1590/-	06
SPARKLEPROADJDLR12W840MOD40D	9405	1590/-	06
SPARKLEPROADJDLR12W857MOD40D	9405	1590/-	06
LEDDRIVER12WS	9405	630/-	06
SPARKLEPROADJDLR20W830MOD40D	9405	2340/-	06
SPARKLEPROADJDLR20W840MOD40D	9405	2340/-	06
SPARKLEPROADJDLR20W857MOD40D	9405	2340/-	06
LEDDRIVER20WS	9405	575/-	06
SPARKLEPROADJDLR30W830MOD40D	9405	3140/-	06
SPARKLEPROADJDLR30W840MOD40D	9405	3140/-	06
SPARKLEPROADJDLR30W857MOD40D	9405	3140/-	06
LEDDRIVER30WS	9405	845/-	06

Ceiling cutout Ø 75 mm, height 55 mm for 8 W. Ceiling cutout Ø 85 mm, height 70 mm for 12 W. Ceiling cutout Ø 120 mm, height 90 mm for 20 W. Ceiling cutout Ø 150 mm, height 98 mm for 30 W.

**Ordering: Module + Driver.**



### SPARKLE PRO FIX (Driver to be ordered separately)

Recess mounted fixed LED downlight made of extruded Aluminium housing and high power LED as a light source with clear diffuser and separate electronic driver.

Item Description	HSN Code	List Price (₹)	Case Lot (No)
SPARKLEPROFIXDLR8W830MOD	9405	840/-	06
SPARKLEPROFIXDLR8W840MOD	9405	840/-	06
SPARKLEPROFIXDLR8W857MOD	9405	840/-	06
LEDDRIVER8WS	9405	615/-	06
SPARKLEPROFIXDLR12W830MOD	9405	1310/-	06
SPARKLEPROFIXDLR12W840MOD	9405	1310/-	06
SPARKLEPROFIXDLR12W857MOD	9405	1310/-	06
LEDDRIVER12WS	9405	630/-	06
SPARKLEPROFIXDLR20W830MOD	9405	1850/-	06
SPARKLEPROFIXDLR20W840MOD	9405	1850/-	06
SPARKLEPROFIXDLR20W857MOD	9405	1850/-	06
LEDDRIVER20WS	9405	575/-	06
SPARKLEPROFIXDLR30W830MOD	9405	2905/-	06
SPARKLEPROFIXDLR30W840MOD	9405	2905/-	06
SPARKLEPROFIXDLR30W857MOD	9405	2905/-	06
LEDDRIVER30WS	9405	845/-	06
SPARKLEPROFIXDLR45W830MOD	9405	3585/-	06
SPARKLEPROFIXDLR45W840MOD	9405	3585/-	06
SPARKLEPROFIXDLR45W857MOD	9405	3585/-	06
LEDDRIVER45WS	9405	1200/-	06

Ceiling cutout Ø 80 mm, height 60 mm for 8 W. Ceiling cutout Ø 105 mm, height 65 mm for 12 W. Ceiling cutout Ø 130 mm, height 75 mm for 20 W. Ceiling cutout Ø 185 mm, height 95 mm for 30 W. Ceiling cutout Ø 215 mm, height 110 mm for 45 W. **Ordering: Module + Driver.**



### SPIRIT (Driver to be ordered separately)

A minimalistic & versatile lighting source that offers a wide range of application with different aperture for same lamp unit. The lamp is deep recessed into the fixture to provide a glare-free solution.

Item Description	HSN Code	List Price (₹)	Case Lot (No)
SPIRITLAMPUNITDLR10WLED827MOD24D	9405	1715/-	06
SPIRITLAMPUNITDLR10WLED840MOD24D	9405	1715/-	06
SPIRITLAMPUNITDLR10WLED827MOD38D	9405	1715/-	06
SPIRITLAMPUNITDLR10WLED840MOD38D	9405	1715/-	06
LEDDRIVER10WS	9405	470/-	06
SPIRITLAMPUNITDLR15WLED827MOD24D	9405	1815/-	06
SPIRITLAMPUNITDLR15WLED840MOD24D	9405	1815/-	06
SPIRITLAMPUNITDLR15WLED827MOD38D	9405	1815/-	06
SPIRITLAMPUNITDLR15WLED840MOD38D	9405	1815/-	06
LEDDRIVER15WS	9405	630/-	06
SPIRITATTACHMENTRD-DDL10WWHT	9405	125/-	06
SPIRITATTACHMENTRD-OVALDL10WWHT	9405	125/-	06
SPIRITATTACHMENTRD-ODL10WWHT	9405	125/-	06
SPIRITATTACHMENTRD-SYMDL10WWHT	9405	125/-	06
SPIRITATTACHMENTRD-ASYMDL10WWHT	9405	125/-	06
SPIRITATTACHMENTSQ-ODL10WWHT	9405	125/-	06
SPIRITATTACHMENTRD-DDL15WWHT	9405	150/-	06
SPIRITATTACHMENTRD-OVALDL15WWHT	9405	150/-	06
SPIRITATTACHMENTRD-ODL15WWHT	9405	150/-	06
SPIRITATTACHMENTRD-SYMDL15WWHT	9405	150/-	06
SPIRITATTACHMENTRD-ASYMDL15WWHT	9405	150/-	06
SPIRITATTACHMENTSQ-ODL15WWHT	9405	150/-	06

Ceiling cutout Ø 80 mm, height 85 mm Attachment 10 W.

Ceiling cutout Ø 100 mm, height 85 mm for 15 W.

**Ordering: Lamp unit + Driver + Attachment.**



Attachment RD-D



Attachment RD-Oval



Attachment RD-O



Attachment RD-ASYM



Attachment RD-SYM



Attachment SQ-O

### FIO TRACK LIGHT

Track based spot light with high efficiency reflector makes it ideal for lighting-up retail spaces with bright and crisp light throw. Suitable for 3 circuit-4 wire universal tracks.

Item Description	HSN Code	List Price (₹)	Case Lot (No)
FIOTS25W830S45DWHT	9405	7185/-	08
FIOTS25W830S45DBLK	9405	7185/-	08
FIOTS25W840S45DWHT	9405	7185/-	08
FIOTS25W840S45DBLK	9405	7185/-	08
FIOTS35W830S45DWHT	9405	9220/-	08
FIOTS35W840S45DWHT	9405	9220/-	08



# Indoor Commercial LED Luminaires

## DOWNLIGHTS

### CYLINDRO

With the high power LED, CYLINDRO offers various luminous intensity levels from 1500-3500 Lumens which is the perfect alternate to conventional HID lamps. Suitable for 3 circuit-4 wire universal tracks.

Item Description	HSN Code	List Price (₹)	Case Lot (No)
CYLINDROTSS15W830S24DWHT	9405	4620/-	12
CYLINDROTSS15W830S38DWHT	9405	4620/-	12
CYLINDROTSS15W840S24DWHT	9405	4620/-	12
CYLINDROTSS15W840S38DWHT	9405	4620/-	12
CYLINDROTSS15W857S38DWHT	9405	4620/-	12
CYLINDROTSS25W830S24DWHT	9405	5445/-	8
CYLINDROTSS25W830S38DWHT	9405	5445/-	8
CYLINDROTSS25W840S24DWHT	9405	5445/-	8
CYLINDROTSS25W840S38DWHT	9405	5445/-	8
CYLINDROTSS25W857S38DWHT	9405	5445/-	8
CYLINDROTSS35W830S24DWHT	9405	6360/-	8
CYLINDROTSS35W830S38DWHT	9405	6360/-	8
CYLINDROTSS35W840S24DWHT	9405	6360/-	8
CYLINDROTSS35W840S38DWHT	9405	6360/-	8
CYLINDROTSS15W830S38DBLK	9405	4620/-	12
CYLINDROTSS15W840S38DBLK	9405	4620/-	12
CYLINDROTSS15W857S38DBLK	9405	4620/-	12
CYLINDROTSS25W830S38DBLK	9405	5445/-	12
CYLINDROTSS25W830S24DBLK	9405	5445/-	12
CYLINDROTSS25W857S38DBLK	9405	5445/-	8
CYLINDROTSS25W840S38DBLK	9405	5445/-	8
CYLINDROTSS25W840S24DBLK	9405	5445/-	8
HONEYCOMBATTACHMENT15W	9405	170/-	8
HONEYCOMBATTACHMENT25W/35W	9405	170/-	8

Size: Dia 70 mm, Length 180 mm, Height 212 mm for 15 W.

Size: Dia 90 mm, Length 206 mm, height 212 mm for 25 W.

Size: Dia 90 mm, Length 216 mm, height 222 mm for 35 W.



### TRACK ACCESSORIES

Item Description	HSN Code	List Price (₹)	Case Lot (No)
1MTR3PHASETTRACKTSWHT	9405	1785/-	-
2MTR3PHASETTRACKTSWHT	9405	3560/-	-
1MTR3PHASETTRACKTSBLK	9405	1785/-	-
2MTR3PHASETTRACKTSBLK	9405	3560/-	-
ISHAPECONNECTOR3PHASETSWHT	9405	765/-	-
LSHAPECONNECTOR3PHASETSWHT	9405	975/-	-
ISHAPECONNECTOR3PHASETSBLK	9405	765/-	-
LSHAPECONNECTOR3PHASETSBLK	9405	975/-	-
ADJUSTABLESUSPENSIONKITTSWHT	9405	360/-	-



# Indoor Commercial LED Luminaires

## DIMMABLE LUMINAIRES PORTFOLIO

### INTEGRA GRAND 15 W

Recess mounted downlighter with pressure die-cast aluminium heat sink & PC diffuser in white powder coated finish with integrated driver **(for DALI products drivers to be ordered separately)**.

Item Description	HSN Code	List Price (₹)	Case Lot (No)
INTEGRAGRANDDL15WLED840MOD	9405	1215/-	01
INTEGRAGRANDDL15WLED857MOD	9405	1215/-	01
INTEGRANEODLR15WLED840MOD	9405	850/-	12
INTEGRANEODLR15WLED857MOD	9405	850/-	12
DALIDRIVERFACT15WD	9405	3800/-	12

Ceiling cutout Ø 175 mm, height 92 mm. **DALI Ordering: Module + DALI Driver.**



### ENDURA DL NEO 15 W

Recess mounted pressure die-cast aluminium luminaire in powder coated white finish in round profile with optimized heat sink for efficient heat dissipation and separate replaceable electronic driver compatible for Analog/DALI Dimming **(for DALI products drivers to be ordered separately)**.

Item Description	HSN Code	List Price (₹)	Case Lot (No)
ENDURANEO1-10VDLR15WLED840MOD	9405	1880/-	01
ENDURANEO1-10VDLR15WLED857MOD	9405	1880/-	01
ENDURANEODLR15WLED840MOD	9405	1215/-	01
ENDURANEODLR15WLED857MOD	9405	1215/-	01
DALIDRIVER15WD	9405	4250/-	01

Ceiling cutout Ø 155 mm, height 45 mm. **DALI Ordering: Module + DALI Driver.**



### ENDURA DL NEO 21 W/25 W

Recess mounted LED downlighter elegantly designed pressure die-cast Al. heat sink for efficient heat dissipation and separate replaceable electronic driver compatible for Analog/DALI Dimming **(for DALI products drivers to be ordered separately)**.

Item Description	HSN Code	List Price (₹)	Case Lot (No)
ENDURANEO1-10VDLR21WLED840MOD	9405	3035/-	01
ENDURANEO1-10VDLR21WLED857MOD	9405	3035/-	01
ENDURANEO1-10VDLR25WLED840MOD	9405	3135/-	01
ENDURANEO1-10VDLR25WLED857MOD	9405	3135/-	01
ENDURANEODLR25WLED840MOD	9405	1735/-	01
ENDURANEODLR25WLED857MOD	9405	1735/-	01
DALIDRIVER25W	9405	4250/-	01

Ceiling cutout Ø 180 mm, height 68 mm for 21/25 W. **DALI Ordering: Module + DALI Driver.**



### VENUS NEO 2X2

New generation recess mounting luminaire with high brightness SMD LEDs as light source, suitable for Armstrong/Grid ceiling compatible for Analog / DALI Dimming **(for DALI products drivers to be ordered separately)**.

Item Description	HSN Code	List Price (₹)	Case Lot (No)
VENUSNEO1-10V2X2PLR34WLED840MOD	9405	5000/-	01
VENUSNEO1-10V2X2PLR34WLED857MOD	9405	5000/-	01
VENUSNEOHE2X2PLR18-42WLED840MOD	9405	2730/-	01
VENUSNEOHE2X2PLR18-42WLED857MOD	9405	2730/-	01
LEDDRIVER30V28WDALI	9405	4150/-	01
LEDDRIVER30V34WDALI	9405	4250/-	01

Fixture size in mm (LxWxH) 595x595x65. **DALI Ordering: Module + DALI Driver.**





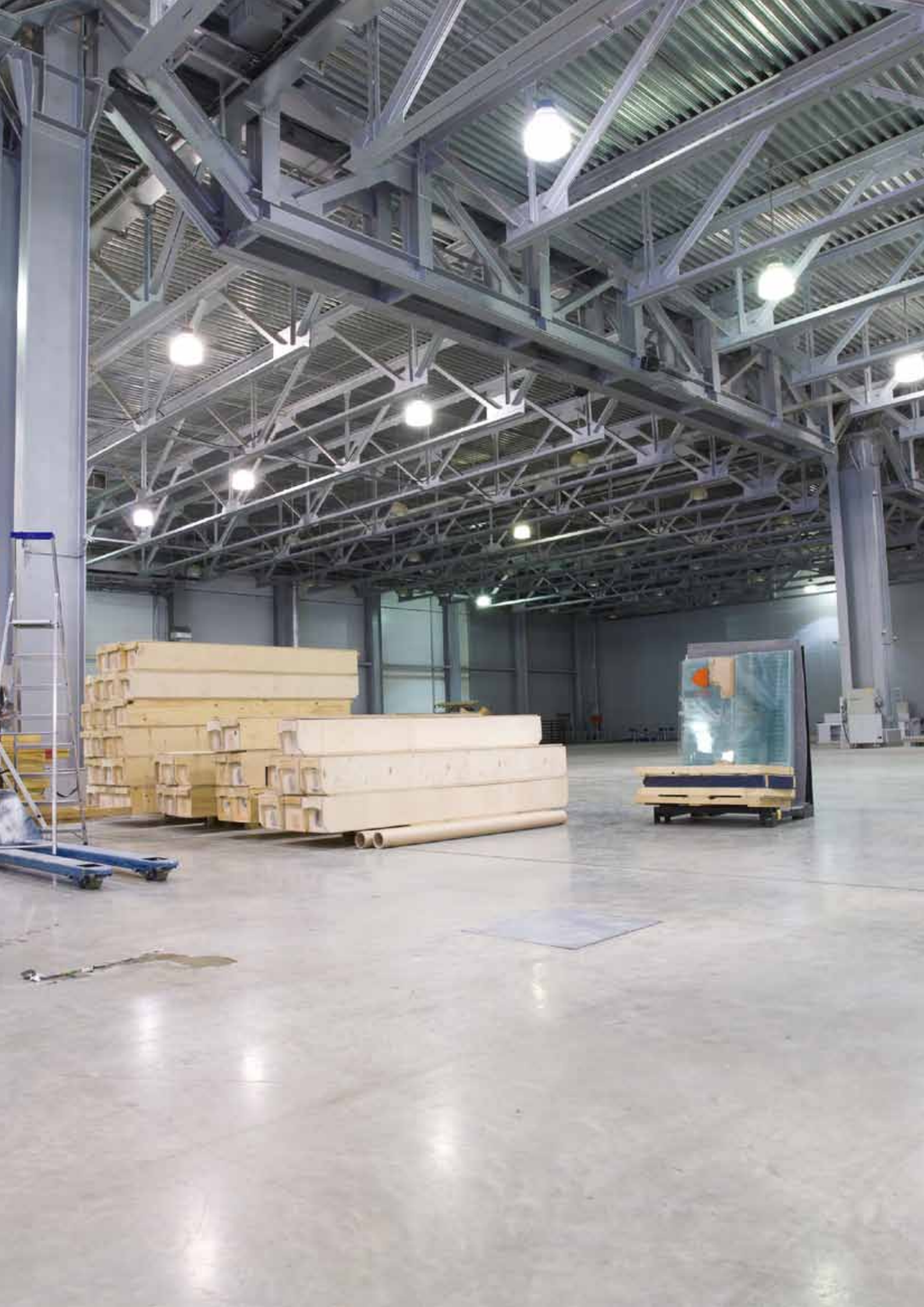

# Industrial LED Luminaires

Havells offers a wide variety of solutions for all industrial applications. Havells ensures the enhancement of productivity of the employees with the right light to keep them motivated. The use of Havells Industrial lights provides fatigue-free and accident-free environment.

### MAGNUM LED 24 W IP66

Energy saving, environmental friendly, long life, corrosion resistant, impact proof, surface mounting IP66 luminaire with PC housing in opal finish suitable for wet location with high brightness LEDs.

Item Description	HSN Code	List Price (₹)	Case Lot (No)
MAGNUMILS24WLED857SPC	9405	4115/-	12

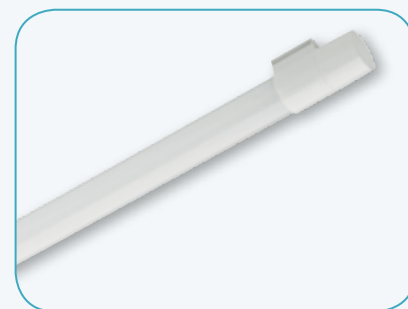

### MAGNUM GRAND

Energy saving, environmental friendly, long life, corrosion resistant, impact proof, surface mounting IP65 luminaire with PC housing & opal finish cover suitable for wet location. LEDs used as light source.

Item Description	HSN Code	List Price (₹)	Case Lot (No)
MAGNUMGRANDILS20WLED857SPC	9405	3190/-	06
MAGNUMGRANDILS40WLED857SPC	9405	4500/-	06



### MAGNUM RETRO (Single Side Connection)

Environmental friendly, long life, corrosion resistant, impact proof, surface mounting IP65 luminaire with PC housing & opal finish cover suitable for LED tubes.

Item Description	HSN Code	List Price (₹)	Case Lot (No)
MAGNUMRETROILS1X18PC	9405*	1485/-	06
MAGNUMRETROILS2X18PC	9405*	1815/-	06



### ENDURA WELL GLASS NEO - IP65

Environmental friendly, energy saving long life corrosion resistant, vertical/horizontal surface mounting pressure die-cast aluminium well glass luminaires with high power LED as light source.

Item Description	HSN Code	List Price (₹)	Case Lot (No)
ENDURAWELLGLASSNEOTSS26WLED757SPCSO	9405	2900/-	06
ENDURAWELLGLASSNEOTSS35WLED757SPCSO	9405	3100/-	06
ENDURAWELLGLASSNEOTSS40WLED757SPCSO	9405	3200/-	06



### ENDURA HIGHBRITE PLUS

Energy saving, environment friendly & robust open type vertical Highbay/Mediumbay LED IP54 luminaire with high power COB LED as light source.

Item Description	HSN Code	List Price (₹)	Case Lot (No)
ENDURAHIBRITEPLUSHP50WLED750S90DTOLENS	9405	9500/-	01
ENDURAHIBRITEPLUSHP90WLED765S60DTOLENS	9405	11900/-	01
ENDURAHIBRITEPLUSHP90WLED765S90DTOLENS	9405	11900/-	01
ENDURAHIBRITEPLUSHP150WLED765P60DTOLENS	9405	15900/-	01
ENDURAHIBRITEPLUSHP150WLED765P90DTOLENS	9405	15900/-	01





# Industrial LED Luminaires

## HIGHBAY LIGHTING

### SAUCER NEO

Energy saving, environment friendly & robust Highbay/Mediumbay LED IP65 luminaire with high efficacy.

Item Description	HSN Code	List Price (₹)	Case Lot (No)
SAUCERHBP80WLED757S60DTOLTG	9405	10200/-	01
SAUCERHBP80WLED757S90DTOLTG	9405	10200/-	01
SAUCERNEOP100WLED75790DLTG	9405	10700/-	01
SAUCERNEOP100WLED75760DLTG	9405	10700/-	01
SAUCERNEOP120WLED75790DLTG	9405	11500/-	01
SAUCERNEOP120WLED75760DLTG	9405	11500/-	01
SAUCERNEOP150WLED75790DLTG	9405	12200/-	01
SAUCERNEOP150WLED75760DLTG	9405	12200/-	01
SAUCERNEOP180WLED75760DTOLTG	9405	20700/-	01
SAUCERNEOP180WLED75790DTOLTG	9405	20700/-	01
SAUCERNEOP200WLED75760DTOLTG	9405	21400/-	01
SAUCERNEOP200WLED75790DTOLTG	9405	21400/-	01



### FLASHBAY

Flashbay LED is designed to replace existing under-canopy and industrial low-bay IP66 lights with HID lamps as a cost effective retrofit kit.

Item Description	HSN Code	List Price (₹)	Case Lot (No)
FLASHBAYCAR80WLED757SBOLTG	9405	9200/-	02



### BAYBRITE FLARE HP

Baybrite Flare is a special designed, multi-functional LED luminaire to replace under canopy or Industrial Low-bay.

Item Description	HSN Code	List Price (₹)	Case Lot (No)
BAYBRITEFLAREHPCA70WLED757S90LTG	9405	8400/-	02
BAYBRITEFLAREHPCA80WLED757S90LTG	9405	8700/-	02



### JETA VALOUR HB

Energy saving, environmental friendly, long life, exclusive innovative die-cast aluminium non integral IP66 highbay, suitable for high mast application, highlighting architectural facade and general purpose lighting.

Item Description	HSN Code	List Price (₹)	Case Lot (No)
JETAVALOURHB180WLED757MODNBLTG	9405	15600/-	01
JETAVALOURHB180WLED757MODWBLTG	9405	15600/-	01
JETAVALOURHB200WLED757MODNBLTG	9405	16000/-	01
JETAVALOURHB200WLED757MODWBLTG	9405	16000/-	01
ASSEMBLED CGBOXVALOURHB180WOPEN	9405	8900/-	01
ASSEMBLED CGBOXVALOURHB180WP	9405	10100/-	01
ASSEMBLED CGBOXVALOURHB200WOPEN	9405	8900/-	01
ASSEMBLED CGBOXVALOURHB200WP	9405	10100/-	01



### LED CLEAN ROOM BOTTOM OPENING

IP65, dust free & zero maintenance LED Clean Room Bottom Opening luminaire for hygienic facilities.

Item Description	HSN Code	List Price (₹)	Case Lot (No)
BOCR1X1R18WLED857SPCMS	9405	3480/-	02
BOCR2X2R34WLED857SPCMS	9405	7440/-	02
BOCR2X2R42WLED857SPCMS	9405	7560/-	02
BOCR2X2R60WLED857SPCMS	9405	9960/-	02
BOCR2X2R80WLED857SPCMS	9405	10320/-	02
BOCR4X1R34WLED857SPCMS	9405	8520/-	02
BOCR4X1R42WLED857SPCMS	9405	8640/-	02
BOCR4X1R60WLED857SPCMS	9405	10920/-	02
BOCR4X1R80WLED857SPCMS	9405	11280/-	02
BOCR2X1R34WLED857SPCMS	9405	7440/-	02
BOCR2X1R42WLED857SPCMS	9405	7680/-	02
BOCR1X1R18WLED857SPCSS	9405	5520/-	02
BOCR2X2R34WLED857SPCSS	9405	10440/-	02
BOCR2X2R42WLED857SPCSS	9405	On Req	02
BOCR2X2R60WLED857SPCSS	9405	On Req	02
BOCR2X2R80WLED857SPCSS	9405	On Req	02
BOCR2X1R34WLED857SPCSS	9405	On Req	02
BOCR2X1R42WLED857SPCSS	9405	On Req	02
BOCR4X1R34WLED857SPCSS	9405	On Req	02
BOCR4X1R42WLED857SPCSS	9405	On Req	02
BOCR4X1R60WLED857SPCSS	9405	On Req	02
BOCR4X1R80WLED857SPCSS	9405	On Req	02



### LED CLEAN ROOM TOP OPENING

IP65, dust free & zero maintenance LED Clean Room Top Opening luminaire for hygienic facilities.

Item Description	HSN Code	List Price (₹)	Case Lot (No)
TOCR1X1R18WLED857SPCMS	9405	3600/-	02
TOCR2X2R34WLED857SPCMS	9405	9480/-	02
TOCR2X2R42WLED857SPCMS	9405	9600/-	02
TOCR2X2R60WLED857SPCMS	9405	10560/-	02
TOCR2X2R80WLED857SPCMS	9405	10800/-	02
TOCR4X1R34WLED857SPCMS	9405	9840/-	02
TOCR4X1R42WLED857SPCMS	9405	10080/-	02
TOCR4X1R60WLED857SPCMS	9405	12000/-	02
TOCR4X1R80WLED857SPCMS	9405	12600/-	02
TOCR2X1R34WLED857SPCMS	9405	9360/-	02
TOCR2X1R42WLED857SPCMS	9405	9600/-	02
TOCR1X1R18WLED857SPCSS	9405	On Req	02
TOCR2X2R34WLED857SPCSS	9405	On Req	02
TOCR2X2R42WLED857SPCSS	9405	On Req	02
TOCR2X2R60WLED857SPCSS	9405	On Req	02
TOCR2X2R80WLED857SPCSS	9405	On Req	02
TOCR4X1R34WLED857SPCSS	9405	On Req	02
TOCR4X1R42WLED857SPCSS	9405	On Req	02
TOCR4X1R60WLED857SPCSS	9405	On Req	02
TOCR4X1R80WLED857SPCSS	9405	On Req	02
TOCR2X1R34WLED857SPCSS	9405	On Req	02
TOCR2X1R42WLED857SPCSS	9405	On Req	02



# Industrial LED Luminaires

## CLEAN ROOM LIGHTS

### LED CLEAN ROOM BOTTOM OPENING SCREW LESS

IP65, dust free & zero maintenance LED Clean Room Bottom Opening luminaire for hygienic facilities.

Item Description	HSN Code	List Price (₹)	Case Lot (No)
BOCR1x1R18WLED857SPCMSSL	9405	3840/-	02
BOCR2X2R34WLED857SPCMSSL	9405	7920/-	02
BOCR2X2R42WLED857SPCMSSL	9405	8040/-	02
BOCR2X2R60WLED857SPCMSSL	9405	10440/-	02
BOCR2X2R80WLED857SPCMSSL	9405	10800/-	02



### LED TOCR TUNABLE WHITE

TOCR with dimming option for hygienic facilities.

Item Description	HSN Code	List Price (₹)	Case Lot (No)
TOCR2X2R42WTUNABLEWHITELED3K-5.7KDPCMS	9405	On Req	02



### LED TOCR H – CLEAN (WITH SEPARATE DIFFUSER)

Dust free & zero maintenance LED Clean Room Top Opening luminaire for hygienic facilities.

Item Description	HSN Code	List Price (₹)	Case Lot (No)
TOCRW/OFRAME2X1R28WCBLED857SPCMS	9405	On Req	02
TOCRW/OFRAME2X1R34WCBLED857SPCMS	9405	On Req	02
TOCRW/OFRAME2X2R42WCBLED857SPCMS	9405	On Req	02
TOCRW/OFRAME2X2R60WCBLED857SPCMS	9405	On Req	02
TOCRW/OFRAME2X2R80WCBLED857SPCMS	9405	On Req	02

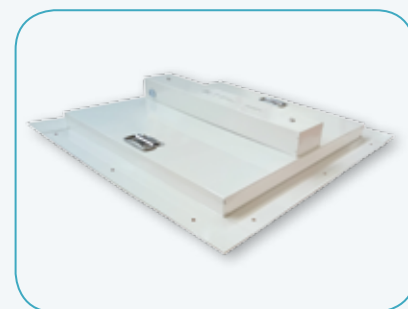

### WALKABLE TRAY FOR TOP OPENING CLEAN ROOM FIXTURES

Item Description	HSN Code	Size (mm)	List Price (₹)	Case Lot (No)
WalkableTray1X1RTOCRMS	9405*	440x440	2748/-	02
WalkableTray1X2RTOCRMS	9405*	440x740	3630/-	02
WalkableTray1X4RTOCRMS	9405*	440x1340	5940/-	02
WalkableTray2X2RTOCRMS	9405*	740x740	4842/-	02





# Outdoor LED Luminaires

Introducing the wide range of outdoor application LED products from Havells. This range is yet another example of Havells' endeavour to innovate and provide world class lighting solution, energy efficient products and robust design. These lights are designed to fulfill the lighting applications of City Road Lighting, Periphery Lighting, Prestigious Heritage Area Outdoor Lighting and Urban Landscape Lighting.

### JETA COMPACTO IP65

Energy saving, environmental friendly, long life, exclusive innovative die-cast aluminium flood light with high power LEDs as light source, suitable for highlighting architectural features or Area Lighting. Also suitable to rough services/installations.

Item Description	HSN Code	List Price (₹)	Case Lot (No)
JETACOMPECTOFL30WLED757LTG	9405	3300/-	10
JETACOMPECTOFL50WLED757LTG	9405	4200/-	10

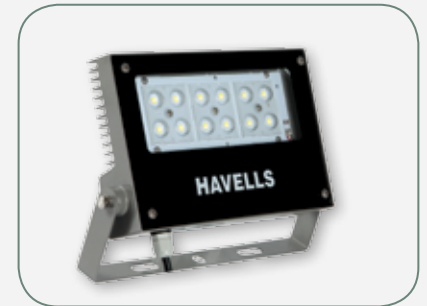

### JETA NEO 70

Energy saving, environmental friendly, long life, exclusive innovative die-cast aluminium IP65 flood light, suitable for highlighting architectural facade and general purpose lighting.

Item Description	HSN Code	List Price (₹)	Case Lot (No)
JETANEOFL70WLED757LTG	9405	8500/-	02



### JETA IRIS

Energy saving, environmental friendly, long life, exclusive innovative die-cast aluminium IP66 flood light, suitable for highlighting architectural facade and general purpose lighting.

Item Description	HSN Code	List Price (₹)	Case Lot (No)
JETAIRISFLS100WLED757ASYMLTG	9405	9400/-	01
JETAIRISFLS100WLED757SYMLTG	9405	9400/-	01
JETAIRISFLS120WLED730SYMLTG	9405	11000/-	01
JETAIRISFLS120WLED757SYMLTG	9405	11000/-	01
JETAIRISFLS120WLED730ASYMLTG	9405	11000/-	01
JETAIRISFLS120WLED757ASYMLTG	9405	11000/-	01
JETAIRISFLS120WLED730PSYMLTG	9405	11700/-	01
JETAIRISFLS120WLED757PSYMLTG	9405	11700/-	01
JETAIRISFLS120WLED730PASYMLTG	9405	11700/-	01
JETAIRISFLS120WLED757PASYMLTG	9405	11700/-	01
JETAIRISFLS140WLED730PSYMLTG	9405	12400/-	01
JETAIRISFLS140WLED757PSYMLTG	9405	12400/-	01
JETAIRISFLS140WLED730PASYMLTG	9405	12400/-	01
JETAIRISFLS140WLED757PASYMLTG	9405	12400/-	01
JETAIRISFLS150WLED730PSYMLTG	9405	12800/-	01
JETAIRISFLS150WLED757PSYMLTG	9405	12800/-	01



### JETA PRO PLUS

Energy saving, environmental friendly, long life, exclusive innovative die-cast aluminium IP65 flood light with high power LEDs as light source, suitable for highlighting architectural facade highmast and general purpose lighting.

Item Description	HSN Code	List Price (₹)	Case Lot (No)
JETAPROPLUSFL120WLED757LTG	9405	14900/-	01
JETAPROPLUSFL150WLED757LTG	9405	15400/-	01
JETAPROPLUSFL180WLED757LTG	9405	22000/-	01
JETAPROPLUSFL200WLED757LTG	9405	22500/-	01
JETAPROPLUSFL240WLED757LTG	9405	23000/-	01



# Outdoor LED Luminaires

## FLOOD LIGHTS

### JETA VALOUR

Energy saving, environmental friendly, long life, exclusive innovative die-cast aluminium non integral IP66 flood light, suitable for high mast application, highlighting architectural facade and general purpose lighting.

Item Description	HSN Code	List Price (₹)	Case Lot (No)
JETAVALOURFLS180WLED757MODSYMLTG	9405	11150/-	01
JETAVALOURFLS180WLED757MODASYMLTG	9405	11150/-	01
ASSEMCGBOXVALOUR180WS	9405	8000/-	01
ASSEMCGBOXVALOUR180WP	9405	9000/-	01
JETAVALOURFLS200WLED757MODSYMLTG	9405	12500/-	01
JETAVALOURFLS200WLED757MODASYMLTG	9405	12500/-	01
ASSEMCGBOXVALOUR200WS	9405	8300/-	01
ASSEMCGBOXVALOUR200WP	9405	9000/-	01
JETAVALOURFLS240WLED757MODSYMLTG	9405	15100/-	01
JETAVALOURFLS240WLED757MODASYMLTG	9405	15100/-	01
ASSEMCGBOXVALOUR80WS	9405	5300/-	01
ASSEMCGBOXVALOUR160WS	9405	8300/-	01
ASSEMCGBOXVALOUR80WP	9405	5800/-	01
ASSEMCGBOXVALOUR160WP	9405	8800/-	01
JETAVALOURFLS300WLED757MODSYMLTG	9405	15500/-	01
JETAVALOURFLS300WLED757MODASYMLTG	9405	15500/-	01
ASSEMCGBOXVALOUR200WS	9405	8300/-	01
ASSEMCGBOXVALOUR100WS	9405	5400/-	01
ASSEMCGBOXVALOUR200WP	9405	9000/-	01
ASSEMCGBOXVALOUR100WP	9405	5400/-	01
JETAVALOURFLS350WLED757MODSYMLTG	9405	20700/-	01
JETAVALOURFLS350WLED757MODASYMLTG	9405	20700/-	01
ASSEMCGBOXVALOUR175WP	9405	8500/-	01
JETAVALOURFLS400WLED757MODSYMLTG	9405	21200/-	01
JETAVALOURFLS400WLED757MODASYMLTG	9405	21200/-	01
ASSEMCGBOXVALOUR200WS	9405	8300/-	01
ASSEMCGBOXVALOUR200WP	9405	9000/-	01

Note: CCT 3000K available on request.



### TYCOON (OPAL)

Design inspired from the classical Victorian era using new generation technology in LED to rejuvenate your outdoor areas with functionality during night and aesthetics during the day. IP65 die cast Aluminium Post top lantern designed with long life LED engine & Electronic Driver, designed for glare free symmetrical light distribution.

Item Description	HSN Code	List Price (₹)	Case Lot (No)
TYCOONPT70WLED730PSYMTOPC	9405	35100/-	01
TYCOONPT70WLED757PSYMTOPC	9405	35100/-	01

Suitable for pole dia Ø 76 mm.



### BARON (OPAL)

Design inspired from the classical Victorian era using new generation technology in LED to rejuvenate your outdoor areas with functionality during night and aesthetics during the day. IP65 die cast Aluminium Post top lantern designed with long life LED engine & Electronic Driver, designed for glare free symmetrical light distribution.

Item Description	HSN Code	List Price (₹)	Case Lot (No)
BARONPT70WLED730PSYMTOPC	9405	32700/-	01
BARONPT70WLED757PSYMTOPC	9405	32700/-	01

Suitable for pole dia Ø 76 mm.



### SUPREME

Contemporary design with new generation technology in LED to invigorate your outdoor areas with functionality during night and aesthetics during the day. IP65 die cast Aluminium Post top lantern designed with long life LED engine & Electronic Driver, well designed aluminium shell intended to control the Upward component of Light and provides glare free downward symmetrical light distribution.

Item Description	HSN Code	List Price (₹)	Case Lot (No)
SUPREMEPT70WLED730PSYMTOPC	9405	32500/-	01
SUPREMEPT70WLED757PSYMTOPC	9405	32500/-	01

Suitable for pole dia Ø 76 mm.



### VICTORIA - IP65

Design from the renaissance era yet with a modern look using new generation technology in LED to enliven your outdoor areas in perfect synchronisation with functionality and aesthetics. Family of post top lantern designed to complement the geometry of the area.

Item Description	HSN Code	List Price (₹)	Case Lot (No)
VICTORIAPT35WLED730PSYMTOTG	9405	23000/-	01
VICTORIAPT35WLED757PSYMTOTG	9405	23000/-	01

Suitable for pole dia Ø 76 mm.



### ENDURA SPRING 6

New generation, post-top, energy saving, environmental friendly, long life aesthetically designed with good indirect symmetrical light distribution, die-cast aluminium landscape IP65 luminaire with high power COB LED as light source.

Item Description	HSN Code	List Price (₹)	Case Lot (No)
ENDURASPRING6PT35WLED740PSYMTOTG	9405	16500/-	01
ENDURASPRING6PT35WLED757PSYMTOTG	9405	16500/-	01

Suitable for pole dia Ø 76 mm.





# Outdoor Luminaires

## LANDSCAPE LIGHTS

### RUBY (CLEAR) - IP65

New generation, post-top, energy saving, environmental friendly, long life aesthetically designed with symmetrical light distribution, spun aluminium landscape luminaire with high power LEDs as light source.

Item Description	HSN Code	List Price (₹)	Case Lot (No)
RUBYPT25WLED757PSYMTOPC	9405	8250/-	01
RUBYPT35WLED757PSYMTOPC	9405	9100/-	01

Suitable for pole dia Ø 76 mm.



### CORAL (OPAL) - IP65

New generation, post-top, energy saving, environmental friendly, long life aesthetically designed with symmetrical light distribution, spun aluminium landscape luminaire with high power LEDs as light source.

Item Description	HSN Code	List Price (₹)	Case Lot (No)
CORALPT25WLED757PSYMTOPC	9405	8250/-	01
CORALPT35WLED757PSYMTOPC	9405	9100/-	01

Suitable for pole dia Ø 76 mm.



### MUSHROOM - IP65

New generation, energy saving, environmental friendly, long life aesthetically designed die-cast aluminium landscape luminaire for downward lighting with high power LED as light source.

Item Description	HSN Code	List Price (₹)	Case Lot (No)
MUSHROOMBL16WLED730SSYMTOPC	9405	8710/-	01
MUSHROOMBL16WLED757SSYMTOPC	9405	8710/-	01



### BAMBOO - IP65

New generation, energy saving, environmental friendly, long life aesthetically designed aluminium landscape luminaire for diffused lighting with high power LED as light source.

Item Description	HSN Code	List Price (₹)	Case Lot (No)
BAMBOOBL8WLED857SSYMTOPC (0.5M)	9405	3900/-	01
BAMBOOBL8WLED857SSYMTOPCM (1.0M)	9405	4200/-	01

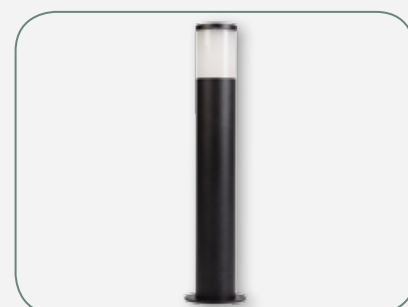

### CONE - IP65

Cone series acts as a imposing street furniture. The elegant yet minimalistic design acts a silent observer and giving light, diffuser at the upper portion acts a beacon of path guidance in a landscape environment.

Item Description	HSN Code	List Price (₹)	Case Lot (No)
CONEBL8WLED857SSYMTOPC	9405	3900/-	01



### ENDURA RUGBY NEO N - IP65

Environmental friendly, ultra modern, energy saving, surface mounted, decorative oval bulk head edge-lit LED luminaire comprising of high brightness LEDs.

Item Description	HSN Code	List Price (₹)	Case Lot (No)
RUGBYNEONFT10WLED860SSYMTOPC	9405	1575/-	08



### POLES

Aesthetically designed decorative hot dipped galvanised mild steel step pole with grey powder finish. Compatible for all Havells post top range.

Item Description	HSN Code	List Price (₹)	Case Lot (No)
3.5MPOLE	7308	16650/-	01
6MPOLE	7308	28250/-	01



# Outdoor Luminaires

## STREET LIGHTS

### ENDURA PEARL

New generation energy saving and environmental friendly long life LED street light made up of pressure die cast aluminium housing with high power LED as lighting source and lens embedded PC cover having TOP OPENING separate driver compartment with IP65 protection and impact resistance of IK07.

Item Description	HSN Code	List Price (₹)	Case Lot (No)
ENDURAPEARLSL15WLED757SASYTOPC	9405	2100/-	01
ENDURAPEARLSL20WLED757SASYTOPC	9405	2200/-	01
ENDURAPEARLSL25WLED757SASYTOPC	9405	2300/-	01

Suitable for pole dia Ø 43 mm (max.).



### ENDURA PEARL NEO

New generation energy saving and environmental friendly long life LED street light made up of pressure die cast aluminium housing with high power LED as lighting source and lens embedded PC cover having TOP Opening separate driver compartment with IP66 protection and impact resistance of IK07.

Item Description	HSN Code	List Price (₹)	Case Lot (No)
ENDURAPEARLNEOSL40WLED757PASYPCTOPC	9405	4200/-	01

Suitable for pole dia Ø 43 mm (max.).



### ENDURA PEARL PLUS

New generation energy saving and environmental friendly long life LED street light made up of pressure die cast aluminium housing with high power LED as lighting source and lens embedded PC cover having TOP OPENING separate driver compartment with IP66 protection and impact resistance of IK07 with 10KV Built-in Surge Protection Device.

Item Description	HSN Code	List Price (₹)	Case Lot (No)
ENDURAPEARLPLUSL60WLED757SASYTOPC	9405	6300/-	01
ENDURAPEARLPLUSL60WLED757PASYPCTOPC	9405	8065/-	01
ENDURAPEARLPLUSL70WLED757SASYTOPC	9405	6850/-	01
ENDURAPEARLPLUSL70WLED757PASYPCTOPC	9405	8615/-	01
ENDURAPEARLPLUSL80WLED757SASYTOPC	9405	8100/-	01
ENDURAPEARLPLUSL80WLED757PASYPCTOPC	9405	9750/-	01

Suitable for pole dia Ø 54 mm (max.).



### ENDURA CITYLITE PLATINUM

Energy saving and environmental friendly long life LED street light made up of pressure die cast aluminium housing with acrylic cover as diffuser with IP66 protection and Impact resistance of IK07.

Item Description	HSN Code	List Price (₹)	Case Lot (No)
ENDURACITYLITEPLATSL15WLED757SASYBOPC	9405	2285/-	01
ENDURACITYLITEPLATSL20WLED757SASYBOPC	9405	2285/-	01
ENDURACITYLITEPLATSL25WLED757SASYBOPC	9405	2385/-	01
ENDURACITYLITEPLATSL30WLED757SASYBOPC	9405	2800/-	01

Suitable for pole dia Ø 43 mm (max.).



### ENDURA CITYLITE PLATINUM PLUS

Energy saving and environmental friendly long life LED street light made up of pressure die cast aluminium housing with high power LED as lighting source and lens embedded PC cover having IP65 protection and Impact resistance of IK07.

Item Description	HSN Code	List Price (₹)	Case Lot (No)
ENDURACITYLITEPLATPLUSL30WLED757SASYBOPC	9405	3100/-	01
ENDURACITYLITEPLATPLUSL35WLED757SASYBOPC	9405	3400/-	01

Suitable for pole dia Ø 43 mm (max.).



### ENDURA CITYLINER NEX GEN

New generation energy saving and environmental friendly long life LED street light made up of pressure die cast aluminium housing with high power LED as lighting source and lens embedded PC cover with IP66 protection and impact resistance of IK07.

Item Description	HSN Code	List Price (₹)	Case Lot (No)
ENDURACITYLINERNEXGENSL40WLED757SASYBOPC	9405	4200/-	01
ENDURACITYLINERNEXGENSL45WLED757SASYBOPC	9405	4600/-	01
ENDURACITYLINERNEXGENSL48WLED757SASYBOPC	9405	5000/-	01

Suitable for pole dia Ø 42 mm (max.).



### ENDURA CITYLINER NEO / NEO N

LED streetlight made up of pressure die cast housing with toughened glass and individual high power LEDs with secondary optics, IP66 protection and impact resistance of IK07.

Item Description	HSN Code	List Price (₹)	Case Lot (No)
ENDURACITYLINERNEOSL90WLED757SASYBOTG	9405	8950/-	01
ENDURACITYLINERNEOSL100WLED757SASYBOTG	9405	9800/-	01
ENDURACITYLINERNEOSL120WLED757SASYBOTG	9405	11500/-	01

Suitable for pole dia Ø 54 mm (max.).



### ENDURA PULSE N

LED streetlight made up of pressure die cast housing with toughened glass and individual high power LEDs with secondary optics, **Potted driver**, IP66 protection and impact resistance of IK07.

Item Description	HSN Code	List Price (₹)	Case Lot (No)
ENDURAPULSEPLUSL135WLED757PASYBOTG	9405	15125/-	01
ENDURAPULSENSL150WLED757PASYBOTG	9405	15450/-	01

Suitable for pole dia Ø 60 mm (max.).



### ENDURA CITYLINER NEO

LED streetlight made up of pressure die cast housing with toughened glass and individual high power LEDs with secondary optics, **Potted driver**, IP66 protection and impact resistance of IK07.

Item Description	HSN Code	List Price (₹)	Case Lot (No)
ENDURACITYLINERNEOSL170WLED757PASYBOTG	9405	20500/-	01
ENDURACITYLINERNEOSL200WLED757PASYBOTG	9405	21900/-	01

Suitable for pole dia Ø 60 mm (max.).



# Outdoor Luminaires

## SOLAR STREET LIGHTS/MINI MAST

### Solar LED Standalone Street Light Range - (2 Days Backup)

For Panel, Battery, Pole and SCC specification pls. contact branch office or refer Catalogue

Solar Standalone Street Light system mentioned below includes LED street Light with in-built SCC, SPV Panel, Battery, HDG Tubular Pole.

Description	HSN Code	Luminaire Wattage	System Voltage	Lumen	MPPT/ PWM	Solar Panel Wp	Battery (LMLA/GEL) Ah	HDG Tubular Pole above ground	List Price (₹) for LMLA	List Price (₹) For GEL
15 W Solar SLS	8543	15	12	1500	PWM	75	40	5 M TUB Pole	38100/-	38600/-
20 W Solar SLS	8543	20	12	2100	PWM	100	60	5 M TUB Pole	44200/-	47600/-
24 W Solar SLS	8543	24	12	2400	PWM	125	60	5 M TUB Pole	47900/-	51500/-
21 W Solar SLS	8543	21	12	2205	MPPT	80	60	5 M TUB Pole	44400/-	47900/-
24 W Solar SLS	8543	24	12	2400	MPPT	100	60	5 M TUB Pole	47400/-	51000/-
30 W Solar SLS	8543	30	12	3150	MPPT	125	75	6 M TUB Pole (B)	55000/-	58600/-
36 W Solar SLS	8543	36	12	3780	MPPT	150	80	6 M TUB Pole (B)	62000/-	65600/-
39 W Solar SLS	8543	39	12	4095	MPPT	160 (80x2)	100	6 M TUB Pole (B)	66800/-	73200/-
45 W Solar SLS	8543	45	24	4725	MPPT	200 (100x2)	120 (60x2)	6 M TUB Pole (B)	82800/-	89900/-
60 W Solar SLS	8543	60	24	6300	MPPT	250 (125x2)	150 (75x2)	7 M Oct	116000/-	123300/-
70 W Solar SLS	8543	70	24	7350	MPPT	300 (150x2)	160 (80x2)	7 M Oct	129000/-	136300/-

\* PWM - Pulse Width Modulation \* MPPT - Maximum Power Point Tracking \* (B) - Pole with base plate \* LMLA - Low Maintenance Lead Acid Tubular \* GEL - VRLA Solar Gel  
 \* Blue tooth & Hybrid Option available from 7 W to 70 W. \* Any change in the specification other than above mentioned specification for Solar PV module, Battery, Luminaire, Pole, Hybrid, Bluetooth etc will be charged extra. \* Price : Ex Works Noida. \* Taxes : Extra as applicable \* Transportation :- Extra as applicable \* Warranty :- 1 year for complete system against manufacturing defect only, Additional warranty will be charged extra.

### Solar LED Standalone Street Light Range - (3 Days Backup)

For Panel, Battery, Pole and SCC specification pls. contact branch office or refer Catalogue

Solar Standalone Street Light system mentioned below includes LED street Light with in-built SCC, SPV Panel, Battery, HDG Tubular Pole.

Description	HSN Code	Luminaire Wattage	System Voltage	Lumen	MPPT/ PWM	Solar Panel Wp	Battery (LMLA/GEL) Ah	HDG Tubular Pole above ground	List Price (₹) for LMLA	List Price (₹) For GEL
7 W Solar SLS	8543	7	12	735	PWM	40	40	4 M TUB Pole	29900/-	29500/-
12 W Solar SLS	8543	12	12	1200	PWM	60	40	5 M TUB Pole	35600/-	38300/-
15 W Solar SLS	8543	15	12	1500	PWM	75	60	5 M TUB Pole	41800/-	45400/-
20 W Solar SLS	8543	20	12	2100	PWM	100	75	5 M TUB Pole	46400/-	49900/-
24 W Solar SLS	8543	24	12	2400	PWM	125	80	5 M TUB Pole	50900/-	54700/-
21 W Solar SLS	8543	21	12	2205	MPPT	80	75	5 M TUB Pole	46700/-	50100/-
24 W Solar SLS	8543	24	12	2400	MPPT	100	80	5 M TUB Pole	50400/-	54200/-
30 W Solar SLS	8543	30	12	3150	MPPT	125	100	6 M TUB Pole (B)	58800/-	65000/-
36 W Solar SLS	8543	36	12	3780	MPPT	150	120	6 M TUB Pole (B)	67700/-	75600/-
39 W Solar SLS	8543	39	12	4095	MPPT	160 (80x2)	150	6 M TUB Pole (B)	73300/-	81700/-
45 W Solar SLS	8543	45	24	4725	MPPT	200 (100x2)	160 (80x2)	6 M TUB Pole (B)	86900/-	96300/-
60 W Solar SLS	8543	60	24	6300	MPPT	250 (125x2)	200 (100x2)	7 M Oct	123600/-	136000/-
70 W Solar SLS	8543	70	24	7350	MPPT	300 (150x2)	240 (120x2)	7 M Oct	140300/-	156000/-

\* PWM - Pulse Width Modulation \* MPPT - Maximum Power Point Tracking \* (B) - Pole with base plate \* LMLA - Low Maintenance Lead Acid Tubular \* GEL - VRLA Solar Gel  
 \* Blue tooth & Hybrid Option available from 7 W to 70 W. \* Any change in the specification other than above mentioned specification for Solar PV module, Battery, Luminaire, Pole, Hybrid, Bluetooth etc will be charged extra. \* Price : Ex Works Noida. \* Taxes : Extra as applicable \* Transportation :- Extra as applicable \* Warranty :- 1 year for complete system against manufacturing defect only, Additional warranty will be charged extra.

### Solar Mini Mast

For Panel, Battery, Mast and SCC specification pls. contact branch office or refer Catalogue.

Luminaire Type	HSN Code	Luminaire Wattage	System Voltage	Solar Panel Wp	Battery Ah	Solar Charge Controller	Metal Battery Box Powder Coated	Octagonal Pole HD Galvanized	List Price (₹)
Street Light	8543	4x30 W	24	500 Wp	400 Ah	MPPT	Mounting at 4 meter from ground	9 m	300000/-
Flood Light	8543	3x33 W	24	400 Wp	300 Ah	MPPT	Mounting at 4 meter from ground	9 m	272000/-
Flood Light	8543	4x33 W	24	500 Wp	400 Ah	MPPT	Mounting at 4 meter from ground	9 m	331500/-
Flood Light	8543	3x45 W	24	500 Wp	400 Ah	MPPT	Mounting at 4 meter from ground	9 m	334900/-

\* Blue tooth & Hybrid Option available. \* Any change in the specification other than above mentioned specification for Solar PV module, Battery, Luminaire, Pole, Hybrid, Bluetooth etc will be charged extra. \* Price : Ex Works Noida. \* Taxes : Extra as applicable \* Transportation :- Extra as applicable \* Warranty :- 1 year for complete system against manufacturing defect only, Additional warranty will be charged extra. \* Street Light - standard item. \* Flood Light - project item. \* Octagonal 4mm thick.

### SSL Neo Solar Street Light with in-built SCC

Model No	HSN Code	Power (W)	System Voltage	Lumen	Solar Charge Controller	List Price (₹)	Case Lot (No)
LHKTBJU7PA6J007	8543	7	12	630	PWM	4696/-	24
LHKTBJU7PA6J009	8543	9	12	810	PWM	5271/-	24
LHKTBJU7PA6J012	8543	12	12	1080	PWM	5654/-	24
LHKTBJU7PA6J015	8543	15	12	1350	PWM	5942/-	24
LHKTBJU7PA6J018	8543	18	12	1620	PWM	6229/-	24
LHKTBJU7PA6J020	8543	20	12	1800	PWM	6613/-	24
LHKTBJU7PA6J024	8543	24	12	2160	PWM	6996/-	12
LHKTBJU7PA6J028	8543	28	12	2520	PWM	7475/-	12

\* Taxes : Extra as applicable \* Transportation :- Extra as applicable \* Warranty :- 1 year for complete system against manufacturing defect only.







FANUC

ROBOCUT  
α-1iD

FANUC



# Conventional Luminaires Portfolio

### SURFACE CUM RECESS T5 MIRROR OPTICS

Lamp Type	Ordering Code	HSN Code	List Price (₹)	Case Lot (No)
1x28 W FTL T5	LHECDEFDIH1W028	9405*	1450/-	02
2x28 W FTL T5	LHECDEFOIH1W028	9405*	1725/-	02

Ceiling cutout size (mm): 1230 x 150 -1x28W FTL T5, 1230 x 185 -2x28W FTL T5.  
Note: Pre-Ano. Ref. L2 Cat. available on request.



### SURFACE CUM RECESS T8 MIRROR OPTICS

Lamp Type	Ordering Code	HSN Code	List Price (₹)	Case Lot (No)
1x36 W FTL T8 HF	LHECDEGFIH1W036	9405*	1450/-	02
2x36 W FTL T8 HF	LHECDEGOIH1W036	9405*	1840/-	02

Ceiling cutout size (mm): 1275 x 160 -1x36W FTL T8, 1275 x 200 -2x36W FTL T8.



### BATTEN EZ T5

Powder coated Batten for T5 28W with replaceable Electronic Ballast.

Lamp Type	Ordering Code	HSN Code	List Price (₹)	Case Lot (No)
1x14 W FTL T5	LHFYBYF10A1W014	9405*	445/-	10
1x28 W FTL T5	LHIT81128032	9405*	475/-	10



### REGAL BATTEN T5

Powder coated Regal Batten for T5 28W.

Lamp Type	Ordering Code	HSN Code	List Price (₹)	Case Lot (No)
1x2 8W FTL T5	LHFYBYF10N1W028	9405*	555/-	10
2x28 W FTL T5	LHFYBYF20N1W028	9405*	890/-	10
1x28 W FTL T5 THD<10%	LHFYBYF1PB1W028	9405*	670/-	10
2x28 W FTL T5 THD<10%	LHFYBYF2PB1W028	9405*	1115/-	10



### PCR FOR REGAL BATTEN T5

Powder coated reflector for Regal Batten T5.

Lamp Type	Ordering Code	HSN Code	List Price (₹)	Case Lot (No)
PCR upto 2x28 W T5	LSSLOW0007	9405*	235/-	10

Reflectors supplied in separate packaging of 10 pieces.



# Conventional Luminaires Portfolio

## LUMINAIRES

### REGAL BATTEN T8 NEO

Powder coated Regal Batten type luminaire with electronic ballast, suitable for domestic application 230V, 50Hz supply.

Lamp Type	Ordering Code	HSN Code	List Price (₹)	Case Lot (No)
1x36 W T8 Neo	LHFYBYG1IN1W036*	9405*	390/-	10

\*For domestic application only.



### REGAL BATTEN T8 EZ

Powder coated Regal Batten type luminaire with electronic ballast, suitable for domestic application 240V, 50Hz supply.

Lamp Type	Ordering Code	HSN Code	List Price (₹)	Case Lot (No)
2x36 W FTL HF T8 EZ	LHFYBYG2IN1W036	9405*	780/-	10

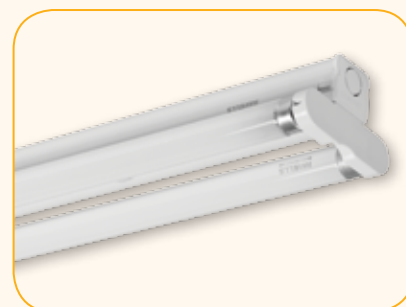

### REGAL BATTEN

Powder coated Regal Batten type luminaire with electronic ballast, suitable for Industrial application 240V, 50Hz supply.

Lamp Type	Ordering Code	HSN Code	List Price (₹)	Case Lot (No)
1x36 W FTL HF	LHFYBYG1OB1W036	9405*	555/-	10
2x36 W FTL HF	LHFYBYG2IB1W036	9405*	890/-	10

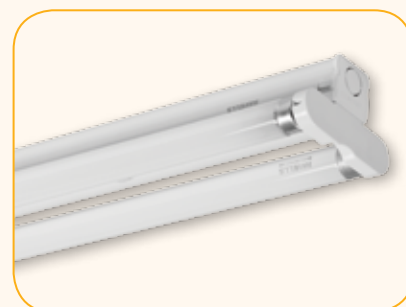

### RUGBY

Bulk head in die cast aluminium housing & frosted glass.

Lamp Type	Ordering Code	HSN Code	List Price (₹)	Case Lot (No)
upto 1x8 W CFL (TU)/ 100 W GLS	LHKL01160099	9405*	380/-	12



### JETA 1

Pressure die-cast aluminium floodlight luminaire for linear tungsten halogen lamp.

Lamp Type	Ordering Code	HSN Code	List Price (₹)	Case Lot (No)
500 W Halogen	LHFH05150099	9405*	530/-	12



### JETA 2

Pressure die-cast aluminium floodlight luminaire for linear tungsten halogen lamp.

Lamp Type	Ordering Code	HSN Code	List Price (₹)	Case Lot (No)
1000 W Halogen	LHFH05110099	9405*	1085/-	06



### JETA 6 NEW IP65

Pressure die-cast aluminium integral floodlight luminaire for SON-T/MH SET lamp.

Lamp Type	Product	Ordering Code	HSN Code	List Price (₹)	Case Lot (No)
1x250 W SON-T/MH SET	Housing	LHFY39140C99	9405*	3400/-	01
	Ballast	LHGM CJENEAC1250	8504	1525/-	04
1x400 W SON-T/MH SET	Housing	LHFY39140C99	9405*	3400/-	01
	Ballast	LHGMCKENEAE1400	8504	2140/-	04



### JETA 7 IP65

Pressure die-cast aluminium integral compact wide beam floodlight luminaire for HID lamp.

Lamp Type	Product	Ordering Code	HSN Code	List Price (₹)	Case Lot (No)
1x70 W MH DE	Housing	LHFM40115D99	9405*	2460/-	01
	Ballast	LHBW07170036	8504	660/-	08
1x150 W MH DE	Housing	LHFM40115D99	9405*	2460/-	01
	Ballast	LHBW20115036	8504	1055/-	06



### IMPACT POP NEW IP66

Streetlight luminaire in a single pc. pressure die-cast aluminium housing with "pot optics" & flat toughened glass. Suitable for lower wattage HID lamps.

Lamp Type	Product	Ordering Code	HSN Code	List Price (₹)	Case Lot (No)
1x70 W SON/MH-T	Housing	LHRY30170D99	9405*	1845/-	01
	Ballast	LHBW07170036	8504	660/-	08

Suitable for pole dia Ø 50 mm (max.).



### IMPACT POPULAR

Streetlight luminaire in single pc. pressure die-cast aluminium housing with "pot optics" & flat toughened glass.

Lamp Type	Product	Ordering Code	HSN Code	List Price (₹)	Case Lot (No)
1x150 W SON-T IP65	Housing	LHFTAZE1AN6J150	9405*	2315/-	01
	Ballast	LHBW20115036	8504	1055/-	04
1x250 W SON-T IP66	Housing	LHFTAZE1AN7J250	9405*	2725/-	01
	Ballast	LHGM CJENEAC1250	8504	1525/-	04

Suitable for pole dia Ø 50 mm (max.).



# Conventional Luminaires Portfolio

## ACCESSORIES

### OPEN CONSTRUCTION (OC) BALLAST for HID Lamps - 240V 50Hz

Lamp Type	Ordering Code	HSN Code	List Price (₹)	Case Lot (No)
1x70 W SON/MH	LHBW07170036	8504	660/-	08
1x150 W SON/MH	LHBW20115036	8504	1055/-	06
1x250 W SV/MH Sleek	LHGM CJENEAC1250	8504	1525/-	04
1x400 W SV/MH Sleek	LHGMCKENEBE1400	8504	2140/-	04
1x400 W HPMV	LHGMCGENEED1400	8504	1700/-	04

\*Base plate & stack design as per 400W SON/MH OC ballast.



### OLYMPIAN SLIM/ SLEEK (ELECTRONIC BALLAST)

Ignitor for	Ordering Code	HSN Code	List Price (₹)	Case Lot (No)
1x36 W FTL with wire	LHBF28904025	8504	300/-	20



### T5 EZ/ T8 EZ (ELECTRONIC BALLAST)

Lamp Type	Ordering Code	HSN Code	List Price (₹)	Case Lot (No)
1x28 W FTL	LHBT03128032	8504	325/-	20
1x36 W FTL	LHGEAFDBHPA1036	8504	275/-	20



### OLYMPIAN (ELECTRONIC BALLAST)

Ignitor for	Ordering Code	HSN Code	List Price (₹)	Case Lot (No)
1x36/40 W FTL	LHBF27904025	8504	300/-	20



### ELECTRONIC BALLASTS

for T5 / T8 / T12 Fluorescent lamps - High performance (THD<33%)

Lamp Type	Ordering Code	HSN Code	List Price (₹)	Case Lot (No)
2x28 W FTL T5	LHBT01228033	8504	485/-	20
1x36/40 W FTL	LHBF07104026	8504	335/-	20
2x36/40 W FTL	LHBF07204027	8504	485/-	20
2x24 W FTL	LHBT01224034	8504	455/-	20

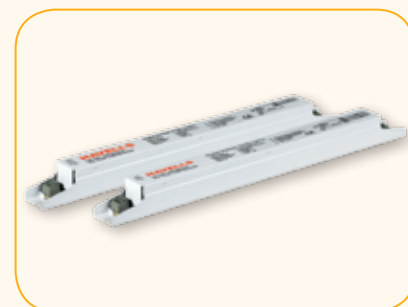

### D TYPE SHORT DISTANCE IGNITORS WITH STUD for 70-400 W SON & MH lamps

Ignitor for	Ordering Code	HSN Code	List Price (₹)	Case Lot (No)
HPSV/MH lamp	LHGEAJENNNA1000	8504	125/-	50

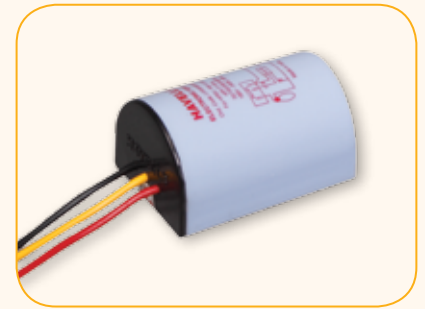

### IGNITORS for 70-400 W HID lamps

Ignitor for	Ordering Code	HSN Code	List Price (₹)	Case Lot (No)
HPSV lamp (S.D.) upto 5 m	LHGEAJENNNA1099	8504	95/-	50
SV/MH lamp (L.D.) upto 30 m	LHGEAJENNNA1999	8504	135/-	06

S.D. is short distance, L.D. is long distance.



# Conventional Luminaires Portfolio

## LAMPS

### TUNGSTON LINER HALOGEN LAMP (TH)

Lamp Type	Ordering Code	HSN Code	Cap Base	List Price (₹)	Case Lot (No)
500 W Halogen	LHSH10050099	8539	Rx7s	65/-	50x8*
1000 W Halogen	LHSH10010099	8539	Rx7s	90/-	50x8*

\*Halogen Lamps are packed individually in coloured boxes and 50 lamps packed in 1 box and 8 boxes of 50 Lamps in each master carton.

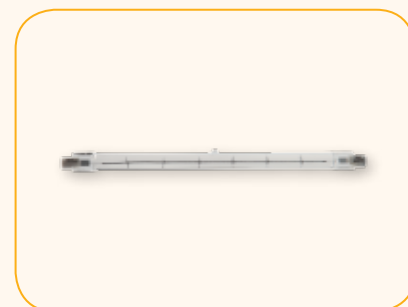

### METAL HALIDE DOUBLE ENDED QUARTZ TUBE LAMP (MH DE) - for enclosed fixture\* only

Lamp Type	Ordering Code	HSN Code	Cap Base	List Price (₹)	Case Lot (No)
70 W MHDE 6000 K	LHSM26070699	8539	Rx7s	460/-	12
150 W MHDE 6000 K	LHSM26015699	8539	Rx7s	460/-	12

\*Enclosed fixture implies, fixture covered with tempered / toughened glass.



### METAL HALIDE SINGLE ENDED CLEAR TUBULAR LAMP (MH SET) - for enclosed fixture\* only

Lamp Type	Ordering Code	HSN Code	Cap Base	List Price (₹)	Case Lot (No)
70 W MH SET 4000 K	LHSM12070499	8539	E27	685/-	40
150 W MH SET 4000 K	LHSM12015499	8539	E27	685/-	40
150 W MH SET 4000 K	LHLIAEJBUI8Y150	8539	E40	685/-	12
250 W MH SET 6000 K (Inst)	LHLQABIGUC8O250	8539	E40	755/-	12
400 W (BT) 6000 K (Inst)	LHLQALIGUL7O400	8539	E40	755/-	12

\*Enclosed fixture implies, fixture covered with tempered / toughened glass.



### METAL HALIDE SINGLE ENDED COATED ELLIPTICAL LAMP (MH SEE) - for enclosed fixture\* only

Lamp Type	Ordering Code	HSN Code	Cap Base	List Price (₹)	Case Lot (No)
70 W MH SEE 6000 K	LHLQABHFUC7P070	8539	E27	685/-	24

\*Enclosed fixture implies, fixture covered with tempered / toughened glass.



### HIGH PRESSURE SODIUM VAPOUR TUBULAR CLEAR LAMP (SON-T)

Lamp Type	Ordering Code	HSN Code	Cap Base	List Price (₹)	Case Lot (No)
70 W SON-T	LHSS16107099	8539	E27	260/-	40
150 W SON-T	LHSS16015099	8539	E40	370/-	12
250 W SON-T	LHSS16025099	8539	E40	400/-	12
400 W SON-T	LHSS16040099	8539	E40	460/-	12

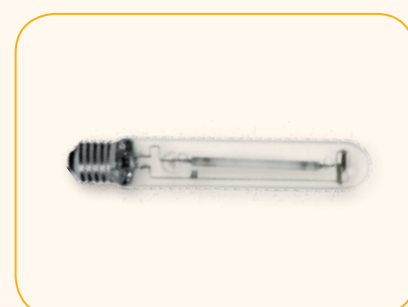

### HIGH PRESSURE SODIUM VAPOUR ELLIPTICAL COATED LAMP (SON-E)

Lamp Type	Ordering Code	HSN Code	Cap Base	List Price (₹)	Case Lot (No)
70 W SON-E	LHSS15170099	8539	E27	260/-	20



### T5 HIGH EFFICIENCY/ HIGH OUTPUT FTL LAMP

Lamp Type	Ordering Code	HSN Code	Cap Base	List Price (₹)	Case Lot (No)
14 W T5 HE 6500 K	LHST27114699	8539	G5	95/-	50
28 W T5 HE 6500 K	LHST27128699	8539	G5	110/-	50
24 W T5 HO 6500 K	LHST27124699	8539	G5	125/-	50





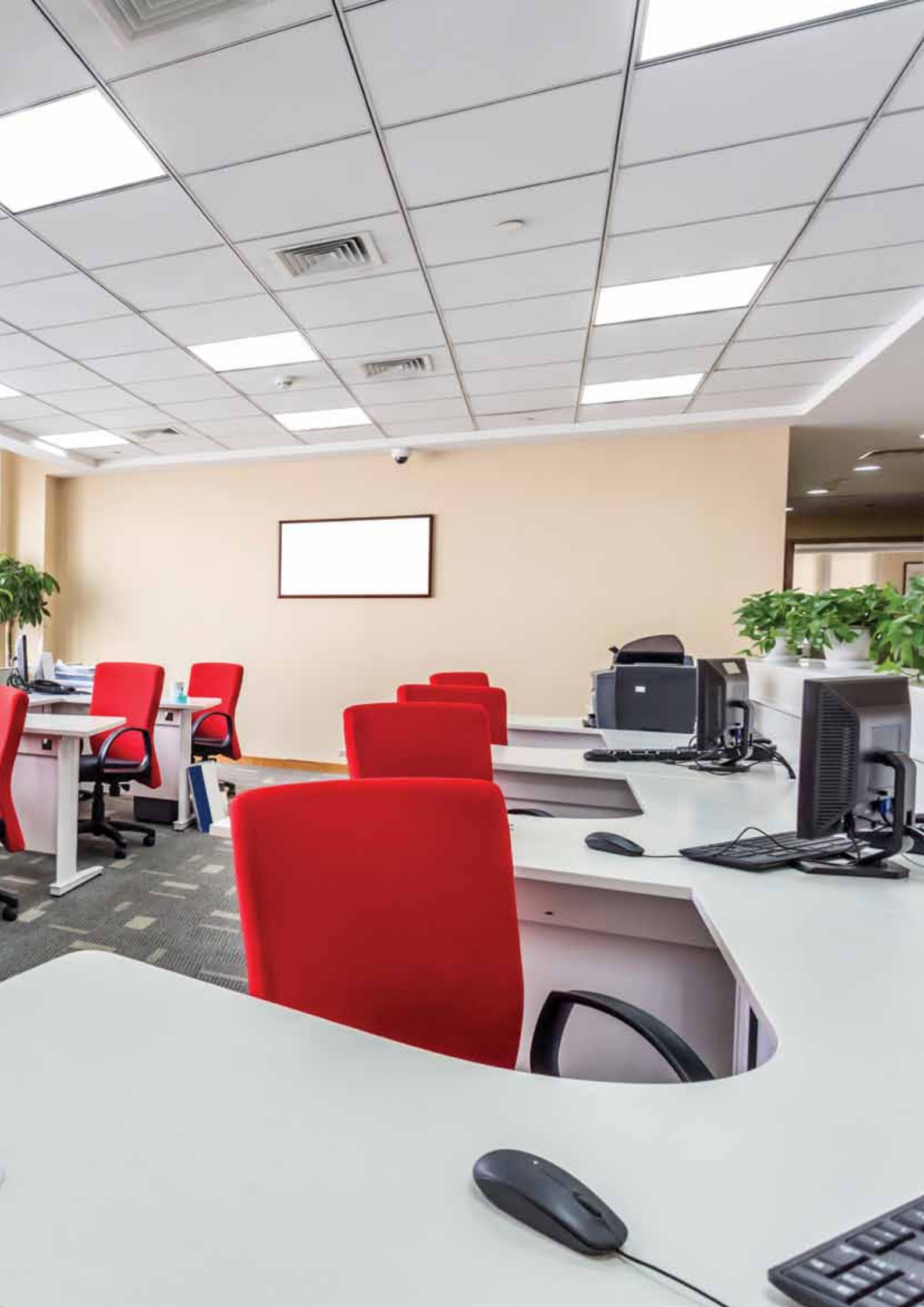





## GENERAL CONDITIONS OF BUSINESS

- Prices are in Indian ₹ (Inclusive of GST)
- All prices are subject to Havells general terms & conditions of business.
- Warranty void for LED fixtures including drivers, if individual points of installations are not provided with proper earthing.
- Orders should be placed in case lot multiples & against the confirmed purchase order only.
- Continuous design improvement is a routine practice at Havells. Data provided may change without any prior intimation. Customers are advised to reconfirm the data or product dimensions before purchase with our local offices.
- This Price List supersedes all our previous Price Lists.
- Prices are subject to change without notice.
- Company reserves the right to issue amendments, which may arise due to any errors in the price list.

HSN Code	Products Included	GST Applicable
9405	LED Fixtures and LED Drivers	12%
9405*	Conventional Fixtures	18%
8504	Ballast (Electronic, HID)/ Ignitors	18%
8543	Solar Street Lights/Mini Mast	5%
7308	Galvanized products	18%
8504*	Rest	18%
8539	Non-LED Lamps	18%

*Although every effort has been made to ensure accuracy in the compilation of the technical detail within this publication, however current details should therefore be checked with Havells. Specifications and performance data are constantly changing. Copyright Subsists. Imitation of trade dress, graphics and color scheme of this document is a punishable offence.*

### REGIONAL & BRANCH OFFICES:

**NORTH - REGIONAL OFFICE: Corporate Office:** QRG Towers, 2D, Sector-126, Expressway, Noida-201304, Tel: 0120-3331000, **Delhi:** Tel: 011-47676700, 23888200, **Chandigarh:** Tel: 0172-4232400-401, **Dehradun:** Tel: 0135-6670202, **Noida / Haryana:** Tel: 0120-3331000, **Ludhiana:** Tel: 0161-4676000 / 24, **Jammu:** Tel: 0191-2478330, 2479330, **Sri Nagar:** Tel: 0194-2490431, **Jaipur:** Tel: 0141-3914645, 3988210 **Jodhpur:** Tel: 0291-9214201640 / 45, **Lucknow:** Tel: 0522-6672100, **Kanpur:** Tel: 0512-6710400, 6710409

**EAST - REGIONAL OFFICE: Kolkata:** ICC Tower, 5th Floor, 4 India Exchange Place, Kolkata-700001, Tel: 033-40129851 / 52, **Bhubaneshwar:** Tel: 0674-6668101/102/103/104, **Guwahati:** Tel: 0361-2134521, 2458923, 2460355, **Siliguri:** Tel: 0353-2525907, **Ranchi:** 0651-2244861, 2244862, 2244864, 2244868, 2244869, **Jamshedpur:** Tel: 0657-6542492, 09234369436, **Patna:** Tel: 0612-2207221, 2207222, 2207223, 2655518

**WEST - REGIONAL OFFICE: Mumbai:** 1271, Solitaire Corporate Park, Bldg. No. 12, 7th Floor, Andheri - Ghatkopar Link Road, Chakala, Andheri (East), Mumbai- 400093. Ph.: 022 - 67298600-602, **Ahmedabad:** Tel: 079-40061111, 40060738-740, **Indore:** Tel: 0731-2572340-41, 4009998 (Airtel), **Rajkot:** Tel: 0281-2481112, 2921212, **Nagpur:** Tel: 0712-2240932, 2242692, 2242699 **Pune:** Tel: 020-64016413 / 14, **Raipur:** Tel: 0771-4243400 / 01, **Surat:** Tel: 0261-2350137, 9979890137, **Jabalpur:** Tel: 0761-4064491

**SOUTH - REGIONAL OFFICE: Chennai:** Sigapi Achi Building, No. 18 / 3, 6th Floor, Rukmani Lakshmipathy Road, Egmore, Chennai-600008, Tel: 044-42280600, 605, **Bangalore:** Tel: 080-49075000, **Coimbatore:** Tel: 0422-4550200, 2305199, 2306199, **Hyderabad:** Tel: 040-27533372, 27533355, 27533632, 66320407/0408/6401/6402, **Kochi:** Tel: 0484-4099000, **Vizag:** Tel: 0891-6514339, **Vijayawada:** Tel: +91-9247058847/57, **Calicut:** 0495-4019194, **Madurai:** 0452-4267022, **Trivandrum:** 0471-4015323, **Hubli:** 09448146028, **Trichy:** 09944460160

Representative Offices: • Goa • Solapur • Gwalior • Kathmandu • Bhopal

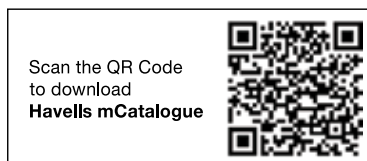

### Havells India Ltd.

QRG Towers, 2D, Sector -126, Expressway, Noida - 201 304 (UP), Ph. +91-120-3331000,  
E-mail: marketing@havells.com, www.havells.com  
Consumer Care No.: 1800 11 0303, 1800 103 1313 (All Connections), 011-4166 0303 (Landline)  
Join us on Facebook at www.facebook.com/havells and share your ways to save the planet!  
CIN - L31900DL1983PLC016304.

