



# Project Painter Plus

3A0249A  
ENG

*- For portable spray applications of architectural paints and coatings -  
(Specifications, page 2.)*

						
---	---	--	--	--	--	--

Use water based or mineral-spirit type material only. Do not use materials having flash points lower than 70°F (21°C). For more information about your material request MSDS from distributor or retailer.



### IMPORTANT SAFETY INSTRUCTIONS.

Read all warnings and instructions in this manual and on the sprayer cord. Save these instructions. See page 2 for model and series information including dispense rate, recommended hose length, guns, and maximum working pressure.

**Project Painter Plus  
Model 257025**

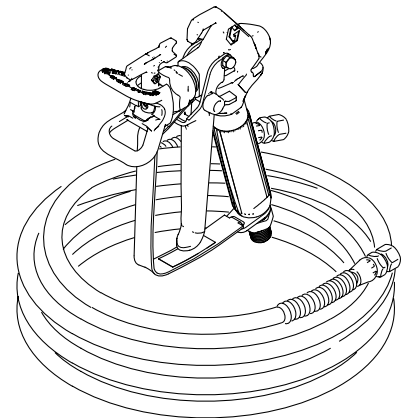
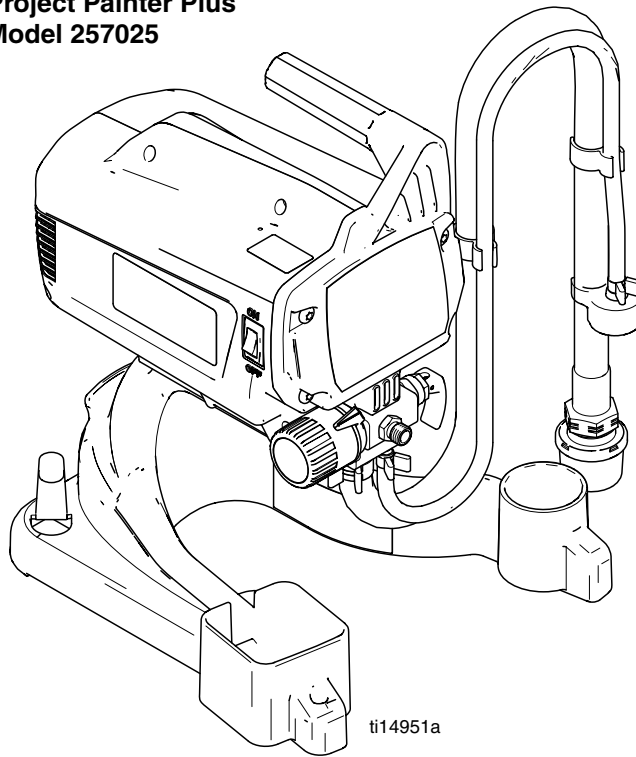

If you need additional assistance or if you are having problems with the sprayer, contact the **GRACO PRODUCT HELPLINE** at **888-541-9788**.



## Specifications

This equipment is not intended for use with flammable or combustible materials used in places such as cabinet shops or other “factory”, or fixed locations. If you intend to use this equipment in this type of application, you must comply with NFPA 33 and OSHA requirements for the use of flammable and combustible materials.

Model Name	Series	Dispense Rate gpm (lpm)	Hose Length and Diameter	Maximum Hose Length	Gun Model	Maximum Working Pressure		
						PSI	MPa	bar
<b>Project Painter Plus</b>	A	0.24 gpm (0.91 lpm)	1/4 in. x 25 ft (6.4 mm x 7.5 m)	50 ft (15 m)	SG2	2800	19	193

# Warnings

The following warnings are for the setup, use, grounding, maintenance and repair of this equipment. The exclamation point symbol alerts you to a general warning and the hazard symbol refers to procedure-specific risks. Refer back to these warnings. Additional, product-specific warnings may be found throughout the body of this manual where applicable.

## Grounding Instructions

This product must be grounded. In the event of an electrical short circuit, grounding reduces the risk of electric shock by providing an escape wire for the electric current. This product is equipped with a cord having a grounding wire with an appropriate grounding plug. The plug must be plugged into an outlet that is properly installed and grounded in accordance with all local codes and ordinances.

### WARNING



#### GROUNDING

- Improper installation of the grounding plug is able to result in a risk of electric shock.
- When repair or replacement of the cord or plug is required, do not connect the grounding wire to either flat blade terminal.
- The wire with insulation having an outer surface that is green with or without yellow stripes is the grounding wire.
- Check with a qualified electrician or serviceman when the grounding instructions are not completely understood, or when in doubt as to whether the product is properly grounded.
- Do not modify the plug provided; if it does not fit the outlet, have the proper outlet installed by a qualified electrician.
- This product is for use on a nominal 120V circuit and has a grounding plug similar to the plug illustrated in the figure below.

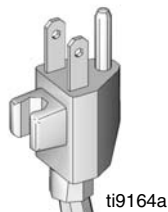

- Only connect the product to an outlet having the same configuration as the plug.
- Do not use an adapter with this product.

#### Extension Cords:

- Use only a 3-wire extension cord that has a 3-blade grounding plug and a 3-slot receptacle that accepts the plug on the product.
- Make sure your extension cord is not damaged. If an extension cord is necessary, use 12 AWG (2.5 mm<sup>2</sup>) minimum to carry the current that the product draws.

An undersized cord results in a drop in line voltage and loss of power and overheating.





 **WARNING**
**FIRE AND EXPLOSION HAZARD**

Flammable fumes, such as solvent and paint fumes, in work area can ignite or explode. To help prevent fire and explosion:

- Do not spray flammable or combustible materials near an open flame or sources of ignition such as cigarettes, motors, and electrical equipment. Only use water-based or mineral spirit-type materials with a flash point greater than 70° F (21° C).
- Paint or solvent flowing through the equipment is able to result in static electricity. Static electricity creates a risk of fire or explosion in the presence of paint or solvent fumes. All parts of the spray system, including the pump, hose assembly, spray gun, and objects in and around the spray area shall be properly grounded to protect against static discharge and sparks. Use conductive or grounded high-pressure airless paint sprayer hoses.
- Verify that all containers and collection systems are grounded to prevent static discharge.
- Connect to a grounded outlet and use grounded extensions cords. Do not use a 3-to-2 adapter.
- Do not use a paint or a solvent containing halogenated hydrocarbons.
- Keep spray area well-ventilated. Keep a good supply of fresh air moving through the area. Keep pump assembly in a well ventilated area. Do not spray pump assembly.
- Do not smoke in the spray area.
- Do not operate light switches, engines, or similar spark producing products in the spray area.
- Keep area clean and free of paint or solvent containers, rags, and other flammable materials.
- Know the contents of the paints and solvents being sprayed. Read all Material Safety Data Sheets (MSDS) and container labels provided with the paints and solvents. Follow the paint and solvents manufacturer's safety instructions.
- Fire extinguisher equipment shall be present and working.
- Sprayer generates sparks. When flammable liquid is used in or near the sprayer or for flushing or cleaning, keep sprayer at least 20 feet (6 m) away from explosive vapors.

**SKIN INJECTION HAZARD**

- Do not aim the gun at, or spray any person or animal.
- Keep hands and other body parts away from the discharge. For example, do not try to stop leaks with any part of the body.
- Always use the nozzle tip guard. Do not spray without nozzle tip guard in place.
- Use nozzle tips.
- Use caution when cleaning and changing nozzle tips. In the case where the nozzle tip clogs while spraying, follow the **Pressure Relief Procedure** for turning off the unit and relieving the pressure before removing the nozzle tip to clean.
- Do not leave the unit energized or under pressure while unattended. When the unit is not in use, turn off the unit and follow the **Pressure Relief Procedure** for turning off the unit.
- High-pressure spray is able to inject toxins into the body and cause serious bodily injury. In the event that injection occurs, **get immediate surgical treatment**.
- Check hoses and parts for signs of damage. Replace any damaged hoses or parts.
- This system is capable of producing 2800 psi. Use replacement parts or accessories that are rated a minimum of 2800 psi.
- Always engage the trigger lock when not spraying. Verify the trigger lock is functioning properly.
- Verify that all connections are secure before operating the unit.
- Know how to stop the unit and bleed pressure quickly. Be thoroughly familiar with the controls.

 <b>WARNING</b>	
	<p><b>PRESSURIZED ALUMINUM PARTS HAZARD</b></p> <p>Do not use 1, 1, 1-trichloroethane, methylene chloride, other halogenated hydrocarbon solvents or fluids containing such solvents in pressurized aluminum equipment. Such use can cause serious chemical reaction and equipment rupture, and result in death, serious injury, and property damage.</p>
	<p><b>MOVING PARTS HAZARD</b></p> <p>Moving parts can pinch or amputate fingers and other body parts.</p> <ul style="list-style-type: none"> <li>• Keep clear of moving parts.</li> <li>• Do not operate equipment with protective guards or covers removed.</li> <li>• Pressurized equipment can start without warning. Before checking, moving, or servicing equipment, follow the <b>Pressure Relief Procedure</b> in this manual. Disconnect power or air supply.</li> </ul>
	<p><b>TOXIC FLUID OR FUMES HAZARD</b></p> <p>Toxic fluids or fumes can cause serious injury or death if splashed in the eyes or on skin, inhaled, or swallowed.</p> <ul style="list-style-type: none"> <li>• Read MSDS's to know the specific hazards of the fluids you are using.</li> <li>• Store hazardous fluid in approved containers, and dispose of it according to applicable guidelines.</li> </ul>
	<p><b>PERSONAL PROTECTIVE EQUIPMENT</b></p> <p>You must wear appropriate protective equipment when operating, servicing, or when in the operating area of the equipment to help protect you from serious injury, including eye injury, inhalation of toxic fumes, burns, and hearing loss. This equipment includes but is not limited to:</p> <ul style="list-style-type: none"> <li>• Protective eye wear</li> <li>• Clothing and respirator as recommended by the fluid and solvent manufacturer</li> <li>• Gloves</li> <li>• Hearing protection</li> </ul>

# Installation

## Grounding and Electric Requirements



**Sprayer** must be grounded. Grounding reduces the risk of static and electric shock by providing an escape wire for electrical current due to static build up or in the event of a short circuit.

- This sprayer requires a 120 Vac, 60 Hz, 15A circuit with a grounding receptacle.
- Never use an outlet that is not grounded or an adapter.
- Do not use the sprayer if the electrical cord has a damaged ground prong.
- Only use an extension cord with an undamaged 3-prong plug.

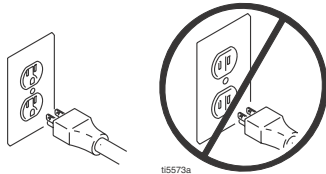

115573a



115972a

Recommended extension cords for use with this sprayer:

- 50 ft (15.0 m) 16 AWG (1.0 mm<sup>2</sup>)
- 100 ft (30.0 m) 14 AWG (1.5 mm<sup>2</sup>)

**Spray gun:** ground through connection to a properly grounded fluid hose and pump.

**NOTE:** Smaller gauge or longer extension cords may reduce sprayer performance.

**Fluid supply container:** follow local code.

**Solvent pails used when flushing:** follow local code. Use only conductive metal pails, placed on a grounded surface such as concrete. Do not place the pail on a nonconductive surface, such as paper or cardboard, which interrupts grounding continuity.

**Grounding the metal pail:** connect a ground wire to the pail by clamping one end to pail and other end to ground such as a water pipe.

**Maintaining grounding continuity when flushing or relieving pressure:** hold metal part of the spray gun firmly to the side of a grounded metal pail, then trigger the gun.



ti12936a

## Thermal Overload

Motor has a thermal overload switch to shut itself down if overheated. If unit overheats, allow approximately 45 minutes for unit to cool. Once cool, switch will close and unit will restart.

To reduce risk of injury from motor starting unexpectedly when it cools, always turn power switch OFF if motor shuts down.					

# Component Identification - Project Painter Plus

A	Airless spray gun	Dispenses fluid.
B	Power switch	Turns sprayer ON and OFF.
C	Pressure control knob	Increases (clockwise) and decreases (counter-clockwise) fluid pressure in pump, hose, and spray gun.
C1	Setting Indicator	To select function, align symbol on pressure control knob with setting indicator, page 9.
D	Pump fluid outlet fitting	Threaded connection for paint hose.
G	Suction tube	Draws fluid from paint pail into pump.
H	Prime tube (with diffuser)	Drains fluid in system during priming and pressure relief.
J	Prime/Spray valve	<ul style="list-style-type: none"> <li>In PRIME position directs fluid to prime tube.</li> <li>In SPRAY position directs pressurized fluid to paint hose.</li> <li>Automatically relieves system pressure in overpressure situations.</li> </ul>
L	Inlet screen	Prevents debris from entering pump.
M	Paint hose	Transports high-pressure fluid from pump to spray gun.
N	Handle	Used to help transport sprayer.
Q	Tip guard	Reduces risk of fluid injection injury.
R	Reversible spray tip	<ul style="list-style-type: none"> <li>Atomizes fluid being sprayed, forms spray pattern and controls fluid flow according to hole size.</li> <li>Reverse unclogs plugged tips without disassembly.</li> </ul>
S	Gun trigger safety lever (page 9)	Prevents accidental triggering of spray gun.
T	Gun fluid inlet fitting	Threaded connection for paint hose.
U	Power Flush attachment	Connects garden hose to suction tube for power flushing water-base fluids.
V	Gun fluid filter	Filters fluid entering spray gun to reduce tip clogs.
W	Pail Hook	Hold material pail.
X	Power Cord	Supplies Project Painter Plus with electricity.

### Project Painter Plus

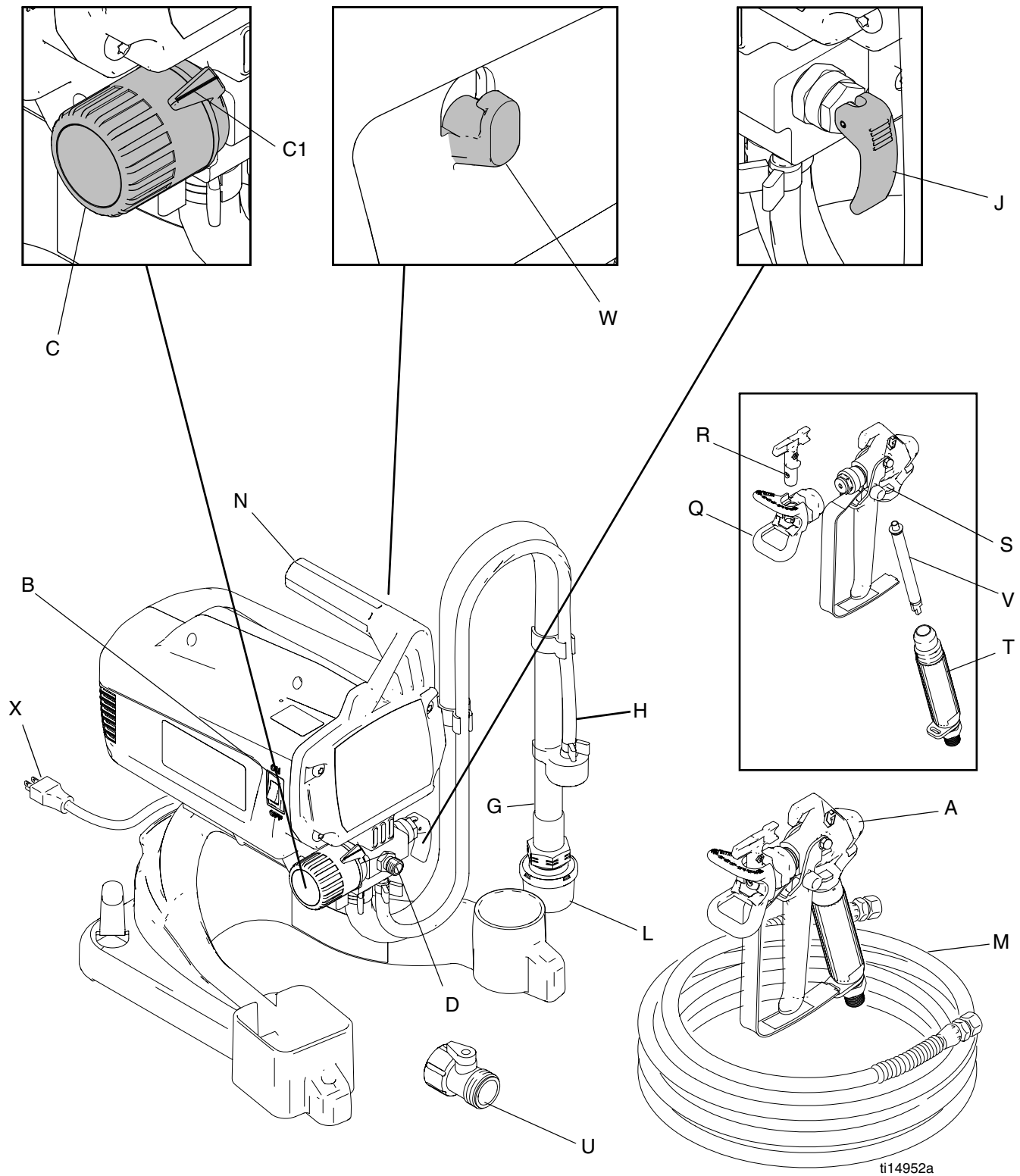

ti14952a



# General Repair Information

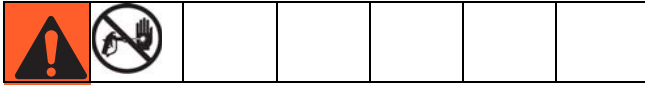

## Trigger Lock

Always engage the trigger lock when you stop spraying to prevent the gun from being triggered accidentally by hand or if dropped or bumped.

**Trigger Locked**

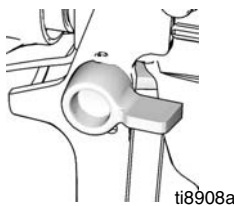

ti8908a

**Trigger Unlocked**

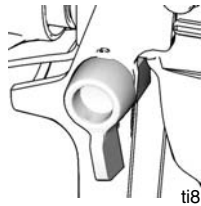

ti8909a

2. Lift prime/spray valve to PRIME to relieve pressure.

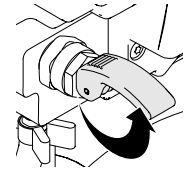

3. Hold gun firmly to side of pail. Trigger the gun to relieve pressure.

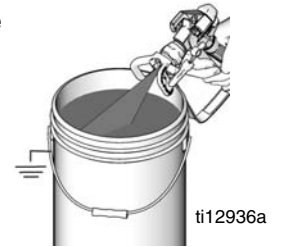

ti12936a

4. Engage trigger lock.

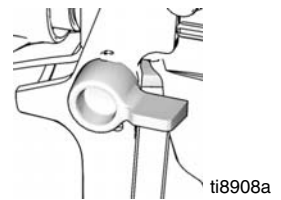

ti8908a

## Pressure Relief Procedure

Follow this **Pressure Relief Procedure** whenever you stop spraying and before cleaning, checking, servicing, or transporting equipment.



1. Turn power switch OFF and unplug power cord.

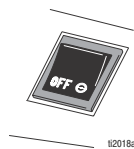

ti2018a

**NOTE:** Leave prime/spray valve in the PRIME position until you are ready to spray again.

If you suspect the spray tip or hose is clogged or that pressure has not been fully relieved after following the steps above, **VERY SLOWLY** loosen tip guard retaining nut or hose end coupling to relieve pressure gradually, then loosen completely. Clear hose or tip obstruction. Read Unclogging Spray Tip instructions in the Sprayer or Gun Operation manual.

## Pressure Control Knob Settings

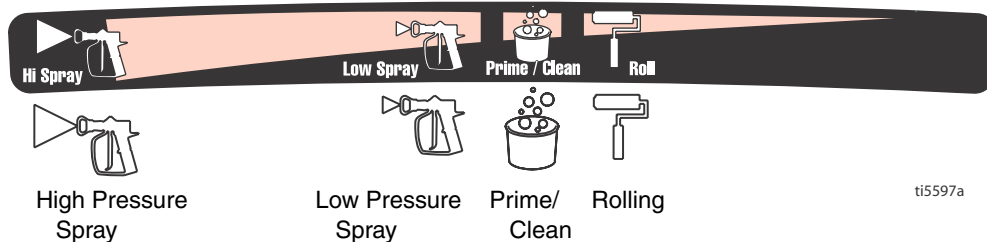

ti5597a

**NOTE:** To select function, align symbol on pressure control knob with setting indicator on sprayer.

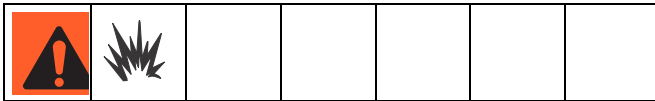

Flammable materials spilled on hot, bare, motor could cause fire or explosion. To reduce risk of burns, fire or explosion, do not operate sprayer with cover removed.

- Keep all screws, nuts, washers, gaskets, and electrical fittings removed during repair procedures. These parts usually are not provided with replacement kits.
- Test repairs after problems are corrected.
- If sprayer does not operate properly, review repair procedure to verify you did it correctly.
- Overspray may build up in the air passages. Remove any overspray and residue from air passages and openings in the enclosures whenever you service sprayer.
- Do not operate the sprayer without the cover in place. Replace if damaged. Covers direct cooling air around motor to prevent overheating.

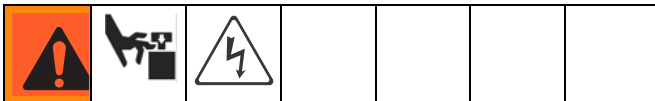

To reduce risk of serious injury, including electric shock:

- Do not touch moving or electric parts with fingers or tools while testing repair.
- Unplug sprayer when power is not required for testing.
- Install all covers, gaskets, screws and washers before you operate sprayer.

**NOTICE**

- Do not run sprayer dry for more than 30 seconds. Doing so could damage pump packings.
- Protect the internal drive parts of this sprayer from water. Openings in the cover allow for air cooling of the mechanical parts and electronics inside. If water gets in these openings, the sprayer could malfunction or be permanently damaged.
- Prevent pump corrosion and damage from freezing. Never leave water or water-base paint in sprayer when its not in use in cold weather. Freezing fluids can seriously damage sprayer. Store sprayer with Pump Armor to protect sprayer during storage.

# Basic Troubleshooting



Check everything in this Basic Troubleshooting Table before you bring the sprayer to an authorized service center.

Problem	Cause	Solution
Power switch is on and sprayer is plugged in, but motor does not run, and pump does not cycle.	Pressure is set at zero pressure.	Turn pressure control knob clockwise to increase pressure setting.
	Motor or control is damaged.	Take sprayer to authorized service center.*
	Electric outlet is not providing power.	<ul style="list-style-type: none"> <li>• Try a different outlet or plug in a compatible working appliance to test outlet.</li> <li>• Check plug end for light</li> <li>• Reset building circuit breaker</li> </ul>
	Extension cord is damaged.	Replace extension cord. Read <b>Grounding and Electric Requirements</b> , page 6.
	Sprayer electric cord is damaged.	Check for broken insulation or wires.
	Paint and/or water is frozen or hardened in pump.	<p>Unplug sprayer from outlet. If frozen do NOT try to start sprayer until it is completely thawed or you may damage the motor, control board and/or drivetrain.</p> <p>Make sure power switch is OFF. Place sprayer in a warm area for several hours. Then plug in power cord and turn sprayer ON. Slowly increase pressure setting to see if motor will start.</p> <p>If paint is hardened in sprayer, it may be damaged. Take sprayer to authorized service center.</p>
Pump does not prime.	Prime/spray valve is in SPRAY position.	Lift prime/spray valve to PRIME position.
	Inlet screen is clogged or suction tube is not immersed.	Clean debris off inlet screen and make sure suction tube is immersed in fluid.

\* The Project Painter Plus is a non-repairable sprayer. Please refer to page 15 for a list of replaceable parts.

Problem	Cause	Solution
Pump does not prime.	Inlet valve check ball is stuck.	Remove suction tube and place a pencil into the inlet section to dislodge the ball, allowing pump to prime properly. OR power flush sprayer (see Operation manual).
	Inlet valve check ball or seat is dirty.	Remove inlet housing. Clean and reinstall ball and seat and torque to 200-240 in-lb.
	Outlet valve check ball is stuck.	Unscrew outlet valve with a 3/4 in. socket. Remove and clean assembly. Reinstall and torque to 320-380 in-lb.
	Suction tube is not immersed	Make sure suction tube is immersed in paint.
	Suction tube is leaking.	Tighten suction tube connection. Inspect for cracks or vacuum leaks.
	Pump does not prime with fluid.	Remove suction tube from paint. Prime pump with water or solvent-based flushing fluid.
Pump cycles but does not build up pressure.	Pump is not primed.	Prime pump (see Operation manual).
	Inlet screen is clogged.	Clean debris off inlet screen and make sure suction tube is immersed in fluid.
	Suction tube is not immersed in paint.	Make sure suction tube is immersed in paint.
	Paint pail is empty.	Refill hopper or paint pail. Reprime sprayer.
	Suction tube is leaking.	Inlet tube fitting improperly or not securely attached.
	Prime/Spray Valve is worn or obstructed with debris.	Take sprayer to authorized service center.*
	Pump check ball is stuck.	Read <b><i>Pump does not prime</i></b> section above.
Pump cycles, but paint only dribbles or spurts when spray gun is triggered.	Pressure is set too low.	Turn pressure control knob clockwise to increase pressure setting which will turn on motor to build pressure.
	Spray tip is clogged.	Unclog spray tip (see Operation manual).
	Spray gun fluid filter is clogged.	Clean or replace gun fluid filter (see Operation manual).
	Spray tip is too large or worn.	Replace spray tip.

\* The Project Painter Plus is a non-repairable sprayer. Please refer to page 15 for a list of replaceable parts.

Problem	Cause	Solution
Pressure is set at maximum but cannot achieve a good spray pattern.	Reversible spray tip is in UNCLOG position.	Rotate arrow-shaped handle on spray tip so it points forward in SPRAY position (see Operation manual).
	Spray tip is too large for sprayer.	Select smaller spray tip.
	Spray tip is worn beyond capability of sprayer.	Replace spray tip.
	Extension cord is too long or not heavy enough gauge.	Replace extension cord. <b>Grounding and Electrical Requirements</b> , page 6.
	Spray gun fluid filter is clogged.	Clean spray gun fluid filter (see Operation manual).
	Inlet screen is clogged.	Clean debris off inlet screen.
	Pump valves are worn.	Check for worn pump valves. <ul style="list-style-type: none"> <li>a. Prime sprayer with paint</li> <li>b. Trigger gun momentarily. When trigger is released, pump should cycle momentarily and stop. If pump continues to cycle, pump valves may be worn. Take sprayer to authorized service center.*</li> </ul>
	Material too thick.	Thin material.
Spray gun stopped spraying.	Hose too long (if extra section is added).	Remove section of hose.
	Pump was not primed with flushing fluid.	Remove suction tube from paint. Prime pump with water or flushing solvent-based flushing fluid.
	Suction tube is leaking.	Tighten suction tube connection. Inspect for cracks or vacuum leaks.
	Prime/Spray Valve is plugged.	Clean/replace prime tube as necessary. Take sprayer to authorized service center if valve is plugged.*
When paint is sprayed, it runs down the wall or sags.	Spray tip is clogged.	Unclog spray tip (see Operation manual).
	Coat is going on too thick.	Move gun faster.
		Choose a tip with smaller hole size.
		Choose tip with wider fan.
When paint is sprayed, coverage is inadequate.	Paint coating is going on too thin.	Make sure gun is far enough from surface.
		Move gun slower.
		Choose tip with larger hole size.
		Choose tip with narrower fan.
		Make sure gun is close enough to surface.

Problem	Cause	Solution
Fan pattern varies dramatically while spraying.  OR  Sprayer does not turn on promptly when resuming spraying.	Pressure control switch is worn and causing excessive pressure variation.	Take sprayer to authorized service center.*
Cannot trigger spray gun.	Spray gun trigger lock is locked.	Rotate trigger safety lever to unlock trigger lock, page 9.
Paint is coming out of pressure control switch.	Pressure control switch is worn.	Take sprayer to authorized service center.*
Prime/spray valve actuates automatically relieving pressure through prime tube.	System is over pressurizing.	Take sprayer to authorized service center.*
Paint leaks down outside of pump.	Pump packings are worn.	Replace sprayer.*
Motor is hot and runs intermittently. Motor automatically shuts off due to excessive heat. Damage can occur if cause is not corrected. <b>Thermal Overload</b> , page 6.	Vent holes in enclosure are plugged or sprayer is covered.	Keep vent holes clear of obstructions and overspray and keep sprayer open to air.
	Extension cord is too long or not a heavy enough gauge.	Replace extension cord. Read <b>Grounding and Electrical Requirements</b> , page 6.
	Unregulated electrical generator being used has excessive voltage.	Use electrical generator with a proper voltage regulator. Sprayer requires 120VAC, 60 Hz, 1500-Watt generator.
	Sprayer was operated at high pressure with very small tip which causes frequent motor starts and excessive heat build up.	Decrease pressure setting or increase tip size.
Building circuit breaker opens after sprayer operates for 5 to 10 minutes.	Too many appliances are plugged in on same circuit.	Free up circuit (unplug things), or use a less busy circuit.
	Sprayer electrical cord is damaged.	Check broken insulation or wires. Replace electrical cord if damaged.
	Extension cord is damaged or too long or not a heavy enough gauge.	<ul style="list-style-type: none"> <li>• Plug in something that you know is working to test extension cord.</li> <li>• Replace extension cord.</li> </ul>

\* The Project Painter Plus is a non-repairable sprayer. Please refer to page 15 for a list of replaceable parts.

# Parts List

## Project Painter Plus Model (257025)

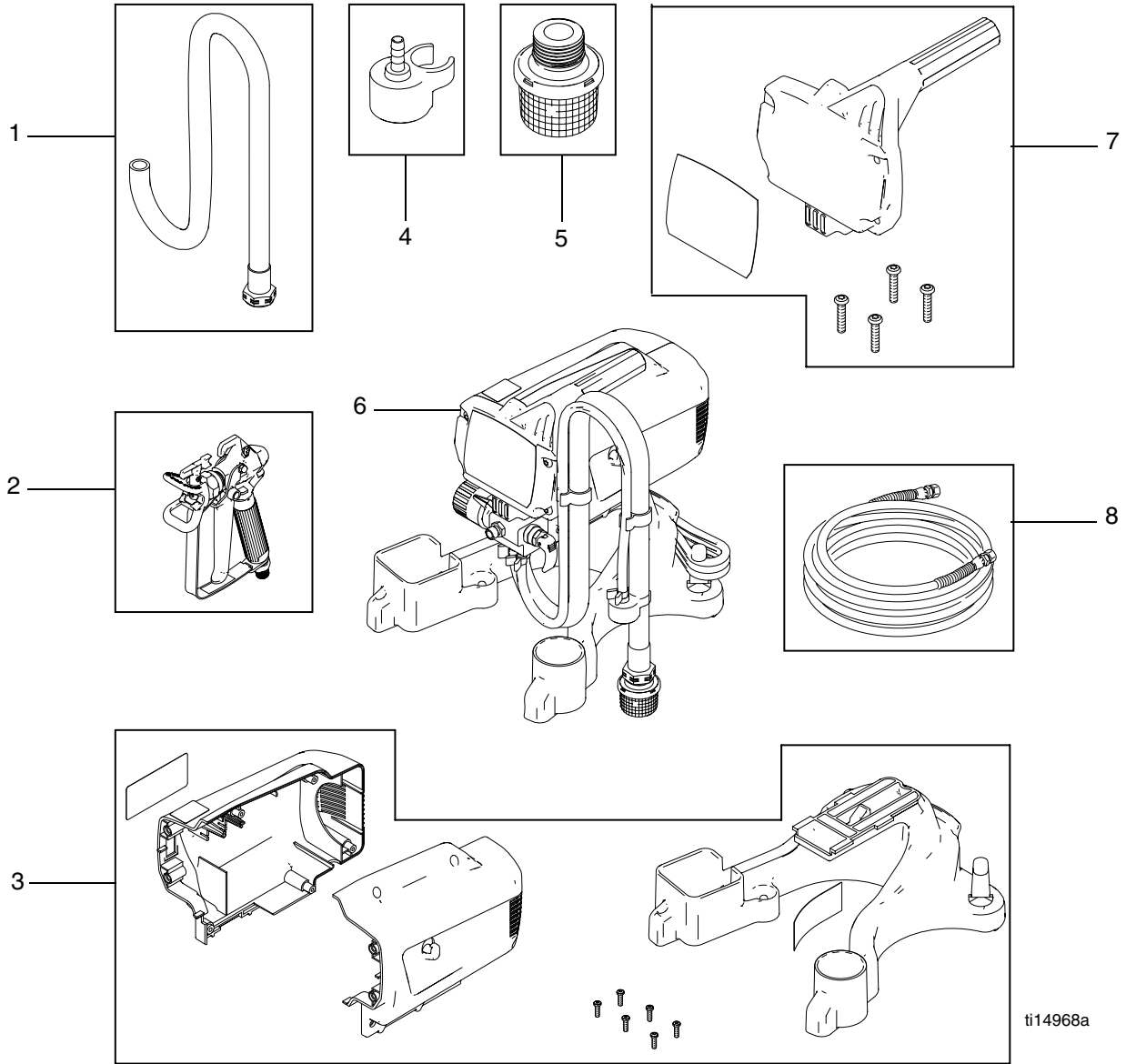

ti14968a

Ref.	Part	Description	Qty.
1	197607	KIT, suction tube	1
2	243011	GUN, SG2	1
3	24D616	KIT, enclosure and stand	1
4	244035	DEFLECTOR, barbed	1
5	257002	STRAINER	1
6	24D626	SPRAYER (no hose or gun)	1
7	24D617	KIT, front cover	1
8	247339	HOSE, 1/4 in. x 25 ft	1

# Wiring Diagram

## Project Painter Plus

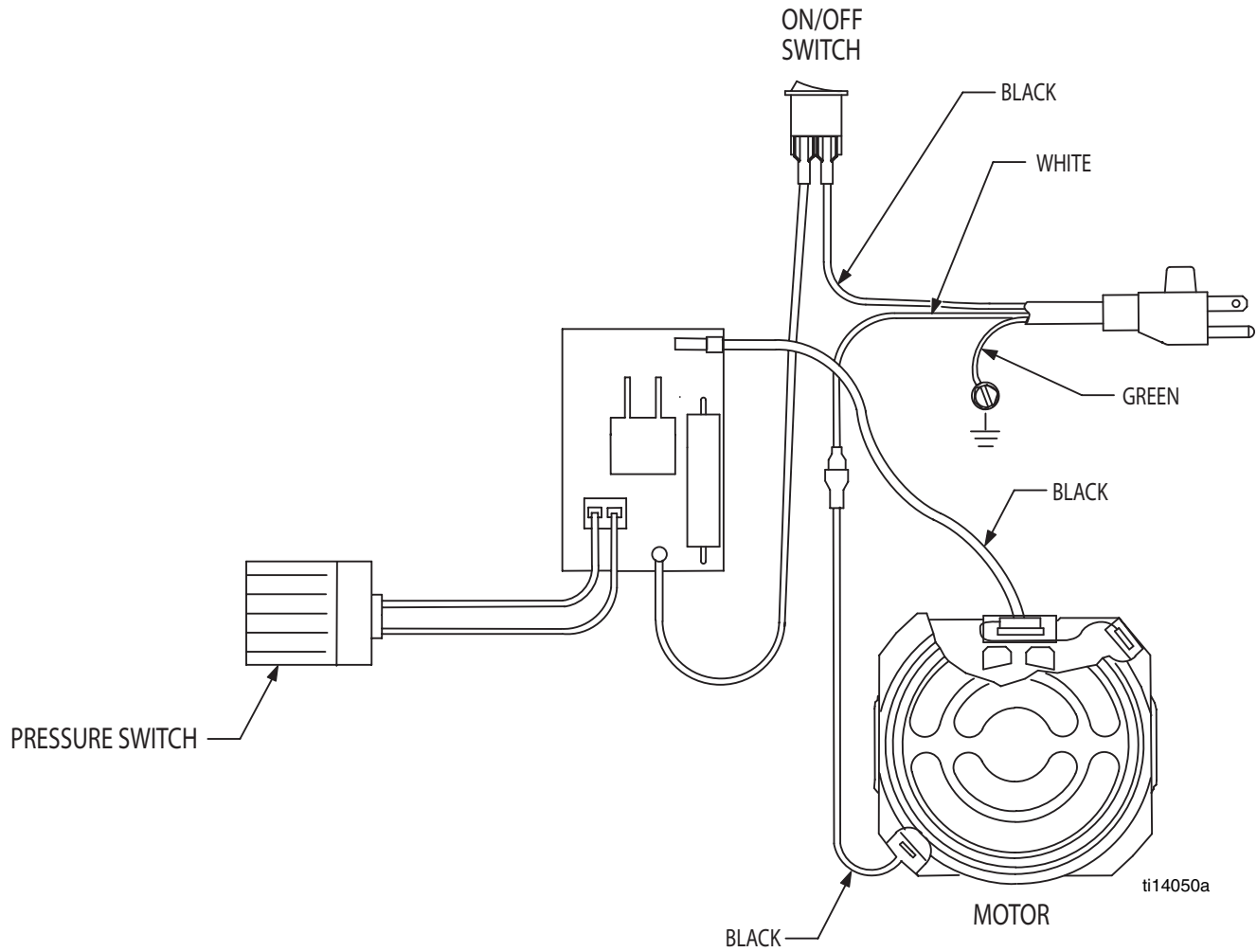



# Technical Data

<b>Project Painter Plus</b>	
Working pressure range	0-2800 psi (0-19 MPa, 0-193 bar)
Electric motor	7.0A (open frame, universal)
Operating horsepower	3/8
Maximum delivery (with tip)	0.24 gpm (0.91 lpm)
Paint hose	1/4 in. x 25 ft (6.4 mm x 7.5 m)
Maximum tip hole size	0.015 in. (0.38 mm)
Weight, sprayer only	10 lb (4.5 kg)
Weight, sprayer, hose & gun	13.2 lb (5.9 kg)
Dimensions (Upright):	
Length	13.6 in. (34.5 cm)
Width	11.1 in. (28.1 cm)
Height	17.8 in. (45.2 cm)
Dimensions (Folded):	
Length	N/A
Width	N/A
Height	N/A
Power cord	18 AWG, 3-wire, 6 ft (1.8 m)
Fluid inlet fitting	3/4 in. internal thread (standard garden hose thread)
Fluid outlet fitting	1/4 NPSM external thread
Inlet screen (on suction tube)	35 mesh (450 micron)
Wetted parts, pump & hose	stainless steel, brass, leather, ultra-high molecular weight polyethylene (UHMWPE), carbide, nylon, aluminum, PVC, polypropylene, fluoroelastomer
Wetted parts, gun	aluminum, brass, carbide, nylon, plated steel, stainless steel, UHMWPE, zinc
Generator requirement	1500 Watt minimum
Electrical power requirement	120 Vac, 60 Hz, 15A, 1 phase
Storage temperature range ♦❖	-30° to 160°F (-35° to 71°C)
Operating temperature range ✓	40° to 115°F (4° to 46°C)

- ♦ When pump is stored with non-freezing fluid. Pump damage will occur if water or latex paint freezes in pump.
- ❖ Damage to plastic parts may result if impact occurs in low temperature conditions.
- ✓ Changes in paint viscosity at very low or very high temperatures can affect sprayer performance.





# Standard Warranty

Graco warrants all equipment referenced in this document which is manufactured by Graco and bearing its name to be free from defects in material and workmanship on the date of sale to the original purchaser for use. With the exception of any special, extended, or limited warranty published by Graco, Graco will, for a period of twelve months from the date of sale, repair or replace any part of the equipment determined by Graco to be defective. This warranty applies only when the equipment is installed, operated and maintained in accordance with Graco's written recommendations.

This warranty does not cover, and Graco shall not be liable for general wear and tear, or any malfunction, damage or wear caused by faulty installation, misapplication, abrasion, corrosion, inadequate or improper maintenance, negligence, accident, tampering, or substitution of non-Graco component parts. Nor shall Graco be liable for malfunction, damage or wear caused by the incompatibility of Graco equipment with structures, accessories, equipment or materials not supplied by Graco, or the improper design, manufacture, installation, operation or maintenance of structures, accessories, equipment or materials not supplied by Graco.

This warranty is conditioned upon the prepaid return of the equipment claimed to be defective to an authorized Graco distributor for verification of the claimed defect. If the claimed defect is verified, Graco will repair or replace free of charge any defective parts. The equipment will be returned to the original purchaser transportation prepaid. If inspection of the equipment does not disclose any defect in material or workmanship, repairs will be made at a reasonable charge, which charges may include the costs of parts, labor, and transportation.

**THIS WARRANTY IS EXCLUSIVE, AND IS IN LIEU OF ANY OTHER WARRANTIES, EXPRESS OR IMPLIED, INCLUDING BUT NOT LIMITED TO WARRANTY OF MERCHANTABILITY OR WARRANTY OF FITNESS FOR A PARTICULAR PURPOSE.**

Graco's sole obligation and buyer's sole remedy for any breach of warranty shall be as set forth above. The buyer agrees that no other remedy (including, but not limited to, incidental or consequential damages for lost profits, lost sales, injury to person or property, or any other incidental or consequential loss) shall be available. Any action for breach of warranty must be brought within two (2) years of the date of sale.

**GRACO MAKES NO WARRANTY, AND DISCLAIMS ALL IMPLIED WARRANTIES OF MERCHANTABILITY AND FITNESS FOR A PARTICULAR PURPOSE, IN CONNECTION WITH ACCESSORIES, EQUIPMENT, MATERIALS OR COMPONENTS SOLD BUT NOT MANUFACTURED BY GRACO.** These items sold, but not manufactured by Graco (such as electric motors, switches, hose, etc.), are subject to the warranty, if any, of their manufacturer. Graco will provide purchaser with reasonable assistance in making any claim for breach of these warranties.

In no event will Graco be liable for indirect, incidental, special or consequential damages resulting from Graco supplying equipment hereunder, or the furnishing, performance, or use of any products or other goods sold hereto, whether due to a breach of contract, breach of warranty, the negligence of Graco, or otherwise.

## **FOR GRACO CANADA CUSTOMERS**

The Parties acknowledge that they have required that the present document, as well as all documents, notices and legal proceedings entered into, given or instituted pursuant hereto or relating directly or indirectly hereto, be drawn up in English.

Les parties reconnaissent avoir convenu que la rédaction du présente document sera en Anglais, ainsi que tous documents, avis et procédures judiciaires exécutés, donnés ou intentés, à la suite de ou en rapport, directement ou indirectement, avec les procédures concernées.

**TO PLACE AN ORDER** or to identify the nearest Graco, call 1-800-543-0339

*All written and visual data contained in this document reflects the latest product information available at the time of publication.  
Graco reserves the right to make changes at any time without notice.*

MM 3A0249

*This manual contains English*

**Graco Headquarters: Minneapolis**  
**International Offices: Belgium, China, Japan, Korea**  
**GRACO INC. P.O. BOX 1441 MINNEAPOLIS, MN 55440-1441**  
www.graco.com  
2009