

# PROMISE & PROGRESS

THE SIDNEY KIMMEL COMPREHENSIVE CANCER CENTER AT JOHNS HOPKINS

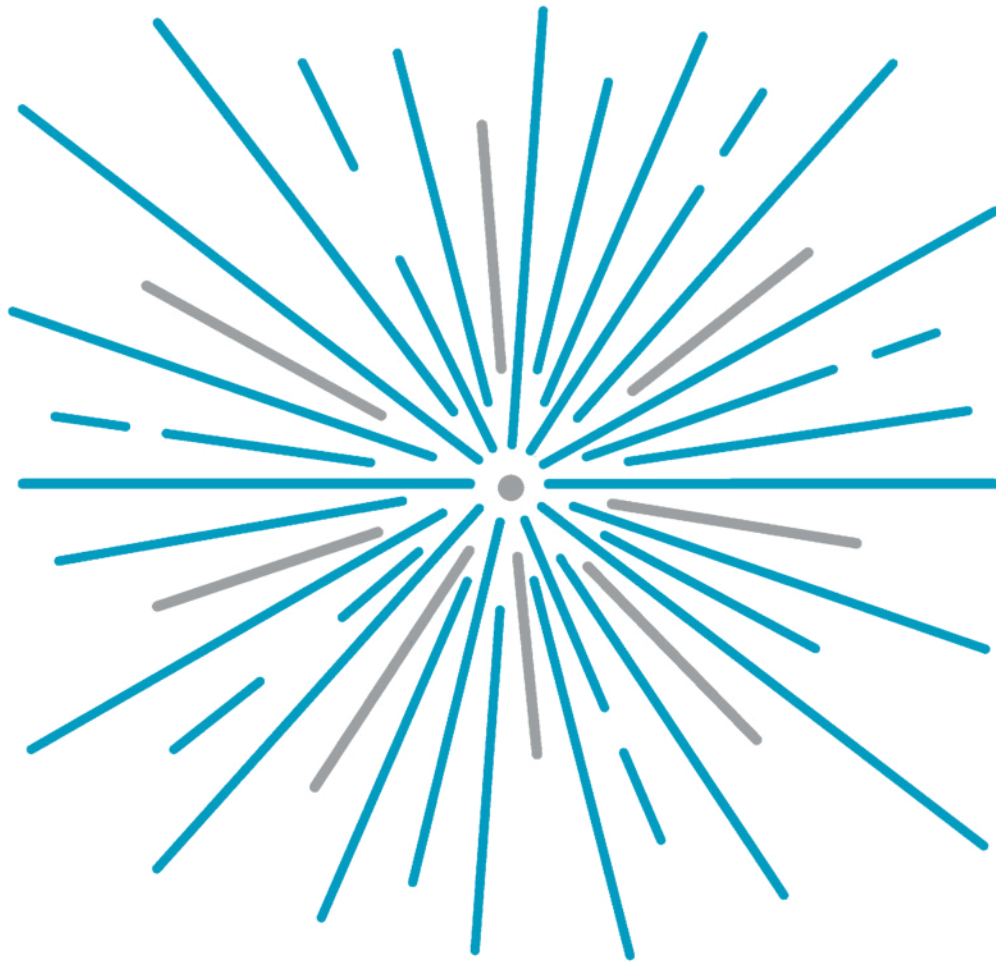

**Proton Therapy Is Here**  
A New Standard of Care

# Proton vs Photon

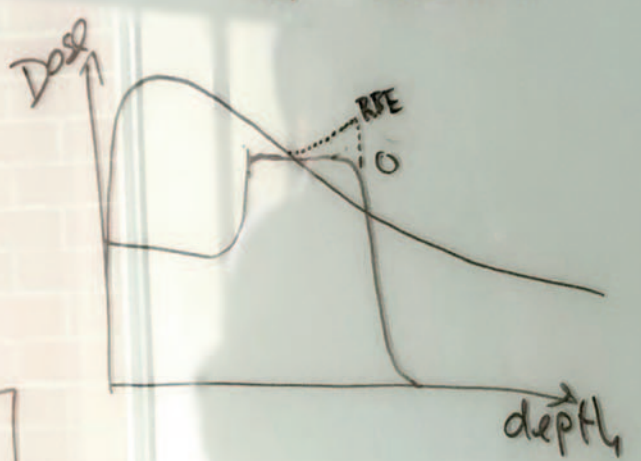
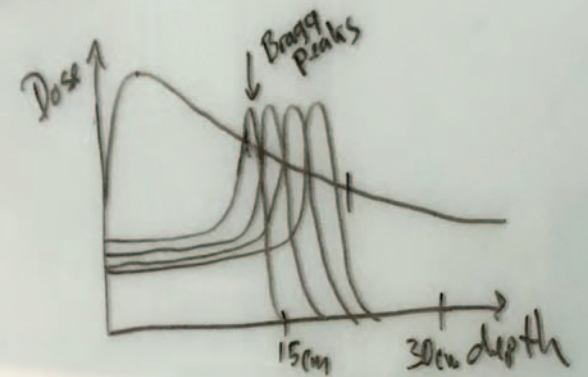

# Linear Energy Transfer Relative Biological Effect

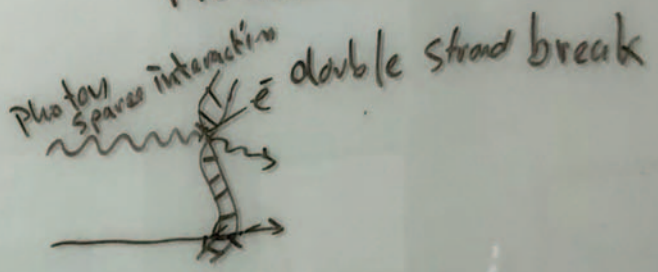

proton higher LET

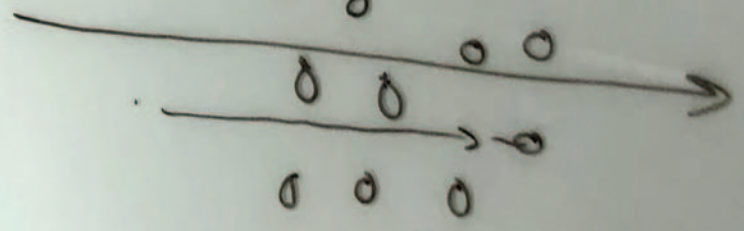
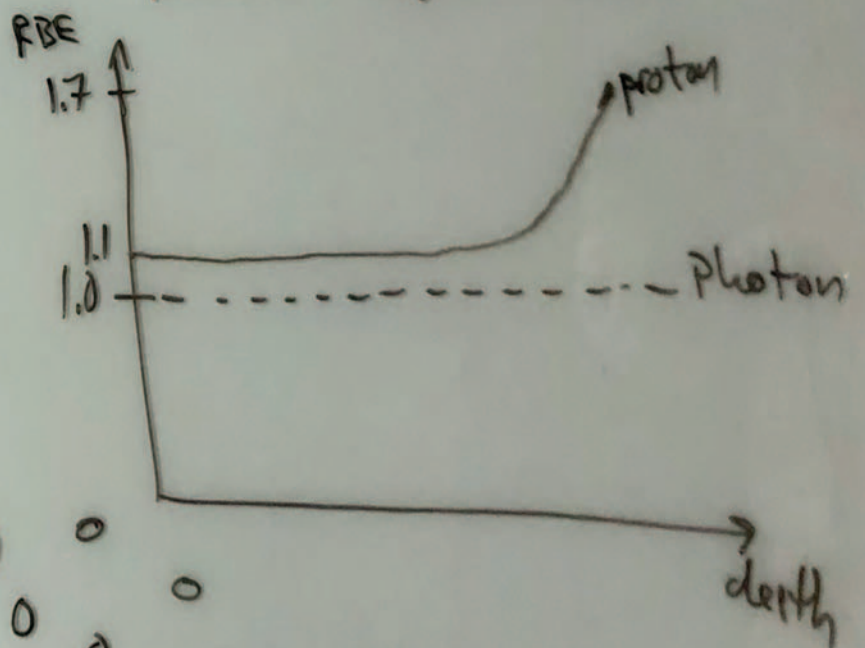

# P&P

THE SIDNEY KIMMEL  
COMPREHENSIVE  
CANCER CENTER AT  
JOHNS HOPKINS

*Promise & Progress*  
is published by  
*The Sidney Kimmel  
Comprehensive Cancer Center  
at Johns Hopkins*  
Office of Public Affairs  
Baltimore, Maryland  
410-955-1287

William G. Nelson, M.D., Ph.D.  
*Director*

Amy Mone  
*Director of Public Affairs*

Valerie Matthews Mehl  
*Editor and Sr. Writer*  
mehlva@jhmi.edu

Megan Mattis  
*Photography Assistant*

Howard Korn, Joe Rubino, Tim Bloomquist  
*Feature Photography*

For additional copies of this  
publication or further information  
about the Kimmel Cancer Center,  
please call 410-955-1287  
or email mehlva@jhmi.edu.

MSK Partners, Inc.  
*Design and Production*

Connecting  
**Promise to Progress**  
On the Web

CONNECT WITH US  
[HOPKINSCANCER.ORG](http://HOPKINSCANCER.ORG)

[FACEBOOK.COM/HOPKINSKIMMEL](https://FACEBOOK.COM/HOPKINSKIMMEL)

[YOUTUBE.COM/HOPKINSKIMMEL](https://YOUTUBE.COM/HOPKINSKIMMEL)

[TWITTER.COM/HOPKINSKIMMEL](https://TWITTER.COM/HOPKINSKIMMEL)

[INSTAGRAM.COM/HOPKINSKIMMEL](https://INSTAGRAM.COM/HOPKINSKIMMEL)

PODCASTS: [HOPKINSKIMMEL.LIBSYN.COM](http://HOPKINSKIMMEL.LIBSYN.COM)

[CANCER-MATTERS.BLOGS.HOPKINSMEDICINE.ORG](http://CANCER-MATTERS.BLOGS.HOPKINSMEDICINE.ORG)  
[OUR-CANCER.BLOGS.HOPKINSMEDICINE.ORG](http://OUR-CANCER.BLOGS.HOPKINSMEDICINE.ORG)

FOR APPOINTMENTS AND OTHER  
INFORMATION, CALL 410-955-5222

# Care. Collaboration. Innovation.

PROTON THERAPY IS HERE. The new Johns Hopkins National Proton Center at Sibley Memorial Hospital is built upon a long and rich tradition of excellence in radiation oncology, bringing nearly a half-century of cancer discovery and clinical progress to proton therapy.



It's striking that this technology has been around for more than 40 years but has never really been tested in the research setting. This is what sets us apart from other centers. We ask the tough questions because we are prepared to go after the answers. With a dedicated proton research laboratory, our experts are ready to do the hard work and gather the much-needed evidence to guide when and how proton therapy is best used.

We waited until the technology was right to bring proton therapy to Johns Hopkins, and when we did, we made it better, customizing it with our own inventions. Our proton therapy center will

have the most advanced pencil beam, which paints tumors with cancer cell-killing energy layer by layer, staying within the boundaries of the tumor. The beam adjusts to differences throughout a tumor to provide the right amount of energy to every different area of the tumor.

One size doesn't fit all. Every patient, every cancer, is different, so we are ushering in the most advanced tumor monitoring that makes the already safe and targeted pencil beam patient-specific and even more tumor-specific. Advanced imaging and sophisticated data mining will make complex comparisons of photon and proton therapies to ensure each patient receives the therapy that is best suited to his or her unique cancer.

We have the world's leading experts across all disciplines and specialties working in collaboration. This includes a collaboration with Children's National Hospital to create one of the largest pediatric radiation oncology programs in the country. Few other centers can claim this level of expertise. We know cancer and proton therapy. That is the Johns Hopkins difference. There are centers that can deliver proton therapy, and then there are centers like ours that combine the highest level of cancer care with scientific innovation to make sure the cancer medicine we deliver is the best medicine for each patient. Our new National Proton Center enhances our mission of curing cancer and changing lives.

William G. Nelson, M.D., Ph.D.  
Marion I. Knott Professor and Director  
*The Sidney Kimmel Comprehensive  
Cancer Center at Johns Hopkins*

# Proton Therapy Is Here

## Johns Hopkins excellence is setting a new standard of care

Technology without advanced and compassionate care is science alone. But technology in an environment of compassionate care, discovery and multispecialty collaboration focused on improving the lives of patients is cancer medicine. This is the hallmark of Johns Hopkins and the Kimmel Cancer Center, where innovation that exceeds the standard is the norm. The result is an unsurpassed level of expertise in radiation oncology, molecular radiation sciences, physics, surgical oncology, medical oncology, cancer biology, engineering, quantitative sciences and more that Johns Hopkins Medicine brings to proton therapy. This level of knowledge and multispecialty collaboration are fundamentally what set the Johns Hopkins National Proton Center apart from most other proton centers across the U.S. Expertise matters because the real value of proton therapy is in the specialists who develop and use it.

Proton therapy may be a rare commodity, with less than 40 centers in the U.S., but this level of expertise is even rarer. The Kimmel Cancer Center is among the very few that will combine cancer treatment excellence across all disciplines with proton therapy excellence.

“Patients and families need the team that knows the most about the tumor. You need to know cancer, not just proton therapy. That is a differentiator for us,” says **William Nelson**, Director of the Kimmel Cancer Center. “We bring the full complement of Johns Hopkins expertise, spanning programs and departments, and nearly a half-century of

cancer discovery and clinical progress to proton therapy.”

Although this technology provides new opportunity to move cancer science and medicine forward, not all proton therapy is created equal. We are not simply users and deliverers of proton therapy. Our scientists are also inventors, driving, testing and improving the technology to create a proton facility unlike any other. Building upon a lengthy history and strong foundation of pioneering discoveries in radiation therapy, this center has the technology to deliver the most advanced and patient-centered care.

The translational ingenuity that merges laboratory discovery with clinical care thrives in the Kimmel Cancer Center. It was engaged throughout the planning and construction of our proton center. As a result, it is one of the most comprehensive in the world, one of the very few separate, dedicated rooms for research, pediatric patient care and adult patient care. Proton therapy has raised many questions about for whom and how it is best used. Our experts are answering those questions. They are providing the “why” and “when” of proton therapy.

Despite commercial advertising to the contrary, proton therapy is not new, and the science is far from settled. “Although it has been around for a long time, it is very much in its infancy in terms of exploration and potential,” says **Akila Viswanathan**, interim director of the Department of Radiation Oncology and Molecular Radiation Sciences.

### COLLABORATION

Proton therapy has raised many questions about for whom and how it is best used. Our experts are helping answer those questions. They are providing the “why” and “when” of proton therapy.



**The Synchrotron**

A synchrotron is a type of particle accelerator used to accelerate protons for use in proton therapy. It is 26 feet in diameter and composed of a ring of small magnets. Protons are injected into the ring and begin traveling around the ring at great speeds, about 10 million times per second. Put another way, the speed of the protons is so fast, it could circle around the earth five times in one second. It is advanced technology over earlier generations of proton therapy because it can produce beams of a wide range of energies and reduces the risk of unnecessary and unwanted radiation to the patient.

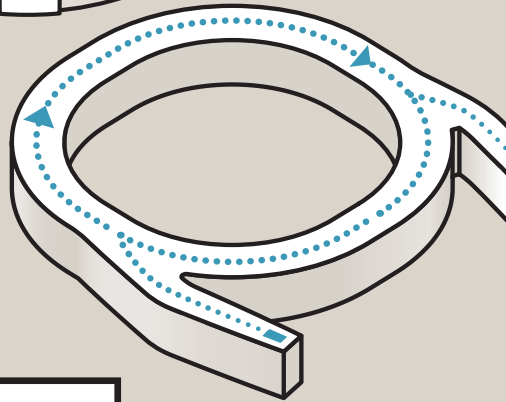
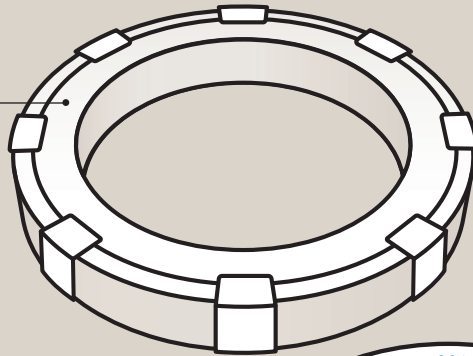

**HOW IT WORKS**

**Inside Our Proton Therapy Center**

The proton is small, but it takes big machinery to generate and move these subatomic particles for treatment.

**Gantries**

Protons travel down magnetic devices into the treatment rooms. A 360-degree, rotating, 30-foot-diameter iron framework, called a gantry, controls the speed and direction of protons. It allows radiation oncologists to direct the beam at any angle and deliver the proton beam with pinpoint accuracy to a patient's cancer.

Our center has four of these, with one gantry dedicated exclusively for pediatric patients and another for much-needed research.

**Pencil Beam Scanning**

This new technology funnels the protons into a narrow beam—just a pencil tip's width—coming out of the proton therapy machine hundreds of times per second, scanning the tumor back and forth and up and down, just to the edges of the tumor, to paint it layer by layer with the cancer-killing proton beam. Our advanced technology is intensity modulated, making it possible to deliver varying degrees of energy targeted to the specific composition of each area of the tumor.

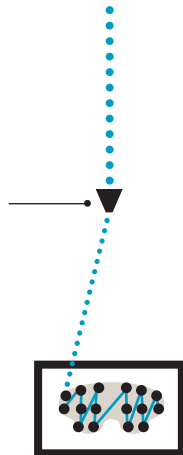

**Respiratory Gating**

The slightest motion can cause tumors to move. Our proton therapy beam tracks directly to the tumor, stopping if the tumor shifts with the patient's breathing and starting up again when the beam and tumor are aligned.

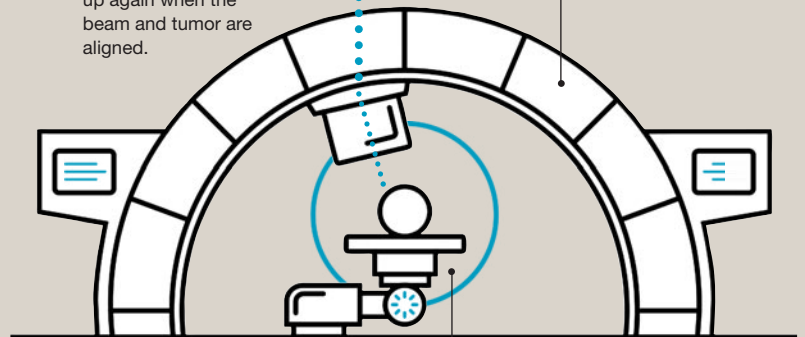

**On-Board Imaging**

Ours will be among the first to have on-board imaging. Plans for a CT Couch, invented by medical physics Director **John Wong** in collaboration with Hitachi, will provide a built-in CT scanner that merges images of the cancer taken during treatment planning with ones taken the day of treatment to verify that the tumor being treated has not changed or moved. It facilitates precision treatment within one-tenth of 1 millimeter accuracy.

As a result, what truly is new in proton therapy is what the Johns Hopkins National Proton Center brings: the laboratory and clinical research to make it better and to advance its use as a tool of precision medicine. Our proton center is among a select few academic centers in the country—and the only in the region—doing research to determine in which situations this type of radiation treatment is the best option.

#### INNOVATION

## Radiation treatment, in all of its forms, is essentially a form of minimally invasive surgery that replaces scalpels with precisely targeted radiation to get to cancers.

Proton therapy does not replace other forms of radiation therapy. “We do well with all forms of radiation therapy, and that’s something most other proton centers do not offer. That’s important because not every patient will need proton therapy,” says Viswanathan.

“Too much information is marketing driven and not fact driven. Claims of clinical benefit are made with no scientific evidence to back them up. There is a lot we still do not know biologically,” says **John Wong**, director of medical physics. “At Johns Hopkins, we do it right.”

Radiation treatment, in all of its forms, is essentially a form of minimally invasive surgery that replaces scalpels with precisely targeted radiation to get to cancers, Wong explains. “The main reason there is no scientific evidence to support many of the claims of benefit is that there was no way to do research. There was no laboratory counterpart for what we do in the clinic,” he says. To solve that

problem, Wong invented the Small Animal Radiation Research Platform (SARRP), a miniaturized version of the machines used to treat humans that is for animal research and potentially other laboratory models. “SARRP provides a realistic model to study in the laboratory the radiation treatment we give to patients, and this is critical to quantifying the benefits of one type of radiation therapy over another and to finding the safest and most effective way to treat patients,” he says.

Lack of research has been one of the most common criticisms of proton therapy. Although most experts agree that its ability to spare healthy cells by zeroing directly in on and stopping at the end of tumors makes proton therapy the radiation treatment of choice for pediatric and adult patients with tumors in the brain or on or near the spinal cord, definitive research studies are lacking. Wong and collaborators are currently adapting SARRP to study proton therapy. One room in the proton center is outfitted specifically for research and will be dedicated to the specific cellular, physics and animal studies needed to refine and define who is best treated with proton therapy.

“What Johns Hopkins does so well is research to improve patient care,” says **Theodore DeWeese**, Vice Dean for Clinical Affairs and former director of the Department of Radiation Oncology and Molecular Radiation Sciences. “We are one of the only proton centers that has a whole room dedicated to this kind of research.”



DEWEESE

Proton therapy expert **Curtiland Deville** says it is the reason he came to Johns Hopkins. “I wanted to be in an academic center to be at the forefront of solving issues and questions about proton therapy: What are the best indications for proton? Where can we increase benefit,

and where can we reduce toxicity? Where are we not getting such benefit and can let go? This is an area that is lacking, and our center can begin to get to the answers.” The Johns Hopkins National Proton Center will be solving these unknowns and leading future progress, says Deville.

Radiation oncologist and gastrointestinal cancer expert **Jeffrey Meyer** was drawn to Johns Hopkins for the same reason. Meyer completed a fellowship in proton therapy before coming to the Kimmel Cancer Center and says that the Johns

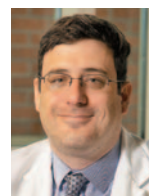

MEYER

Hopkins National Proton Center is one of the few addressing complications associated with proton therapy, such as organ movement and sensitivity to density in organs. All of these questions and concerns can be mitigated with research, he says.

“There are always going to be new technologies. Expertise and the willingness to do research to know how to use it are critical,” Meyer says. “It’s a great technology we want to take advantage of, but we have to be smart about how we use it.”

Other proton experts, including **Matthew Ladra**, a pediatric cancer specialist who directed a proton center in Tennessee, and Jen Holt, a nurse from the same center, came to Johns Hopkins and the Kimmel Cancer Center because of the combined excellence in research and patient care.

“There are many aspects we still don’t know and a lot of research opportunities. That’s something we bring to the table, with the goal to figure it all out and bridge these gaps in knowledge,” says **Marikki Laiho**, director of the Division of Molecular Radiation Sciences.



LAIHO

**COLLABORATION**

At left, **John Wong, M.D.** director of medical physics. The Johns Hopkins National Proton Center build upon a lengthy history of pioneering discoveries in radiation therapy and offers the technology to deliver the most advanced and patient-centered care.



**INNOVATION**

**Heng Li, Ph.D.**, Chief Proton Physicist, helps bring patients the most advanced radiation therapy technologies, latest techniques and innovative treatments.





**INNOVATION**

**Akila Viswanathan, M.D., M.P.H.**, Interim Director of Radiation Oncology and Molecular Radiation Sciences, says although proton therapy has been around for a long time, it is very much in its infancy in terms of exploration and potential. What truly is new is the research and multispecialty collaboration the Johns Hopkins National Proton Center brings.



“We do well with all forms of radiation therapy, and that’s something most other proton centers don’t offer. That’s important because not every patient will need proton therapy.”



## Photons and Protons

Radiation oncology is unique in that it is the only specialty that makes its own medicine. Radiation treatments delivered by machines essentially come in one of two forms: photons or protons. Although every radiation oncology expert recognizes that photon therapy and proton therapy are different, no one has studied them at the level proposed by our experts.

“We will be able to leverage our extraordinary talent in order to advance the field,” says Viswanathan.

Long-term research data made possible through Wong’s SARRP technology make it possible to begin comparative photon/proton studies almost immediately.

“This will give never-before-seen insights into the actual biologic effects of proton,” she says.

Photons are a higher-energy version of the same X-rays used for diagnostic imaging. These high-energy X-rays can be pointed at a part of the body where a cancer is located and, through a series of interactions inside of the body, break the DNA inside the cancer cell, rendering it unable to repair or copy itself. As a result, the cancer cell dies.

Proton therapy is called heavy ion therapy. It essentially kills cancer in the same way—breaking the DNA—but it uses charged particles directly rather than X-rays to kill cancer. Many experts believe that protons do a better job of breaking the DNA than photons, and this is an area Laiho is eager to explore.

“Protons damage DNA directly, and that type of damage is harder for cells to repair,” says Laiho, whose research focuses on understanding the benefit of radiation therapy with drugs that further cripple cells’ ability to repair DNA damage. “If we combine proton therapy with drugs that inhibit DNA repair pathways, the interaction will likely be greater than what we see with photons.”

One key difference between X-ray or photon radiation therapy and proton therapy is already known. It goes to the very core of why proton therapy is beneficial. It’s not that it kills cancer better; it’s that it damages normal cells less. Photons pass through the cancer and out the other side, so on this exit, they hit normal cells and tissue. Proton therapy, on the other hand, stops at the tumor. There is no exit dose. “Conventional photon radiation therapy and proton therapy cure tumors at the same rate,” explains Viswanathan. “The side effects they can cause are similar, but with proton, less dose goes to normal cells, and that’s the benefit.”

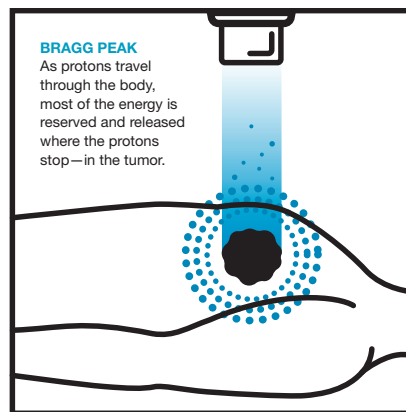

What Viswanathan describes is technically known as the Bragg peak. As protons travel through the body, most of the energy is reserved and released where the protons stop—in the tumor. Photons release energy along the entire path they travel. This fundamental difference is what makes proton therapy preferential for certain tumors. If vital organs or structures are along the path the radiation travels, protons cause less damage to them.

It can reduce excess radiation to normal cells and to vital structures and organs by about 1.5 to three times, Viswanathan says. But at two times the cost of photon radiation, clinical data to prove proton’s benefit over photon radiation is essential to moving the technology forward.

DeWeese says photons and protons both have their place in radiation therapy, and that’s why advanced knowledge of the field is so important. One area, he says, where the benefit has clearly been demonstrated is pediatric patients and

### INNOVATION

**As protons travel through the body, most of the energy is reserved and released where the protons stop—in the tumor. Photons release energy along the entire path they travel.**

tumors in the brain, spine and when the cancer is located close to vital organs, like the heart. Head and neck cancers, tumors located at the base of the skull where nerves come out, breast cancers near the heart, lung cancers in the middle of chest or near the esophagus, certain pancreas and abdominal tumors—essentially any cancer located in or around complicated anatomy that needs to be shielded from radiation—may be better suited for proton therapy. When combined with lumpectomy, proton therapy could potentially improve breast-conserving treatments. However, all of these benefits must be proven definitively through clinical trials, DeWeese says, adding that these studies may show cancers that can be treated just as effectively with less expensive therapies, but they will also reveal when proton is the preferable choice.

Prostate cancer is a cancer where many questions remain. Proton therapy has been used frequently

**WEB EXCLUSIVE**  
Listen to *On Target* with Dr. Akila Viswanathan, Interim Director of Radiation Oncology and Molecular Radiation Sciences: <http://bit.ly/2TD58vr>

**Curtiland Deville Jr., M.D.,**  
Associate Director of the  
Johns Hopkins National  
Proton Center.



“I was drawn to the Kimmel Cancer Center because of its clinical and research expertise and patient-centered approach,” says Deville. “The goal is always to leverage this wealth of experience, bring this expertise to the community, and improve the treatment of patients.”



## Urologic Cancers and Sarcoma

**Curtiland Deville** specializes in the treatment of urologic cancers, such as prostate cancer, and soft tissue sarcoma, a rare cancer of the soft tissues of the body.

The fundamental benefit of proton therapy is that it has no exit dose, Deville says, and this reduces unnecessary radiation exposure to surrounding normal, healthy tissues. Proton therapy also provides the potential to treat in challenging clinical scenarios. When soft tissue sarcomas in the arms or legs recur, the patient may be spared an amputation by undergoing a repeat course of radiation allowing for limb-sparing surgery.

Deville also published the first clinical studies on the use of proton therapy for prostate cancer after surgery. “This is an exciting area, particularly for young men who have undergone surgery for their prostate cancer and experience recurrence in the prostate bed where the prostate was located,” says Deville. When treating the prostate, the development of an injectable, absorbable “hydrogel” spacer, protects adjacent bowel and rectum during treatment.

Seminoma is a rare but highly curable form of testicular cancer that typically affects younger men. Radiation may be used after surgery to reduce the risk of or treat recurrence. Proton therapy may reduce the risk of second cancers benefiting these often young patients, says Deville.

“I was drawn to the Kimmel Cancer Center because of its clinical and research expertise and patient-centered approach,” says Deville. “The goal is always to leverage this wealth of experience, bring this expertise to the community, and improve the treatment of patients.”

He likes being based at Sibley, which brings the expertise and resources of a major academic university to a community environment. He is excited about partnering with other doctors in the community and other local institutions, such as the United Medical Center, Howard University and Children’s National. “These clinical collaborations enhance our impact on patients in the broader national capital region and beyond, providing convenient access to unique care and world class treatments, such as the most advanced radiation therapies and clinical innovations.”

to treat the cancer. National trials are ongoing, but currently, all available evidence shows that both types of radiation therapy have equal benefit.

“The fundamental issue with proton for prostate is do we have a clinically meaningful benefit that justifies its increased cost?” asks Deville. Generally, he says, photon and proton therapy provide comparable results for prostate cancer, but photon therapy is a less expensive treatment.

“I am a prostate expert,” says DeWeese. “I’m not sure it’s a substantial advantage for this cancer. But that’s OK. These kinds of studies have to be done to determine when other forms of radiation therapy will work just as well at a lower cost.”

Deville would like to study proton therapy in younger men diagnosed with prostate cancer, particularly those who have a recurrence after surgery, who do not want to have surgery. Young patients are at greatest risk of developing radiation-induced secondary cancers later in life, and proton therapy could prevent these toxicities. Other functional characteristics could also indicate prostate cancer patients who may develop fewer quality of life-impacting side effects with proton therapy. Patients who have received radiation and could benefit from additional treatment, or re-radiation, is another circumstance where the precision of proton offers an advantage in various types of cancer. There may be patients who, in the past, would have been excluded from radiation therapy that could be beneficial against their cancers because of toxicities, says Deville.

On the other hand, photon, with its more scattered energy, may be the better choice for tumors that are not so precisely located but rather dispersed throughout an area of the body or organ. These types of comparative studies will be standard practice at the Johns Hopkins National Proton Center.

The lack of comparative studies between photon and proton therapy was a primary

reason DeWeese and Viswanathan set up the proton center to have an unparalleled emphasis on research.

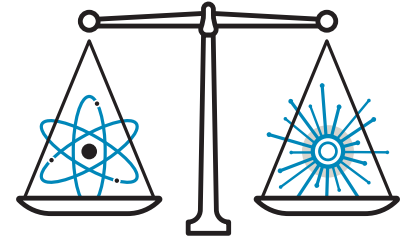

RBE helps researchers learn what doses of each type of radiation therapy are required to produce the same clinical effect.

One important area of research focus will be relative biological effectiveness, or RBE, how much more effective is proton therapy compared to photon radiation therapy. They want to know what doses of each type of radiation therapy are required to produce the same clinical effect. Just as important, they need to confirm that the prescribed dose is actually being delivered and going where they expect it to go.

Linear energy transfer, or LET, is the density at which the energy is deposited along the path to the tumor and in the tumor. Protons travel more quickly en route to the tumor, depositing little energy or lower LET. The protons slow inside the tumor, and that is where the highest density of cancer cell-killing energy is transferred or deposited, explains physicist **Todd McNutt**, who is part of the expert team that makes the complex calculations that maximize damage to cancer and minimize risk to healthy organs and tissue. The region where the energy is the highest is right at the edge of the tumor, he says. This is why expertise is so critical. “If you don’t get it right, the highest LET may hit outside the tumor, and if there is a narrow boundary between the tumor and a critical organ or structure, the patient may be harmed.”

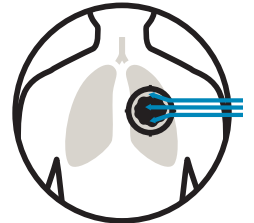

Linear energy transfer, or LET, is the density of energy deposited along the path to the tumor and in the tumor. Protons travel more quickly en route to the tumor, depositing little energy or lower LET.

# The Johns Hopkins National Proton Center

## What Sets Us Apart

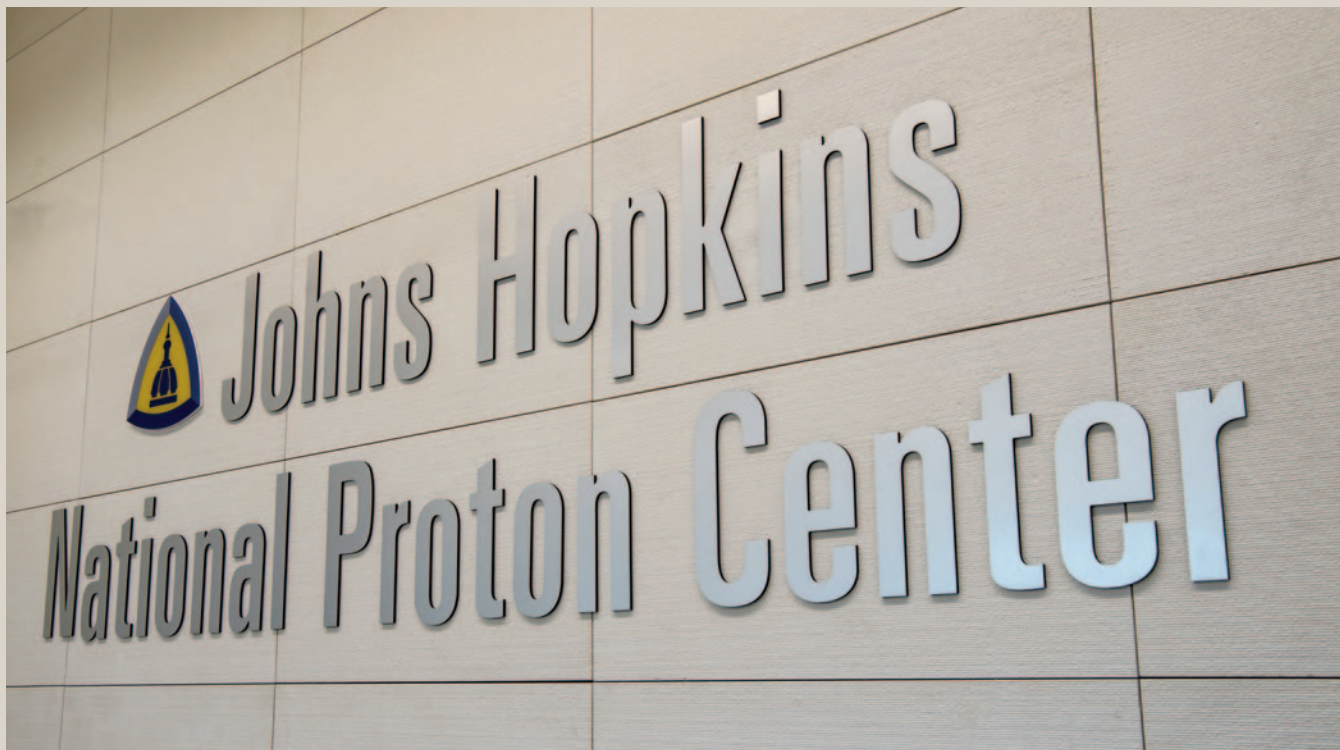

**Unparalleled Expertise:** Since opening as one of the first comprehensive cancer centers in the nation, the Johns Hopkins Kimmel Cancer Center and its experts have led cancer research, deciphering the causes of cancer and advancing care for the most complex cancer cases. This level of expertise continues with our proton therapy center, which will be directed by the leading radiation oncology and medical physics experts in the world.

**Largest and Most Advanced:** Our 80,000-square-foot facility is one of the largest and most advanced facilities in the world, with four treatment gantries and dedicated research and pediatric-specific space.

**Imaging Couch and Respiratory Gating:** It is the only proton center with CT imaging integrated with treatment to ensure the most accurate and precise treatment

planning and delivery of proton therapy. Respiratory gating technology tracks the proton beam to movement of the tumor. Our experts helped invent and develop these technologies.

**Pencil Beam and Other Advanced Technologies:** It is one of just a few incorporating the latest pencil beam delivery that virtually paints tumors with cancer cell-killing radiation while sparing surrounding normal tissue.

**Research Center:** It is the only academic proton therapy center in the region and one of just a few in the world where much-needed research studies will be performed to decipher basic biological mechanisms and help set the standard of care for proton therapy now and for the future.

**Precision Medicine:** Our experts take a unique multidisciplinary and precision

medicine approach that brings together all specialists and experts to work with patients to develop individualized, detailed treatment plans specifically suited to each patient.

**Local, National and International:** The location of our proton center at Sibley Memorial Hospital in Washington, D.C., allows us to continue to bring the most advanced cancer care to patients living in the region, while also providing care to patients across the U.S. and around the world.

**Access for All:** Collaboration among the Johns Hopkins Kimmel Cancer Center, Children's National Hospital and Howard University ensures advanced cancer care to patients of all ages, including children and young adults, and the most underserved communities in the region.



## LEADING THE WAY

## Meet National Proton Center Medical Director Christina Tsien



Johns Hopkins National Proton Center Medical Director **Christina Tsien**, a leading brain and central nervous system tumor expert, brings a wealth of expertise to her new role.

Tsien comes to Johns Hopkins from Washington University School of Medicine in St. Louis, Missouri, where she was chief of the Central Nervous System Service, director of clinical research for radiation oncology, and co-medical director of stereotactic radiosurgery and the gamma knife center.

Her mission for the Johns Hopkins National Proton Center is to ensure patients receive outstanding individualized care, provide the very best training opportunities for faculty and staff members, and maintain an active clinical and translational research program.

“We are bringing world-class cancer care and cutting-edge research to patients here and around the world,” says Tsien.

The Johns Hopkins National Proton Center is committed to providing pediatric and adult patient-centered clinical and research programs, she says. “In collaboration with Children’s National, we will have a strong focus on improving outcomes for pediatric patients and reducing short-term and long-term treatment side effects,” says Tsien. This includes using proton therapy to reduce treatment-related impact on growth and cognition, and the risk of secondary cancers later in life, she says.

“For adults, the potential impact of proton therapy can also be substantial,” Tsien says. “Radiation therapy is an integral component of cancer care, with over half of all patients diagnosed with cancer receiving radiation

therapy as part of their treatment.”

Tsien and colleagues are excited by the possibilities of using proton technology to improve radiation treatment of tumors next to critical organs. Tsien notes that the National Proton Center has state-of-the-art pencil beam technology with image guidance, which affords physicians the ability to deliver highly precise and conformal proton therapy.

“Johns Hopkins physicians are world-renowned experts in the treatment of cancer, and they are committed to clinical trials and translational research to improve the quality of life and outcomes for cancer patients, providing evidence on how proton therapy can reduce long-term radiation side effects,” says Tsien. This includes protecting the heart for breast cancer patients and reducing short- and long-term effects on normal swallowing, dry mouth, taste changes and weight loss in head and neck patients, she says.

“Treatment of brain tumors will also be a key area of cancer care progress because of the potential to preserve vision, hearing, memory, and vital brain stem, pituitary and neuro-cognitive function,” says Tsien.

Tsien adds that proton therapy is an exciting opportunity for patients who otherwise might be excluded from radiation therapy because of prior radiation treatments.

“Proton therapy is an incredibly complex and precise tool, and there is still much to be done for experts to harness its full potential,” she says. “We are working to develop advanced imaging techniques to monitor treatment changes in real time, allowing us to adapt radiation treatment plans. We are building better motion management tools, and we want to improve our understanding of radiation tumor biology to further increase the effectiveness of proton therapy in combination with systemic therapies.”

Tsien is eager to study proton therapy in combination with immunotherapy, targeted drug therapies and systemic therapy — treatments that work to zero in on specific molecular alterations that drive cancer growth and spread.

“Combining proton therapy with other cancer treatments may help prevent cancer recurrence, and this will be an active area of preclinical and clinical translational research in the Johns Hopkins National Proton Center,” Tsien says. “Our purpose is to figure out how to improve cancer survival, and often the best way to do that is to use different cancer therapies in combination to deliver high radiation doses to the tumor while minimiz-

ing dose to the surrounding normal tissues.”

Among the strategies Tsien wants to research is the use of ultrafast flash radiation therapy with proton therapy to maintain high doses of radiation to tumors while reducing the dose to normal tissues. “This would ultimately enable us to substantially shorten the length of treatment from several weeks to several days,” she says.

Radiation oncologists now have many different cancer-fighting tools at their disposal, and Tsien stresses the importance of selecting the right treatment plan for each patient. “Proton therapy will not be suitable for everyone, and we are committed to ensuring patients receive the best and most suitable treatment,” says Tsien.

“One of the most rewarding things for me is the opportunity to work as a treatment team, to give every patient a second look to make sure nothing has been missed and that we’ve explored every possible avenue and every treatment option,” she says. “We need to identify patients who will benefit the most from proton therapy and learn more about its impact on tumors and normal tissues. We also need to go into the laboratory to reveal the cellular mechanisms that can answer questions like why a specific treatment may work in one patient but not in another.”

Tsien says Johns Hopkins National Proton Center experts will work closely with colleagues throughout the Johns Hopkins system as well as with colleagues at other organizations such as the National Institutes of Health. “We are aiming to provide the very best patient care and to be on the forefront of innovative proton research,” she says.

As Tsien looks ahead, she also thinks back to her own diagnosis as a young medical student with a rare type of sarcoma. It led her to pursue a career in radiation oncology. Proton therapy was not available at that time, and her experience reminds her of the continuing need to advance cancer therapies. She understands cancer on a professional and personal level and chose to come to the Johns Hopkins National Proton Center, she says, because of the opportunities uniquely set up to pursue novel clinical and laboratory studies using state-of-the-art proton therapy with the aim of transforming patient care.

“I am excited to be here,” says Tsien, “and what I’m most excited about is helping patients everywhere get the best care, and that means we are always looking to the future and always moving forward. Our goal is to eliminate cancer.”

CONTINUED FROM PAGE 9.

Deville is among Kimmel Cancer Center experts who are eager to collaborate with McNutt and use his Oncospace data mining system to track and compare toxicities with photon and proton therapy to develop a precision medicine approach. He says it could help identify prostate cancer patients who would benefit from proton therapy.

“This is the right direction for an academic proton center like ours. High-level evidence has been lacking. Kimmel Cancer Center experts can bring their expertise into the research realm, and 10 years from now, we’ll have these answers to set the standards of care,” says Deville.

## Better from the Start

Even before the research begins, DeWeese and Viswanathan are confident that the Johns Hopkins National Proton Center is poised to deliver unprecedented care. Our 80,000-square-foot proton center is one of the largest in the country and has four gantries—the large, sphere-shaped structures that house the equipment used to deliver proton therapy to patients. The gantry rotates around the patient, delivering the proton beam at any angle necessary to target the cancer. Unique features, including the pencil beam, a tumor tracking system that allows the beam to adjust to tumor movement, in-room imaging via a CT Couch and the Oncospace data mining system, are all unique to the Kimmel

Cancer Center and make the proton therapy we provide the safest and most advanced available.

How we deliver radiation therapy at the Kimmel Cancer Center is already a step above most other places, DeWeese says. Advanced expertise has kept radiation delivery very focused, conforming to the tumors, and allowed our doctors and scientists to make every type of radiation therapy technology work the best for patients while minimizing harm.

To that point, DeWeese recalls a patient he treated as a resident who poignantly illustrates the tradition for patient-centered care and ingenuity that remain the heartbeat of the department.



CARE

## Head and Neck Cancers

**Ana Kiess** often treats cancers that occur amid confined spaces in the proximity of the brain, eyes and other vital anatomy. She plans to explore proton therapy for the treatment of salivary gland and skull-based tumors to spare the brain stem, brain and optic structures from radiation. The precision of proton therapy and the ability to stop the beam at the tumor will provide new opportunities to cure patients with advanced cancers, she says. In sinus and nasal cancers, calculating radiation dose is difficult because of the potential density changes.

“The patient may have clear sinuses as treatment begins that become filled with mucus before the end of treatment,” she says.

As a result, these patients require complex treatment planning, replanning and dose calculations to account for these dynamic changes. She will be collaborating with Oncospace (see page 25.) inventor **Todd McNutt** and others to use data to help create sophisticated advanced planning for these patients. Kiess is excited about proton therapy clinical trials for patients with these less common cancers.

“Through clinical trials, we learn from each patient, improving the understanding of toxicities and ways to improve treatment,” she says.



In 1990, he was working with a former faculty member, the late **Moody Wharam**, to treat a young patient with the rare occurrence of an eye cancer called retinoblastoma in both eyes. Without extraordinary measures, the young boy was destined to lose vision in both eyes, DeWeese says. The only way to preserve the function of one eye was to deliver radiation so precisely that it would destroy the cancer without harming the anatomy of his eye.

#### COLLABORATION

**Advanced expertise has kept radiation delivery very focused, conforming to the tumors, and allowed our doctors and scientists to make every type of radiation therapy technology work the best for patients while minimizing harm.**

The treatment was so complex, including the construction of a special device for the patient's eye, that DeWeese recalls coming in every morning for weeks at 6 a.m. to set up for the patient's treatment. Technologies to perform this type of precise radiation treatment, like proton therapy and stereotactic ablative radio-surgery, had not yet been developed, so DeWeese and Wharam fashioned their own way to get radiation to the cancer and protect the eye. It worked, and in 2017, the patient graduated from college with an engineering degree. He sent Wharam and DeWeese a family photo taken at his graduation. DeWeese wonders how different that family photo might have been if they had not gone to such lengths to save the patient's vision in one eye.

"I can't think of too many places at the time that had the team to innovate this type of care to save this child's eye," says DeWeese, adding that this remains the type of care that every patient who comes to the Kimmel Cancer Center receives.

This dedication to patients and the ability to successfully plan and deliver such a complex treatment exemplifies the difference between radiation therapy at Johns Hopkins, including proton therapy, and radiation therapy most everywhere else.

It is these "extra lengths" that make our proton center unique from the start.

Our proton center also has the most up-to-date pencil beam technology, which only recently became available. The pencil beam paints tumors with cancer cell-killing energy layer by layer, staying within the boundaries of cancer. The technology is so advanced that it is able to modulate intensity, delivering varying degrees of energy based on the specific makeup of the tumor. Instead of the same energy being deposited throughout the tumor, our pencil beam adjusts to differences throughout a tumor to provide the right amount of energy to every different area of the tumor.

Collaboration among Kimmel Cancer Center molecular radiation scientists and the manufacturer of our proton therapy system means our National Proton Center will usher more advanced tumor monitoring that makes the already safe and targeted pencil beam patient-specific and even more tumor-specific. One method uses molecular monitoring to evaluate the tumor and adapt radiation treatment to each individual patient. Molecular imaging allows doctors to differentiate cancer cells from scar tissue or other ambiguous lesions and better define the anatomy of the tumor and its response to radiation treatment.

"When protons interact with human tissue, they produce things like oxygen in a different molecular state. We can use a

type of imaging called a PET scan to see that and know exactly where radiation was applied that minute. Based on what we see, we may deliver the dose on that day in one way, and the next day, use a slightly different dose or angle of treatment or energy," says DeWeese.

Wong worked with proton therapy developer Hitachi to integrate another invention, called respiratory gating, that tracks motion in the lung and stops the pencil beam if the beam and tumor lose alignment due to motion caused when patients breathe.

"The machine only fires when the beam is in the right place," says Wong. "If the tumor moves, the machine automatically stops. The beam works when it is lined up and stops when it is not lined up. We're the first to have it."

Wong says the studies needed for FDA approval of the gating technology will be done at our National Proton Center.

Another technology being studied by Wong and physicist **Kai Ding** further



DING

buffers vital organs from the energy of the proton beam. Some tumors sit right next to critical structures, and providing a buffer between the organ and

the tumor could make it safe to deliver higher doses of radiation to the tumor, Wong says.

Ding received funding from the National Cancer Institute to study image-guided injection of a spacer gel to push tumors away from radiation-sensitive organs. For example, in pancreas cancer, the spacer gel could be used to push the tumor away from a section of the small intestine called the duodenum. Protecting nearby organs would permit higher doses of radiation to the tumor. Studies of the spacer gel have already begun in photon radiation therapy and will begin in proton when the center opens.

# The Path to Proton

## Milestones in Radiation Oncology

Excellence in proton therapy emanates from excellence in all areas of radiation oncology. Our National Proton Center is built upon a strong history of breakthrough discoveries and scientific ingenuity.

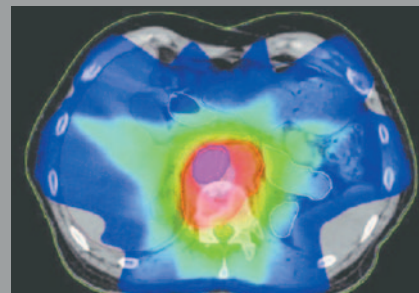
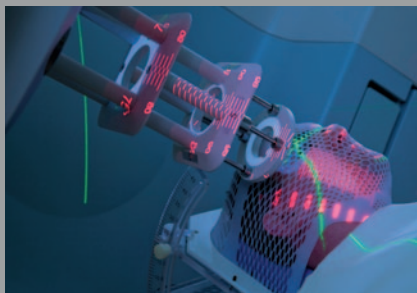

**1973:** Johns Hopkins is among the first to be designated a Comprehensive Cancer Center by the National Cancer Institute. Medical oncologists, radiation oncologists, surgeons, oncology nurses, researchers and other specialists work together to advance cancer treatment and research.

Radiation oncology broke off from the Department of Radiology and Radiological Sciences and joined forces with the Department of Oncology to make progress against a growing cancer epidemic.

**1976:** A specialty cancer program for pediatric patients is established. The National Cancer Institute appoints Kimmel Cancer Center radiation oncologist to two national study groups investigating childhood cancer.

**1977:** Johns Hopkins' program was viewed as one of the few strong academic programs in radiation oncology in the U.S. This expertise attracted so many patients, the radiation oncology clinic had to expand to twice its original size to accommodate the growing patient load.

**1980:** A Kimmel Cancer Center radiation oncologist is named director of the radiation oncology committee of the Pediatric Oncology Group, a position he held for 10 years. He was among the first to study toxicities and late effects of radiation therapy on pediatric patients.

**1986:** Our radiation oncology experts become the first in the region to perform stereotactic brain surgery, a computer-generated surgery performed without knives, in order to destroy deep-seated tumors and blood vessel malformations in the brain.

**1989:** A new treatment delivers radioactive "seeds" into the airways, extending life for inoperable lung cancer patients. The same type of therapy, now known as brachytherapy, is used to treat prostate and gynecologic cancers.

**1993:** Investigators discover that chemotherapy and radiation therapy administered prior to surgery improve success rates in some cancer patients.

**1994:** The Kimmel Cancer Center becomes one of the first in the nation to use a 3D radiation simulation for more precisely planned radiation therapy.

**2001:** A combined chemotherapy/radiation regimen preserves the voice box for many laryngeal cancer patients with success rates equal to surgical removal of the voice box and significant improvement in quality of life.

**2003:** The Department of Radiation Oncology and Molecular Radiation Sciences is established.

**2004:** The Intensity Modulated Radiation Therapy Program began to deliver high-precision radiation that conforms to the three-dimensional shapes of tumors and delivers higher and well-defined doses of radiation to tumors, and even specific areas within tumors, while minimizing radiation to surrounding normal tissue.

**2005:** Miniature versions of the equipment used to treat patients are created to perform never-before-done animal research models. These models allow researchers to study the best ways to target radiation-based treatments to tumors and, at the same time, prevent damage to normal cells.

**2006:** Research reveals that lower doses of radiation may kill more cancer cells by eluding a protein called ATM, a damage detection mechanism for cancer cells.

*Science Watch* newsletter dubs the Kimmel Cancer Center a "cancer research powerhouse," as its research is the most often cited in all of cancer research worldwide.

**2007:** The stereotactic body radiation therapy program starts. This knifeless surgery uses highly focused beams of radiation to ablate tumors.

**2008:** Molecular Radiation Sciences research accelerated to decipher the biology of DNA damage response to radiation therapy and how cells sense and repair this damage.

Research showed that men whose tumors recurred after prostate cancer surgery are three times more likely to survive their disease long term if they underwent radiation therapy within two years of the recurrence.





**2009:** A computer-assisted version of brachytherapy, a prostate cancer therapy that uses radioactive seeds inserted in the prostate to kill cancer cells, is developed. The innovation allows for more precise placement of seeds. An even more precise version followed, using an MRI-assisted robotic needle to accurately insert the seeds.

**2010:** A technique to keep normal and cancerous tissue surgically removed from the prostate alive and functioning for up to a week is developed to allow investigators to test anticancer therapies on live tissue.

**2010:** Sibley Memorial Hospital in Washington, D.C., becomes part of the Johns Hopkins Health System.

**2011:** Our experts led the first-ever, in-depth, scientifically based safety analysis of radiation oncology and reported that a combination of approximately six common quality assurance measures could have prevented more than 90 percent of the potential incidents.

**2012:** A new, never-described compound known as BMH-21 destroyed critical communication between cancer cells and the POLI pathway, necessary for cancer cell survival.



**2013:** The Johns Hopkins application to build the largest and one of the most advanced proton therapy centers in the country is approved.

**2014:** An interdisciplinary research collaboration reveals that testosterone, a hormone prostate cancer cells need to survive, can also form breaks in the DNA that would make cancer cells more vulnerable to treatment with radiation therapy.

**2015:** A unique collaboration between our Department of Radiation Oncology at Sibley and Children's National pediatric cancer center results in the first dedicated pediatric radiation oncology program in the national capital region. It brings together pediatric medical and surgical oncology experts from Children's National and pediatric radiation oncology experts from the Kimmel Cancer Center to provide comprehensive pediatric cancer care, including clinical trials, to patients in the region.

Stereotactic radiotherapy is shown to augment immune response in pancreatic cancer patients.

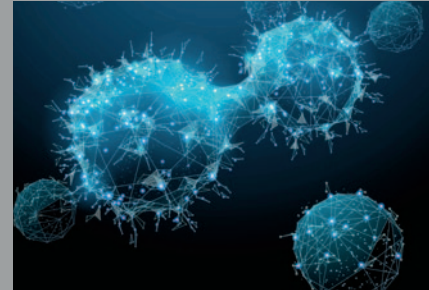

**2015:** The Kimmel Cancer Center at Sibley partners with United Medical Center and Howard University to bring cancer care to the most underserved Washington, D.C., neighborhoods.

**2016:** The Kimmel Cancer Center at Sibley Memorial Hospital opens adding medical oncology and surgical oncology to the already established and growing radiation oncology program. The 36,000-square-foot facility brings patients the most advanced radiation therapy technologies, latest techniques and innovative treatments—the same techniques and technologies used throughout the Johns Hopkins Kimmel Cancer Center.

**2017:** A pioneering new therapy uses CT- and MRI-guided brachytherapy to treat cervical cancer and other gynecologic cancers.

**2018:** *U.S. News & World Report* continues to rank the Kimmel Cancer Center as one of the top cancer hospitals in the nation and the top-ranked center in the mid-Atlantic region. Our pediatric oncology program is also ranked among the top five in the nation.

**2019:** The Johns Hopkins National Proton Center opens, bringing the most advanced proton technology, expertise and research to the region.

#### On the Web

*What is Proton Therapy?*  
Watch our informative introduction to proton therapy – the precision radiation therapy:  
<http://bit.ly/2TD58vr>



COLLABORATION

## A New Approach for Advanced Cancers

Patients like **David** with advanced cancers are benefiting from a new, first-of-its-kind Cancer Invasion and Metastasis Program, co-directed by radiation oncologist **Phuoc Tran**. The new research tackles cancer spread head on—the cause of more than 90% of cancer deaths.

Tran believes cutting off the metastatic or spreading cancer cells from the primary tumor makes it more difficult for a cancer to survive. Tran and colleagues are shifting the treatment paradigm for advanced cancers, using treatments, like surgery, from which patients with advanced cancers have historically been excluded, and combining chemotherapy, targeted drug therapies, surgery and radiation therapy, including proton therapy, to transform the management of advanced cancers.



CONTINUED FROM PAGE 13.

## The Inventor

Affable and brilliant, Wong's energy and



WONG

his excitement for the field are infectious. He moves between meetings with young up-and-coming physicists in his office to the stairwell as he scurries to the treatment areas to see his

inventions in practice and interacts with clinicians who can describe existing shortfalls. Along the path, he stops to talk to faculty members, nurses, technicians, residents and fellows. He is always thinking about how he can make radiation therapy better. More impressively, he has turned these ideas into revolutionary advances in the field of radiation oncology and molecular radiation sciences.

---

### John Wong's Inventions

**1997:** Active Breathing Coordinator, an interactive and noninvasive device, coordinates breathing with radiation treatment, locking a breath in place for a short, comfortable period to prevent movement-related radiation damage to vital organs, such as the heart or lungs.

**2000:** Co-inventor of cone beam computed tomography, which uses a cone of divergent X-rays and captures CT images to deliver clear images of bone, soft tissue and tumor to guide radiation delivery.

**2001:** The Small Animal Radiation Research Platform (SARRP) is a miniaturized version of the human machine and made it possible, for the first time, to study human therapies in animal models.

**2013:** The Raven quality assurance device connects to machines and quickly performs a series of measurements to ensure machines are functioning correctly.

**2018:** CT Couch integrates image guidance with treatment delivery.

---

"It's great to be paid to sit and think," he jokes.

He rarely believes a new technology is adequate "out of the box," and proton therapy was no exception. His inventions make existing technologies better, safer and more precise. He epitomizes the intangible component so essential to pro-

ton therapy, or any radiation therapy, for that matter. It is the expertise, experience and in-depth knowledge that allow him to optimize a new technology to work better for the radiation oncologists, physicists, nurses and technicians who use it and—his main goal—to advance the care of patients.

Most places acquire proton therapy by contracting someone else to build it for them. Wong and his Kimmel Cancer Center colleagues took a different approach, partnering with manufacturer Hitachi to design and build a one-of-a-kind proton therapy system that exceeds every other proton center in its scope, size and capability.

"We have always been innovators in the Kimmel Cancer Center. There are few places like us, but this is how leading institutions like Johns Hopkins should be driving the development of technology. When we see a clinical problem, we solve it ourselves," says Wong. "I look for logical ways to make equipment work better, which allows researchers to dig deeper and move faster so they can get improved treatments to patients."

Most of Wong's inventions over more than three decades are centered on imaging that makes sure the potent radiation beam hits its intended cancer target.

The protection of normal tissue and organs is at the center of most everything our experts do in treating patients with radiation therapy. There is no question that radiation kills cancer cells. Researchers have understood that since 1896. At issue is how it can be used to kill cancer without harming normal cells to prevent toxic side effects at the time of treatment, particularly for pediatric and young adult patients, down the road, when excess doses of radiation can result in long-term side effects or cause second cancers to develop.

The ability to direct the beam to a tumor, and only the tumor, is the advantage of

proton therapy over the more scattered photon beam. However, the beam—no matter how precise—is only as good as its guidance system. Simply put, it will hit what it's directed to hit, which is why for most of his career, Wong has focused on the development of better imaging technologies that show where the beam is going.

### INNOVATION

**"Conventional photon radiation therapy and proton therapy cure tumors at the same rate. The side effects they can cause are similar, but with proton, less dose goes to normal cells. That's the benefit."**

The National Proton Center has magnetic resonance, or MR, and CT imaging, as well as a new type of CT scan called dual energy CT that provides detailed information on the specific makeup of a tumor. This advanced and unmatched imaging makes our proton therapy the most precise of any available today.

His latest invention, the CT Couch, brings new technology to photon and proton therapy by putting the image guidance directly on the therapy machines. Typically in radiation therapy, patients must move between a simulator and the treatment room. The simulator is a dress rehearsal of sorts that uses CT imaging so that the physicists and the treatment team can visualize where tumors are located in relation to the rest of the body, particularly vital organs. Complex calculations are made based on these imaging data, and the treatment plan is set in place. Until now, treatment planning and treatment delivery could not be done in the same room and usually not on the same day.

CONTINUED ON PAGE 24.



Lawrence Kleinberg, M.D., (right) and patient Jeanie.



## CARE

# Beating Brain Tumors



Jeanie (right) and partner Jenny

When Jeanie, a housepainter, began having trouble pouring paints without spilling them, the active 65-year-old chalked the coordination problem up to age. Still, she couldn't understand why she had no problem riding the waves on her boogie board but struggled to paint in a straight line or back her car out of a driveway. Worried Jeanie may have had a stroke, her sister encouraged her to see a doctor, and the news was shocking. The cause of her symptoms was three tumors in her brain that had spread there from an advanced endometrial cancer Jeanie never knew she had.

Jeanie knew her diagnosis was unusual and dire, so the Kent Narrows, Maryland, resident opted to go to the Johns Hopkins

Kimmel Cancer Center. There, she underwent a hysterectomy to treat the endometrial cancer. Radiation oncologist and brain tumor expert **Lawrence Kleinberg** and neurosurgeon **Chetan Bettegowda** treated the spreading cancer in her brain. When friends asked Jeanie if she planned to get a second opinion, she responded, "After you've gotten your first opinion at Johns Hopkins, you don't need a second opinion," noting that she had a team of more than a dozen experts collaborating on her care.

Kleinberg offered optimism when most saw her advancing cancer as hopeless. "My friends thought I was a goner, but Dr. Kleinberg always believed I had a chance, and that meant so much to me," says Jeanie.

Despite what seemed a bleak diagnosis, four years later Jeanie's cancer is now undetectable. "I'm a bit of a miracle," says Jeanie, who just celebrated her 69th birthday. After the combination of chemotherapy, radiation therapy and surgery used to treat the advanced cancer, she went through physical therapy for balance and coordination issues caused by the brain tumors but says, "My treatment at Johns Hopkins was a breeze."

Today, Jeanie is back to work and playing drums with her band the Surf Jaguars.



## Brain Tumors

Radiation oncologist **Lawrence Kleinberg** understands the gravity of the cancer he specializes in treating. The brain tumor expert knows there is not only vital functional consequences of treatment, including loss of vision or use of arms or legs, but there is also a certain sanctity when it comes to the brain. It is what makes us truly human, the keeper of our personality, thoughts and memories. The world's greatest supercomputer makes the connections for essentially every bodily process and function. When cancer and benign tumors infiltrate the brain, the consequences of treatment can often be as dire as the diagnosis.

"The type of damage that can be caused by radiation therapy depends on where in brain the tumor is located," says Kleinberg. "It could affect almost any function—strength of an arm or leg, memory function, or even vision. Almost anything the brain controls could be affected."

As a result, Kleinberg is excited about the opportunities to explore the great promise of proton therapy for protecting the brain from these side effects.

The patients most likely to benefit, he says, are those with brain tumors classified as low grade because they are slow growing, limited to a specific area of the brain, highly treatable and often curable. These characteristics make them good candidates for treatment with radiation, including proton therapy. These characteristics also distinguish low-grade tumors from their highly malignant and aggressive counterpart that reach throughout the brain. Whether the precision of the proton beam will benefit patients with these types of brain tumors is more uncertain and will require extensive research studies.

"The problem with highly malignant tumors is that what we are treating on purpose is mixed in with the normal brain," says Kleinberg.

Low-grade tumors, such as meningioma (a benign tumor that forms on membranes that cover the brain and spinal cord just inside the skull) and pilocytic astrocytoma (a slow-growing type of glioma brain tumor that originates from star-shaped cells called astrocytes) are more confined to a specific area of the brain.

"Proton therapy will probably not be any better at controlling the tumor, but it may do better job of protecting normal brain

cells surrounding the tumor from injury," Kleinberg explains.

Comparing proton treatment to photon therapies will be one area of research in the Johns Hopkins National Proton Center.

The studies will be very different for the adult patients Kleinberg treats than pediatric patients. "We know for certain that there are toxicities for pediatric patients whose brains are still developing, but we don't know yet the extent of these toxicities in adult patients whose brains are already formed. We will only learn this by doing research studies that compare proton therapy to other types of radiation treatment," says Kleinberg.

As protons travel through the body, most of the energy is reserved and released where the protons stop in the tumor. Photons, on the other hand, release energy along the entire path they travel. This fundamental difference is what makes proton therapy preferential for certain tumors in the spinal cord and the brain. If vital organs or structures are along the path the radiation travels, protons cause less damage to them. And there is no exit dose.

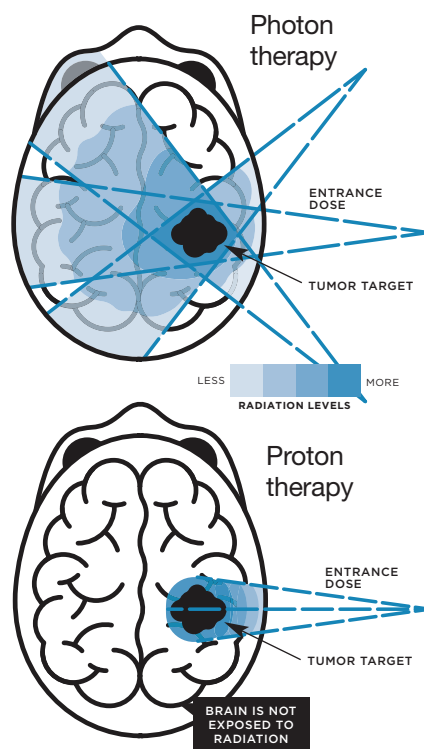

For example, Kleinberg says, stereotactic ablative radiation or robotic radiation treatment with the Cyberknife, also protect normal tissue. Research will show the situations where proton therapy will provide greater protection.

"We have expertise in all of these options, and this is important because proton may be better in some situations, and in other instances, we may want to give big bursts of radiation over a shorter period of time, and in that case, other types of treatment may protect the brain better. It's very individualized," says Kleinberg.

Like proton therapy, some of our other radiation treatment devices also have tumor tracking to make sure the radiation beam stays fixed to the tumor, even if the patient moves. This is even more vital for brain tumors, Kleinberg explains, where toxicities to normal brain can have life-altering consequences. Comparing the tumor tracking in proton versus other types of radiation treatment, such as Cyberknife, is another focus of research in the proton therapy center.

The ability of the proton beam to stop at the tumor makes it the preferable option for patients with tumors that sit on or close to the spine or near other critical structures that need to be shielded from radiation, such as the optic nerve. Kleinberg says proton therapy may also be the best option to preserve fertility in women of childbearing age who have tumors near the pituitary gland. Whether proton therapy is the best option will be an individualized decision, depending upon the shape and type of tumor.

Its toxicity-limiting precision also provides flexibility to increase doses. With other types of radiation treatment, doctors may decrease the radiation dose to the tumor to protect a vital structure nearby. "Proton therapy in some situations will allow us to give a better therapeutic dose without worrying about damage to nearby structures, and that could improve outcome for some patients," he says.

Kleinberg would also like to study proton therapy's ability to instigate the body's own natural defenses—the immune system—to attack brain tumors.

Having another tool to consider in treating his patients is a good thing, but he says patients come to the Kimmel Cancer Center because of its reputation for excellence.

"Our patients aren't just looking for the next new technology. They are much more engaged with our expertise and knowledge, as are the physicians who refer them to us. That is key," says Kleinberg. "Patients often come a long way and pass a lot of centers to get to us. They do this because we have earned that trust."

# Curing Cancers Once Thought Incurable

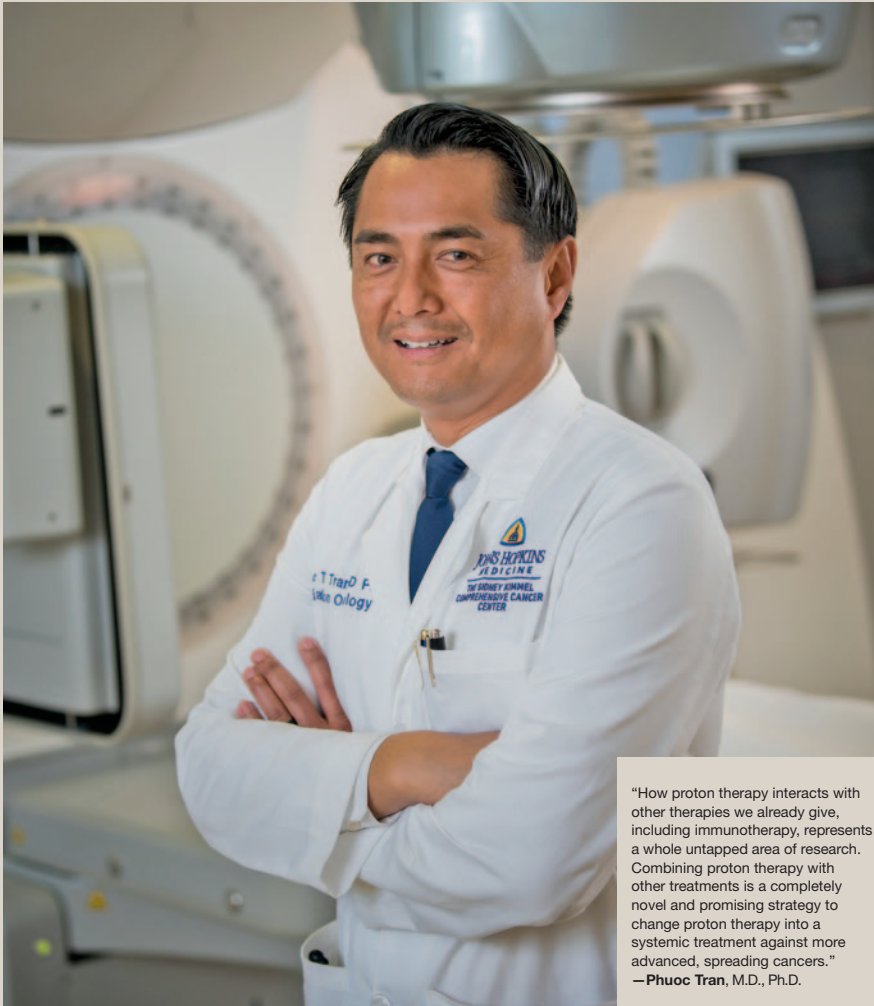

"How proton therapy interacts with other therapies we already give, including immunotherapy, represents a whole untapped area of research. Combining proton therapy with other treatments is a completely novel and promising strategy to change proton therapy into a systemic treatment against more advanced, spreading cancers."  
—Phuoc Tran, M.D., Ph.D.

Brian's days were busy as he and his wife enjoyed their active 2-year-old son. Despite a family history of prostate cancer, when the 47-year-old began feeling "a little off," he didn't initially think much of it. As his symptoms worsened, however, Brian decided to make an appointment with a urologist.

The urologist performed a prostate exam and a prostate-specific antigen (PSA), a blood test that screens for prostate cancer. The results of both tests pointed to cancer. The exam revealed an enlarged prostate, and his PSA test results were high. A friend recommended he go to Johns Hopkins to have it checked out.

"He said Johns Hopkins was excellent. He sort of joked with me at first saying, 'I won't be offended if you don't go, but I highly recommend it. Scratch that, he said, I will be offended if you don't go,'" recalls Brian. He took the advice, and to this day, he remains grateful to his friend for the recommendation.

His appointment with the Prostate Cancer Multidisciplinary Clinic involved all of the specialists involved in treating prostate cancer, including radiation oncologist **Phuoc Tran**.

By the time Brian's cancer was diagnosed in 2016, it had already spread, a distinction

known as a metastatic cancer that often limits the kind of treatments a patient is eligible to receive. It also often represents a dividing line between a curable cancer and one that is not curable. However, Tran is beginning to shift that paradigm through a new Cancer Metastasis and Invasion Program he leads with Kimmel Cancer Center colleagues, cell biologist **Andrew Ewald** and Bloomberg Distinguished Professor **Ashani Weeraratna**.

Their research shows that just as there are varying stages and grades of cancer, there are also varying degrees of metastasis. A cancer that has just begun to spread from the primary tumor to a few sites is very different from a cancer that has spread to many distant sites throughout the body, yet treatment is often similar, Tran explains. Popular opinion was that once a cancer had spread, there was no going back. Attempts to cure the cancer were obviated for palliative treatments that knocked the cancer back a bit and ameliorated pain and other side effects associated with the spread of the cancer.

Tran and colleagues, including prostate cancer researcher **Kenneth Pienta**, however, were starting to see evidence that there was connectivity between primary tumors and cancer cells that broke away and formed new tumors elsewhere in the body. They believed that selectively treating these tumors with radiation and other treatments had the potential to make cancers once thought incurable, curable.

This was the approach taken with Brian.

Tran uses the analogy of the first American colonists. Although, they set up communities in distant locations, they often relied upon and received support, guidance and instruction from Great Britain, says Tran. Similarly, he believes—and research is beginning to bear this out—that spreading cancers remain molecularly connected to the primary tumor site, where the cancer originated.

"Most experts forget about the primary prostate tumor once a cancer has spread," says Tran. "We've learned from data generated by the Johns Hopkins Rapid

Autopsy Program that some metastatic cells go back to the prostate and travel all over, communicating with other cancer cells and colonizing. Information is exchanged, and it strengthens the cancer as a whole,” he says.

This connectivity and how the primary tumor communicates with colonizing metastatic tumors are not yet fully understood. Although cancer metastasis is the leading cause of cancer death—accounting for 90%—little research is aimed at figuring out how to thwart it. Deciphering how cancer spreads and how to interfere with the process is the mission of the Cancer Invasion and Metastasis Program.

Cancer cells are the ultimate survivalists, exploiting all the tools of normal cellular and molecular biology to their advantage. There are some data that show that primary tumors send out signals to lay the groundwork for the future spread of the cancer. Later, cells go to predetermined locations and form new tumors. Other tumors remain dormant, sometimes for decades, and then begin growing again.

“Communication is cut off, and the cancer is barely surviving, but then communication is restored,” Tran hypothesizes. “The cancer may just be sitting there, not actively dividing, but then some event allows it to take off again. That’s what we need to stop.”

Tran believes cutting off the metastatic or spreading cancer cells from the primary tumor makes it more difficult for a cancer to survive. Some prostate clinical trials are beginning to prove his hypothesis to be true, showing that treating the primary tumor extends life. Still, many times the cancer often comes back, he says.

Tran’s vision is to take the battle to the next step, treating both the primary tumor and metastatic sites.

This is the plan Tran, Pienta and surgeon **Mohamad Allaf** developed for Brian, combining chemotherapy, a testosterone-blocking drug, surgery and radiation to get at the primary tumor and the spreading cancer cells.

Typically, surgery is not an option for prostate cancer that has already spread. Instead, doctors usually opt to cut off the testosterone feeding the cancer, a treatment that can quiet the cancer down but also have unfavorable side effects for patients, and it does not cure the cancer.

**Tran believes cutting off the metastatic or spreading cancer cells from the primary tumor makes it more difficult for a cancer to survive. Some prostate clinical trials are beginning to prove his hypothesis to be true, showing that treating the primary tumor extends life.**

Tran says as they shift the treatment paradigm for metastatic cancers, they need safe and precise ways to get at spreading tumors, and he believes proton therapy could be the way. Treatments such as immunotherapies that engage and improve the ability of the immune system to attack cancer are having success against metastatic cancers and may be part of combined treatments. “We think that protons are less immunosuppressive, so we want to study how they interact with immunotherapy,” says Tran.

He and **Marikki Laiho**, director of molecular radiation sciences, have already begun preparing for these kinds of proton therapy laboratory studies.

“We don’t really know a lot about protons. This is our mandate. How proton therapy interacts with other therapies we already give, including immunotherapy, represents a whole untapped area of research,” says Tran. “Combining proton therapy with other treatments is a completely novel and promising strategy to change proton therapy into a systemic

treatment against more advanced, spreading cancers.”

It is called the abscopal effect, Tran explains. The thought behind it is that treating the primary tumor and some metastatic lesions can cause even untreated tumors to shrink. It goes back to Tran’s concept that the primary and spreading cancer cells are interconnected, and damaging one link in this chain is enough to weaken the entire cancer.

“The sum is greater than the individual parts,” says Tran. “Cut off the metastatic sites from the primary tumor, and it becomes more difficult for the cancer to survive.”

The treatment appears to be working for Brian, who four years later remains cancer-free, with no signs of recurrence and a PSA of zero. He does his part to keep the cancer in check, keeping active, eating well and keeping a positive outlook.

“One of the smartest things I did was come to the Johns Hopkins Kimmel Cancer Center,” says Brian, who got a second opinion at Tran’s encouragement. Troisi went to another major comprehensive cancer center and was advised to stick with Tran’s plan. The doctor he saw noted that no other place was offering these kinds of treatments for advanced prostate cancer.

“The most important advice I give to other people is to make sure to talk to the best,” says Brian. “Find the people who care about the issue you have and are on the cutting edge. I met people around the world when I was receiving radiation therapy at the Kimmel Cancer Center. They told me that everyone around the world knows Johns Hopkins.”

Tran says many patients he sees for the first time come believing there is nothing that can be done for them. In their most difficult moment, Tran’s innovative new treatment approach gives hope.

“My life is great,” says Brian. “I have two kids now, and my wife and I are enjoying every moment.”



## INNOVATION

# Better Treatment for Head and Neck Cancers

In 2018, a cancerous tumor David had removed from his neck a decade earlier returned.

David's cancer was classified as HPV-positive, meaning it was caused by the human papillomavirus. Kimmel Cancer Center researchers identified the virus as the driver of certain head and neck cancers in 2007. Their findings marked a distinct subtype of head and neck cancer and one that portended better responses to treatment and very high cure rates.



Patient David

As an engineer, David looked at things pragmatically and analytically, and he did his research. He consulted with his doctors in Hong Kong, where he'd lived since 1995 and had his first surgery. They told him HPV-positive head and neck cancer was uncommon in Hong Kong. At their suggestion, he began considering treatment back in the U.S., where he often traveled for business. He contacted experts at the National Cancer Institute (NCI) and at several NCI-designated comprehensive cancer centers.

He began receiving a standard regimen of chemotherapy in Hong Kong as he explored radiation therapy options, including proton therapy. David's oncologist told him he had accepted a position at Johns Hopkins and introduced David to Kimmel Cancer Center radiation oncologist and head and neck cancer expert **Harry Quon**.

David's cancer was at the base of his tongue and a saliva-producing gland called the parotid.

"Every person I talked to prepared me for pain and suffering," says David. "Dr. Quon was different, and that sold me."

While most cancer experts David consulted considered severe side effects a given, Quon took a different view. "We don't want you to be in pain. We want you to eat," Quon told David. His goal was to minimize or eliminate side effects, and David said that made the Kimmel Cancer Center's approach unique.

At the heart of what sets Quon's approach from others is a desire to do better for patients, and this resulted in a program called Oncospace he developed with physicist **Todd McNutt**. Head and neck cancers are considered among the most difficult to treat because they are in close proximity to so many other organs and glands. Damage to the voice box, tongue, throat and salivary glands can make it painful for patients to eat and cause other quality-of-life-altering and even life-threatening consequences.

McNutt and Quon developed a complex, computerized data mining system that scrutinizes and analyzes data from prior patients who received radiation treatment to improve the treatment of new patients. It evaluates the therapies that worked best for a particular cancer and learns from those that resulted in less-than-favorable outcomes to generate an optimal treatment plan. Quon used Oncospace to develop a plan that protected David's parotid gland from permanent damage.

David says he is grateful to Quon and nurse **Marsha Freudigman** for focusing on the person and not the cancer. David continued to work and remained active throughout his treatment, exercising and using yoga, reiki and acupuncture to support healing. "After six weeks of radiation therapy, I was eating just like anyone else," says David. Even better, David's last scans show no signs of cancer.





Harry Quon, M.D.

**Oncospace** scrutinizes and analyzes data from prior patients who received radiation treatment to improve the treatment of new patients.



CONTINUED FROM PAGE 17.

Just as the trajectory of the beam is only as good as the guidance system, the image guidance is only as good as the quality of the images it receives. Imaging resolution has been a challenge that often leads to a larger field of radiation treatment to ensure that cancer cells aren't missed.

"Imaging is critical to the process. The better you can see the target, the more precisely you can treat with radiation," says Wong. "If I don't know where the tumor is, it doesn't matter how great the equipment is." He says proton therapy has been delivered for many years without absolutely knowing for sure where the beam is hitting.

**"We own all of our machines, so we are not driven by profit to select one machine over others. Patient care—whatever is the best option for the patient—will guide this decision-making."**

The CT Couch addresses this problem, introducing—for the first time—practical in-room imaging. Some refer to it as on-board imaging, but Wong prefers CT Couch because of an essential component—the couch is part of the therapy machine, but it is not on the therapy machine so it does not disturb or interfere with any of the treatment machinery. The image quality is comparable to diagnostic-quality CT and far superior to cone beam CT—one of Wong's earlier inventions—and other existing imaging technologies.

The proton therapy CT Couch will integrate radiation simulation with radiation treatment, and because Wong is the inventor, his patented technology will be unique to the Kimmel Cancer Center's radiation oncology clinics, including the National Proton Center.

The idea to integrate imaging with therapy came to him when he observed colleague Viswanathan's novel 3D image-guided brachytherapy. One part involves advanced MRI guidance, and the other uses mobile CT to check the placement of the implant every day to confirm the location of the radioactive seeds that treat cervical, uterine and vaginal cancers.

"It made me realize you could do CT imaging with a small footprint," he says. This small footprint makes it possible to bring imaging into the treatment room without interfering with the treatment equipment.

"This is precision therapy in practice," says DeWeese. "Patients' tumors are in their bodies in a specific orientation, and this differs patient by patient. One size doesn't fit all," he explains. "We have to target each patient's cancer differently, and we do this based on a sophisticated set of scans before patients are treated. Those images are fused together, sort of like virtual reality, so we know precisely where in the body the tumor is in relationship to the normal cells around it."

DeWeese says a CT scan of a patient is done to see where cancer is on the day of treatment relative to where it was determined to be in treatment planning. All of the images are merged to precisely aim the beam within an incredible one-tenth of 1 millimeter accuracy.

The CT Couch will be integrated into both photon and proton therapy, helping ensure the treatment beam goes where it is intended, and perhaps more importantly, avoiding critical organs and structures that need to be protected from radiation treatment.

## Comparative Planning

To use proton or not to use proton is the question that few centers can solve.

"We own all of our machines, so we are not driven by profit to select one machine over others. Patient care—whatever is the best option for the patient—will guide this decision-making," says Viswanathan.

The Kimmel Cancer Center's excellence in all areas of radiation therapy makes it possible to offer comparative planning. This means the ability to determine which one of its many radiation treatment tools—proton, photon, CT- and MRI-guided brachytherapy, stereotactic ablative radiation, Cyberknife—is the best option for each patient.

"The kind of radiation our experts perform is already very focused in conforming to the tumors. Some centers have been so proton focused they are missing the benefits of other types of radiation," says Viswanathan. "Proton therapy, for example, cannot substitute for stereotactic ablative radiotherapy, so the benefit of an expert team who can make the important comparisons and correctly determine, patient by patient, which form of radiation therapy is the optimal choice cannot be overstated."

Stereotactic ablative radiotherapy involves many weaker beams that come from a variety of directions and converge at the tumor to deliver a more precise, higher-dose beam to the cancer.

This kind of comparative planning is another unique service of the Johns Hopkins National Proton Center. For each patient, it involves analysis of imaging and treatment plans for each machine to determine which type of radiation therapy is the best approach. Sometimes it may be a combination.

Every type of radiation therapy has its place, but most centers lack the capability to use data and science to make those judgments. "It's not always obvious," says



DeWeese, “so this is another area where expertise is vitally important. All plans are not created equally.”

“There are some cancers, such as those in the brain or near vital organs, that should get proton therapy, but there are other cancers that would respond better to photon therapy,” explains Viswanathan. “Some patients might benefit from a combination of both. We may want to treat the main tumor with photons and metastatic sites or lymph nodes with protons.”

Working with our radiation oncologists, our medical physicists use supercomputers to iterate the plans hundreds of times to arrive at the most ideal way to deliver radiation to each patient. The selected plan is reviewed, modifications are made and it is tested with a virtual avatar of the patient to be sure it has the outcomes anticipated. The end product is precision radiation therapy that has been detailed and confirmed at many levels and specific to the needs of each patient.

## Oncospace and Proton

Further informing these decisions is a Kimmel Cancer Center-built data mining system called Oncospace.

This complex system scrutinizes and analyzes data from prior patients who received radiation treatment to improve the treatment of new patients. It evaluates the therapies that worked best for a particular cancer and learns from those that resulted in less-than-favorable outcomes to generate an optimal treatment plan.

Ten years in the making, Oncospace was piloted in head and neck cancers, which are among the most difficult cancers for radiation physicists and oncologists to plan for, says radiation physicist **Todd McNutt**, who built the technology. It often requires many revisions to design a treatment that hits the cancer with radiation but does not do damage to vital organs and glands, such as the voice box and salivary glands, he says.



### INNOVATION

A technology called Oncospace, developed by physicist **Todd McNutt**, Ph.D., compares outcomes to determine when and in which patients proton therapy is the best option.

CARE

# Kimmel in the Community



## Howard Hopkins Partnership

The opening of the Johns Hopkins National Proton Center will also mark the start of a collaborative medical physics program with Howard University.

**Theodore DeWeese** and **John Wong** collaborated with Quinton Williams, chair of the physics and astronomy department, and Prabhakar Misra, professor of physics, at Howard University, a historically black university in Washington, D.C., to get the program up and running.

“Howard University has a top notch undergraduate program in physics and engineering with outstanding students,” says DeWeese. “These are exactly the kinds of students who will excel in our joint program and become great contributors to the field.”

Wong and other Kimmel Cancer Center physicists will be among the faculty of the new program. DeWeese approached Wayne Frederick, president of Howard University with the idea when he noticed there were very few African Americans among the 4,000 members of the professional society for medical physicists.



## Unity Health Care

A collaboration between Unity Health Care and Johns Hopkins Sibley Memorial Hospital brings a cancer clinic to underserved communities in Washington, D.C. The specialty services offered through this collaboration will provide much-needed cancer care to underserved patients in Wards 7 and 8, who have some of the highest cancer rates in the country, and other areas throughout the District of Columbia.

The Parkside Health Center will serve as home base for the clinic. A nurse navigator will help patients overcome barriers to care and facilitate timely access to treatment at the Johns Hopkins Kimmel Cancer Center and Johns Hopkins National Proton Center.



CONTINUED FROM PAGE 25.

With such vulnerable anatomy close to the tumor, radiation can impact the function of untreated glands as much as the treated glands, explains McNutt. Instead of looking at each gland as an independent organ, he says Oncospace helps them analyze it all together. It's called inter-organ dependency, and he and collaborators, like head and neck cancer expert **Harry Quon**, are the first to use such complex computer analysis to understand it and improve care for patients.

"All of these glands work together to produce saliva. If I give a high dose of radiation to one gland, we have to know how much function we have to preserve in all of these other glands to keep salivary production at a comfortable level," says McNutt. "If I overdose this ductal region, I may render some portion of the rest of the gland useless." Although the gland may still function, it blocks the flow of saliva, making it difficult to eat, causing pain and often leading to oral infections.

Oncospace quantifies, measures and analyzes all of the variations in treatments and toxicities in patients already treated to inform the care of new patients. Every patient treated adds to the data, so it is ever improving as new data—and more types of data, such as physician notes and imaging—are included.

"There is knowledge in the variations in toxicities and response that occur from patient to patient, and this type of analysis is only possible with the analytic capabilities of Oncospace," says Quon.

It's a tool that no other cancer center in the world has, and Quon says it has been instrumental in improving patient care. He credits it with attracting people to the Kimmel Cancer Center's head and neck cancer practice.

McNutt's system provides the guidance that allows Quon and other clinicians to maximize healing and minimize harm. It scours all of the data on head and neck cancer patients treated in the Kimmel Cancer Center; charts radiation dose distributions, toxicity and other data in

vividly colored computerized maps and graphs; and reveals the optimal plan. At the same time, it takes into account and connects all of the variables—age, underlying health conditions and other treatments patients are receiving—and figures out how all of these variables relate and influence toxicities and response to treatment.

They are even exploring the physiological features of glands and the potential role they play. Information like texture, fat content, fibrous connective tissue around glands and overall health of salivary glands are entered into Oncospace to help guide individualized treatment plans for patients.

Oncospace uses a type of artificial intelligence known as machine learning to look back at the patterns of dose within the anatomy and how these doses related to patient outcomes. In head and neck cancer, McNutt and Quon know there are stem cells throughout the glands that initiate the healing that keeps the glands healthy. By querying Oncospace, they found that varying the dose of radiation may be the key to protecting these stem cells and ensuring that salivary function returns after radiation.

"This is one of the things we are most excited about studying in the proton center," says Quon. "Now when we have to give radiation close to areas that we think contain these repair stem cells, we have the capability to stop the proton beam on a dime. That makes it possible for us to keep radiation at a low dose in these critical stem cell regions. It gives us some new options."

Proton therapy, he says, offers the ability to improve patterns of dose because it is so targeted. Oncospace also compares photon and proton treatment outcomes to determine when and in which patients proton is preferable and when photon may be the better option. It is one more tool that helps our experts know the best way to use proton therapy.

No one else is doing this because no one else has the technology to quantify and measure

the myriad of contributing factors to make these incredibly complex calculations.

McNutt is now beginning to apply the same analytical tools to decrease swallowing problems, potentially life-threatening scarring of the larynx and the less serious but nonetheless troubling impact on taste for head and neck cancer patients getting radiation. They are also exploring how to use Oncospace to predict risk of cancer recurrence, and which patients will likely benefit from treatment with immunotherapy, and identify patients who would most benefit from receiving radiation therapy after surgery. Oncospace is also being expanded to mine other cancers, including esophageal, lung, pancreatic, prostate and pediatric cancers, with the goal of using it to inform the treatment of every cancer type. Ultimately, he would like to make the technology available to experts throughout the U.S. and the world.

**"Now when we have to give radiation close to areas that we think contain these repair stem cells, we have the capability to stop the proton beam on a dime."**

Experts from Japan, a country with a long history of treating cancer with proton therapy, are coming to the Kimmel Cancer Center to collaborate with McNutt and discuss including their data in the system.

"The truth is no one can keep treating with protons without the evidence and guidance Oncospace provides," Quon says. He hopes other proton centers will want to collaborate.

"This kind of inventory opens up a lot of opportunities," says Quon. "The data's value is not just defined by what you want to do now but also by the possibilities of what we can do in the future."

# Pediatrics

## A collaboration with Children's National

Like adult patients, pediatric patients receive radiation therapy as treatment for a variety of cancers. Brain tumors are the most common solid tumor in children and the cancer where most experts agree proton has the edge because of its ability to so precisely spare surrounding normal cells.

It is clear that every patient does not need proton therapy. "It's a necessary tool to have to use at certain times, but not every time," says DeWeese. "We look at each patient—pediatric and adult—individually to bring the best technology and treatment plan we have to bear against their cancer. We look at anatomy of where the tumor is

and what is the best approach to kill the cancer and preserve everything else."

In fact, how to lessen the adverse effects of radiation has long been an area of research among the Kimmel Cancer Center's pediatric radiation oncologists.

Although it is generally accepted that proton therapy provides benefit over other types of radiation therapy for pediatric patients, research studies are lacking, and our experts understand better than most the important role of laboratory and clinical science in setting the standard of pediatric cancer care. We've been leaders for more than a half-century.



**Children's National**

When the National Cancer Institute established four study groups to investigate common childhood cancers in the late 1970s, Johns Hopkins radiation oncologist **Moody Wharam** was the only expert appointed to two of the groups. From 1980 to 1990, he served as director of the radiation oncology committee of the Pediatric Oncology Group, now known as the Children's Oncology Group, the world's largest organization devoted exclusively to childhood and adolescent cancer research. Wharam and Kimmel Cancer Center collaborators were active participants in all of the pivotal pediatric cancer research of the time—research that led to dramatic increases in pediatric cancer survival rates.

Akila Viswanathan, M.D., M.P.H. (left) and Jeffrey Dome, M.D., Ph.D.



**COLLABORATION**  
Patients have access to the combined expertise of **Children's National** and the **Johns Hopkins Kimmel Cancer Center**.



“The way we manage radiation therapy in children today is based on what he did through all those years of tireless work. That’s why we do research,” says DeWeese.

The cruel irony that the radiation treatments given to save the lives of young patients also has the potential to cause harm continues to trouble radiation oncologists. Radiation to growing bones and organs can impede normal development, and radiation to the brain, a common site of pediatric cancers, too often results in impairments to learning and other cognitive brain functions.

**The ability to better steer protons to the cancer and stop the beam means developing brains, the heart, lungs and growing bones can be better protected. Reducing an unnecessary dose is a good thing.**

In this long history of improving care for pediatric cancer patients, proton therapy is viewed as another major advance in managing late effects of radiation therapy. **Matthew Ladra**, director of pediatric radiation oncology, is eager to begin proton therapy studies. Ladra was the first radiation oncologist to earn a proton therapy-specific fellowship, which he completed at Massachusetts General Hospital. This training led to a directorship of the pediatric service at the Provision Center for Proton Therapy in Knoxville, Tennessee.

**Jen Holt**, who also worked at the Provision Center, joined Ladra as nurse manager for the pediatric radiation oncology program.



## Nanoparticles and Organoids

Pediatric radiation oncologist **Matthew Ladra** is experimenting with protons, nanoparticles and organoids to deliver promising new therapies to pediatric patients.

One study uses nanoparticles—ultra-tiny structures that can transport a cargo of drugs and other cancer-fighting treatments to tumors—to reset cells’ natural cancer-fighting DNA. Ladra says that many pediatric cancers are missing a key tumor suppressing gene, called P53, and the nanoparticles transport the gene to cancer cells to put it back into action.

“We use proton therapy to stun the tumor and open it up so we can infuse radiolabeled p53 genes,” he says. The gene is already present in normal cells, so it only goes to work in tumor cells. The radiolabel allows the scientists to see and track the gene inside cancer cells to confirm that if it turns on and helps shrink the tumor.

Ladra also plans to collaborate with drug discovery experts and other scientists to study drug/proton combinations. In pediatric brain tumor research, he is excited about a new model of discovery being used by radiation molecular scientist **Sonia Franco**. Tiny, organized spheres of human neural and nerve cells about the size of a fly’s eye, called organoids or minibrains, are providing an innovative way to research treatments of pediatric brain cancers. Franco is using them to replicate how pediatric brain cancers naturally grow and spread, and to study more closely how these cancers respond to radiation and drug treatment. In a precision medicine approach, a minibrain could be created as a stand-in for a patient by implanting it with cells from the patient’s brain cancer.

“When children get exposed to radiation at a young age, they are at much higher risk of issues down the road when they are long-term survivors,” says Ladra. He is among a select number of radiation oncologists whose practice and research focus solely on pediatric cancers. “Our goal is to radiate what’s supposed to be radiated and leave everything else alone. Proton therapy helps us do that.”

The ability to better steer protons to the cancer and stop the beam means developing brains, the heart, lungs and growing bones can be better protected.

Ladra says he has seen the benefits. He recalls brain tumor patients he treated with proton therapy who have none of the telltale signs of a brain tumor battle. “They have no cognitive issues. They are growing normally. It’s very rewarding, and the technology we have at Johns Hopkins is even better, and that means there are still advances that can be made,” says Ladra.

Still, he knows that there is a difference between anecdotal reports of benefits and scientific evidence. The latter is a key element that has been missing from the conversation.

Novel research, including a map of the brain that relates dose of radiation to impact on specific areas of the brain, showing the maximum dose of radiation each area of a young brain can tolerate without causing functional deficits, is providing information that other centers don’t have. It is revealing areas that will require smaller doses of radiation but also others that could safely tolerate larger doses.

The opportunity to study the benefits of proton therapy is what attracted him to the Kimmel Cancer Center. The Johns Hopkins National Proton Center is only one of two in the country that has a dedicated pediatric facility and a proton research program.

“This is a truly visionary approach. Research is the only way to get at concrete evidence of the advantage of using protons to treat children and to show us how we can improve the care of kids moving forward,” says Holt.

The dedicated pediatric oncology service has its own team of experts—radiation oncologists and technicians, pediatric nurses, including a nurse practitioner and nurse navigator, a child life specialist, a nutritionist, survivorship and family counselors, and a pediatric anesthesiologist, as very young patients often require some sedation during treatment.

“The proton therapy technology is much better now, and we will have the most up-to-date proton facility, but expertise is critical,” says DeWeese. “Like anything else, it has to be done well. We are learning now that there can be issues with proton therapy when not done correctly.”

Proton therapy may also be a better option for pediatric patients with sarcoma, cancers of the bone and soft connective tissue. Sarcomas are particularly challenging to treat because they often occur in the vicinity of other vital anatomy and

growing organs. With its precision, the proton beam offers the ability to get at the cancer without harming these nearby structures. As a result, experts believe it may help patients avoid amputation.

Spinal tumors, cancers in the head and neck, tumors that are close to other organs—which in the small bodies of children can be many—and abdominal and pelvic tumors are also well-suited to proton therapy.

For example, a toddler with a tumor sitting close to growth plates in the pelvis can be treated with proton therapy to protect the pelvic bones from radiation damage that can cause the growth plates to close, resulting in growth issues and other problems later in life. In other cancers, such as Hodgkin lymphoma, that require radiation to the chest, proton therapy can protect the heart and lungs. In other cases, another type of radiation therapy may be preferable.

“Proton therapy is an essential tool to have at certain times, but it’s not the only tool,” says Ladra. “We look at anatomy of where the tumor is and what we need to preserve and decide on case by case if the

patient would most benefit from proton therapy.”

A teenage patient recently treated for osteosarcoma that had spread, creating a golf ball-sized tumor in the patient’s lung, benefited from stereotactic ablative radiation. Surgery was not an option because of pre-existing damage to the lung. Immunotherapy with drugs aimed at boosting the immune system to attack the cancer was not keeping the cancer in check, so the multispecialty team of doctors decided to use stereotactic radiosurgery to go after the tumor in her lung. The tumor disappeared, and the patient remains cancer-free.

The combined treatment of immunotherapy and stereotactic ablative radiation allowed her to avoid more toxic chemotherapy that is frequently ineffective against advanced osteosarcoma. For the teenager, who was about to begin high school, it was also a quality of life issue. She didn’t want her hair to fall out, and the radiation/immunotherapy combination worked better against her cancer without altering her appearance.

Working in collaboration with experts at the Bloomberg-Kimmel Institute for Cancer Immunotherapy, our radiation oncologists uncovered evidence that cancer cells killed by radiation signal the immune system as they die, revealing their identity as a cancer cell and setting cancer-killing immune cells into action. Similar studies are planned combining immunotherapy and proton therapy.

“In a center with so much strength in every area of cancer research and therapy, we have more information to help inform our treatment decisions, and that leads to novel, patient-centered medicine and better outcomes,” says Holt. “There are so many things available here—comparative planning, specialized nursing care, multispecialty collaboration—that are not available at other places. The fact that we’re different from most of the proton centers out there is also what makes us better. Our patients get it, and their parents get it.”



Kurt Newman, M.D. (left) and Theodore DeWeese, M.D.

#### COLLABORATION

“This shows how two nationally respected institutions came together in a collaborative and strategic way to change the face of pediatric cancer.”



**CARE**

The dedicated pediatric oncology service has its own team of experts, including pediatric anesthesiologist **Eugenie Heitmiller, M.D.** (right).

The knowledge about the cancer being treated must be equivalent to the proton expertise, Viswanathan stresses. The multispecialty approach the Kimmel Cancer Center uses means each patient's care is informed by every specialist. Radiation oncologists, medical oncologists, pathologists, nurses, surgeons and other experts work together to evaluate every case and develop the best treatment plan. "This multidisciplinary component is so important because what really makes proton therapy at the Kimmel Cancer Center special is what our experts bring to it," she says.

## Unique Collaboration

It is this kind of pioneering influence that earned the radiation oncology program distinction as one of a select few in the nation with a long and proven track record of excellence in treating pediatric cancers.

In 2013, it helped pave the way for a collaboration with Children's National. It creates one of the largest pediatric

radiation oncology programs in the country, and the increase in patient volume promises to speed clinical discovery.

"It is another example of our strategic focus to consistently partner with organizations in the region to bring high-quality, accessible care to children and families," says **Elizabeth Flury**, Executive Vice President and Chief Strategy Officer at Children's National. "When we base our strategic decisions around what's best for the child, everyone wins. This collaboration is a perfect example of that thinking."

DeWeese believes it is a national model. "This shows how two nationally respected institutions came together in a collaborative and strategic way to change the face of pediatric cancer care in the region and around the world," he says.

Through the collaboration, patients have access to the combined expertise of Children's National and the Kimmel Cancer

Center's pediatric oncology program. The Kimmel Cancer Center's pediatric cancer program has consistently been ranked by *U.S. News & World Report* as one of the top pediatric cancer programs in the country, and Children's National was also ranked as one of the top five children's hospitals in the country. The collaborations include joint clinical trials and research initiatives with the National Institutes of Health.

"Working together through an integrated radiation oncology service—including research—we are providing important new treatment options for kids fighting cancer who live in the national capital area or who travel here to take advantage of our joint expertise," says **Kurt Newman**, President and Chief Executive Officer of Children's National. The joining of these two leading programs marks a significant achievement in children's health, he says.

The collaboration represents the first pediatric radiation oncology program in the national capital region. DeWeese says









## CARE

## Zay Zay the Superhero

Ezaylen's "Zay Zay's" mom, Phyllice, instinctively knew something serious was wrong when 2-year-old Zay Zay experienced persistent high fevers and constant ear infections. Although her mother's intuition was correct, she never imagined that the fevers and a protruding tummy she chalked up to a healthy appetite were actually Wilms tumor, a type of pediatric kidney cancer. Two-year-old Zay Zay was diagnosed with stage III cancer, and the tumor was occupying a shocking 90% of his kidney.

After chemotherapy and surgery to remove the diseased kidney, his Children's National doctors recommended radiation therapy as part of the treatment plan and referred him to **Matthew Ladra**, director of pediatric radiation oncology at the Johns Hopkins Kimmel Cancer Center at Sibley Memorial Hospital.

"I was very concerned at first," says Phyllice, who was aware of the side effects radiation treatment can have on young, growing children. "My husband convinced me we had to do it. The treatment would help make sure no cancer cells survived."

It's a decision Phyllice has never regretted. "Johns Hopkins is awesome," she says. "Dr. Ladra is a great doctor. We had a good connection from the start, and everyone—doctors, nurses, child life teachers—stayed in constant communication with us, explaining the therapy and involving us every step of the way."

One year later, Zay Zay's treatments appear to be working, she says. He still has more chemotherapy ahead of him, but he has lived up to his love of superheroes and her nickname for him—little firecracker. She says, "He's small but powerful."





**COLLABORATION**

The Johns Hopkins/Children's National collaborative creates one of the largest pediatric radiation oncology programs in the country.

From left: **Lin Whetzel, B.S.N., R.N., Jennifer Holt, B.S.N., R.N., Matthew Ladra, M.D., M.P.H., Andrea Lattimore, B.S.N., R.N., Judy Tran, C.R.N.P**



Jean Wright, M.D.



Theodore DeWeese, M.D.



the dedicated, multispecialty team brings the most advanced therapy and the highest level of safety and quality care for pediatric patients and families.

“There are cases in which radiation is the best way to enhance treatment for a young patient,” says **Jeffrey Dome**, Oncology Division chief at Children’s National. “This collaboration is focused on finding the best strategies based in current research to integrate radiation therapy into a comprehensive care regime.”

## Built on Tradition

So many things in cancer research have their roots in the Kimmel Cancer Center. It is this convergence of expertise that makes the Johns Hopkins National Proton Center stand out among others. Kimmel Cancer Center scientists and clinicians bring expertise to all areas of the cancer compendium and are among the undisputed leaders in cancer genetics, epigenetics and immunotherapy. Add to that Magnet nursing status recognition for quality of care, one of the first programs to study late effects of cancer treatment and complete integration of cancer services across all Kimmel Cancer Center locations, and before its doors even open, the Johns Hopkins National Proton Center distinguishes itself among cancer centers and proton centers alike—in the Baltimore/Washington region and around the country.

To ensure quality of care and access to proton therapy among all of our sites, radiation oncologist **Daniel Song** will lead regional chart rounds to discuss patient cases across all Kimmel Cancer Center locations, including Sibley, Suburban, Green Spring Station, Johns Hopkins Bayview Medical Center and Johns Hopkins Hospital. **Jean Wright** will oversee safety and quality across all locations. Clinical nurse specialist **Jen Weirworka** bridges all of the sites, overseeing intensive training for nurses to ensure the same standard of care exists at every Kimmel Cancer Center location.

In addition to the cancer acumen of leaders in every field of cancer research and treatment, the National Proton Center has at its disposal the brain trust of all of The Johns Hopkins University to lend their expertise and advance the application of proton therapy alone and in combination with other cancer treatments. This progress is in line with everything else our experts are doing to make cancer therapies work better for patients while also limiting toxicities. Targeted drug therapies, organ-sparing surgeries and less toxic proton therapy all have this goal.

“We can bring together so many things that are not available at other places. This wealth of expertise means we have more information coming, more people informing decisions and solving problems, and that leads to better outcomes for patients. We approach cancer from all angles. There is not one single preferred solution. Sometimes it is a combination of therapies.”

Two specialized institutes will also support our proton center. A new Translational Convergence Institute brings doctors, nurses, astronomers, engineers, computer scientists, physicists, bioethicists, biologists, materials scientists and mathematicians together to work side by side to amass and apply their knowledge to cancer. They will solve complicated and vexing problems, build new technologies and consider out-of-the-box, creative new approaches that can only be found through this type of directed collaboration.

The Bloomberg-Kimmel Institute for Cancer Immunotherapy will help integrate proton therapy with immunotherapy, revolutionary new treatments that activate the immune system to attack cancers. A Drug Discovery and Develop-

ment program will advance combined treatments with new targeted therapies, and a first-of-its-kind Cancer Invasion and Metastasis Program, co-lead by radiation oncologist Phuoc Tran, will study proton therapy, among other treatments, to transform the management of advanced cancers.

“We can bring together so many things that are not available at other places. This wealth of expertise means we have more information coming, more people informing decisions and solving prob-

lems, and that leads to better outcomes for patients,” says Akila Viswanathan. “We approach cancer from all angles. There is not one single preferred solution. Sometimes it is a combination of therapies.”

Viswanathan says one of the most important collaborations will be with the community of primary care providers who choose us to work with them to develop the optimal treatment plans for their patients.

“The Johns Hopkins National Proton Center is one of the few comprehensive proton centers in the world. We will be doing research that has never been done before,” says DeWeese. “It’s going to be a huge advance for the field.”

**New on the Web**  
Watch our new video about the Johns Hopkins National Proton Center. [hopkinscancer.org](http://hopkinscancer.org)



JOHNS HOPKINS  
MEDICINE

THE SIDNEY KIMMEL  
COMPREHENSIVE CANCER  
CENTER

750 E. Pratt Street  
Suite 1700  
Baltimore, Maryland 21202



IF YOU PREFER NOT TO RECEIVE FUNDRAISING COMMUNICATIONS FROM THE FUND FOR JOHNS HOPKINS MEDICINE, PLEASE CONTACT US AT 1-877-600-7783 OR [JHHOPTOUT@JHMI.EDU](mailto:JHHOPTOUT@JHMI.EDU). PLEASE INCLUDE YOUR NAME AND ADDRESS SO THAT WE MAY HONOR YOUR REQUEST.

NON-PROFIT  
U.S. POSTAGE  
PAID  
PERMIT #1608  
BALTIMORE, MD

The Johns Hopkins  
National Proton Center.  
It Can Change a Life.

[HOPKINSPROTON.ORG](http://HOPKINSPROTON.ORG)

