

NETGEAR®

ProSecure Web/Email Security Threat Management Appliance STM150, STM300, or STM600 Reference Manual



350 East Plumeria Drive
San Jose, CA 95134
USA

January 2011
202-10519-06
1.0

© 2009–2011 NETGEAR, Inc. All rights reserved.

No part of this publication may be reproduced, transmitted, transcribed, stored in a retrieval system, or translated into any language in any form or by any means without the written permission of NETGEAR, Inc.

Technical Support

Thank you for choosing NETGEAR. To register your product, get the latest product updates, or get support online, visit us at <http://support.netgear.com>.

Phone (US & Canada only): 1-888-NETGEAR

Phone (Other Countries): See Support information card.

Product Updates

Product updates are available on the NETGEAR website at <http://prosecure.netgear.com> or <http://kb.netgear.com/app/home>.

ProSecure Forum

Go to <http://prosecure.netgear.com/community/forum.php> for information about the ProSecure forum and to become part of the ProSecure community.

Trademarks

NETGEAR, the NETGEAR logo, ReadyNAS, ProSafe, ProSecure, Smart Wizard, Auto Uplink, X-RAID2, and NeoTV are trademarks or registered trademarks of NETGEAR, Inc. Microsoft, Windows, Windows NT, and Vista are registered trademarks of Microsoft Corporation. Other brand and product names are registered trademarks or trademarks of their respective holders.

Statement of Conditions

To improve internal design, operational function, and/or reliability, NETGEAR reserves the right to make changes to the products described in this document without notice. NETGEAR does not assume any liability that may occur due to the use, or application of, the product(s) or circuit layout(s) described herein.

Revision History

Manual Part Number	Manual Version Number	Publication Date	Description
202-10519-06	1.0	February 2011	Made the following changes: <ul style="list-style-type: none">• Upgraded the book to the new format.• Entirely revised Chapter 6, Monitoring System Access and Performance, to document the new Logs, Reports, and Alerts configuration menus that replaced the old Logs & Report configuration menu.• Added Appendix A, Report Templates.• Separated the traffic logs into email traffic logs and Web traffic logs (see Configuring and Activating System, Email, and Syslog Logs and Querying Logs).• Under the Monitoring main navigation menu, replaced all screen shots that showed the old Logs & Reports configuration menu with screen shots that show the new Alerts, Logs, and Reports configuration menus.

202-10519-06 (continued)	1.0	February 2011 (continued)	(continued) <ul style="list-style-type: none"> Revised the Setup Wizard update settings information (see Setup Wizard Step 7 of 11: Update Settings), software update information (see Updating the Software), and system status information (see Viewing System Status).
202-10519-05	1.0	July 2010	<p>Added the following major new features:</p> <ul style="list-style-type: none"> Network refresh and permanent MAC address bindings (see Configuring the Network Refresh and Permanent MAC Address Bindings) Setting exceptions for custom groups and custom categories, and setting exceptions for file extensions and protocols (see Setting Scanning Exclusions and Web Access Exceptions) Creating custom groups (see Creating Custom Groups for Web Access Exceptions) Creating custom categories—see Creating Custom Categories for Web Access Exceptions) Using the DC Agent (see Understanding the ProSecure DC Agent, Requirements for the ProSecure DC Agent Software and DC Agent Server, and Downloading ProSecure DC Agent Software, and Creating and Deleting DC Agents) <p>Also added the following minor features:</p> <ul style="list-style-type: none"> Requirement to accept terms of service agreement on the Real-Time Blacklist screen Capability to set the public host, IP address, and port on the Distributed Spam Analysis screen Capability to replace the content of a blocked page with custom text Capability to enable and disable SSLv2 Refinements in the active users search methods. Domain information in the output screens that are accessible from the Monitoring menu Testing a URL as part of the diagnostics tools
202-10519-01	1.1	October 2009	Index update.
202-10519-01	1.0	September 2009	Initial publication of this reference manual.

Contents

Chapter 1 Introduction

What Is the ProSecure Web/Email Security Threat Management Appliance STM150, STM300, or STM600?	8
What Can You Do with an STM?	9
Key Features and Capabilities	9
Stream Scanning for Content Filtering	10
Autosensing Ethernet Connections with Auto Uplink	11
Easy Installation and Management	11
Maintenance and Support	12
STM Model Comparison	12
Service Registration Card with License Keys	12
Package Contents	13
Hardware Features	14
Front Panel Ports and LEDs	14
Rear Panel Features	20
Bottom Panel with Product Label	22
Choosing a Location for the STM	23
Using the Rack-Mounting Kit	24

Chapter 2 Using the Setup Wizard to Provision the STM in Your Network

Choosing a Deployment Scenario	25
Gateway Deployment	25
Server Group	26
Segmented LAN Deployment	27
Understanding the Steps for Initial Connection	27
Qualified Web Browsers	28
Logging In to the STM	28
Understanding the Web Management Interface Menu Layout	30
Using the Setup Wizard to Perform the Initial Configuration	32
Setup Wizard Step 1 of 10: Introduction	33
Setup Wizard Step 2 of 11: Networking Settings	33
Setup Wizard Step 3 of 11: Time Zone	35
Setup Wizard Step 4 of 11: Email Security	37
Setup Wizard Step 5 of 11: Web Security	39
Setup Wizard Step 6 of 11: Email Notification Server Settings	42
Setup Wizard Step 7 of 11: Update Settings	43
Setup Wizard Step 8 of 11: HTTP Proxy Settings	45
Setup Wizard Step 9 of 11: Web Categories	46

Setup Wizard Step 10 of 11: Configuration Summary	48
Setup Wizard Step 11 of 11: Restarting the System	49
Verifying Correct Installation	49
Testing Connectivity	49
Testing HTTP Scanning	49
Registering the STM with NETGEAR	50
What to Do Next	51

Chapter 3 Performing Network and System Management

Configuring Network Settings	52
Configuring Session Limits and Timeouts	56
Configuring the Network Refresh and Permanent MAC Address Bindings	57
Managing Permanent MAC Address Bindings	59
Configuring the HTTP Proxy Settings	60
About Users with Administrative and Guest Privileges	61
Changing Administrative Passwords and Timeouts	62
Configuring Remote Management Access	64
Using an SNMP Manager	65
Supported MIB Browsers	67
Managing the Configuration File	67
Backing Up Settings	68
Restoring Settings	69
Reverting to Factory Default Settings	70
Updating the Software	71
Scheduling Updates	71
Performing a Manual Update	73
Critical Updates That Require a Restart	74
Configuring Date and Time Service	74
Managing Digital Certificates	76
Managing the Certificate for HTTPS Scans	78
Managing Trusted Certificates	79
Managing Untrusted Certificates	80
Managing the Quarantine Settings	81
Managing the STM's Performance	82

Chapter 4 Content Filtering and Optimizing Scans

About Content Filtering and Scans	84
Default Email and Web Scan Settings	85
Configuring Email Protection	87
Customizing Email Protocol Scan Settings	87
Customizing Email Anti-Virus Settings	88
Email Content Filtering	94
Protecting Against Email Spam	97
Configuring Web and Services Protection	105
Customizing Web Protocol Scan Settings	105
Configuring Web Malware Scans	107

Configuring Web Content Filtering	109
Configuring Web URL Filtering	116
HTTPS Scan Settings	119
Specifying Trusted Hosts	124
Configuring FTP Scans	125
Configuring Application Control	127
Setting Scanning Exclusions and Web Access Exceptions	130
Setting Scanning Exclusions	130
Setting Access Exception Rules for Web Access	132
Creating Custom Groups for Web Access Exceptions	139
Creating Custom Categories for Web Access Exceptions	142

Chapter 5 Managing Users, Groups, and Authentication

About Users, Groups, and Domains	147
Configuring Groups	148
Creating and Deleting Groups by Name	149
Editing Groups by Name	150
Creating and Deleting Groups by IP Address and Subnet	151
Configuring User Accounts	152
Creating and Deleting User Accounts	153
Editing User Accounts	154
Configuring Authentication	154
Understanding the STM's Authentication Options	155
Understanding Active Directories and LDAP Configurations	157
Creating and Deleting LDAP and Active Directory Domains	161
Editing LDAP and Active Directory Domains	164
Understanding the ProSecure DC Agent	164
Requirements for the ProSecure DC Agent Software and DC Agent Server	165
Downloading ProSecure DC Agent Software, and Creating and Deleting DC Agents	165
Creating and Deleting RADIUS Domains	167
Editing RADIUS Domains and Configuring VLANs	169
Global User Settings	170
Viewing and Logging Out Active Users	172

Chapter 6 Monitoring System Access and Performance

Configuring Logging, Alerts, and Event Notifications	175
Configuring the Email Notification Server	176
Configuring and Activating System, Email, and Syslog Logs	177
Configuring Alerts	182
Monitoring Real-Time Traffic, Security, Statistics, and Web Usage	184
Understanding the Information on the Dashboard Screen	184
Monitoring Web Usage	190
Viewing System Status	192
Querying Logs	194
Example: Using Logs to Identify Infected Clients	199

- Log Management 199
- Viewing, Scheduling, and Generating Reports. 200
 - Report Templates 200
 - Generating Reports for Downloading 202
 - Scheduling Automatic Generation and Emailing of Reports. 203
 - Advanced Report Filtering Options. 204
- Viewing and Managing the Quarantine Files 208
- Using Diagnostics Utilities 215
 - Using the Network Diagnostic Tools. 216
 - Using the Realtime Traffic Diagnostics Tool. 217
 - Gathering Important Log Information and
Generating a Network Statistics Report 218
 - Restarting and Shutting Down the STM 219

Chapter 7 Troubleshooting and Using Online Support

- Basic Functioning 223
 - Power LED Not On 223
 - Test LED or Status LED Never Turns Off. 223
 - LAN or WAN Port LEDs Not On 224
- Troubleshooting the Web Management Interface 224
- When You Enter a URL or IP Address a Time-Out Error Occurs. 225
- Troubleshooting a TCP/IP Network Using a Ping Utility. 225
 - Testing the LAN Path to Your STM 226
 - Testing the Path from Your PC to a Remote Device 226
- Restoring the Default Configuration and Password 227
- Problems with Date and Time 228
- Using Online Support 228
 - Enabling Remote Troubleshooting 228
 - Installing Hot Fixes 229
 - Sending Suspicious Files to NETGEAR for Analysis 230
 - Accessing the Knowledge Base and Documentation 231

Appendix A Report Templates

Appendix B Default Settings and Technical Specifications

Appendix C Related Documents

Appendix D Notification of Compliance

Index

This chapter provides an overview of the features and capabilities of the ProSecure Web/Email Security Threat Management Appliance STM150, STM300, and STM600. It also identifies the physical features of the appliances and the contents of the product packages.

This chapter contains the following sections:

- *What Is the ProSecure Web/Email Security Threat Management Appliance STM150, STM300, or STM600?* on this page
- *What Can You Do with an STM?* on page 9
- *Key Features and Capabilities* on page 9
- *Service Registration Card with License Keys* on page 12
- *Package Contents* on page 13
- *Hardware Features* on page 14
- *Choosing a Location for the STM* on page 23

What Is the ProSecure Web/Email Security Threat Management Appliance STM150, STM300, or STM600?

The ProSecure Web/Email Security Threat Management Appliance STM150, STM300, or STM600, hereafter referred to as the STM, is an appliance-based, Web and email security solution that protects the network perimeter against Web-borne threats from spyware, viruses, email, and blended threats. Ideally deployed at the gateway, it serves as the network's first line of defense against all types of threats, and complements firewalls, intrusion detection systems (IDS)/intrusion prevention systems (IPS), dedicated Intranet security products, and endpoint antivirus and antispymware software.

Powered by patent-pending Stream Scanning technology and backed by one of the most comprehensive malware databases in the industry, the STM can detect and stop all known spyware and viruses at the gateway, preventing them from reaching your desktops and servers, where cleanup would be much more difficult.

In addition to scanning HTTP, HTTPS, FTP, SMTP, POP3, and IMAP traffic, the STM protects networks against spam phishing attacks and unwanted Web use. The STM is a plug-and-play device that can be installed and configured within minutes.

What Can You Do with an STM?

The STM combines robust protection against malware threats with ease of use and advanced reporting and notification features to help you deploy and manage the device with minimal effort.

Here are some of the things that you can do with the STM:

- **Protect the network instantly.** The STM is a plug-and-play security solution that can be instantly added to networks without the need for network reconfiguration.
- **Scan network traffic for malware.** Using the Stream Scanning technology, you can configure the STM to scan HTTP, HTTPS, FTP, SMTP, POP3, and IMAP protocols. Unlike traditional batch-based scan engines that need to cache the entire file before they can scan, this scan engine checks traffic as it enters the network, ensuring unimpeded network performance.
- **Set access policies for individual users or groups.** You can configure Web and email access policies for individual users and groups based on the STM's local database, on a group IP address, on a Lightweight Directory Access Protocol (LDAP) domain, group, or user, or on a RADIUS VLAN.
- **Receive real-time alerts and generate comprehensive reports.** You can configure the STM to send alerts when a malware attack or outbreak is detected on the network. Real-time alerts can be sent by email, allowing you to monitor malware events wherever you are.

By configuring the STM to send malware alerts, you can isolate and clean the infected computer before the malware incident can develop into a full-blown outbreak. The STM also provides comprehensive reports that you can use to analyze network and malware trends.

- **Manage through SNMP support.** You can enable and configure the STM's Simple Network Management Protocol (SNMP) settings to receive SNMP traps through a supported management information base (MIB) browser.
- **Allow automated component updates.** Downloading components regularly is the key to ensuring updated protection against new threats. The STM makes this administrative task easier by supporting automatic malware pattern, program, and engine updates.

Key Features and Capabilities

The STM provides the following key features and capabilities:

- Up to two pairs of 10/100/1000 Mbps Gigabit Ethernet WAN ports (see [STM Model Comparison](#) on page 12).
- Scalable support (see [STM Model Comparison](#) on page 12) for:
 - Up to 600 concurrent users
 - Up to 6000 concurrently scanned HTTP sessions

- Up to 239 MB/s HTTP throughput
- Up to 960,000 emails per hour SMTP throughput
- Stream Scanning technology that enables scanning of real-time protocols such as HTTP.
- Comprehensive Web and email inbound and outbound security, covering six major network protocols: HTTP, HTTPS, FTP, SMTP, POP3, and IMAP.
- URL content filtering with 64 categories.
- Malware database containing hundreds of thousands of signatures of spyware, viruses, and other malware threats.
- Very frequently updated malware signatures, hourly if required. The STM can automatically check for new malware signatures as frequently as every 15 minutes.
- Multiple antispam technologies to provide extensive protection against unwanted emails.
- Spam and malware quarantine for easy analysis.
- Web application control, including access control for instant messaging, media applications, peer-to-peer applications, and Web-based tools and toolbars.
- User management with LDAP, Active Directory, and RADIUS integration, allowing you to configure access policies per user and per group.
- Easy, Web-based wizard setup for installation and management.
- SNMP-manageable.
- Dedicated management interface. (This feature is model dependent; see [STM Model Comparison](#) on page 12.)
- Hardware bypass port to prevent network disruption in case of failure. (This feature is model dependent; see [STM Model Comparison](#) on page 12.)
- Front panel LEDs for easy monitoring of status and activity.
- Internal universal switching power supply.

Stream Scanning for Content Filtering

Stream Scanning is based on the simple observation that network traffic travels in streams. The STM scan engine starts receiving and analyzing traffic as the stream enters the network. As soon as a number of bytes are available, scanning starts. The scan engine continues to scan more bytes as they become available, while at the same time another thread starts to deliver the bytes that have been scanned.

This multithreaded approach, in which the receiving, scanning, and delivering processes occur concurrently, ensures that network performance remains unimpeded. The result is file scanning that is up to five times faster than with traditional antivirus solutions—a performance advantage that you will notice.

Stream Scanning also enables organizations to withstand massive spikes in traffic, as in the event of a malware outbreak. The scan engine has the following capabilities:

- **Real-time protection.** The Stream Scanning technology enables scanning of previously undefended real-time protocols, such as HTTP. Network activities susceptible to latency (for example, Web browsing) are no longer brought to a standstill.

- **Comprehensive protection.** Provides both Web and email security, covering six major network protocols: HTTP, HTTPS, FTP, SMTP, POP3, and IMAP. The STM uses enterprise-class scan engines employing both signature-based and distributed spam analysis to stop both known and unknown threats. The malware database contains hundreds of thousands of signatures of spyware, viruses, and other malware.
- **Objectionable traffic protection.** The STM prevents objectionable content from reaching your computers. You can control access to the Internet content by screening for Web categories, Web addresses, and Web services. You can log and report attempts to access objectionable Internet sites.
- **Automatic signature updates.** Malware signatures are updated as frequently as every hour, and the STM can check automatically for new signatures as frequently as every 15 minutes.

Autosensing Ethernet Connections with Auto Uplink

With its internal 10/100/1000 ports, the STM can connect to either a 10 Mbps standard Ethernet network, a 100 Mbps Fast Ethernet network, or a 1000 Mbps Gigabit Ethernet network. The interfaces are autosensing and capable of full-duplex or half-duplex operation.

The STM incorporates Auto Uplink™ technology. Each Ethernet port automatically senses whether the Ethernet cable plugged into the port should have a “normal” connection such as to a PC or an “uplink” connection such as to a switch or hub. That port then configures itself correctly. This feature eliminates the need to think about crossover cables, as Auto Uplink accommodates either type of cable to make the right connection.

Easy Installation and Management

You can install, configure, and operate the STM within minutes after connecting it to the network. The following features simplify installation and management tasks:

- **Browser-based management.** Browser-based configuration allows you to easily configure the STM from almost any type of operating system, such as Windows, Macintosh, or Linux. A user-friendly Setup Wizard is provided, and online help documentation is built into the browser-based Web Management Interface.
- **SNMP.** The STM supports SNMP to let you monitor and manage log resources from an SNMP-compliant system manager. The SNMP system configuration lets you change the system variables for MIB2.
- **Diagnostic functions.** The STM incorporates built-in diagnostic functions such as a ping utility, traceroute utility, DNS lookup utility, and remote restart.
- **Remote management.** The STM allows you to log in to the Web Management Interface from a remote location on the Internet. For security, you can limit remote management access to a specified remote IP address or range of addresses.
- **Visual monitoring.** The STM's front panel LEDs provide an easy way to monitor its status and activity.

Maintenance and Support

NETGEAR offers technical support seven days a week, 24 hours a day. Information about support is available on the NETGEAR ProSecure website at <http://prosecure.netgear.com/support/index.php>.

STM Model Comparison

The following table compares the three STM models to show the differences:

Table 1. Differences between the STM Models

Feature	STM150	STM300	STM600
Performance and Sizing Guidelines			
Concurrent users	Up to 150	Up to 300	Up to 600
Web scan throughput	42 Mbps	136 Mbps	307 Mbps
Concurrent scanned HTTP connections	1500	3000	6000
SMTP throughput (emails per hour)	122,000	355,000	550,000
Hardware			
Gigabit RJ-45 ports	Total of 5 ports: • 1 uplink • 4 downlink	Total of 3 ports: • 1 pair of ports (1 uplink and 1 downlink) • 1 management	Total of 5 ports: • 2 pairs of ports ^a (2 uplink and 2 downlink) • 1 management
Gigabit RJ45 port pairs with failure bypass	0	1 pair of ports	2 pairs of ports
Dedicated management VLAN RJ45 ports	0	1	1

a. The STM600 provides two pairs of ports, allowing for support of two separate networks or subnets with strict traffic separation.

Service Registration Card with License Keys

Be sure to store the license key card that came with your STM in a secure location. You do need these keys to activate your product during the initial setup.

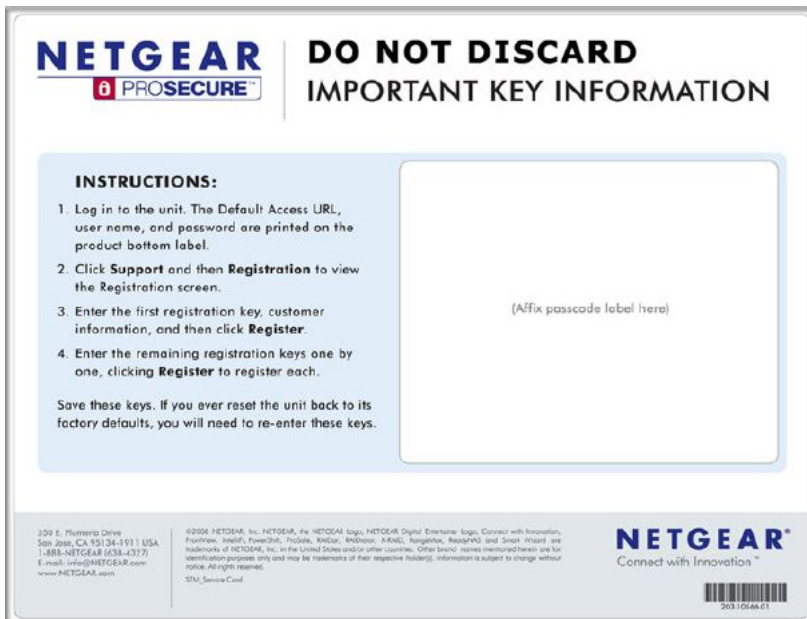

Figure 1.

Note: If you reset the STM to the original factory default settings after you have entered the license keys to activate the STM (see [Registering the STM with NETGEAR](#) on page 50), the license keys are erased. The license keys and the different types of licenses that are available for the STM are no longer displayed on the Registration screen. However, after you have reconfigured the STM to connect to the Internet and to the NETGEAR registration server, the STM retrieves and restores all registration information based on its MAC address and hardware serial number. You do not need to reenter the license keys and reactivate the STM.

Package Contents

The STM product package contains the following items:

- ProSecure Web/Email Security Threat Management Appliance STM150, STM300, or STM600
- One AC power cable
- Rubber feet (4) with adhesive backing
- One rack-mount kit
- Straight-through Category 5 Ethernet cable

- *ProSecure™ Web/Email Security Threat Management Appliance STM150, STM300, or STM600 Installation Guide*
- Depending on the model purchased, service registration card with one or more license keys

If any of the parts are incorrect, missing, or damaged, contact your NETGEAR dealer. Keep the carton, including the original packing materials, in case you need to return the product for repair.

Hardware Features

The front panel ports and LEDs, rear panel ports, and bottom label of the STM models are described in this section.

Front Panel Ports and LEDs

The front panels of the three STM models provide different components.

STM150 Front Panel

The following figure shows the front panel ports and status light-emitting diodes (LEDs) of the STM150:

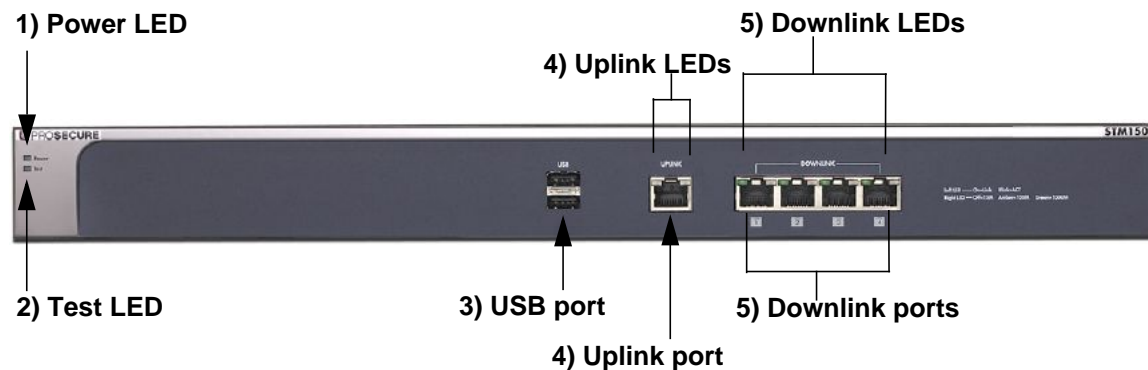

Figure 2.

From left to right, the STM150's front panel shows the following ports and LEDs:

1. Power LED.
2. Test LED.
3. One nonfunctioning USB port. This port is included for future management enhancements. The port is currently not operable on any STM model.
4. One uplink (WAN) Gigabit Ethernet port with an RJ-45 connector, left LED, and right LED.
5. Four downlink (LAN) Gigabit Ethernet ports with RJ-45 connectors, left LEDs, and right LEDs.

Note: All Gigabit Ethernet ports provide switched N-way, automatic speed-negotiating, auto MDI/MDIX technology.

The function of each STM150 LED is described in the following table:

Table 2. LED Descriptions for the STM150

Object	Activity	Description
Power	On (green)	Power is supplied to the STM.
	Off	Power is not supplied to the STM.
Test	On (amber) during startup	The STM is initializing. After approximately 2 minutes, when the STM has completed its initialization, the Test LED turns off. If the Test LED remains on, the initialization has failed.
	Off	The system has completed its initialization successfully. The Test LED should be off during normal operation.
	Blinking (amber)	The STM is shutting down.
		Software is being updated.
A hotfix is being installed.		
		One of the three licenses has expired. To stop the Test LED from blinking, renew the license, or click the Stop LED Blinking button on the System Status screen (see Viewing System Status on page 192).
Uplink (WAN) Port		
Left LED	Off	The WAN port has no physical link, that is, no Ethernet cable is plugged into the STM.
	On (green)	The WAN port has a valid connection with a device that provides an Internet connection.
	Blink (green)	Data is being transmitted or received by the WAN port.
Right LED	Off	The WAN port is operating at 10 Mbps.
	On (amber)	The WAN port is operating at 100 Mbps.
	On (green)	The WAN port is operating at 1000 Mbps.
Downlink (LAN) Ports		
Left LED	Off	The LAN port has no link.
	On (green)	The LAN port has detected a link with a connected Ethernet device.
	Blink (green)	Data is being transmitted or received by the LAN port.

Table 2. LED Descriptions for the STM150 (Continued)

Object	Activity	Description
Right LED	Off	The LAN port is operating at 10 Mbps.
	On (amber)	The LAN port is operating at 100 Mbps.
	On (green)	The LAN port is operating at 1000 Mbps.

Front Panel STM300

The following figure shows the front panel ports and LEDs of the STM300:

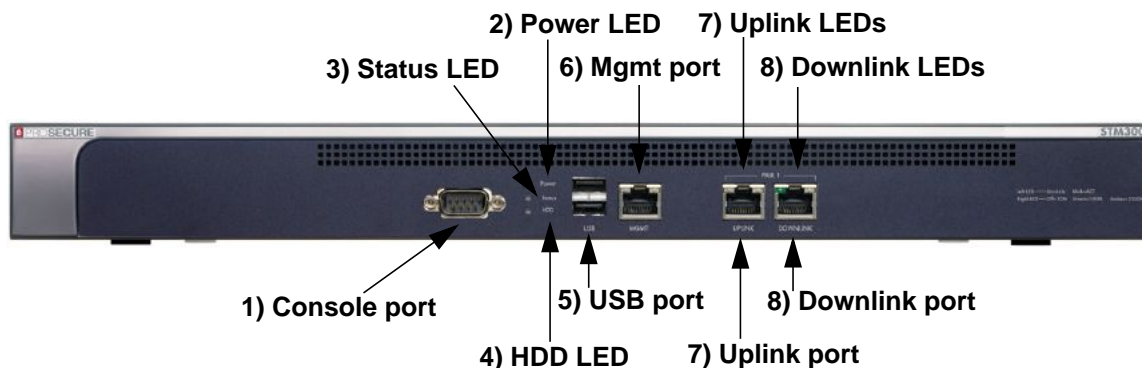

Figure 3.

From left to right, the STM300’s front panel shows the following ports and LEDs:

1. Console port. Port for connecting to an optional console terminal. The port has a DB9 male connector. The default baud rate is 9600 K. The pinouts are (2) Tx, (3) Rx, (5) and (7) Gnd.
2. Power LED.
3. Status LED.
4. Hard drive (HDD) LED.
5. One nonfunctioning USB port. This port is included for future management enhancements. The port is currently not operable on any STM model.
6. Dedicated management (Mgmt) Gigabit Ethernet port with an RJ-45 connector.
7. One uplink (WAN) Gigabit Ethernet port with an RJ-45 connector, left LED, and right LED.
8. One downlink (LAN) Gigabit Ethernet port with RJ-45 connectors, left LED, and right LED.

Note: All Gigabit Ethernet ports provide switched N-way, automatic speed-negotiating, auto MDI/MDIX technology.

The function of each STM300 LED is described in the following table:

Table 3. LED Descriptions for the STM300

Object	Activity	Description
Power	On (green)	Power is supplied to the STM.
	Off	Power is not supplied to the STM.
Status	On (amber) during startup	The STM is initializing. After approximately 2 minutes, when the STM has completed its initialization, the Status LED turns off. If the Status LED remains on, the initialization has failed.
	Off	The system has completed its initialization successfully. The Status LED should be off during normal operation.
	Blinking (amber)	The STM is shutting down.
		Software is being updated.
A hotfix is being installed.		
		One of the three licenses has expired. To stop the Status LED from blinking, renew the license, or click the Stop LED Blinking button on the System Status screen (see Viewing System Status on page 192).
HDD	On (Green)	Information is being written to the hard drive.
	Off	No hard drive activity.
Uplink (WAN) Port		
Left LED	Off	The WAN port has no physical link, that is, no Ethernet cable is plugged into the STM.
	On (green)	The WAN port has a valid connection with a device that provides an Internet connection.
	Blink (green)	Data is being transmitted or received by the WAN port.
Right LED	Off	The WAN port is operating at 10 Mbps.
	On (green)	The WAN port is operating at 100 Mbps.
	On (amber)	The WAN port is operating at 1000 Mbps.
Downlink (LAN) Ports		
Left LED	Off	The LAN port has no link.
	On (green)	The LAN port has detected a link with a connected Ethernet device.
	Blink (green)	Data is being transmitted or received by the LAN port.
Right LED	Off	The LAN port is operating at 10 Mbps.
	On (green)	The LAN port is operating at 100 Mbps.
	On (amber)	The LAN port is operating at 1000 Mbps.

Front Panel STM600

The following figure shows the front panel ports and LEDs of the STM600:

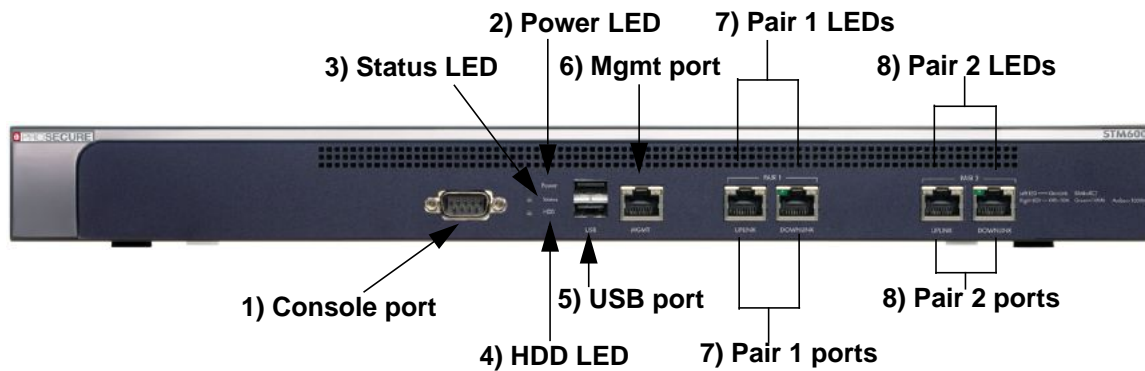

Figure 4.

From left to right, the STM600's front panel shows the following ports and LEDs:

1. Console port. Port for connecting to an optional console terminal. The ports has a DB9 male connector. The default baud rate is 9600 K. The pinouts are (2) Tx, (3) Rx, (5) and (7) Gnd.
2. Power LED.
3. Status LED.
4. Hard drive (HDD) LED.
5. One nonfunctioning USB port. This port is included for future management enhancements. The port is currently not operable on any STM model.
6. Dedicated management (Mgmt) Gigabit Ethernet port with an RJ-45 connector.
7. Pair 1 uplink (WAN) and downlink (LAN) Gigabit Ethernet ports with RJ-45 connectors, left LEDs, and right LEDs.
8. Pair 2 uplink (WAN) and downlink (LAN) Gigabit Ethernet ports with RJ-45 connectors, left LEDs, and right LEDs.

Note: All Gigabit Ethernet ports provide switched N-way, automatic speed-negotiating, auto MDI/MDIX technology.

The function of each STM600 LED is described in the following table:

Table 4. LED Descriptions for the STM600

Object	Activity	Description
Power	On (green)	Power is supplied to the STM.
	Off	Power is not supplied to the STM.
Status	On (amber) during startup	The STM is initializing. After approximately 2 minutes, when the STM has completed its initialization, the Status LED turns off. If the Status LED remains on, the initialization has failed.
	Off	The system has completed its initialization successfully. The Status LED should be off during normal operation.
	Blinking (amber)	The STM is shutting down.
		Software is being updated.
A hotfix is being installed.		
		One of the three licenses has expired. To stop the Status LED from blinking, renew the license, or click the Stop LED Blinking button on the System Status screen (see Viewing System Status on page 192).
HDD	On (green)	Information is being written to the hard drive.
	Off	No hard drive activity.
Uplink (WAN) Port		
Left LED	Off	The WAN port has no physical link, that is, no Ethernet cable is plugged into the STM.
	On (green)	The WAN port has a valid connection with a device that provides an Internet connection.
	Blink (green)	Data is being transmitted or received by the WAN port.
Right LED	Off	The WAN port is operating at 10 Mbps.
	On (green)	The WAN port is operating at 100 Mbps.
	On (amber)	The WAN port is operating at 1000 Mbps.
Downlink (LAN) Ports		
Left LED	Off	The LAN port has no link.
	On (green)	The LAN port has detected a link with a connected Ethernet device.
	Blink (green)	Data is being transmitted or received by the LAN port.
Right LED	Off	The LAN port is operating at 10 Mbps.
	On (green)	The LAN port is operating at 100 Mbps.
	On (amber)	The LAN port is operating at 1000 Mbps.

Rear Panel Features

The rear panel of the STM150 differs from the rear panels of the STM300 and STM600.

Rear Panel STM150

The following figure shows the rear panel components of the STM150:

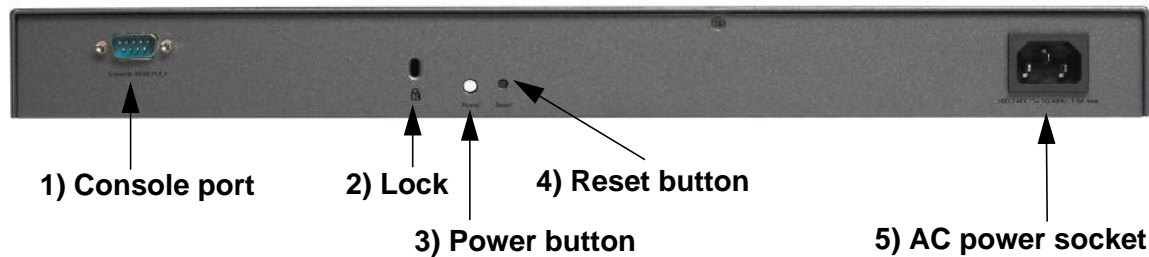

Figure 5.

From left to right, the STM150's rear panel components are:

1. Console port. Port for connecting to an optional console terminal. The port has a DB9 male connector. The default baud rate is 9600 K. The pinouts are (2) Tx, (3) Rx, (5) and (7) Gnd.
2. Kensington lock. Attach an optional Kensington lock to prevent unauthorized removal of the STM150.
3. Power button. Press to restart the STM150. Restarting does not reset the STM150 to its factory defaults.
4. Reset button. Using a sharp object, press and hold this button for about 10 seconds until the front panel Test LED flashes and the STM150 returns to factory default settings.

Note: If you reset the STM150, all configuration settings are lost and the default passwords are restored.

5. AC power socket. Attach the power cord to this socket.

Rear Panel STM300 and STM600

The rear panels of the STM300 and STM600 are identical.

The following figure shows the rear panel components of the STM300 and STM600:



Figure 6.

From left to right, the STM300's and STM600's rear panel components (excluding the four fan air outlets) are:

1. Power switch. Switch to turn the STM300 or STM600 on or off. Restarting does not reset the STM300 or STM600 to its factory defaults.

Note: The STM300 and STM600 do not provide a Reset button. For information about how to reset the STM300 or STM600 to factory default settings using the Web Management Interface, see [Reverting to Factory Default Settings](#) on page 70.

2. AC power socket. Attach the power cord to this socket.

Bottom Panel with Product Label

The product label on the bottom of the STM's enclosure displays the STM's default IP address, default user name, and default password, as well as regulatory compliance, input power, and other information.

STM150 Product Label



Figure 7.

STM300 Product Label



Figure 8.

STM600 Product Label



Figure 9.

Choosing a Location for the STM

The STM is suitable for use in an office environment where it can be freestanding (on its runner feet) or mounted into a standard 19-inch equipment rack. Alternatively, you can rack-mount the STM in a wiring closet or equipment room. A mounting kit, containing two mounting brackets and four screws, is provided in the STM package.

Consider the following when deciding where to position the STM:

- The unit is accessible and cables can be connected easily.
- Cabling is away from sources of electrical noise. These include lift shafts, microwave ovens, and air-conditioning units.
- Water or moisture cannot enter the case of the unit.
- Airflow around the unit and through the vents in the side of the case is not restricted. Provide a minimum of 25 mm or 1 inch clearance.
- The air is as free of dust as possible.
- Temperature operating limits are not likely to be exceeded. Install the unit in a clean, air-conditioned environment. For information about the recommended operating temperatures for the STM, see [Appendix B, Default Settings and Technical Specifications](#).

Using the Rack-Mounting Kit

Use the mounting kit for the STM to install the appliance in a rack. (A mounting kit is provided in the product package for the STM.) The mounting brackets that are supplied with the STM are usually installed before the unit is shipped out. If the brackets are not yet installed, attach them using the supplied hardware.



Figure 10.

Before mounting the STM in a rack, verify that:

- You have the correct screws (supplied with the installation kit).
- The rack onto which you will mount the STM is suitably located.

Using the Setup Wizard to Provision the STM in Your Network

2

This chapter describes provisioning the STM in your network. This chapter contains the following sections:

- *Choosing a Deployment Scenario* on this page
- *Understanding the Steps for Initial Connection* on page 27
- *Logging In to the STM* on page 28
- *Using the Setup Wizard to Perform the Initial Configuration* on page 32
- *Verifying Correct Installation* on page 49
- *Registering the STM with NETGEAR* on page 50
- *What to Do Next* on page 51

Choosing a Deployment Scenario

The STM is an inline transparent bridge appliance that can easily be deployed to any point on the network without the need for network reconfiguration or additional hardware.

The following are the most common deployment scenarios for the STM. Depending on your network environment and the areas that you want to protect, you can choose one or a combination of the deployment scenarios that are described in the following sections:

- *Gateway Deployment* on this page
- *Server Group* on page 26
- *Segmented LAN Deployment* on page 27

Gateway Deployment

In a typical gateway deployment scenario, a single STM appliance is installed at the gateway—between the firewall and the LAN core switch—to protect the network against all malware threats entering and leaving the gateway. Installing the STM behind the firewall protects it from denial of service (DoS) attacks.

The following figure shows a typical gateway deployment scenario:

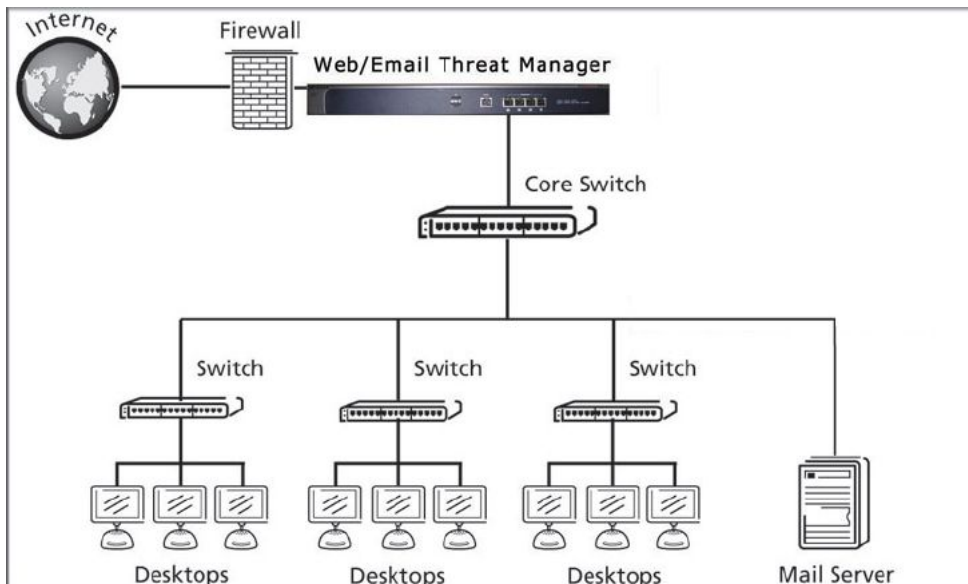

Figure 11.

Server Group

In a server group deployment, one STM appliance is installed at the gateway and another in front of the server group to help protect the email server from threats from internal as well as external clients. This type of deployment splits the network load and provides the email server with dedicated protection against malware threats, including email-borne viruses and spam. The following figure shows a typical server group deployment scenario:

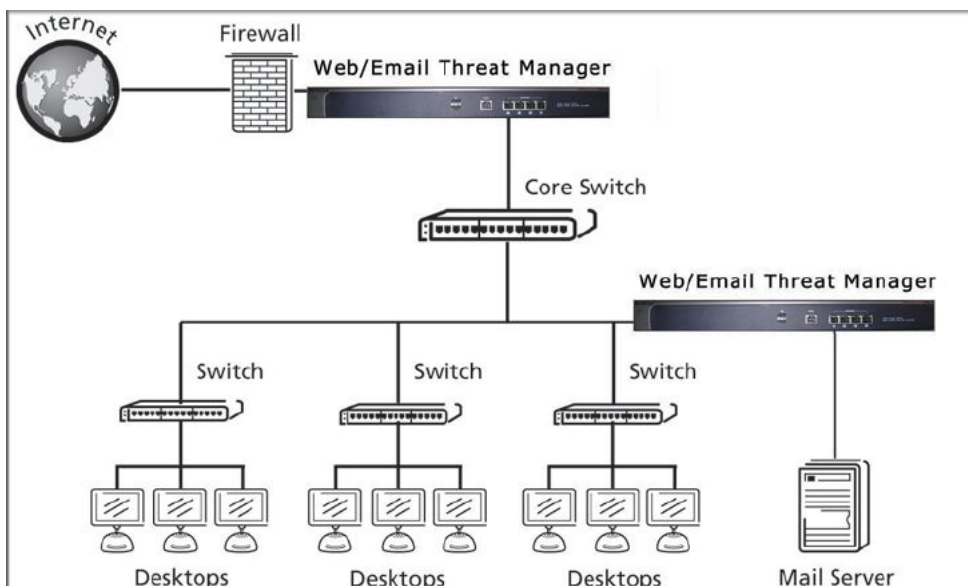

Figure 12.

Segmented LAN Deployment

In a segmented LAN deployment, one STM appliance is installed in front of each network segment. VLAN traffic can pass through the STM and can be scanned by the STM. This type of deployment splits the network load and protects network segments from malware threats coming in through the gateway or originating from other segments. The following figure shows a typical segmented LAN deployment scenario:

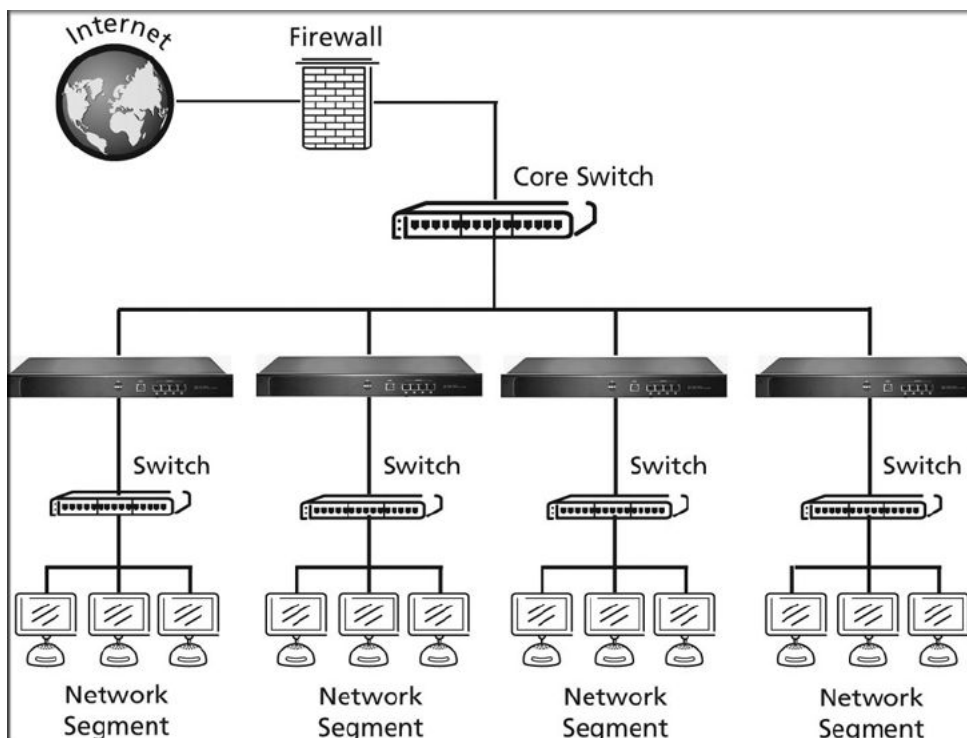

Figure 13.

Understanding the Steps for Initial Connection

Generally, five steps are required to complete the basic and security configuration of your STM:

1. **Connect the STM physically to your network.** Connect the cables and restart your network according to the instructions in the installation guide. See the *ProSecure™ Web/Email Security Threat Management Appliance STM150, STM300, or STM600 Installation Guide* for complete steps. A PDF of the *Installation Guide* is on the NETGEAR ProSecure™ website at <http://prosecure.netgear.com/resources/document-library.php>.
2. **Log in to the STM.** After logging in, you are ready to set up and configure your STM. See *Logging In to the STM* on page 28.
3. **Use the Setup Wizard to configure basic connections and security.** During this phase, you connect the STM to your network. See *Using the Setup Wizard to Perform the Initial Configuration* on page 32.

4. **Verify the installation.** See *Verifying Correct Installation* on page 49.
5. **Register the STM.** See *Registering the STM with NETGEAR* on page 50.

Each of these tasks is described separately in this chapter.

Qualified Web Browsers

To configure the STM, you need to use a Web browser such as Microsoft Internet Explorer 5.1 or later, Mozilla Firefox 1.x or later, or Apple Safari 1.2 or later with JavaScript, cookies, and SSL enabled.

Although these Web browsers are qualified for use with the STM's Web Management Interface, SSL VPN users should choose a browser that supports JavaScript, Java, cookies, SSL, and ActiveX to take advantage of the full suite of applications. Note that Java is required only for the SSL VPN portal, not for the Web Management Interface.

Logging In to the STM

To connect to the STM, your computer needs to be configured to obtain an IP address automatically from the STM via DHCP. For instructions on how to configure your computer for DHCP, see the document that you can access from *Preparing Your Network* in Appendix C.

To connect and log in to the STM:

1. Start any of the qualified browsers, as explained in *Qualified Web Browsers* on this page.
2. Enter **https://192.168.1.201** in the address field.



Figure 14.

Note: The STM factory default IP address is 192.168.1.201. If you change the IP address, you need to use the IP address that you assigned to the STM to log in to the STM.

The NETGEAR Configuration Manager Login screen displays in the browser (see the following figure, which shows the STM300).

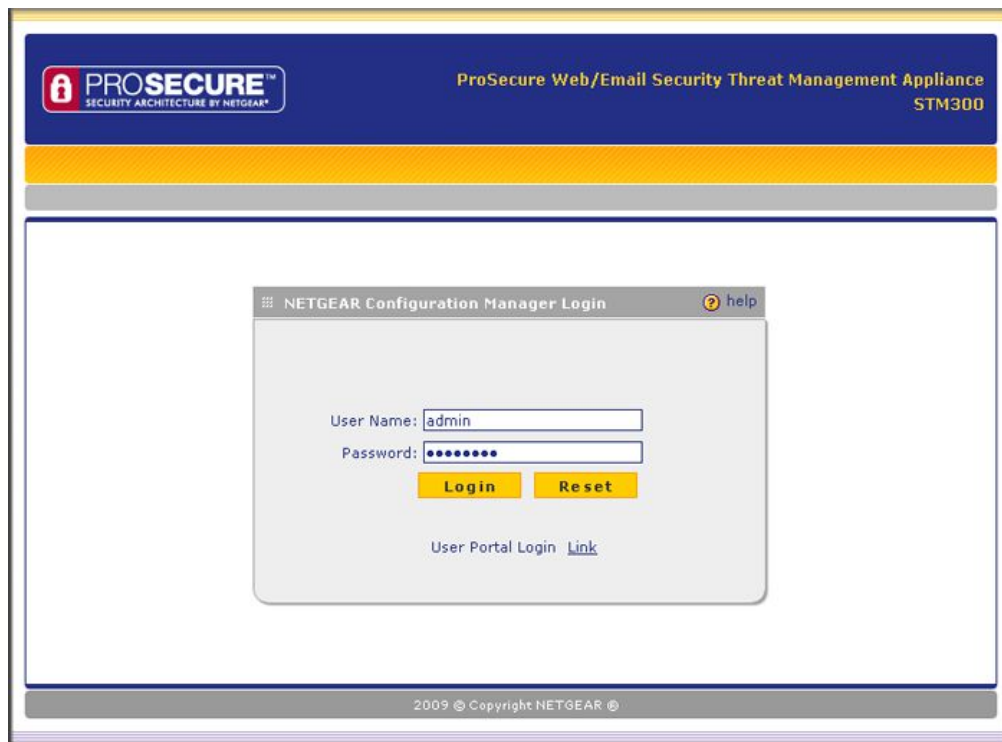

Figure 15.

3. In the User Name field, type **admin**. Use lowercase letters.
4. In the Password field, type **password**. Here, too, use lowercase letters.

Note: The STM user name and password are not the same as any user name or password you might use to log in to your Internet connection.

Note: The first time that you remotely connect to the STM with a browser via an SSL VPN connection, you might get a warning message regarding the SSL certificate. If you are using a Windows computer with Internet Explorer 5.5 or later, simply click **Yes** to accept the certificate. Other browsers provide you with similar options to accept and install the SSL certificate.

If you connect to the STM through the User Portal Login screen (see [Figure 88](#) on page 156), you can import the STM's root certificate by clicking the link at the bottom of the screen.

- Click **Login**. The Web Management Interface displays, showing the Dashboard screen (see the following figure, which shows only the top part of the screen). For information about this screen, see *Understanding the Information on the Dashboard Screen* on page 184.

Note: During the initial setup, the Setup Wizard displays when you first log in; afterward the login takes you to the Dashboard screen.

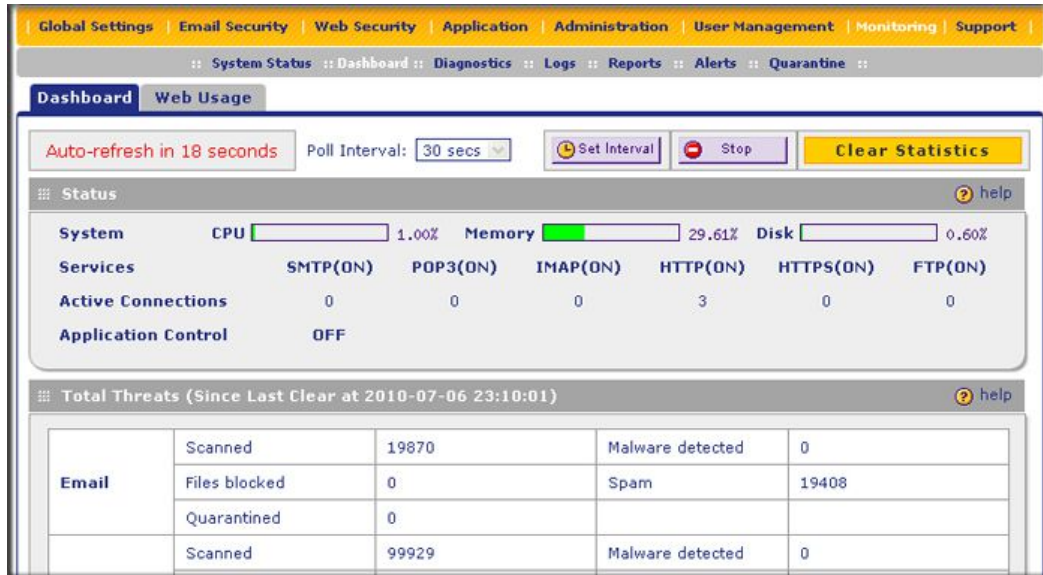

Figure 16.

Note: After 5 minutes of inactivity (the default login time-out), you are automatically logged out.

Understanding the Web Management Interface Menu Layout

The following figure shows the menu at the top of the STM300's Web Management Interface. The Web Management Interface layouts of the STM150 and STM600 are identical to the STM300.



Figure 17.

The Web Management Interface menu consists of the following components:

- **1st Level: Main navigation menu links.** The main navigation menu in the orange bar across the top of the Web Management Interface provides access to all the configuration functions of the STM, and remains constant. When you select a main navigation menu link, the letters are displayed in white against an orange background.
- **2nd Level: Configuration menu links.** The configuration menu links in the gray bar (immediately below the main navigation menu bar) change according to the main navigation menu link that you select. When you select a configuration menu link, the letters are displayed in white against a gray background.
- **3rd Level: Submenu tabs.** Each configuration menu item has one or more submenu tabs that are listed below the gray menu bar. When you select a submenu tab, the text is displayed in white against a blue background.

The bottom of each screen provides action buttons. The nature of the screen determines which action buttons are shown. The following figure shows an example:



Figure 18.

Any of the following action buttons might be displayed on screen (this list might not be complete):

- **Apply.** Save and apply the configuration.
- **Reset.** Reset the configuration to default values.
- **Test.** Test the configuration before you decide whether or not to save and apply the configuration.
- **Auto Detect.** Enable the STM to detect the configuration automatically and suggest values for the configuration.
- **Next.** Go to the next screen (for wizards).
- **Back.** Go to the previous screen (for wizards).
- **Search.** Perform a search operation.

- **Cancel.** Cancel the operation.
- **Send Now.** Send a file or report.

When a screen includes a table, table buttons are displayed to let you configure the table entries. The nature of the screen determines which table buttons are shown. The following figure shows an example:



Figure 19.

Any of the following table buttons might be displayed on screen:

- **Select All.** Select all entries in the table.
- **Delete.** Delete the selected entry or entries from the table.
- **Enable.** Enable the selected entry or entries in the table.
- **Disable.** Disable the selected entry or entries in the table.
- **Add.** Add an entry to the table.
- **Edit.** Edit the selected entry.
- **Up.** Move the selected entry up in the table.
- **Down.** Move the selected entry down in the table.

Almost all screens and sections of screens have an accompanying help screen. To open the help screen, click the question mark icon. (?).

Using the Setup Wizard to Perform the Initial Configuration

The Setup Wizard facilitates the initial configuration of the STM by taking you through 11 screens, the last of which allows you to save the configuration.

To start the Setup Wizard:

1. Select **Global Settings > Network Settings** from the menu. The Network Settings submenu tabs display with the Network Settings screen in view.
2. From the Network Settings configuration menu, select **Setup Wizard**.

The following sections explain the 11 configuration screens of the Setup Wizard. On the 10th screen, you can save your configuration. The 11th screen is just an informational screen.

The tables in the following sections explain the buttons and fields of the Setup Wizard screens. Additional information about the settings in the Setup Wizard screens is provided in other chapters that explain manual configuration; each following section provides a specific link to a section in another chapter.

Setup Wizard Step 1 of 10: Introduction

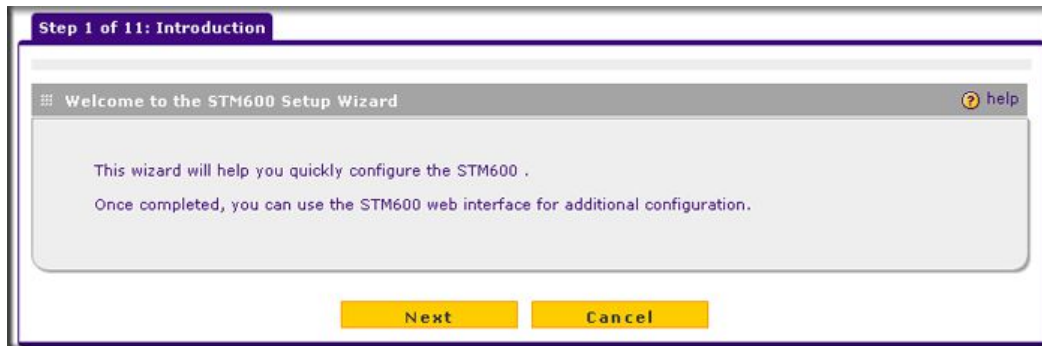

Figure 20.

The first Setup Wizard screen is just an introductory screen. Click **Next** to go to the following screen.

Setup Wizard Step 2 of 11: Networking Settings

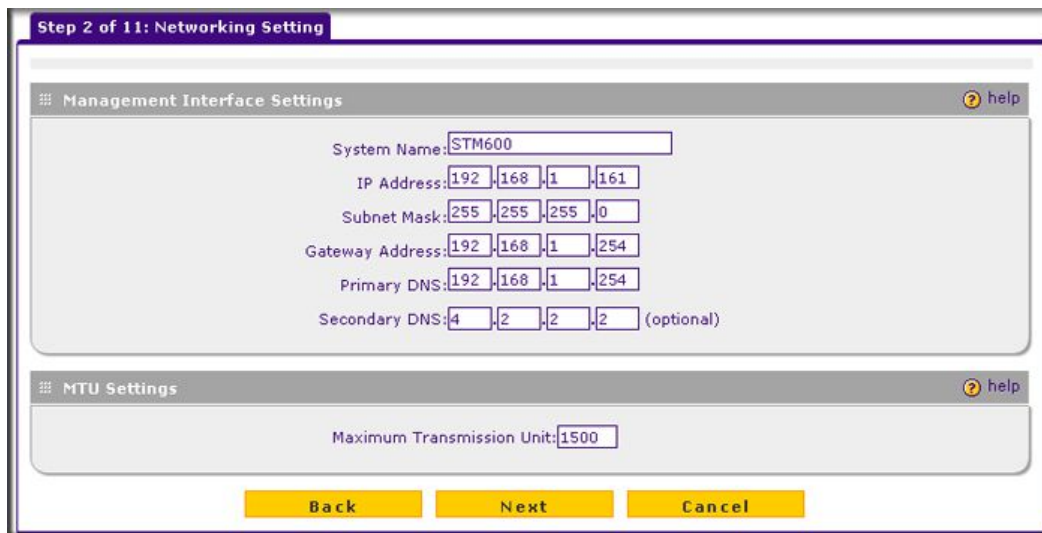

Figure 21.

Enter the settings as explained in the following table, and then click **Next** to go the following screen.

Note: After you have completed the steps in the Setup Wizard, you can make changes to the network settings by selecting **Global Settings > Network Settings**. For more information about these network settings, see *Configuring Network Settings* on page 52.

Table 5. Setup Wizard Step 2: Network Settings

Setting	Description (or Subfield and Description)
Management Interface Settings	
System Name	The name for the STM for purposes of identification and management. The default name is the name of your model (STM150, STM300, or STM600).
IP Address	Enter the IP address of the STM through which you will access the Web Management Interface. The factory default IP address is 192.168.1.201. Note: If you change the IP address of the STM while being connected through the browser, you will be disconnected. You then need to open a new connection to the new IP address and log in again. For example, if you change the default IP address from 192.168.1.201 to 10.0.0.1, you need to enter https://10.0.0.1 in your browser to reconnect to the Web Management Interface.
Subnet Mask	Enter the IP subnet mask. The subnet mask specifies the network number portion of an IP address. Unless you are implementing subnetting, use 255.255.255.0 as the subnet mask.
Gateway Address	Enter the IP address of the gateway through which the STM is accessed.
Primary DNS	Specify the IP address for the primary DNS server.
Secondary DNS	As an option, specify the IP address for the secondary DNS server.
MTU Settings	
Maximum Transmission Unit	The maximum transmission unit (MTU) is the largest physical packet size that a network can transmit. Packets that are larger than the MTU value are divided into smaller packets before they are sent, an action that prolongs the transmission process. For most Ethernet networks the MTU value is 1500 bytes, which is the default setting. Note: NETGEAR recommends synchronizing the STM's MTU setting with that of your network to prevent delays in transmission.

Setup Wizard Step 3 of 11: Time Zone

Figure 22.

Enter the settings as explained in the following table, and then click **Next** to go the following screen.

Note: After you have completed the steps in the Setup Wizard, you can make changes to the date and time by selecting **Administration > System Date & Time**. For more information about these settings, see *Configuring Date and Time Service* on page 74.

Table 6. Setup Wizard Step 3: System Date and Time Settings

Setting	Description (or Subfield and Description)
System Date and Time	
From the drop-down list, select an NTP server, or select to enter the time manually.	
Use Default NTP Servers	The STM regularly updates its real-time clock (RTC), which it uses for scheduling, by contacting a default NETGEAR NTP server on the Internet. This is the default setting.

Table 6. Setup Wizard Step 3: System Date and Time Settings (Continued)

Setting	Description (or Subfield and Description)	
Use Custom NTP Servers	<p>The STM regularly updates its RTC by contacting one of the two NTP servers (primary and backup), both of which you need to specify in the fields that become available when you select this option.</p> <p>Note: If you select this option but leave either the Server 1 or Server 2 field blank, both fields are automatically set to the default NETGEAR NTP servers.</p> <p>Note: A list of public NTP servers is available at http://support.ntp.org/bin/view/Servers/WebHome.</p>	
	Server 1 Name / IP Address	Enter the IP address or host name of the primary NTP server.
	Server 2 Name / IP Address	Enter the IP address or host name of the secondary NTP server.
Manually Enter the Date and Time	Date	Enter the date in the yyyy-mm-dd (year-month-date) format.
	Time	Enter the time in the hh-mm-ss (hour-minutes-seconds) format.
Time Zone		
<p>From the drop-down list, select the local time zone in which the STM operates. The correct time zone is required in order for scheduling to work correctly. You do not need to configure daylight savings time, which is applied automatically when applicable. Greenwich Mean Time (GMT) is the default setting.</p> <p>Note: When you select a time zone that is not associated with a location, such as (GMT -08:00) GMT-8, daylight savings time is automatically disabled. When you select a time zone that <i>is</i> associated with a location, such as (GMT -08:00) Pacific Time (US & Canada), daylight savings time is automatically enabled.</p>		

Setup Wizard Step 4 of 11: Email Security

Step 4 of 11: Email Security

Services to Scan help

Enable	Service	Ports to Scan
<input checked="" type="checkbox"/>	SMTP	25
<input checked="" type="checkbox"/>	POP3	110
<input checked="" type="checkbox"/>	IMAP	143

Scan Action help

Service	Action
SMTP	Block infected email
POP3	Delete attachment
IMAP	Delete attachment

Scan Exceptions help

Skip if the file or message is larger than KB (Maximum: 51200 KB)

Back **Next** **Cancel**

Figure 23.

Enter the settings as explained in the following table, and then click **Next** to go the following screen.

Note: After you have completed the steps in the Setup Wizard, you can make changes to the email security settings by selecting **Email Security > Policy** or **Email Security > Anti-Virus**. The Email Anti-Virus screen also lets you specify notification settings and email alert settings. For more information about these settings, see [Configuring Email Protection](#) on page 87.

Tip: To enhance performance, you can disable scanning of any protocols that are seldom or never used. Be mindful of the difference between user- and server-generated traffic. For example, your mail server might not use IMAP, but some users might configure IMAP clients.

Table 7. Setup Wizard Step 4: Email Security Settings

Setting	Description (or Subfield and Description)	
Services to Scan		
SMTP	SMTP scanning is enabled by default on standard service port 25.	To disable any of these services, clear the corresponding check box. You can change the standard service port or add another port in the corresponding Ports to Scan field.
POP3	POP3 scanning is enabled by default on standard service port 110.	
IMAP	IMAP scanning is enabled by default on standard service port 143.	
Scan Action		
SMTP	<p>From the SMTP drop-down list, specify one of the following actions to be taken when an infected email is detected:</p> <ul style="list-style-type: none"> • Quarantine attachment. The email is not blocked, but the attachment is removed and placed in the malware quarantine for further research. In addition, a malware quarantine log entry is created, and depending on the nature of the malware threat, also a virus log entry or a spyware log entry. • Delete attachment. The email is not blocked, but the attachment is deleted, and a virus log entry or a spyware log entry is created. • Block infected email. This is the default setting. The email is blocked, and a virus log entry or a spyware log entry is created. • Quarantine infected email. The email is placed in the malware quarantine for further research. In addition, a malware quarantine log entry is created, and depending on the nature of the malware threat, also a virus log entry or a spyware log entry. • Log only. Only a virus log entry or a spyware log entry is created. The email is not blocked and the attachment is not deleted. 	
POP3	<p>From the POP3 drop-down list, specify one of the following actions to be taken when an infected email is detected:</p> <ul style="list-style-type: none"> • Quarantine attachment. The email is not blocked, but the attachment is removed and placed in the malware quarantine for further research. In addition, a malware quarantine log entry is created, and depending on the nature of the malware threat, also a virus log entry or a spyware log entry. • Delete attachment. This is the default setting. The email is not blocked, but the attachment is deleted, and a virus log entry or a spyware log entry is created. • Log only. Only a virus log entry or a spyware log entry is created. The email is not blocked and the attachment is not deleted. 	
IMAP	<p>From the IMAP drop-down list, specify one of the following actions to be taken when an infected email is detected:</p> <ul style="list-style-type: none"> • Quarantine attachment. The email is not blocked, but the attachment is removed and placed in the malware quarantine for further research. In addition, a malware quarantine log entry is created, and depending on the nature of the malware threat, also a virus log entry or a spyware log entry. • Delete attachment. This is the default setting. The email is not blocked, but the attachment is deleted, and a virus log entry or a spyware log entry is created. • Log only. Only a virus log entry or a spyware log entry is created. The email is not blocked and the attachment is not deleted. 	

Table 7. Setup Wizard Step 4: Email Security Settings (Continued)

Setting	Description (or Subfield and Description)
Scan Exceptions	
<p>From the drop-down list, specify one of the following actions to be taken when an email attachment exceeds the size that you specify in the file size field:</p> <ul style="list-style-type: none"> • Skip. The file is not scanned but skipped, leaving the end user vulnerable. This is the default setting. • Block. The file is blocked and does not reach the end user. <p>The default and maximum file sizes are as follows:</p> <ul style="list-style-type: none"> • For the STM600, the default setting is to block any attachment larger than 10240 KB. The maximum file size that you can specify is 51200 KB. • For the STM300, the default setting is to block any attachment larger than 10240 KB. The maximum file size that you can specify is 25600 KB. • For the STM150, the default setting is to block any attachment larger than 8192 KB. The maximum file size that you can specify is 25600 KB. <p>Note: Setting the maximum file size to a high value might affect the STM's performance. NETGEAR recommends the default value, which is sufficient to detect the vast majority of threats.</p>	

Setup Wizard Step 5 of 11: Web Security

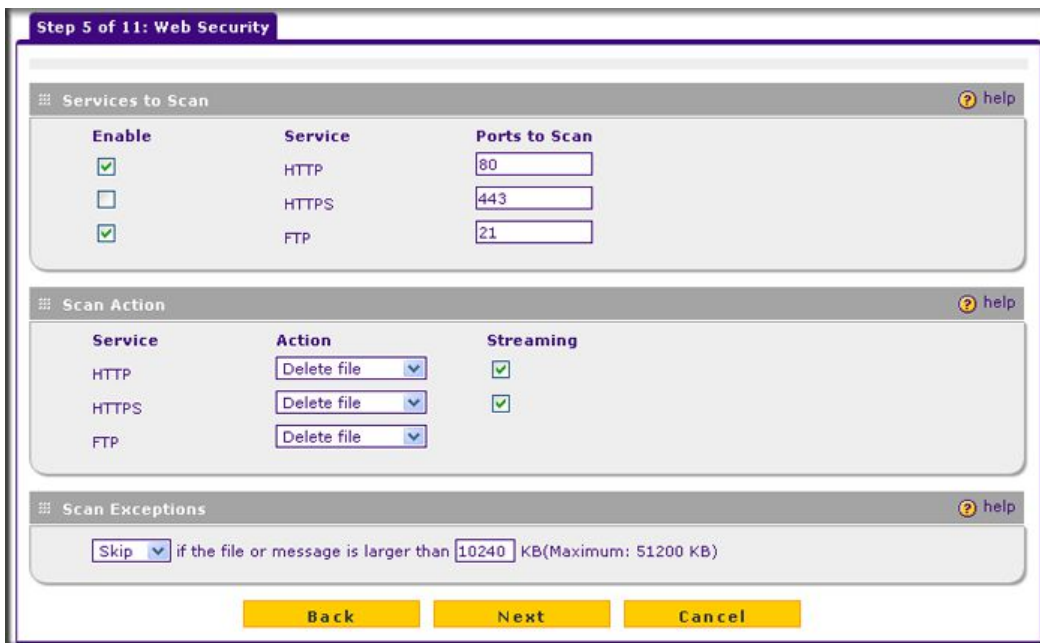

Figure 24.

Enter the settings as explained in the following table, and then click **Next** to go the following screen.

Note: After you have completed the steps in the Setup Wizard, you can make changes to the Web security settings by selecting **Web Security > Policy** or **Web Security > HTTP/HTTPS > Malware Scan**. The Malware Scan screen also lets you specify HTML scanning and notification settings. For more information about these settings, see *Configuring Web and Services Protection* on page 105.

Table 8. Setup Wizard Step 5: Web Security Settings

Setting	Description (or Subfield and Description)	
Services to Scan		
HTTP	HTTP scanning is enabled by default on standard service port 80.	To disable Hypertext Transfer Protocol (HTTP) scanning, clear the corresponding check box. You can change the standard service port or add another port in the corresponding Ports to Scan field.
HTTPS	HTTPS scanning is disabled by default.	To enable Hypertext Transfer Protocol over Secure Socket Layer (HTTPS) scanning, select the corresponding check box. You can change the standard service port (number 443) or add another port in the corresponding Ports to Scan field.
FTP	FTP scanning is enabled by default on standard service port 21.	To disable File Transfer Protocol (FTP) scanning, clear the corresponding check box. You can change the standard service port or add another port in the corresponding Ports to Scan field.
Scan Action		
HTTP	<p>From the HTTP drop-down list, specify one of the following actions to be taken when an infected Web file or object is detected:</p> <ul style="list-style-type: none"> • Quarantine file. The Web file or object is removed and placed in the malware quarantine for further research. In addition, a malware quarantine log entry is created, and depending on the nature of the malware threat, also a virus log entry or spyware log entry. • Delete file. This is the default setting. The Web file or object is deleted, and a virus log entry or spyware log entry is created. • Log only. Only a virus log entry or spyware log entry is created. The Web file or object is not deleted. <p>Select the Streaming check box to enable streaming of partially downloaded and scanned HTTP file parts to the end user. This method allows the user to experience more transparent Web downloading. Streaming is enabled by default.</p>	

Table 8. Setup Wizard Step 5: Web Security Settings (Continued)

Setting	Description (or Subfield and Description)
HTTPS	<p>From the HTTPS drop-down list, specify one of the following actions to be taken when an infected Web file or object is detected:</p> <ul style="list-style-type: none"> • Quarantine file. The Web file or object is removed and placed in the malware quarantine for further research. In addition, a malware quarantine log entry is created, and depending on the nature of the malware threat, also a virus log entry or spyware log entry. • Delete file. This is the default setting. The Web file or object is deleted, and a virus log entry or spyware log entry is created. • Log only. Only a virus log entry or spyware log entry is created. The Web file or object is not deleted. <p>Select the Streaming check box to enable streaming of partially downloaded and scanned HTTPS file parts to the end user. This method allows the user to experience more transparent Web downloading. Streaming is enabled by default.</p>
FTP	<p>From the FTP drop-down list, specify one of the following actions to be taken when an infected Web file or object is detected:</p> <ul style="list-style-type: none"> • Quarantine file. The Web file or object is removed and placed in the malware quarantine for further research. In addition, a malware quarantine log entry is created, and depending on the nature of the malware threat, also a virus log entry or spyware log entry. • Delete file. This is the default setting. The Web file or object is deleted, and a virus log entry or spyware log entry is created. • Log only. Only a virus log entry or spyware log entry is created. The Web file or object is not deleted.
Scan Exceptions	
<p>From the drop-down list, specify one of the following actions to be taken when a Web file or object exceeds the size that you specify in the file size field:</p> <ul style="list-style-type: none"> • Skip. The file is not scanned but skipped, leaving the end user vulnerable. This is the default setting. • Block. The file is blocked and does not reach the end user. <p>The default and maximum file sizes are as follows:</p> <ul style="list-style-type: none"> • For the STM600 and STM300, the default setting is to block any attachment larger than 10240 KB. The maximum file size that you can specify is 51200 KB. • For the STM150, the default setting is to block any attachment larger than 8192 KB. The maximum file size that you can specify is 25600 KB. <p>Note: Setting the maximum file size to a high value might affect the STM's performance. NETGEAR recommends the default value, which is sufficient to detect the vast majority of threats.</p>	

Setup Wizard Step 6 of 11: Email Notification Server Settings

Figure 25.

Enter the settings as explained in the following table, and then click **Next** to go the following screen.

Note: After you have completed the steps in the Setup Wizard, you can make changes to the administrator email notification settings by selecting **Global Settings > Email Notification Server**. For more information about these settings, see [Configuring the Email Notification Server](#) on page 176.

Table 9. Setup Wizard Step 6: Email Notification Server Settings

Setting	Description (or Subfield and Description)				
Email Notification Server Settings					
Show as Mail Sender	A descriptive name of the sender for email identification purposes. For example, enter stm600notification@netgear.com.				
Send Notifications to	The email address to which the notifications should be sent. Typically, this is the email address of a user with administrative privileges.				
SMTP Server	The IP address and port number or Internet name and port number of your ISP's outgoing email SMTP server. The default port number is 25. Note: If you leave this field blank, the STM cannot send email notifications.				
Mail Server Requires Authentication	If the SMTP server requires authentication, select the Mail Server Requires Authentication check box and enter the following settings:				
	<table border="1"> <tr> <td>User Name</td> <td>The user name for SMTP server authentication.</td> </tr> <tr> <td>Password</td> <td>The password for SMTP server authentication.</td> </tr> </table>	User Name	The user name for SMTP server authentication.	Password	The password for SMTP server authentication.
User Name	The user name for SMTP server authentication.				
Password	The password for SMTP server authentication.				

Setup Wizard Step 7 of 11: Update Settings

Step 7 of 11: Update Settings

System Information help

Component	Current Version	Last Update
Software	V3.0.0-43	2011-01-14
Scan Engine	V8.1.3.107	2010-12-07
Pattern File	201101172022	2011-01-18
OS	V1.2.0.1	2010-11-29
+ More		

Update Settings help

Update From

Default Update Server

Another Update Server

Server Address:

Update Component

Update Signature Patterns only

Update all Software and Signature Patterns

Update Frequency help

Weekly (hh:mm)

Daily (hh:mm)

Every

Back **Next** **Cancel**

Figure 26.

Enter the settings as explained in the following table, and then click **Next** to go the following screen.

Note: After you have completed the steps in the Setup Wizard, you can make changes to the security subscription update settings by selecting **Administration > Software Update**. For more information about these settings, see *Updating the Software* on page 71.

Table 10. Setup Wizard Step 7: Update Settings

Setting	Description (or Subfield and Description)		
System Information			
<p>You cannot configure this section; it is shown for information only. For the software, scan engine, (signature) pattern file, and operating system (OS), the current version and the date of the last update are displayed. Click + More to display the versions and most recent downloads for the antispam engine, applications engine, applications pattern file, stream engine, stream pattern file, mini engine, mini pattern file, policyd, scand, urld, update client, and rescue software.</p>			
Update Settings			
Update From	<p>Select one of the following radio buttons:</p> <ul style="list-style-type: none"> • Default Update Server. The scan engine and signatures are updated from the NETGEAR default update server. • Another Update Server. The scan engine and signatures are updated from a server that you specify by entering the server IP address or host name in the Server Address field. 		
	<table border="1"> <tr> <td>Server Address</td> <td>The update server IP address or host name.</td> </tr> </table>	Server Address	The update server IP address or host name.
Server Address	The update server IP address or host name.		
Update Component	<p>Make one of the following selections from the drop-down list:</p> <ul style="list-style-type: none"> • Update Signature Patterns only. Only the (signature) pattern file is updated. The software, scan engine, and OS are not updated. • Update all Software and Signature Patterns. The software, scan engine, (signature) pattern file, and OS are updated. This is the default setting. 		
Update Frequency			
<p>Make one of the following selections:</p> <ul style="list-style-type: none"> • Weekly. From the drop-down lists, specify the day, hour, and minutes that the update should occur. • Daily. From the drop-down lists, specify the hour and minutes that the update should occur. • Every. From the drop-down list, specify the frequency with which the update should occur. 			

Setup Wizard Step 8 of 11: HTTP Proxy Settings

Figure 27.

Enter the settings as explained in the following table, and then click **Next** to go the following screen.

Note: After you have completed the steps in the Setup Wizard, you can make changes to the security subscription update settings by selecting **Global Settings > HTTP Proxy**. For more information about these settings, see [Configuring the HTTP Proxy Settings](#) on page 60.

Table 11. Setup Wizard Step 8: HTTP Proxy Settings

Setting	Description (or Subfield and Description)
HTTPS Proxy Settings	
Use a Proxy Server to Connect to the Internet	If computers on the network connect to the Internet via a proxy server, select the Use a Proxy Server to Connect to the Internet check box to specify and enable a proxy server. Enter the following settings:
Proxy Server	The IP address and port number of the proxy server.
User Name	The user name for proxy server authentication.
Password	The password for proxy server authentication.

Setup Wizard Step 9 of 11: Web Categories



Figure 28.

Enter the settings as explained in the following table, and then click **Next** to go the following screen.

Note: After you have completed the steps in the Setup Wizard, you can make changes to the content filtering settings by selecting **Web Security > HTTP/HTTPS > Content Filtering**. The Content Filtering screen lets you specify additional filtering tasks and notification settings. For more information about these settings, see [Configuring Web Content Filtering](#) on page 109.

Table 12. Setup Wizard Step 9: Web Categories Settings

Setting	Description (or Subfield and Description)
Select the Web Categories You Wish to Block	
<p>Select the Enable Blocking check box to enable blocking of Web categories, which is the default setting. Select the check boxes of any Web categories that you want to block. Use the action buttons in the following way:</p> <ul style="list-style-type: none"> • Allow All. All Web categories are allowed. • Block All. All Web categories are blocked. • Set to Defaults. Blocking and allowing of Web categories are returned to their default settings. See Table 24 on page 85 for information about the Web categories that are blocked by default. Categories that are preceded by a green rectangle are allowed by default; categories that are preceded by a pink rectangle are blocked by default. 	

Setup Wizard Step 10 of 11: Configuration Summary

Step 10 of 11: Configuration Summary

Network Settings

System Name: STM600
 IP Address: 192.168.1.161
 Subnet Mask: 255.255.255.0
 Gateway IP Address: 192.168.1.254
 Primary DNS: 192.168.1.254
 Secondary DNS: 4.2.2.2
 Maximum Transmission Unit: 1500

System Date and Time

Use NTP Server: time-g.netgear.com,time-h.netgear.com
 Time Zone: (GMT) Greenwich Mean Time : Dublin, Edinburgh, Lisbon, London

Email Security

Status	Service	Ports To Scan	Action
Enable	SMTP	25	Block infected email
Enable	POP3	110	Delete attachment
Enable	IMAP	143	Delete attachment
Skip if a file or message is larger than:			10240 KB

Web Security

Status	Service	Ports To Scan	Action
Enable	HTTP	80	Delete file (Streaming)
Disable	HTTPS	443	Delete file (Streaming)
Enable	FTP	21	Delete file
Skip if a file or message is larger than:			10240 KB

Email Notification Server

Emails Sent As: stm600notification@netgear.com
 SMTP Server: 123.456.0.789
 Mail Recipients: admin@yourdomain.com

Update Settings

Update Server Address: update1.beta.netgear.com
 Update Component: Software and pattern
 Frequency: 1h

HTTP Proxy Settings

HTTP Proxy: Disable
 Proxy Server:

Blocked Web Categories

<input checked="" type="checkbox"/> Alcohol & Tobacco	<input checked="" type="checkbox"/> Anonymizers	<input checked="" type="checkbox"/> Botnets
<input checked="" type="checkbox"/> Child Abuse Images	<input checked="" type="checkbox"/> Criminal Activity	<input checked="" type="checkbox"/> Gambling
<input checked="" type="checkbox"/> Games	<input checked="" type="checkbox"/> Hacking	<input checked="" type="checkbox"/> Hate & Intolerance
<input checked="" type="checkbox"/> Illegal Drug	<input checked="" type="checkbox"/> Illegal Software	<input checked="" type="checkbox"/> Malware
<input checked="" type="checkbox"/> Nudity	<input checked="" type="checkbox"/> Phishing & Fraud	<input checked="" type="checkbox"/> Pornography / Sexually Exploit
<input checked="" type="checkbox"/> School Cheating	<input checked="" type="checkbox"/> Sex Education	<input checked="" type="checkbox"/> Spam Sites
<input checked="" type="checkbox"/> Tasteless	<input checked="" type="checkbox"/> Uncategorized	<input checked="" type="checkbox"/> Violence
<input checked="" type="checkbox"/> Virus Infected / Compromised	<input checked="" type="checkbox"/> Weapons	

New settings will be applied after you click the 'Apply' button. System reboot is required for the new settings take effect. When the appliance finishes rebooting, please make sure it has Internet access and register management interface to activate your license keys or free trial.

Figure 29.

Click **Apply** to save your settings and automatically restart the system, or click **Back** to make changes to the configuration.

Setup Wizard Step 11 of 11: Restarting the System

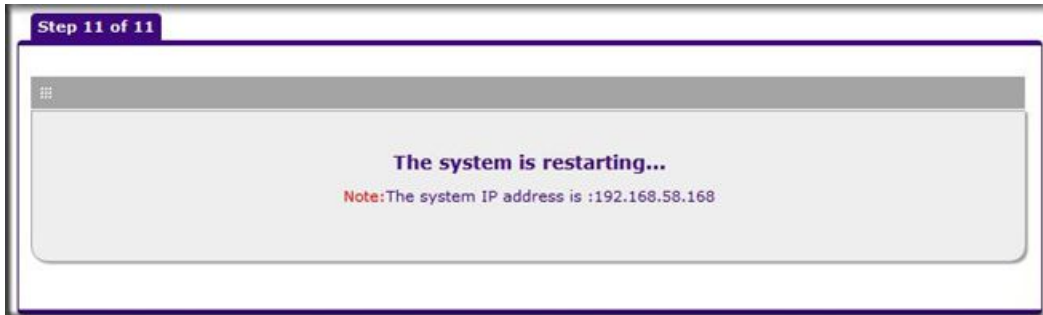

Figure 30.

Wizard screen 11 is just an informational screen to let you know that the system restarts automatically with the new configuration.

Verifying Correct Installation

Test the STM before deploying it in a live production environment. The following instructions walk you through a couple of quick tests designed to ensure that your STM is functioning correctly.

Testing Connectivity

Verify that network traffic can pass through the STM:

- Test an Internet URL (see *Testing a URL* on page 217).
- Ping the IP address of a device on either side of the STM.

Testing HTTP Scanning

If client computers have direct access to the Internet through your LAN, try to download the eicar.com test file from <http://www.eicar.org/download/eicar.com>.

The eicar.com test file is a legitimate DoS program and is safe to use because it is not a malware threat and does not include any fragments of malware code. The test file is provided by EICAR, an organization that unites efforts against computer crime, fraud, and misuse of computers or networks.

Verify that the STM correctly scans HTTP traffic:

1. Log in to the STM Web Management Interface, and then verify that HTTP scanning is enabled. For information about how to enable HTTP scanning, see *Customizing Web Protocol Scan Settings* on page 105.
2. Check the downloaded eicar.com test file, and note the attached malware information file.

Registering the STM with NETGEAR

To receive threat management component updates and technical support, you need to register your STM with NETGEAR. The support registration keys are provided with the product package (see *Service Registration Card with License Keys* on page 12).

The STM supports a bundle key, which is a single support registration key that provides all three licenses: Web protection, Email protection, and Support & Maintenance.

Note: Activating the service licenses initiates their terms of use. Activate the licenses only when you are ready to start using this unit. If your unit has never been registered before, you can use the 30-day trial period for all three types of licenses to perform the initial testing and configuration. To use the trial period, do *not* click **Register** in *step 5* of the following procedure but click **Trial** instead.

To activate the service licenses:

1. Ensure that your STM is connected to the Internet.
2. Select **Support > Registration** from the menu. The Registration screen displays:

The screenshot shows the 'Registration' screen in the Netgear web interface. At the top, there is a navigation menu with options: Global Settings, Email Security, Web Security, Application, Administration, User Management, Monitoring, and Support. Below this is a sub-menu: Online Support, Hot Fixes, Malware Analysis, Registration, Knowledge Base, and Documentation. The main content area is titled 'Registration' and contains an 'Online Registration' window. This window has a 'Registration Key' input field and a table of license keys. Below the table are sections for 'Customer Information' and 'VAR Information', each with fields for Company Name, First Name, Last Name, Email Address, Fax Number, Phone Number, Address, and Country (a dropdown menu currently set to 'United States'). At the bottom of the window are two buttons: 'Trial' and 'Register'.

License Key	License Type	Expiration Date
NG2002-XXXX-XXXX-XXXX-XXXX-XXXX-XXXX-XXXX-XXXX	Web Protection	2010-07-21
NG2001-XXXX-XXXX-XXXX-XXXX-XXXX-XXXX-XXXX-XXXX	Email Protection	2010-07-21
NG2000-XXXX-XXXX-XXXX-XXXX-XXXX-XXXX-XXXX-XXXX	Support & Maintenance	2010-07-21

Figure 31.

3. In the Registration Key field, enter the license key.
4. Fill out the customer and VAR fields.
5. Click **Register**.
6. Repeat [step 3](#) and [step 5](#) for additional license keys.

The STM activates the licenses and registers the unit with the NETGEAR registration server.

Note: If you reset the STM to the original factory default settings after you have entered the license keys to activate the STM (see [Registering the STM with NETGEAR](#) on page 50), the license keys are erased. The license keys and the different types of licenses that are available for the STM are no longer displayed on the Registration screen. However, after you have reconfigured the STM to connect to the Internet and to the NETGEAR registration server, the STM retrieves and restores all registration information based on its MAC address and hardware serial number. You do not need to reenter the license keys or reactivate the STM.

What to Do Next

You have completed setting up and deploying the STM to the network. The STM is now set up to scan the protocols and services that you specified for malware threats and to perform updates based on the configured update source and frequency.

If you need to change the settings, or to view reports or logs, log in to the STM Web Management Interface, using the default IP address or the IP address that you assigned to the STM in [Setup Wizard Step 1 of 10: Introduction](#) on page 33.

The STM is ready for use. However, the following sections describe some important tasks that you might want to address before you deploy the STM in your network:

- [Changing Administrative Passwords and Timeouts](#) on page 62
- [Managing Digital Certificates](#) on page 76
- [Configuring Groups](#) on page 148
- [Configuring User Accounts](#) on page 152
- [Configuring Authentication](#) on page 154
- [Setting Scanning Exclusions and Web Access Exceptions](#) on page 130

Performing Network and System Management

3

This chapter describes the network settings, the system management features, and ways to improve the performance of the STM. If you have used the Setup Wizard, you have already configured some of these settings, but there are situations in which you might want to modify them. This chapter contains the following sections:

- [Configuring Network Settings](#) on this page
- [Configuring Session Limits and Timeouts](#) on page 56
- [Configuring the Network Refresh and Permanent MAC Address Bindings](#) on page 57
- [Configuring the HTTP Proxy Settings](#) on page 60
- [About Users with Administrative and Guest Privileges](#) on page 61
- [Configuring Remote Management Access](#) on page 64
- [Using an SNMP Manager](#) on page 65
- [Managing the Configuration File](#) on page 67
- [Updating the Software](#) on page 71
- [Configuring Date and Time Service](#) on page 74
- [Managing Digital Certificates](#) on page 76
- [Managing the Quarantine Settings](#) on page 81
- [Managing the STM's Performance](#) on page 82

Configuring Network Settings

If you have used the Setup Wizard, you might already have configured the Web Management Interface and maximum transmission unit (MTU) settings; the Network Settings screen allows you to modify these settings and to specify the interface speed and duplex settings.

The STM requires a valid IP address to retrieve online updates and to enable access to its Web Management Interface. If you have used the Setup Wizard to configure the STM, you have already specified the management interface name and address settings and the size of the MTU. In addition to modifying these settings, the Network Settings screen also allows you to specify the interface speed and duplex settings for the management interface, for the

STM600 or STM300 uplink and downlink interfaces, or for the STM150's WAN and LAN interfaces.

To configure the STM's network settings:

1. Select **Global Settings > Network Settings** from the menu. The Network Settings submenu tabs display with the Network Settings screen in view. (The following figure shows the STM600.)

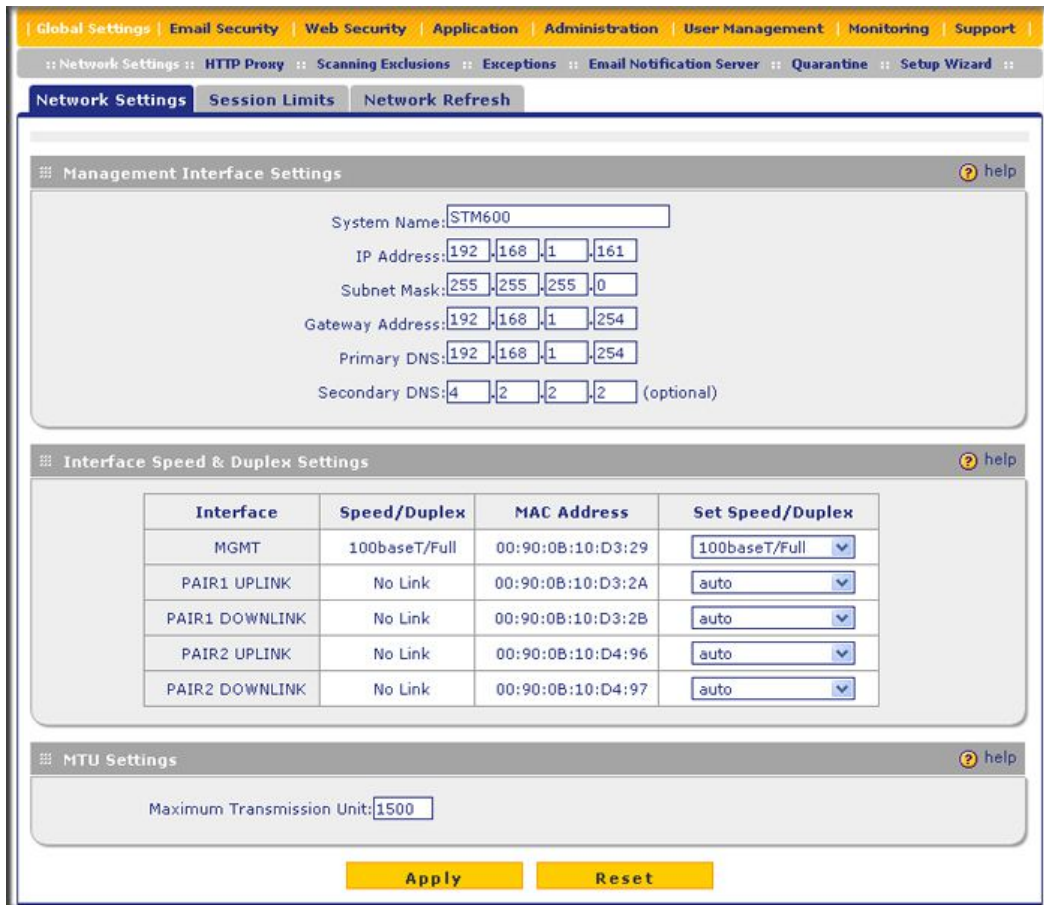

Figure 32. STM600

The following figure shows the Interface Speed & Duplex Settings section of the Network Settings screen of the STM300:

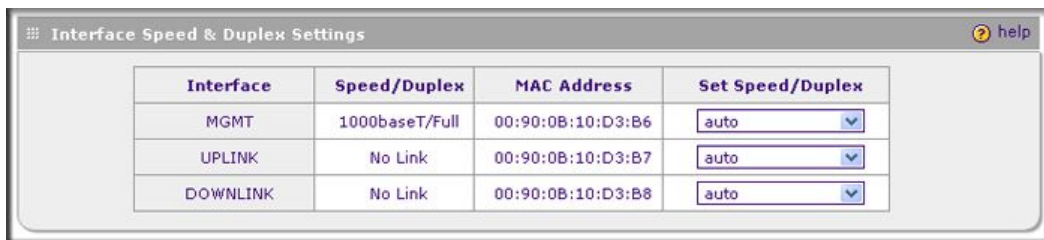

Figure 33. STM300

The following figure shows the Interface Speed & Duplex Settings section of the Network Settings screen of the STM150:

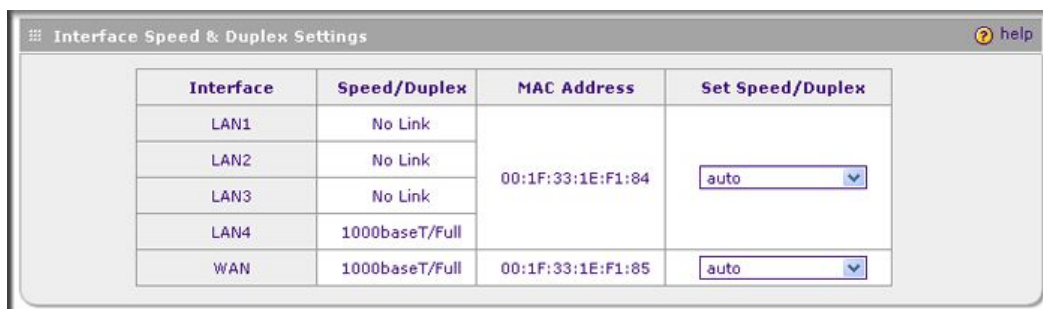

Figure 34. STM150

- Complete the fields and make your selections from the drop-down lists as explained in the following table:

Table 13. Network Settings

Setting	Description (or Subfield and Description)
Management Interface Settings	
System Name	The name for the STM for purposes of identification and management. The default name is the name of your model (STM150, STM300, or STM600).
IP Address	Enter the IP address of the STM through which you will access the Web Management Interface. The factory default IP address is 192.168.1.201. Note: If you change the IP address of the STM while being connected through the browser, you will be disconnected. You then need to open a new connection to the new IP address and log in again. For example, if you change the default IP address from 192.168.1.201 to 10.0.0.1, you need to enter https://10.0.0.1 in your browser to reconnect to the Web Management Interface.
Subnet Mask	Enter the IP subnet mask. The subnet mask specifies the network number portion of an IP address. Unless you are implementing subnetting, use 255.255.255.0 as the subnet mask.
Gateway Address	Enter the IP address of the gateway through which the STM is accessed.
Primary DNS	Specify the IP address for the primary DNS server IP address.
Secondary DNS	As an option, specify the IP address for the secondary DNS server IP address.
Interface Speed & Duplex Settings	
These sections show the MAC address and assigned speed and duplex setting for each active interface. The Set Speed/Duplex drop-down list allows you to select the speed and duplex setting for each active interface. To set the speed to 1000baseT duplex ("full"), select auto to let the STM sense the speed automatically.	
Note: MGMT stands for management interface.	

Table 13. Network Settings (Continued)

Setting	Description (or Subfield and Description)	
STM600 (see <i>Figure 32</i> on page 53)	MGMT	From the Set Speed/Duplex drop-down list, make one of the following selections: <ul style="list-style-type: none"> • auto. Speed autosensing. This is the default setting. • 10baseT/Half. Ethernet speed at half duplex. • 10baseT/Full. Ethernet speed at full duplex. • 100baseT/Half. Fast Ethernet speed at half duplex. • 100baseT/Full. Fast Ethernet speed at full duplex.
	PAIR1 UPLINK	
	PAIR1 DOWNLINK	
	PAIR2 UPLINK	
	PAIR2 DOWNLINK	
STM300 (see <i>Figure 33</i> on page 53)	MGMT	From the Set Speed/Duplex drop-down list, make one of the following selections: <ul style="list-style-type: none"> • auto. Speed autosensing. This is the default setting. • 10baseT/Half. Ethernet speed at half duplex. • 10baseT/Full. Ethernet speed at full duplex. • 100baseT/Half. Fast Ethernet speed at half duplex. • 100baseT/Full. Fast Ethernet speed at full duplex.
	UPLINK	
	DOWNLINK	
STM150 (see <i>Figure 34</i> on page 54)	LAN1	From the Set Speed/Duplex drop-down list, make one of the following selections: <ul style="list-style-type: none"> • auto. Speed autosensing. This is the default setting, which can sense 1000BaseT speed at full duplex. • 10baseT/Half. Ethernet speed at half duplex. • 10baseT/Full. Ethernet speed at full duplex. • 100baseT/Half. Fast Ethernet speed at half duplex. • 100baseT/Full. Fast Ethernet speed at full duplex. <p>Note: All LAN interfaces share the same MAC address, speed, and duplex mode.</p> <p>Note: The STM150 does not provide a dedicated management interface.</p>
	LAN2	
	LAN3	
	LAN4	
	WAN	
MTU Settings		
Maximum Transmission Unit	The maximum transmission unit (MTU) is the largest physical packet size that a network can transmit. Packets that are larger than the MTU value are divided into smaller packets before they are sent, an action that prolongs the transmission process. For most Ethernet networks the MTU value is 1500 bytes, which is the default setting. <p>Note: NETGEAR recommends synchronizing the STM's MTU setting with that of your network to prevent delays in transmission.</p>	

- Click **Apply** to save your settings. (If you click **Reset**, the STM restarts to restore the default network settings.) Changing the network settings has the following consequences:
 - Changing any of the settings in the Management Interface Settings section of the screen causes the STM to restart.
 - Changing any of the settings in the Interface Speed & Duplex Settings section of the screen causes the network to restart.
 - Changing the MTU setting causes services such as HTTP and SMTP to restart.

Configuring Session Limits and Timeouts

The Session Limits screen allows you to specify the total number of sessions per user (that is, per IP address or single source machine) that are allowed on the STM. Session limiting is disabled by default. When session limiting is enabled, you can specify the maximum number of sessions per user either as an absolute number or as a percentage of the STM's total connection capacity per user, which is 10000 sessions. (You cannot change the total connection capacity per user.) If a user exceeds the number of allocated sessions, packets might be dropped.

Note: Some protocols such as FTP and RSTP create two sessions per connection.

To configure session limits and timeouts:

1. Select **Global Settings > Network Settings** from the menu. The Network Settings submenu tabs display with the Network Settings screen in view.
2. Click the **Session Limits** submenu tab. The Session Limits screen displays:

Figure 35.

3. Select the radio buttons, make your selections from the drop-down list, and complete the fields as explained in the following table:

Table 14. Session Limits Settings

Setting	Description (or Subfield and Description)
Session Limits	
Do You Want to Enable per-user Session Limits?	Select the Yes radio button to enable session limits, and then fill in the Limit Type and Limit Value fields. The No radio button is selected by default.
Limit Type	From the Limit Type drop-down list, make one of the following selections: <ul style="list-style-type: none"> • Percentage of Maximum Sessions. Session limits are set as a percentage of the total connection capacity per user. • Sessions per User. Session limits are set as an absolute number.
Limit Value	Depending on the selection in the Limit Type field, this value is a percentage or an absolute number.
	The Total Number of Packets Dropped field, which you cannot configure, shows the total number of packets that are dropped because the session limit has been exceeded.
Session Timeouts	
If a session goes without data flow longer than the configured values, the session is terminated.	
TCP Timeout	The time in seconds after which a TCP session without data flow is terminated. The default time is 1200 seconds.
UDP Timeout	The time in seconds after which an UDP session without data flow is terminated. The default time is 180 seconds.
ICMP Timeout	The time in seconds after which an ICMP session without data flow is terminated. The default time is 8 seconds.

4. Click **Apply** to save your settings. Changing any settings in the Session Timeouts section of the screen requires the STM to restart. If you click **Reset**, the STM restarts to restore the default network settings.

Configuring the Network Refresh and Permanent MAC Address Bindings

The STM integrates smart virtual MAC address detection to automatically detect virtual MAC addresses and bind these to an interface. When the network topology changes, a virtual MAC address might no longer be bound to the original interface. If this situation occurs, the host to which the virtual MAC address is assigned is no longer able to communicate with others through the STM. Therefore, the network need to be refreshed to enable the STM to redetect the virtual MAC address on the correct interface.

To refresh the network and view the MAC Address Bindings table:

1. Select **Global Settings > Network Settings** from the menu. The Network Settings submenu tabs display with the Network Settings screen in view.
2. Click the **Network Refresh** submenu tab. The Network Refresh screen displays. (The following figure shows the STM150.)

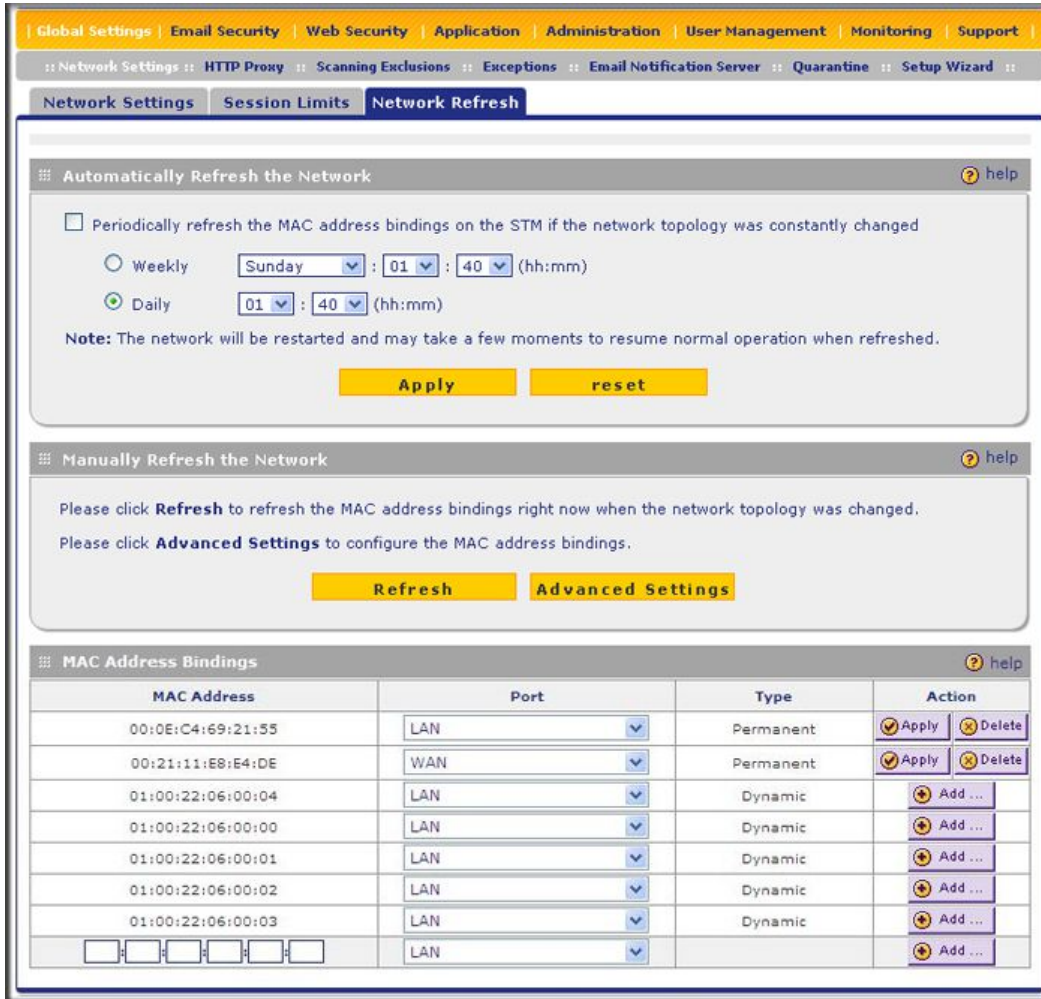

Figure 36.

3. Select the check boxes and radio buttons and make your selections from the drop-down list as explained in the following table:

Table 15. Network Refresh Settings

Setting	Description (or Subfield and Description)	
Automatically Refresh the Network		
Periodically refresh the MAC address bindings	Select this check box to enable the periodic refresh of the dynamic MAC address bindings. Specify if the refresh occurs either weekly or daily.	
	Weekly	Select the Weekly radio button to enable a weekly refresh of the network, and then specify when the refresh needs to occur by selecting the day, hour, and minutes from the drop-down lists.
	Daily	Select the Daily radio button to enable a daily refresh of the network, and then specify when the refresh needs to occur by selecting the hour and minutes from the drop-down lists.
Click Apply to schedule the automatic refresh of the network, or click Reset to return to the default settings.		
Manually Refresh the Network		
Click Refresh to immediately refresh the network.		
Note: When you click Refresh , the network restarts.		
Note: The Advanced Settings button is described in the following section.		

Managing Permanent MAC Address Bindings

You can permanently bind a MAC address to an interface. Such a binding does not change when the network topology changes and does not need to be redetected by the STM.

To create a permanent MAC binding:

1. Select **Global Settings > Network Settings** from the menu. The Network Settings submenu tabs display with the Network Settings screen in view.
2. Click the **Network Refresh** submenu tab. The Network Refresh screen displays (see the previous figure, which shows the STM150). Locate the Manually Refresh the Network section.
3. Click the **Advanced Settings** button. The screen expands to display the MAC Address Bindings section.

- Complete the fields and make your selections from the drop-down lists as explained in the following table:

Table 16. MAC Address Binding Settings

Setting	Description
MAC Address	Enter the MAC address that you want to bind permanently.
Port (STM150) or Interface (STM300 and STM600)	From the drop-down list, select the interface to which the MAC address needs to be bound.
Type	This field is automatically determined: it displays Permanent or Dynamic.

- To add the newly configured MAC address binding to the MAC Address Bindings table, click the **Add** table button in the Action column.

The MAC Address Bindings table displays both the dynamic bindings that are automatically detected by the STM and the permanent bindings that you have created.

Changing a Dynamic MAC Address Binding to a Permanent Binding

To change a dynamic binding to a permanent binding:

- Locate the dynamic MAC address binding that you want bind permanently, and select an interface from the Port drop-down list (STM150) or Interface drop-down list (STM300 and STM600).
- Click the corresponding **Add** table button in the Action column.

Activating, Editing, or Deleting a Permanent MAC Address Binding

For each permanent binding in the MAC Address Bindings table, the Action column provides two table buttons:

- Apply.** Activates the permanent MAC address binding.
- Delete.** Deletes the permanent MAC address binding from the table.

To assign another interface to a permanent MAC address binding:

- Locate the dynamic MAC address binding that you want to edit, and select another interface from the Port drop-down list (STM150) or Interface drop-down list (STM300 and STM600).
- Click **Apply** to save your changes.

Configuring the HTTP Proxy Settings

If you have used the Setup Wizard, you might have already configured an HTTP proxy; the HTTP Proxy screen allows you to modify these settings. If the STM is installed behind an HTTP proxy, you might need to specify the HTTP proxy settings for the STM to connect to the

Internet. The settings on the HTTP Proxy screen affect Web category filtering, distributed spam analysis, and software updates.

To configure the HTTP proxy:

1. Select **Global Settings > HTTP Proxy** from the menu. The HTTP Proxy screen displays:

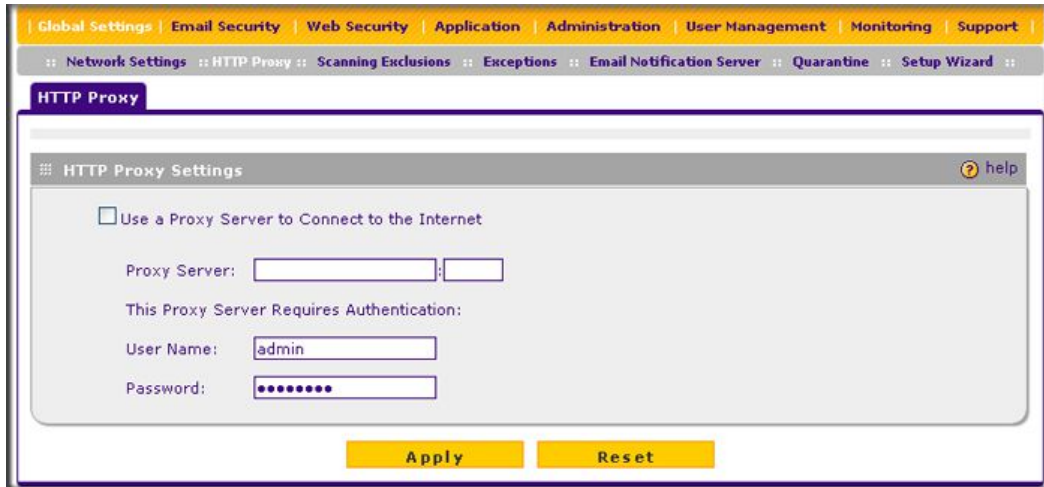

Figure 37.

2. Select the check box and complete the fields as explained in the following table:

Table 17. HTTP Proxy Settings

Setting	Description (or Subfield and Description)
HTTPS Proxy Settings	
Use a Proxy Server to Connect to the Internet	If computers on the network connect to the Internet via a proxy server, select the Use a Proxy Server to Connect to the Internet check box to specify and enable a proxy server. Enter the following settings:
Proxy Server	The IP address and port number of the proxy server.
User Name	The user name for proxy server authentication.
Password	The password for proxy server authentication.

3. Click **Apply** to save your settings.

About Users with Administrative and Guest Privileges

There are two predefined user types that can access the STM's Web Management Interface:

- **Administrator.** A user who has full access and the capacity to change the STM configuration (that is, read/write access). The default user name for an administrator is admin, and the default password for an administrator is password.

- **Guest user.** A user who can only view the STM configuration (that is, read-only access). The default user name for a guest is guest, and the default password for a guest is guest.

NETGEAR recommends that you change these passwords to more secure passwords.

The login window that is presented to the administrator and guest user is the NETGEAR Configuration Manager Login screen (see [Figure 87](#) on page 155).

Changing Administrative Passwords and Timeouts

In addition to changing the default password for the administrator and guest user, you can use the Set Password screen to change the account names, and modify the Web Management Interface timeout setting.

Note: The ideal password should contain no dictionary words from any language, and should be a mixture of letters (both uppercase and lowercase), numbers, and symbols. The password can be up to 64 characters.

To modify the administrator and guest accounts, and to modify the Web Management Interface timeout setting:

1. Select **Administration > Set Password** from the menu. The Set Password screen displays:

Figure 38.

- To modify the administrator or guest settings, select the check box and complete the fields as explained in the following table:

Table 18. Set Password Settings Screen: Administrator and Guest Settings

Setting	Description (or Subfield and Description)
User Selection	
Select one of the following radio buttons:	
<ul style="list-style-type: none"> • Edit Administrator Settings. Allows you to modify the administrator settings, while the guest settings are masked out. • Edit Guest Settings. Allows you to modify the guest settings, while the administrator settings are masked out. 	
Administrator Settings/Guest Setting	
New User Name	The default user name. For the administrator account, the default name is admin; for the guest account, the default name is guest.
Old Password	The current (factory default) password.
New Password	Enter the new password.
Retype New Password	Confirm the new password.

- Under the Administrator Settings and Guest Settings sections of the screen, click **Apply** to save your settings.
- If you modified the administrator settings and now want to modify the guest settings, or the other way around, repeat [step 2](#) and [step 3](#) for the other settings.
- To modify the Web Management Interface timeout settings, complete the field as explained in the following table:

Table 19. Set Password Settings Screen: Web Interface Timeout Settings

Setting	Description (or Subfield and Description)
Web Interface Timeout	
Session Timeout	Enter the period in seconds after which the Web Management Interface is automatically logged off if no activity is detected. The default is 600 seconds. You can configure a session timeout from 30 seconds to 9999 seconds.

- Under the Web Interface Timeout section of the screen, click **Apply** to save your settings.

Note: After a factory default reset, the password and timeout values are changed back to password and 600 seconds (5 minutes), respectively.

Configuring Remote Management Access

An administrator can configure, upgrade, and check the status of the STM over the Internet via a Secure Sockets Layer (SSL) VPN connection.

You need to use an SSL VPN connection to access the STM from the Internet: type **https://** (not **http://**) followed by the STM's WAN IP address into your browser. For example, if the STM's WAN IP address is 172.16.0.123, type the following in your browser:
https://172.16.0.123.

The STM's remote login URL is:

https://<IP_address> or **https://<FullyQualifiedDomainName>**

Note: The STM is accessible to anyone who knows its IP address and default password. Because a malicious WAN user can reconfigure the STM and misuse it in many ways, NETGEAR highly recommends that you change the admin and guest default passwords before continuing (see *Changing Administrative Passwords and Timeouts* on page 62).

To configure remote management:

1. Select **Administration > Remote Management** from the menu. The Remote Management screen displays:

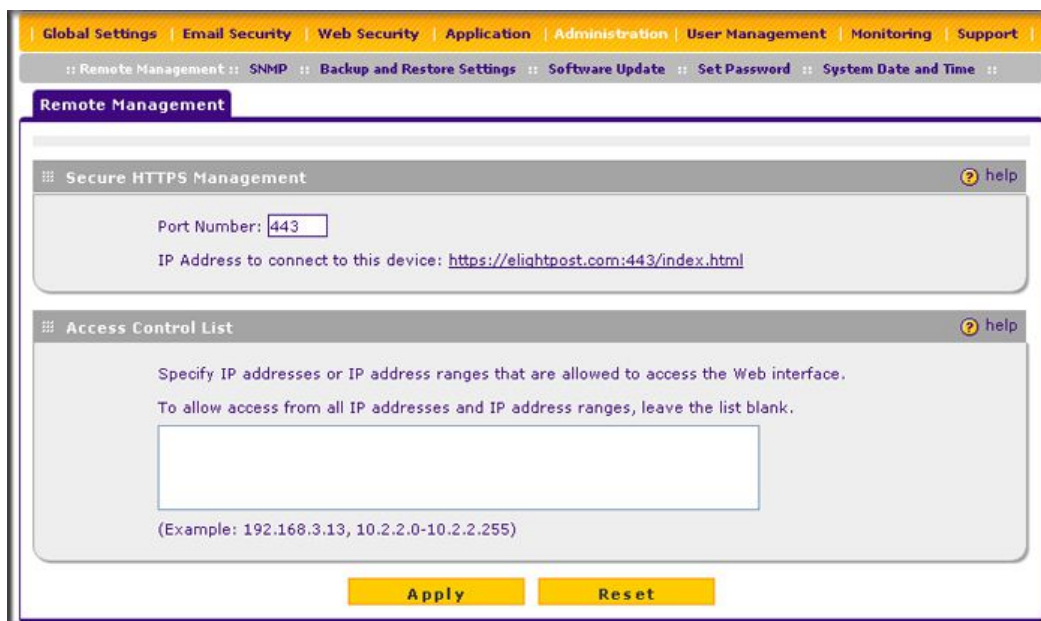

Figure 39.

2. In the Secure HTTPS Management section of the screen, enter number of the port that you want to use to access Web Management Interface of the STM. The default setting is port 443, but you can enter a port ranging from 1024 to 65535. You cannot use some ports such as 2080 and 8088 that might be used by the STM.

This section of the screen also displays the HTTPS hyperlink through which you can access the Web Management Interface of the STM. The hyperlink consists of the IP address or fully qualified domain name (FQDN) for the STM and the port number that you have assigned.

3. In the Access Control List section of the screen, you can specify IP addresses or IP address ranges that you want to grant access to the Web Management Interface for increased security. To specify a range, separate the beginning IP address and the ending IP address by a hyphen (-). To allow access from all IP addresses and IP address ranges, leave this field blank.
4. Click **Apply** to save your changes.

Note: To maintain security, the STM rejects a login that uses http://address rather than the SSL https://address.

Note: The first time that you remotely connect to the STM with a browser via an SSL VPN connection, you might get a warning message regarding the SSL certificate. If you are using a Windows computer with Internet Explorer 5.5 or later, simply click **Yes** to accept the certificate.

Using an SNMP Manager

Simple Network Management Protocol (SNMP) forms part of the Internet Protocol Suite as defined by the Internet Engineering Task Force (IETF). SNMP is used in network management systems to monitor network-attached devices for conditions that warrant administrative attention.

SNMP exposes management data in the form of variables on the managed systems, which describe the system configuration. These variables can then be queried (and sometimes set) by managing applications.

SNMP lets you monitor and manage your STM from an SNMP manager. It provides a remote means to monitor and control network devices, and to manage configurations, statistics collection, performance, and security. The STM provides support for report aggregation through SNMP version 1 (SNMPv1) and version 2 (SNMPv2).

To enable SNMP and to configure the SNMP settings:

1. Select **Administration > SNMP** from the menu. The SNMP screen displays:

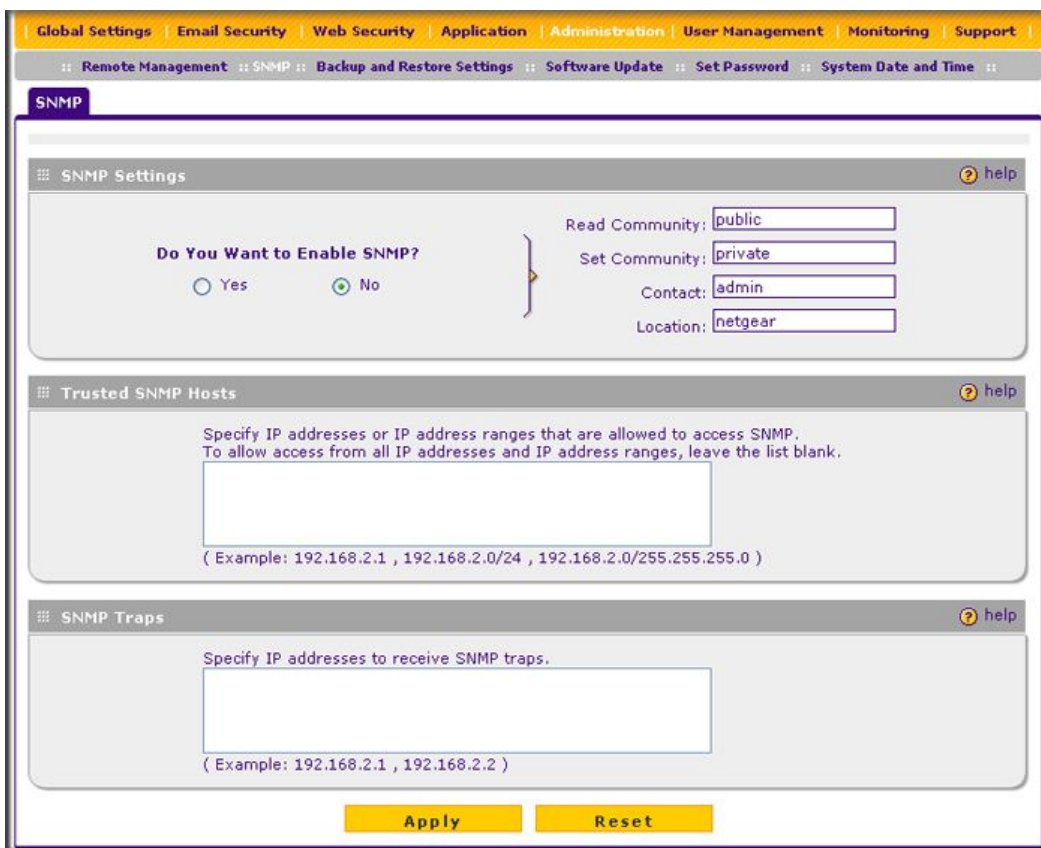

Figure 40.

2. Select the radio buttons and complete the fields as explained in the following table:

Table 20. SNMP Settings

Setting	Description (or Subfield and Description)
SNMP Settings	
Do You Want to Enable SNMP?	Select one of the following radio buttons: <ul style="list-style-type: none"> • Yes. Enable SNMP. • No. Disable SNMP. This is the default setting.
Read Community	The community string to allow an SNMP manager access to the MIB objects of the STM for the purpose of reading only. The default setting is public.
Set Community	The community string to allow an SNMP manager access to the MIB objects of the STM for the purpose of reading and writing. The default setting is private.

Table 20. SNMP Settings (Continued)

Setting	Description (or Subfield and Description)	
Do You Want to Enable SNMP? (continued)	Contact	The SNMP system contact information that is available to the SNMP manager. This setting is optional.
	Location	The physical location of the STM. This setting is optional.
Trusted SNMP Hosts		
Enter the IP addresses of the computers and devices to which you want to grant read-only (GET) or write (SET) privileges on the STM. Separate IP addresses by a comma. To allow any trusted SNMP host access, leave the field blank, which is the default setting.		
SNMP Traps		
Enter the IP addresses of the SNMP management stations that are allowed to receive the STM's SNMP traps. Separate IP addresses by a comma. If you leave the field blank, which is the default setting, no SNMP management station can receive the STM's SNMP traps.		

3. Click **Apply** to save your settings.

Supported MIB Browsers

After you have configured the SNMP settings, you need to enter the IP address of the STM in the Management Information Base (MIB) browsers through which you want to query or configure the STM. See the documentation of your MIB browser for instructions.

NETGEAR recommends the following MIB browsers for receiving the STM SNMP notifications:

- MG-Soft
- SNMP
- Net-SNMP (Linux Text)
- SNMP Browser for KDE

The STM MIB structure is automatically downloaded by management stations. You should start receiving notifications after you have enabled SNMP on the STM and added its IP address into your MIB browsers.

Managing the Configuration File

The configuration settings of the STM are stored in a configuration file on the STM. This file can be saved (backed up) to a PC, retrieved (restored) from the PC, or cleared to factory default settings.

Once the STM is installed and works correctly, make a backup of the configuration file to a computer. If necessary, you can later restore the STM settings from this file.

The Backup and Restore Settings screen lets you:

- Back up and save a copy of the current settings
- Restore saved settings from the backed-up file
- Revert to the factory default settings.

To display the Backup and Restore Settings screen, select **Administration > Backup and Restore Settings** from the menu:

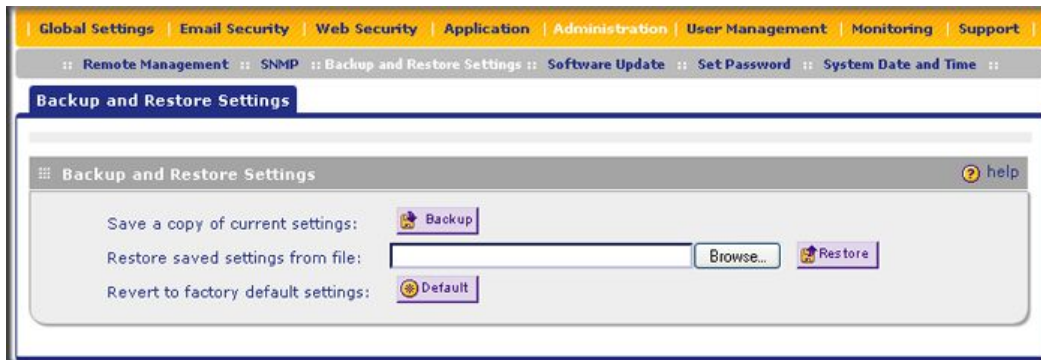

Figure 41.

Backing Up Settings

The backup feature saves all STM settings to a file. These settings include:

- **Network settings.** IP address, subnet mask, gateway, and so on.
- **Scan settings.** Services to scan, primary and secondary actions, and so on.
- **Update settings.** Update source, update frequency, and so on.
- **Antispam settings.** Whitelist, blacklist, content filtering settings, and so on.

Back up your STM settings periodically, and store the backup file in a safe place.

Tip: You can use a backup file to export all settings to another STM that has the same language and management software versions. Remember to change the IP address of the second STM before deploying it to eliminate IP address conflicts on the network.

To back up settings:

1. On the Backup and Restore Settings screen (see the previous figure), next to Save a copy of current settings, click the **Backup** button to save a copy of your current settings. A dialog box displays, showing the file name of the backup file.

Note: The backup file has the following format:

backup_\$(hostname)_\$(productversion)_\$(yyyymmdd).gpg.

\$(hostname): The host name of the STM that is configured on the Network Settings screen, for example, STM600.

\$(productversion): The software version of the STM, for example, 2.0.0-39.

\$(yyyymmdd): The time when the backup is performed, for example, 20100617.

Using these examples, the backup file name would be
backup_STM600_2.0.0-39_20100617.gpg.

2. Select **Save file**, and then click **OK**.
3. Open the folder where you have saved the backup file, and then verify that it has been saved successfully.

Note the following:

- If your browser is not configured to save downloaded files automatically, locate the folder in which you want to save the file, specify the file name, and save the file.
- If you have your browser configured to save downloaded files automatically, the file is saved to your browser's download location on the hard disk.

Restoring Settings



WARNING!

Restore only settings that were backed up from the same software version. Restoring settings from a different software version can corrupt your backup file or the STM system software.

To restore settings from a backup file:

1. On the Backup and Restore Settings screen (see *Figure 41* on page 68), next to Restore save settings from file, click **Browse**.
2. Locate and select the previously saved backup file.
3. When you have located the file, click the **Restore** button. A warning screen might appear, and you might have to confirm that you want to restore the configuration.

The STM restarts. During the reboot process, the Backup and Restore Settings screen remains visible. The reboot process is complete after several minutes when the Test LED on the front panel goes off.



WARNING!

Once you start restoring settings, do *not* interrupt the process. Do not try to go online, turn off the STM, shut down the computer, or do anything else to the STM until the settings have been fully restored.

Reverting to Factory Default Settings

To reset the STM to the original factory default settings, click the **Default** button next to Revert to factory default settings on the Backup and Restore Settings screen (see *Figure 41* on page 68).

The STM restarts. The Backup and Restore Settings screen remains visible during the reboot process. The reboot process is complete after several minutes when the Test LED (STM150) or Status LED (STM300 and STM600) on the front panel goes off.



WARNING!

When you restore the factory default settings, the STM settings are erased. All content settings and scan settings are lost. Back up your settings if you intend on using them.

Note: After rebooting with factory default settings, the STM administrator account password is password, the guest account password is guest, and the LAN IP address is **192.168.1.201**.

Note: For the STM150 only, there is an alternate way to return the settings to factory defaults: Using a sharp object, press and hold the **Reset** button on the rear panel of the STM150 (see [Rear Panel STM150](#) on page 20) for about 10 seconds until the front panel Test LED flashes and the STM150 returns to factory default settings.

Updating the Software

If you have used the Setup Wizard, you might have already configured the software update settings; the Software Update screen allows you to modify these settings.

The STM has four main software components:

- The application software that includes the network protocols, security services, Web Management Interface, and other components.
- A scan engine that enables the STM to scan emails, attachments, Web files, and applications, and that functions in conjunction with the pattern file.
- A pattern file that contains the virus signature files and virus database.
- An operating system (OS) that includes the kernel modules and hardware drives.

The STM provides two methods for updating components:

- Scheduled, automatic update
- Manual update

Because new virus threats can appear any hour of the day, it is very important to keep both the pattern file and scan engine firmware as current as possible. The STM can automatically check for updates, as often as every 15 minutes, to ensure that your network protection is current.

Scheduling Updates

Enabling scheduled updates ensures that the STM automatically downloads the latest components from the NETGEAR update server.

To configure scheduled updates:

1. Select **Administration > Software Update** from the menu. The Software Update screen displays:

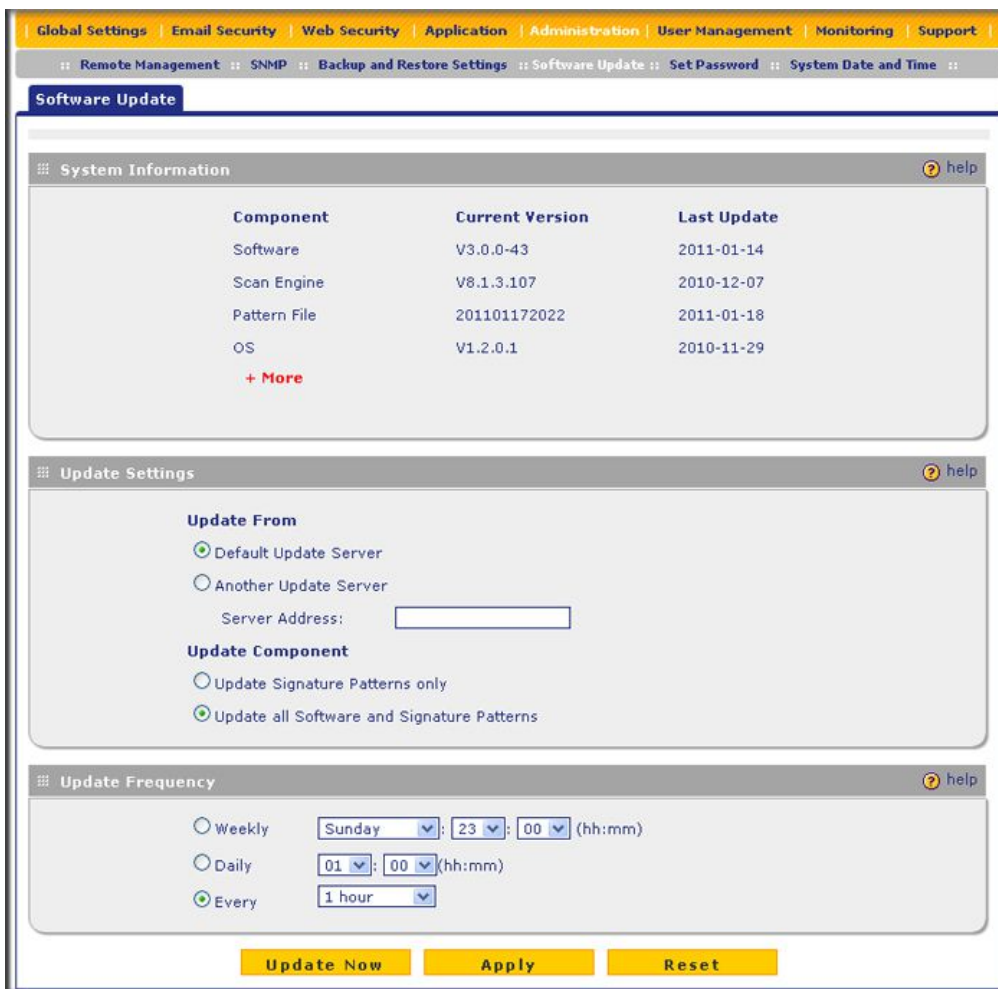

Figure 42.

2. Select the radio buttons, complete the field, and make your selections from the drop-down lists as explained in the following table:

Table 21. Software Update Settings

Setting	Description (or Subfield and Description)
System Information	
<p>You cannot configure this section; it is shown for information only. For the software, scan engine, (signature) pattern file, and operating system (OS), the current version and the date of the last update are displayed. Click + More to display the versions and most recent downloads for the antispam engine, applications engine, applications pattern file, stream engine, stream pattern file, mini engine, mini pattern file, policyd, scand, urld, update client, and rescue software.</p>	

Table 21. Software Update Settings (Continued)

Setting	Description (or Subfield and Description)		
Update Settings			
Update From	<p>Select one of the following radio buttons:</p> <ul style="list-style-type: none"> • Default Update Server. The scan engine and signatures are updated from the NETGEAR default update server. • Another Update Server. The scan engine and signatures are updated from a server that you specify by entering the server IP address or host name in the Server Address field. 		
	<table border="1"> <tr> <td>Server Address</td> <td>The update server IP address or host name.</td> </tr> </table>	Server Address	The update server IP address or host name.
Server Address	The update server IP address or host name.		
Update Component	<p>Make one of the following selections from the drop-down list:</p> <ul style="list-style-type: none"> • Update Signature Patterns only. Only the (signature) pattern file is updated. The software, scan engine, and OS are not updated. • Update all Software and Signature Patterns. The software, scan engine, (signature) pattern file, and OS are updated. This is the default setting. 		
Update Frequency			
<p>Make one of the following selections:</p> <ul style="list-style-type: none"> • Weekly. From the drop-down lists, specify the day, hour, and minutes that the update should occur. • Daily. From the drop-down lists, specify the hour and minutes that the update should occur. • Every. From the drop-down list, specify the frequency with which the update should occur. 			

3. Click **Apply** to save your settings.

Performing a Manual Update

If you want to immediately check for and download available updates, perform a manual update:

1. Select **Administration > Software Update** from the menu. The Software Update screen displays (see the previous figure).
2. At the bottom of the screen, click **Update Now**. The STM contacts the update server and checks for available updates. If updates are available, the Update Progress screen displays to show the progress of the update:

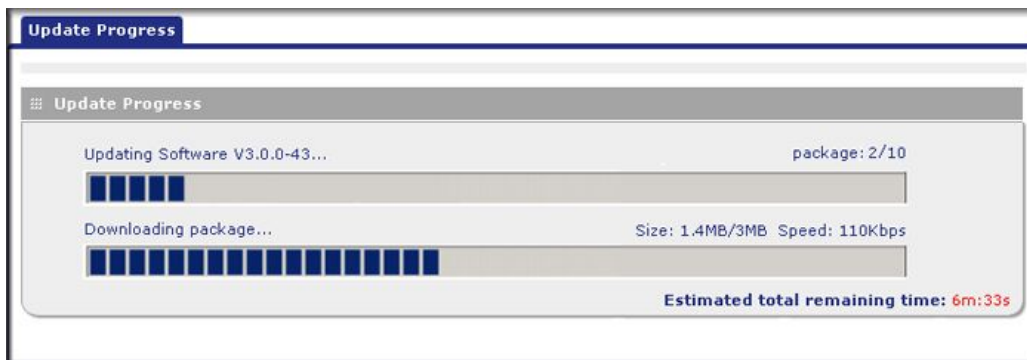

Figure 43.

- After the update has finished, click **Apply** to activate the newly updated software.

Critical Updates That Require a Restart

If a downloaded update requires a restart, you are prompted to perform the update when you log in to the STM. The following figure shows an example of a Critical Update screen, which provides information about the update and allows you to install it immediately or at a later time. To install the update immediately, click **Install Now**. To install the update at a later time, click **Later**.

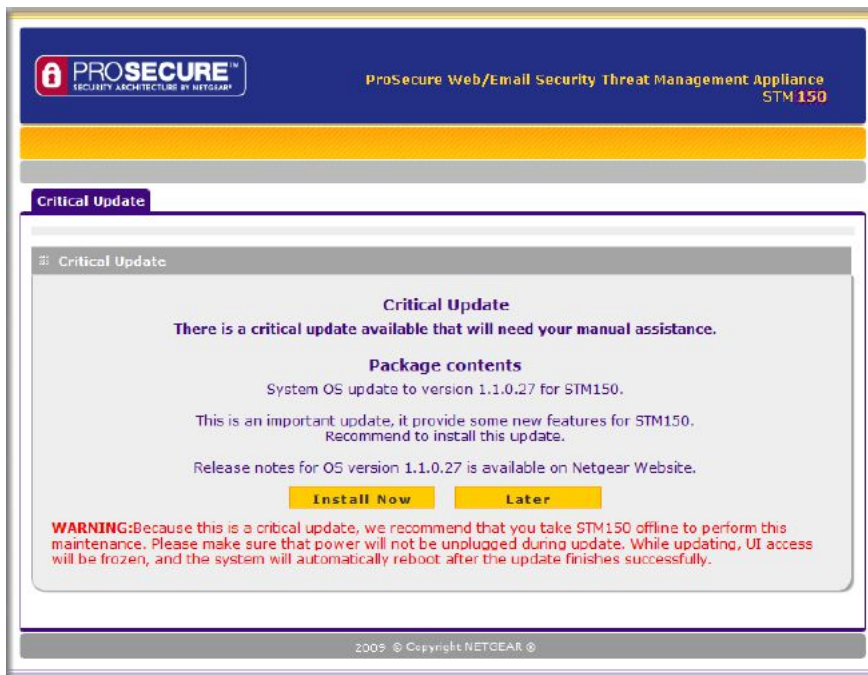

Figure 44.

Configuring Date and Time Service

If you have used the Setup Wizard, you might have already configured the system date and time settings; the System Date and Time screen allows you to modify these settings.

Configure date, time, and NTP server designations on the System Date and Time screen. Network Time Protocol (NTP) is a protocol that is used to synchronize computer clock times in a network of computers. Setting the correct system time and time zone ensures that the date and time recorded in the STM logs and reports are accurate. Changing the time zone requires the STM to restart to apply the updated settings.

To set time, date, and NTP servers:

1. Select **Administration > System Date and Time** from the menu. The System Date and Time screen displays:

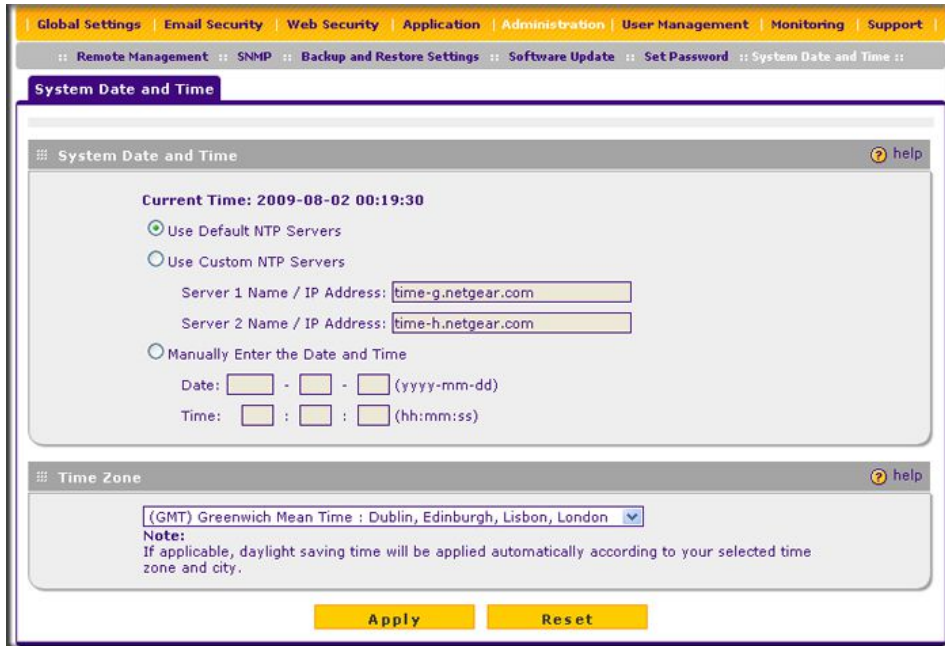

Figure 45.

The top of the screen displays the current weekday, date, time, time zone, and year (in the example in the previous figure: Current Time: 2009-08-02 00:19:30).

2. Select the radio buttons, complete the fields, and make your selections from the drop-down list as explained in the following table:

Table 22. System Date and Time Settings

Setting	Description (or Subfield and Description)
System Date and Time	
From the drop-down list, select an NTP server, or select to enter the time manually.	
Use Default NTP Servers	The STM regularly updates its real-time clock (RTC), which it uses for scheduling, by contacting a default NETGEAR NTP server on the Internet. This is the default setting.

Table 22. System Date and Time Settings (Continued)

Setting	Description (or Subfield and Description)	
Use Custom NTP Servers	The STM regularly updates its RTC by contacting one of the two NTP servers (primary and backup), both of which you need to specify in the fields that become available when you select this option.	
	<p>Note: If you select this option but leave either the Server 1 or Server 2 field blank, both fields are automatically set to the default NETGEAR NTP servers.</p> <p>Note: A list of public NTP servers is available at http://support.ntp.org/bin/view/Servers/WebHome.</p>	
	Server 1 Name / IP Address	Enter the IP address or host name the primary NTP server.
	Server 2 Name / IP Address	Enter the IP address or host name the secondary NTP server.
Manually Enter the Date and Time	Date	Enter the date in the yyyy-mm-dd (year-month-date) format.
	Time	Enter the time in the hh-mm-ss (hour-minutes-seconds) format.
Time Zone		
From the drop-down list, select the local time zone in which the STM operates. The correct time zone is required in order for scheduling to work correctly. You do not need to configure daylight savings time, which is applied automatically when applicable. GMT (Greenwich Mean Time) is the default setting.		
<p>Note: When you select a time zone that is not associated with a location such as (GMT -08:00) GMT-8, daylight savings time is automatically disabled. When you select a time zone that <i>is</i> associated with a location such as (GMT -08:00) Pacific Time (US & Canada), daylight savings time is automatically enabled.</p>		

- Click **Apply** to save your settings. Changing the time zone requires the STM to restart.

Note: If you select the default NTP servers or if you enter a custom server FQDN, the STM determines the IP address of the NTP server by performing a DNS lookup. You need to configure a DNS server address on the Network Settings screen (see [Configuring Network Settings](#) on page 52) before the STM can perform this lookup.

Managing Digital Certificates

The STM uses digital certificates (also known as X509 certificates) for secure Web access connections over HTTPS (that is, SSL VPN connections).

Digital certificates can be either self-signed or can be issued by Certification Authorities (CAs) such as an internal Windows server or an external organizations such as Verisign or Thawte. On the STM, the uploaded digital certificate is checked for validity and purpose. The digital certificate is accepted when it passes the validity test and the purpose matches its use.

The STM uses digital certificates to authenticate connecting HTTPS servers, and to allow HTTPS clients to be authenticated by remote entities. A digital certificate that authenticates a server, for example, is a file that contains the following elements:

- A public encryption key to be used by clients for encrypting messages to the server.
- Information identifying the operator of the server.
- A digital signature confirming the identity of the operator of the server. Ideally, the signature is from a trusted third party whose identity can be verified.

When a security alert is generated, the user can decide whether or not to trust the host.



Figure 46.

You can obtain a digital certificate from a well-known commercial Certificate Authority (CA) such as Verisign or Thawte. Because a commercial CA takes steps to verify the identity of an applicant, a digital certificate from a commercial CA provides a strong assurance of the server's identity.

The STM contains a self-signed digital certificate from NETGEAR. This certificate can be downloaded from the STM login screen or from the Certificate Management screen for browser import. However, NETGEAR recommends that you replace this digital certificate with a digital certificate from a well-known commercial CA prior to deploying the STM in your network.

The STM's Certificate Management screen lets you to view the currently loaded digital certificate for HTTPS scans, upload a new digital certificate, manage the trusted CA authorities list, and manage the untrusted certificates list.

To display the Certificate Management screen, select **Web Security > Certificate Management** from the menu. Because of the size of this screen, and because of the way the information is presented, the Certificate Management screen is divided and presented in this manual in three figures (the following figure, *Figure 48* on page 79, and *Figure 49* on page 80).

Managing the Certificate for HTTPS Scans

To manage the STM's active certificate that is used for HTTPS scans, select **Web Security > Certificate Management** from the menu. The Certificate Management screen displays. The following figure shows only the Certificate Used for HTTPS Scans section of the screen:

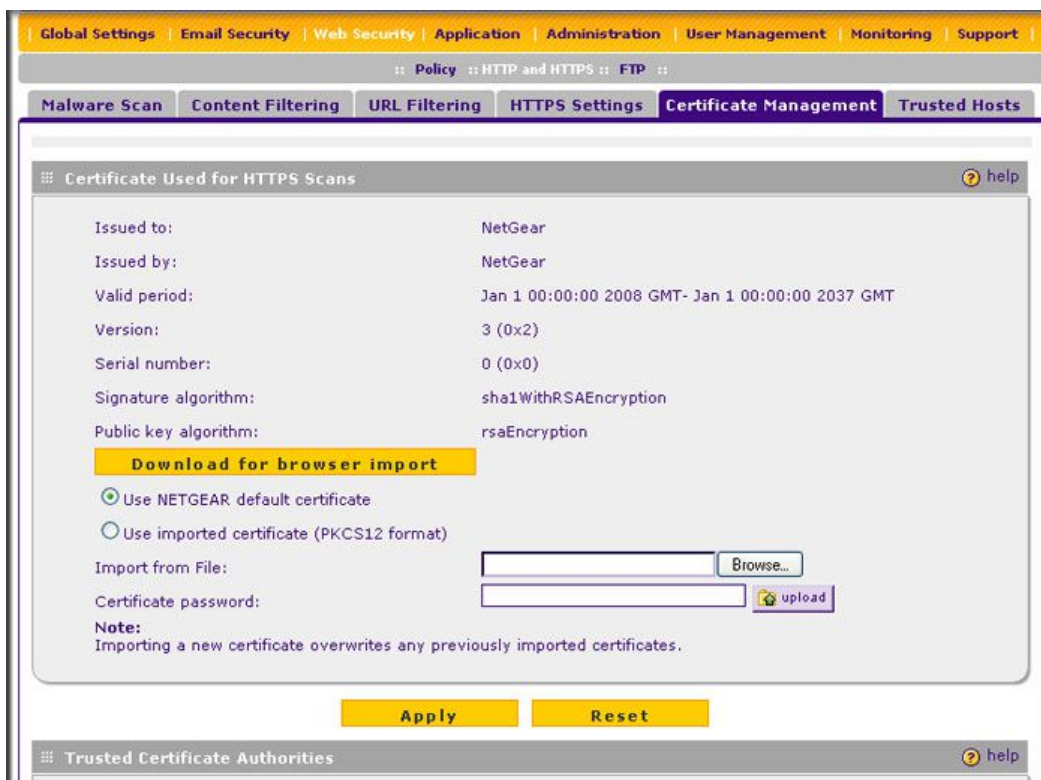

Figure 47. Certificate Management, screen 1 of 3

The top part of the Certificate Used for HTTPS Scans section displays information about the current certificate that is used for HTTPS scans.

Note: For information about the HTTPS scanning process, [HTTPS Scan Settings](#) on page 119.

To download the current certificate into your browser:

1. Click **Download for browser import**.
2. Follow the instructions of your browser to save the RootCA.crt file on your computer.

To reload the default NETGEAR certificate:

1. Select the **Use NETGEAR default certificate** radio button.
2. Click **Apply** to save your settings.

To import a new certificate:

1. Select the **Use imported certificate (PKCS12 format)** radio button.
2. Click **Browse** next to the Import from File field.
3. Navigate to a trusted certificate file on your computer. Follow the instructions of your browser to place the certificate file in the Import from File field.
4. If required, enter the appropriate password in the Certificate password field.
5. Click the **Upload** button.

Note: If the certificate file is not in the pkcs12 format, the upload fails. Importing a new certificate overwrites any previously imported certificates.

6. Click **Apply** to save your settings.

Managing Trusted Certificates

To manage trusted certificates:

Select **Web Security > Certificate Management** from the menu. The Certificate Management screen displays. The following figure shows only the Trusted Certificate Authorities section of the screen:



Figure 48. Certificate Management, screen 2 of 3

The Trusted Certificate Authorities table contains the trusted certificates from third-party websites that are signed by the Certificate Authorities.

To view details of a trusted certificate:

1. From the Trusted Certificate Authorities table, select the certificate.
2. Click **View Details**. A new screen opens that displays the details of the certificate.

To delete a trusted certificate:

1. From the Trusted Certificate Authorities table, select the certificate.
2. Click **Delete Selected**.

To import a trusted certificate:

1. Click **Browse** next to the Import from File field.
2. Navigate to a trusted certificate file on your computer. Follow the instructions of your browser to place the certificate file in the Import from File field.
3. Click the **Upload** button. The newly imported trusted certificate is added to the Trusted Certificate Authorities table.

Managing Untrusted Certificates

To manage untrusted certificates:

Select **Web Security > Certificate Management** from the menu. The Certificate Management screen displays. The following figure shows only the Untrusted Certificates section of the screen:



Figure 49. Certificate Management, screen 3 of 3

When the STM detects an untrusted or invalid certificate, it automatically places the certificate in the Untrusted Certificates table.

To view details of an untrusted certificate:

1. From the Untrusted Certificates table, select the certificate.
2. Click **View Details**. A new screen opens that displays the details of the certificate.

To delete an untrusted certificate:

1. From the Untrusted Certificates table, select the certificate.
2. Click **Delete Selected**.

To move an untrusted certificate to the Trusted Certificate Authorities table:

1. From the Untrusted Certificates table, select the certificate.
2. Click **Add to Trusted List**. The previously untrusted certificate is added to the Trusted Certificate Authorities table.

Managing the Quarantine Settings

You can specify how much memory the STM reserves for quarantined items, and how long these items remain in memory. In general, the default settings work well for most situations.

To change the quarantine settings:

1. Select **Global Settings > Quarantine** from the menu. The Quarantine screen displays:

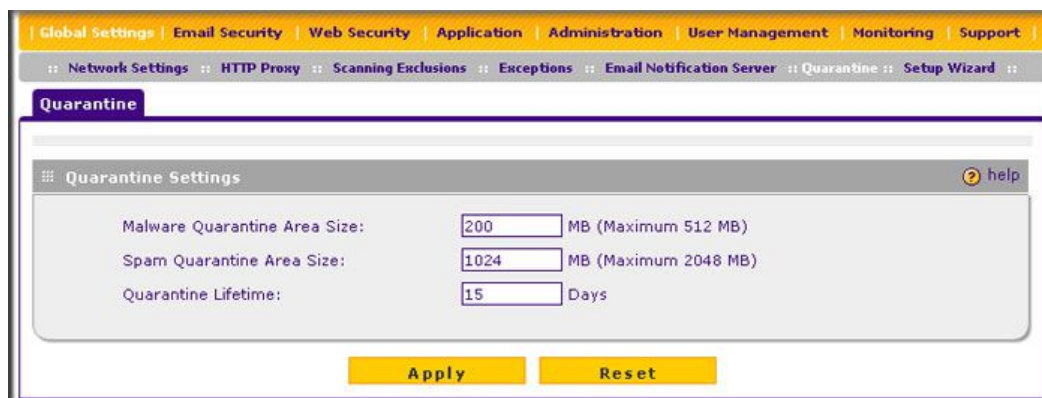

The screenshot shows the Quarantine Settings configuration page. The page has a navigation bar at the top with the following items: Global Settings | Email Security | Web Security | Application | Administration | User Management | Monitoring | Support. Below the navigation bar is a breadcrumb trail: :: Network Settings :: HTTP Proxy :: Scanning Exclusions :: Exceptions :: Email Notification Server :: Quarantine :: Setup Wizard ::. The main content area is titled "Quarantine" and contains a "Quarantine Settings" section. This section has three input fields: "Malware Quarantine Area Size" with a value of 200 MB (Maximum 512 MB), "Spam Quarantine Area Size" with a value of 1024 MB (Maximum 2048 MB), and "Quarantine Lifetime" with a value of 15 Days. At the bottom of the settings section are two buttons: "Apply" and "Reset".

Figure 50.

2. Select the radio buttons, complete the field, and make your selections from the drop-down lists as explained in the following table:

Table 23. Quarantine Settings

Setting	Description (or Subfield and Description)
Malware Quarantine Area Size	<p>Specify the maximum amount of memory in MB that is allocated to malware quarantine. This limit is cumulative for all users.</p> <p>For the STM600, the default setting is 200 MB, and the maximum setting is 512 MB.</p> <p>For the STM150 and STM300, the default setting is 100 MB, and the maximum setting is 512 MB.</p> <p>Note: After the limit has been exceeded, old items are automatically purged from the malware quarantine to make space for new items.</p>
Spam Quarantine Area Size	<p>Specify the maximum amount of memory in MB that is allocated to spam quarantine. This limit is cumulative for all users.</p> <p>For the STM600, the default setting is 1024 MB, and the maximum setting is 2048 MB.</p> <p>For the STM150 and STM300, the default setting is 512 MB, and the maximum setting is 1024 MB.</p> <p>Note: After the limit has been exceeded, old items are automatically purged from the malware quarantine to make space for new items.</p>
Quarantine Lifetime	<p>Specify how long items remain in quarantine before being automatically purged. The default setting is 15 days. The maximum setting is 30 days.</p>

3. Click **Apply** to save your settings.

Note: For information about how to view and manage the quarantine files, see [Viewing and Managing the Quarantine Files](#) on page 208.

Managing the STM's Performance

Performance management consists of controlling the traffic through the STM so that the necessary traffic gets through when there is a bottleneck and either reducing unnecessary traffic or rescheduling some traffic to low-peak times to prevent bottlenecks from occurring in the first place.

If you want to reduce traffic by preventing unwanted emails from reaching their destinations or by preventing access to certain sites on the Internet, you can use the STM's content filtering feature. By default, this feature is disabled; all requested traffic from any website is allowed with the exception of Web content categories that are mentioned in [Default Email and Web Scan Settings](#) on page 85.

You can adjust the following features of the STM in such a way that the traffic load on the WAN side decreases.

- **Email content filtering.** To reduce incoming email traffic, you can block emails with large attachments, reject emails based on keywords, file extensions, or file names, and set spam protection rules. There are several ways you can reduce unwanted email traffic:
 - **Setting the size of email files to be scanned.** Scanning large email files requires network resources and might slow down traffic. You can specify the maximum file or message size that is scanned, and whether files that exceed the maximum size are skipped (which might compromise security) or blocked. For more information, see [Exception Settings](#) on page 90.
 - **Keyword, file extension, and file name blocking.** You can reject emails based on keywords in the subject line, file type of the attachment, and file name of the attachment. For more information, see [Email Content Filtering](#) on page 94.
 - **Protecting against spam.** Set up spam protection to prevent spam from using up valuable bandwidth. For more information, see [Protecting Against Email Spam](#) on page 97.
- **Web content filtering.** The STM provides extensive methods to filter Web content in order to reduce traffic:
 - **Web category blocking.** You can block entire Web categories because their content is unwanted, offensive, or not relevant, or simply to reduce traffic. For more information, see [Configuring Web Content Filtering](#) on page 109.
 - **File extension blocking.** You can block files based on their extension. Such files can include executable files, audio and video files, and compressed files. For more information, see [Configuring Web Content Filtering](#) on page 109.
 - **URL blocking.** You can specify URLs that are blocked by the STM. For more information, see [Configuring Web URL Filtering](#) on page 116.
 - **Web services blocking.** You can block Web applications such as instant messaging, media, peer-to-peer, and tools. For more information, see [Configuring Application Control](#) on page 127.
 - **Web object blocking.** You can block the following Web component types: embedded objects (ActiveX, Java, Flash), proxies, and cookies; and you can disable Java scripts. For more information, see [Configuring Web Content Filtering](#) on page 109.
 - **Setting the size of Web files to be scanned.** Scanning large Web files requires network resources and might slow down traffic. You can specify the maximum file size that is scanned, and whether files that exceed the maximum size are skipped (which might compromise security) or blocked. For more information, see [Configuring Web Malware Scans](#) on page 107.

For these features (with the exception of Web object blocking and setting the size of files to be scanned), you can set schedules to specify when Web content is filtered (see [Configuring Web Content Filtering](#) on page 109) and configure scanning exclusions and access exceptions (see [Setting Scanning Exclusions and Web Access Exceptions](#) on page 130). You can use the STM's monitoring functions to assist you with performance management (see [Monitoring Real-Time Traffic, Security, Statistics, and Web Usage](#) on page 184).

Content Filtering and Optimizing Scans

4

This chapter describes how to apply the content filtering features of the STM and how to optimize scans to protect your network. This chapter contains the following sections:

- [About Content Filtering and Scans](#) on this page
- [Configuring Email Protection](#) on page 87
- [Configuring Web and Services Protection](#) on page 105
- [Configuring Application Control](#) on page 127
- [Setting Scanning Exclusions and Web Access Exceptions](#) on page 130

About Content Filtering and Scans

The STM provides very extensive Web content and email content filtering options, Web browsing activity reporting, email antivirus and antispam options, and instant alerts via email. You can establish restricted Web access policies that are based on the time of day, Web addresses, and Web address keywords. You can also block Internet access by applications and services, such as instant messaging and peer-to-peer file sharing clients.

Note: For information about how to monitor blocked content and malware threats in realtime, see [Monitoring Real-Time Traffic, Security, Statistics, and Web Usage](#) on page 184. For information about how to view blocked content and malware threats in the logs, see [Querying Logs](#) on page 194. For information about how to view quarantined content, see [Viewing and Managing the Quarantine Files](#) on page 208.

Default Email and Web Scan Settings

For most network environments, the default scan settings and actions that are shown in the following table work well, but you can adjust these to meet the needs of your specific environment.

Table 24. Default Email and Web Scan Settings

Scan Type	Default Scan Setting	Default Action (if applicable)
Email Server Protocols		
SMTP	Enabled	Block infected email
POP3	Enabled	Delete attachment if infected
IMAP	Enabled	Delete attachment if infected
Web Server Protocols^a		
HTTP	Enabled	Delete file if malware threat detected
HTTPS	Disabled	No action (scan disabled)
FTP	Enabled	Delete file if malware threat detected
Instant Messaging Services		
Google Talk	Allowed	
ICQ	Allowed	
mIRC	Allowed	
MSN Messenger	Allowed	
QQ	Allowed	
Yahoo Messenger	Allowed	
Media Applications		
iTunes (music store, update)	Allowed	
Quicktime (update)	Allowed	
Real Player (guide)	Allowed	
Rhapsody (guide, music store)	Allowed	
Winamp (Internet radio/TV)	Allowed	
Peer-to-Peer (P2P) Services		
BitTorrent	Allowed	
eDonkey	Allowed	
Gnutella	Allowed	

Table 24. Default Email and Web Scan Settings (Continued)

Scan Type	Default Scan Setting	Default Action (if applicable)
Tools		
Alexa Toolbar	Allowed	
GoToMyPC	Allowed	
Weatherbug	Allowed	
Yahoo Toolbar	Allowed	
Web Objects		
Embedded Objects (ActiveX/Java/Flash)	Allowed	
Javascript	Allowed	
Proxy	Allowed	
Cookies	Allowed	
Web Content Categories		
Commerce	Allowed	
Drugs and Violence	Blocked	
Education	Allowed with the exception of School Cheating	
Gaming	Blocked	
Inactive Sites	Allowed	
Internet Communication and Search	Allowed with the exception of Anonymizers	
Leisure and News	Allowed	
Malicious	Blocked	
Politics and Religion	Allowed	
Sexual Content	Blocked	
Technology	Allowed	
Uncategorized	Allowed	

a. For the STM300 and STM600, files and messages that are larger than 10240 KB are skipped by default. For the STM150, files and messages that are larger than 8192 KB are skipped by default.

Configuring Email Protection

The STM lets you configure the following settings to protect the network's email communication:

- The email protocols that are scanned for malware threats
- Actions that are taken when infected emails are detected
- The maximum file sizes that are scanned
- Keywords, file types, and file names in emails that are filtered to block objectionable or high-risk content
- Customer notifications and email alerts that are sent when events are detected
- Rules and policies for spam detection

Customizing Email Protocol Scan Settings

If you have used the Setup Wizard, you might have already configured the email policies; the (email) Policy screen allows you to modify these settings.

To configure the email protocols and ports to scan:

1. Select **Email Security > Policy** from the menu. The (email) Policy screen displays:

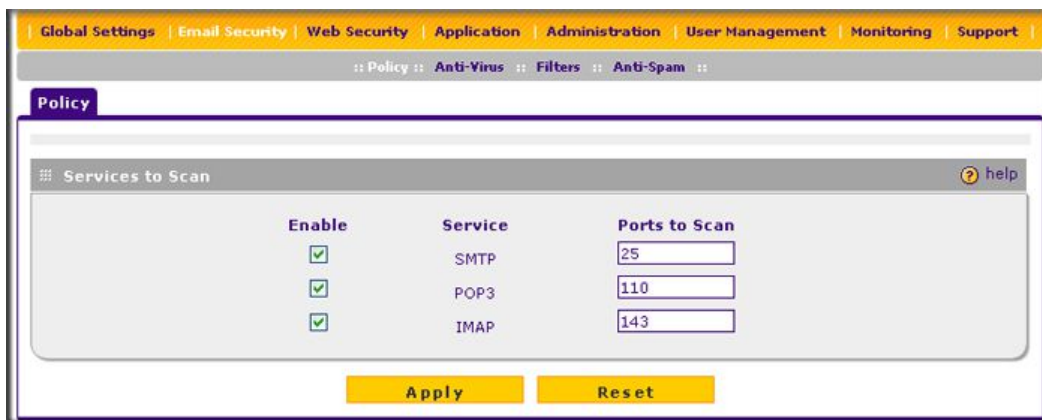

Figure 51.

2. Select the check boxes and complete the fields and as explained in the following table:

Table 25. Email Policy Settings

Setting	Description
Services to Scan	
SMTP	Select the SMTP check box to enable Simple Mail Transfer Protocol (SMTP) scanning. This service is enabled by default and uses default port 25.
POP3	Select the POP3 check box to enable Post Office Protocol 3 (POP3). This service is enabled by default and uses default port 110.
IMAP	Select the IMAP check box to enable Internet Message Access Protocol (IMAP). This service is enabled by default and uses default port 143.

Note: If a protocol uses a port other than the standard service port (for example, port 25 for SMTP), enter this nonstandard port in the Ports to Scan field. For example, if the SMTP service on your network uses both port 25 and port 2525, enter both port numbers in the Ports to Scan field and separate them by a comma.

Note: The following protocols are not supported by the STM: SMTP over SSL using port number 465, POP3 over SSL using port number 995, and IMAP over SSL using port number 993.

3. Click **Apply** to save your settings.

Customizing Email Anti-Virus Settings

If you have used the Setup Wizard, you might have already configured the email antivirus action and exception settings; the Action and Exception screens allows you to modify these settings. The Notification screen allows you to specify the email antivirus notification settings.

Whether or not the STM detects an email virus, you can configure it to take a variety of actions (some of the default actions are listed in [Table 24](#) on page 85), set exceptions for file sizes, and specify which notifications, emails, or both need to be sent to the end users.

Action Settings

To configure the email antivirus action settings:

1. Select **Email Security > Anti-Virus** from the menu. The Anti-Virus submenu tabs display with the Action screen in view:

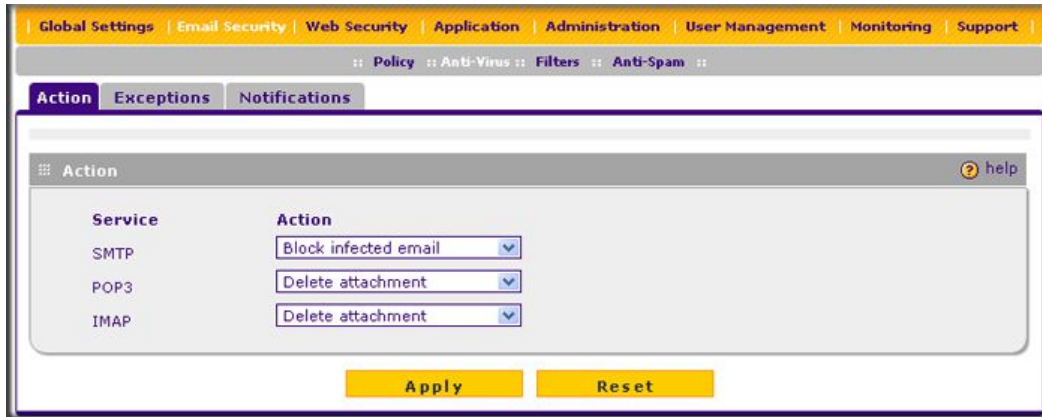

Figure 52.

2. Make your selections from the drop-down lists as explained in the following table:

Table 26. Email Anti-Virus Action Settings

Setting	Description
Action	
SMTP	<p>From the SMTP drop-down list, specify one of the following actions to be taken when an infected email is detected:</p> <ul style="list-style-type: none"> • Quarantine attachment. The email is not blocked, but the attachment is removed and placed in the malware quarantine for further research. In addition, a malware quarantine log entry is created, and depending on the nature of the malware threat, also a virus log entry or a spyware log entry. • Delete attachment. The email is not blocked, but the attachment is deleted, and a virus log entry or a spyware log entry is created. • Block infected email. This is the default setting. The email is blocked, and a virus log entry or a spyware log entry is created. • Quarantine infected email. The email is placed in the malware quarantine for further research. In addition, a malware quarantine log entry is created, and depending on the nature of the malware threat, also a virus log entry or a spyware log entry. • Log only. Only a virus log entry or a spyware log entry is created. The email is not blocked and the attachment is not deleted.

Table 26. Email Anti-Virus Action Settings (Continued)

Setting	Description
POP3	<p>From the POP3 drop-down list, specify one of the following actions to be taken when an infected email is detected:</p> <ul style="list-style-type: none"> • Quarantine attachment. The email is not blocked, but the attachment is removed and placed in the malware quarantine for further research. In addition, a malware quarantine log entry is created, and depending on the nature of the malware threat, also a virus log entry or a spyware log entry. • Delete attachment. This is the default setting. The email is not blocked, but the attachment is deleted, and a virus log entry or a spyware log entry is created. • Log only. Only a virus log entry or a spyware log entry is created. The email is not blocked and the attachment is not deleted.
IMAP	<p>From the IMAP drop-down list, specify one of the following actions to be taken when an infected email is detected:</p> <ul style="list-style-type: none"> • Quarantine attachment. The email is not blocked, but the attachment is removed and placed in the malware quarantine for further research. In addition, a malware quarantine log entry is created, and depending on the nature of the malware threat, also a virus log entry or a spyware log entry. • Delete attachment. This is the default setting. The email is not blocked, but the attachment is deleted, and a virus log entry or a spyware log entry is created. • Log only. Only a virus log entry or a spyware log entry is created. The email is not blocked and the attachment is not deleted.

3. Click **Apply** to save your settings.

Exception Settings

To configure the email antivirus exception settings:

1. Select **Email Security > Anti-Virus** from the menu. The Anti-Virus submenu tabs display with the Action screen in view.
2. Click the **Exceptions** submenu tab. The Exceptions screen displays:



Figure 53.

3. Make your selection from the drop-down list and complete the field as explained in the following table:

Table 27. Email Anti-Virus Exception Settings

Setting	Description
Scan Exceptions	
<p>From the drop-down list, specify one of the following actions to be taken when an email attachment exceeds the size that you specify in the file size field:</p> <ul style="list-style-type: none"> • Skip. The file is not scanned but skipped, leaving the end user vulnerable. This is the default setting. • Block. The file is blocked and does not reach the end user. <p>The default and maximum file sizes are:</p> <ul style="list-style-type: none"> • For the STM600 and STM300, the default setting is to block any attachment larger than 10240 KB. The maximum file size that you can specify is 51200 KB. • For the STM150, the default setting is to block any attachment larger than 8192 KB. The maximum file size that you can specify is 25600 KB. 	

Note: Setting the maximum file size to a high value might affect the STM's performance. NETGEAR recommends the default value, which is sufficient to detect the vast majority of threats.

4. Click **Apply** to save your settings.

Notification Settings

To configure the email antivirus notification settings:

1. Select **Email Security > Anti-Virus** from the menu. The Anti-Virus submenu tabs display with the Action screen in view.
2. Click the **Notifications** submenu tab. The Notifications screen displays:

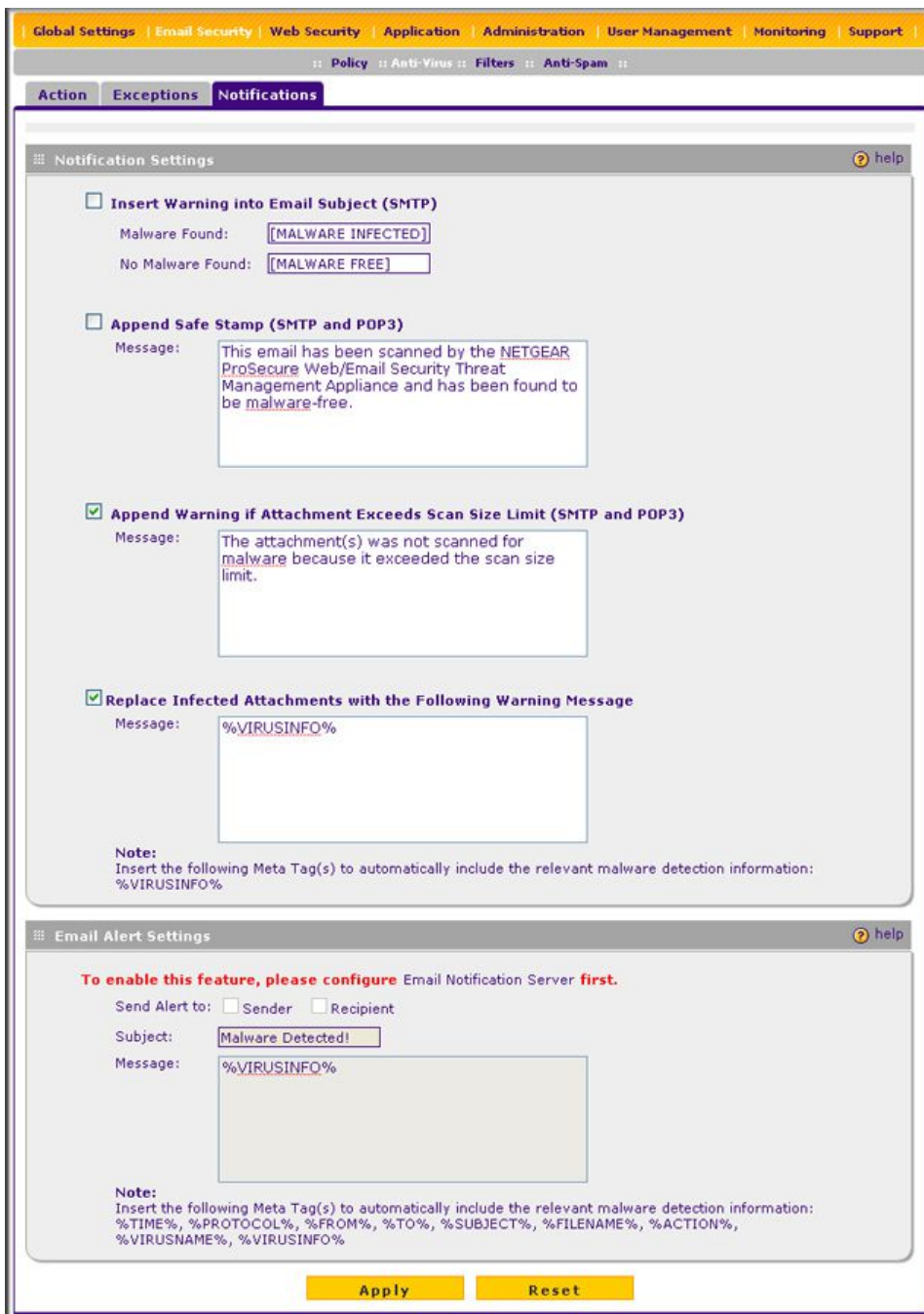

Figure 54.

- Complete the fields, select the check boxes, and make your selections from the drop-down lists as explained in the following table:

Table 28. Email Anti-Virus Notification Settings

Setting	Description
Notification Settings	
Insert Warning into Email Subject (SMTP)	For SMTP email messages, select this check box to insert a warning into the email subject line: <ul style="list-style-type: none"> • Malware Found. If a malware threat is found, a [MALWARE INFECTED] message is inserted. You can change this default message. • No Malware Found. If no malware threat is found, a [MALWARE FREE] message is inserted. You can change this default message. By default, this check box is cleared and no warnings are inserted.
Append Safe Stamp (SMTP and POP3)	For SMTP and POP3 email messages, select this check box to insert a default safe stamp message at the end of an email. The safe stamp insertion serves as a security confirmation to the end user. You can change the default message. By default, this check box is cleared and no safe stamp is inserted.
Append Warning if Attachment Exceeds Scan Size Limit (SMTP and POP3)	For SMTP and POP3 email messages, select this check box to append a default warning message to an email if the message or an attachment to the message exceeds the scan size limit. The warning message informs the end user that the attachment was skipped and might not be safe to open. You can change the default message. By default, this check box is selected and a warning message is appended to the email.
Replace Infected Attachments with the Following Warning Message	Select this check box to replace an email that is infected with a default warning message. The warning message informs the end user about the name of the malware threat. You can change the default message to include the action that the STM has taken (see the following example). By default, this check box is selected, and a warning message replaces an infected email. <p>The following is a sample message where the %VIRUSINFO% metaword is replaced with the EICAR test virus:</p> <p style="padding-left: 40px;">This attachment contains malware: File 1.exe contains malware EICAR. Action: Delete.</p> <p>Note: Make sure that you keep the %VIRUSINFO% metaword in a message to enable the STM to insert the correct malware threat information.</p>
Email Alert Settings	
Note: Ensure that the email notification server (see Configuring the Email Notification Server on page 176) is configured before you specify the email alert settings.	
Send alert to	In addition to inserting a warning message to replace an infected email, you can configure the STM to send a notification email to the sender, the recipient, or both by selecting the corresponding check box or check boxes. By default, both check boxes are cleared and no notification email is sent.

Table 28. Email Anti-Virus Notification Settings (Continued)

Setting	Description
Subject	The default subject line for the notification email is "Malware detected!" You can change this subject line.
Message	The warning message informs the sender, the recipient, or both about the name of the malware threat. You can change the default message to include more information. Make sure that you keep the %VIRUSINFO% metaword in a message to enable the STM to insert the correct malware threat information. In addition to the %VIRUSINFO% metaword, you can insert the following metawords in your customized message: %TIME%, %PROTOCOL%, %FROM%, %TO%, %SUBJECT%, %FILENAME%, %ACTION%, %VIRUSNAME%.

4. Click **Apply** to save your settings.

Email Content Filtering

The STM provides several options to filter unwanted content from emails. You can filter content from emails based on keywords in the subject line, file type of the attachment, and file name of the attachment. You can also set an action to perform on emails with password-protected attachments.

Several types of email blocking are available:

- **Keyword blocking.** You can specify words that, should they appear in the email subject line, cause that email to be blocked by the STM.
- **Password-protected attachments.** You can block emails based on password-protected attachments such as .zip or .rar attachments.
- **File extension blocking.** You can block emails based on the extensions of attached files. Such files can include executable files, audio and video files, and compressed files.
- **File name blocking.** You can block emails based on the names of attached files. Such names can include, for example, names of known malware threats such as the Netsky worm (which normally arrives as netsky.exe).

To configure email content filtering:

1. Select **Email Security > Filters** from the menu. The Filters screen displays:

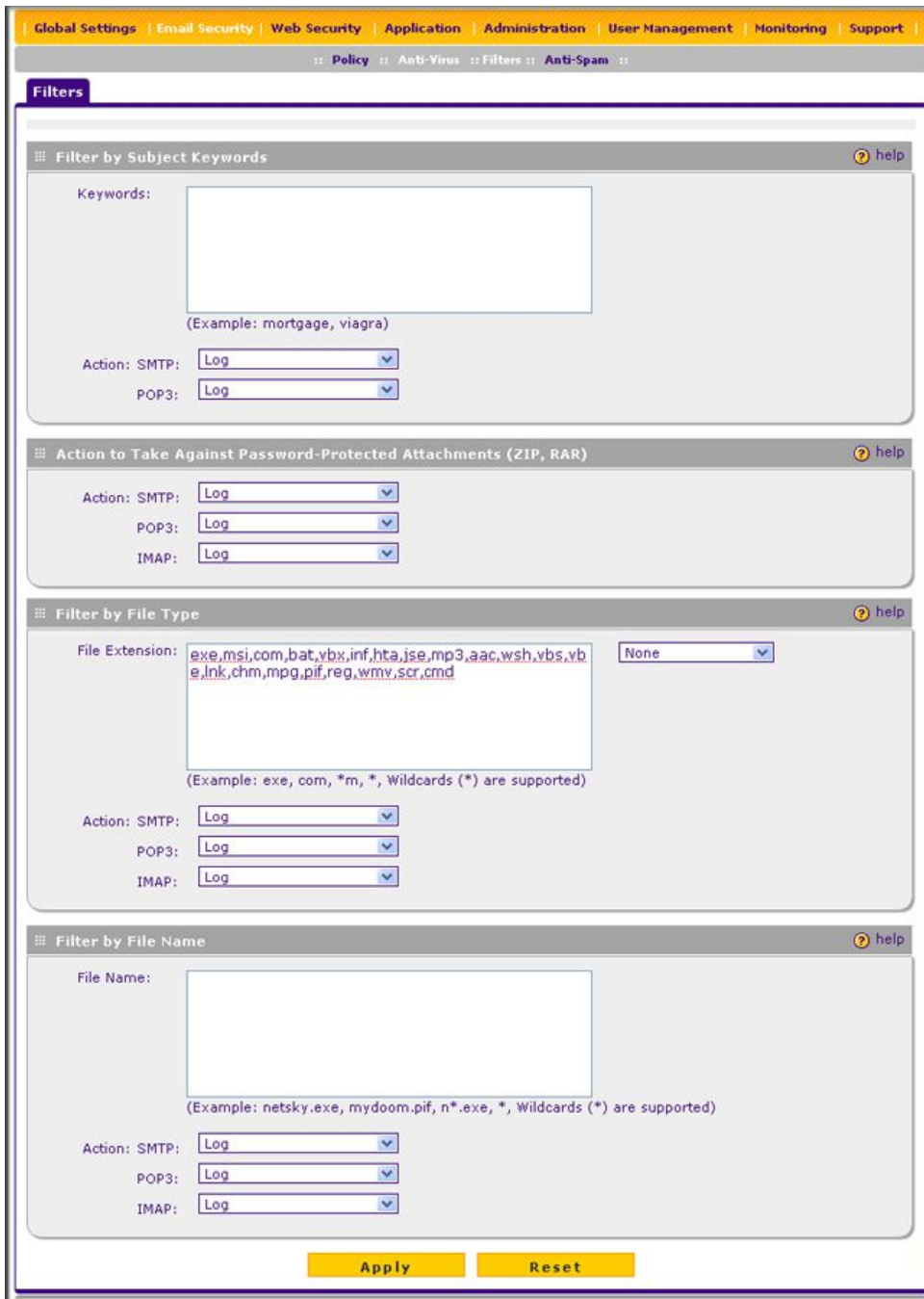

Figure 55.

- Complete the fields and make your selections from the drop-down lists as explained in the following table:

Table 29. Email Filter Settings

Setting	Description (or Subfield and Description)	
Filter by Subject Keywords		
Keywords	Enter keywords that are detected in the email subject line. Use commas to separate different keywords. The total maximum length of this field is 2048 characters, excluding duplicate words and delimiter commas.	
Action	SMTP	From the SMTP drop-down list, specify one of the following actions to be taken when a keyword that is defined in the Keywords field is detected: <ul style="list-style-type: none"> • Block email & Log. The email is blocked, and a log entry is created. • Log. This is the default setting. Only a log entry is created. The email is not blocked.
	POP3	From the POP3 drop-down list, specify one of the following actions to be taken when a keyword that is defined in the Keywords field is detected: <ul style="list-style-type: none"> • Block email & Log. The email is blocked, and a log entry is created. • Log. This is the default setting. Only a log entry is created. The email is not blocked.
Filter by Password-Protected Attachments (ZIP, RAR, etc.)		
Action	SMTP	From the SMTP drop-down list, specify one of the following actions to be taken when a password-protected attachment to an email is detected: <ul style="list-style-type: none"> • Block attachment & Log. The email is not blocked, the attachment is blocked, and a log entry is created. • Block email & Log. The email is blocked, and a log entry is created. • Log. This is the default setting. Only a log entry is created. The email and attachment are not blocked.
	POP3	From the POP3 drop-down list, specify one of the following actions to be taken when a password-protected attachment to an email is detected: <ul style="list-style-type: none"> • Block attachment & Log. The email is not blocked, the attachment is blocked, and a log entry is created. • Log. This is the default setting. Only a log entry is created. The email and attachment are not blocked.
	IMAP	From the IMAP drop-down list, specify one of the following actions to be taken when a password-protected attachment to an email is detected: <ul style="list-style-type: none"> • Block attachment & Log. The email is not blocked, the attachment is blocked, and a log entry is created. • Log. This is the default setting. Only a log entry is created. The email and attachment are not blocked.

Table 29. Email Filter Settings (Continued)

Setting	Description (or Subfield and Description)	
Filter by File Type		
File Extension	<p>By default, the File Extension field lists the most common file extensions that are detected. You can manually add or delete extensions. Use commas to separate different extensions. You can enter a maximum of 40 file extensions; the maximum total length of this field, excluding the delimiter commas, is 160 characters.</p> <p>You can also use the drop-down list to add predefined file extensions from a specific category to the File Extension field:</p> <ul style="list-style-type: none"> • None. No file extensions are added to the File Extension field. This is the default setting. • Executables. Executable file extensions (exe, com, dll, so, lib, scr, bat, and cmd) are added to the File Extension field. • Audio/Video. Audio and video file extensions (wav, mp3, avi, rm, rmvb, wma, wmv, mpg, mp4, and aac) are added to the File Extension field. • Compressed Files. Compressed file extensions (zip, rar, gz, tar, and bz2) added to the File Extension field. 	
Action	SMTP POP3 IMAP	From the drop-down list, specify an action when an email attachment with a file extension that is defined in the File Extension field is detected. The drop-down list selections and defaults are the same as the ones for the <i>Filter by Password-Protected Attachments (ZIP, RAR, etc.)</i> section earlier in this table.
Filter by File Name		
File Name	Enter the file names that are detected. For example, to block the Netsky worm (which normally arrives as netsky.exe), enter netsky.exe. You can enter a maximum of 20 file names. Use commas to separate multiple file names. The maximum total length of this field is 400 characters, excluding the delimiter commas.	
Action	SMTP POP3 IMAP	From the drop-down list, specify an action when an email attachment with a name that is defined in the File Name field is detected. The drop-down list selections and defaults are the same as the ones for the <i>Filter by Password-Protected Attachments (ZIP, RAR, etc.)</i> section earlier in this table.

3. Click **Apply** to save your settings.

Protecting Against Email Spam

The STM integrates multiple antispam technologies to provide comprehensive protection against unwanted email. You can enable all or a combination of these antispam technologies. The STM implements these spam prevention technologies in the following order:

1. **Whitelist.** Emails from the specified sources or to the specified recipients are not considered spam and are accepted.
2. **Blacklist.** Emails from the specified sources are considered spam and are blocked.
3. **Real-time blacklist.** Emails from known spam sources that are collected by blacklist providers are blocked.
4. **Distributed spam analysis.** Emails that are detected as spam by the NETGEAR Spam Classification Center are either tagged, blocked, or quarantined.

This order of implementation ensures the optimum balance between spam prevention and system performance. For example, if an email originates from a whitelisted source, the STM delivers the email immediately to its destination inbox without implementing the other spam prevention technologies, thereby speeding up mail delivery and conserving the STM system resources. However, regardless of whether or not an email is whitelisted, it is still scanned by the STM's antimalware engines.

You can configure these antispam options in conjunction with content filtering to optimize blocking of unwanted mails.

Note: Emails that are sent through the STM over an authenticated connection between a client and an SMTP mail server are not checked for spam.

Note: An email that has been checked for spam by the STM contains an "X-STM-SMTP" (for SMTP emails) or "X-STM-POP3" (for POP-3 emails) tag in its header.

Setting Up the Whitelist and Blacklist

You can specify emails that are accepted or blocked based on the originating IP address, domain, and email address by setting up the whitelist and blacklist. You can also specify emails that are accepted based on the destination domain and email address.

The whitelist ensures that email from listed (that is, trusted) sources and recipients is not mistakenly tagged as spam. Emails going to and from these sources and recipients are delivered to their destinations immediately, without being scanned by the antispam engines. This can help to speed up the system and network performance. The blacklist, on the other hand, lists sources from which all email messages are blocked. You can enter up to 200 entries per list, separated by commas.

Note: The whitelist takes precedence over the blacklist, which means that if an email source is on both the blacklist and the whitelist, the email is not scanned by the antispam engines.

To configure the whitelist and blacklist:

1. Select **Email Security > Anti-Spam** from the menu. The Anti-Spam submenu tabs display, with the Whitelist/Blacklist screen in view:

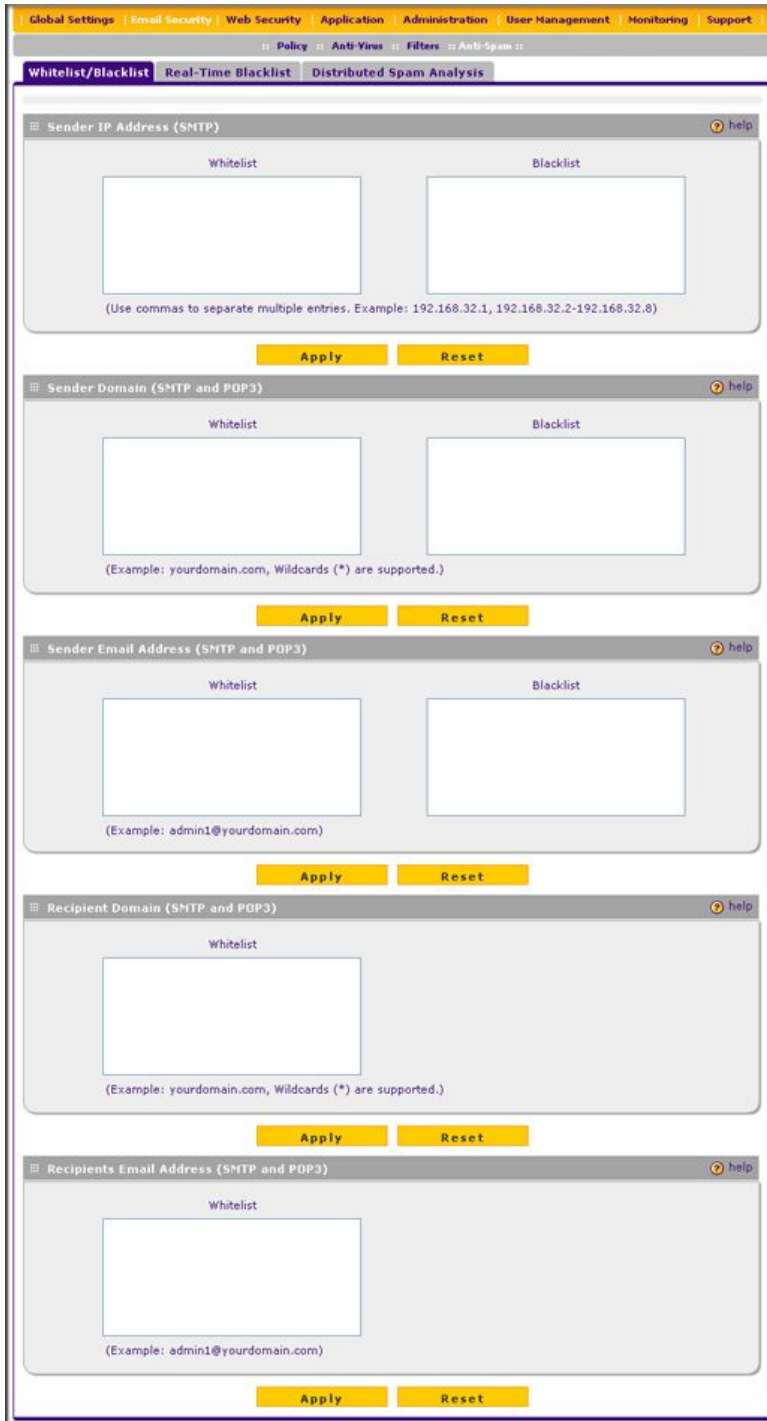

Figure 56.

2. Complete the fields as explained in the following table:

Table 30. Whitelist/Blacklist Settings

Setting	Description
Sender IP Address (SMTP)	
Whitelist	Enter the source IP addresses from which emails can be trusted.
Blacklist	Enter the source IP addresses from which emails are blocked.
Click Apply to save your settings, or click Reset to clear all entries from these fields.	
Sender Domain (SMTP and POP3)	
Whitelist	Enter the sender email domains from which emails can be trusted.
Blacklist	Enter the sender email domains from which emails are blocked.
Click Apply to save your settings, or click Reset to clear all entries from these fields.	
Sender Email Address (SMTP and POP3)	
Whitelist	Enter the email addresses from which emails can be trusted.
Blacklist	Enter the email addresses from which emails are blocked.
Click Apply to save your settings, or click Reset to clear all entries from these fields.	
Recipients Domain (SMTP and POP3)	
Whitelist	Enter the email domains of the recipients to which emails can be safely delivered.
Click Apply to save your settings, or click Reset to clear all entries from this field.	
Recipients Email Address (SMTP and POP3)	
Whitelist	Enter the email addresses of the recipients to which emails can be safely delivered.
Click Apply to save your settings, or click Reset to clear all entries from this field.	

Note: In the fields of the Whitelist/Blacklist screen, use commas to separate multiple entries. For IP addresses, use a hyphen to indicate a range (for example, 192.168.32.2-192.168.32.8.)

Configuring the Real-Time Blacklist

Blacklist providers are organizations that collect IP addresses of verified open SMTP relays that might be used by spammers as media for sending spam. These known spam relays are compiled by blacklist providers and are made available to the public in the form of real-time blacklists (RBLs). By accessing these RBLs, the STM can block spam originating from known spam sources.

Note: By default, the STM comes with two pre-defined blacklist providers: Spamhaus, and Spamcop. You can add a maximum of 16 blacklist providers to the RBL sources.

To enable the real-time blacklist:

1. Select **Email Security > Anti-Spam** from the menu. The Anti-Spam submenu tabs display, with the Whitelist/Blacklist screen in view.
2. Click the **Real-Time Blacklist** submenu tab. The Real-Time Blacklist screen displays:

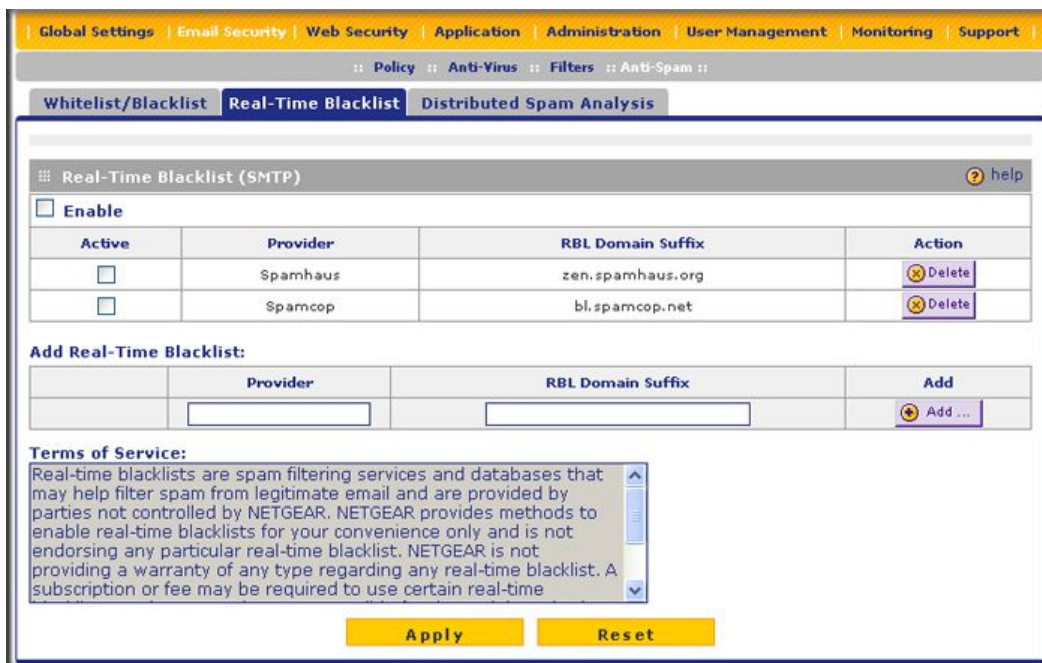

Figure 57.

3. Select the **Enable** check box to enable the Real-Time Blacklist function.
4. Select the **Active** check boxes to the left of the default blacklist providers (Spamhaus and Spamcop) that you want to activate. A Terms of Service popup window displays.
5. Read the terms of service in the Terms of Service field. If you agree with these terms, click **OK**.
6. Click **Apply** to save your settings.

To add a blacklist provider to the real-time blacklist:

1. In the Add Real-time Blacklist section, add the following information:
 - In the Provider field, add the name of the blacklist provider.
 - In the RBL Domain Suffix field, enter the domain suffix of the blacklist provider.
2. Click the **Add** table button in the Add column. The new blacklist provider is added to the Real-Time Blacklist (SMTP) table, and it is disabled by default.

To delete a blacklist provider from the real-time blacklist, click the **Delete** table button next to the blacklist provider that you want to delete.

Configuring Distributed Spam Analysis

Spam, phishing, and other email-borne threats consist of millions of messages intentionally composed differently to evade commonly used filters. Nonetheless, all messages within the same outbreak share at least one unique, identifiable value that can be used to distinguish the outbreak.

With distributed spam analysis, message patterns are extracted from the message envelope, headers, and body with no reference to the content itself. Pattern analysis can then be applied to identify outbreaks in any language, message format, or encoding type. Message patterns can be divided into distribution patterns and structure patterns. The STM uses distribution patterns to determine if the message is legitimate or a potential threat by analyzing the way it is distributed to the recipients. The STM uses structure patterns to determine the volume of the distribution.

The STM uses a distributed spam analysis architecture to determine whether or not an email is spam for SMTP and POP3 emails. Any email that is identified as spam is tagged as spam (an option for both SMTP and POP3), blocked, or quarantined (the latter two are options possible only for SMTP).

Note: Unlike other scans, you do not need to configure the spam score because the NETGEAR Spam Classification Center performs the scoring automatically as long as the STM is connected to the Internet. However, this does mean that the STM needs to be connected to the Internet for the spam analysis to be performed correctly.

To configure distributed spam analysis and the antispam engine settings:

1. Select **Email Security > Anti-Spam** from the menu. The Anti-Spam submenu tabs display, with the Whitelist/Blacklist screen in view.
2. Click the **Distributed Spam Analysis** submenu tab. The Distributed Spam Analysis screen displays:

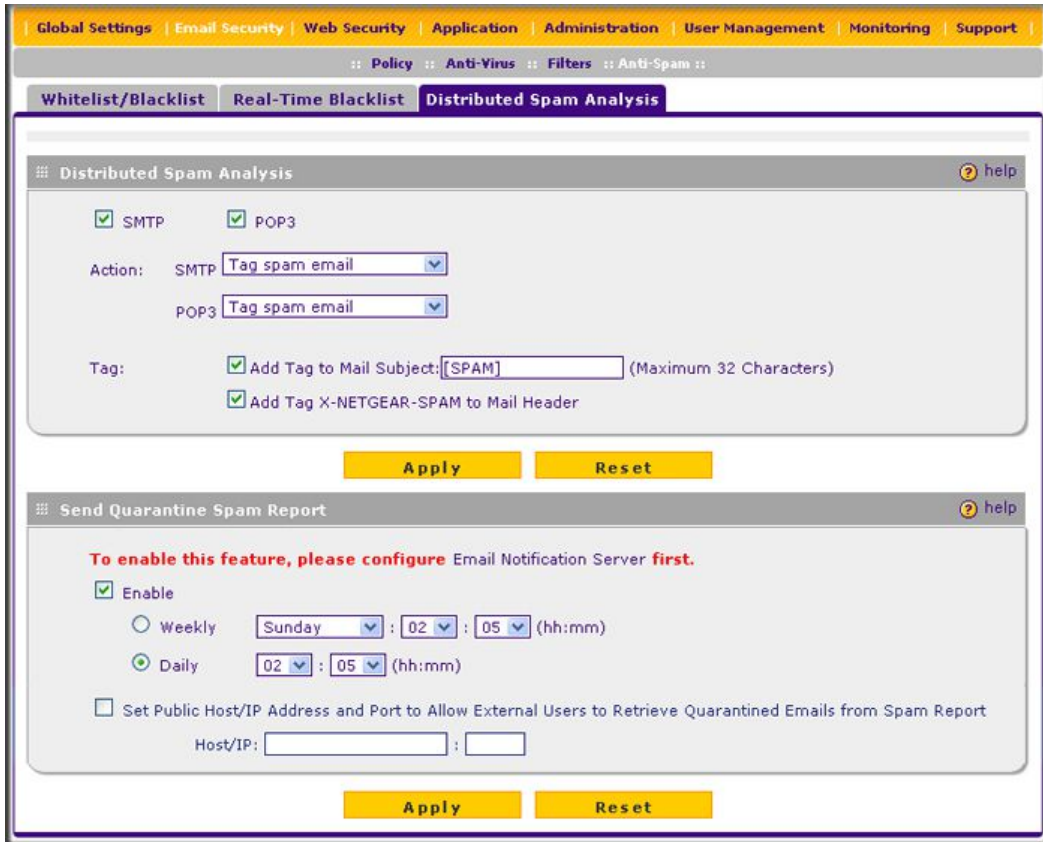

Figure 58.

3. Complete the fields, select the check boxes, and make your selections from the drop-down lists as explained in the following table:

Table 31. Distributed Spam Analysis Settings

Setting	Description (or Subfield and Description)
Distributed Spam Analysis	
SMTP	Select the SMTP check box to enable distributed spam analysis for the SMTP protocol. (You can enable distributed spam analysis for both SMTP and POP3.)
POP3	Select the POP3 check box to enable distributed spam analysis for the POP3 protocol. (You can enable distributed spam analysis for both SMTP and POP3.)

Table 31. Distributed Spam Analysis Settings (Continued)

Setting	Description (or Subfield and Description)	
Action	SMTP	From the SMTP drop-down list, select the action that is taken when spam is detected by the antispam engine: <ul style="list-style-type: none"> • Tag spam email. This is the default setting. The email is tagged as spam, and a spam log entry is created. • Block spam email. The email is blocked, and a spam log entry is created. • Quarantine spam email. The email is quarantined, a spam log entry is created, and a spam quarantine log entry is created.
	POP3	The only option is to tag spam email. A spam log entry is also created.
Tag	Add tag to mail subject	When you select the Tag spam email option from the Action drop-down list (see earlier in this table), select this check box to add a tag to the email subject line. The default tag is [SPAM], but you can customize this tag. The default setting is to add the default tag to the subject line.
	Add tag X-NETGEAR-SPAM to mail header	When you select the Tag spam email option from the Action drop-down list (see earlier in this table), select this check box to add the X-NETGEAR-SPAM tag to the email header. The default setting is to add the default tag to the email header.
<p>Send Quarantine Spam Report</p> <p>Note: Ensure that the email notification server (see Configuring the Email Notification Server on page 176) is configured before you specify the quarantine spam report settings.</p>		
Enable	Select this check box to enable the STM to send a quarantine spam report to the recipient that you have specified on the Email Notification Server screen (see Configuring the Email Notification Server on page 176).	
	Select one of the following radio buttons to specify the frequency with which the report is sent: <ul style="list-style-type: none"> • Weekly. Reports are sent weekly at the day and time that you specify from the drop-down lists (weekday, hours, and minutes). • Daily. Reports are sent daily at the time that you specify from the drop-down lists (hours and minutes). 	

Table 31. Distributed Spam Analysis Settings (Continued)

Setting	Description (or Subfield and Description)
Set Public Host/IP Address and Port	The management port of the STM usually has a LAN IP address assigned, preventing users from outside the LAN from accessing the STM to look at their quarantined spam email. Select this check box to enable users from outside the LAN to access their quarantined spam email. Complete the Host/IP fields. Note: If you use a firewall, you need to map the public IP address and public port to the LAN IP address of the STM's management port. Note: When you select the Set Public Host/IP Address and Port check box, the spam reports (see <i>User-Generated Spam Reports</i> on page 214) display an External Link column with hyperlinks that are consistent with the IP address and port that you specify in the Host/IP field.
	Host/IP

4. Click **Apply** to save your settings. The Distributed Spam Analysis section and the Send Quarantine Spam Report section each have their own Apply and Reset buttons to enable you to make changes to these sections separately.

Configuring Web and Services Protection

The STM lets you configure the following settings to protect the network's Internet communication:

- The Web protocols that are scanned for malware threats
- Actions that are taken when infected Web files or objects are detected
- The maximum file sizes that are scanned
- Web objects that are blocked
- Web categories, keywords, and file types that are filtered to block objectionable or high-risk content
- Domains and URLs that are blocked for objectionable or high-risk content
- Customer notifications and email alerts that are sent when events are detected
- Schedules that determine when content filtering is active

Customizing Web Protocol Scan Settings

If you have used the Setup Wizard, you might have already configured the Web protocol scan settings; the (Web) Policy screen allows you to modify these settings.

Scanning all protocols enhances network security, but might affect the performance of the STM. For an optimum balance between security and performance, enable scanning only of the most commonly used protocols on your network. For example, you can scan FTP and HTTP, but not HTTPS (if this last protocol is not often used). For more information about performance, see *Managing the STM's Performance* on page 82.

To specify the Web protocols and ports that are scanned for malware threats.

1. Select **Web Security > Policies** from the menu. The (Web) Policy screen displays:

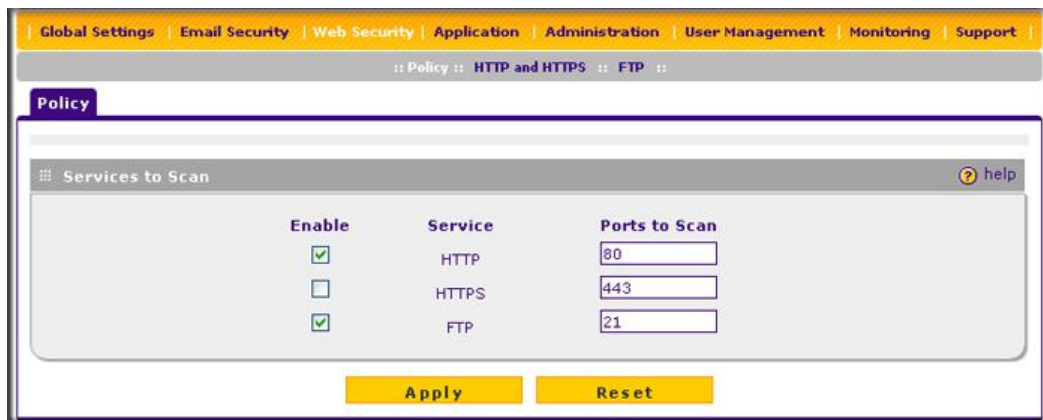

Figure 59.

2. Select the check boxes and complete the fields and as explained in the following table:

Table 32. Web Policy Settings

Setting	Description
Services to Scan	
HTTP	Select the HTTP check box to enable Hypertext Transfer Protocol (HTTP) scanning. This service is enabled by default and uses default port 80. You can change the standard service port or add another port in the corresponding Ports to Scan field.
HTTPS	Select the HTTPS check box to enable Hypertext Transfer Protocol over Secure Socket Layer (HTTPS). This service is disabled by default. The HTTPS default port is 443. You can change the standard service port or add another port in the corresponding Ports to Scan field.
FTP	Select the FTP check box to enable File Transfer Protocol (FTP). This service is enabled by default and uses default port 21. You can change the standard service port or add another port in the corresponding Ports to Scan field.

Note: If a protocol uses a port other than the standard service port (for example, port 80 for HTTP), enter this nonstandard port in the Ports to Scan field. For example, if the HTTP service on your network uses both port 80 and port 8080, enter both port numbers in the Ports to Scan field, and separate them by a comma.

3. Click **Apply** to save your settings.

Configuring Web Malware Scans

If you have used the Setup Wizard, you might have already configured the Web malware action and exception scan settings; the Malware Scan screen allows you to modify these settings.

Whether or not the STM detects Web-based malware threats, you can configure it to take a variety of actions (some of the default actions are listed in [Table 24](#) on page 85), skip files that are too large, and send notifications, emails, or both to the end users.

To configure the Web-based malware settings:

1. Select **Application Security > HTTP/HTTPS** from the menu. The HTTP/HTTPS submenu tabs display, with the Malware Scan screen in view:

The screenshot displays the Malware Scan configuration interface. At the top, there is a navigation bar with tabs for Global Settings, Email Security, Web Security, Application, Administration, User Management, Monitoring, and Support. Below this, a breadcrumb trail shows Policy > HTTP and HTTPS > FTP. The main content area is divided into several sections:

- Action:** A table with columns for Service, Action, and Streaming.

Service	Action	Streaming
HTTP	Delete file	<input checked="" type="checkbox"/>
HTTPS	Delete file	<input checked="" type="checkbox"/>
- Scan Exceptions:** A section with a dropdown menu set to 'Skip' and a text field containing 'if the file or message is larger than 10240 KB(Maximum: 51200 KB)'. A help icon is present.
- HTML Scan:** A section with a checked checkbox labeled 'Scan HTML Files' and a help icon.
- Notification Settings:** A section with a checked checkbox labeled 'Replace Page with the Following Warning Text:'. Below this is a text area containing HTML code:

```
<!DOCTYPE HTML PUBLIC "-//W3C//DTD HTML 4.0 Transitional//EN">
<HTML><HEAD><TITLE>NETGEAR ProSecure - User Notification</TITLE>
<META http-equiv=Content-Type content="text/html; charset=windows-1252">
```

 Below the text area is a 'Preview' button and a note: 'Note that scripts are not supported'. A 'Note:' section follows, stating: 'Insert the following Meta Tag(s) to automatically include the relevant malware detection information: %TIME%, %PROTOCOL%, %FROM%, %TO%, %SUBJECT%, %FILENAME%, %ACTION%, %VIRUSNAME%, %VIRUSINFO%'. At the bottom of the screen are 'Apply' and 'Reset' buttons.

Figure 60.

2. Complete the fields, select the check boxes, and make your selections from the drop-down lists as explained in the following table:

Table 33. Malware Scan Settings

Setting	Description
Action	
HTTP and HTTPS	<p>Action</p> <p>From the HTTP or HTTPS drop-down list, specify one of the following actions to be taken when an infected Web file or object is detected:</p> <ul style="list-style-type: none"> • Quarantine file. The file is placed in quarantine, a malware quarantine log entry is created, and depending on the nature of the malware threat, also a virus log entry or a spyware log entry. • Delete file. This is the default setting. The Web file or object is deleted, and depending on the nature of the malware threat, a virus log entry or a spyware log entry is created. • Log only. Depending on the nature of the malware threat, only a virus log entry or a spyware log entry is created. The Web file or object is not placed in quarantine nor deleted.
	<p>Streaming</p> <p>Select the Streaming check box to enable streaming of partially downloaded and scanned HTTP or HTTPS file parts to the end user. This method allows the user to experience more transparent Web downloading. Streaming is enabled by default.</p>
Scan Exceptions	
<p>From the drop-down list, specify one of the following actions to be taken when a file or message exceeds the size that you specify in the file size field:</p> <ul style="list-style-type: none"> • Skip. The file is not scanned but skipped, leaving the end user vulnerable. This is the default setting. • Block. The file is blocked and does not reach the end user. <p>The default and maximum file sizes are as follows:</p> <ul style="list-style-type: none"> • For the STM600 and STM300, the default setting is to block any attachment larger than 10240 KB. The maximum file size that you can specify is 51200 KB. • For the STM150, the default setting is to block any attachment larger than 8192 KB. The maximum file size that you can specify is 25600 KB. <p>Note: Setting the maximum file size to a high value might affect the STM's performance. NETGEAR recommends the default value, which is sufficient to detect the vast majority of threats.</p>	
HTML Scan	
Scan HTML Files	Select this check box to enable scanning of HyperText Markup Language (HTML) files, which is enabled by default.
Notification Settings	
<p>Select the Replace Page with the Following Warning Text check box to enable the STM to replace the content of a Web page that is blocked because of a detected malware threat with the following text:</p> <p>NETGEAR ProSecure Web/Email Security Threat Management Appliance has detected and stopped malicious code embedded in this web site for protecting your computer and network from infection.</p> <p>%VIRUSINFO%</p>	

Table 33. Malware Scan Settings (Continued)

Setting	Description
	<p>Note: You can customize this text. Make sure that you keep the %VIRUSINFO% metaword in the text to enable the STM to insert the correct malware threat information. In addition to the %VIRUSINFO% metaword, you can insert the following metawords in your customized message: %TIME%, %PROTOCOL%, %FROM%, %TO%, %SUBJECT%, %FILENAME%, %ACTION%, %VIRUSNAME%.</p>
	<p>The text is displayed on the Malware Scan screen with HTML tags. Click Preview to open a screen that displays the notification text in HTML format.</p>

3. Click **Apply** to save your settings.

Configuring Web Content Filtering

If you want to restrict internal LAN users from access to certain types of information and objects on the Internet, use the STM's content filtering and Web objects filtering. With the exception of the Web content categories that are mentioned in *Default Email and Web Scan Settings* on page 85, all requested traffic from any website is allowed. You can specify a message such as "Blocked by NETGEAR" that is displayed onscreen if a user attempts to access a blocked site (see the Notification Settings section that is described at the bottom of *Table 34* on page 112). Several types of Web content blocking are available:

- **File extension blocking.** You can block files based on their extension. Such files can include executable files, audio and video files, and compressed files.
- **Web object blocking.** You can block the following Web objects: embedded objects (ActiveX, Java, Flash), proxies, and cookies; and you can disable Java scripts. However, websites that are on the whitelist (see *Configuring Web URL Filtering* on page 116) are never subject to Web object blocking.
- **Web category blocking.** You can block entire Web categories because their content is unwanted, offensive, or not relevant, or simply to reduce traffic.

Note: You can bypass any type of Web blocking for trusted domains by adding the exact matching domain names to the trusted host list (see *Specifying Trusted Hosts* on page 124). Access to the domains on the trusted host list is allowed for PCs in the groups for which file extension, object, or category blocking, or a combination of these types of Web blocking has been enabled.

Note: You can bypass any type of Web blocking for trusted URLs by adding the URLs to the whitelist (see *Configuring Web URL Filtering* on page 116). Access to the URLs on the whitelist is allowed for PCs in the groups for which file extension, object, or category blocking, or a combination of these types of Web blocking has been enabled.

Note: For information about creating custom categories that allow you to set access exceptions for combinations of Web categories, see *Creating Custom Categories for Web Access Exceptions* on page 142.

If you have used the Setup Wizard, you might have already configured the Web category blocking settings; the Content Filtering screen allows you to modify these settings.

To configure Web content filtering:

1. Select **Web Security > HTTP/HTTPS** from the menu. The HTTP/HTTPS submenu tabs display, with the Malware Scan screen in view.
2. Click the **Content Filtering** submenu tab. The Content Filtering screen displays. Because of the large size of this screen, it is presented in this manual in three figures (the following figure, *Figure 62* on page 111, and *Figure 63* on page 112).

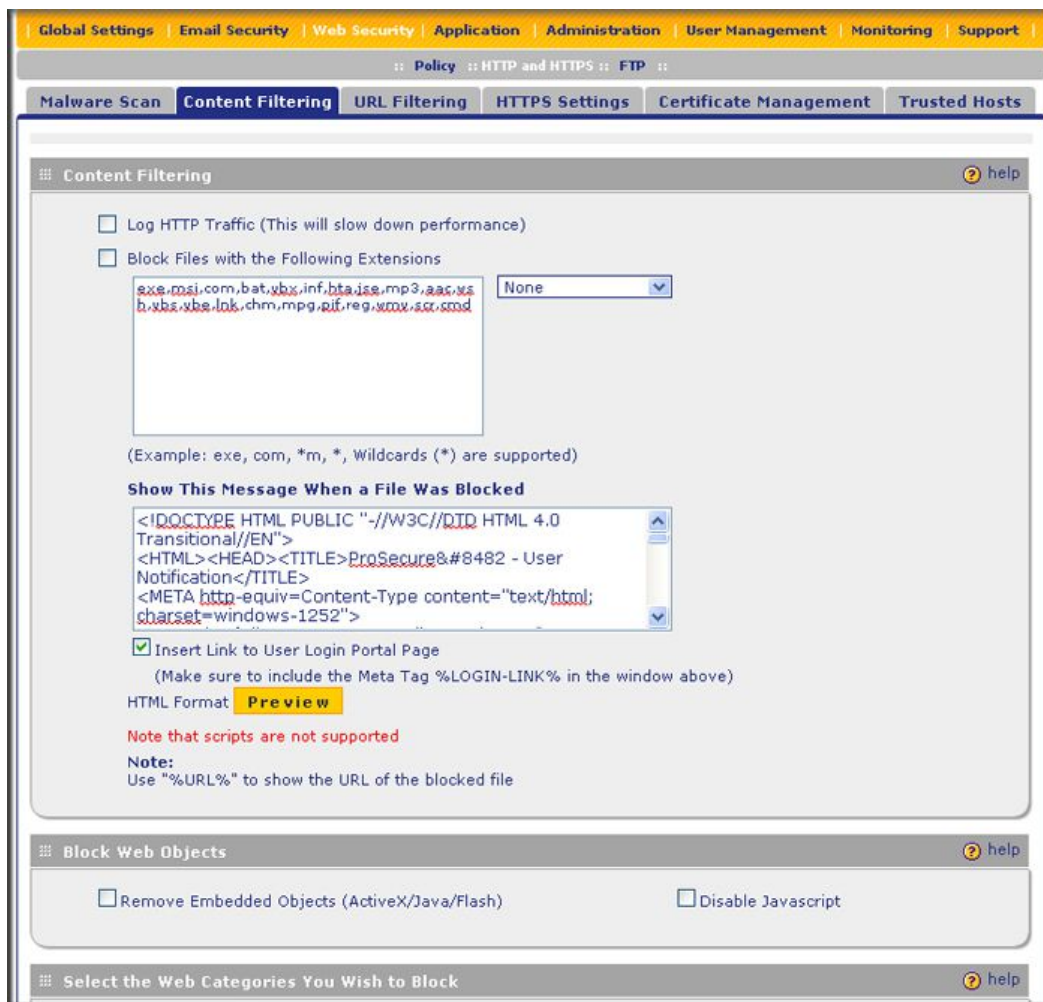

Figure 61. Content Filtering, screen 1 of 3



Figure 62. Content Filtering, screen 2 of 3

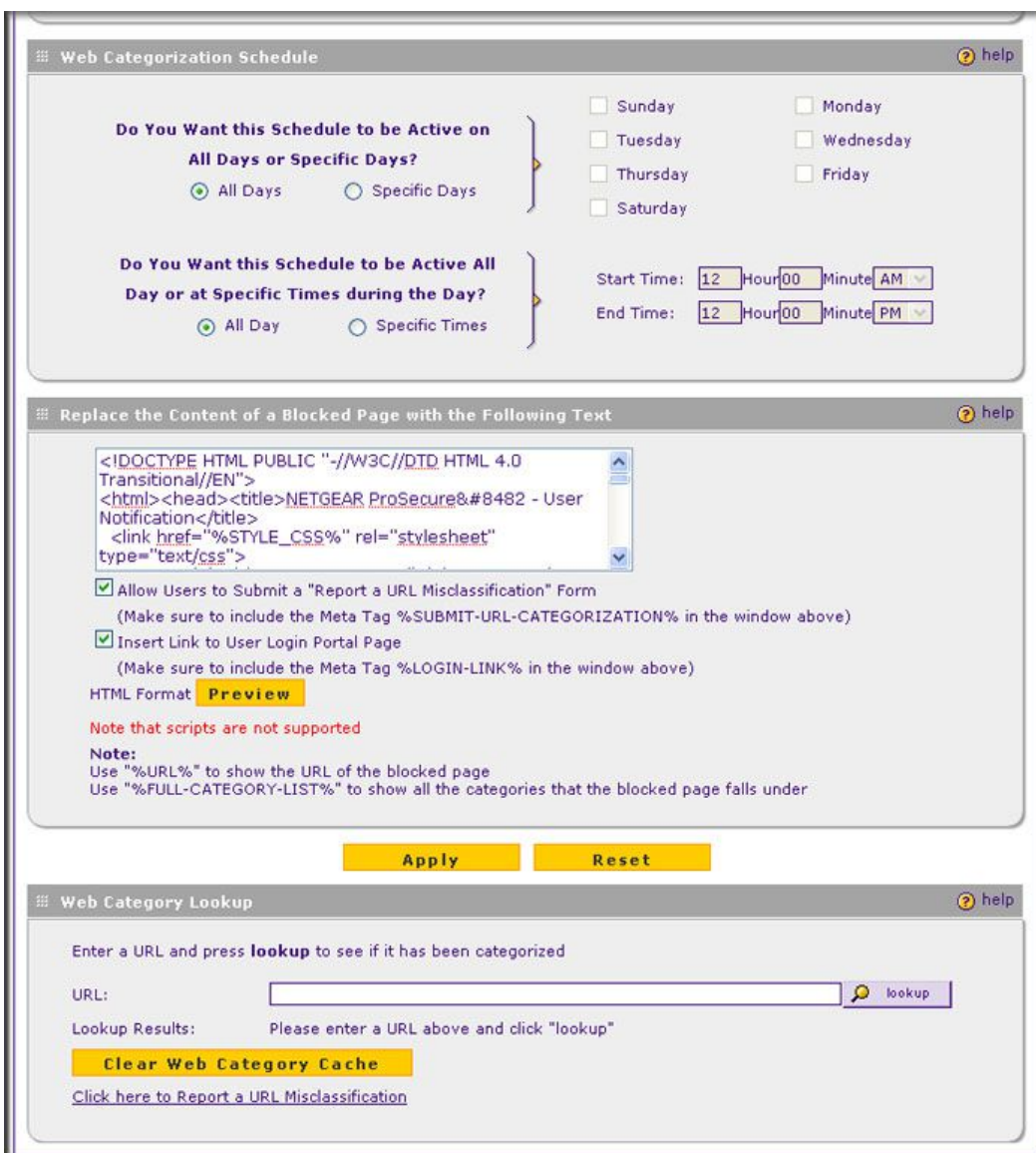

Figure 63. Content Filtering, screen 3 of 3

- Complete the fields, select the check boxes, and make your selections from the drop-down lists as explained in the following table:

Table 34. Content Filtering Settings

Setting	Description
Content Filtering	
Log HTTP Traffic	Select this check box to log HTTP traffic. For information about how to view the logged traffic, see <i>Querying Logs</i> on page 194. By default, HTTP traffic is not logged. Note: Logging HTTP traffic might affect the STM's performance (see <i>Managing the STM's Performance</i> on page 82).

Table 34. Content Filtering Settings (Continued)

Setting	Description
Block Files with the Following Extensions	<p>Select the check box to enable file extension blocking. By default, the File Extension field lists the most common file extensions that are detected. You can manually add or delete extensions. Use commas to separate different extensions. You can also use the drop-down list to add predefined file extensions from a specific category to the File Extension field:</p> <ul style="list-style-type: none"> • None. No file extensions are added to the File Extension field. This is the default setting. • Executables. Executable file extensions (exe, com, dll, so, lib, scr, bat, and cmd) are added to the File Extension field. • Audio/Video. Audio and video file extensions (wav, mp3, avi, rm, rmvb, wma, wmv, mpg, mp4, and aac) are added to the File Extension field. • Compressed Files. Compressed file extensions (zip, rar, gz, tar, and bz2) added to the File Extension field.
Show This Message When a File was Blocked	
<p>The STM replaces the content of a Web page that is blocked because of violating file extensions with the following text, which you can customize:</p> <p style="padding-left: 40px;">Internet Policy has restricted access to this location with file extension: %URL%</p> <p>Note: Make sure that you keep the %URL% metaword in the text to enable the STM to show the URL of the blocked pager.</p>	
<p>As an option, you can select the Insert Link to User Login Portal Page check box. When you select this check box, the screen that displays when a user attempts to access blocked content includes a hyperlink that allows the user to log in as another user:</p> <p style="padding-left: 40px;">You are logged in as %USER% (Click here to login as another user)</p> <p>Note: Make sure that you keep the %LOGIN-LINK% metaword in the text to enable the STM to insert the actual hyperlink.</p>	
<p>The text is displayed on the Content Filtering screen with HTML tags. Click Preview to open a screen that displays the notification text in HTML format.</p>	
<p>Block Web Objects Select one or both of the following check boxes:</p>	
Remove Embedded Objects	<p>All embedded objects such as ActiveX, Java, and Flash objects are removed from downloaded Web pages.</p> <p>Note: Because embedded objects are commonly used on legitimate websites, blocking embedded objects globally might have a negative impact on a user's Web browsing experience.</p>
Disable Javascript	Javascript is disabled on downloaded Web pages.

Table 34. Content Filtering Settings (Continued)

Setting	Description
Select the Web Categories You Wish to Block	
<p>Select the Enable Blocking check box to enable blocking of Web categories, which is the default setting. Select the check boxes of any Web categories that you want to block. Use the action buttons at the top of the section in the following way:</p> <ul style="list-style-type: none"> • Allow All. All Web categories are allowed. • Block All. All Web categories are blocked. • Set to Defaults. Blocking and allowing of Web categories are returned to their default settings. See Table 24 on page 85 for information about the Web categories that are blocked by default. Categories that are preceded by a green rectangle are allowed by default; categories that are preceded by a pink rectangle are blocked by default. 	
Web Categorization Schedule	
Do You Want this Schedule to be Active on All Days or Specific Days?	<p>Select one of the following radio buttons:</p> <ul style="list-style-type: none"> • All Days. The schedule is in effect all days of the week. • Specific Days. The schedule is active only on specific days. <p>To the right of the radio buttons, select the check box for each day that you want the schedule to be in effect.</p>
Do You Want this Schedule to be Active All Day or at Specific Times during the Day?	<p>Select one of the following radio buttons:</p> <ul style="list-style-type: none"> • All Day. The schedule is in effect all hours of the selected day or days. • Specific Times. The schedule is active only on specific hours of the selected day or days. <p>To the right of the radio buttons, fill in the Start Time and End Time fields (Hour, Minute, AM/PM) during which the schedule is in effect.</p>
Replace the Content of a Blocked Page with the Following Text	
<p>The STM replaces the content of a Web page that is blocked because of violating content with the following text, which you can customize:</p> <p style="padding-left: 40px;">Internet Policy has restricted access to this location belonging to the following categories: %FULL-CATEGORY-LIST%</p> <p>Note: Make sure that you keep the %FULL-CATEGORY-LIST% metaword in the text to enable the STM to insert the categories that the blocked Web page falls under.</p>	

Table 34. Content Filtering Settings (Continued)

Setting	Description
	<p>As an option, you can select one or both of the following check boxes:</p> <ul style="list-style-type: none"> Allow Users to Submit a "Report a URL Misclassification" Form. When you select this check box, the screen that displays when a user attempts to access blocked content includes a hyperlink to report a URL misclassification. See Click here to Report a URL Misclassification in the Web Category Lookup section later in this table. <p>Note: Make sure that you keep the %SUBMIT-URL-CATEGORIZATION% metaword in the text to enable the STM to insert the actual hyperlink.</p> <ul style="list-style-type: none"> Insert Link to User Login Portal Page. When you select this check box, the screen that displays when a user attempts to access blocked content includes a hyperlink that allows the user to log in as another user: <p style="padding-left: 20px;">You are logged in as %USER% (Click here to login as another user)</p> <p>Note: Make sure that you keep the %LOGIN-LINK% metaword in the text to enable the STM to insert the actual hyperlink.</p>
	<p>The text is displayed on the Content Filtering screen with HTML tags. Click Preview to open a screen that displays the notification text in HTML format.</p>
Web Category Lookup	
URL	<p>Enter a URL to find out if it has been categorized, and if so, in which category. Then click the Lookup button. If the URL has been categorized, the category appears next to Lookup Results.</p>
Clear Web Category Cache	<p>Click Clear Web Category Cache to enable the STM to synchronize with the NETGEAR server and download the most recent Web categorizations.</p> <p>Note: Synchronizing might temporarily slow down the STM's performance because the STM needs to acquire the Web categorizations remotely instead of from its local cache.</p>
Click here to Report a URL Misclassification	<p>To submit a misclassified or uncategorized URL to NETGEAR for analysis, click the Click here to Report a URL Misclassification link. A screen opens that allows you to select from drop-down lists up to two categories in which you think that the URL could be categorized. Then click the Submit button.</p>

4. Click **Apply** to save your settings.

Configuring Web URL Filtering

If you want to allow or block internal LAN users from access to certain sites on the Internet, use the STM's Web URL filtering. You can create or import a whitelist that contains domain names and URLs that are accepted, and a blacklist with domain names and URLs that are blocked. The whitelist takes precedence over the blacklist.

Note: A URL that you enter on the whitelist or blacklist might contain other embedded URLs such as URLs for advertisements or sponsors, causing unexpected behavior. If you want to allow a URL by placing it on the whitelist, make sure that all embedded URLs are also placed on the whitelist. Similarly, if you want to block a URL by placing it on the blacklist, make sure that all embedded URLs are also placed on the blacklist.

Note: For information about creating custom categories that allow you to set access exceptions for combinations of URLs, see [Creating Custom Categories for Web Access Exceptions](#) on page 142.

To configure Web URL filtering:

1. Select **Web Security > HTTP/HTTPS** from the menu. The HTTP/HTTPS submenu tabs display, with the Malware Scan screen in view.
2. Click the **URL Filtering** submenu tab. The URL Filtering screen displays:

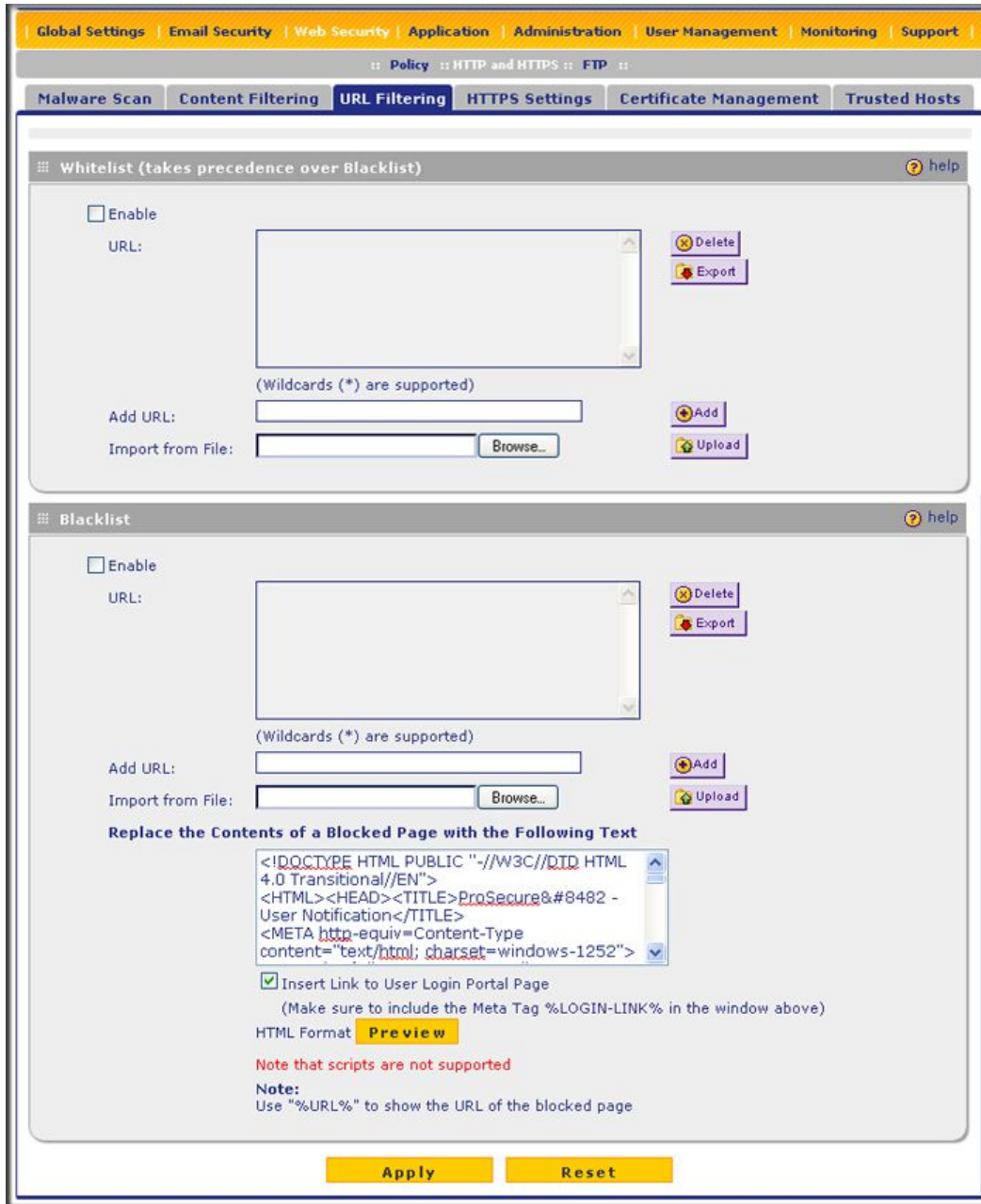

Figure 64.

3. Select the check boxes and complete the fields and as explained in the following table:

Table 35. URL Filtering Settings

Setting	Description	
Whitelist (takes precedence over Blacklist)		
Enable	Select this check box to bypass scanning of the URLs that are listed in the URL field. Users are allowed to access the URLs that are listed in the URL field.	
URL	This field contains the URLs for which scanning is bypassed. To add a URL to this field, use the Add URL field or the Import from File tool (see information later in this table). You can add a maximum of 2000 URLs. Note: If a URL is in both the whitelist and blacklist, then the whitelist takes precedence and URLs on the whitelist are not scanned. Note: Wildcards (*) are supported. For example, if you enter www.net*.com in the URL field, any URL that begins with www.net and ends with .com is allowed.	
	Delete	To delete one or more URLs, highlight the URLs, and click the Delete table button.
	Export	To export the URLs, click the Export table button, and follow the instructions of your browser.
Add URL	Type or copy a URL in the Add URL field. Then click the Add table button to add the URL to the URL field.	
Import from File	To import a list with URLs into the URL field, click the Browse button and navigate to a file in .txt format that contains line-delimited URLs (that is, one URL per line). Then click the Upload table button to add the URLs to the URL field. Note: Any existing URLs in the URL field are overwritten when you import a list of URLs from a file.	
Blacklist		
Enable	Select this check box to block the URLs that are listed in the URL field. Users attempting to access these URLs receive a notification (see information later in this table).	
URL	This field contains the URLs that are blocked. To add a URL to this field, use the Add URL field or the Import from File tool (see information later in this table). You can add a maximum of 2000 URLs. Note: If a URL is in both the whitelist and blacklist, then the whitelist takes precedence and URLs on the whitelist are not scanned. Note: Wildcards (*) are supported. For example, if you enter www.net*.com in the URL field, any URL that begins with www.net and ends with .com is blocked.	
	Delete	To delete one or more URLs, highlight the URLs, and click the Delete table button.
	Export	To export the URLs, click the Export table button and follow the instructions of your browser.

Table 35. URL Filtering Settings (Continued)

Setting	Description
Add URL	Type or copy a URL in the Add URL field. Then click the Add table button to add the URL to the URL field.
Import from File	To import a list with URLs into the URL field, click the Browse button and navigate to a file in .txt format that contains line-delimited URLs (that is, one URL per line). Then click the Upload table button to add the URLs to the URL field. Note: Any existing URLs in the URL field are overwritten when you import a list of URLs from a file.
Replace the Content of a Blocked Page with the Following Text	When a user attempts to access a blocked URL, the STM replaces the content of the blocked URL with the following text, which you can customize: Internet Policy has restricted access to this location: %URL%
	Note: Make sure that you keep the %URL% metaword in the text to enable the STM to insert the category that the blocked Web page falls under. As an option, you can select the Insert Link to User Login Portal Page check box to include a hyperlink on screen that allows the user to log in as another user: You are logged in as %USER% (Click here to login as another user)
	Note: Make sure that you keep the %LOGIN-LINK% metaword in the text to enable the STM to insert the actual hyperlink. The text is displayed on the URL Filtering screen with HTML tags. Click Preview to open a screen that displays the notification text in HTML format.

4. Click **Apply** to save your settings.

HTTPS Scan Settings

HTTPS traffic is encrypted traffic that cannot be scanned or the data stream would not be secure. However, the STM can scan HTTPS traffic that is transmitted through an HTTP proxy. The STM can break up the SSL connection between the HTTPS server and the HTTP client, scan the HTTPS traffic, and then rebuild the SSL connection.

The following figure shows the HTTPS scanning traffic flow:

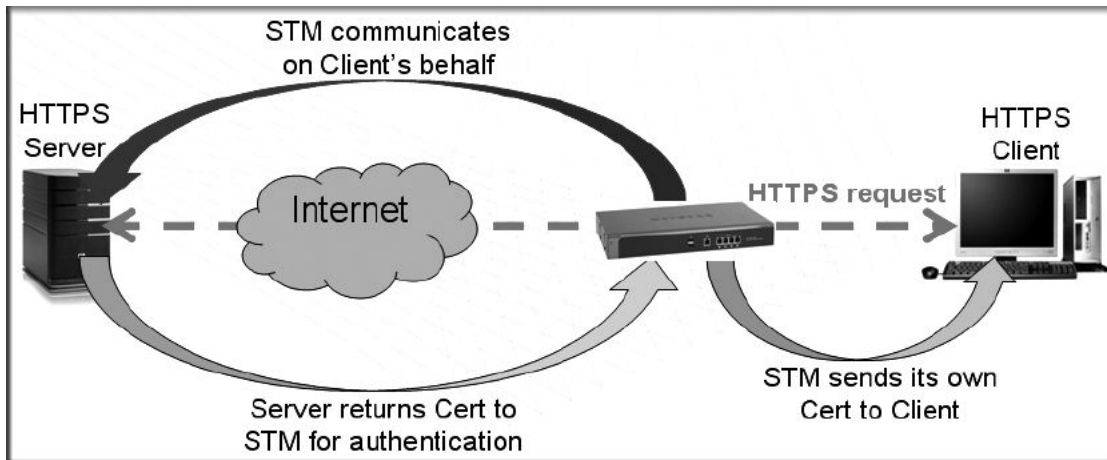

Figure 65.

The HTTPS scanning process functions with the following principles:

- The STM breaks up an SSL connection between an HTTPS server and an HTTP client into two parts:
 - A connection between the HTTPS client and the STM
 - A connection between the STM and the HTTPS server
- The STM simulates the HTTPS server communication to the HTTPS client, including the SSL negotiation, certificate exchange, and certificate authentication. In effect, the STM functions as the HTTPS server for the HTTPS client.
- The STM simulates the HTTPS client communication to the HTTPS server, including the SSL negotiation, certificate exchange, and certificate authentication. In effect, the STM functions as the HTTPS client for the HTTPS server.

During SSL authentication, the HTTPS client authenticates three items:

- Is the certificate trusted?
- Has the certificate expired?
- Does the name on the certificate match that of the website?

If one of these is not satisfied, a security alert message displays in the browser window:



Figure 66.

However, even when a certificate is trusted or still valid, or when the name of a certificate does match the name of the website, a security alert message still displays when a user who is connected to the STM visits an HTTPS site. The appearance of this security alert message is expected behavior because the HTTPS client receives a certificate from the STM instead of directly from the HTTPS server. If you want to prevent this security alert message from displaying, install a root certificate on the client PC. The root certificate can be downloaded from the STM's User Portal Login screen (see [Figure 88](#) on page 156).

If client authentication is required, the STM might not be able to scan the HTTPS traffic because of the nature of SSL. SSL has two parts—client and server authentication. HTTPS server authentication occurs with every HTTPS request, but HTTPS client authentication is not mandatory, and rarely occurs. Therefore it is of less importance whether the HTTPS request comes from the STM or from the real HTTPS client.

However, certain HTTPS servers do require HTTPS client certificate authentication for every HTTPS request. Because of the design of SSL, the HTTPS client needs to present its own certificate in this situation rather than using the one from the STM, preventing the STM from scanning the HTTPS traffic. For information about certificates, see [Managing Digital Certificates](#) on page 76.

You can specify trusted hosts for which the STM bypasses HTTPS traffic scanning. For more information, see [Specifying Trusted Hosts](#) on page 124.

To configure the HTTPS scan settings:

1. Select **Web Security > HTTP/HTTPS** from the menu. The HTTP/HTTPS submenu tabs display, with the Malware Scan screen in view.
2. Click the **HTTPS Settings** submenu tab. The HTTPS Settings screen displays:



Figure 67.

3. Select the check boxes and complete the field and as explained in the following table:

Table 36. HTTPS Settings

Setting	Description
HTTP Tunneling	
<p>Select this check box to allow scanning of HTTPS connections through an HTTP proxy, which is disabled by default. Traffic from trusted hosts is not scanned (see Specifying Trusted Hosts on page 124).</p> <p>Note: For HTTPS scanning to occur correctly, you need to add the HTTP proxy server port in the Ports to Scan field for the HTTPS service on the Services screen (see Configuring the HTTP Proxy Settings on page 60).</p>	
HTTPS SSL Settings	
<p>Select the Allow the STM to handle HTTPS connections using SSLv2 check box to allow HTTPS connections using SSLv2, SSLv3, or TLSv1. If this check box is cleared, the STM allows HTTPS connections using SSLv3 or TLSv1, but SSLv2 connections are dropped by the STM.</p>	
HTTPS 3rd Party Website Certificate Handling	
<p>Select this check box to allow a Secure Sockets Layer (SSL) connection with a valid certificate that is not signed by a trusted Certificate Authority (CA). The default setting is to allow such as a connection.</p>	
Show This Message When an SSL Connection Attempt Fails	
<p>By default, a rejected SSL connection is replaced with the following text, which you can customize:</p> <p style="padding-left: 20px;">The SSL connection cannot be established. URL: %URL% REASON: %REASON%</p> <p>Note: The text is displayed on the HTTPS Settings screen with HTML tags. Click Preview to open a screen that displays the notification text in HTML format.</p> <p>Note: Make sure that you keep the %URL% and %REASON% metawords in the text to enable the STM to insert the correct URL information and the reason of the rejection.</p>	

4. Click **Apply** to save your settings.

Note: For information about certificates that are used for SSL connections and HTTPS traffic, see [Managing Digital Certificates](#) on page 76.

Specifying Trusted Hosts

You can specify trusted hosts for which the STM bypasses HTTPS traffic scanning and security certificate authentication. The security certificate is sent directly to the client for authentication, which means that the user does not receive a security alert for trusted hosts. For more information about security alerts, see [Managing Digital Certificates](#) on page 76.

Note that certain sites contain elements from different HTTPS hosts. As an example, assume that the `https://example.com` site contains HTTPS elements from the following three hosts:

- `trustedhostserver1.example.com`
- `trustedhostserver2.example.com`
- `imageserver.example.com`

To completely bypass the scanning of the `https://example.com` site, you need to add all three hosts to the trusted hosts list because different files from these three hosts are also downloaded when a user attempts to access the `https://example.com` site.

To specify trusted hosts:

1. Select **Web Security > HTTP/HTTPS** from the menu. The HTTP/HTTPS submenu tabs display, with the Malware Scan screen in view.
2. Click the **Trusted Hosts** submenu tab. The Trusted Hosts screen displays. (The following figure contains an example.)

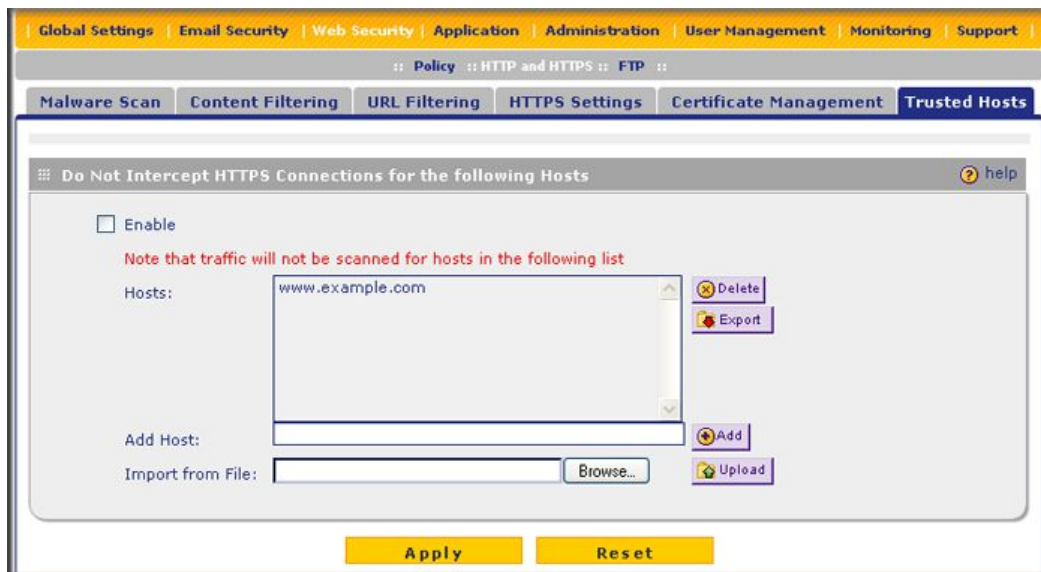

Figure 68.

3. Complete the fields and select the check box as explained in the following table:

Table 37. Trusted Hosts Settings

Setting	Description	
Do Not Intercept HTTPS Connections for the following Hosts		
Enable	Select this check box to bypass scanning of trusted hosts that are listed in the Hosts field. Users do not receive a security alert for trusted hosts that are listed in the Hosts field.	
Hosts	This field contains the trusted hosts for which scanning is bypassed. To add a host to this field, use the Add Host field or the Import from File tool (see later in this table). You can add a maximum of 200 hosts.	
	Delete	To delete one or more hosts, highlight the hosts, and click the Delete table button.
	Export	To export the hosts, click the Export table button and follow the instructions of your browser.
Add Host	Type or copy a trusted host in the Add Host field. Then click the Add table button to add the host to the Hosts field.	
Import from File	To import a list with trusted hosts into the Hosts field, click the Browse button and navigate to a file in .txt format that contains line-delimited hosts (that is, one host per line). Then click the Upload table button to add the hosts to the Host field. Note: Any existing hosts in the Hosts field are overwritten when you import a list of hosts from a file.	

4. Click **Apply** to save your settings.

Configuring FTP Scans

Some malware threats are specifically developed to spread through the FTP protocol. By default, the STM scans FTP traffic, but you can specify how the STM scans FTP traffic and which action is taken when a malware threat is detected.

Note: The STM does not scan password-protected FTP files.

To configure the FTP scan settings:

1. Select **Web Security > FTP** from the menu. The FTP screen displays:

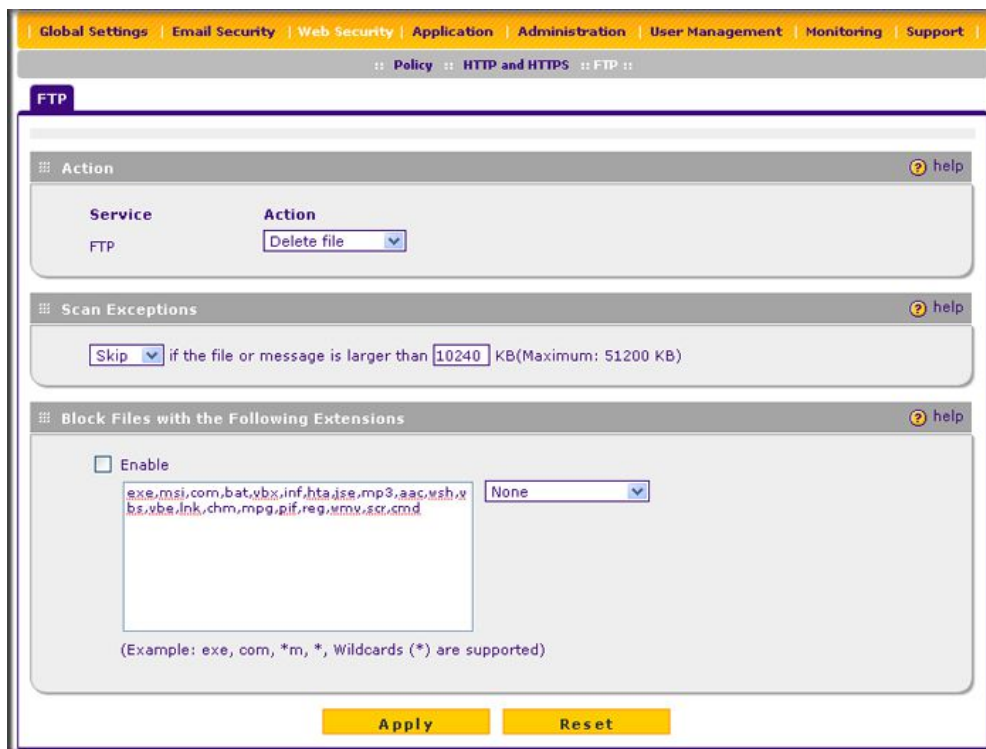

Figure 69.

2. Complete the fields, select the check boxes, and make your selections from the drop-down lists as explained in the following table:

Table 38. FTP Scan Settings

Setting	Description	
Action		
FTP	Action	<p>From the FTP drop-down list, specify one of the following actions to be taken when an infected FTP file or object is detected:</p> <ul style="list-style-type: none"> • Quarantine file. The FTP file or object is placed in quarantine, a malware quarantine log entry is created, and depending on the nature of the malware threat, also a virus log entry or a spyware log entry. • Delete file. This is the default setting. The FTP file or object is deleted, and depending on the nature of the malware threat, a virus log entry or a spyware log entry is created. • Log only. Depending on the nature of the malware threat, only a virus log entry or a spyware log entry is created. The FTP file or object is not deleted.

Table 38. FTP Scan Settings (Continued)

Setting	Description
Scan Exception	
<p>From the drop-down list, specify one of the following actions to be taken when a file or object exceeds the size that you specify in the file size field:</p> <ul style="list-style-type: none"> • Skip. The file or object is not scanned but skipped, leaving the end user vulnerable. This is the default setting. • Block. The file or object is blocked and does not reach the end user. <p>The default and maximum file sizes are as follows:</p> <ul style="list-style-type: none"> • For the STM600 and STM300, the default setting is to block any file or object larger than 10240 KB. The maximum file size that you can specify is 51200 KB. • For the STM150, the default setting is to block any file or object larger than 8192 KB. The maximum file size that you can specify is 25600 KB. <p>Note: Setting the maximum file size to a high value might affect the STM's performance. NETGEAR recommends the default value, which is sufficient to detect the vast majority of threats.</p>	
Block Files with the Following Extensions	
<p>Select the check box to enable file extension blocking. By default, the File Extension field lists the most common file extensions that are detected. You can manually add or delete extensions. Use commas to separate different extensions.</p> <p>You can also use the drop-down list to add predefined file extensions from a specific category to the File Extension field:</p> <ul style="list-style-type: none"> • None. No file extensions are added to the File Extension field. This is the default setting. • Executables. Executable file extensions (exe, com, dll, so, lib, scr, bat, and cmd) are added to the File Extension field. • Audio/Video. Audio and video file extensions (wav, mp3, avi, rm, rmvb, wma, wmv, mpg, mp4, and aac) are added to the File Extension field. • Compressed Files. Compressed file extensions (zip, rar, gz, tar, and bz2) are added to the File Extension field. 	

3. Click **Apply** to save your settings.

Configuring Application Control

The STM lets you control user access to Web applications such as instant messaging, media, peer-to-peer services, and online tools. Blocking an application prohibits all traffic to and from the application, which can be useful when you want to control the STM's throughput. By default, none of the applications are blocked.

Note: For information about creating custom categories that allow you to set access exceptions for combinations of applications, see [Creating Custom Categories for Web Access Exceptions](#) on page 142.

To enable and configure application control:

1. Select **Application** from the menu. The Application Control screen displays.

Because of the size of this screen, and because of the way the information is presented, the Application Control screen is divided and presented in this manual in three figures: the following figure shows only the very top part of the screen, [Figure 71](#) on page 129 shows the Instant Messaging and Media Application sections, and [Figure 72](#) on page 129 shows the Peer to Peer and Tools sections.



Figure 70. Application Control, screen 1 of 3

2. In the Application Settings section of the screen, select the **Enable Application Control** check box.
3. Under the Application Settings section of the screen, click **Apply**. The configurations of the individual applications can now take effect.
4. For each of the four application sections on the screen—Instant Messaging, Media Applications, Peer to Peer, and Tools—select the **Block** check box to specify to block all applications for that section, or select the individual check boxes to specify to block individual applications.

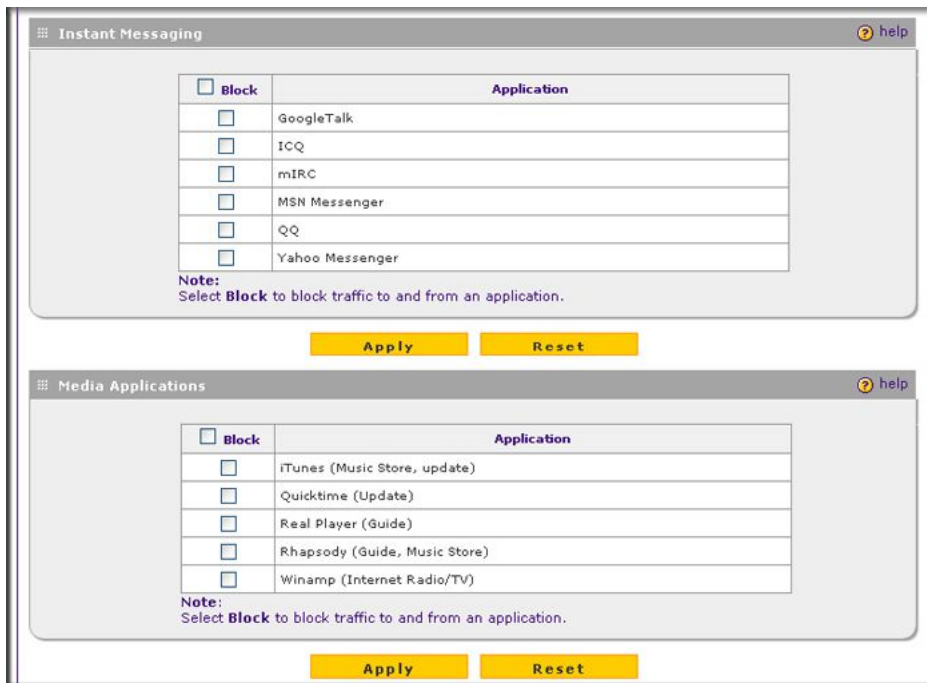

Figure 71. Application Control, screen 2 of 3

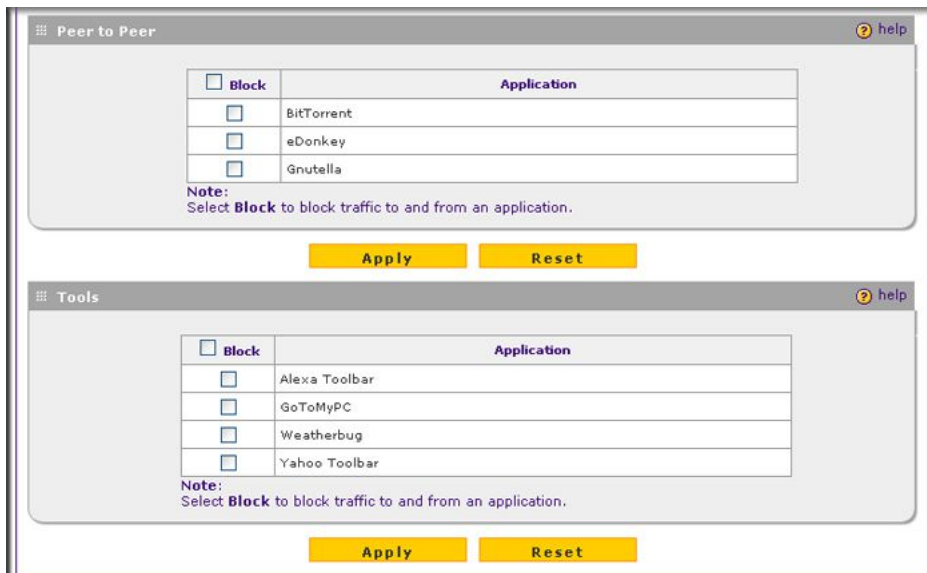

Figure 72. Application Control, screen 3 of 3

5. After you have configured each section, first click **Apply** to save the settings before you continue with the next section. You need to save the configuration changes for each section individually.

For reference, you can specify access control for the following applications:

- Instant Messaging:
 - Google Talk
 - ICQ
 - mIRC
 - MSN Messenger
 - QQ
 - Yahoo Messenger
- Media Applications:
 - iTunes (Music Store, update)
 - Quicktime (Update)
 - Real Player (Guide)
 - Rhapsody (Guide, Music Store)
 - Winamp (Internet Radio/TV)
- Peer to Peer:
 - BitTorrent
 - eDonkey
 - Gnutella
- Tools
 - Alexa Toolbar
 - GoToMyPC
 - Weatherbug
 - Yahoo Toolbar

Setting Scanning Exclusions and Web Access Exceptions

After you have specified which IP addresses and ports the STM scans for malware threats, you can set scanning exclusion rules for certain IP addresses and ports. Similarly, after you have specified which content the STM filters, you can set exception rules for users and members of a group.

Setting Scanning Exclusions

To save resources, you can configure scanning exclusions for IP addresses and ports that you know are secure. For example, if your network includes a Web server that hosts Web pages that are accessible by anyone on the Internet, the files that are hosted by your Web server do not need to be scanned. To prevent the STM from scanning these files, you can configure up to 127 scanning exclusion rules for your Web server.

To configure scanning exclusion rules:

1. Select **Global Settings > Scanning Exclusions** from the menu. The Scanning Exclusions screen displays. This screen shows the Scanning Exclusions table, which is empty if you have not specified any exclusions. (The following figure shows one exclusion rule in the table as an example.)



Figure 73.

2. In the Scanning Exclusions section of the screen, specify an exclusion rule as explained in the following table:

Table 39. Add Scanning Exclusion Settings

Setting	Description
Client IP	The client IP address and optional subnet mask that are excluded from all scanning.
Destination IP	The destination IP address and optional subnet mask that are excluded from all scanning.
Port	The number of the port that is excluded from all scanning.
Brief Description	A description of the exclusion rule for identification and management purposes.

3. In the Add column, click the **Add** table button to add the exclusion rule to the Scanning Exclusions table. The new exclusion rule is enabled by default.

To disable a rule, select the check box in the Enable column for the rule.

To delete an exclusion rule from the Scanning Exclusions table, click the **Delete** table button in the Action column to the right of the rule that you want to delete.

Setting Access Exception Rules for Web Access

You can set up to 200 exception rules for users and members of a group to allow access to applications, file extensions and protocols, Web categories, and URLs that you have blocked for all other users, or the other way around, to block access to applications, file extensions and protocols, Web categories, and URLs that you have allowed access to for all other users.

If you have not created a custom group, an exception rule can apply to either *one* of the following groups or individual users:

- All users
- All authenticated users
- All unauthenticated users
- A local group or local user
- A group or users that is defined by its IP address
- A Lightweight Directory Access Protocol (LDAP) group or LDAP user
- A RADIUS VLAN group

To further refine exception rules, you can create custom groups that allow you to include a combination of local groups and local users, groups and users that are defined by their IP address, LDAP groups and users, and RADIUS groups and users. For more information, see [Creating Custom Groups for Web Access Exceptions](#) on page 139.

Note: Users and groups to which access exception rules apply are not the same as LAN groups. For information about how to specify members of a LAN group and to customize LAN group names, see [Managing Users, Groups, and Authentication](#) on page 147.

If you have not created a custom category, an exception rule can apply to either *one* of the following components:

- One built-in application group or built-in individual application
- A combination of files extensions and protocols
- One URL or URL expression
- One built-in Web category group or built-in individual Web category

To further refine exception rules, you can create custom categories that allow you to include either a selection of applications, or a selection of URLs, or a selection of Web categories. For more information, see [Creating Custom Categories for Web Access Exceptions](#) on page 142.

Tip: If you want to use a custom group and custom category, first create the custom group and custom category, then create the exception rule.

To set Web access exception rules:

1. Select **Global Settings > Exceptions** from the menu. The Exceptions submenu tabs display, with the Exceptions screen in view. This screen shows the Exceptions table, which is empty if you have not specified any exception rules. (The following figure shows several exception rules in the table as an example.)

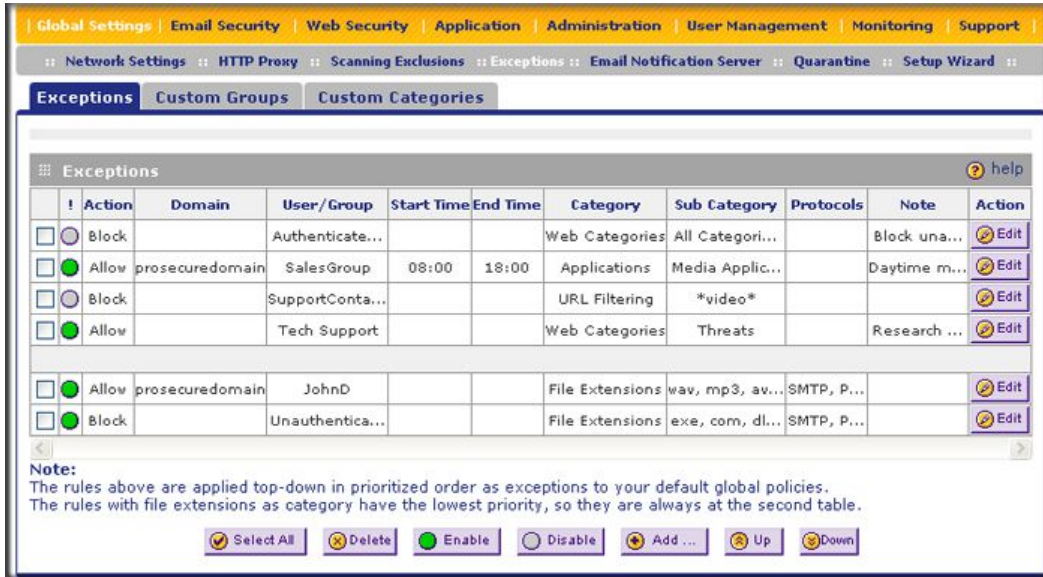

Figure 74.

Note: If text in a field of the table exceeds the width of the column, hold the cursor over the field to display the entire text.

2. Under the Exceptions table, click the **Add** table button to specify an exception rule. The Add Exception screen displays:

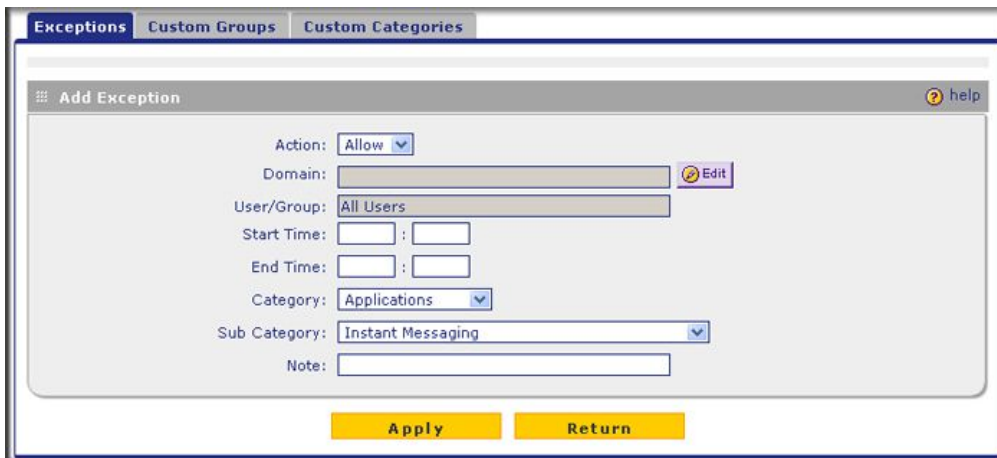

Figure 75.

- Complete the fields and make your selections from the drop-down lists as explained in the following table:

Table 40. Add Exception Settings

Setting	Description
Action	<p>From the drop-down list, select the action that the STM applies:</p> <ul style="list-style-type: none"> Allow. The exception allows access to an application, Web category, or URL that is otherwise blocked. Block. The exception blocks access to an application, Web category, or URL that is otherwise allowed.
Domain User/Group	<p>Click the Edit button to open the Applies To screen, which lets you configure a domain, group, or individual user to which the exception needs to apply (see the screen later in this table).</p> <p>If applicable, on the Applies To screen, click a Lookup button to retrieve a group or user. When you have made your decision, click an Apply button to add the domain to the Domain field on the Add Exception screen and the group and user to the User/Group field on the Add Exception screen.</p> <p>Note: The Domain field can remain blank for some special users or groups.</p> <p>Following are the options on the Applies To screen.</p> 

Table 40. Add Exception Settings (Continued)

Setting	Description	
Domain User/Group (continued)	All Users	Click the Apply button to apply the exception to all users, both authenticated and unauthenticated.
	Authenticated	Click the Apply button to apply the exception to all authenticated users. These are users who have actively logged in to the STM and who have been authenticated.
	Unauthenticated	Click the Apply button to apply the exception to all unauthenticated users. These are users who have not actively logged in to the STM. By default, these users are assigned the account name anonymous.
	Local Groups	<p>Do the following:</p> <ol style="list-style-type: none"> From the Name drop-down list, select a local group. Click the Apply button to apply the exception to the selected local group. <p>You can specify local groups on the Groups screen (see Creating and Deleting Groups by Name on page 149).</p>
	Group Membership by IP	<p>Do the following:</p> <ol style="list-style-type: none"> From the Name drop-down list, select a group that is defined by its IP address. Click the Apply button to apply the exception to the selected group. <p>You can specify groups that are defined by their IP address on the IP/Subnet Groups screen (see Creating and Deleting Groups by IP Address and Subnet on page 151).</p>
	Local User Search	<p>Do the following:</p> <ol style="list-style-type: none"> In the Name field, enter a user name. Click the Lookup button. If the user is found, he or she is listed to the left of the Apply button. Click the Apply button to apply the exception to the selected user.

Table 40. Add Exception Settings (Continued)

Setting	Description	
Domain User/Group (continued)	LDAP User/Group Search	<p>Do the following:</p> <ol style="list-style-type: none"> From the Domain drop-down list, select an LDAP domain. From the Type drop-down list, select User, Group, or User&Group. In the Name field, enter the name of the user, group, or user and group, or leave this field blank. Click the Lookup button. If the user or group is found, it is listed to the left of the Apply button. If you left the Name field blank, all users, groups, or users and groups are listed; in this case, make a selection. Click the Apply button to apply the exception to the selected user or group. <p>You can specify LDAP domains, groups, and users on the LDAP screen (see Creating and Deleting LDAP and Active Directory Domains on page 161).</p>
	RADIUS User	<p>Do the following:</p> <ol style="list-style-type: none"> From the Domain drop-down list, select a RADIUS domain. From the VLAN ID/Name drop-down list, select a VLAN ID or VLAN name. Click the Apply button to apply the exception to the selected VLAN. <p>You can specify RADIUS domains and VLANs on the RADIUS screen (see Creating and Deleting RADIUS Domains on page 167).</p>
	Custom Groups	<p>Do the following:</p> <ol style="list-style-type: none"> From the Name drop-down list, select a custom group. Click the Apply button to apply the exception to the selected group. <p>You can specify custom groups on the Custom Groups screen (see Creating Custom Groups for Web Access Exceptions on page 139).</p>
Start Time	The time in 24-hour format (hours and minutes) when the action starts. If you leave these fields empty, the action applies continuously.	
End Time	The time in 24-hour format (hours and minutes) when the action ends. If you leave these fields empty, the action applies continuously.	

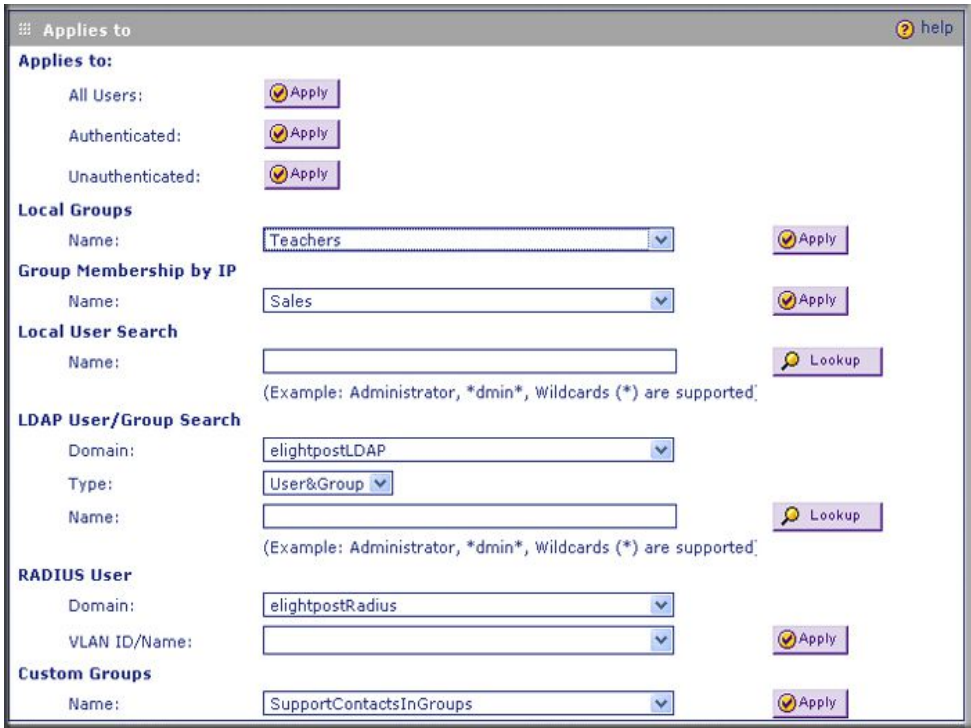
Table 40. Add Exception Settings (Continued)

Setting	Description	
Category (and related information)	From the Category drop-down list, select the category to which the action applies. Your selection determines which drop-down lists, fields, radio buttons, and check boxes display onscreen.	
	Applications	The action applies to an application. Select an application from the Sub Category drop-down list. For information about custom application categories, see Creating Custom Categories for Web Access Exceptions on page 142.
	File Extensions	<p>The action applies to one or more file extensions and one or more protocols. The following field and check boxes display on screen:</p> <ul style="list-style-type: none"> • File Extensions. Manually enter up to 40 file extensions. Use commas to separate multiple file extensions. Wildcards (*) are supported. A single asterisk (*) matches any file extension. You can also use the drop-down list to the right of the File Extension field to automatically add file extensions from the following categories: <ul style="list-style-type: none"> - None. No file extensions are added to the File Extension field. This is the default setting. - Executables. Executable file extensions (exe, com, dll, so, lib, scr, bat, and cmd) are added to the File Extension field. - Audio/Video. Audio and video file extensions (wav, mp3, avi, rm, rmvb, wma, wmv, mpg, mp4, and aac) are added to the File Extension field. - Compressed Files. Compressed file extensions (zip, rar, gz, tar, and bz2) are added to the File Extension field. • Protocols. Select one or multiple check boxes to specify which protocols the action applies to: <ul style="list-style-type: none"> - SMTP - POP3 - IMAP - HTTP - HTTPS - FTP
	URL Filtering	<p>The action applies to a URL. The following field and drop-down list display onscreen. Select a radio button to either enter a URL expression or select a custom URL list.</p> <ul style="list-style-type: none"> • URL Expression. Enter a URL or URL expression such as *video* or *chat*. Wildcards (*) are supported. The maximum supported size of the URL or URL expression is 1024 bytes. • Custom URL List. Select a custom URL list from the Sub Category drop-down list. <p>For information about custom URL lists, see Creating Custom Categories for Web Access Exceptions on page 142.</p>

Table 40. Add Exception Settings (Continued)

Setting	Description	
Category (and related information) (continued)	Web Categories	The action applies to a Web category. Select a Web category from the Sub Category drop-down list. For information about custom Web categories, see Creating Custom Categories for Web Access Exceptions on page 142.
Note	A description of the exception rule for identification and management purposes or any other relevant information that you wish to include.	

4. Click **Apply** to save your settings. The new exception rule is added to the Exceptions table. To return to the Exception screen without adding the rule, click **Return**.
5. Select the check box to the left of the rule that you want to enable, or click the **Select All** table button to select all rules.
6. Click the **Enable** table button to enable the selected rule or rules.

Note: Enabled exception rules are preceded by a green circle in the ! column; disabled exception rules are preceded by a gray circle in the ! column.

To make changes to an existing exception rule:

1. In the Action column to the right of to the exception rule, click the **Edit** table button. The Edit Exception screen displays. This screen is identical to the Add Exception screen (see [Figure 74](#) on page 133).
2. Modify the settings that you wish to change (see the previous table).
3. Click **Apply** to save your changes. The modified exception rule is displayed in the Exceptions table.

To delete or disable one or more exception rules:

1. Select the check box to the left of the rule that you want to delete or disable, or click the **Select All** table button to select all rules.
2. Click one of the following table buttons:
 - **Disable.** Disables the rule or rules. The ! status icon changes from a green circle to a gray circle, indicating that the rule is or rules are disabled. (By default, when a rule is added to the table, it is automatically enabled.)
 - **Delete.** Deletes the rule or rules.

The table rank of the exception rule in the Exceptions table determines the order in which the rule is applied (from the top down). To change the position of the rules in the table, select one or more a rules, and then click one of the following table buttons:

- **Up.** Moves the rule or rules up one position in the table rank.
- **Down.** Moves the rule or rules down one position in the table rank.

Creating Custom Groups for Web Access Exceptions

After you have specified groups and users (see *Managing Users, Groups, and Authentication* in Chapter 5), you can create up to 200 custom groups, each of which can include a combination of local groups and local users, groups and users that are defined by their IP address, LDAP groups and users, and RADIUS groups and users. You use these custom groups to set Web access exceptions on the Exceptions screen (see *Setting Access Exception Rules for Web Access* on page 132).

To create and manage custom groups:

1. Select **Global Settings > Exceptions** from the menu. The Exceptions submenu tabs display, with the Exceptions screen in view.
2. Click the **Custom Groups** submenu tab. The Custom Groups screen displays. This screen shows the Custom Groups table, which is empty if you have not specified any custom groups. (The following figure shows one custom group in the table as an example.)

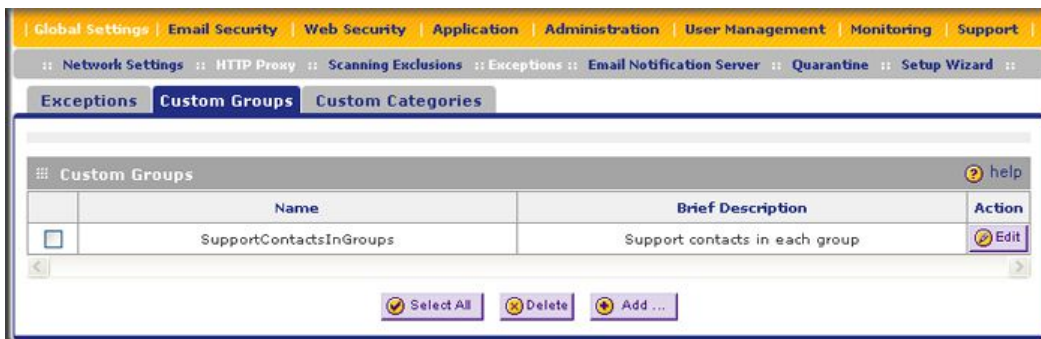

Figure 76.

- Under the Custom Groups table, click the **Add** table button to specify a custom group. The Add Custom Group screen displays:

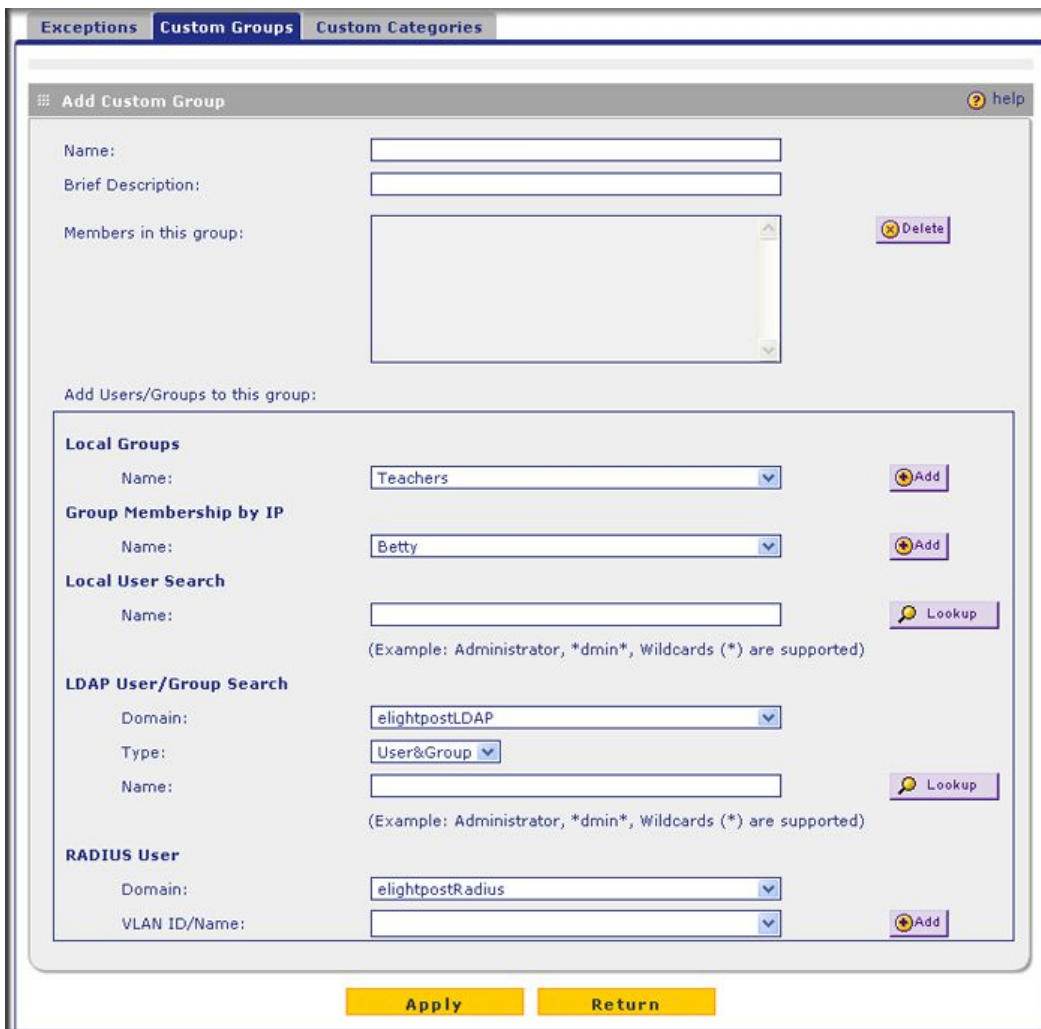

Figure 77.

- Complete the fields and make your selections from the drop-down lists as explained in the following table:

Table 41. Add Custom Group Settings

Setting	Description
Name	A name of the custom group for identification and management purposes.
Brief Description	A description of the custom group for identification and management purposes.
Members in this group	When you click the Add button in the Add Users/Groups to this group section of the screen, the selected member is added to this field. You can add multiple members. To remove a member, highlight the member in this field, and then click the Delete button.

Table 41. Add Custom Group Settings (Continued)

Setting	Description	
Add Users/Groups to this group	Local Groups	<p>Do the following:</p> <ol style="list-style-type: none"> 1. From the Name drop-down list, select a local group. 2. Click the Add button to add the selected local group to the custom group. Repeat this step to add more local groups to the custom group. <p>You can specify local groups on the Groups screen (see Creating and Deleting Groups by Name on page 149).</p>
	Group Membership by IP	<p>Do the following:</p> <ol style="list-style-type: none"> 1. From the Name drop-down list, select a group that is defined by its IP address. 2. Click the Add button to add the selected group to the custom group. Repeat this step to add more users or groups, or both, to the custom group. <p>You can specify groups that are defined by their IP address on the IP/Subnet Groups screen (see Creating and Deleting Groups by IP Address and Subnet on page 151).</p>
	Local User Search	<p>Do the following:</p> <ol style="list-style-type: none"> 1. In the Name field, enter a user name. 2. Click the Lookup button. If the user is found, he or she is listed to the left of the Apply button. 3. Click the Add button to add the selected local user to the custom group. Repeat this step to add more local users to the custom group.
	LDAP User/Group Search	<p>Do the following:</p> <ol style="list-style-type: none"> 1. From the Domain drop-down list, select an LDAP domain. 2. From the Type drop-down list, select User, Group, or User&Group. 3. In the Name field, enter the name of the user, group, or user and group, or leave this field blank. 4. Click the Lookup button. If the user or group is found, it is listed to the left of the Add button. If you left the Name field blank, all users, groups, or users and groups are listed. In this case, make a selection. 5. Click the Add button to add the selected user or group to the custom group. Repeat this step to add more users or groups, or both, to the custom group. <p>You can specify LDAP domains, groups, and users on the LDAP screen (see Creating and Deleting LDAP and Active Directory Domains on page 161).</p>

Table 41. Add Custom Group Settings (Continued)

Setting	Description	
Add Users/Groups to this group (continued)	RADIUS User	<p>Do the following:</p> <ol style="list-style-type: none"> 1. From the Domain drop-down list, select a RADIUS domain. 2. From the VLAN ID/Name drop-down list, select a VLAN ID or VLAN name. 3. Click the Add button to add the selected VLAN ID or VLAN name to the custom group. Repeat this step to add more VLAN IDs or VLAN names to the custom group. <p>You can specify RADIUS domains and VLANs on the RADIUS screen (see <i>Creating and Deleting RADIUS Domains</i> on page 167).</p>

5. After you have specified all members of the custom group, click **Apply** to save your settings. The new custom group is added to the Custom Groups table. To return to the Custom Groups screen without adding the group, click **Return**.

To make changes to an existing custom group:

1. In the Action column to the right of the custom group, click the **Edit** table button. The Edit Custom Group screen displays. This screen is identical to the Add Custom Group screen (see *Figure 77* on page 140).
2. Modify the settings that you wish to change (see the previous table).
3. Click **Apply** to save your changes. The modified custom group is displayed in the Custom Groups table.

To delete one or more custom groups:

1. Select the check box to the left of the custom group that you want to delete, or click the **Select All** table button to select all custom groups.
2. Click the **Delete** table button.

Creating Custom Categories for Web Access Exceptions

Use custom categories to set Web access exceptions on the Exceptions screen (see *Setting Access Exception Rules for Web Access* on page 132). Custom categories can include a selection of applications, or a selection of URLs, or a selection of Web categories, but no combination of applications, URLs, and Web categories. You can create up to 200 custom categories.

To create and manage custom categories:

1. Select **Global Settings > Exceptions** from the menu. The Exceptions submenu tabs display, with the Exceptions screen in view.
2. Click the **Custom Categories** submenu tab. The Custom Categories screen displays. This screen shows the Custom Categories table, which is empty if you have not specified any custom categories. (The following figure shows three custom categories in the table as an example.)



Figure 78.

3. Under the Custom Categories table, click the **Add** table button to specify a custom category. The Add Custom Category screen displays. The nature of the screen depends on your selection from the Category Type drop-down list, which is set by default to Applications (this selection is shown in the following figure). The URL Filtering and Web Categories settings are shown in [Figure 80](#) on page 144 and [Figure 81](#) on page 144 respectively.

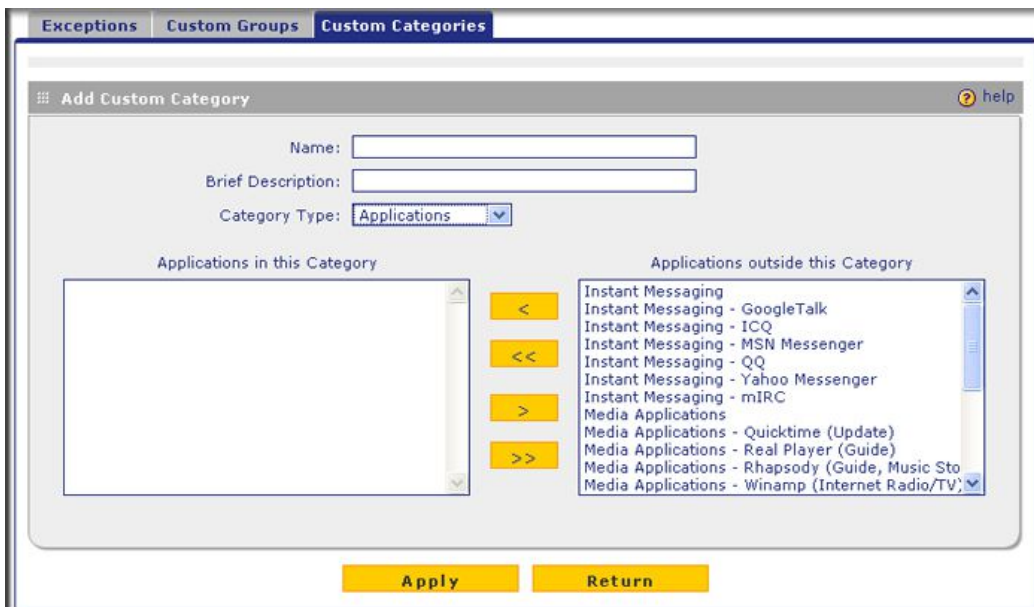

Figure 79. Category Type: Applications

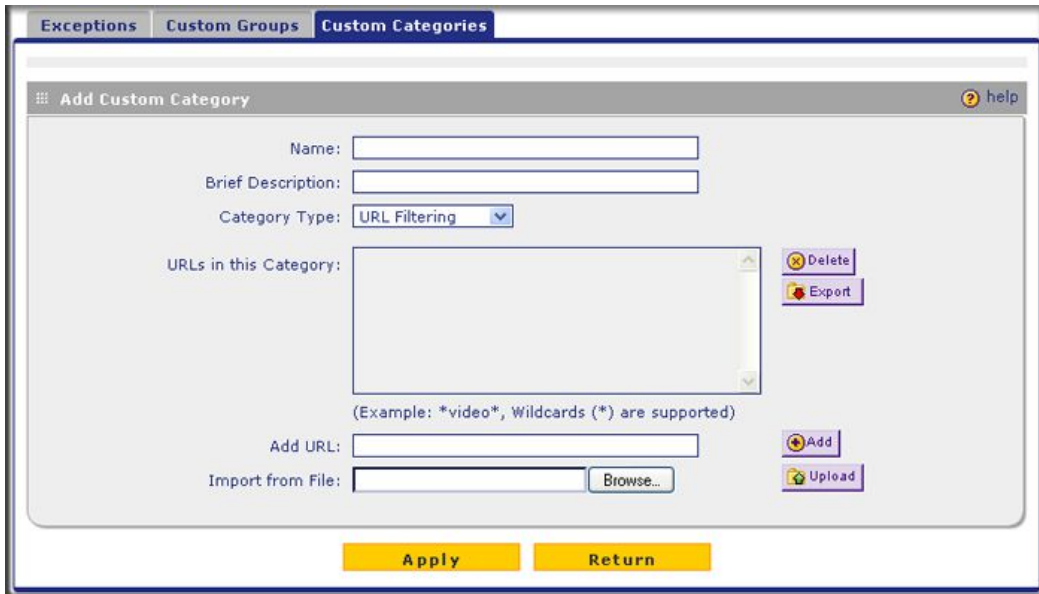

Figure 80. Category Type: URL Filtering

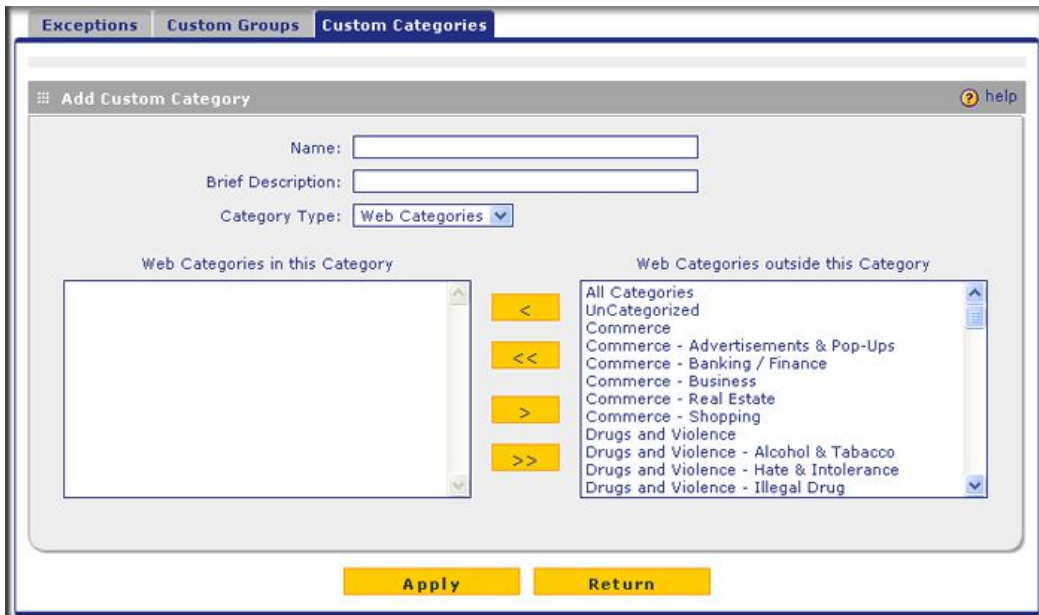

Figure 81. Category Type: Web Categories

- Complete the fields and make your selections from the drop-down lists as explained in the following table:

Table 42. Add Custom Category Settings

Setting	Description
Name	A name of the custom category for identification and management purposes.
Brief Description	A description of the category group for identification and management purposes.
Category Type	From the Category Type drop-down list, select the type of category that you want to create. Your selection determines the nature of the screen.
	<p>Applications</p> <p>Use the move buttons to move entire application categories (for example, Instant Messaging), individual applications (for example, Instant Messaging - Google Talk), or combinations of both from the Applications outside this Category field to the Applications in this Category field (or the other way around).</p> <p>These are the functions of the move buttons:</p> <ul style="list-style-type: none"> • < or > moves one or more highlighted selections from one field to the other. • << or >> moves all entries from one field to the other.
	<p>URL Filtering</p> <p>URLs in this Category field:</p> <p>This field contains the URLs that are added to the custom category. To add a URL to this field, use the Add URL field or the Import from File tool (see explanations later in this table). You can add a maximum of 2000 URLs.</p> <p>Note: Wildcards (*) are supported. For example, if you enter www.net*.com in the Add URL field and then click the Add table button, any URL that begins with www.net and ends with .com is included in the custom category.</p> <p>These are the functions of the table buttons to the right of the field:</p> <ul style="list-style-type: none"> • Delete. To delete one or more URLs, highlight the URLs, and click the Delete table button. • Export. To export the URLs, click the Export table button, and follow the instructions of your browser.
	<p>Add URL field:</p> <p>Type or copy a URL in the Add URL field. Then click the Add table button to add the URL to the URLs in this Category field.</p>
<p>Import from File field:</p> <p>To import a list with URLs into the URLs in this Category field, click the Browse button and navigate to a file in .txt format that contains line-delimited URLs (that is, one URL per line). Then click the Upload table button to add the URLs to the URLs in this Category field.</p> <p>Note: Any existing URLs in the URLs in this Category field are overwritten when you import a list of URLs from a file.</p>	

Table 42. Add Custom Category Settings (Continued)

Setting	Description	
Category Type (continued)	Web Categories	Use the move buttons to move entire Web categories (for example, Commerce), individual applications (for example, Commerce - Shopping), or combinations of both from the Web Categories outside this Category field to the Web Categories in this Category field (or the other way around). These are the functions of the move buttons: <ul style="list-style-type: none"> • < or > moves one or more highlighted selections from one field to the other. • << or >> moves all entries from one field to the other.

5. Click **Apply** to save your settings. The new category is added to the Custom Categories table. To return to the Custom Categories screen without adding the category, click **Return**.

To make changes to an existing custom category:

1. In the Action column to the right of the custom category, click the **Edit** table button. The Edit Custom Category screen displays. This screen is identical to the Add Custom Category screen (see [Figure 77](#) on page 140).
2. Modify the settings that you wish to change (see the previous table).
3. Click **Apply** to save your changes. The modified custom group is displayed in the Custom Categories table.

To delete one or more custom categories:

1. Select the check box to the left of the custom category that you want to delete, or click the **Select All** table button to select all custom categories.
2. Click the **Delete** table button.

Managing Users, Groups, and Authentication

5

This chapter describes how to manage users, groups, and authentication on the STM. This chapter contains the following sections:

- *About Users, Groups, and Domains* on this page
- *Configuring Groups* on page 148
- *Configuring User Accounts* on page 152
- *Configuring Authentication* on page 154
- *Global User Settings* on page 170
- *Viewing and Logging Out Active Users* on page 172

About Users, Groups, and Domains

Users can be individual users or can be part of a group, and a group is generally part of a domain. Normally, you first create a domain, then you create a group that you assign to a domain, and then you create users that you assign to a group. The STM does not let you create domains; the local groups that you define are automatically assigned to the STM's `prosecuredomain` default domain. However, you can use existing LDAP and RADIUS domains on the STM.

The main purpose for using groups and domains is to apply exceptions (that is, adding or removing restrictions) for Web browsing, URL access, and application access (see *Setting Access Exception Rules for Web Access* on page 132).

Note: For information about a different type of users—those with administrative and guest privileges—see *About Users with Administrative and Guest Privileges* on page 61.

The STM supports both unauthenticated and authenticated users:

- **Unauthenticated users.** Anonymous users who do not log in to the STM and to which the STM's default email and Web access policies apply.
- **Authenticated users.** Users who have a computer behind the STM, who log in to the STM with a user name and password, and who are assigned an access policy that normally differs from the STM's default email and Web access policies. Different users or user groups can have different access policies, so there can be multiple access policies on the STM.

In addition to being authenticated as individual users, users can be authenticated on the STM according to group membership or IP address:

- **Group membership.** A group is defined in the STM's local database, an LDAP database, or a RADIUS database. If you use a RADIUS database for authentication, a group can also be defined in a VLAN.
- **IP address.** A group is defined by its IP address and subnet.

Note: For detailed information about authentication, see [Configuring Authentication](#) on page 154.

The login window that is presented to this type of users is the User Portal Login screen (see [Figure 88](#) on page 156), which requires three items: a user name, a password, and a domain selection. The domain determines the authentication method that needs to be used—LDAP, Active Directory, RADIUS, or the STM's local database.

Configuring Groups

The use of groups simplifies the application of exception policies that allow different sets of users to have different Internet access restrictions. Rather than applying the same exception to each user, it is easier to apply a single exception to the entire group. For information about exception policies, see [Setting Access Exception Rules for Web Access](#) on page 132.

Note: For information about custom groups that allow you to set access exceptions for a combination of local groups and local users, groups and users that are defined by their IP address, LDAP groups and users, and RADIUS groups and users, see [Creating Custom Groups for Web Access Exceptions](#) on page 139.

You can define groups either by name or by IP address and subnet:

- **Groups defined by name.** These are local groups on the STM to which you can add users from the STM's local user database. Local groups are automatically assigned to the STM's prosecuredomain default domain.

Note: For information about groups that are defined by VLANs, see *Creating and Deleting VLANs for Use with RADIUS Domains* on page 170.

- **Groups defined by IP address and subnet.** These are groups that can be on your local network or on a remote device.

Note: If you use groups on a remote device, you need to configure your network's firewall to allow access to the IP address and subnet mask that have been assigned to the remote group.

Creating and Deleting Groups by Name

To create a local group by name:

1. Select **User Management > Groups** from the menu. The Groups screen displays. (The following figure contains one example.)

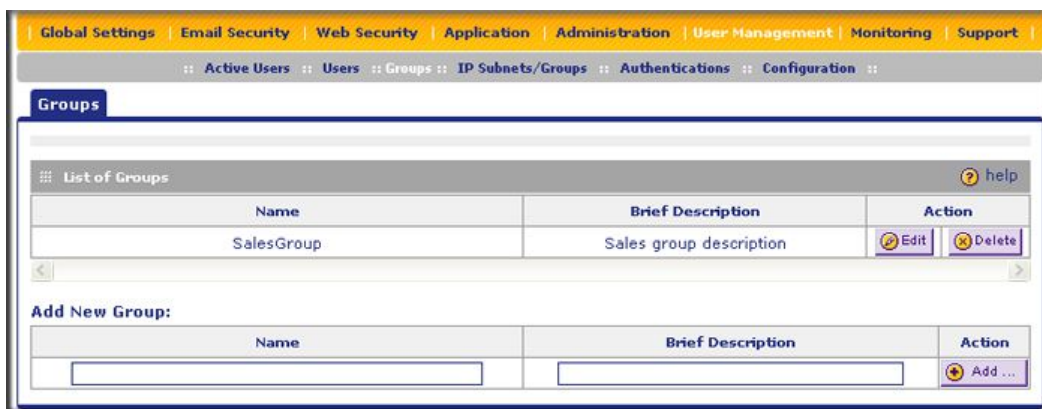

Figure 82.

The List of Groups table displays the local groups with the following fields:

- **Name.** The name of the group, which is the defining characteristic of the group.
- **Brief Description.** An optional brief description of the group.
- **Action.** The Edit table button, which provides access to the Edit Group screen, and the Delete table button, which allows you to delete the group.

- In the Add New Group section of the screen, complete the fields as explained in the following table:

Table 43. Group Settings

Setting	Description
Name	A descriptive (alphanumeric) name of the group for identification and management purposes.
Description	A brief description of the group for identification and management purposes. This description is optional.

- Click the **Add** table button. The new group is added to the List of Groups table.

To delete a group from the List of Groups table, click the **Delete** table button in the Action column for the group that you want to delete.

Note: When you delete a group, an exception rule that is associated with this group no longer has any effect. You can delete such an exception rule.

Editing Groups by Name

To edit a local group that you created by name:

- Select **User Management > Groups** from the menu. The Groups screen displays (see the previous figure).
- In the Action column of the List of Groups table, click the **Edit** table button for the group that you want to edit. The Edit Group screen displays. (The following figure contains some examples.)

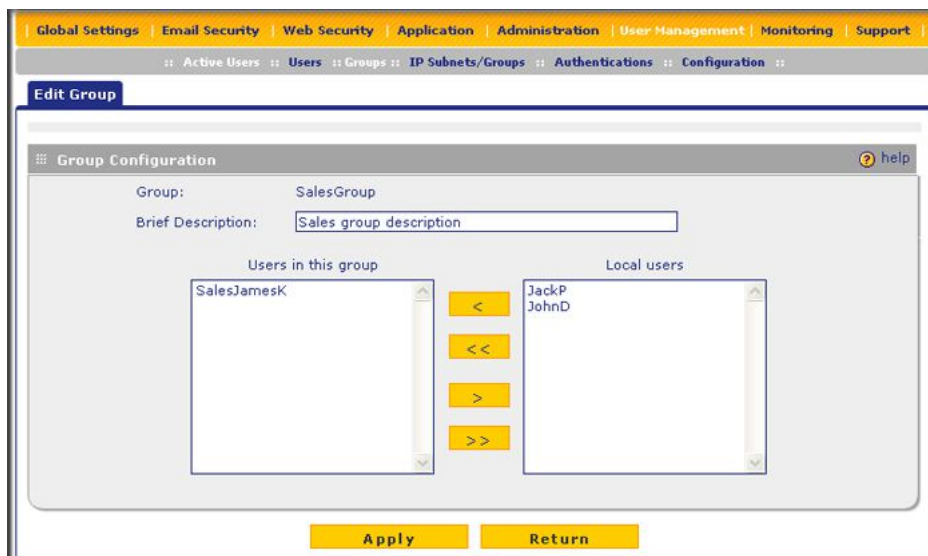

Figure 83.

3. Change the field and move the users as explained in the following table:

Table 44. Edit Group Settings

Setting	Description
Edit Description	You can edit the brief description of the group for identification and management purposes.
<p>Use the move buttons to move all users or only selected users from the Local users field to the Users in this group field (or the other way around).</p> <p>These are the functions of the move buttons:</p> <ul style="list-style-type: none"> • < or > moves one or more highlighted selections from one field to the other. • << or >> moves all entries from one field to the other. 	

4. Click **Apply** to save your changes.

Creating and Deleting Groups by IP Address and Subnet

To create a group by IP address and subnet:

1. Select **User Management > IP Subnet/Groups** from the menu. The IP Subnet/Groups screen displays. (The following figure contains one example.)



Figure 84.

The Groups Membership by IP Address table displays the groups with the following fields:

- **IP Address.** The IP address for the group.
- **Netmask.** The subnet mask for the group.
- **Name.** The name of the group.
- **Action.** The Delete table button, which allows you to delete the group.

- In the Add New IP Subnets/Groups section of the screen, complete the fields as explained in the following table:

Table 45. IP Subnet/Group Settings

Setting	Description
IP Address	An IP address on your local network or on a remote device to which the users are assigned.
Netmask	The subnet mask to which the users are assigned. For an individual IP address, specify 255.255.255.255 .
Name	A descriptive (alphanumeric) name of the group for identification and management purposes.

- Click the **Add** table button. The new group is added to the Groups Membership by IP Address table.

To delete a group from the List of Groups table, click the **Delete** table button in the Action column for the group that you want to delete.

Note: When you delete a group, an exception rule that might be associated with this group no longer has any effect. You can delete such an exception rule.

Configuring User Accounts

When you create a user account, you can assign the user to a local group. Therefore, you should first create any local groups, then user accounts. User accounts are added to the STM's local user database.

Creating and Deleting User Accounts

To create an individual user account:

1. Select **Users > Users** from the menu. The Users screen displays:

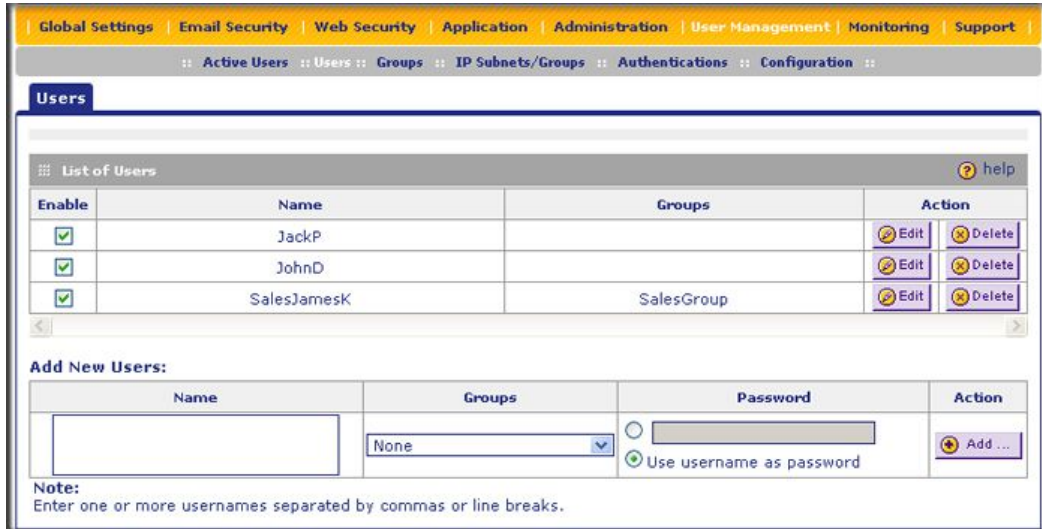

Figure 85.

The List of Users table displays the users with the following fields:

- **Enable.** The check box allows you to enable or disable the user.
 - **Name.** The name of the user.
 - **Group.** The group to which the user is assigned. If no group is displayed, the user is not assigned to any group.
 - **Action.** The Edit table button, which provides access to the Edit User screen, and the Delete table button, which allows you to delete the user.
2. In the Add New Users section of the screen, complete the fields, make your selection from the drop-down list, and select the radio buttons as explained in the following table:

Table 46. User Settings

Setting	Description
Name	A descriptive (alphanumeric) name of the user for identification and management purposes.
Groups	The drop-down list shows the local groups that are listed on the Groups screen. From the drop-down list, select the group to which the user is assigned. For information about how to configure groups, see Configuring Groups on page 148.
Password	Select one of the following radio buttons: <ul style="list-style-type: none"> • The radio button to the left of the Password field. Enter the password that the user needs to enter to gain access to the STM. The password can be up to 64 characters. • Use username as the password. The password that is assigned to the user is identical to the user name.

3. Click the **Add** table button. The new user is added to the List of Users table.

To delete a user from the List of Users table, click the **Delete** table button in the Action column for the user that you want to delete.

Editing User Accounts

The only field that you can change for a user account is the password.

To modify the password for a user:

1. Select **Users > Users** from the menu. The Users screen displays (see the previous figure).
2. Click the **Edit** table button in the Action column for the user whose password you want to modify. The Edit User screen displays. (The following figure contains an example.)

The screenshot shows the 'Edit User' interface. At the top, there is a navigation bar with tabs: Global Settings, Email Security, Web Security, Application, Administration, User Management, Monitoring, and Support. Below this is a breadcrumb trail: Active Users :: Users :: Groups :: IP Subnets/Groups :: Authentications :: Configuration. The main title is 'Edit User'. The form area is titled 'User Configuration' and contains the following fields:

- Name: SalesJamesK
- Groups: SalesGroup
- Password: [masked with dots]
- Confirm Password: [empty]

At the bottom of the form are two buttons: 'Apply' and 'Return'.

Figure 86.

3. Modify the password:
 - a. In the Password field, enter the new password.
 - b. In the Confirm Password field, repeat the new password.
4. Click **Apply** to save your settings.

Configuring Authentication

The authentication options of the STM are discussed in the following sections:

- [Understanding the STM's Authentication Options](#) on page 155
- [Understanding Active Directories and LDAP Configurations](#) on page 157
- [Creating and Deleting LDAP and Active Directory Domains](#) on page 161
- [Editing LDAP and Active Directory Domains](#) on page 164
- [Understanding the ProSecure DC Agent](#) on page 164
- [Requirements for the ProSecure DC Agent Software and DC Agent Server](#) on page 165

- [Downloading ProSecure DC Agent Software, and Creating and Deleting DC Agents](#) on page 165
- [Creating and Deleting RADIUS Domains](#) on page 167
- [Editing RADIUS Domains and Configuring VLANs](#) on page 169

Understanding the STM's Authentication Options

The login screen and authentication on the STM depend on the user type. There are two basic user types on the STM that are explained in the following sections:

- Administrative users and users with guest privileges
- Users with special access privileges

Administrative Users and Users with Guest Privileges

Users with administrative and guest privileges on the STM need to log in through the NETGEAR Configuration Manager Login screen (see the following figure), where they are authenticated through the STM's local user database. These users need to provide their user name and password.

For information about the predefined administrator and guest user accounts, see [About Users with Administrative and Guest Privileges](#) on page 61. For information about how to change the administrator default name and password or guest default name and password, see [Changing Administrative Passwords and Timeouts](#) on page 62.

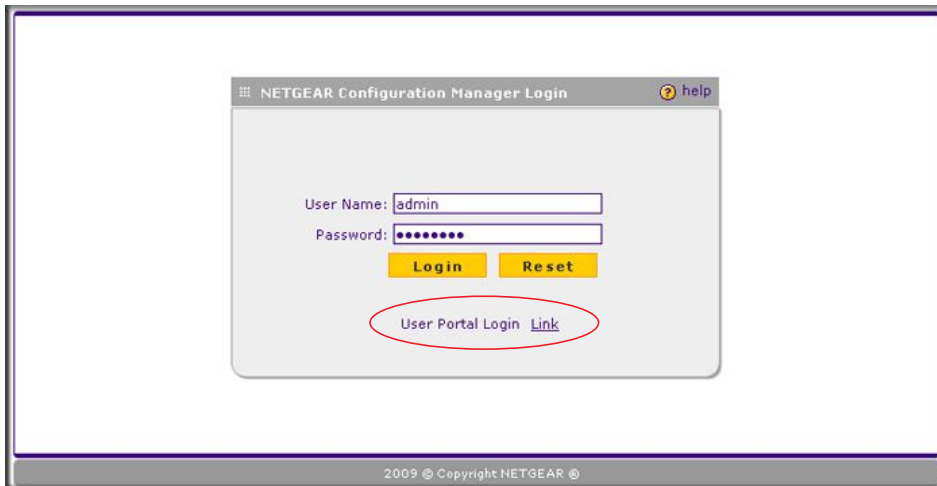

Figure 87.

Users with Special Access Privileges

Users who have a computer behind the STM and who are assigned access policies that differ from the STM's default email and Web access policies (see [Setting Access Exception Rules for Web Access](#) on page 132) need to log in through the User Portal Login screen (see the following figure). These users need to provide their user name and password, and select the domain to which they have been assigned.

The lower part of the NETGEAR Configuration Manager Login screen (see the previous figure) provides a User Portal Login Link that lets you open the User Portal Login screen:

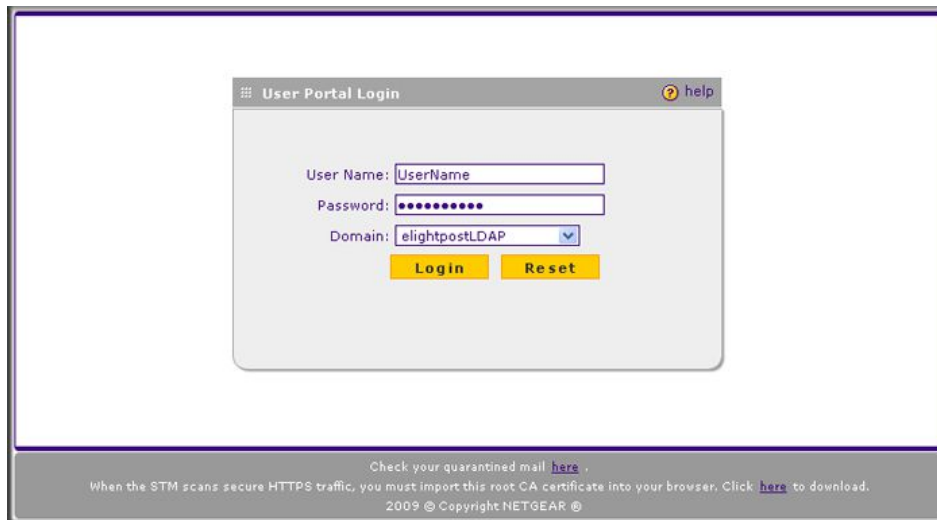

Figure 88.

After a user has logged in through the User Portal Login screen, the Authentication screen displays:



Figure 89.

The Authentication screen shows the IP address with which the user has logged in and lets a user change his or her password.

If you do not use the DC agent in your configuration (see *Understanding the ProSecure DC Agent* on page 164), after completing a session, a user needs to log out by following these steps:

1. Return to the User Portal Login screen (see *Figure 88*).

Note: The user needs to know how to return to the User Portal Login screen.

The administrator needs to provide the User Portal Login URL:

`https://<IP_address>/~common/cgi-bin/user_login.pl` or

`https://<FullyQualifiedDomainName>/~common/cgi-bin/user_login.pl`

Alternately, the administrator can provide the NETGEAR Configuration Manager Login screen, from which the user can access the User Portal Login screen: `https://<IP_address>` or `https://<FullyQualifiedDomainName>`

2. Log in again.
3. On the Authentication screen (see the previous figure), click the **Logout** link.

**WARNING!**

Ensure that users understand that they need to log out after completing a session in order to prevent subsequent users from inheriting access privileges that were not assigned to them.

In addition to authentication through the STM's local user database, the STM supports the following external authentication methods for users logging in through the User Portal Login screen:

- **LDAP.** A network-validated domain-based authentication method that functions with a Lightweight Directory Access Protocol (LDAP) authentication server. LDAP is a standard for querying and updating a directory. Because LDAP supports a multilevel hierarchy (for example, groups or organizational units), this information can be queried to provide specific group policies or bookmarks based on LDAP attributes.
- **Active Directory.** A network-validated domain-based authentication method that functions with a Microsoft Active Directory authentication server. Microsoft Active Directory authentication servers support a group and user structure. Because the Active Directory supports a multilevel hierarchy (for example, groups or organizational units), this information can be queried to provide specific group policies or bookmarks based on Active Directory attributes. A Microsoft Active Directory database uses an LDAP organization schema.
- **RADIUS.** A network-validated PAP or CHAP password-based authentication method that functions with Remote Authentication Dial In User Service (RADIUS).

RADIUS supports two types of protocols:

- **PAP.** Password Authentication Protocol (PAP) is a simple protocol in which the client sends a password in clear text.
- **CHAP.** Challenge Handshake Authentication Protocol (CHAP) executes a three-way handshake in which the client and server trade challenge messages, each responding with a hash of the other's challenge message that is calculated using a shared secret value.

When logging in through the User Portal Login screen, users need to provide their name and password, and select the domain that corresponds to the authentication method that has been assigned to them.

Understanding Active Directories and LDAP Configurations

This manual assumes that you already have a knowledge of Active Directories and LDAP servers. The following sections are meant to provide some additional information before you go to [Creating and Deleting LDAP and Active Directory Domains](#) on page 161.

How an Active Directory Works

Understanding how a typical Active Directory (AD) works might be of help when you are specifying the settings for the LDAP and Active Directory domains on the STM.

The following applies to a typical AD:

- Organizational unit (OU), common name (CN), and domain controller (DC) can all be used to build a search base in the AD. The following applies to the OU and CN containers:
 - An AD administrator can create an OU but cannot create a CN that was built in the AD server.
 - An AD administrator can apply a global policy object (GPO) to an OU but not to a CN.
- An OU is created in the root node (for example, dc=companyname, dc=com) of the hierarchy. In a company AD, an OU often represents a regional office or department.
- A group is created under cn=users.
- A user is created under each OU so that the user can logically show in a tree of the AD server.
- A relationship between a group and users is built using their attributes (by default: member and memberOf). These show in a lookup result.

The following is an example of how to set the search base:

If in a company AD server “cn=users” and “ou=companyname” and both are specified under “dc=companyname,dc=com,” the search base needs to be set as “dc=companyname,dc=com” in order for the STM to search both users and groups.

If the size limit is exceeded so that “dc=companyname,dc=com” misses some entries during the lookup process, a user can still be correctly authenticated. However, to prevent the size limit from being exceeded, an AD administrator needs to set a larger value in the LDAP server configuration so that the entire list of users and groups is returned in the lookup result. Another workaround is to use a specific search name or a name with a wildcard in the lookup process, so that the subset of the entire list is returned in the lookup result.

How to Bind a Distinguished Name in an LDAP Configuration

Understanding how to bind a distinguished name (DN) in an LDAP configuration might be of help when you are specifying the settings for the LDAP and Active Directory domains on the STM.

To bind a user with the name Jamie Hanson with the LDAP server:

Note: In this example, the LDAP domain name is ABC.com, and the LDAP server has the IP address 192.168.35.115 on port 389.

1. On a computer that has access to the Active Directory (AD), open the Active Directory for Users and Computers.
2. Select the user Jamie Hanson.

3. Click the **General** tab. The general properties for Jamie Hanson display:

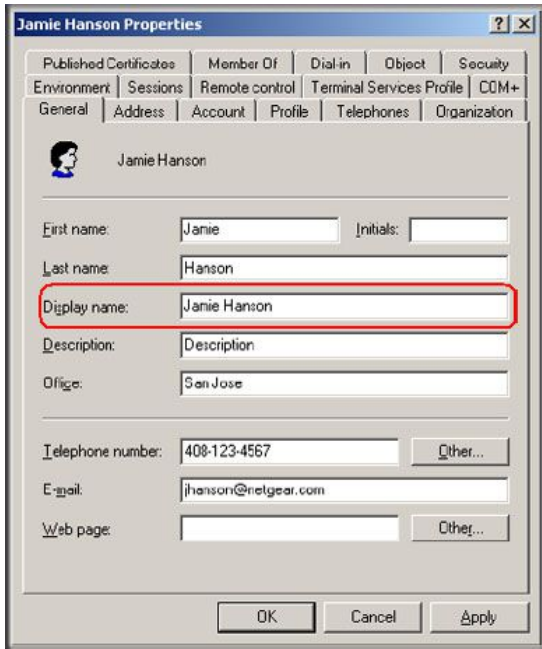

Figure 90.

4. To verify Jamie Hanson's user login name, click the **Account** tab. The account properties for Jamie Hanson display:

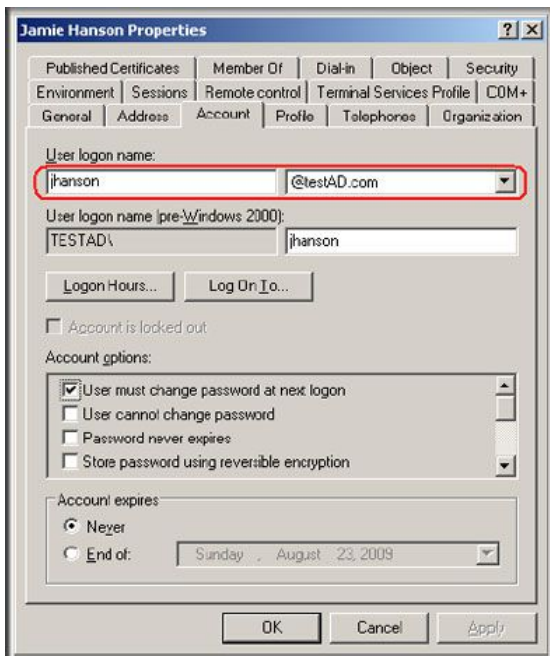

Figure 91.

5. Log in to the STM.
6. Select **User Management > Authentications** from the menu. The LDAP screen displays.

7. In the List of LDAP table, click the **Edit** button in the Action column of domain ABC.com. The Edit LDAP screen displays.
8. To bind the user Jamie Hanson to the LDAP server for authentication on the STM, use one of the following two formats in the Bind DN field of the Edit LDAP screen:
 - The display name in DN format:
cn=Jamie Hanson,cn=users,dc=testAD,dc=com (see the example in the following figure).

The screenshot shows the 'Edit LDAP' configuration page. The 'LDAP Configuration' section includes the following fields:

- Domain: ABC.com
- Server: 192.168.35.115
- Encryption: None
- Port: 389
- Bind DN: cn=Jamie Hanson,cn=users,dc=testAD,dc=com (highlighted with a red circle)
- Bind Password: [Redacted]
- Search Base: dc=testAD,dc=com (Example: CN=users,DC=domain,DC=com)
- UID Attribute: sAMAccountName (Example for Active Directory: sAMAccountName)
- Member Groups Attribute: memberof (optional) (Example for Active Directory: memberOf)
- Group Members Attribute: member (optional) (Example for Active Directory: member)
- Additional Filter: [Empty] (optional)

Buttons at the bottom: Test, Apply, Return.

Figure 92.

- The Windows account name in email format such as jhanson@testAD.com. (The following figure shows only the Bind DN field.)

The close-up shows the Bind DN field with the value 'jhanson@testAD.com' entered. The field is highlighted with a red circle.

Figure 93.

9. Click **Test** to verify that the LDAP server can actually function with the bind DN that you have modified. The automated test procedure checks the connection to the LDAP server, the bind DN, and the bind password. If any settings require changes, you are notified at the end of the automated test procedure.
10. Click **Apply** to save your settings.

Creating and Deleting LDAP and Active Directory Domains

To configure LDAP and Active Directory authentication:

1. Select **User Management > Authentication** from the menu. The authentication submenu tabs display with the LDAP screen in view:

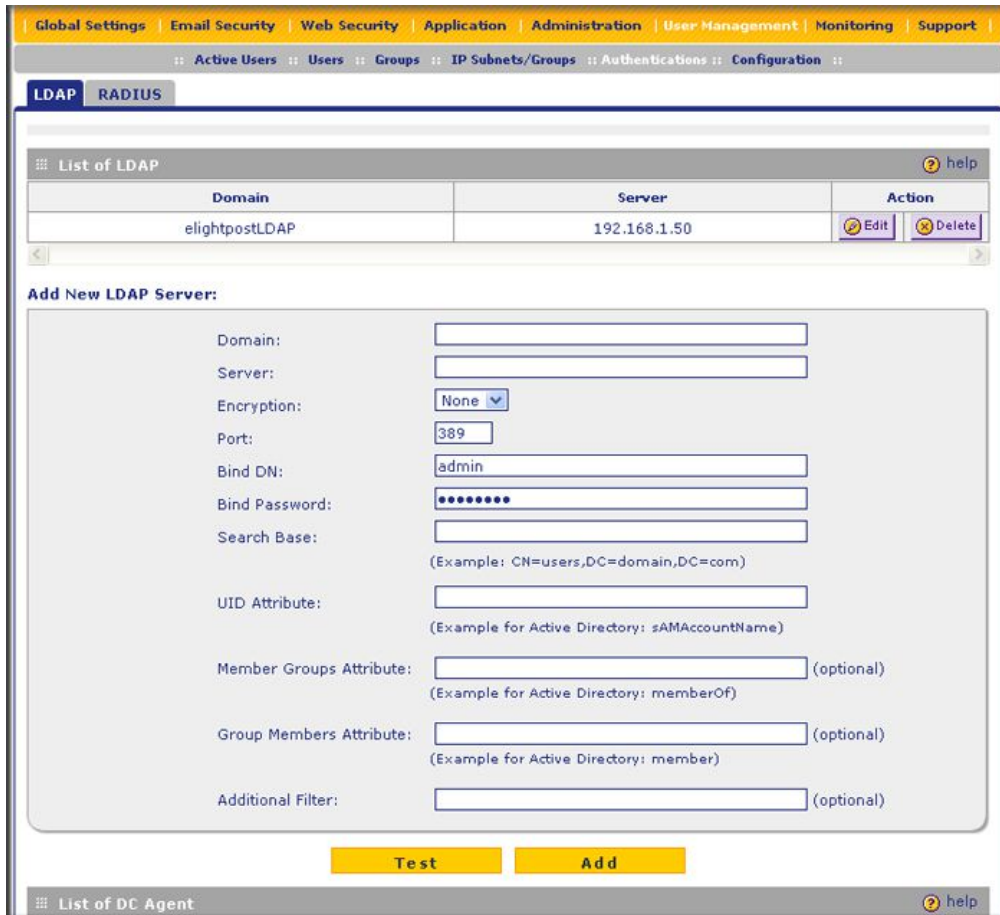

Figure 94.

The List of LDAP table displays the following fields:

- **Domain Name.** The name of the STM's domain to which the server has been assigned.
- **Server.** The IP address of the LDAP or Active Directory server.
- **Action.** The Edit table button, which provides access to the Edit LDAP screen, and the Delete table button, which allows you to delete the LDAP or Active Directory server.

2. Complete the fields and make your selections from the drop-down list as explained in the following table:

Table 47. LDAP Settings

Setting	Description
Domain	A descriptive (alphanumeric) name of the LDAP or Active Directory authentication server for identification and management purposes.
Server	The server IP address or server host name of the LDAP or Active Directory authentication server.
Encryption	From the drop-down list, select the encryption type for the connection between the STM and the LDAP or Active Directory server: <ul style="list-style-type: none"> • None. The connection is not encrypted. This is the default setting. • TLS. The connection uses Transport Layer Security (TLS) encryption. • SSL. The connection uses Secure Socket Layer (SSL) encryption.
Port	The port number for the LDAP or Active Directory authentication server. The default port for the LDAP server is 389, which is generally the default port for TLS encryption or no encryption. When the encryption is SSL, the default port is generally 636.
Bind DN	The LDAP or Active Directory bind distinguished name (DN) that is required to access the LDAP or Active Directory authentication server. This bind DN needs to be a user in the LDAP or Active Directory directory that has read access to all the users that you would like to import into the STM. The Bind DN field accepts two formats: <ul style="list-style-type: none"> • A display name in the DN format. For example: <code>cn=Jamie Hanson,cn=users,dc=test,dc=com.</code> • A Windows login account name in email format. For example: <code>jhanson@testAD.com.</code> This last type of bind DN can be used only for a Windows Active Directory server.
Bind Password	The authentication secret or password that is required to access the LDAP or Active Directory authentication server.
Search Base	The distinguished name (DN) at which to start the search, specified as a sequence of relative distinguished names (rdn), connected with commas and without any blank spaces. For most users, the search base is a variation of the domain name. For example, if your domain is <code>yourcompany.com</code> , your search base DN might be as follows: <code>dc=yourcompany,dc=com.</code>
UID Attribute	The attribute in the LDAP directory that contains the user's identifier (uid). For an Active Directory, enter sAMAccountName . For an OpenLDAP directory, enter uid .
Member Groups Attribute	This field is optional. The attribute that is used to identify the groups an entry belongs to. For an Active Directory, enter memberOf . For OpenLDAP, you can enter a customized attribute to identify the groups of an entry.

Table 47. LDAP Settings (Continued)

Setting	Description
Group Members Attribute	This field is optional. The attribute that is used to identify the members of a group. For an Active Directory, enter member . For OpenLDAP, you can enter a customized attribute to identify the members of a group.
Additional Filter	This field is optional. A filter that is used when searching the LDAP server for matching entries while excluding others. (Use the format described by RFC 2254.) The following search term examples match users only: Active Directory: objectClass=user Open LDAP: objectClass=posixAccount

3. Click **Test** to verify that the LDAP server can actually function with the LDAP settings that you have specified. The automated test procedure checks the connection to the LDAP server; the bind DN, and the bind password. If any settings require changes, you are notified at the end of the automated test procedure.

Note: If the automated test procedure returns the message “LDAP server test passed but size limit exceeded,” only a limited number of entries (for example, 1000) was returned after the LDAP server was queried. To ensure that the lookup results include all users and groups, set larger values in the LDAP server. Another workaround is to use a specific search name or a name with a wildcard in the lookup process, so that the subset of the entire list is returned in the lookup result.

4. Click **Add** to save your settings. The LDAP or Active Directory domain and server are added to the List of LDAP table.

To delete a domain and server from the List of LDAP table, click the **Delete** table button in the Action column for the domain and server that you want to delete.



WARNING!

After their sessions have expired, users can no longer log in to the STM if the domain that has been assigned to them is the domain that you deleted.

Editing LDAP and Active Directory Domains

To edit an LDAP or Active Directory domain:

1. Select **User Management > Authentication** from the menu. The authentication submenu tabs display with the LDAP screen in view (see [Figure 94](#) on page 161).
2. In the Action column of the List of LDAP table, click the **Edit** table button for the domain and server that you want to edit. The Edit LDAP screen displays. This screen contains the same fields as the LDAP screen (see [Figure 94](#) on page 161).
3. Modify the fields and make your selections from the drop-down list as explained in [Table 47](#) on page 162.
4. Click **Test** to verify that the LDAP server can actually function with the LDAP settings that you have modified. The automated test procedure checks the connection to the LDAP server, the bind DN, and the bind password. If any settings require changes, you are notified at the end of the automated test procedure.
5. Click **Apply** to save your settings.

Understanding the ProSecure DC Agent

If you set up an open network, you would want to allow unauthenticated users to surf anonymously. For a secure network, you would use a more restrictive access policy for unauthenticated users and a less restricted access policy for authenticated users.

Without the use of the DC agent, any LDAP domain user surfs anonymously until providing credentials to the STM in order to proceed past a blocked Web activity. With use of the DC agent, LDAP domain users are immediately known to the STM when they are authenticated on a DC server on which the DC agent is installed.

If the LDAP directory authenticates through a domain controller (DC) server that runs Windows Server 2003 with Service Pack 1 (SP1) or Windows Server 2008, you can use the ProSecure DC Agent software to authenticate LDAP domain users.

The DC agent monitors all Windows login events (that is, all LDAP domain user authentications) on the DC server, and provides a mapping of Windows user names and IP addresses to the STM, enabling the STM to transparently apply user policies. The DC agent transfers encrypted names, IP addresses, groups, and login times of the users logged in to the STM, where this information remains securely (that is, it is not transferred out of the STM).

Requirements for the ProSecure DC Agent Software and DC Agent Server

Note the following requirements for the ProSecure DC agent software and domain controller (DC) servers:

- If the DC server is located behind a firewall or there is a firewall on the DC server, ensure that the firewall does not block the server's listening port. The default port that is used by the DC agent is 5182.
- The DC agent needs to be able to automatically log an account login event when a domain user account is authenticated against the LDAP directory on a DC server. Verify that the DC server has the following configuration:
 - The Audit Logon Events policy is defined and the **Success** check box is selected.
 - The Audit Account Logon Events policy is defined and the **Success** check box is selected.
 - The Audit Account Management policy is defined and the **Success** check box is selected.

In addition, if you change the log path of the security log, restart the DC server to bring the change into effect.

- If you use the ProSecure DC Agent software on a DC server that is running Windows Server 2003, ensure that Windows Security Log settings in the Event Viewer are set to the maximum size of 16 MB and to overwrite events as needed.

Downloading ProSecure DC Agent Software, and Creating and Deleting DC Agents

When new ProSecure DC Agent software is available, the STM automatically downloads the software from the update server and notifies administrative users in several ways:

- The STM sends an email to administrative users.
- The STM records a syslog entry.
- The STM generates a notification screen that is presented to administrative users upon login.

To download ProSecure DC Agent software and add a DC agent:

1. Select **User Management > Authentication** from the menu. The authentication submenu tabs display with the LDAP screen in view. Locate the List of DC Agents table at the bottom of the screen. (See this section of the screen in the following figure.)

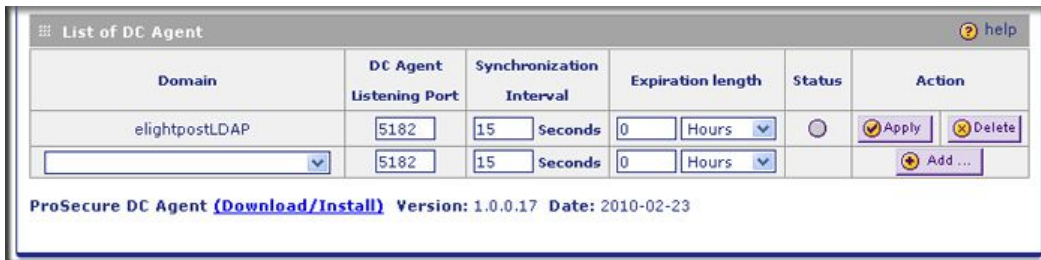

Figure 95.

2. Under the List of DC Agents table, click the **Download/Install** link to download the ProSecure DC Agent software. Follow the instructions of your browser to save the software file to your computer.
3. Install the ProSecure DC Agent software on each domain controller (DC) server through which the LDAP directory authenticates users.
4. Complete the fields and make your selections from the drop-down lists as explained in the following table:

Table 48. DC Agent Settings

Setting	Description
Domain	From the Domain drop-down list, select an LDAP domain to bind with the DC agent. For information about configuring LDAP domains, see Creating and Deleting LDAP and Active Directory Domains on page 161.
DC Agent Listening Port	Enter the listening port of the DC agent. The listening port is the port through which the DC agent transfers the list of authenticated users to the STM. The default port is 5182.
Synchronization Interval	Enter the time interval (in seconds) at which the DC agent updates the list of authenticated users. The default interval is 15 seconds.
Expiration length	Enter time interval in hours or minutes (determined by your selection from the Expiration length drop-down list) that is allowed to elapse before a user login expires. The default setting is zero (0), that is, a user login does not expire.
Status	Displays the status of the DC agent: A green circle indicates that the DC agent is active; a gray circle indicates that the DC agent is inactive.

5. To add the newly configured DC agent to the List of DC Agents table, click the **Add** table button in the Action column.

For each DC agent in the List of DC Agents table, the Action column provides two table buttons:

- **Apply.** Activates the DC agent. The circle in the Status column turns green.
- **Delete.** Deletes the DC agent from the table.

To edit a DC agent:

1. In the Domain column, locate the DC agent that you want to edit, and make changes in the columns to the right of the Domain column.
2. Click **Apply** to save your changes.

Creating and Deleting RADIUS Domains

To configure RADIUS authentication:

1. Select **User Management > Authentication** from the menu. The authentication submenu tabs display with the LDAP screen in view.
2. Click the **RADIUS** submenu tab. The RADIUS screen displays. (The following figure contains two examples.)

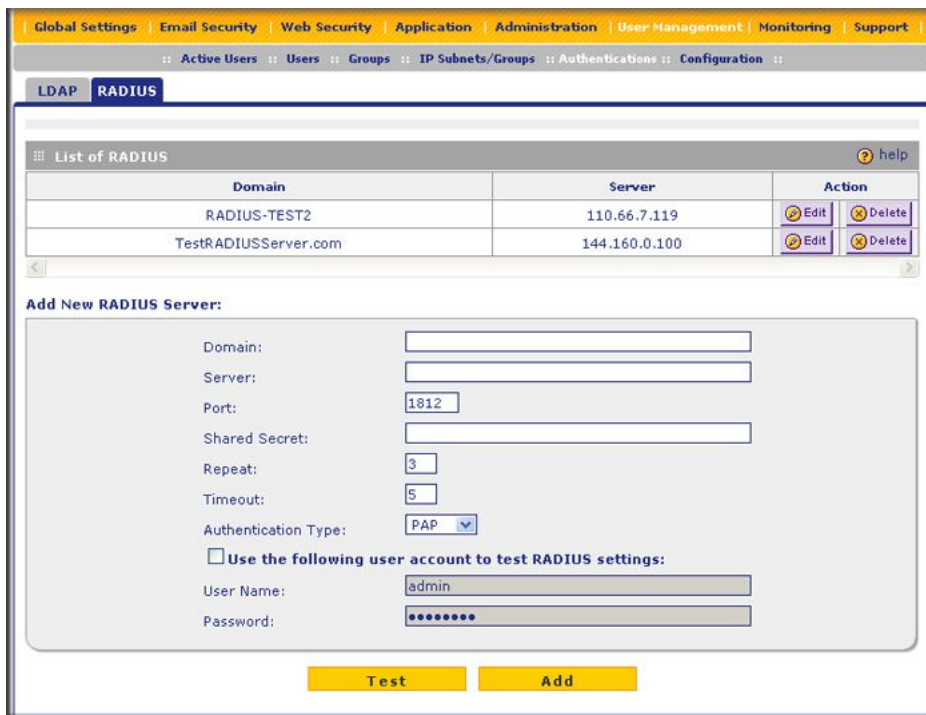

Figure 96.

The List of RADIUS table displays the following fields:

- **Domain.** The name of the STM's domain to which the server has been assigned.
- **Server.** The IP address of the RADIUS server.
- **Action.** The Edit table button, which provides access to the Edit RADIUS screen, and the Delete table button, which allows you to delete the RADIUS server.

3. Complete the fields and make your selections from the drop-down list as explained in the following table:

Table 49. RADIUS Settings

Setting	Description	
Domain	A descriptive (alphanumeric) name of the RADIUS authentication server for identification and management purposes.	
Server	The server IP address or server host name of the RADIUS authentication server.	
Port	The port number for the RADIUS authentication server. The default port for the RADIUS server is 1812.	
Shared Secret	The shared secret (password) that is required to access the RADIUS authentication server.	
Repeat	The maximum number of times that the STM attempts to connect to the RADIUS server. The default setting is 3 times.	
Timeout	The period after which an unsuccessful connection attempt times out. The default setting is 5 seconds.	
Authentication Type	From the drop-down list, select the encryption type for the connection between the STM and the LDAP or Active Directory server: <ul style="list-style-type: none"> • PAP. The connection uses the Password Authentication Protocol (PAP). This is the default setting. • CHAP. The connection uses the Challenge Handshake Authentication Protocol (CHAP). 	
Use the following user account to test RADIUS settings	Select this check box to test the RADIUS settings with the user name and password that you need to specify.	
	User Name	The user name to test the RADIUS settings with.
	Password	The password to test the RADIUS settings with.

4. Click **Test** to verify that the RADIUS server can actually function with the RADIUS settings that you have specified. The automated test procedure checks the connection to the RADIUS server, the user name, and the password. If any settings require changes, you are notified at the end of the automated test procedure.
5. Click **Apply** to save your settings. The RADIUS domain and server are added to the List of RADIUS table.

To delete a domain and server from the List of RADIUS table, click the **Delete** table button in the Action column for the domain and server that you want to delete.



WARNING!

After their sessions have expired, users can no longer log in to the STM if the domain that has been assigned to them is the domain that you deleted.

Editing RADIUS Domains and Configuring VLANs

To edit a RADIUS domain:

1. Select **User Management > Authentication** from the menu. The authentication submenu tabs display with the LDAP screen in view.
2. Click the **RADIUS** submenu tab. The RADIUS screen displays (see [Figure 96](#) on page 167).
3. In the Action column of the List of RADIUS table, click the **Edit** table button for the domain and server that you want to edit. The Edit Radius screen displays. (The following figure contains some examples.)

The screenshot shows the 'Edit RADIUS' configuration screen. The top navigation bar includes: Global Settings | Email Security | Web Security | Application | Administration | User Management | Monitoring | Support. The breadcrumb trail is: Active Users :: Users :: Groups :: IP Subnets/Groups :: Authentications :: Configuration :: Edit RADIUS. The main content area is titled 'RADIUS Configuration' and contains the following fields:

- Domain: TestRADIUSServer.com
- Server: 144.160.0.100
- Port: 1812
- Shared Secret: 12345678
- Repeat: 3
- Timeout: 5
- Authentication Type: PAP
- Use the following user account to test RADIUS settings:
- User Name: admin
- Password: [masked]

Below the form are three buttons: Test, Apply, and Return. Below the form is a 'List of VLAN' table:

VLAN ID/Name	Brief Description	Action
SecondVLAN		Delete
TestVLAN	VLAN for test purposes	Delete

Below the table is an 'Add New VLAN ID/Name' form with the following fields:

VLAN ID/Name	Brief Description	Add
[input field]	[input field]	Add ...

Figure 97.

4. Modify the fields and make your selections from the drop-down list as explained in [Table 49](#) on page 168.
5. Click **Test** to verify that the RADIUS server can actually function with the RADIUS settings that you have modified. The automated test procedure checks the connection to the RADIUS server, the user name, and the password. If any settings require changes, you are notified at the end of the automated test procedure.
6. Click **Apply** to save your settings.

Creating and Deleting VLANs for Use with RADIUS Domains

After you have created a RADIUS domain by specifying a RADIUS server, you can add a virtual LAN (VLAN), and then set access exceptions for the logged-in RADIUS users (see [Setting Access Exception Rules for Web Access](#) on page 132).

In order to use the VLAN to set access exceptions on the STM, the following is required:

- You need to have defined a VLAN policy on another platform.
- You need to have added users to the VLAN policy.
- The RADIUS server needs to contain VLAN attributes in its user information.

At the bottom of the Edit Radius screen (see the previous figure, which contains one VLAN example), the List of VLAN table displays the following fields:

- **VLAN ID/Name.** The identifier or name for the VLAN.
- **Brief Description.** An optional brief description of the VLAN.
- **Action.** The Delete table button, which allows you to delete the VLAN.

To add a VLAN:

1. On the Edit Radius screen, locate the Add New VLAN ID/Name section at the very bottom of the screen. Specify the VLAN:
 - a. In the VLAN ID/Name field, enter the identifier or the name of the VLAN.
 - b. In the Brief Description field, enter a description of the VLAN. This field is optional.
2. Click the **Add** table button. The new VLAN is added to the List of VLAN table.

To delete a user from the List of VLAN table, click the **Delete** table button in the Action column for the VLAN that you want to delete.

Global User Settings

You can globally set the user session settings for authenticated users. These settings include the session expiration period, the allowed session idle time, and the default domain that is presented to the users.

To specify the global user configuration settings:

1. Select **User Management > Configuration** from the menu. The Configuration screen displays:

The screenshot shows the Configuration screen with the following details:

- Navigation:** Global Settings | Email Security | Web Security | Application | Administration | User Management | Monitoring | Support
- Breadcrumbs:** Active Users :: Users :: Groups :: IP Subnets/Groups :: Authentications :: Configuration ::
- Section: Session Parameters**
 - Session Expiration Length: 24 Hours
 - Idle Time: 8 Hours
 - Buttons: Apply, Reset
- Section: User Portal Login Settings**
 - Default Domain: prosecuredomain
 - Authenticate User with User Selected Domain
 - Buttons: Apply, Reset

Figure 98.

2. Locate the Sessions Parameters section on screen. Specify the session settings:
 - **Session Expiration Length.** The period after which a session expires and a user needs to log in again. This setting applies to all users. From the drop-down list, select either **Minutes** or **Hours**. Then, in the field to the left of the drop-down list, enter a number for the minutes or hours. The session expiration length cannot exceed the idle time period.

Note: For information about how to set the time-out period for the Web Management Interface, see [Changing Administrative Passwords and Timeouts](#) on page 62.

- **Idle Time.** The period after which an idle connection is terminated and a user needs to log in again. This setting applies to all users. From the drop-down list, select either **Minutes** or **Hours**. Then, in the field to the left of the drop-down list, enter a number for the minutes or hours. The idle time period cannot exceed the session expiration length.
3. Click **Apply** to save the session settings.

4. Locate the Users Portal Login Settings section on screen. Specify the default domain settings:
 - From the Default Domain drop-down list, select a domain that is presented as the default domain on the User Portal Login screen. The default domain that is presented is prosecuredomain. Users can still select another domain (if there are other domains configured on the STM) from the drop-down list on the User Portal Login screen.
 - Select the **Authenticate User with User Selected Domain** check box to limit the authentication on the User Portal Login screen to the domain that you select from the Default Domain drop-down list. If you do not select this check box, the STM attempts to authenticate users through all the domains that are listed in the drop-down list on the User Portal Login screen; when authentication through one domain fails, the STM attempts authentication through another domain.
5. Click **Apply** to save the default domain settings.

Viewing and Logging Out Active Users

A user with administrative privileges can view the active users and log out selected or all active users.

To log out all active users:

1. Select **User Management > Active Users** from the menu. The Active Users screen displays:

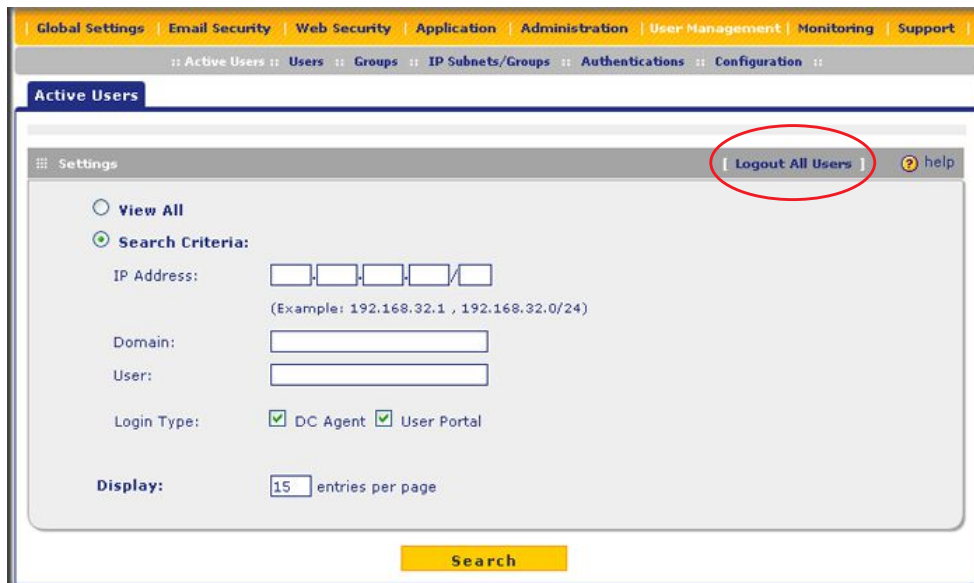

Figure 99.

2. Click the **Logout All Users** button in the gray settings bar at the top of the Active Users screen.

To view all or selected users:

- On the Active Users screen (see the previous figure), select one of the following radio buttons:
 - View All.** This selection returns all active users after you click the Search button.
 - Search Criteria.** This selection lets you enter the following search criteria so that only selected users are returned after you click the Search button. Use either the IP Address field or the Domain and User fields. The setting of the Login Type check boxes affects both the IP address search method and the domain and user search method.
 - IP Address.** Enter an IP address or an IP address and subnet mask in Classless Inter-Domain Routing (CIDR) notation (for example, /024).
 - Domain.** Enter a domain (for example, prosecuredomain).
 - User.** Enter a user name (for example, JackP). If you do not enter a user name, all users of the specified domain are displayed in the search results.
 - Login Type.** Select the **DC Agent** check box to display only users who logged in through the DC agent in the search results. Select the **User Portal** check box to display only users who logged in through the user portal search results. By default, both check boxes are selected.
- In the Display field, enter a number to specify how many entries per page the search result screen returns.
- Click **Search**. The search results screen displays. (The following figure contains some examples.)



Figure 100.

The List of Users table displays the following fields:

- IP Address.** The IP address that is associated with the user.
- Domain.** The domain to which the user belongs.
- User.** The user name.
- Groups.** The groups to which the user belongs, if any.
- Last Seen.** The most recent time that scanned traffic associated with the user (that is, IP address) passed through the STM.
- Login Type.** The method through which the user logged in (DC agent or user portal).

To log out selected active users:

1. On the search results screen select the check boxes to the left of the users that you want to log out.
2. Click **Logout**.

Monitoring System Access and Performance

6

This chapter describes the system monitoring features of the STM. You can be alerted to important events such as attacks and login failures. You can also view the system status and real-time traffic and security information. In addition, the diagnostics utilities are described.

Note: All email notification functions that are part of the Logs, Reports, and Alerts menus, and some of the functions that are part of the Diagnostics configuration menu require that you configure the email notification server—see [Configuring the Email Notification Server](#) on page 176.

This chapter contains the following sections:

- [Configuring Logging, Alerts, and Event Notifications](#) on this page
- [Monitoring Real-Time Traffic, Security, Statistics, and Web Usage](#) on page 184
- [Viewing System Status](#) on page 192
- [Querying Logs](#) on page 194
- [Viewing, Scheduling, and Generating Reports](#) on page 200
- [Viewing and Managing the Quarantine Files](#) on page 208
- [Using Diagnostics Utilities](#) on page 215

Configuring Logging, Alerts, and Event Notifications

You can configure the STM to email logs and alerts to a specified email address. For example, the STM can email security-related events such as malware incidents, infected clients, and failed authentications. By default, the STM logs content filtering events such as attempts to access blocked sites and URLs, unwanted email content, spam attempts, and many other types of events.

For you to receive the logs in an email message, the STM's notification server needs to be configured and email notification needs to be enabled. If the notification server is not configured or email notification is disabled, you can still query the logs and generate log reports to view on the Web Management Interface or to save in CSV format.

For more information about logs, see [Querying Logs](#) on page 194.

Configuring the Email Notification Server

If you have used the Setup Wizard, you might have already configured the email notification server; the Email Notification Server screen allows you to modify these settings.

The STM can automatically send information such as notifications and reports to an administrator. You need to configure the necessary information for sending email, such as the administrator’s email address, the email server, user name, and password.

To configure the email notification server:

1. Select **Global Settings > Email Notification Server** from the menu. The Email Notification Server screen displays. (The following figure contains some examples.)

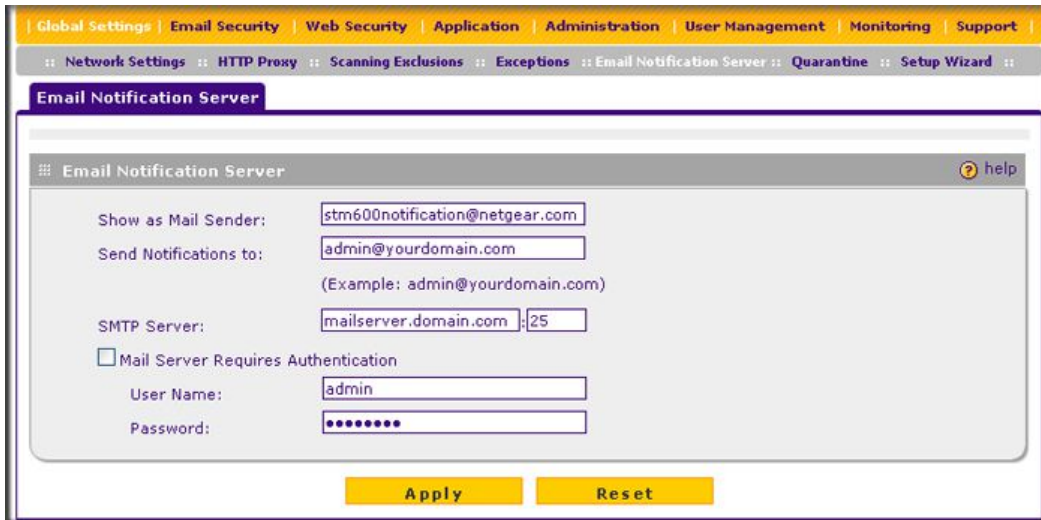

Figure 101.

2. Complete the fields, select the radio button and check boxes, and make your selections from the drop-down lists as explained in the following table:

Table 50. Email Notification Settings

Setting	Description (or Subfield and Description)
Show as Mail Sender	A descriptive name of the sender for email identification purposes. For example, enter stm600notification@netgear.com.
Send Notifications to	The email address to which the notifications should be sent. Typically, this is the email address of a user with administrative privileges.
SMTP server	The IP address and port number or Internet name and port number of your ISP’s outgoing email SMTP server. The default port number is 25. Note: If you leave this field blank, the STM cannot send email notifications.

Table 50. Email Notification Settings (Continued)

Setting	Description (or Subfield and Description)	
Mail Server Requires Authentication	If the SMTP server requires authentication, select the Mail Server Requires Authentication check box and enter the following settings:	
	User Name	The user name for SMTP server authentication.
	Password	The password for SMTP server authentication.

3. Click **Apply** to save your settings.

Configuring and Activating System, Email, and Syslog Logs

You can configure the STM to log system events such as a change of time by an NTP server, secure login attempts, restarts, and other events. You can also send logs to the administrator or schedule logs to be sent to the administrator or to a syslog server on the network. In addition, the Log Management screen provides the option to selectively clear logs. Because this large screen has three sections, each with its own Apply button, this screen is presented in this manual in three figures (the following figure, [Figure 103](#) on page 180, and [Figure 104](#) on page 182).

Emailing Logs

To enable and configure logs to be sent to an email address:

1. Select **Monitoring > Logs** from the menu. The Logs submenu tabs display, with the Log Management screen in view (see the following figure, [Figure 103](#) on page 180, and [Figure 104](#) on page 182).
2. Locate the Email Logs to Administrator section on the screen. Select the **Enable** check box to enable the STM to send logs to an email address.

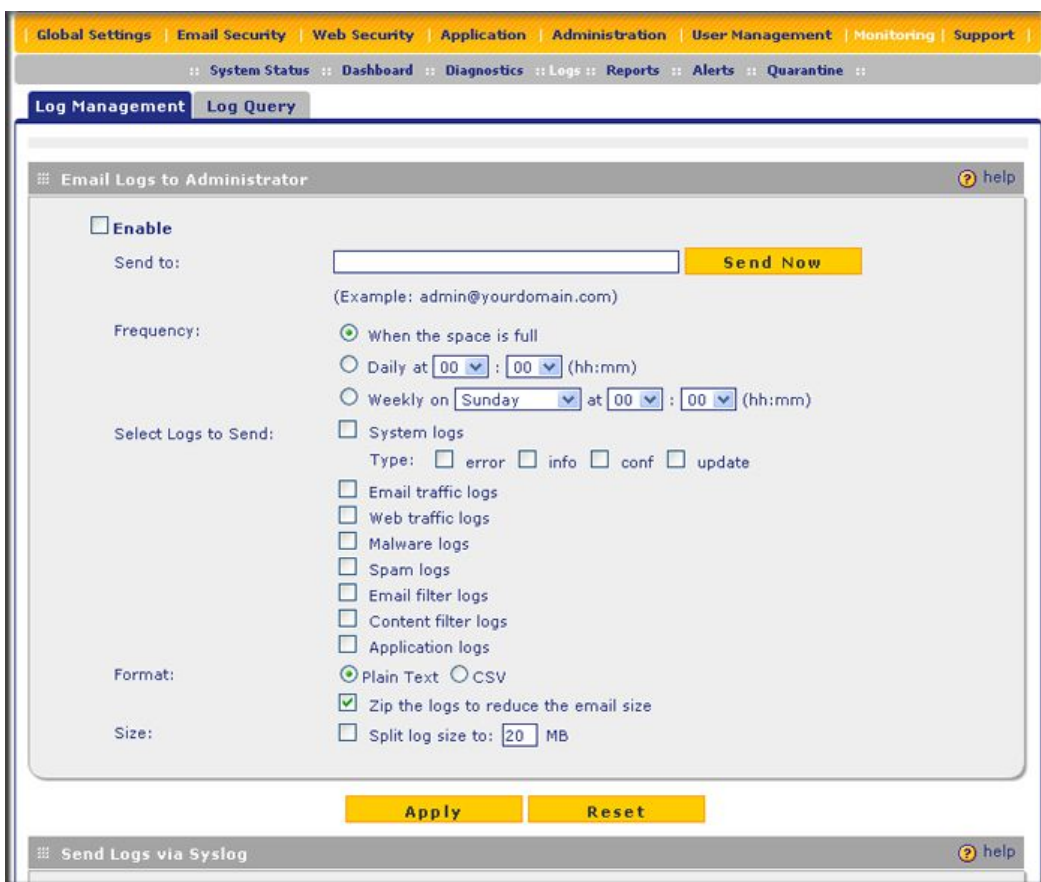

Figure 102. Log Management, screen 1 of 3

3. Complete the fields, select the radio button and check boxes, and make your selections from the drop-down lists as explained in the following table:

Table 51. Email Logs Settings

Setting	Description (or Subfield and Description)
Send to	<p>The email address of the recipient of the log file. This is normally a user with administrative privileges. You enter up to three email address, separated by commas. Click Send Now to immediately send the logs that you first need to have specified (see the information later in this table).</p> <p>Note: To limit the size of the email, the STM does not send the actual logs to the specified email address but an email that contains links to the actual logs. These links remain active for a period of 10 days, after which the logs are no longer available.</p>
Frequency	<p>Select a radio button to specify how often the log file is sent:</p> <ul style="list-style-type: none"> • When the space is full. Logs are sent when the storage space that is assigned to the logs is full. • Daily. Logs are sent daily at the time that you specify from the drop-down lists (hours and minutes). • Weekly. Logs are sent weekly at the day and time that you specify from the drop-down lists (weekday, hours, and minutes).

Table 51. Email Logs Settings (Continued)

Setting	Description (or Subfield and Description)
Select Logs to Send	<p>Select the check boxes to specify which logs are sent via email:</p> <ul style="list-style-type: none"> • System logs. The system event logs that include all system errors, informational messages, configuration changes, and system software updates. • Email traffic logs. All scanned incoming and outgoing email traffic. • Web traffic logs. All scanned incoming and outgoing Web traffic. • Malware logs. All intercepted viruses and spyware. • Spam logs. All intercepted spam, including spam that was detected through the blacklist, real-time blacklist, and distributed spam analysis. • Email filter logs. All emails that are intercepted because of keyword, file type, file name, password, or size limit violations. • Content filter logs. All websites, URLs, and FTP sites that are intercepted because of Web category, blacklist, file type, or size limit violations. • Application logs. All intercepted application access violations. <p>Select the types of system logs that are sent via email:</p> <ul style="list-style-type: none"> • error. All system errors. • info. All informational messages. • conf. All configuration changes. • update. All system software updates.
Format	<p>Select a radio button to specify the format in which the log file is sent:</p> <ul style="list-style-type: none"> • Plain text. The log file is sent as a plain text file. • CSV. The log file is sent as a comma-separated values (CSV) file. <p>Select the Zip the logs to save space check box to enable the STM to compress the log file.</p>
Size	Select the Split logs size to check box to break up the log file into smaller files, and specify the maximum size of each file in MB. The default setting is 20 MB.

4. Click **Apply** to save your settings.

Sending Logs to a Syslog Servers

To enable and configure logs to be sent to a syslog server:

1. Select **Monitoring > Logs** from the menu. The Logs submenu tabs display, with the Log Management screen in view (see [Figure 102](#) on page 178).
2. Locate the Send Logs via Syslog section on the screen (see the following figure), and select the **Enable** check box to enable the STM to send logs to a syslog server.

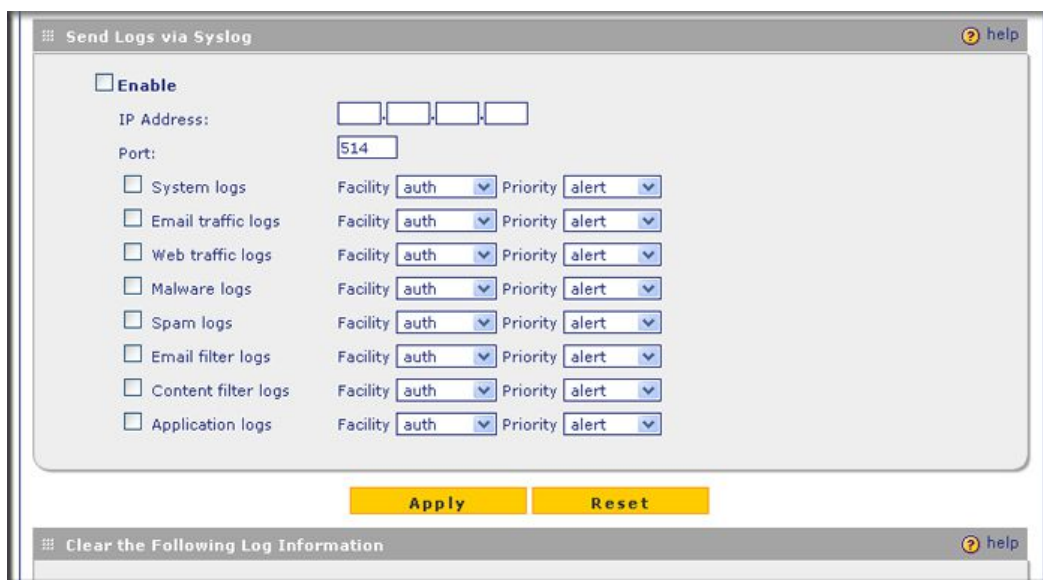

Figure 103. Log Management, screen 2 of 3

- Complete the fields, select the check boxes, and make your selections from the drop-down lists as explained in the following table:

Table 52. Syslog Settings

Setting	Description (or Subfield and Description)
IP Address	The IP address of the syslog server.
Port	The port number that the syslog server uses to receive logs. The default port number is 514.
Logs	<p>Select the check boxes to specify which logs are sent to the syslog server:</p> <ul style="list-style-type: none"> • System logs. The system event logs that include all system errors, informational messages, configuration changes, and system software updates. • Email traffic logs. All scanned incoming and outgoing traffic. • Web traffic logs. All scanned incoming and outgoing traffic. • Malware logs. All intercepted viruses and spyware. • Spam logs. All intercepted spam, including spam that was detected through the blacklist, real-time blacklist, and distributed spam analysis. • Email filter logs. All emails that are intercepted because of keyword, file type, file name, password, or size limit violations. • Content filter logs. All websites, URLs, and FTP sites that are intercepted because of Web category, blacklist, file type, or size limit violations. • Application logs. All intercepted application access violations.

Table 52. Syslog Settings (Continued)

Setting	Description (or Subfield and Description)
Facility	<p>The facility indicates from which internal part of the STM the log message originates. For each log that you have selected to be sent to the syslog server (see earlier in this table), select one of the following facilities from the drop-down list:</p> <ul style="list-style-type: none"> • auth. Security and authorization log messages. • authpriv. Security and authorization log messages for sensitive information. • cron. Clock daemon log messages. • daemon. Other daemon log messages. • ftp. FTP log messages. • kern. Kernel log messages. • local0 through local7. Locally defined log messages (1 through 7). • lpr. Line printer subsystem log messages. • mail. Mail subsystem log messages. • news. Usenet news subsystem log messages. • syslog. Log messages that are generated internally by the syslog server (syslogd). • user. Generic user-level log messages. • uucp. Unix-Unix copy (UUCP) subsystem log messages.
Priority	<p>For each log that you have selected to be sent to the syslog server (see earlier in this table), select one of the following severities from the drop-down list:</p> <ul style="list-style-type: none"> • emerg. The STM is unusable. • alert. An action needs to be taken immediately. • crit. There are critical conditions. • err. There are error conditions. • warning. There are warning conditions. • notice. There are normal but significant conditions. • info. Informational messages. • debug. Debug-level messages. <p>Note: All the logs with a severity that is equal to and above the severity that you specify are logged on the specified syslog server. For example, if you select crit as the severity, then the logs with the severities crit, alert, and emerg are logged.</p>

4. Click **Apply** to save your settings.

Clearing Logs

To clear logs:

1. Select **Monitoring > Logs** from the menu. The Logs submenu tabs display, with the Log Management screen in view (see *Figure 102* on page 178). Locate the Clear the Following Log Information section at the bottom of the screen:



Figure 104. Log Management, screen 3 of 3

2. Select one or more check boxes to specify which logs are cleared:
 - **System.** The system event logs are cleared.
 - **Email traffic.** The logs with scanned incoming and outgoing email traffic are cleared.
 - **Web traffic.** The logs with scanned incoming and outgoing Web traffic are cleared.
 - **Malware.** The logs with intercepted viruses and spyware are cleared.
 - **Spam.** The logs with intercepted spam are cleared.
 - **Email filter.** The logs with intercepted emails are cleared.
 - **Content filter.** The logs with intercepted websites, URLs, and FTP sites are cleared.
 - **Application.** The logs with intercepted applications are cleared.
3. Click **Clear Log Information**.

Configuring Alerts

You can configure the STM to send an email alert when a failure, license expiration, or malware attack or outbreak occurs. Four types of alerts are supported:

- **Update Failure Alert.** Sent when an attempt to update any component such as a pattern file or scan engine firmware fails.
- **License Expiration Alerts.** Sent when a license is about to expire and then again when a license has expired.
- **Malware Alert.** Sent when the STM detects malware threats.
- **Malware Outbreak Alert.** Sent when the malware outbreak criteria that you have configured are reached or exceeded. Outbreak criteria are based on the number of malware threats detected within a specified period of time.

To configure and activate the email alerts:

1. Select **Monitoring > Alerts** from the menu. The Alerts screen displays:

Figure 105.

2. Select the check boxes and complete the fields as explained in the following table:

Table 53. Alerts Settings

Setting	Description (or Subfield and Description)	
Enable Update Failure Alerts	Select this check box to enable update failure alerts.	
Enable License Expiration Alerts	Select this check box to enable update license expiration alerts.	
Enable Malware Alerts	Select this check box to enable malware alerts, and configure the Subject and Message fields.	
	Subject	Enter the subject line for the email alert. The default text is [Malware alert].
	Message	Enter the content for the email alert. The default text is %VIRUSINFO%, which is the metaword that enables the STM to insert the correct malware threat information. Note: In addition to the %VIRUSINFO% metaword, you can insert the following metawords in your customized message: %TIME%, %PROTOCOL%, %FROM%, %TO%, %SUBJECT%, %FILENAME%, %ACTION%, %VIRUSNAME%.

Table 53. Alerts Settings (Continued)

Setting	Description (or Subfield and Description)						
Enable Malware Outbreak Alerts	Select this check box to enable malware outbreak alerts, and configure the Outbreak Criteria, Protocol, and Subject fields.						
	<table border="1"> <tr> <td>Outbreak Criteria</td> <td> To define a malware outbreak, specify the following fields: <ul style="list-style-type: none"> • malware found within. The number of malware incidents that are detected. • minutes (maximum 90 minutes). The period in which the specified number of malware incidents are detected. <p>Note: When the specified number of detected malware incidents is reached within the time threshold, the STM sends a malware outbreak alert.</p> </td> </tr> <tr> <td>Protocol</td> <td>Select the check box or check boxes to specify the protocols (SMTP, POP3, IMAP, HTTP, HTTPS, and FTP) for which malware incidents are detected.</td> </tr> <tr> <td>Subject</td> <td>Enter the subject line for the email alert.</td> </tr> </table>	Outbreak Criteria	To define a malware outbreak, specify the following fields: <ul style="list-style-type: none"> • malware found within. The number of malware incidents that are detected. • minutes (maximum 90 minutes). The period in which the specified number of malware incidents are detected. <p>Note: When the specified number of detected malware incidents is reached within the time threshold, the STM sends a malware outbreak alert.</p>	Protocol	Select the check box or check boxes to specify the protocols (SMTP, POP3, IMAP, HTTP, HTTPS, and FTP) for which malware incidents are detected.	Subject	Enter the subject line for the email alert.
Outbreak Criteria	To define a malware outbreak, specify the following fields: <ul style="list-style-type: none"> • malware found within. The number of malware incidents that are detected. • minutes (maximum 90 minutes). The period in which the specified number of malware incidents are detected. <p>Note: When the specified number of detected malware incidents is reached within the time threshold, the STM sends a malware outbreak alert.</p>						
Protocol	Select the check box or check boxes to specify the protocols (SMTP, POP3, IMAP, HTTP, HTTPS, and FTP) for which malware incidents are detected.						
Subject	Enter the subject line for the email alert.						

3. Click **Apply** to save your settings.

Monitoring Real-Time Traffic, Security, Statistics, and Web Usage

You can monitor the real-time traffic, security events, and statistics from the Dashboard screen. The Web Usage screen displays which hosts on your network are consuming the most resources.

Understanding the Information on the Dashboard Screen

When you start up the STM, the default screen that displays is the Dashboard screen, which lets you monitor the following items:

- CPU, memory, and hard disk status
- The number of active connections per protocol
- The total malware threats and the malware threats over the last seven days
- Total scanned services traffic over the last seven days
- Statistics for the most recent five and top five malware threats detected, applications blocked, Web categories blocked, and spam emails blocked
- The real-time security scanning status with detected network traffic, detected network threats, and service statistics for the six supported protocols (HTTP, HTTPS, FTP, SMTP, POP3, and IMAP)
- Interface statistics

To display the Dashboard screen, select **Monitoring > Dashboard** from the menu. The Dashboard submenu tabs display with the Dashboard screen in view. Because of the size of this screen, it is divided and presented in this manual in three figures (the following figure, *Figure 107* on page 187, and *Figure 108* on page 189), each with its own table that explains the fields.

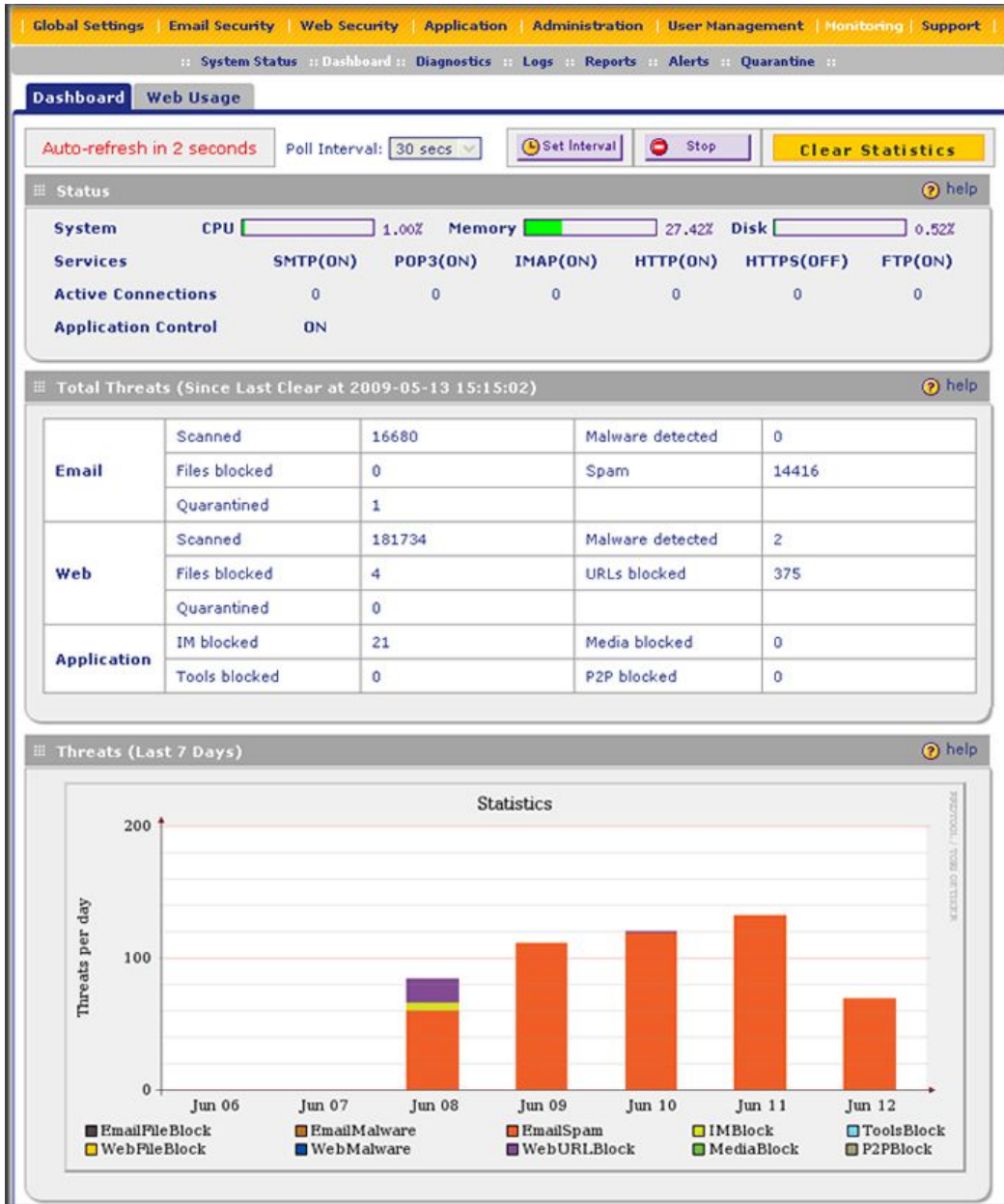

Figure 106. Dashboard, screen 1 of 3

Except for setting the poll interval and clearing the statistics, you cannot configure the fields on the Dashboard screen. Any changes need to be made on other screens.

To set the poll interval:

1. Click the **Stop** button.
2. From the Poll Interval drop-down list, select a new interval (the minimum is 5 seconds, the maximum is 5 minutes).
3. Click the **Set Interval** button.

To clear the statistics, click **Clear Statistics**.

The following table explains the fields of the Status, Total Threats, and Threats (Last 7 Days) sections of the Dashboard screen:

Table 54. Dashboard: Status, Total Threats, and Threats (Last 7 Days) Information

Item	Description
Status	
System	The current CPU, memory, and hard disk usage. When usage is within safe limits, the status bars show green.
Services	The protocols that are being scanned for malware threats. ON, OFF, or HALT is stated next to the protocol, and the number of active connections for each protocol. ON indicates that protocol is scanned; OFF indicates that the protocol is not scanned; HALT indicates that you enabled protocol scanning but the protection license has expired.
Active Connections	The number of active connection per protocol.
Application Control	ON indicates that application control is enabled; OFF indicates that application control is disabled; HALT indicates that you enabled application control but the protection license has expired. For information about how to configure application control, see Configuring Application Control on page 127.
Total Threats (Since Last Clear)	
Email	Displays the total number of: <ul style="list-style-type: none"> • Scanned (emails). • Files blocked (see Email Content Filtering on page 94). • Quarantined (see Email Content Filtering on page 94). • Malware detected (see Customizing Email Anti-Virus Settings on page 88). • Spam (see Protecting Against Email Spam on page 97).
Web	Displays the total number of: <ul style="list-style-type: none"> • Scanned (files). • Files blocked (see Configuring Web Content Filtering on page 109). • Quarantined (see Configuring Web Content Filtering on page 109). • Malware detected (see Configuring Web Malware Scans on page 107). • URLs blocked (see Configuring Web URL Filtering on page 116).

Table 54. Dashboard: Status, Total Threats, and Threats (Last 7 Days) Information (Continued)

Item	Description
Application	<p>Displays the total number of:</p> <ul style="list-style-type: none"> • IM blocked. • Tools blocked. • Media blocked. • P2P blocked. <p>Note: For information about how to configure these applications, see <i>Configuring Application Control</i> on page 127.</p>
Threats (Last 7 Days)	
<p>This is a graphic that shows the relative number of threats and access violations over the last week, using different colors for the various applications:</p> <p>Note: IMBlock stands for instant messaging applications blocked; P2PBlock stands for peer-to-peer applications blocked.</p>	

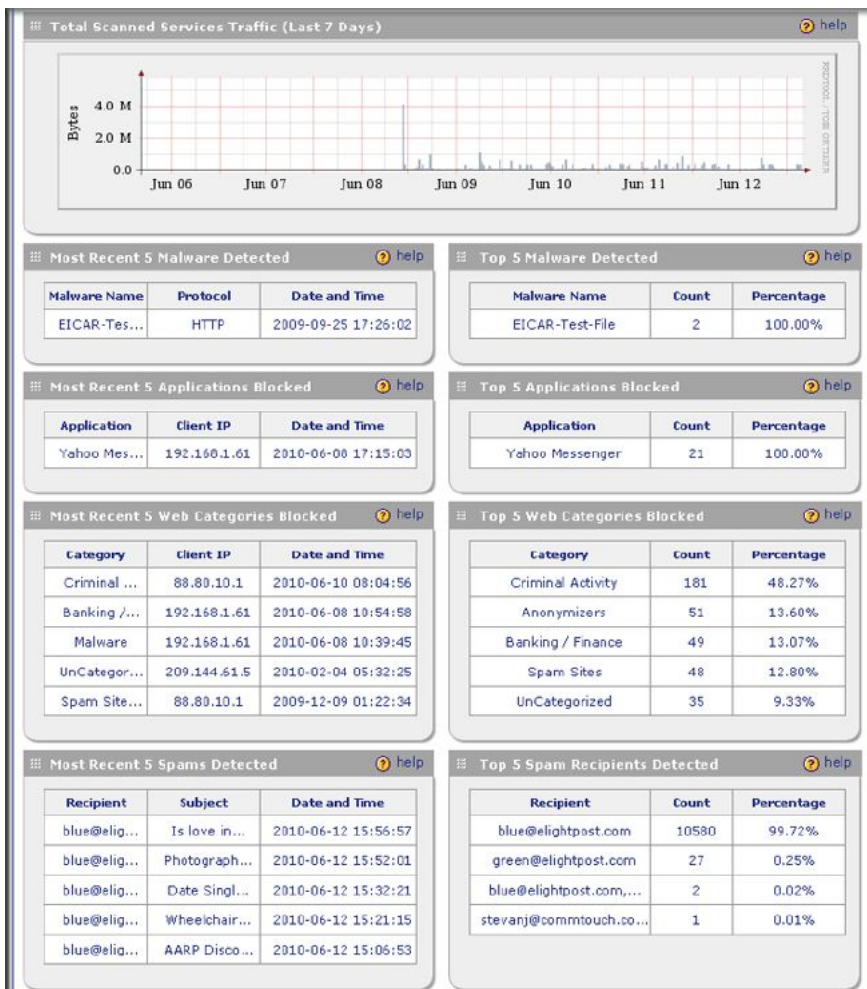

Figure 107. Dashboard, screen 2 of 3

The following table explains the fields of the Total Scanned Services Traffic, Most Recent 5, and Top 5 sections of the Dashboard screen:

Table 55. Dashboard: Total Scanned Services Traffic and Most Recent 5 and Top 5 Information

Item	Description	
Total Scanned Services Traffic (Last 7 Days)		
This is a graphic that shows the relative number of traffic in bytes over the last week.		
Category	Most Recent 5 Description	Top 5 Description
Malware	<ul style="list-style-type: none"> • Malware Name. The name of the malware threat. • Protocol. The protocol in which the malware threat was detected. • Date and Time. The date and time that the malware threat was detected. 	<ul style="list-style-type: none"> • Malware Name. The name of the malware threat. • Count. The number of times that the malware threat was detected. • Percentage. The percentage that the malware threat represents in relation to the total number of detected malware threats.
Application	<ul style="list-style-type: none"> • Application. The name of the application that was blocked. • Client IP. The client IP address from which the application request came. • Date and Time. The date and time that the application request was blocked. 	<ul style="list-style-type: none"> • Application. The name of the application that was blocked. • Count. The total number of user requests for the blocked application. • Percentage. The percentage that the application represents in relation to the total number of detected application requests.
Web	<ul style="list-style-type: none"> • Category. The Web category that was blocked. • Note: For more information about Web categories, see Configuring Web Content Filtering on page 109. • Client IP. The client IP address from which the Web request came. • Date and Time. The date and time that the Web request was blocked. 	<ul style="list-style-type: none"> • Category. The Web category that was blocked. • Note: For more information about Web categories, see Configuring Web Content Filtering on page 109. • Count. The total number of Web requests for the blocked Web category. • Percentage. The percentage that the Web category represents in relation to the total number of blocked Web categories.
Spam	<ul style="list-style-type: none"> • Recipient. The intended recipient of the spam message. • Subject. The email subject line in the spam message. • Date and Time. The date and time that the spam message was detected. 	<ul style="list-style-type: none"> • Recipient. The intended recipient of the spam message. • Count. The number of spam messages for the intended recipient. • Percentage. The percentage that the spam message represents in relation to the total number of detected spam messages.

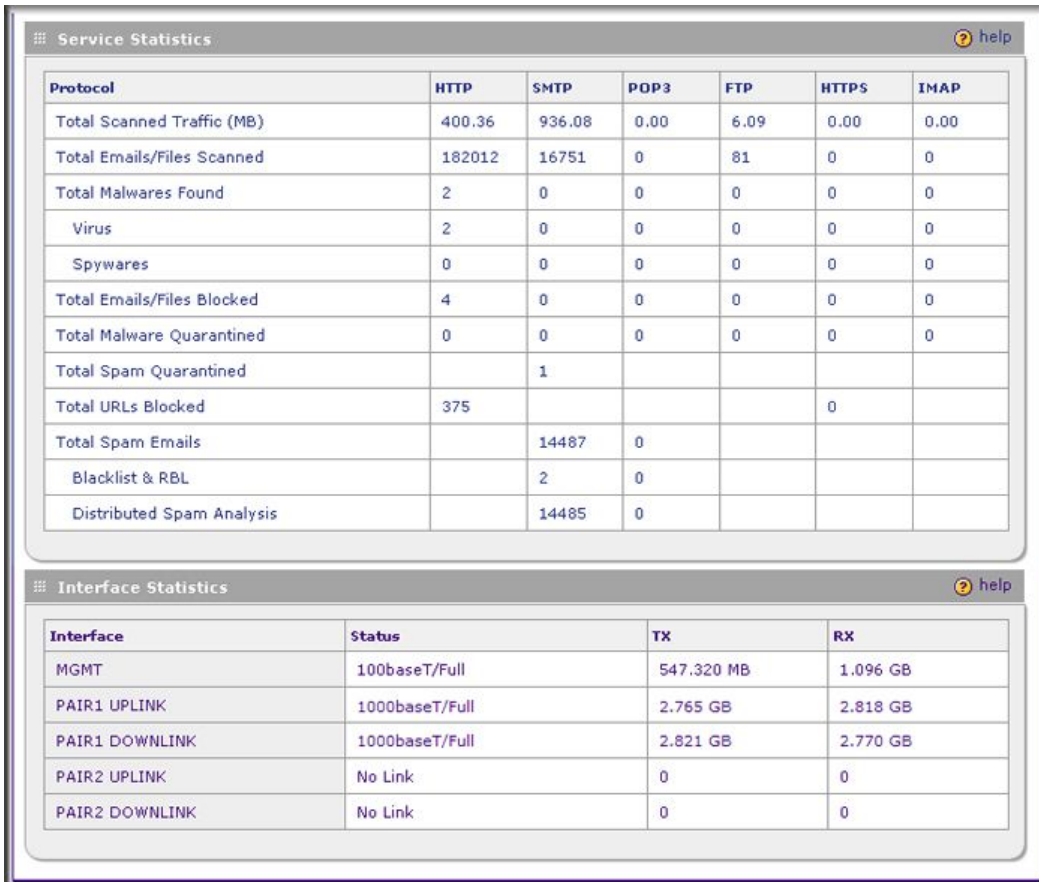

Figure 108. Dashboard, screen 3 of 3

Note: The previous figure shows the Interface Statistics section of the STM600. The STM300 and STM150 have different interfaces (see the following table).

The following table explains the fields of the Service Statistics and Interface Statistics sections of the Dashboard screen:

Table 56. Dashboard: Service Statistics and Interface Statistics Information

Item	Description
Service Statistics	
For each of the six supported protocols (HTTP, HTTPS, FTP, SMTP, POP3, and IMAP), this section provides the following statistics:	
Total Scanned Traffic (MB)	The total quantity of scanned traffic in MB.
Total Emails/Files Scanned	The total number of scanned emails and files.

Table 56. Dashboard: Service Statistics and Interface Statistics Information (Continued)

Item	Description	
Total Malwares Found	The total number of detected malware threats.	
	Virus	The total number of detected viruses.
	Spyware	The total number of detected spyware threats.
Total Emails/Files Blocked	The total number of blocked emails and files.	
Total Malware Quarantined	The total number of detected malware threats that were placed in quarantine.	
Total Spam Quarantined	The total number of spam messages that were placed in quarantine. Note: These statistics apply only to SMTP.	
Total URLs Blocked	The total number of URL requests that were blocked. Note: These statistics apply only to HTTP and HTTPS.	
Total Spam Emails	The total number of spam emails that were detected. Note: These statistics apply only to SMTP and POP3.	
	Blacklist & RBL	The total number of emails that were detected through the spam blacklist and the real-time blacklist (see Setting Up the Whitelist and Blacklist on page 98 and Configuring the Real-Time Blacklist on page 100).
	Distributed Spam Analysis	The total number of spam messages that were detected through distributed spam analysis (see Configuring Distributed Spam Analysis on page 102).
Interface Statistics STM600: MGMT (Management), PAIR1 UPLINK, PAIR1 DOWNLINK, PAIR2 UPLINK, PAIR2 DOWNLINK. STM300: MGMT, UPLINK, DOWNLINK. STM150: LAN1, LAN2, LAN3, LAN4, WAN.		
For each interface the following statistics are displayed:		
Status	10BaseT Half duplex, 10BaseT Full duplex, 100BaseT Half duplex, 100BaseT Full duplex, or No Link.	
TX	The number of transmitted packets in KB, MB, or GB (as stated on the screen).	
RX	The number of received packets in KB, MB, or GB (as stated on the screen).	

Monitoring Web Usage

The Web Usage screen shows you how the STM's Web resources are being used. You can see, for example, which host on the STM uses most resources.

To view the STM's Web usage:

1. Select **Monitoring > Dashboard** from the menu. The Dashboard submenu tabs display with the Dashboard screen in view.
2. Click the **Web Usage** submenu tab. The Web Usage screen displays:

TOP	Category	Requests	% of Requests	IPs	% of IPs	Blocked
1	Webmail	13327	63.35	3	38.95	no
2	Search Engines & Portals	7498	35.64	3	44.21	no
3	Computers & Technology	113	0.54	1	18.95	no
4	Government	34	0.16	1	1.05	no
5	Peer-to-Peer	28	0.13	1	14.74	no
6	Education	8	0.04	1	1.05	no
7	Anonymizers	6	0.03	1	6.32	yes
8	Spam Sites	6	0.03	1	6.32	yes
9	General	5	0.02	1	4.21	no
10	News	5	0.02	1	5.26	no
11	Banking / Finance	3	0.01	1	1.05	no
12	Advertisements & Pop-Ups	2	0.01	1	1.05	no
13	Banking / Finance	2	0.01	1	1.05	yes
14	Entertainment	1	0.00	1	1.05	no

Figure 109.

3. Use the From drop-down list to select the start date of the Web usage report (year, month, date) and the To drop-down list to select the end date of the report (year, month, date).
4. Click **View**. The STM generates a Web usage report.

The Web usage reports shows the following columns:

- **TOP.** The Web usage ranking.
- **Category.** The Web content filtering category.
- **Requests.** The number of requests for the category.
- **% of Requests.** The percentage of requests for the category in relation to the total number of Web requests.
- **IPs.** The number of IP addresses that request the category.
- **% of IPs.** The percentage of IP addresses that request the category in relation to the total number of IP addresses.
- **Blocked.** Whether or not the category is blocked by the STM.

Viewing System Status

The System Status screen provides real-time information about the following components of the STM:

- Firmware versions and update information of the STM, software versions and update information of the components, license expiration dates for each type of license, and hardware serial number
- Management interface information
- MAC addresses for the STM's interfaces

To view the System Status screen select **Monitoring > System Status**. The following figure displays the System Status screen of the STM600. The Interfaces section of the System Status screen differs for the STM300 and STM150 (see the explanation in the following table).

The screenshot displays the System Status screen with the following sections:

System Information

Component	Current Version	Last Update
Software	V3.0.0-43	2011-01-14
Scan Engine	V8.1.3.107	2010-12-07
Pattern File	201101171822	2011-01-17
OS	V1.2.0.1	2010-11-29

[+ More](#)

Hardware Serial Number: stm300satish0

License Key	License Type	Expiration Date
NG1F02-A9B9-F289-0611-BDED-C68D-6249-04CE-7175	Web Protection	2012-04-20
NG1F01-7311-7FDB-D052-D394-33ED-42A7-F1C5-0E5F	Email Protection	2012-04-20
NG1F00-8448-4B28-129E-6CF0-47A9-2413-B0BE-3B9F	Support & Maintenance	2012-05-20

Upon license expiration, the LED blinks to remind you to renew. Press the following button to stop the LED from blinking: [Stop LED Blinking](#)

Management Interface Information

System Name:	STM600
IP Address:	192.168.1.161
Subnet Mask:	255.255.255.0
Gateway IP Address:	192.168.1.254
Primary DNS:	192.168.1.254
Secondary DNS:	4.2.2.2

Interfaces

Interface	MAC Address
MGMT	00:90:0B:10:D3:29
PAIR1 DOWNLINK	00:90:0B:10:D3:2B
PAIR1 UPLINK	00:90:0B:10:D3:2A
PAIR2 DOWNLINK	00:90:0B:10:D4:97
PAIR2 UPLINK	00:90:0B:10:D4:96

Figure 110.

The following table explains the fields of the System Information, Management Interface Information, and Interfaces sections of the System Status screen:

Table 57. System Status Information

Setting	Description
System Information	
Firmware Information	The current version and most recent update (that is, the most recently downloaded version) for the software, scan engine, pattern file, and operating system (OS). Click + More to display the versions and most recent downloads for the antispam engine, applications engine, applications pattern file, stream engine, stream pattern file, mini engine, mini pattern file, policyd, scand, urld, update client, and rescue software.
Hardware Serial Number	The hardware serial number of the STM.
License Expiration Date	The license keys and the expiration dates for the email protection, Web protection, and maintenance and support licenses. Note: When a license has expired, the license expiration date is displayed in red font. When a license expires, a LED on the front panel of the STM blinks continuously to remind you to renew the license. To stop the blinking, click Stop LED Blinking . On the STM150: The Test LED blinks when a license expires. On the STM300 and STM600: The Status LED blinks when a license expires.
Management Interface Information	
System Name	These fields are self-explanatory. You can configure these fields on the Network Settings screen (see <i>Configuring Network Settings</i> on page 52).
IP Address	
Subnet Mask	
Gateway IP Address	
Primary DNS	
Secondary DNS	
Interfaces	
The MAC addresses of the STM's interfaces. (The previous figure displays the System Status screen for the STM600.) STM600: MGMT (Management), PAIR1 DOWNLINK, PAIR1 UPLINK, PAIR2 DOWNLINK, PAIR2 UPLINK. STM300: MGMT, DOWNLINK, UPLINK. STM150: LAN, WAN. (The four LAN interfaces share a single MAC address.)	

Querying Logs

The extensive log querying functions of the STM can help you to monitor the protection of the network and fine-tune the performance of the STM.

For information about emailing logs and sending logs to a syslog server, see [Configuring and Activating System, Email, and Syslog Logs](#) on page 177.

The STM generates logs that provide detailed information about malware threats and traffic activities on the network. You can search and view these logs through the Web Management Interface or save the log records in CSV or HTML format and download them to a computer (the downloading option is not available for all logs). You can also specify how many entries are displayed per page (the default setting is 15 entries).

The STM provides nine types of logs:

- **Email traffic.** All scanned incoming and outgoing email traffic.
- **Web traffic.** All scanned incoming and outgoing Web traffic.
- **Virus.** All intercepted viruses.
- **Spyware.** All intercepted spyware.
- **Spam.** All intercepted spam, including spam that was detected through the blacklist, real-time blacklist, and distributed spam analysis.
- **Email filters.** All emails that are intercepted because of keyword, file type, file name, password, or size limit violations.
- **Content filters.** All websites, URLs, and FTP sites that are intercepted because of Web category, blacklist, file type, or size limit violations.
- **System.** The system event logs that include all system errors, informational messages, configuration changes, and system software updates.
- **Application.** All intercepted application access violations.

You can query and generate each type of log separately and filter the information based on a number of criteria. For example, you can filter the virus logs using the following criteria (other log types have similar filtering criteria):

- Start date and time
- End date and time
- Protocols (HTTP, HTTPS, FTP, SMTP, POP3, and IMAP)
- Virus name
- Action (delete, quarantine, quarantine email, block email, and log)
- Domain name
- User name
- Client IP address
- Server IP address

- Recipient email address
- URL or subject

To query and download logs:

1. Select **Monitoring > Logs** from the menu. The Logs submenu tabs display, with the Log Management screen in view.
2. Click the **Logs Query** submenu tab. The Logs Query screen displays (see the following figure).

Depending on the selection that you make from the Log Type drop-down list, the screen adjusts to display the settings for the selected type of log. The following figure displays the Virus log information settings as an example.

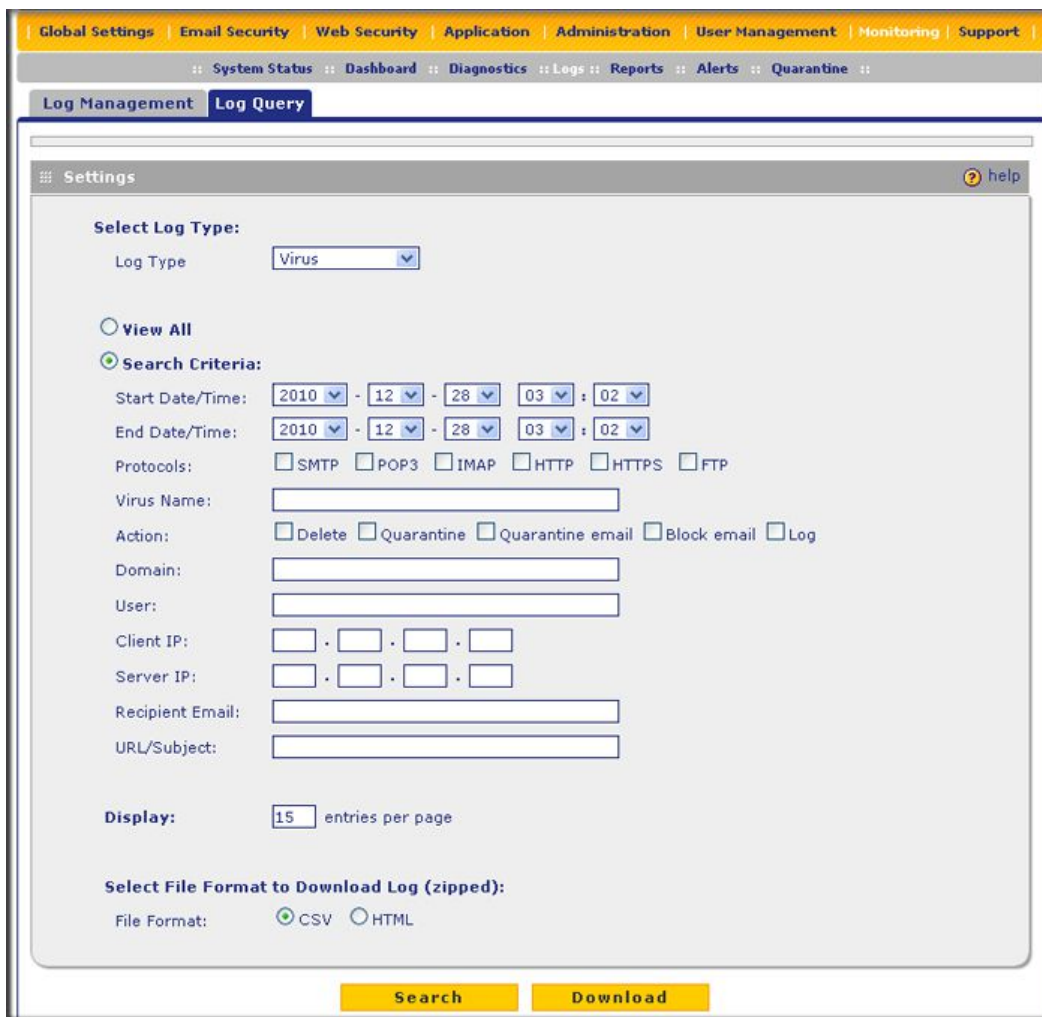

Figure 111.

3. Select the check boxes and radio buttons, make your selections from the drop-down lists, and complete the fields as explained in the following table:

Table 58. Log Query Settings

Setting	Description (or Subfield and Description)
Log Type	<p>Select one of the following log types from the drop-down list:</p> <ul style="list-style-type: none"> • Email traffic. All scanned incoming and outgoing email traffic. • Web traffic. All scanned incoming and outgoing email traffic. • Virus. All intercepted viruses. • Spyware. All intercepted spyware. • Spam. All intercepted spam, including spam that was detected through the blacklist, real-time blacklist, and distributed spam analysis. • Email filters. All emails that are intercepted because of keyword, file type, file name, password, or size limit violations. • Content filters. All websites, URLs, and FTP sites that are intercepted because of Web category, blacklist, file type, or size limit violations. • System. The system event logs that include all system errors, informational messages, configuration changes, and system software updates. • Application. All intercepted application access violations.
View All	<p>Select one of the following radio buttons:</p> <ul style="list-style-type: none"> • View All. Display or download the entire selected log.
Search Criteria	<ul style="list-style-type: none"> • Search Criteria. Query the selected log by configuring the search criteria that are available for the selected log.
Start Date/Time	<p>From the drop-down lists, select the year, month, day, hours, and minutes for the start date and time.</p> <p>This field is available for the following logs: Email traffic, Web traffic, Virus, Spyware, Spam, Email filters, Content filters, System, and Application.</p>
End Date/Time	<p>From the drop-down lists, select the year, month, day, hours, and minutes for the end date and time.</p> <p>This field is available for the following logs: Email traffic, Web traffic, Virus, Spyware, Spam, Email filters, Content filters, System, and Application.</p>
Protocols	<p>Select one or more check boxes to specify the protocols that are queried.</p> <p>The following protocols can be selected:</p> <ul style="list-style-type: none"> • For the Email traffic log: SMTP, POP3, and IMAP. • For the Web traffic log: HTTP, HTTPS, and FTP. • For Virus, and Spyware logs: SMTP, POP3, IMAP, HTTP, HTTPS, and FTP. • For the Spam log: SMTP and POP3. • For the Email filters log: SMTP, POP3, and IMAP. • For the Content filters log: HTTP, HTTPS, and FTP.

Table 58. Log Query Settings (Continued)

Setting	Description (or Subfield and Description)	
Search Criteria (continued)	Domain	The domain name that is queried. This field is available for the following logs: Email traffic, Web traffic, Virus, Spyware, Spam, Email filters, Content filters, and Application.
	User	The user name that is queried. This field is available for the following logs: Email traffic, Web traffic, Virus, Spyware, Spam, Email filters, Content filters, and Application.
	Client IP	The client IP address that is queried. This field is available for the following logs: Email traffic, Web traffic, Virus, Spyware, Spam, Content filters, and Application.
	Server IP	The server IP address that is queried. This field is available for the following logs: Email traffic, Web traffic, Virus, Spyware, Content filters, and Application.
	Reason	Select one or more check boxes to specify the reasons that are queried: The following reasons can be selected: <ul style="list-style-type: none"> • For the Email filters log: keyword, file type, file name, password, and size limit. • For the Content filters log: Web category, file type, blacklist, and size limit.
	Virus Name	The name of the virus that is queried. This field is available only for the Virus log.
	Spyware Name	The name of the spyware that is queried. This field is available only for the Spyware log.
	Action	Select one or more check boxes to specify the malware treatment actions that are queried. The following actions can be selected: <ul style="list-style-type: none"> • For the Virus and Spyware logs: Delete, Quarantine, Quarantine email, Block email, or Log. • For the Spam log: Block, Tag, or Quarantine.
	Detected By	Select one or all check boxes to specify the method by which spam is detected: Blacklist, RBL, or Distributed Spam Analysis. This field is available only for the Spam log.
	Subject	The email subject that is queried: This field is available for the following logs: Email traffic, Spam, and Email filters.
Sender Email	The email address of the sender that is queried. This field is available only for the Email traffic log.	

Table 58. Log Query Settings (Continued)

Setting	Description (or Subfield and Description)	
Search Criteria (continued)	Recipient Email	The email address of the recipient that is queried. This field is available for the following logs: Email traffic, Virus, Spyware, Spam, and Email filters.
	URL/Subject	The URL and subject that are queried. This field is available for the following logs: Traffic, Virus, and Spyware.
	URL	The URL that is queried. This field is available for the following logs: Web traffic and Content filters.
	Category	The Web or application category that is queried. This field is available for the following logs: Content filters and Application.
	Size	The file's minimum and maximum size (in bytes) that are queried. This field is available only for the Web traffic log.
	Type	Select one or more check boxes to specify the system event types that are queried: Error (all system errors), Info (all informational messages), Conf (all configuration changes), and Update (all system software updates). This field is available only for the System log.
	Event	The description of the event incident that is queried. This field is available only for the System log.
	Section	The application group (Instant Messaging, Media Applications, Peer to Peer, or Tools) that is queried. This field is available only for the Application log.
Display	The maximum number of pages that are displayed. The default setting is 15 entries.	
Download Log (zipped) File Format	Select a radio button to specify the format in which to download the zipped log file: <ul style="list-style-type: none"> • CSV. Download the log file as a comma-separated values (CSV) file. • HTML. Download the log file as an HTML file. 	

4. Click one of the following action buttons:
 - **Search.** Query the log according to the search criteria that you specified and view the log through the Web Management Interface, that is, onscreen.
 - **Download.** Query the log according to the search criteria that you specified, and download the log to a computer.

Example: Using Logs to Identify Infected Clients

You can use the STM logs to help identify potentially infected clients on the network. For example, clients that are generating abnormally high volumes of HTTP traffic might be infected with spyware or a virus.

To identify infected clients that are sending spyware or a virus in outbound traffic, query the STM spyware and virus logs and see if any of your internal IP addresses are the source of spyware or a virus:

1. On the Log Query screen (see [Figure 111](#) on page 195), select **Web traffic** as the log type.
2. Select the start date and time from the drop-down lists.
3. Select the end date and time from the drop-down lists.
4. Next to Protocols, select the **HTTP** check box.
5. Click **Search**. After a while, the log displays onscreen.
6. Check if there are clients that are sending out suspicious volumes of data, especially to the same destination IP address, on a regular basis.

If you find a client exhibiting this behavior, you can run a query on that client's HTTP traffic activities to get more information. Do so by running the same HTTP traffic query and entering the client IP address in the Client IP field.

Log Management

Generated logs take up space and resources on the STM internal disk. To ensure that there is always sufficient space to save newer logs, the STM automatically deletes older logs whenever the total log size reaches 50 percent of the allocated file size for each log type.

Automated log purging means that you do not need to constantly manage the size of the STM logs and ensures that the latest malware incidents and traffic activities are always recorded.

Note: The STM saves its logs every 5 minutes. If a power failure affects the STM, logs that were created within the 5-minute period before the power failure occurred are lost. Therefore, NETGEAR recommends that you connect the STM to a syslog server to save the logs externally.

For information about how to manually purge selected logs, see [Clearing Logs](#) on page 182.

Viewing, Scheduling, and Generating Reports

The extensive reporting functions of the STM let you perform the following tasks that help you to monitor the protection of the network and the performance of the STM:

- Generating, viewing, and downloading Web, email, application, and system reports
- Scheduling automatic Web, email, application, and system reports, and emailing these reports to specified recipients

You can view the reports onscreen, download them to your computer, and configure the STM to send them to one or more email addresses.

The STM provides preconfigured report templates. As an option, you can apply advanced filtering options to specify the number of top entries to be included, the chart type, and the output format, and you can filter the report on the following components:

- Client IP addresses
- Users
- Destinations

Because of the size and nature of the Reports screen, it is divided and presented in this manual in several figures that are explained in the following sections:

- *Report Templates* on this page
- *Generating Reports for Downloading* on page 202
- *Scheduling Automatic Generation and Emailing of Reports* on page 203
- *Advanced Report Filtering Options* on page 204

Report Templates

The STM provides preconfigured report templates in four categories:

- Web Activity
- Email Activity
- Application Activity
- System Information

To display the report templates and view reports onscreen:

1. Select **Monitoring > Reports** from the menu. The Reports screen displays. The following figure shows only the Report Templates section of the screen with the preconfigured report templates.

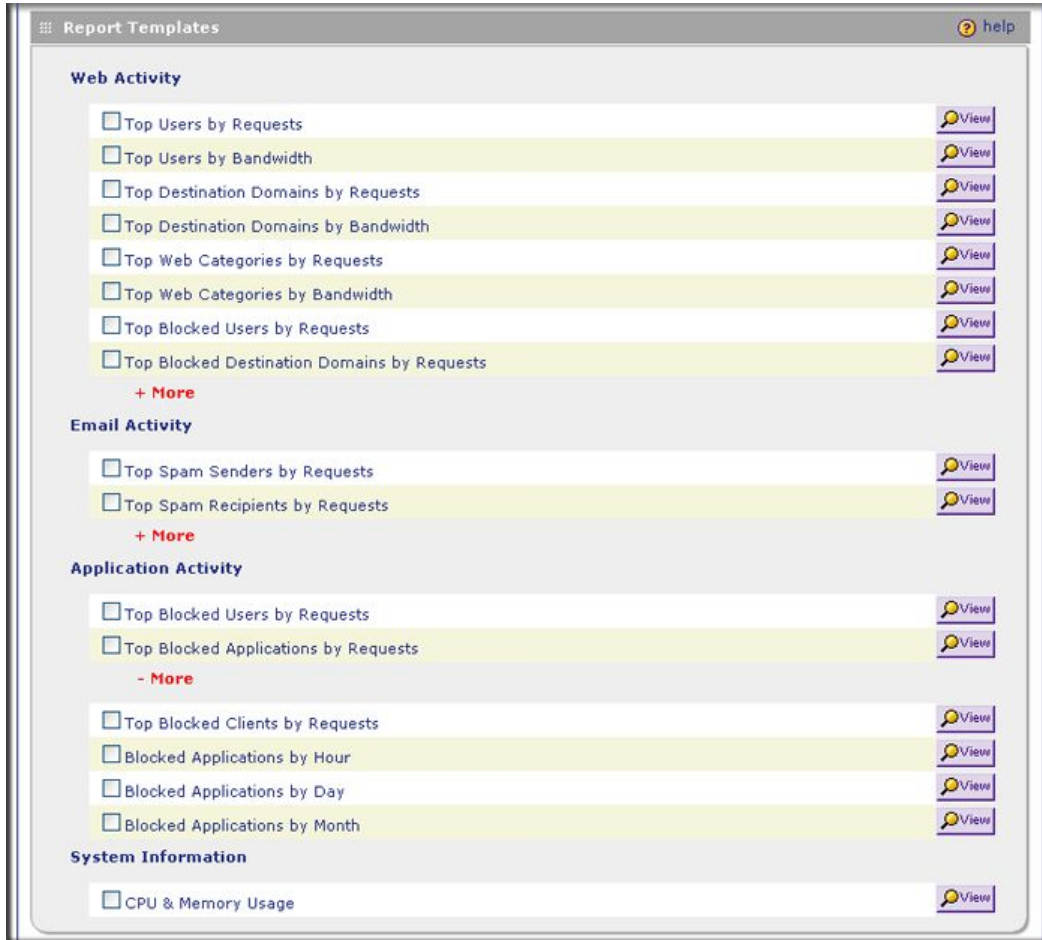

Figure 112.

2. Click the red **+ More** button for a report category to display the advanced report templates for that category. The System Information category contains only a single report template.
3. Click **View** for a report to display the selected report onscreen. To set a time range and advanced filtering options for a report, see the following sections.

For detailed information about report templates, including what type of information is presented in each report and what type of advanced filtering you can apply to each report, see [Appendix A, Report Templates](#).

Generating Reports for Downloading

To generate a report:

1. Select **Monitoring > Reports** from the menu. The Reports screen displays. By default, the Generate Report radio button is selected. The following figure shows the Reports screen without the Template Reports section, and shows some samples in the Generated Report List.

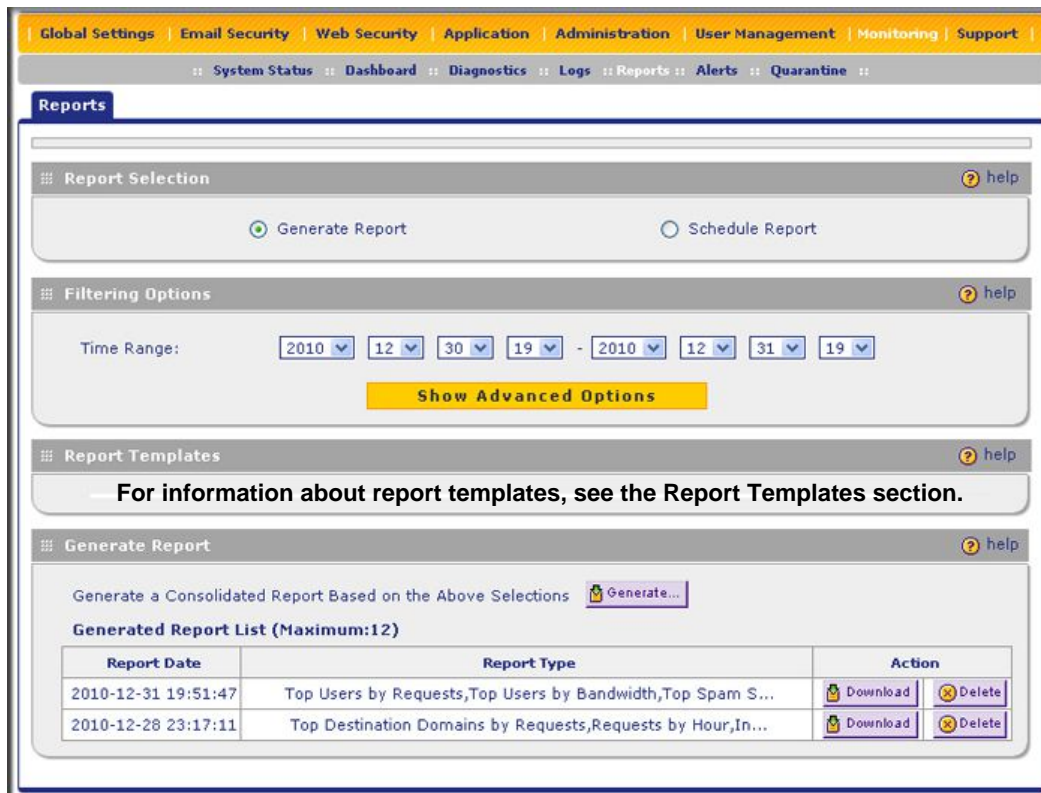

Figure 113.

2. In the Filtering Options section of the screen, make your selections from the Time Range drop-down lists. Specify a start date and time and an end date and time. For advanced filtering options, see [Advanced Report Filtering Options](#) on page 204.
3. In the Report Templates section of the screen, select the check boxes for the reports that you want to generate. For information, see [Report Templates](#) on page 200 and [Appendix A, Report Templates](#).
4. In the Generate Report section of the screen, click **Generate**. After a short while, the report is added to the Generated Report List. This list can contain a maximum of 12 saved reports. (To delete a previously saved report, click its **Delete** table button in the Action column.)
5. Download the new report (or a previously saved report) by clicking its **Download** table button in the Action column.

The report is downloaded as a zipped file. By default, the zipped file contains MHTML files. However, you can change the output format from the Output Format drop-down list

in the advanced filtering options section of the screen (see [Advanced Report Filtering Options](#) on page 204).

Scheduling Automatic Generation and Emailing of Reports

To schedule a report and enable the STM to email the report:

1. Select **Monitoring > Reports** from the menu. The Reports screen displays.
2. In the Report Selection section of the screen, select the **Schedule Report** radio button. The screen adjusts to display the scheduling and emailing options. The following figure shows the Reports screen without the Template Reports section, and with some samples in the Scheduled Report List.

The screenshot shows the 'Reports' configuration page. The 'Report Selection' section has 'Schedule Report' selected. The 'Filtering Options' section shows 'Weekly' frequency on 'Sunday' at '03:00'. The 'Schedule Report' section has 'Reports to Keep' set to 5 and 'Send Report by Email' checked. The 'Scheduled Report List' table is as follows:

!	Report Name	Report Type	Email Report to	Frequency	Action
●	BlockedAppl...	Top Blocked Users by Reques...	stmsadmin@netgear.com	Weekly	[Edit] [Disable] [Delete]
●	TopUsers	Top Users by Requests,Top U...	stmsadmin@netgear.com	Weekly	[Edit] [Disable] [Delete]

Figure 114.

3. In the Filtering Options section of the screen, make your selections from the Frequency drop-down lists to specify the frequency with which the reports are generated.
 - **Daily.** If you do not use the drop-down lists to change the time, the report is generated daily at 3:00 a.m.

- **Weekly.** By default, the report is generated weekly on Sunday at 3:00 a.m. You can use the drop-down lists to change the day of the week and the time.
- **Monthly.** If you do not use the drop-down lists to change the time, the report is generated on the first of the month at 3:00 a.m. You cannot change the day of the month.

For advanced filtering options, see [Advanced Report Filtering Options](#) on page 204.

4. In the Report Templates section of the screen, select the check boxes for the reports that you want to generate. For information, see [Report Templates](#) on page 200 and [Appendix A, Report Templates](#).
5. Configure the Schedule Report section of the screen as explained in the following table:

Table 59. Schedule Report Settings

Setting	Description				
Report Name	Enter a unique name for the report.				
Reports to keep	Enter the maximum number of reports that you want to be saved in the Scheduled Report List. The maximum number of report that can be saved is 12. The default number is 5.				
Send Report by Email	Select the Send Report by Email check box to enable the STM to send the report to the recipients that you specify in the Email Report to field.				
	<table border="1"> <tr> <td>Email Report to</td> <td>The email addresses of the report recipients.</td> </tr> <tr> <td></td> <td>Note: Use commas to separate email addresses.</td> </tr> </table>	Email Report to	The email addresses of the report recipients.		Note: Use commas to separate email addresses.
Email Report to	The email addresses of the report recipients.				
	Note: Use commas to separate email addresses.				

6. Still in the Schedule Report section of the screen, click the **Add** table button to add the report to the Scheduled Report List. The report is automatically enabled, which is indicated by a green circle in the leftmost column, enabling the STM to automatically generate the report at the specified date and time.

The buttons in the Action column of the Scheduled Report List allow you perform the following actions:

- **Edit.** Opens the Edit Scheduled Report screen to let you make changes to the report.
- **Disable.** Disables the automatic generation of the report. The circle in the leftmost column turns gray.
- **Enable.** Enables the automatic generation of the report. The circle in the leftmost column turns green.
- **Delete.** Deletes the report.

Advanced Report Filtering Options

You can configure advanced filtering options for both generated and scheduled reports. Although the Time Range drop-down lists apply only to the generated reports and the Frequency drop-down lists apply only to the scheduled reports, the advanced filtering options

are identical for both types of reports but need to be specified separately for each generated report and each scheduled report.

To configure advanced filtering options:

1. Select **Monitoring > Reports** from the menu. The Reports screen displays.
2. In the Report Selection section, select one of the following radio buttons:
 - **Generate Report.**
 - **Schedule Report.**
3. Depending on the whether you selected to generate or schedule a report, perform one of the following actions:
 - If you selected Generate Report, make your selections from the Time Range drop-down lists.
 - if you selected Schedule Report, make your selections from the Frequency drop-down lists.
4. In the Filtering Options section of the screen, click **Show Advanced Options**. The following figure shows only the advanced options of the Filtering Options section of the screen.

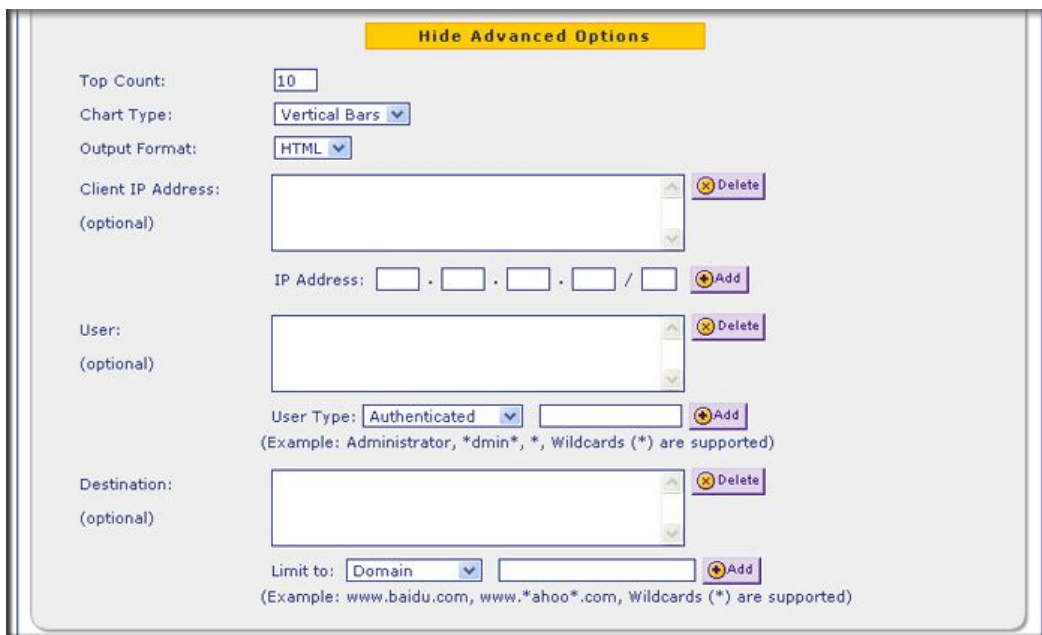

Figure 115.

5. Configure the advanced filtering options as explained in the following table:

Table 60. Advanced Filtering Options Settings

Setting	Description	
Top Count	<p>Enter a number between 1 and 100 to specify how many entries are included in reports that provide a top count, such as the Top Users by Requests report or the Top Spam Senders by Requests report.</p> <p>The default number is 10, which means that 10 users are included in the Top Users by Requests report and 10 senders are included in the Top Spam Senders by Requests report.</p>	
Chart Type	<p>Specify the type of chart that is generated in the report by making one of the following selections from the drop-down list:</p> <ul style="list-style-type: none"> • Vertical Bars. This is the default selection. • Line. • Pie. 	
Output Format	<p>Specify the output format of the report by making one of the following selections from the drop-down list:</p> <ul style="list-style-type: none"> • HTML. The report is generated as a zipped file that contains MIME HTML (MHTML or MTH) files. This is the default setting. • PDF. The report is generated as a zipped file that contains PDF files. • CSV. The report is generated as a zipped file that contains comma-separated values (CSV) files. 	
Client IP Address	<p>To filter the report results on a client IP address, enter the IP address and optional subnet mask in the IP Address fields below the Client IP Address table, and then click the Add table button to add the IP address to the Client IP Address table. You can add multiple IP addresses to the table.</p> <p>To delete an entry from the Client IP Address table, select the entry, and then click the Delete table button.</p>	
User	<p>To filter the report results on a user identity, make a selection from the User Type drop-down list below the User table. The screen adjusts depending on your selection; the different options are explained in the following rows in this table. After you have specified the user identity, click the Add table button to add the user to the User table. You can add multiple users to the table. Wildcards (*) are supported.</p> <p>To delete an entry from the User table, select the entry, and then click the Delete table button.</p>	
	Authenticated	<p>Enter the name of an authenticated user, or use wildcards to specify a group of users. To specify all authenticated users, enter *. Then click the Add table button. You can add multiple users to the User table.</p>
	Unauthenticated	<p>You cannot further specify unauthenticated users; just click the Add table button.</p>

Table 60. Advanced Filtering Options Settings (Continued)

Setting	Description	
Users (continued)	Local User	<p>Enter the name of a local user, or use wildcards to specify a group of users. To specify all local users, enter *. Then click the Add table button.</p> <p>Alternately, click the Lookup table button to open a table that displays all local users, each user with an individual Add table button that lets you add the user to the User table. You can add multiple users to the User table.</p> <p>Note: Groups to which local users might belong are not displayed.</p>
	LDAP User	<p>Select an LDAP domain from the drop-down list to the right of the User Type drop-down list. Enter the name of an LDAP user, or use wildcards to specify a group of users. To specify all LDAP users who belong to the selected LDAP domain, enter *. Then click the Add table button.</p> <p>Alternately, click the Lookup table button to open a table that displays all users who belong to the selected LDAP domain, each user with an individual Add table button that lets you add the user to the User table. You can add multiple users to the User table.</p>
	RADIUS User	<p>Select a RADIUS domain from the drop-down list to the right of the User Type drop-down list. Enter the name of a RADIUS user, or use wildcards to specify a group of users. To specify all RADIUS users who belong to the selected RADIUS domain, enter *. Then click the Add table button.</p> <p>Alternately, click the Lookup table button to open a table that displays all users who belong to the selected RADIUS domain, each user with an individual Add table button that lets you add the user to the User table. You can add multiple users to the User table.</p>
Destination	<p>To filter the report results on a Web destination such as a domain, Web category, or application, make a selection from the Limit to drop-down list below the Destination table. The screen adjusts depending on your selection; the different options are explained in the following rows in this table. After you have specified the destination, click the Add table button to add the destination to the Destination table. You can add multiple destinations to the table.</p> <p>To delete an entry from the Destination table, select the entry, and then click the Delete table button.</p>	
	Domain	<p>Enter the name of a domain or use wildcards to specify a group of domains. Then click the Add table button. You can add multiple domains to the Destination table.</p>

Table 60. Advanced Filtering Options Settings (Continued)

Setting	Description	
Destination (continued)	Category	<p>From the drop-down list to the right of the Limit to drop-down list, select one of the following options:</p> <ul style="list-style-type: none"> • Web Categories. The screen displays a table with all Web categories, each one with an individual Add table button that lets you add the category to the Destination table. You can add multiple categories to the Destination table. • Applications. The screen displays a table with all applications, each one with an individual Add table button that lets you add the application to the Destination table. You can add multiple applications to the Destination table.

6. In the Report Templates section of the screen, select the check boxes for the reports that you want to generate. For information, see [Report Templates](#) on page 200 and [Appendix A, Report Templates](#).
7. Depending on whether you selected to generate or schedule a report, perform one of the following actions:
 - If you selected Generate Report, click **Generate** in the Generate Report section of the screen. For more information, see [Generating Reports for Downloading](#) on page 202.
 - If you selected Schedule Report, configure the settings in the Schedule Report section of the screen, and click the **Add** table button. For more information, see [Scheduling Automatic Generation and Emailing of Reports](#) on page 203.

Viewing and Managing the Quarantine Files

Depending on the selections that you made on the screens of the Email Security and Web Security main menus (see [Chapter 4, Content Filtering and Optimizing Scans](#)), the STM intercepts and saves emails that are infected by spam and both emails and files that are infected by malware threats (viruses and spyware) to its quarantine files. You can search these files, view the search results through the Web Management Interface, and then take a variety of actions that are described in [Viewing and Managing the Quarantined Spam Table](#) on page 212 and [Viewing and Managing the Quarantined Infected Files Table](#) on page 213. You can also specify how many entries are displayed per page (the default setting is 15 entries).

Note: For information about how to specify the quarantine settings, see [Managing the Quarantine Settings](#) on page 81.

You can query and view the spam quarantine file and the malware quarantine file separately and filter the information based on a number of criteria. You can filter the spam quarantine file using the following criteria:

- Start date and time
- End date and time
- Domain name
- User name
- Source IP address
- Sender email address
- Recipient email address
- Subject
- Size of the email

You can filter the malware quarantine file using the following criteria:

- Start date and time
- End date and time
- Protocols (HTTP, HTTPS, FTP, SMTP, POP3, and IMAP)
- Domain name
- User name
- Malware name
- Client IP address
- Recipient email address
- Recipient email address
- URL or subject
- Size of the file

To query the quarantine files:

1. Select **Monitoring > Quarantine** from the menu. The Quarantine screen displays (see the following figure).
2. Depending on the selection that you make from the Quarantine File Type drop-down list, the screen adjusts to display the settings for the selected type of quarantine file. The following figure displays the spam quarantine file settings as an example.

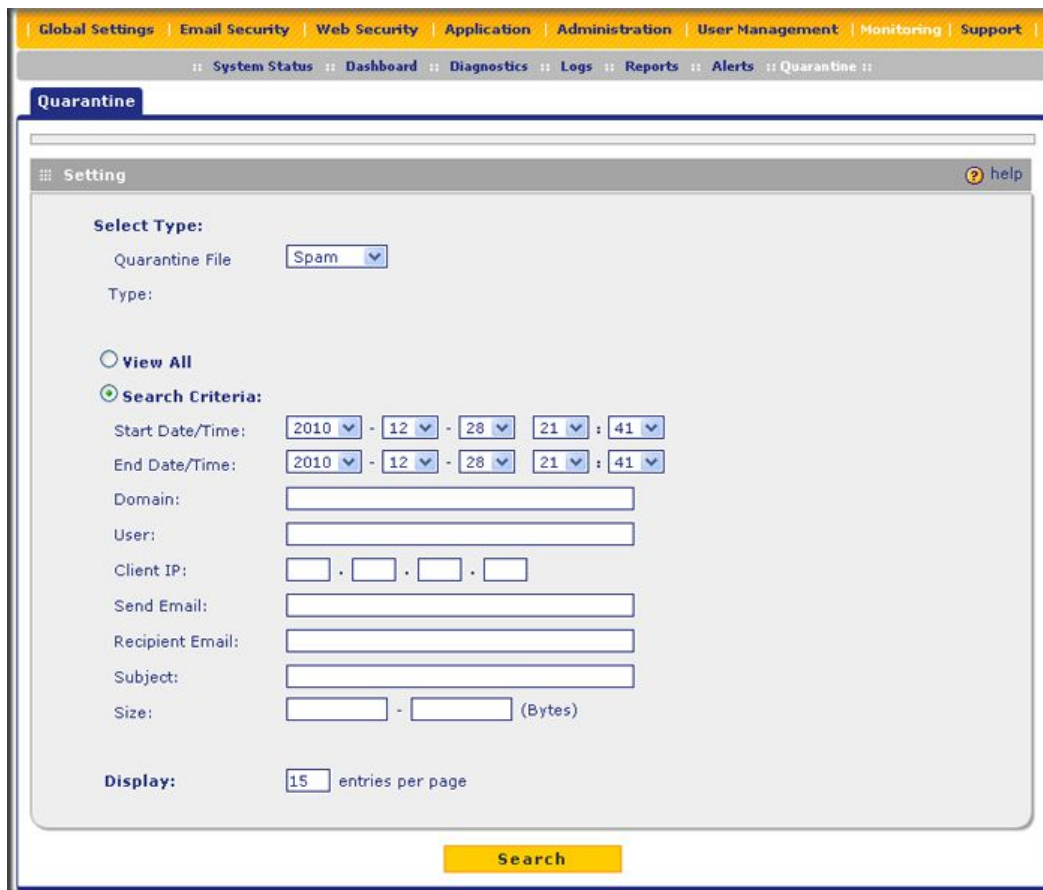

Figure 116.

3. Select the check boxes and radio buttons, make your selections from the drop-down lists, and complete the fields as explained in the following table:

Table 61. Quarantine File Settings

Setting	Description (or Subfield and Description)
File Type	Select one of the following file types from the drop-down list: <ul style="list-style-type: none"> • Spam. Quarantined spam that was detected through distributed spam analysis. • Malware. All quarantined spyware and viruses.
View All	Select one of the following radio buttons: <ul style="list-style-type: none"> • View All. Display or download the entire selected quarantine file.
Search Criteria	<ul style="list-style-type: none"> • Search Criteria. Query the selected quarantine file by configuring the search criteria that are available for the selected file.

Table 61. Quarantine File Settings (Continued)

Setting	Description (or Subfield and Description)	
Search Criteria (continued)	Start Date/Time	From the drop-down lists, select the year, month, day, hours, and minutes for the start date and time.
	End Date/Time	From the drop-down lists, select the year, month, day, hours, and minutes for the end date and time.
	Protocols	Select one or more check boxes to specify the protocols that are queried (malware quarantine file only).
	Domain	The domain name that is queried.
	User	The user name that is queried.
	Malware Name	The name of the spyware or virus that is queried (malware quarantine file only).
	Client IP	The client IP address that is queried (malware quarantine file only).
	Source IP	The source IP address that is queried (spam quarantine file only).
	Sender Email	The email address of the sender that is queried (spam quarantine file only).
	Recipient Email	The email address of the recipient that is queried.
	URL/Subject	The URL or subject that is queried (malware quarantine file only).
	Subject	The subject that is queried (spam quarantine file only).
	Size	The file's minimum and maximum size (in bytes) that are queried.
Display	The maximum number of entries that are displayed on a page. The default setting is 15 entries.	

4. Click **Search**. Depending on the selected quarantine file (spam or malware), the Quarantine screen displays the Quarantined Spam table or the Quarantined Infected Files table, which are explained in the following sections.

Viewing and Managing the Quarantined Spam Table

When you query the spam quarantine file, the Quarantine screen with the Quarantined Spam table displays:



Figure 117.

The Quarantined Spam table shows the following columns:

- **Check box.** Lets you select the table entry.
- **Date.** The date that the email was received.
- **Protocol.** The protocol (SMTP) in which the spam was found.
- **Domain.** The domain in which the spam was found.
- **User.** The user name that was used to log in to the STM.
- **Client IP.** The client IP address from which the spam originated.
- **From.** The email address of the sender.
- **To.** The email address of the recipient.
- **Subject.** The email subject line.
- **Size (Bytes).** The size of the email in bytes.

The following figure show the Quarantined Spam table with data. (Normally, this data does not fit on screen, and you need to scroll to see all data.)

<input type="checkbox"/>	Date	Protocol	Domain	User	Client IP	From	To	Subject	Size(Bytes)
<input type="checkbox"/>	2010-06-12 04:29:00	SMTP		anonymous	192.168.58.200	ztzhang@test.com	ztzhang@test.com, user@test.com	##### CTCH Evaluation Spam Test Match #####	1017
<input type="checkbox"/>	2010-06-12 04:28:30	SMTP		anonymous	192.168.58.200	ztzhang@test.com	ztzhang@test.com	##### CTCH Evaluation Spam Test Match #####	1145

Figure 118.

After you have selected one or more table entries, take one of the following actions (or click the **Return** link to return to the previous screen):

- **Send as Spam.** The selected spam email files are tagged as spam for distributed spam analysis, and are sent to the intended recipients.
- **Send as Ham.** The selected spam email files are not tagged as spam for distributed spam analysis, are removed from quarantine, and are sent to the intended recipients.

- **Delete.** The selected spam email files are removed from quarantine and deleted.

Viewing and Managing the Quarantined Infected Files Table

When you query the malware quarantine file, the Quarantine screen with the Quarantined Infected Files table displays:



Figure 119.

The Quarantined Infected Files table shows the following columns:

- **Check box.** Lets you select the table entry.
- **Date.** The date that the file was received.
- **Protocol.** The protocol (SMTP, POP3, IMAP, HTTP, FTP, HTTPS) in which the spyware or virus was found.
- **Domain.** The domain name that was used to log in to the STM.
- **User.** The user name that was used to log in to the STM.
- **Malware name.** The name of the spyware or virus.
- **File name.** The name of the file in which the spyware or virus was found.
- **Client IP.** The client IP address from which the spyware or virus originated.
- **Server IP.** The server IP address from which the spyware or virus originated.
- **From.** The email address of the sender.
- **To.** The email address of the recipient.
- **URL/Subject.** The URL or subject that is associated with the spyware or virus.
- **Size (Bytes).** The size of the virus or spyware file in bytes.

The following figure shows the Quarantined Infected Files table with data. (Normally, this data does not fit onscreen, and you need to scroll to see all data.)

<input type="checkbox"/>	Date	Protocol	Domain	User	Malware Name	Filename	Client IP	Server IP	From	To	URL/Subject	Size(Bytes)
<input type="checkbox"/>	2010-06-12 04:30:00	SMTP	prosecure	test_user	EICAR-Test-File	eicar.zip	192.168.58.200	192.168.35.165	test@test.com	user@test.com	Virus 3	70
<input type="checkbox"/>	2010-06-12 04:26:34	POP3		anonymous	EICAR-Test-File	eicar.病毒	192.168.58.200	192.168.35.165	ztzhang@test.com	ztzhang@test.com	virus 2	68
<input type="checkbox"/>	2010-06-12 04:26:00	SMTP		anonymous	EICAR-Test-File	eicar.病毒	192.168.58.200	192.168.35.165	ztzhang@test.com	ztzhang@test.com	virus 1	68

Figure 120.

After you have selected one or more table entries, take one of the following actions (or click the **Return** link to return to the previous screen):

- **Resend to Admin.** The selected malware files are removed from quarantine, zipped together as an email attachment, and then send to the recipient that you have specified on the Email Notification Server screen (see *Configuring the Email Notification Server* on page 176).
- **Delete.** The selected malware files are removed from quarantine and deleted.

User-Generated Spam Reports

Users logging in through the User Portal Login screen can select to receive a report with intercepted spam emails that were intended for their email address.

To send a spam report to an email address, a user should do the following:

1. On the User Portal Login screen (see *Figure 88* on page 156), click the **here** link in the Check your quarantined mail here section. The Send Spam Report screen displays. (The following figure shows the STM300).

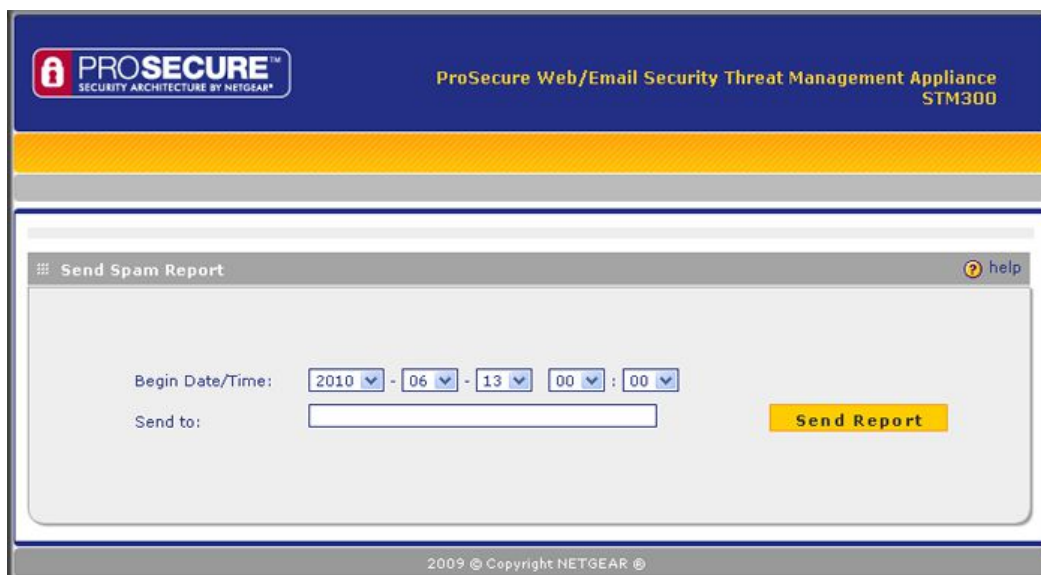

Figure 121.

2. Select the start date and time from the Begin Date/Time drop-down lists.
3. Specify the recipient's email address in the Send to field.

Note: The report includes only quarantined spam emails that contain the email address that is specified in the Send to field.

4. Click **Send Report**.

The report provides summary information such as time, sender, recipient, subject, and size, and a retrieve link. The user can retrieve an individual email by clicking the internal or external retrieve link for the email. The presence of an external retrieve links (see the red box in the following figure) depends on the setting of the Set Public Host/IP Address and Port check box on the Distributed Spam Analysis screen (see *Configuring Distributed Spam Analysis* on page 102).

Time	From	To	Subject	Size(Bytes)	Internal link	External link
2010-01-19 00:00:00	test@test.com	test2@test.com	Quarantine Spam Report 0	1	Retrieve it	Retrieve it
2010-01-19 00:00:15	test1@test.com	test2@test.com	Quarantine Spam Report 1	2	Retrieve it	Retrieve it
2010-01-19 00:00:30	test2@test.com	test2@test.com	Quarantine Spam Report 2	3	Retrieve it	Retrieve it

Figure 122.

Using Diagnostics Utilities

The STM provides diagnostic tools that help you analyze traffic conditions and the status of the network. Two sets of tools are available:

- **Network diagnostic tools.** These tools include a ping utility, traceroute utility, and DNS lookup utility.
- **Traffic diagnostic tools.** These tools allow you to perform real-time, per-protocol traffic analysis between specific source and destination addresses and let you generate reports on network usage in your network.

Note: For normal operation, diagnostic tools are not required.

To display the Diagnostics screen, select **Monitoring > Diagnostics** from the menu. To facilitate the explanation of the tools, the Diagnostics screen is divided and presented in this manual in three figures (the following figure, *Figure 125* on page 217, and *Figure 126* on page 218).

Using the Network Diagnostic Tools

This section discusses the Ping or Trace an IP Address section, the Perform a DNS Lookup section, and the Test URL section of the Diagnostics screen:

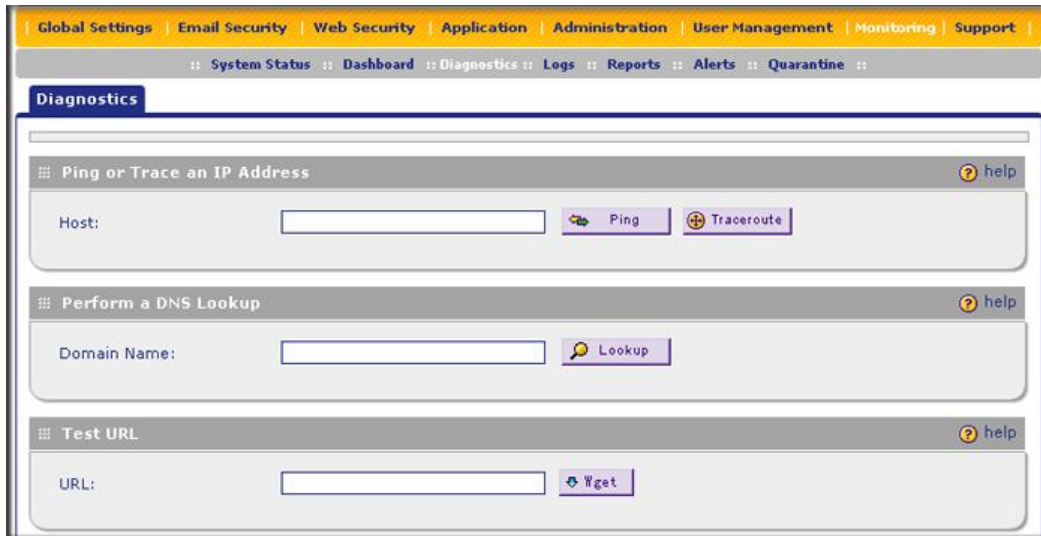

Figure 123. Diagnostics, screen 1 of 3

Sending a Ping Packet

Use the ping utility to send a ping packet request to check the connection between the STM and a specific IP address. If the request times out (no reply is received), it usually means that the destination is unreachable. However, some network devices can be configured not to respond to a ping. The ping results are displayed on a new screen; click **Back** on the Windows menu bar to return to the Diagnostics screen.

To send a ping:

1. Locate the Ping or Trace an IP Address section on the Diagnostics screen. In the Host field, enter the IP address or host name that you want to ping.
2. Click the **Ping** button. The results of the ping are displayed below the Host field.

Tracing a Route

A traceroute lists all routers between the source (the STM) and the destination IP address.

To send a traceroute:

1. Locate the Ping or Trace an IP Address section on the Diagnostics screen. In the Host field, enter the IP address or host name for which you want trace the route.
2. Click the **Traceroute** button. The results of the traceroute are displayed below the Host field.

Looking Up a DNS Address

A Domain Name Server (DNS) converts the Internet name (for example, www.netgear.com) to an IP address. If you need the IP address of a Web, FTP, mail, or other server on the Internet, request a DNS lookup to find the IP address.

To look up a DNS address:

1. Locate the Perform a DNS Lookup section on the Diagnostics screen. In the Domain Name field, enter a domain name.
2. Click the **Lookup** button. The results of the lookup action are displayed below the Domain Name field.

Testing a URL

Testing a URL allows you to verify that the STM can connect to the Internet. The test performs a DNS lookup and captures the HTTP page.

To test a URL:

1. Locate the Test URL section on the Diagnostics screen. In the URL field, enter a URL.
2. Click the **Wget** button. The results of the URL test are displayed below the URL field:

```
--11:26:35-- http://www.yahoo.com/
=> `index.html'
Resolving www.yahoo.com... 67.195.145.138, 72.30.2.43, 67.195.145.137
Connecting to www.yahoo.com[67.195.145.138]:80... connected.
HTTP request sent, awaiting response... 200 OK
Length: unspecified [text/html]
200 OK
```

Figure 124.

Using the Realtime Traffic Diagnostics Tool

This section discusses the Realtime Traffic Diagnostics section of the Diagnostics screen:

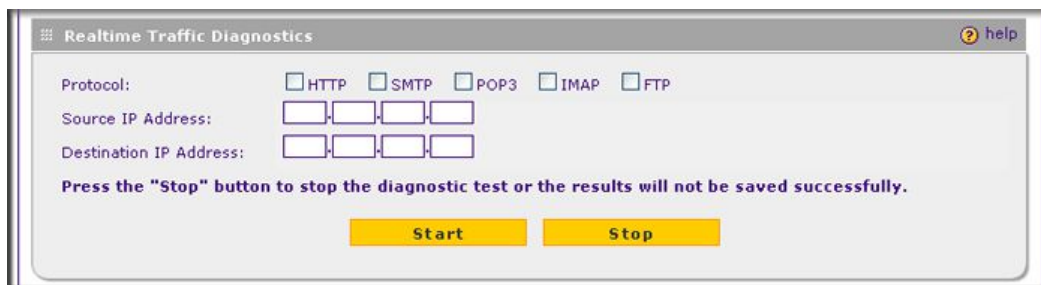

Figure 125. Diagnostics, screen 2 of 3

You can use the realtime traffic diagnostics tool to analyze traffic patterns with a network traffic analyzer tool. Depending on the network traffic analyzer tool that you use, you can find

out which applications are using most bandwidth, which users use most bandwidth, how long users are connected, and other information.

To use the realtime traffic diagnostics tool:

1. Locate the Realtime Traffic Diagnostics section on the Diagnostics screen. Select one or more check boxes to specify the protocols for which you want to capture the traffic flow. The check boxes that you can select are **HTTP**, **SMTP**, **POP3**, **IMAP**, and **FTP**.
2. In the Source IP Address field, enter the IP address of source of the traffic stream that you want to analyze.
3. In the Destination IP Address field, enter the IP address of the destination of the traffic stream that you want to analyze.
4. Click **Start**. You are prompted to save the downloaded traffic information file to your computer; however, do not save the file until you have stopped capturing the traffic flow.
5. When you want to stop capturing the traffic flow, click **Stop**.
6. Select a location to save the captured traffic flow. (The default file name is diagnostics.result.dat.) The file is downloaded to the location that you specify.
7. When the download is complete, browse to the download location you specified and verify that the file has been downloaded successfully.
8. Send the file to NETGEAR Technical Support for analysis.

Gathering Important Log Information and Generating a Network Statistics Report

When you request support, NETGEAR Technical Support might ask you to collect the debug logs and other information from your STM.

This section discusses the Gather Important Log Information section, Network Statistics Report section, and Reboot the System section of the Diagnostics screen:

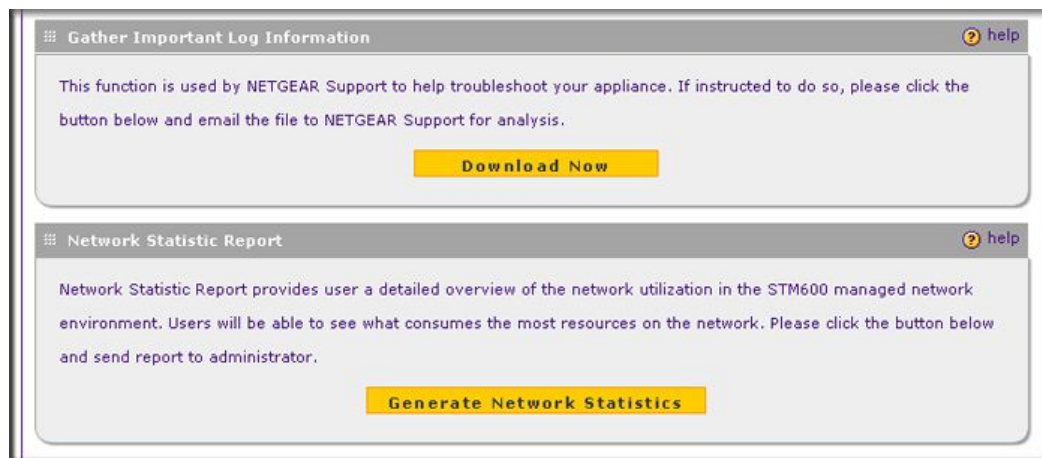

Figure 126. Diagnostics, screen 3 of 3

Gathering Important Log Information

To gather log information about your STM:

1. Locate the Gather Important Log Information section on the Diagnostics screen. Click **Download Now**. You are prompted to save the downloaded log information file to your computer. The default file name is importantlog.gpg.
2. When the download is complete, browse to the download location you specified and verify that the file has been downloaded successfully.

Generating Network Statistics

The network statistic report provides a detailed overview of the network utilization in the STM managed network environment. The report allows you to see what consumes the most resources on the network.

To generate the network statistic report:

Locate the Network Statistics Report section on the Diagnostics screen. Click **Generate Network Statistics**. The network statistic report is sent in an email to the recipient that you have configured on the email Notification Server screen (see [Configuring the Email Notification Server](#) on page 176).

Restarting and Shutting Down the STM

You can perform a remote restart, for example, when the STM seems to have become unstable or is not operating normally.

Note: Restarting breaks any existing connections either to the STM (such as your management session) or through the STM (for example, LAN users accessing the Internet). However, connections to the Internet are automatically reestablished when possible.

To restart the STM:

Locate the Restart & Shutdown section on the Diagnostics screen (this section is not shown on any of the Diagnostics screen figures in this manual). Click the **Restart** button. The STM restarts. (If you can see the unit: The reboot process is complete when the Test LED on the front panel goes off.)

Note: See also [Updating the Software](#) on page 71.

Note: For the STM150 only, there is an alternate way to restart: Press the **Power** button on the rear panel of the STM150 (see *Rear Panel STM150* on page 20). The front panel Test LED flashes, and the STM150 reboots.

To shut down the STM:

Locate the Restart & Shutdown section on the Diagnostics screen (this section is not shown on any of the Diagnostics screen figures in this manual). Click the **Shutdown** button. The STM shuts down.



WARNING!

You can shut down the STM using the Web Management Interface, but you cannot start up the STM using the Web Management Interface.

Troubleshooting and Using Online Support

7

This chapter provides troubleshooting tips and information for the STM. After each problem description, instructions are provided to help you diagnose and solve the problem. For the common problems listed, go to the section indicated.

- Is the STM on?
Go to *Basic Functioning* on page 223.
- Have I connected the STM correctly?
Go to *Basic Functioning* on page 223.
- I cannot access the STM's Web Management Interface.
Go to *Troubleshooting the Web Management Interface* on page 224.
- A time-out occurs.
Go to *When You Enter a URL or IP Address a Time-Out Error Occurs* on page 225.
- I have problems with the LAN connection.
Go to *Troubleshooting a TCP/IP Network Using a Ping Utility* on page 225.
- I want to clear the configuration and start over again.
Go to *Restoring the Default Configuration and Password* on page 227.
- The date or time is not correct.
Go to *Problems with Date and Time* on page 228.
- I need help from NETGEAR.
Go to *Using Online Support* on page 228.

Note: The STM's diagnostic tools are explained in *Using Diagnostics Utilities* on page 215.

Basic Functioning

After you turn on power to the STM, check that the following sequence of events occurs:

1. When power is first applied, verify that the Power LED is on.
2. After approximately 2 minutes, verify that:
 - a. The Test LED (STM150) or Status LED (STM300 and STM600) is no longer lit.
 - b. The left LAN port LEDs are lit for any local ports that are connected.
 - c. The left WAN port LEDs are lit for any WAN ports that are connected.

If a port's left LED is lit, a link has been established to the connected device. If a port is connected, verify the following right LED behavior in relation to the established port speed:

- Connected to a 1000-Mbps device:
 - STM150: The right LED is green.
 - STM300: The right LED is amber.
 - STM600: The right LED is amber.
- Connected to a 100-Mbps device:
 - STM150: The right LED is amber.
 - STM300: The right LED is green.
 - STM600: The right LED is green.
- Connected to a 10-Mbps device: For all STM models, the right LED is off.

If any of these conditions does not occur, see the appropriate following section.

Power LED Not On

If the Power and other LEDs are off when your STM is turned on, make sure that the power cord is correctly connected to your STM and that the power supply adapter is correctly connected to a functioning power outlet. If the error persists, you have a hardware problem and should contact NETGEAR Technical Support.

Test LED or Status LED Never Turns Off

When the STM is powered on, the Test LED (STM150) or Status LED (STM300 and STM600) turns on for approximately 2 minutes and then turns off when the STM has completed its initialization. If the Test LED (STM150) or Status LED (STM300 and STM600) remains on, there is a fault within the STM.

If all LEDs are still on more than several minutes after power-up, do the following:

- Turn the power off, and then turn it on again to see if the STM recovers.
- Clear the STM's configuration to factory defaults. Doing so sets the STM's IP address to **192.168.1.201**. This procedure is explained in *Restoring the Default Configuration and Password* on page 227.

If the error persists, you might have a hardware problem and should contact NETGEAR Technical Support.

LAN or WAN Port LEDs Not On

If either the LAN LEDs or WAN LEDs do not light when the Ethernet connection is made, check the following:

- Make sure that the Ethernet cable connections are secure at the STM and at the hub, router, or workstation.
- Make sure that power is turned on to the connected hub, router, or workstation.
- Be sure you that are using the correct cables:

When connecting the STM's uplink (WAN) ports to one or two devices that provide the Internet connections, use the cables that are supplied with the devices. These cables could be a standard straight-through Ethernet cables or an Ethernet crossover cables.

Troubleshooting the Web Management Interface

If you are unable to access the STM's Web Management Interface from a PC on your local network, check the following:

- Check the Ethernet connection between the PC and the STM as described in the previous section (*LAN or WAN Port LEDs Not On*).
- If your STM's IP address has been changed and you do not know the current IP address, clear the STM's configuration to factory defaults. This sets the STM's IP address to **192.168.1.201**. This procedure is explained in *Restoring the Default Configuration and Password* on page 227.

Tip: If you do not want to revert to the factory default settings and lose your configuration settings, you can restart the STM and use a sniffer to capture packets sent during the reboot. Look at the ARP packets to locate the STM's LAN interface address.

- Make sure that you are using the SSL <https://address> login rather than the <http://address> login.

- Make sure that your browser has Java, JavaScript, or ActiveX enabled. If you are using Internet Explorer, click **Refresh** to be sure that the Java applet is loaded.
- Try quitting the browser and launching it again.
- Make sure that you are using the correct login information. The factory default login name is admin and the password is password. Make sure that Caps Lock is off when entering this information.

If the STM does not save changes you have made in the Web Management Interface, check the following:

- When entering configuration settings, be sure to click the **Apply** button before moving to another screen, or your changes are lost.
- Click the **Refresh** or **Reload** button in the Web browser. The changes might have occurred, but the Web browser might be caching the old configuration.

When You Enter a URL or IP Address a Time-Out Error Occurs

A number of things could be causing this situation; try the following troubleshooting steps:

- Check whether other computers on the LAN work correctly. If they do, ensure that your computer's TCP/IP settings are correct.
- If the computer is configured correctly but still not working, ensure that the STM is connected and turned on. Connect to the Web Management Interface and check the STM's settings. If you cannot connect to the STM, see the information in the previous section (*Troubleshooting the Web Management Interface* on page 224).
- If the STM is configured correctly, check your Internet connection (for example, your modem or router) to make sure that it is working correctly.

Troubleshooting a TCP/IP Network Using a Ping Utility

Most TCP/IP terminal devices and firewalls contain a ping utility that sends an echo request packet to the designated device. The device then responds with an echo reply. Troubleshooting a TCP/IP network is made very easy by using the ping utility in your PC or workstation.

Testing the LAN Path to Your STM

You can ping the STM from your PC to verify that the LAN path to the STM is set up correctly.

To ping the STM from a PC running Windows 95 or later:

1. From the Windows toolbar, click **Start** and select **Run**.
2. In the field provided, type `ping` followed by the IP address of the STM; for example:

```
ping 192.168.1.201
```

3. Click **OK**. A message, similar to the following, should display:

```
Pinging <IP address> with 32 bytes of data
```

If the path is working, you will see this message:

```
Reply from <IP address>: bytes=32 time=NN ms TTL=xxx
```

If the path is not working, you will see this message:

```
Request timed out
```

If the path is not functioning correctly, you could have one of the following problems:

- Wrong physical connections
 - Make sure that the LAN port LED is on. If the LED is off, follow the instructions in [LAN or WAN Port LEDs Not On](#) on page 224.
 - Check that the corresponding Link LEDs are on for your network interface card and for the hub ports (if any) that are connected to your workstation and STM.
- Wrong network configuration
 - Verify that the Ethernet card driver software and TCP/IP software are both installed and configured on your PC or workstation.
 - Verify that the IP address for your STM and your workstation are correct and that the addresses are on the same subnet.

Testing the Path from Your PC to a Remote Device

After verifying that the LAN path works correctly, test the path from your PC to a remote device. From the Windows Run dialog box, type:

```
ping -n 10 <IP address>
```

in which `<IP address>` is the IP address of a remote device such as your ISP's DNS server.

If the path is functioning correctly, replies as in the previous section are displayed. If you do not receive replies:

- Check that your PC has the IP address of your STM listed as the default gateway. If the IP configuration of your PC is assigned by DHCP, this information is not visible in your PC's Network Control Panel.

- Check to see that the network address of your PC (the portion of the IP address that is specified by the netmask) is different from the network address of the remote device.
- Check that the modem or router is connected and functioning.

Restoring the Default Configuration and Password

To reset the STM to its original factory default settings:

1. Select **Administration > Backup and Restore Settings** from the menu. The Backup and Restore Settings screen displays.

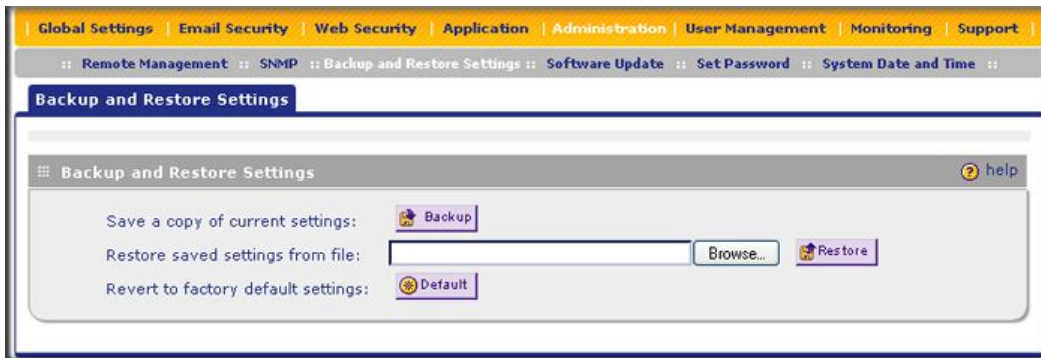

Figure 127.

2. Next to Revert to factory default settings, click the **Default** button.

The STM restarts. During the reboot process, the Backup & Restore Settings screen remains visible. The reboot process is complete after several minutes when the Test LED (STM150) or Status LED (STM300 and STM600) on the front panel goes off.



WARNING!

When you restore the factory default settings, the STM settings are erased. All scan and antispam settings are lost. Back up your settings if you intend to use them.

Note: After rebooting with factory default settings, the STM administrator account password is password, the guest account password is guest, and the LAN IP address is **192.168.1.201**.

Note: For the STM150 only, there is an alternate way to return the settings to factory default: Using a sharp object, press and hold the **Reset** button on the rear panel of the STM150 (see *Rear Panel STM150* on page 20) for about 10 seconds until the front panel Test LED flashes and the STM150 returns to factory default settings.

Problems with Date and Time

The System Date and Time screen displays the current date and time of day (see *Configuring Date and Time Service* on page 74). The STM uses the Network Time Protocol (NTP) to obtain the current time from one of several Network Time Servers on the Internet. Each entry in the log is stamped with the date and time of day. Problems with the date and time function can include:

- Date shown is January 1, 2000. Cause: The STM has not yet successfully reached a Network Time Server. Check that your Internet access settings are configured correctly. If you have just completed configuring the STM, wait at least 5 minutes and check the date and time again.
- Time is off by one hour. Cause: The STM does not automatically sense daylight savings time. Go to the System Date & Time screen (**Administration > System Date & Time**), and select or clear the check box marked **Automatically Adjust for Daylight Savings Time**.

Using Online Support

The STM includes online support tools that allow NETGEAR Technical Support to securely perform diagnostics of the STM, and that let you submit suspicious files for analysis by NETGEAR. You can also access the Knowledge Base and documentation online.

Enabling Remote Troubleshooting

One of the advanced features that the STM provides is online support through a support tunnel. With this feature, NETGEAR Technical Support staff is able to analyze from a remote location any difficulty you might be experiencing with the STM and to perform advanced diagnostics. Make sure that ports 443 and 2222 are open on your firewall, and that you have the support key that was given to you by NETGEAR.

To initiate the support tunnel:

1. Select **Support > Online Support** from the menu. The Online Support screen displays:

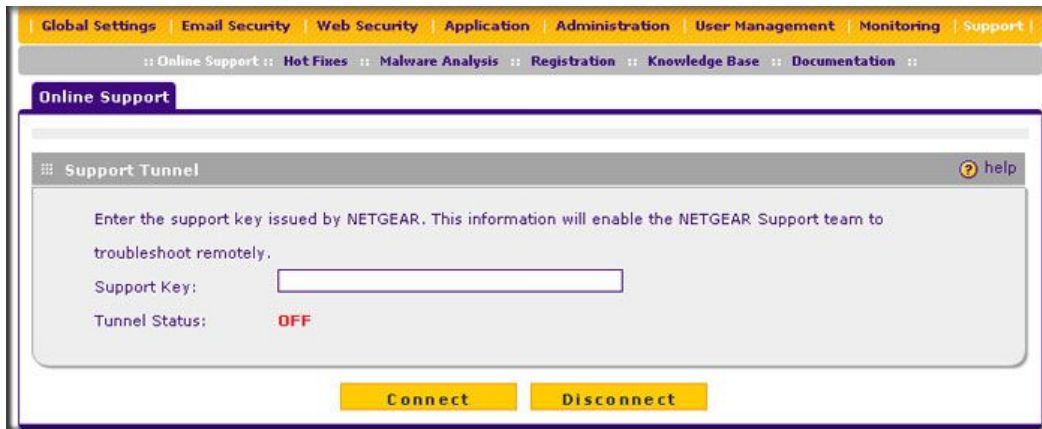

Figure 128.

2. In the Support Key field, enter the support key that was given to you by NETGEAR.
3. Click **Connect**. When the tunnel is established, the tunnel status field displays ON.

To terminate the tunnel, click **Disconnect**. The Tunnel Status field displays OFF.

If NETGEAR Technical Support cannot access the STM remotely, they might ask you to save a log file to your computer and then email it to NETGEAR for analysis (see [Gathering Important Log Information and Generating a Network Statistics Report](#) on page 218).

Installing Hot Fixes

NETGEAR might release hot fixes or patches if certain problems are found in any software release. When a hot fix is available, install it immediately to ensure optimum performance of the STM. Hot fixes might be released through NETGEAR resellers or might be available on the NETGEAR ProSecure website at <http://prosecure.netgear.com>.

To display information about installed hot fixes, select **Support > Hot Fixes** from the menu. The Hot Fixes screen displays:

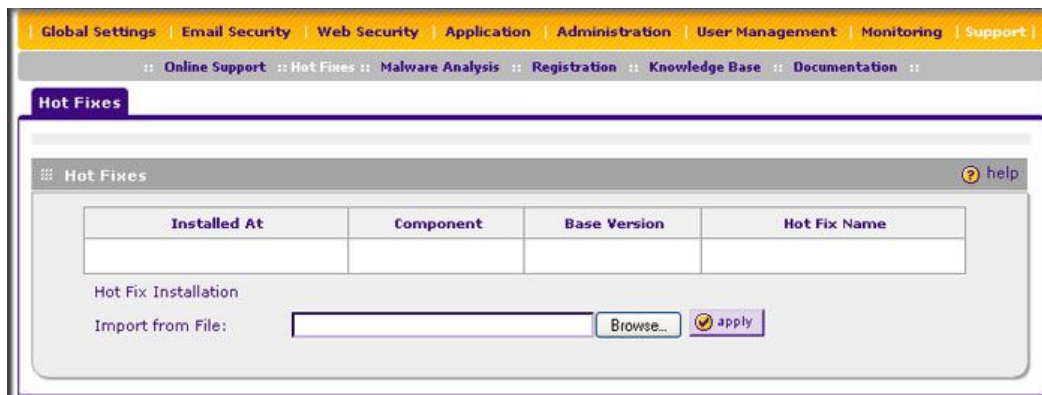

Figure 129.

The Hot Fixes table displays the installed hot fixes with the following fields:

- **Installed At.** The date and time when the hot fix was installed on the STM.
- **Component.** The component for which the hot fix provides a patch.
- **Base Version.** The base software version for the hot fix. The hot fix cannot be installed on an earlier or later software version, but only on the software version for which it is intended.
- **Hot Fix Name.** The name of the hot fix.

To install a hot fix:

1. Obtain the hot fix from NETGEAR or its authorized reseller.
2. Save the hot fix file on the computer that you will use to access the STM.
3. Log in to the STM.
4. Select **Support > Hot Fixes** from the menu. The Hot Fixes screen displays (see the previous figure).
5. Next to the Import from File field, click **Browse**.
6. Navigate to the location on your computer where you have saved the hot fix file, and then select it.
7. Click **Open**. The hot fix file now appears in the Import from File field.
8. Click **Apply** to install the hot fix.

The Test LED (STM150) or Status LED (STM300 and STM600) blinks during the hot fix installation.

Sending Suspicious Files to NETGEAR for Analysis

You can report any undetected malware file or malicious email to NETGEAR for online for analysis. The file is compressed and password protected before it is sent.

To submit a file to NETGEAR for analysis:

1. Select **Support > Malware Analysis** from the menu. The Malware Analysis screen displays:

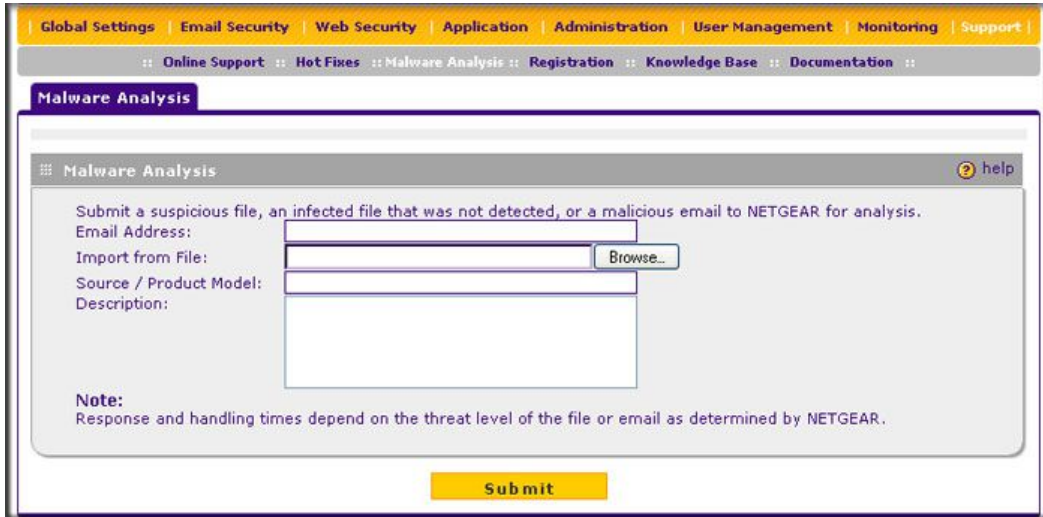

Figure 130.

2. Complete the fields as explained in the following table:

Table 62. Malware Analysis Settings

Setting	Description
Email Address	The email address of the submitter to enable NETGEAR to contact the submitter if needed.
Import from File	Click Browse to navigate to the file that you want to submit to NETGEAR.
Source / Product Model	Specify where the file originated (for example, an email address if received via email) and, if known, which product or scan feature (for example, the STM or a desktop antivirus application) detected the file.
Description	As an option, include a description or any information that is relevant.

3. Click **Submit**.

Accessing the Knowledge Base and Documentation

To access NETGEAR's Knowledge Base for the STM, select **Support > Knowledge Base** from the menu.

To access NETGEAR's documentation library for your STM model, select **Support > Documentation** from the menu.

Report Templates



The following table provides information about the preconfigured report templates. These report templates are accessible from the Reports screen (see *Viewing, Scheduling, and Generating Reports* on page 200).

In the Filtering Options columns of the following table, a ✓ indicates that the option is supported; an ✗ indicates that the option is not supported. Some reports require you to enable logging of HTTP traffic (for more information, see the Content Filtering screen and *Configuring Web Content Filtering* on page 109) so the report can provide HTTP traffic statistics. This requirement is indicated by a ✓ in the Enable logging of HTTP traffic column.

Note: “By hour” report templates show only the most recent 24 hours of statistics data if the selected time range is longer than one day; “By day” report templates show only the most recent 30 or 31 days of statistics data if the selected time range is longer than one month; “By month” report templates show only the most recent 12 months of statistics data if the selected time range is longer than one year.

Table 63. Report Templates Information

Activity	Information Reported	Filtering Options					Enable logging of HTTP traffic
		Client IP Address	User	Domain	Web Categories	Applications	
Web Activity							
Top Users by Requests	Top users by number of Web requests: <ul style="list-style-type: none"> • Chart with the number of Web requests per user • Table with the following items: <ul style="list-style-type: none"> - User identity - Number of Web requests - Bandwidth usage 	✓	✓	✓	✓	✗	✓
Top Users by Bandwidth	Top users by bandwidth usage: <ul style="list-style-type: none"> • Chart with the bandwidth usage per user • Table with the following items: <ul style="list-style-type: none"> - User identity - Bandwidth usage - Number associated of Web requests 	✓	✓	✓	✓	✗	✓

Table 63. Report Templates Information (Continued)

Activity	Information Reported	Filtering Options					Enable logging of HTTP traffic
		Client IP Address	User	Domain	Web Categories	Applications	
Top Destination Domains by Requests	Top destination domains by number of requests: • Chart with the requests by destination domains listed • Table with the following items: - Destination domain name - Number of requests - Associated bandwidth usage	✓	✓	✓	✓	✗	✓
Top Destination Domains by Bandwidth	Top destination domains by bandwidth usage: • Chart with the bandwidth usage by destination domains listed • Table with the following items: - Destination domain name - Bandwidth usage - Number of associated requests	✓	✓	✓	✓	✗	✓
Top Web Categories by Requests	Top Web categories by number of requests: • Chart with the number of requests by Web category listed • Table with the following items: - Web category - Number of requests - Associated bandwidth usage	✓	✓	✓	✓	✗	✓
Top Web Categories by Bandwidth	Top Web categories by bandwidth usage: • Chart with the bandwidth usage by Web category listed • Table with the following items: - Web category - Bandwidth usage - Number of associated requests	✓	✓	✓	✓	✗	✓
Top Blocked Users by Requests	Top blocked users by number of Web requests: • Chart with the number of Web requests per user • Table with the following items: - User identity - Number of Web requests	✓	✓	✓	✓	✗	✓
Top Blocked Destination Domains by Requests	Top blocked destination domains by number of requests: • Chart with the number of requests by destination domain listed • Table with the following items: - Destination domain name - Number of requests	✓	✓	✓	✓	✗	✓

Table 63. Report Templates Information (Continued)

Activity	Information Reported	Filtering Options					Enable logging of HTTP traffic
		Client IP Address	User	Domain	Web Categories	Applications	
Web Activity, Advanced (Click +More onscreen)							
Top Blocked Web Categories by Requests	Top blocked Web categories by number of requests: <ul style="list-style-type: none"> • Chart with the number of requests by Web categories listed • Table with the following items: <ul style="list-style-type: none"> - Web category - Number of blocked requests 	✓	✓	✓	✓	✗	✗
Top Blocked Users by Web Categories	Top blocked users by number of Web category requests: <ul style="list-style-type: none"> • Chart with the number of Web category requests per blocked user • Table with the following items: <ul style="list-style-type: none"> - User identity - Number of blocked Web category requests 	✓	✓	✓	✓	✗	✗
Top Blocked Users by Blacklist	Top users by number of blacklisted website requests: <ul style="list-style-type: none"> • Chart with the number of backlisted website requests per user • Table with the following items: <ul style="list-style-type: none"> - User identity - Number of backlisted website requests 	✓	✓	✓	✗	✗	✗
Top Blocked Users by File Type	Top users by number of blocked file extension requests: <ul style="list-style-type: none"> • Chart with the number of blocked file extension requests per user • Table with the following items: <ul style="list-style-type: none"> - User identity - Number of blocked file extension requests 	✓	✓	✓	✗	✗	✗
Top Blocked Users by Malware	Top users by number of blocked malware downloads: <ul style="list-style-type: none"> • Chart with the number of blocked malware downloads per user • Table with the following items: <ul style="list-style-type: none"> - User identity - Number of blocked malware downloads 	✓	✓	✓	✗	✗	✗
Requests by Hour	For each Web server protocol separately, the number of requests per hour for the time range that you specify in the Filtering Options section of the Reports screen: <ul style="list-style-type: none"> • Chart with the number of Web requests per hour • Table with the following items: <ul style="list-style-type: none"> - Hour - Number of Web requests per hour - Associated bandwidth usage per hour 	✓	✓	✓	✓	✗	✓

Table 63. Report Templates Information (Continued)

Activity	Information Reported	Filtering Options					Enable logging of HTTP traffic
		Client IP Address	User	Domain	Web Categories	Applications	
Requests by Day	For each Web server protocol separately, the number of requests per day for the time range that you specify in the Filtering Options section of the Reports screen: <ul style="list-style-type: none"> • Chart with the number of Web requests per day • Table with the following items: <ul style="list-style-type: none"> - Day - Number of Web requests per day - Associated bandwidth usage per day 	✓	✓	✓	✓	✗	✓
Requests by Month	For each Web server protocol separately, the number of requests per month for the time range that you specify in the Filtering Options section of the Reports screen: <ul style="list-style-type: none"> • Chart with the number of Web requests per month • Table with the following items: <ul style="list-style-type: none"> - Month - Number of Web requests per month - Associated bandwidth usage per month 	✓	✓	✓	✓	✗	✓
Bandwidth by Hour	For each Web server protocol separately, the bandwidth usage per hour for the time range that you specify in the Filtering Options section of the Reports screen: <ul style="list-style-type: none"> • Chart with the bandwidth usage per hour • Table with the following items: <ul style="list-style-type: none"> - Hour - Bandwidth usage per hour - Associated number of requests per hour 	✓	✓	✓	✓	✗	✓
Bandwidth by Day	For each Web server protocol separately, the bandwidth usage per day for the time range that you specify in the Filtering Options section of the Reports screen: <ul style="list-style-type: none"> • Chart with the bandwidth usage per day • Table with the following items: <ul style="list-style-type: none"> - Day - Bandwidth usage per day - Associated number of requests per day 	✓	✓	✓	✓	✗	✓
Bandwidth by Month	For each Web server protocol separately, the bandwidth usage per month for the time range that you specify in the Filtering Options section of the Reports screen: <ul style="list-style-type: none"> • Chart with the bandwidth usage per month • Table with the following items: <ul style="list-style-type: none"> - Month - Bandwidth usage per month - Associated number of requests per month 	✓	✓	✓	✓	✗	✓

Table 63. Report Templates Information (Continued)

Activity	Information Reported	Filtering Options					Enable logging of HTTP traffic
		Client IP Address	User	Domain	Web Categories	Applications	
Blocked Categories by Hour	<p>For HTTP and HTTPS separately, the number of blocked Web category requests per hour for the time range that you specify in the Filtering Options section of the Reports screen:</p> <ul style="list-style-type: none"> • Chart with the number of blocked Web category requests per hour • Table with the following items: <ul style="list-style-type: none"> - Hour - Number of blocked Web category requests per hour 	✓	✓	✓	✓	✗	✗
Blocked Categories by Day	<p>For HTTP and HTTPS separately, the number of blocked Web category requests per day for the time range that you specify in the Filtering Options section of the Reports screen:</p> <ul style="list-style-type: none"> • Chart with the number of blocked Web category requests per day • Table with the following items: <ul style="list-style-type: none"> - Day - Number of blocked Web category requests per day 	✓	✓	✓	✓	✗	✗
Blocked Categories by Month	<p>For HTTP and HTTPS separately, the number of blocked Web category requests per month for the time range that you specify in the Filtering Options section of the Reports screen:</p> <ul style="list-style-type: none"> • Chart with the number of blocked Web category requests per month • Table with the following items: <ul style="list-style-type: none"> - Month - Number of blocked Web category requests per month 	✓	✓	✓	✓	✗	✗
Blocked Files by Hour	<p>For each Web server protocol separately, the number of blocked file extension requests per hour for the time range that you specify in the Filtering Options section of the Reports screen:</p> <ul style="list-style-type: none"> • Chart with the number of blocked file extension requests per hour • Table with the following items: <ul style="list-style-type: none"> - Hour - Number of blocked file extension requests per hour 	✓	✓	✓	✗	✗	✗
Blocked Files by Day	<p>For each Web server protocol separately, the number of blocked file extension requests per day for the time range that you specify in the Filtering Options section of the Reports screen:</p> <ul style="list-style-type: none"> • Chart with the number of blocked file extension requests per day • Table with the following items: <ul style="list-style-type: none"> - Day - Number of blocked file extension requests per day 	✓	✓	✓	✗	✗	✗

Table 63. Report Templates Information (Continued)

Activity	Information Reported	Filtering Options					Enable logging of HTTP traffic
		Client IP Address	User	Domain	Web Categories	Applications	
Blocked Files By Month	<p>For each Web server protocol separately, the number of blocked file extension requests per month for the time range that you specify in the Filtering Options section of the Reports screen:</p> <ul style="list-style-type: none"> • Chart with the number of blocked file extension requests per month • Table with the following items: <ul style="list-style-type: none"> - Month - Number of blocked file extension requests per month 	✓	✓	✓	✗	✗	✗
Top Infected Malwares	<p>Top malware by number of detected infections or infection attempts received over Web requests:</p> <ul style="list-style-type: none"> • A chart with the number of detected infections or infection attempts per malware • Table with the following items: <ul style="list-style-type: none"> - Malware name - Number of detected infections or infection attempts 	✓	✓	✓	✗	✗	✗
Top Infected Clients	<p>Top client IP addresses by number of detected malware infections or infection attempts received over Web requests:</p> <ul style="list-style-type: none"> • Chart with the number of detected malware infections or infection attempts per client IP address • Table with the following items: <ul style="list-style-type: none"> - Client IP address - Number of detected malware infections or infection attempts 	✓	✓	✓	✗	✗	✗
Infected Malwares by Hour	<p>For each Web server protocol separately, the number of detected malware infections or infection attempts per hour for the time range that you specify in the Filtering Options section of the Reports screen:</p> <ul style="list-style-type: none"> • Chart with the number of detected malware infections or infection attempts per hour • Table with the following items: <ul style="list-style-type: none"> - Hour - Number of detected malware infections or infection attempts per hour 	✓	✓	✓	✗	✗	✗
Infected Malwares by Day	<p>For each Web server protocol separately, the number of detected malware infections or infection attempts per day for the time range that you specify in the Filtering Options section of the Reports screen:</p> <ul style="list-style-type: none"> • Chart with the number of detected malware infections or infection attempts per day • Table with the following items: <ul style="list-style-type: none"> - Day - Number of detected malware infections or infection attempts per day 	✓	✓	✓	✗	✗	✗

Table 63. Report Templates Information (Continued)

Activity	Information Reported	Filtering Options					Enable logging of HTTP traffic
		Client IP Address	User	Domain	Web Categories	Applications	
Infected Malwares by Month	For each Web server protocol separately, the number of detected malware infections or infection attempts per month for the time range that you specify in the Filtering Options section of the Reports screen: <ul style="list-style-type: none"> • Chart with the number of detected malware infections or infection attempts per month • Table with the following items: <ul style="list-style-type: none"> - Month - Number of detected malware infections or infection attempts per month 	✓	✓	✓	✗	✗	✗
User Activity	Top users by number of blocked and allowed Web requests: <ul style="list-style-type: none"> • Chart with the number of blocked and allowed Web requests per user • Table with the following items: <ul style="list-style-type: none"> - User identity - Last time that the user was detected ("Last seen") - Total number of Web requests - Number of allowed Web requests - Number of blocked Web requests - Associated bandwidth usage 	✓	✓	✓	✓	✗	✓
Email Activity							
Top Spam Senders by Requests	For the blacklist and real-time blacklist combined and for the distributed spam analysis separately, the top spam senders by number of detected spam messages: <ul style="list-style-type: none"> • Chart with the number of detected spam messages per sender • Table with the following items: <ul style="list-style-type: none"> - Sender's email address - Number of detected spam messages 	✓	✓	✗	✗	✗	✗
Top Spam Recipients by Requests	For the blacklist and real-time blacklist combined and for the distributed spam analysis separately, the top spam recipients by number of detected spam messages: <ul style="list-style-type: none"> • Chart with the number of detected spam messages per recipient • Table with the following items: <ul style="list-style-type: none"> - Recipient's email address - Number of detected spam messages 	✓	✓	✗	✗	✗	✗

Table 63. Report Templates Information (Continued)

Activity	Information Reported	Filtering Options					Enable logging of HTTP traffic
		Client IP Address	User	Domain	Web Categories	Applications	
Email Activity, Advanced (Click +More onscreen)							
Spam by Hour	<p>For SMTP and POP3 separately, the number of detected spam messages per hour for the time range that you specify in the Filtering Options section of the Reports screen:</p> <ul style="list-style-type: none"> • Chart with the number of detected spam messages per hour • Table with the following items: <ul style="list-style-type: none"> - Hour - Number of detected spam messages per hour <p>Note: For SMTP, the blacklist and real-time blacklist information is presented combined; for POP3, only blacklist information is presented; for both SMTP and POP3, the distributed spam analysis information is presented separately.</p>	✓	✓	✗	✗	✗	✗
Spam by Day	<p>For SMTP and POP3 separately, the number of detected spam messages per day for the time range that you specify in the Filtering Options section of the Reports screen:</p> <ul style="list-style-type: none"> • Chart with the number of detected spam messages per day • Table with the following items: <ul style="list-style-type: none"> - Day - Number of detected spam messages per day <p>Note: For SMTP, the blacklist and real-time blacklist information is presented combined; for POP3, only blacklist information is presented; for both SMTP and POP3, the distributed spam analysis information is presented separately.</p>	✓	✓	✗	✗	✗	✗
Spam by Month	<p>For SMTP and POP3 separately, the number of detected spam messages per month for the time range that you specify in the Filtering Options section of the Reports screen:</p> <ul style="list-style-type: none"> • Chart with the number of detected spam messages per month • Table with the following items: <ul style="list-style-type: none"> - Month - Number of detected spam messages per month <p>Note: For SMTP, the blacklist and real-time blacklist information is presented combined; for POP3, only blacklist information is presented; for both SMTP and POP3, the distributed spam analysis information is presented separately.</p>	✓	✓	✗	✗	✗	✗

Table 63. Report Templates Information (Continued)

Activity	Information Reported	Filtering Options					Enable logging of HTTP traffic
		Client IP Address	User	Domain	Web Categories	Applications	
Email Messages by Hour	For each email server protocol separately, the number of email messages per hour for the time range that you specify in the Filtering Options section of the Reports screen: <ul style="list-style-type: none"> • Chart with the number of email messages per hour • Table with the following items: <ul style="list-style-type: none"> - Hour - Number of email messages per hour - Associated bandwidth usage per hour 	✓	✓	✗	✗	✗	✗
Email Messages by Day	For each email server protocol separately, the number of email messages per day for the time range that you specify in the Filtering Options section of the Reports screen: <ul style="list-style-type: none"> • Chart with the number of email messages per day • Table with the following items: <ul style="list-style-type: none"> - Day - Number of email messages per day - Associated bandwidth usage per day 	✓	✓	✗	✗	✗	✗
Email Messages by Month	For each email server protocol separately, the number of email messages per month for the time range that you specify in the Filtering Options section of the Reports screen: <ul style="list-style-type: none"> • Chart with the number of email messages per month • Table with the following items: <ul style="list-style-type: none"> - Month - Number of email messages per month - Associated bandwidth usage per month 	✓	✓	✗	✗	✗	✗
Filtered Emails by Hour	For each email server protocol separately, the number of filtered email messages per hour for the time range that you specify in the Filtering Options section of the Reports screen: <ul style="list-style-type: none"> • Chart with the number of filtered email messages per hour • Table with the following items: <ul style="list-style-type: none"> - Hour - Number of filtered email messages per hour 	✓	✓	✗	✗	✗	✗
Filtered Emails by Day	For each email server protocol separately, the number of filtered email messages per day for the time range that you specify in the Filtering Options section of the Reports screen: <ul style="list-style-type: none"> • Chart with the number of filtered email messages per day • Table with the following items: <ul style="list-style-type: none"> - Day - Number of filtered email messages per day 	✓	✓	✗	✗	✗	✗

Table 63. Report Templates Information (Continued)

Activity	Information Reported	Filtering Options					Enable logging of HTTP traffic
		Client IP Address	User	Domain	Web Categories	Applications	
Filtered Emails by Month	<p>For each email server protocol separately, the number of filtered email messages per month for the time range that you specify in the Filtering Options section of the Reports screen:</p> <ul style="list-style-type: none"> • Chart with the number of filtered email messages per month • Table with the following items: <ul style="list-style-type: none"> - Month - Number of filtered email messages per month 	✓	✓	✗	✗	✗	✗
Top Infected Malwares	<p>Top virus or spyware by number of detected infections or infection attempts received over email messages:</p> <ul style="list-style-type: none"> • A chart with the number of detected infections or infection attempts per malware • Table with the following items: <ul style="list-style-type: none"> - Virus or spyware name - Number of detected infections or infection attempts 	✓	✓	✗	✗	✗	✗
Top Infected Clients	<p>Top client IP addresses by number of detected virus or spyware infections or infection attempts received over email messages:</p> <ul style="list-style-type: none"> • Chart with the number of detected virus or spyware infections or infection attempts per client IP address • Table with the following items: <ul style="list-style-type: none"> - Client IP address - Number of detected virus or spyware infections or infection attempts 	✓	✓	✗	✗	✗	✗
Infected Malwares by Hour	<p>For each email server protocol separately, the number of detected virus or spyware infections or infection attempts per hour for the time range that you specify in the Filtering Options section of the Reports screen:</p> <ul style="list-style-type: none"> • Chart with the number of detected virus or spyware infections or infection attempts per hour • Table with the following items: <ul style="list-style-type: none"> - Hour - Number of detected virus or spyware infections or infection attempts per hour 	✓	✓	✗	✗	✗	✗

Table 63. Report Templates Information (Continued)

Activity	Information Reported	Filtering Options					Enable logging of HTTP traffic
		Client IP Address	User	Domain	Web Categories	Applications	
Infected Malwares by Day	For each email server protocol separately, the number of detected virus or spyware infections or infection attempts per day for the time range that you specify in the Filtering Options section of the Reports screen: <ul style="list-style-type: none"> • Chart with the number of detected virus or spyware infections or infection attempts per day • Table with the following items: <ul style="list-style-type: none"> - Day - Number of detected virus or spyware infections or infection attempts per day 	✓	✓	✗	✗	✗	✗
Infected Malwares by Month	For each email server protocol separately, the number of detected virus or spyware infections or infection attempts per month for the time range that you specify in the Filtering Options section of the Reports screen: <ul style="list-style-type: none"> • Chart with the number of detected virus or spyware infections or infection attempts per month • Table with the following items: <ul style="list-style-type: none"> - Month - Number of detected virus or spyware infections or infection attempts per month 	✓	✓	✗	✗	✗	✗
Application Activity							
Top Blocked Users by Requests	Top users by number of blocked application requests: <ul style="list-style-type: none"> • Chart with the number of blocked application requests per user • Table with the following items: <ul style="list-style-type: none"> - User identity - Number of blocked applications 	✓	✓	✗	✗	✓	✗
Top Blocked Applications by Requests	Top blocked applications by number of requests: <ul style="list-style-type: none"> • Chart with the number of requests per blocked application • Table with the following items: <ul style="list-style-type: none"> - Application name - Number of blocked requests 	✓	✓	✗	✗	✓	✗
Application Activity, Advanced (Click +More onscreen)							
Top Blocked Clients by Requests	Top clients IP addresses by number of blocked applications: <ul style="list-style-type: none"> • Chart with the number of blocked applications per client IP address • Table with the following items: <ul style="list-style-type: none"> - Client IP address - Number of blocked applications 	✓	✓	✗	✗	✓	✗

Table 63. Report Templates Information (Continued)

Activity	Information Reported	Filtering Options					Enable logging of HTTP traffic
		Client IP Address	User	Domain	Web Categories	Applications	
Blocked Applications by Hour	The number of blocked applications per hour for the time range that you specify in the Filtering Options section of the Reports screen: <ul style="list-style-type: none"> • Chart with the number of blocked applications per hour • Table with the following items: <ul style="list-style-type: none"> - Hour - Number of blocked applications per hour 	✓	✓	✗	✗	✓	✗
Blocked Applications by Day	The number of blocked applications per day for the time range that you specify in the Filtering Options section of the Reports screen: <ul style="list-style-type: none"> • Chart with the number of blocked applications per day • Table with the following items: <ul style="list-style-type: none"> - Day - Number of blocked applications per day 	✓	✓	✗	✗	✓	✗
Blocked Applications by Month	The number of blocked applications per month for the time range that you specify in the Filtering Options section of the Reports screen: <ul style="list-style-type: none"> • Chart with the number of blocked applications per month • Table with the following items: <ul style="list-style-type: none"> - Month - Number of blocked applications per month 	✓	✓	✗	✗	✓	✗
System Information							
CPU & Memory Usage	CPU and memory usage, presented separately: <ul style="list-style-type: none"> • Chart with the CPU usage and the memory usage <p>Note: There is no table for this information.</p>	✗	✗	✗	✗	✗	✗

B Default Settings and Technical Specifications



To return the STM to the default factory configuration settings that are shown in the following table, click the **Default** button on the Backup and Restore Settings screen (see [Reverting to Factory Default Settings](#) on page 70).

Table 64. STM Default Configuration Settings

Feature	Default
Login	
User Login URL	https://192.168.1.201
Admin User Name (case-sensitive)	admin
Admin Login Password (case-sensitive)	password
Guest User Name (case-sensitive)	guest
Guest Login Password (case-sensitive)	guest
Management	
System Configuration	Web-based configuration and status monitoring
Required Minimum Browser versions	<ul style="list-style-type: none">• Microsoft Internet Explorer 5.1 or later• Mozilla Firefox 1.x or later• Apple Safari 1.2 or later <p>Note: To enable a computer to scan secure HTTPS traffic, you need to import the root CA certificate into your browser from the STM login screen.</p>
Time Zone	GMT (Greenwich Mean Time)
Time Adjusted for Daylight Savings Time	Enabled
SNMP	Disabled
Administration Console Port	RS232

Table 64. STM Default Configuration Settings (Continued)

Feature	Default
LAN Connections	
MAC Address	Default address
MTU Size	1500
Ports	STM150: 5 AutoSense 10/100/1000BASE-T, RJ-45 STM300: 3 AutoSense 10/100/1000BASE-T, RJ-45 STM600: 5 AutoSense 10/100/1000BASE-T, RJ-45
LAN IP Address	In line transparent bridged
Subnet Mask	255.255.255.0

The following table shows the STM specifications.

Table 65. STM Specifications

Feature	Specification
Supported Protocols	
Data Protocols	HTTP, HTTPS, FTP, IMAP, POP3, SMTP
Power	
Worldwide	100–240V AC/50–60 Hz, universal input, 1.5A max.
Physical Specifications	
Dimensions (H x L x W)	STM150: 43.5 x 258 x 440 mm (1.7 x 10.2 x 17.3 in.) STM300: 44.4 x 500 x 426 mm (1.75 x 19.7 x 16.8 in.) STM600: 44.4 x 500 x 426 mm (1.75 x 19.7 x 16.8 in.)
Weight	STM150: 3.68 kg (8.1 lb.) STM300: 8.2 kg (18.1 lb.) STM600: 8.2 kg (18.1 lb.)
Form Factor	1U
Environmental Specifications	
Operating temperature	0° to 40° C (32° to 104° F)
Storage temperature	–20° to 70° C (–4° to 70° F)
Operating humidity	5–95% maximum relative humidity, noncondensing
Meets requirements of	RoHS

Table 65. STM Specifications (Continued)

Feature		Specification
Electromagnetic Emissions		
	Meets requirements of	FCC Part 15 Class A VCCI Class A CE mark, commercial
Safety		
	Meets requirements of	UL listed C-Tick

c. Related Documents



This appendix provides links to reference documents you can use to gain a more complete understanding of the technologies used in your NETGEAR product.

Document	Link
TCP/IP Networking Basics	http://documentation.netgear.com/reference/enu/tcpip/index.htm
Wireless Networking Basics	http://documentation.netgear.com/reference/enu/wireless/index.htm
Preparing Your Network	http://documentation.netgear.com/reference/enu/wsdhcp/index.htm
Virtual Private Networking Basics	http://documentation.netgear.com/reference/enu/vpn/index.htm
Glossary	http://documentation.netgear.com/reference/enu/glossary/index.htm

Notification of Compliance



NETGEAR Wired Products

Regulatory Compliance Information

This section includes user requirements for operating this product in accordance with National laws for usage of radio spectrum and operation of radio devices. Failure of the end-user to comply with the applicable requirements may result in unlawful operation and adverse action against the end-user by the applicable National regulatory authority.

This product's firmware limits operation to only the channels allowed in a particular Region or Country. Therefore, all options described in this user's guide may not be available in your version of the product.

FCC Requirements for Operation in the United States

FCC Information to User

This product does not contain any user serviceable components and is to be used with approved antennas only. Any product changes or modifications will invalidate all applicable regulatory certifications and approvals

This device complies with Part 15 of the FCC Rules. Operation is subject to the following two conditions: (1) This device may not cause harmful interference, and (2) this device must accept any interference received, including interference that may cause undesired operation.

FCC Guidelines for Human Exposure

This equipment complies with FCC radiation exposure limits set forth for an uncontrolled environment. This equipment should be installed and operated with minimum distance of 20 cm between the radiator and your body.

This transmitter must not be co-located or operating in conjunction with any other antenna or transmitter.

FCC Declaration Of Conformity

We, NETGEAR, Inc., 350 East Plumeria Drive, San Jose, CA 95134, declare under our sole responsibility that the ProSecure Web/Email Security Threat Management Appliance STM150, STM300, or STM600 complies with Part 15 of FCC Rules.

Operation is subject to the following two conditions:

- This device may not cause harmful interference, and
- This device must accept any interference received, including interference that may cause undesired operation.

FCC Radio Frequency Interference Warnings & Instructions

This equipment has been tested and found to comply with the limits for a Class B digital device, pursuant to Part 15 of the FCC Rules. These limits are designed to provide reasonable protection against harmful interference in a residential installation. This equipment uses and can radiate radio frequency energy and, if not installed and used in accordance with the instructions, may cause harmful interference to radio communications. However, there is no guarantee that interference will not occur in a particular installation.

If this equipment does cause harmful interference to radio or television reception, which can be determined by turning the equipment off and on, the user is encouraged to try to correct the interference by one or more of the following methods:

- Reorient or relocate the receiving antenna.
- Increase the separation between the equipment and the receiver.
- Connect the equipment into an electrical outlet on a circuit different from that which the radio receiver is connected.
- Consult the dealer or an experienced radio/TV technician for help.

Modifications made to the product, unless expressly approved by NETGEAR, Inc., could void the user's right to operate the equipment.

Canadian Department of Communications Radio Interference Regulations

This digital apparatus, ProSecure Web/Email Security Threat Management Appliance STM150, STM300, or STM600, does not exceed the Class B limits for radio-noise emissions from digital apparatus as set out in the Radio Interference Regulations of the Canadian Department of Communications.

European Union

The ProSecure Web/Email Security Threat Management Appliance STM150, STM300, or STM600 complies with essential requirements of EU EMC Directive 2004/108/EC and Low Voltage Directive 2006/95/EC as supported by applying the following test methods and standards:

- EN55022: 2006 / A1: 2007
- EN55024: 1998 / A1: 2001 / A2 : 2003
- EN60950-1: 2005 2nd Edition
- EN 61000-3-2:2006
- EN 61000-3-3:1995 w/A1: 2001+A2: 2005

For the EU Declaration of Conformity, please visit:

http://kb.netgear.com/app/answers/detail/a_id/11621/sno/0.

Additional Copyrights

<p>AES</p>	<p>Copyright (c) 2001, Dr. Brian Gladman, brg@gladman.uk.net, Worcester, UK. All rights reserved. TERMS Redistribution and use in source and binary forms, with or without modification, are permitted subject to the following conditions:</p> <ol style="list-style-type: none"> 1. Redistributions of source code must retain the above copyright notice, this list of conditions, and the following disclaimer. 2. Redistributions in binary form must reproduce the above copyright notice, this list of conditions, and the following disclaimer in the documentation and/or other materials provided with the distribution. 3. The copyright holder's name must not be used to endorse or promote any products derived from this software without his specific prior written permission. <p>This software is provided "as is" with no express or implied warranties of correctness or fitness for purpose.</p>
<p>Open SSL</p>	<p>Copyright (c) 1998–2000 The OpenSSL Project. All rights reserved. Redistribution and use in source and binary forms, with or without modification, are permitted provided that the following conditions are met:</p> <ol style="list-style-type: none"> 1. Redistributions of source code must retain the above copyright notice, this list of conditions, and the following disclaimer. 2. Redistributions in binary form must reproduce the above copyright notice, this list of conditions, and the following disclaimer in the documentation and/or other materials provided with the distribution. 3. All advertising materials mentioning features or use of this software must display the following acknowledgment: "This product includes software developed by the OpenSSL Project for use in the OpenSSL Toolkit (http://www.openssl.org/)." 4. The names "OpenSSL Toolkit" and "OpenSSL Project" must not be used to endorse or promote products derived from this software without prior written permission. For written permission, contact openssl-core@openssl.org. 5. Products derived from this software may not be called "OpenSSL" nor may "OpenSSL" appear in their names without prior written permission of the OpenSSL Project. 6. Redistributions of any form whatsoever must retain the following acknowledgment: "This product includes software developed by the OpenSSL Project for use in the OpenSSL Toolkit (http://www.openssl.org/)." <p>THIS SOFTWARE IS PROVIDED BY THE OpenSSL PROJECT "AS IS," AND ANY EXPRESSED OR IMPLIED WARRANTIES, INCLUDING, BUT NOT LIMITED TO, THE IMPLIED WARRANTIES OF MERCHANTABILITY AND FITNESS FOR A PARTICULAR PURPOSE ARE DISCLAIMED. IN NO EVENT SHALL THE OpenSSL PROJECT OR ITS CONTRIBUTORS BE LIABLE FOR ANY DIRECT, INDIRECT, INCIDENTAL, SPECIAL, EXEMPLARY, OR CONSEQUENTIAL DAMAGES (INCLUDING, BUT NOT LIMITED TO, PROCUREMENT OF SUBSTITUTE GOODS OR SERVICES; LOSS OF USE, DATA, OR PROFITS; OR BUSINESS INTERRUPTION) HOWEVER CAUSED AND ON ANY THEORY OF LIABILITY, WHETHER IN CONTRACT, STRICT LIABILITY, OR TORT (INCLUDING NEGLIGENCE OR OTHERWISE) ARISING IN ANY WAY OUT OF THE USE OF THIS SOFTWARE, EVEN IF ADVISED OF THE POSSIBILITY OF SUCH DAMAGE.</p> <p>This product includes cryptographic software written by Eric Young (eay@cryptsoft.com). This product includes software written by Tim Hudson (tjh@cryptsoft.com).</p>

MD5	<p>Copyright (C) 1990, RSA Data Security, Inc. All rights reserved.</p> <p>License to copy and use this software is granted provided that it is identified as the "RSA Data Security, Inc. MD5 Message-Digest Algorithm" in all material mentioning or referencing this software or this function. License is also granted to make and use derivative works provided that such works are identified as "derived from the RSA Data Security, Inc. MD5 Message-Digest Algorithm" in all material mentioning or referencing the derived work.</p> <p>RSA Data Security, Inc. makes no representations concerning either the merchantability of this software or the suitability of this software for any particular purpose. It is provided "as is" without express or implied warranty of any kind.</p> <p>These notices must be retained in any copies of any part of this documentation and/or software.</p>
PPP	<p>Copyright (c) 1989 Carnegie Mellon University. All rights reserved.</p> <p>Redistribution and use in source and binary forms are permitted provided that the above copyright notice and this paragraph are duplicated in all such forms and that any documentation, advertising materials, and other materials related to such distribution and use acknowledge that the software was developed by Carnegie Mellon University. The name of the University may not be used to endorse or promote products derived from this software without specific prior written permission.</p> <p>THIS SOFTWARE IS PROVIDED "AS IS" AND WITHOUT ANY EXPRESS OR IMPLIED WARRANTIES, INCLUDING, WITHOUT LIMITATION, THE IMPLIED WARRANTIES OF MERCHANTABILITY AND FITNESS FOR A PARTICULAR PURPOSE.</p>
Zlib	<p>zlib.h. Interface of the zlib general purpose compression library version 1.1.4, March 11th, 2002. Copyright (C) 1995–2002 Jean-loup Gailly and Mark Adler.</p> <p>This software is provided "as is," without any express or implied warranty. In no event will the authors be held liable for any damages arising from the use of this software. Permission is granted to anyone to use this software for any purpose, including commercial applications, and to alter it and redistribute it freely, subject to the following restrictions:</p> <ol style="list-style-type: none"> 1. The origin of this software must not be misrepresented; you must not claim that you wrote the original software. If you use this software in a product, an acknowledgment in the product documentation would be appreciated but is not required. 2. Altered source versions must be plainly marked as such, and must not be misrepresented as being the original software. 3. This notice may not be removed or altered from any source distribution. <p>Jean-loup Gailly: jloup@gzip.org; Mark Adler: madler@alumni.caltech.edu.</p> <p>The data format used by the zlib library is described by RFCs (Request for Comments) 1950 to 1952 in the files rfc1950.txt (zlib format), rfc1951.txt (deflate format), and rfc1952.txt (gzip format). For more information, see http://www.ietf.org/rfc/.</p>

Index

Numerics

10BaseT, 100BaseT, and 1000BaseT **55**

A

AC input

STM150 **20**

STM300 **21**

STM600 **21**

access

preventing inherited privileges **156**

read/write and read-only **61**

remote management **64**

rules for Web access **132**

action buttons (Web Management Interface) **31**

activating service licenses **12, 50**

Active Directory (AD)

domains **161**

how it works **158**

overview **157**

ActiveX objects **86**

address binding, permanent **57, 59**

administrator (admin)

overview **61**

receiving

alerts by email **182**

logs by email **178**

reports by email **204**

settings **63**

airflow **23**

alerts

email address for sending alerts **176**

specifying alerts to send via email **182**

Alexa Toolbar **86, 130**

allowing

emails **100**

URLs **118**

Web access exceptions **134**

Web categories **47, 114**

antispam settings, backing up **68**

antivirus

action if infected emails **38**

user notification settings **93**

application software, updating **71**

applications

activity reports **243**

control **127**

custom categories **143, 145**

logs **179, 180, 194, 196**

recent 5 and top 5 violations **188**

setting access exceptions **137**

status **187**

attached devices, monitoring with SNMP **65**

audio and video files

email filtering **97**

FTP filtering **127**

Web filtering **113, 137**

authenticated users **135**

authentication

methods **157**

using the DC agent **164**

Auto Uplink **11**

automatically updating software **72**

autosensing, speed **54, 55**

B

backing up settings **68**

binding MAC addresses **59**

BitTorrent **85, 130**

blacklist

emails **98**

URLs **118**

blocking

emails **100**

file extensions **94, 97, 109, 113, 127**

file names **94, 97**

keywords, emails **94, 96**

sites, reducing traffic **82**

URLs **118**

Web access exceptions **134**

Web categories **47, 109, 114**

Web objects **109, 113**

bottom panel and label

STM150 **22**

STM300 **22**

STM600 **23**

browsers, for Web Management Interface **28**

bundle key, for registering **50**

- buttons (hardware)
 - Power
 - STM150 **20**
 - STM300 **21**
 - STM600 **21**
 - Reset (STM150 only) **20, 71**
 - buttons (software) **31, 32**
- ## C
- CA (Certification Authority) **76**
 - cache, clearing Web categories **115**
 - capabilities and features **9**
 - card, service registration **12**
 - categories, Web content **47, 114**
 - certificates
 - authentication **120**
 - commercial CAs **77**
 - exchange **120**
 - managing **76**
 - NETGEAR default **78**
 - self-signed **77**
 - third party website **123**
 - trusted **79**
 - untrusted **80**
 - warning messages **29, 65, 121**
 - Certification Authority (CA) **76**
 - Challenge Handshake Authentication Protocol (CHAP) **157**
 - clearing statistics **186**
 - clients, identifying infected **199**
 - community strings, SNMP **66**
 - community, ProSecure™ **2**
 - comparison, STM models **12**
 - compatibility, protocols **246**
 - compliance
 - notification of **249**
 - regulatory and safety **247**
 - compressed files
 - email filtering **97**
 - FTP filtering **127**
 - Web filtering **113, 137**
 - concurrent number of users and scanned HTTP connections **12**
 - configuration
 - changes, system logs **179**
 - settings, defaults **245**
 - using the Setup Wizard **32**
 - Configuration Manager login **155**
 - configuration menu (Web Management Interface) **31**
 - connections, concurrently scanned, HTTP **12**
 - console port
 - STM150 **20**
 - STM300 **16**
 - STM600 **18**
 - content filtering
 - See also* emails.
 - See also* Web content filtering.
 - audio, compressed, executable, and video files **137**
 - blocked Web page, user notification settings **113, 114**
 - emails **94, 95**
 - logs **179, 180, 194, 196**
 - overview **84, 109**
 - scheduling **114**
 - settings, using the Setup Wizard **46**
 - Web **47, 112, 114**
 - control, applications **127**
 - cookies **86**
 - CPU usage **186**
 - critical updates **74**
 - crossover cable **11, 224**
- ## D
- dates
 - setting **36, 75, 76**
 - troubleshooting **228**
 - daylight savings time **36, 76**
 - DC (domain controller) agent **164**
 - debug logs **218**
 - dedicated management VLAN port **12**
 - defaults
 - configuration
 - list of settings **245**
 - restoring **70, 227**
 - content filtering settings **85**
 - domains, for authentication **172**
 - IP address **34, 54**
 - login time-out **30**
 - NETGEAR certificate **78**
 - subnet mask **34, 54**
 - user name and password **29**
 - deployment
 - rack mounting **24**
 - scenarios **25**
 - testing and verifying connectivity **49**
 - diagnostic tools **216**
 - distinguished name (DN) **158**
 - distributed spam analysis **102, 103**
 - DNS
 - looking up an address **217**
 - server IP addresses **34, 54**

- documentation
 - online **231**
 - reference **248**
- domain controller (DC) agent **164**
- domains
 - default **172**
 - LDAP and Active Directory (AD) **161**
 - overview **147**
 - RADIUS **167**
 - trusted **109**
 - Web access exceptions, applying to **134**
- downlink (LAN) ports **14, 16**
- downloading
 - DC agent software **165**
 - SSL certificate **29**
 - STM software **73**
- dropped packets, session limit exceeded **57**
- duplex, settings **54**
- dust **23**
- dynamic MAC bindings **60**

E

- eDonkey **85, 130**
- EICAR **49**
- electrical noise **23**
- email notification server
 - configuring manually **176**
 - settings, using the Setup Wizard **42**
 - SMTP server **42, 176**
- emails
 - activity reports **239**
 - antivirus settings **38**
 - antivirus user notifications **93**
 - attachments, sizes **39, 91**
 - audio, compressed, executable, and video files, filtering **97**
 - blocked, statistics **190**
 - content filtering **94, 95**
 - defaults, content filtering and scan settings **85**
 - distributed spam analysis **102, 103**
 - filter logs **179, 180, 194, 196**
 - protection. See SMTP, POP3, or IMAP.
 - real-time blacklist **100**
 - scanned, statistics **189**
 - security settings, using the Setup Wizard **37**
 - SMTP throughput (emails per hour) **12**
 - spam protection, overview **97**
 - traffic logs **179, 180, 194, 196**
 - traffic statistics **186**
 - whitelist and blacklist **98**
- environmental specifications **246**
- error, system logs **179**

- exceptions, Web access
 - custom categories **142**
 - custom groups **139**
 - setting rules **132**
- exclusions, scanning **130**
- executable files
 - email filtering **97**
 - FTP filtering **127**
 - Web filtering **113, 137**

F

- facilities, syslog server **181**
- factory defaults
 - login **22**
 - service licenses, automatic retrieval **51**
 - settings, reverting to **70, 227**
- failure bypass **12**
- features and capabilities **9**
- file extensions
 - blocking
 - for emails **94, 97**
 - for Web access **109, 113, 127**
 - settings access exceptions **137**
- file names, blocking **94, 97**
- File Transfer Protocol. See FTP.
- files, suspicious **230**
- filtering reports **204, 233**
- firmware
 - updating **71**
 - versions **193**
- fixes, "hot" **229**
- Flash objects **86**
- forum, ProSecure™ **2**
- FQDN (fully qualified domain name) **65**
- front panel
 - STM150 **14**
 - STM300 **16**
 - STM600 **18**
- FTP (File Transfer Protocol)
 - action, infected Web file or object **41**
 - default port **40, 106**
 - enabling scanning **40, 106**
 - filtering files (audio, video, executable, and compressed) **127**
 - sizes of files and objects **127**
- fully qualified domain name (FQDN) **65**

G

- gateway address **54**
- Gnutella **85, 130**
- Google Talk **85, 130**

GoToMyPC **86, 130**

groups

- by IP address and subnet, managing **151**
- by IP membership, authentication **135, 141**
- by name, managing **149**
- local **135, 141**
- membership **148**
- overview **147**
- Web access exceptions
 - applying to **134**
 - creating custom groups **139**

guest users **61, 63**

guidelines, performance and sizing **12**

H

hard disk usage **186**

Hard drive (HDD) LED

- STM150, not applicable
- STM300 **17**
- STM600 **19**

hardware

- serial number **193**
- STM150
 - bottom panel and label **22**
 - front panel **14**
 - LEDs **15, 223, 224**
 - rear panel **20**
- STM300
 - bottom panel and label **22**
 - front panel **16**
 - LEDs **17, 223, 224**
 - rear panel **21**
- STM600
 - bottom panel and label **23**
 - front panel **18**
 - LEDs **19, 223, 224**
 - rear panel **21**

help button (Web Management Interface) **32**

hosts

- public **105**
- security alerts **77**
- trusted
 - importing **125**
 - SNMP **67**
 - specifying **124**

hot fixes **229**

HTML (Hypertext Markup Language), scanning **108**

HTTP (Hypertext Transfer Protocol)

- action, infected Web file or object **40, 108**
- default port **40, 106**
- logging, traffic **112**

proxy settings

- configuring manually **61**
- for HTTPS scanning **119, 123**
- using the Setup Wizard **45**

scanning

- concurrent connections **12**
- enabling **40, 106**
- testing **49**
- trusted hosts **124**

HTTPS (Hypertext Transfer Protocol over Secure Socket Layer)

- action, infected Web file or object **41, 108**
- default port **40, 106**
- managing certificates **78**
- scanning
 - enabling **40, 106**
 - explanation of process **119**
- trusted hosts **124**

Hypertext Markup Language (HTML) **108**

Hypertext Transfer Protocol over Secure Socket Layer.
See HTTPS.

Hypertext Transfer Protocol. See HTTP.

I

ICMP (Internet Control Message Protocol) time-out **57**

ICQ (instant messaging) **85, 130**

IDS (intrusion detection system) **8**

IETF (Internet Engineering Task Force) **65**

IMAP (Internet Message Access Protocol)

- action, infected emails **38, 90**
- blocking (password-protected attachments, file extensions, and file names) **96**
- default port **38, 88**
- enabling scanning **38, 88**

importing

- certificates **79**
- trusted hosts **125**

informational messages, system logs **179**

initial configuration, Setup Wizard **32**

installation, steps **27**

instant messaging services

- configuring **130**
- defaults **85**
- statistics **187**

interfaces

- binding to a MAC address **60**
- speed and duplex settings **54**
- status **193**

Internet Control Message Protocol (ICMP) time-out **57**

Internet Engineering Task Force (IETF) **65**

Internet Message Access Protocol. See IMAP.

intrusion detection systems (IDS) and intrusion prevention systems (IPS) **8**

IP addresses

DNS servers **34, 54**

public **105**

STM **34, 54**

subnet mask, STM **34, 54**

IPS (intrusion prevention system) **8**

iTunes **85, 130**

J

Java objects **86**

Javascript **86, 113**

K

KDE (MIB browser) **67**

Kensington lock (STM150 only) **20**

key (bundle), for registering **50**

keywords, blocking in emails **94, 96**

kit, rack-mounting **24**

Knowledge Base **231**

L

LAN default settings **246**

LAN LEDs

STM150 **15**

STM300 **17**

STM600 **19**

troubleshooting **223, 224**

LAN ports

STM150 **14**

STM300 **16**

STM600 **18**

LDAP (Lightweight Directory Access Protocol)

binding a DN **158**

configuring a DN **162**

domains **161**

overview **157**

settings **162**

users and groups **136, 141**

LEDs

Hard drive (HDD)

STM150, not applicable

STM300 **17**

STM600 **19**

LAN

STM150 **15**

STM300 **17**

STM600 **19**

locations

STM150 **14**

STM300 **16**

STM600 **18**

Power

STM150 **15**

STM300 **17**

STM600 **19**

Status

STM150, not applicable

STM300 **17**

STM600 **19**

stop blinking (Test LED, Status LED) **193**

Test (STM150 only) **15**

troubleshooting **223, 224**

WAN

port speed indicators **223**

STM150 **15**

STM300 **17**

STM600 **19**

license expiration alert **182**

licenses

activating **50**

expiration dates **193**

key **12**

trial period **50**

lifetime, quarantine **82**

Lightweight Directory Access Protocol. *See* LDAP.

limits, sessions **57**

listening port, DC agent **166**

location, placement **23**

lock, Kensington (STM150 only) **20**

log information, diagnostics **219**

logging

administrator emailing options **178**

clearing **182**

email address for sending logs **176**

management **199**

querying logs **194**

search criteria **196**

selecting logs **196**

specifying logs to send via email **179**

syslog server **180**

logging out users

all active **172**

preventing inherited access privileges **156**

login

default settings **245**

time-out

changing **62**

defaults **30**

looking up DNS address **217**

M

- MAC addresses, binding **59**
- main navigation menu (Web Management Interface) **31**
- malware
 - alerts and outbreak alerts **182, 183**
 - blocked page, user notification settings **108**
 - detected, statistics **190**
 - infected files, viewing **213**
 - logs **179, 180**
 - quarantine area size **82**
 - quarantined
 - querying and viewing **209**
 - statistics **190**
 - recent 5 and top 5 threats **188**
- management
 - default settings **245**
 - digital certificates **76**
 - performance **82**
- Management Information Base (MIB) **67**
- management ports
 - STM150, not applicable
 - STM300 **16**
 - STM600 **18**
- manually updating software **73**
- maximum transmission unit (MTU) settings **34, 55**
- media applications
 - configuring **130**
 - defaults **85**
 - status **187**
- memory usage **186**
- menu descriptions **31**
- MG-Soft MIB browser **67**
- MIB (Management Information Base), and MIB browsers **67**
- mIRC (instant messaging) **85, 130**
- misclassification, of URLs **115**
- models, STM **12**
- moisture **23**
- MSN Messenger **85, 130**
- MTU (maximum transmission unit) settings **34, 55**

N

- name, system **34, 54**
- NETGEAR Configuration Manager login **155**
- NETGEAR registration server **13**
- Net-SNMP (Linux Text) (MIB browser) **67**
- network
 - diagnostic tools **215, 216**
 - refreshing **57**
 - statistics report, diagnostics **219**

- network settings
 - backing up **68**
 - configuring manually **52**
 - using the Setup Wizard **33**
- Network Time Protocol (NTP), troubleshooting **228**
- notification settings (users)
 - antivirus **93**
 - malware, blocked page **108**
 - URLs, blocked **119**
 - Web content filtering, blocked page **113, 114**
- NTP servers, settings **35, 75**

O

- online analysis, by NETGEAR **230**
- online documentation **231**
- online support **228**
- operating system, updating **44, 71**
- outbreak, malware alerts **182, 184**

P

- package contents, STM **13**
- packets
 - dropped, exceeding session limit **57**
 - transmitted and received, statistics **190**
- pair of ports **12**
- Password Authentication Protocol (PAP) **157**
- password-protected attachments **94, 96**
- passwords
 - changing **62**
 - default **29**
 - restoring **227**
- pattern file
 - signatures **44**
 - updating **71**
- peer-to-peer (P2P) services
 - configuring **130**
 - defaults **85**
 - status **187**
- performance and sizing guidelines **12**
- performance, management **82**
- permanent MAC bindings **60**
- phishing **102**
- physical specifications **246**
- pinging
 - ping utility, diagnostics **216**
 - troubleshooting TCP/IP **225**
- placement, location **23**
- polling interval **186**
- POP3 (Post Office Protocol 3)
 - action, infected emails **38, 90**

- blocking (keywords, password-protected attachments, file extensions, and file names) **96**
 - default port **38, 88**
 - distributed spam analysis **103**
 - enabling scanning **38, 88**
 - ports
 - console
 - STM150 **20**
 - STM300 **16**
 - STM600 **18**
 - LAN
 - speed **223**
 - STM150 **14**
 - STM300 **16**
 - STM600 **18**
 - locations
 - STM150 **14**
 - STM300 **16**
 - STM600 **18**
 - management
 - STM150, not applicable
 - STM300 **16**
 - STM600 **18**
 - public **105**
 - WAN
 - STM150 **14**
 - STM300 **16**
 - STM600 **18**
 - Post Office Protocol 3. *See* POP3.
 - Power button
 - STM150 **20**
 - STM300 **21**
 - STM600 **21**
 - Power LED
 - STM150 **15**
 - STM300 **17**
 - STM600 **19**
 - troubleshooting **223**
 - power receptacle
 - STM150 **20**
 - STM300 **21**
 - STM600 **21**
 - power specifications, adapter **246**
 - priorities, syslog server **181**
 - product updates **2**
 - ProSecure™ forum and community **2**
 - ProSecure™ Web/Email Security Threat Management Appliance STM150, STM300, or STM600 Installation Guide* **27**
 - protocols
 - compatibilities **246**
 - settings access exceptions **137**
 - Web **105**
 - proxies
 - for HTTPS scanning **119**
 - HTTP
 - configuring manually **61**
 - using the Setup Wizard **45**
 - scanning defaults **86**
- ## Q
- QQ (instant messaging) **85, 130**
 - quarantine
 - infected files (malware), viewing **213**
 - search criteria **211**
 - settings **81**
 - spam emails, viewing **212**
 - viewing **208**
 - question mark icon (Web Management Interface) **32**
 - Quicktime **85, 130**
- ## R
- rack-mount kit **24**
 - RADIUS
 - domains **167**
 - overview **157**
 - shared secrets **168**
 - users **136, 142**
 - VLANs **170**
 - RADIUS-CHAP and RADIUS-PAP **157, 168**
 - read/write access, read-only access **61**
 - Real Player **85, 130**
 - real-time blacklist (RBL)
 - emails **100**
 - terms of service **101**
 - real-time clock (RTC) **35, 75**
 - real-time protection, capabilities **10**
 - real-time traffic, diagnostics **217**
 - rear panel
 - STM150 **20**
 - STM300 **21**
 - STM600 **21**
 - rebooting **219**
 - reducing traffic **82**
 - reference documents **248**
 - refreshing the network **57**
 - registering with NETGEAR **50**
 - registration information, retrieving **13**
 - regulatory compliance **247**
 - Remote Authentication Dial In User Service. *See* RADIUS.
 - remote management, access and configuration **64**
 - remote troubleshooting, enabling **228**

removing, embedded objects **113**

reports

email address for sending reports **176**

filtering options **204, 233**

generating **202**

scheduling **203**

templates **200, 233**

user-generated spam report **214**

Web resource usage **191**

Reset button, STM150 (only) **20, 71**

restoring

factory default settings **70, 227**

settings from backup file **69**

Rhapsody **85, 130**

routes, tracing **216**

RTC (real-time clock) **35, 75**

rules, Web access exceptions **132**

S

safety compliance **247**

scan engine

capabilities **10**

updating **44, 71**

scan settings, backing up **68**

scanning

email security settings **38**

exclusions **130**

HTML files **108**

overview **84**

size exceptions

email attachments **39, 91**

FTP files and objects **127**

Web files and objects **41, 108**

Web security settings **40**

scheduling

content filtering **114**

reports **203**

updates **44, 71**

Web access exceptions **136**

search criteria

logs **196**

quarantine **211**

Secure Socket Layer. *See* SSL.

security alerts, trusted or untrusted hosts **77**

security subscription update settings

configuring manually **71**

using the Setup Wizard **43**

service licenses

activating **50**

automatic retrieval **51**

expiration dates **193**

trial period **50**

service registration card **12**

sessions

expiration length **171**

limits **57**

time-out **63**

Setup Wizard, initial configuration **32**

severities, syslog **180**

shared secrets, RADIUS **168**

shutting down **219**

signatures, pattern file **44**

Simple Mail Transfer Protocol. *See* SMTP.

Simple Network Management Protocol. *See* SNMP.

size, exceptions

email attachments **39, 91**

FTP files and objects **127**

Web files and objects **41, 108**

size, quarantine areas **82**

sizing and performance, guidelines **12**

SMTP (Simple Mail Transfer Protocol)

action, infected emails **38, 89**

blocking (keywords, password-protected attachments, file extensions, and file names) **96**

default port **38, 88**

distributed spam analysis **103**

enabling scanning **38, 88**

server for email notification **42, 176**

throughput (emails per hours) **12**

sniffer **224**

SNMP (Simple Network Management Protocol)

overview **65**

settings **66**

SNMPv1 and SNMPv2, supported **65**

traps **67**

trusted hosts **67**

software updates, system logs **179**

software, STM **44**

spam

blocked messages, recent 5 and top 5 **188**

detected, statistics **190**

distributed spam analysis **102**

logs **179, 180, 194, 196**

protection, overview **97**

quarantine area size **82**

quarantined

emails, viewing **212**

querying and viewing **209**

statistics **190**

real-time blacklist (RBL) **100**

reports, sending **104**

user-generated report **214**

whitelist and blacklist **98**

Spamhaus and Spamcop **101**

specifications, physical and technical **246**

- speed settings and autosensing **54**
 - spyware
 - logs **194, 196**
 - See *also* anti virus, *See also* emails.
 - SSL (Secure Socket Layer)
 - connection and HTTPS scanning **120**
 - disabling SSLv2 connections **123**
 - encryption for LDAP **162**
 - SSLv2, SSLv3, and TLSv1 **123**
 - SSL certificates
 - downloading **29**
 - warning message **65, 121**
 - statistics (interfaces, service, and traffic) **189**
 - status
 - interfaces and Web Management Interface **193**
 - system **186, 192**
 - Status LED
 - STM150, not applicable
 - STM300 **17**
 - STM600 **19**
 - stop blinking **193**
 - troubleshooting **223**
 - STM150 hardware
 - bottom panel and label **22**
 - front panel **14**
 - LEDs **15, 223, 224**
 - rear panel **20**
 - STM300 hardware
 - bottom panel and label **22**
 - front panel **16**
 - LEDs **17, 223, 224**
 - rear panel **21**
 - STM600 hardware
 - bottom panel and label **23**
 - front panel **18**
 - LEDs **19, 223, 224**
 - rear panel **21**
 - Stream Scanning technology overview **10**
 - streaming, scanned file parts **40, 108**
 - submenu tabs (Web Management Interface) **31**
 - subnet mask, STM **34, 54**
 - support
 - online **228**
 - technical **2**
 - suspicious files **230**
 - switch, power
 - STM150 **20**
 - STM300 **21**
 - STM600 **21**
 - synchronization interval, DC agent **166**
 - syslog server **180**
 - system
 - activity reports **244**
 - logs **179, 180, 194, 196**
 - name **34, 54**
 - status **186, 192**
 - system date and time settings, using the Setup Wizard **35**
- ## T
- table buttons (Web Management Interface) **32**
 - tabs, submenu (Web Management Interface) **31**
 - TCP (Transmission Control Protocol) time-out **57**
 - TCP/IP network troubleshooting **225**
 - technical specifications **246**
 - technical support **2**
 - templates, reports **200, 233**
 - terms of service, real-time blacklist (RBL) **101**
 - Test LED (STM150 only)
 - description **15**
 - stop blinking **193**
 - troubleshooting **223**
 - testing
 - connectivity and HTTP scanning **49**
 - URLs **217**
 - throughput
 - SMTP (emails per hour) **12**
 - Web scan **12**
 - time
 - setting **36, 75, 76**
 - troubleshooting **228**
 - time zone **36, 76**
 - time, daylight savings
 - applied automatically **36, 76**
 - troubleshooting **228**
 - time-out
 - errors **225**
 - sessions **63**
 - TCP, UDP, and ICMP **57**
 - TLS (Transport Layer Security) **162**
 - tools (online)
 - configuring **130**
 - defaults **86**
 - status **187**
 - tracing a route (traceroute) **216**
 - trademarks **2**
 - traffic
 - diagnostic tools **215**
 - email and Web logs **179, 180, 194, 196**
 - real-time diagnostics **217**
 - reducing **82**
 - total scanned, in MB **189**
 - total, in bytes **188**

- Transmission Control Protocol (TCP) time-out **57**
- Transport Layer Security (TLS) **162**
- traps, SNMP **67**
- trial period, service licenses **50**
- troubleshooting
 - basic functioning **223**
 - browsers **225**
 - configuration settings, using sniffer **224**
 - defaults **225**
 - LEDs **223, 224**
 - NTP **228**
 - remotely **228**
 - testing your setup **226**
 - time-out error **225**
 - Web Management Interface **224**
- trusted certificates **79**
- trusted domains **109**
- trusted hosts **124**
- trusted URLs **109**

U

- UDP (User Datagram Protocol) time-out **57**
- unauthenticated users **135**
- untrusted certificates **80**
- update failure alert **182, 183**
- update servers **44, 73**
- update settings
 - backing up **68**
 - security subscriptions
 - configuring manually **71**
 - using the Setup Wizard **43**
- updates
 - critical **74**
 - product **2**
 - scheduling **44, 71**
- updating software **71**
- uplink (WAN) ports **14, 16**
- URLs
 - blacklist **118**
 - blocked
 - statistics **190**
 - user notification settings **119**
 - categorization **115**
 - custom categories **144, 145**
 - misclassification **115**
 - settings access exceptions **137**
 - testing **217**
 - trusted **109**
 - using wildcards **118**
 - whitelist **118**
- USB port, nonfunctioning
 - STM150 **14**

- STM300 **16**
- STM600 **18**
- User Datagram Protocol (UDP) time-out **57**
- user name, default **29**
- User Portal Login link **156**
- users
 - accounts, configuring **152**
 - administrative (admin) **61, 63, 155**
 - authenticated **135, 148**
 - global settings **170**
 - guests **61, 63**
 - logging out **156**
 - number of concurrent **12**
 - overview **147**
 - searching **135, 141, 173**
 - special privileges **155**
 - unauthenticated **135, 148**
 - Web access exceptions, applying to **134**

V

- virus
 - logs **194, 196**
 - See also malware.
- VLAN port, dedicated management **12**
- VLANs (virtual LANs), using for authentication **170**

W

- WAN LEDs
 - port speed indicators **223**
 - STM150 **15**
 - STM300 **17**
 - STM600 **19**
 - troubleshooting **224**
- WAN ports
 - STM150 **14**
 - STM300 **16**
 - STM600 **18**
- warning message, SSL certificate **29, 65, 121**
- Weatherbug **86, 130**
- Web access exceptions
 - custom categories **142**
 - custom groups **139**
 - setting rules **132**
- Web activity
 - reports **233**
 - statistics **186**
 - traffic logs **179, 180, 194, 196**
- Web categories
 - blocked, recent 5 and top 5 **188**
 - blocking **109, 114**
 - blocking, using the Setup Wizard **47**
 - custom, for exceptions **142, 144**

- default settings **86**
- filtering, using the Setup Wizard **46**
- setting access exceptions **138**

Web content filtering

- audio, compressed, executable, and video files **113, 137**
- blocked malware, user notifications **108**
- blocked page, user notifications **113, 114**
- blocked URL, user notifications **119**
- defaults **85**
- files and objects, sizes **41, 108**
- logs **179, 180, 194, 196**
- overview **109**
- security settings, using the Setup Wizard **39**

Web Management Interface **31**

- browsers, qualified **28**
- layout **30**
- settings **34**
- status **193**
- troubleshooting **224**

Web objects

- blocking **109, 113**
- default settings **86**
- sizes **41, 108**

Web protection. See HTTP, See HTTPS, See FTP.

Web resource usage

- monitoring **190**
- reports **191**

Web scanning

- defaults **85**
- throughput **12**

whitelist

- emails **98**
- URLs **118**

wildcards, using for URLs **118**

Winamp **85, 130**

Y

Yahoo Messenger **85, 130**

Yahoo Toolbar **86, 130**

Z

zone, time **36, 76**