

Japanese
Technology



Protection, Monitoring and Control Components for Low Voltage Equipment

SELECTION GUIDE: INTERNATIONAL EDITION







[Terasaki is the world leader for circuit breakers in switchgear in the marine market]

Terasaki supply circuit breakers which protect people and equipment from electrical faults. Safety and protection are the prime purposes of our products.

We supply products to switchboard builders, shipbuilders and equipment manufacturers. We are global market leaders for switchgear in the marine market. Terasaki have worldwide export experience and the necessary professional skills to support your business.



[Telehouse Data Centre, London. 199 TemPower 2 ACBs, 423 TemBreak 2 MCCBs.]



Terasaki Profile	4
Overheating Protection and Selectivity Analysis Software	6
Moulded Case Circuit Breakers	7
Electronic Protection Including Types with Monitoring and Communication	8
Adjustable Thermal and Adjustable Magnetic Protection	10
TemBreak 2 Lite	12
Circuit Breakers with Integral Residual Current Protection (CBR)	13
Moulded Case Circuit Breakers for Special Applications	14
MCCB Accessories	15
Air Circuit Breakers	16
ACB Selection Guide	17
Protection Relay Guide	18
ACB Accessories	19
Retrofit	20
Advanced External Display and Protection Products	22
Monitoring and Communication: T2ED	22
Multi-Protection Relay: TemTrip 2	22
Contactors and Manual Motor Starters	23
Contactor Selection Guide 3P	24
Contactor Selection Guide 4P	26
MMS Selection Guide	28
Automatic Transfer Controller and Earth Leakage Protection Relays	29
DIN Modular Protection	30
Accessories	30
Din Modular Protection Selection Guide	31



TERASAKI PROFILE



Mr. Taizo Terasaki
President



Mr. Masakazu Fujita
Chairman

Foundation:

October 1, 1923

Established:

April 1, 1980

Capital:

1236640 thousands of yen

Chairman:

Masakazu Fujita

President:

Taizo Terasaki

Number of Employees:

1895

Net sales:

39400 million yen

Subsidiaries:

5 domestic (Japan) and 9 overseas

Affiliated companies:

2 domestic

Listing:

Tokyo Stock Exchange (Jasdaq)
[Security code 6637]

“We want to meet the needs of more customers around the world in our circuit breaker and lifecycle service businesses.”

Mr. Taizo Terasaki, President



Mr. Yasuhiko Terasaki
Late chairman of the company



Mr. Yasutaro Terasaki
Founder of the company

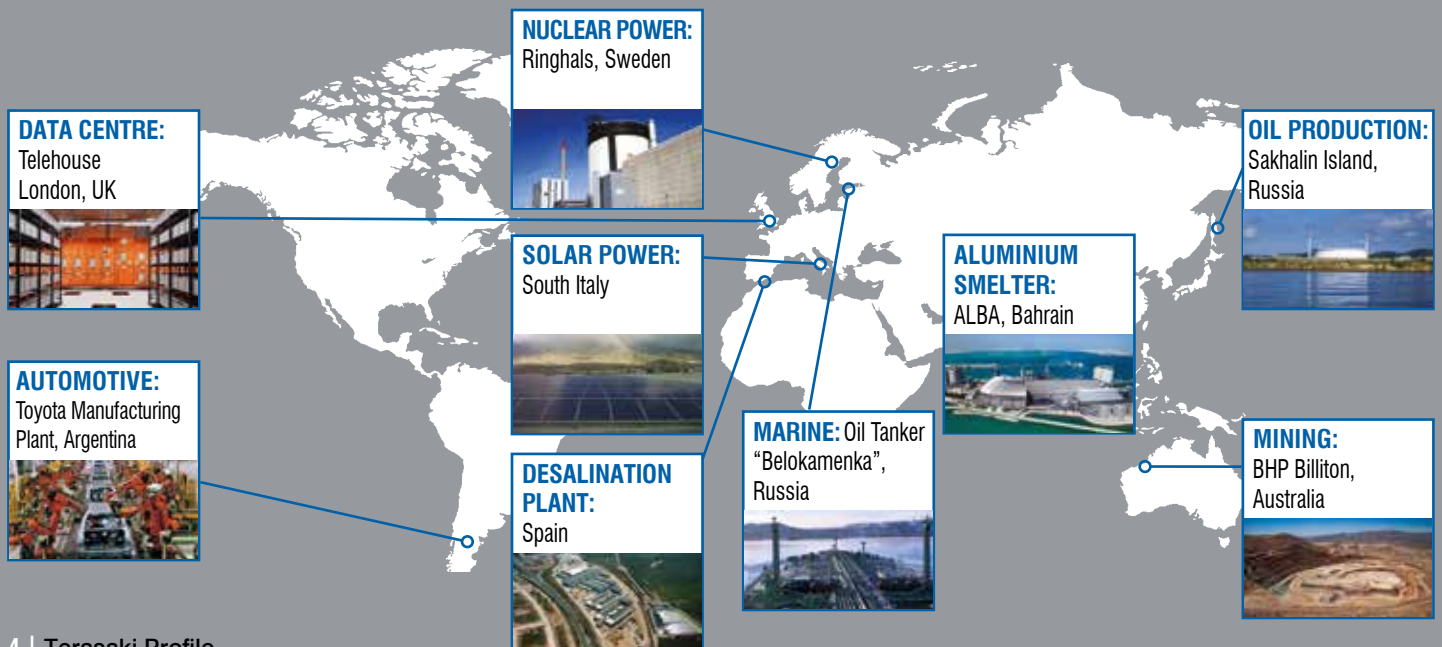

R&D

We are meeting the needs of customers with a complete system of development, design and manufacture based on the know-how we have accumulated with electrics, electronics and control over the decades since our founding.

We have DEKRA (formerly KEMA) -approved test systems and two generators in house to carry out the necessary development tests.

Terasaki realises optimised products through 3D CAD, software development, mould and sheet metal design, structural design and resin flow analysis.



PRODUCTS & SERVICES



Air Circuit Breakers



Moulded Case Circuit Breakers



Din Modular Protection



Automatic Transfer Controller



Contactors



External Display



Asset Management



Retrofit

CAPABILITIES

Safety & Reliability

High MTBF; Low MTTR; temperature monitoring, double control circuits

Approvals

ISO 9001; ISO 14001; OHSAS 18001; Lloyds; BV; GL; GOST; SABS; DEKRA (KEMA); ASTA; IEC 60947-2; IEC 61439; IEC 60898

Asset Management

Retrofits; Preventative Maintenance; Lifecycle Management

Special Protection Solutions

DC; PV; UPS; 1000V AC; Integrated residual protection; 100kA and above



3C Overheating Protection for Contacts, Connections & Conductors



3C BENEFITS

- **LOW INVESTMENT** [system is integrated with circuit breakers]
- **FAST INSTALLATION** [breakers are supplied with sensors already fitted]
- **EASY UPGRADE** [the 3C system can be retrofitted to existing installations]
- **FREE EXTENDED WARRANTY ON NEW CIRCUIT BREAKERS**
[when 3C overheating protection is included with the order]



TemCurve Selectivity Analysis Software

TemCurve Lite 3.0

TemCurve Lite Selectivity Software can assist in protection device grading from the transformer primary to the point of final distribution. The software is designed for the Terasaki range of circuit breakers, but also includes a large number of complimentary protection devices such as low and high voltage fuses and relays.

TemCurve Lite 3.0 is FREE

- The software package is now multilingual allowing you to select from: English, Italian, Spanish, Russian, Swedish, Chinese and Japanese language options
- It can output DXF and PDF files
- Latest product developments included: TemBreak 2 Lite MCCBs and TemBreak 2 CBRs.





Moulded Case Circuit Breakers

5 Reasons to Use TemBreak 2 MCCBs



1. Electronic Versions with integrated monitoring and communication

Data can be sent to integrated display, local display and Modbus network simultaneously.

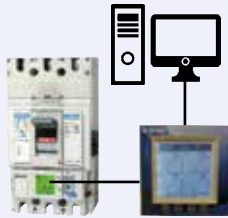

*See T2ED on page 22

4. Circuit breaker with integral residual current protection (CBRs) [see page 13]

We offer integrated protection from earth leakage faults, overloads and short-circuits in one device.



2. Smaller 1000A MCCB

It is only 273mm high and 210mm wide - same size as 800A MCCB



Previous 1000A MCCB New 1000A MCCB

5. Direct opening action.

The robust mechanism ensures that the force you apply to the toggle is transmitted directly to the contacts. Direct opening action is recommended by IEC 60204-1, Safety of Machinery: Electrical Equipment for Machinery



3. Superior temperature performance

We offer MCCBs for use up to 50°C without derating from 20A to 1600A



CUSTOMER ENDORSEMENT

“Terasaki Electric have supplied circuit breakers for a number of high resilience projects that we have designed, through the selected switchgear suppliers.

They have always provided excellent support to our projects and we have found them to be a good company to partner with on component supply; the selected products provided the ideal solution for our mission critical environments.

We have no hesitation in including Terasaki Electric devices in our designs.”

Karl Luck, WSP (Engineering Consultancy, UK)



Electronic Protection Including Types with Monitoring and Communication

Electrical Characteristics to IEC 60947-2, EN 60947-2, JIS C 8201-2-1 ANN.1, AS/NZS 3947-2, NEMA AB-1

Frame Reference	Quantity	Unit	Condition	TB2 S/H/L 250			
Model				S250	S250	S250	H250
Type				NE	GE	PE	NE
Number of Poles				3,4	3,4	3,4	3,4
Nominal current ratings	I_n	(A)	50°C	40,125,160,250	40,125,160,250	40,125,160,250	40,125,160,250
Monitoring and Communication				●	●	●	●
Electrical characteristics							
Rated Operational voltage	U_e	(V)	AC 50/60 HZ	690	690	690	690
Rated insulation voltage	U_i	(V)		800	800	800	800
Rated impulse withstand voltage	U_{imp}	(kV)		8	8	8	8
Ultimate breaking capacity (IEC, JIS, AS/NZS)	I_{cu}	(kA)	690V AC 525V AC 440V AC 400/415V AC 220/240V AC	7.5 25 25 36 65	7.5 25 50 65 85	20 35 50 70 125	20 45 120 125 150
Service breaking capacity (IEC, JIS, AS/NZS)	I_{cs}	(kA)	690V AC 525V AC 440V AC 400/415V AC 220/240V AC	7.5 25 25 36 65	7.5 25 25 36 85	15 35 50 70 125	15 45 80 85 150
Rated breaking capacity (NEMA)		(kA)	480V AC 240V AC	25 65	25 65	35 125	45 150
Rated short-time withstand current	I_{cw}	(kA)	0.3 sec	–	–	–	–
Utilisation category				A	A	A	A
Dimensions							
	Height	(mm)		165	165	165	165
	Width	(mm)	3 Pole 4 Pole	105 140	105 140	105 140	105 140
	Depth	(mm)		103	103	103	103
	Weight	(kg)	3 Pole 4 Pole	2.5 3.3	2.5 3.3	2.5 3.3	2.5 3.3
Operation							
Endurance	Electrical	cycles	415V AC			10,000	
	Mechanical	cycles				30,000	

Frame Reference	Quantity	Unit	Condition	TB2 H/L 800		TB2 1000			
Model				H800	L800	S800	S800	S1000	S1000
Type				NE	NE	NE	RE	SE	NE
Number of Poles				3,4	3,4	3,4	3,4	3,4	3,4
Nominal current ratings	I_n	(A)	50°C	630,800	630,800	630,800	630,800	1000 ^⑥	1000 ^⑥
Monitoring and Communication				●	●	●	●	●	●
Electrical characteristics									
Rated Operational voltage	U_e	(V)	AC 50/60 HZ	690	690	690	690	690	690
Rated insulation voltage	U_i	(V)		800	800	800	800	800	800
Rated impulse withstand voltage	U_{imp}	(kV)		8	8	8	8	8	8
Ultimate breaking capacity (IEC, JIS, AS/NZS)	I_{cu}	(kA)	690V AC 525V AC 440V AC 400/415V AC 220/240V AC	25 ^① 40 125 125 150	25 ^① 45 180 200 200	20 ^① 30 50 50 85	25 ^① 35 65 70 100	20 ^① 30 45 50 85	25 ^① 45 65 70 100
Service breaking capacity (IEC, JIS, AS/NZS)	I_{cs}	(kA)	690V AC 525V AC 440V AC 400/415V AC 220/240V AC	20 ^① 34 94 94 150	20 ^① 34 135 150 150	20 ^① 30 50 50 85	20 ^① 30 50 50 75	15 ^① 23 34 38 65	20 ^① 34 50 50 75
Rated breaking capacity (NEMA)		(kA)	480V AC 240V AC	40 150	45 200	30 85	35 100	30 85	45 100
Rated short-time withstand current	I_{cw}	(kA)	0.3 sec	10	10	10	10	–	–
Utilisation category				B	B	B	B	A	A
Dimensions									
	Height	(mm)		273	273	273	273	273	273
	Width	(mm)	3 Pole 4 Pole	210 280	210 280	210 280	210 280	210 280	210 280
	Depth	(mm)		140	140	103	103	103	103
	Weight	(kg)	3 Pole 4 Pole	⑥ ⑦	⑥ ⑦	④ ⑤	④ ⑤	11.0 14.8	11.0 14.8
Operation									
Endurance	Electrical	cycles	415V AC		4,000			4,000	
	Mechanical	cycles			10,000			10,000	

– Not available • Optional ① MCCB cannot be used in IT systems at this voltage ② 100KA at 400V ③ 75KA at 400V ④ 8.7kg 630A, 9.1kg 800A ⑤ 11.9kg 630A, 12.3kg 800A ⑥ 13.3kg 630A, 14.8kg 800A ⑦ 16.8kg 630A, 18.8kg 800A ⑧ Not fully rated at 50°C. Contact Terasaki

TB2 H/L 400		TB2 E/S 630					
H400	L400	S400	S400	S400	E630	S630	S630
NE	NE	NE	GE	PE	NE	CE	GE
3,4	3,4	3,4	3,4	3,4	3,4	3,4	3,4
250, 400	250, 400	250,400	250,400	250,400	630	630	630
•	•	•	•	•	•	•	•
690	690	690	690	690	690 ^①	690 ^①	690 ^①
800	800	800	800	800	800	800	800
8	8	8	8	8	8	8	8
35	50	20	20	20	10 ^①	20 ^①	20 ^①
45	65	30	30	30	15	30	30
120	180	45	65	80	25	45	65
125	200	50	70	85	36	50	70
150	200	85	100	100	50	85	100
35	50	15	15	15	10 ^①	15 ¹	15 ^①
45	65	30	30	30	15	30	30
80	135	45	50	80	25	45	50
85	150	50	50	85	36	50	50
150	150	85	85	85	50	85	85
45	65	25	30	30	15	25	30
150	200	85	100	100	50	85	100
5	5	5	5	5	–	–	–
B	B	B	B	B	A	A	A
260	260	260	260	260	260	260	260
140	140	140	140	140	140	140	140
185	185	185	185	185	185	185	185
140	140	103	103	103	103	103	103
7.1	7.1	4.3	4.3	4.3	5.0	5.0	5.0
9.4	9.4	5.7	5.7	5.7	6.5	6.5	6.5
4,500					4,500		
15,000					15,000		



Electronic overload protection is adjustable from 40% to 100% of rated current for **ALL** TemBreak 2 models.

TB2 1250			TB21600	
S1250	S1250	S1250	S1600	S1600
SE	NE	GE	SE	NE
3,4	3,4	3,4	3,4	3,4
800, 1250	800, 1250	800, 1250	1250, 1600	1250, 1600
–	–	–	–	–
690	690	690	690	690
800	800	800	800	800
8	8	8	8	8
20 ^①	25 ^①	45 ^①	20 ^①	45 ^①
30	45	65	30	65
45	65	85	45	85
50	70	100/85 ^②	50	100/85 ^②
85	100	125	85	125
15 ^①	20 ^①	34 ^①	15 ^①	34 ^①
23	34	50	23	50
34	50	65	34	65
38	50	75/65 ^③	38	75/65 ^③
65	75	94	65	94
30	45	65	30	65
85	100	125	85	125
15	15	15	20	20
B	B	B	B	B
370	370	370	370	370
210	210	210	210	210
280	280	280	280	280
120	120	120	140	140
19.8	19.8	19.8	27.0	27.0
25.0	25.0	25.0	35.0	35.0
4,000			2,000	
5,000			5,000	

– Not available • Optional ^① MCCB cannot be used in IT systems at this voltage ^②100KA at 400V ^③75KA at 400V ^④8.7kg 630A, 9.1kg 800A ^⑤11.9kg 630A, 12.3kg 800A ^⑥13.3kg 630A, 14.8kg 800A ^⑦16.8kg 630A, 18.8kg 800A

MCCBS up to 3200A are available. Contact Terasaki for details.



Adjustable Thermal and Adjustable Magnetic Protection

Electrical Characteristics to IEC 60947-2, EN 60947-2, JIS C 8201-2-1 ANN.1, AS/NZS 3947-2, NEMA AB-1

Frame Reference	Quantity	Unit	Condition	TB2 S125			TB2 S250	
Model				S125	S125	S160	S160	
Type				NJ	GJ	NJ	GJ	
Number of Poles				3,4	3,4	3,4	3,4	
Nominal current ratings	I_n	(A)	50°C	20,32,50,63,100,125	20,32,50,63,100,125	20,32,50,63,100,125,160	50,63,100,125,160	
Electrical characteristics								
Rated Operational voltage	U_e	(V)	AC 50/60 Hz DC	690 250	690 250	690 250	690 250	
Rated insulation voltage	U_i	(V)		800	800	800	800	
Rated impulse withstand voltage	U_{imp}	(kV)		8	8	8	8	
Ultimate breaking capacity (IEC, JIS, AS/NZS)	I_{cu}	(kA)	690V AC 525V AC 440V AC 400/415V AC 220/240V AC 250V DC	6 22 25 36 50 25	6 25 50 65 85 40	7,5 (5*) 25(18*) 25(18*) 36 (30*) 65 (42*) 40 (30*)	7,5 25 50 65 85 40	
Service breaking capacity (IEC, JIS, AS/NZS)	I_{cs}	(kA)	690V AC 525V AC 440V AC 400/415V AC 220/240V AC 250V DC	6 22 25 36/30 50 19	6 22 25 36/33 85 40	7,5 (5*) 25(18*) 25(18*) 36 (25*) 65 (35*) 40 (25*)	7,5 25 25 36 85 40	
Rated breaking capacity (NEMA)		(kA)	480V AC 240V AC	22 50	25 85	22(18*) 65(42*)	25 85	
Utilisation category				A	A	A	A	
Dimensions								
	Height	(mm)		155	155	165	165	
	Width	(mm)	3 Pole 4 Pole	90 120	90 120	105 140	105 140	
	Depth	(mm)		68	68	68	68	
	Weight	(kg)	3 Pole 4 Pole	1.1 1.4	1.1 1.4	1.5 1.9	1.5 1.9	
Operation								
Endurance	Electrical	cycles	415V AC		30,000		20,000	
	Mechanical	cycles			30,000		30,000	

Frame Reference	Quantity	Unit	Condition	TB2 S/H/L 250			TB2 E/S 630	
Model				S250	H250	L250	E400	S400
Type				RJ	NJ	NJ	NJ	CJ
Number of Poles				3,4	3,4	3,4	3,4	3,4
Nominal current ratings	I_n	(A)	50°C	160,250	160,250	160,250	250,400	250,400
Electrical characteristics								
Rated Operational voltage	U_e	(V)	AC 50/60 Hz DC	690 250	690 250	690 250	525 250	690 250
Rated insulation voltage	U_i	(V)		800	800	800	800	800
Rated impulse withstand voltage	U_{imp}	(kV)		8	8	8	8	8
Ultimate breaking capacity (IEC, JIS, AS/NZS)	I_{cu}	(kA)	690V AC 525V AC 440V AC 400/415V AC 220/240V AC 250V DC	20 35 65 65 100 40	20 45 120 125 150 40	25 65 180 200 200 40	– 15 22 25 35 25	15 22 30 36 50 40
Service breaking capacity (IEC, JIS, AS/NZS)	I_{cs}	(kA)	690V AC 525V AC 440V AC 400/415V AC 220/240V AC 250V DC	15 35 65 65 100 40	15 45 80 85 150 40	20 65 135 150 150 40	– 15 22 25 35 19	15 22 30 36 50 40
Rated breaking capacity (NEMA)		(kA)	480V AC 240V AC	35 100	45 150	65 200	15 35	22 50
Utilisation category				A	A	A	A	A
Dimensions								
	Height	(mm)		165	165	165	260	260
	Width	(mm)	3 Pole 4 Pole	105 140	105 140	105 140	140 185	140 185
	Depth	(mm)		103	103	103	103	103
	Weight	(kg)	3 Pole 4 Pole	2.4 3.2	2.4 3.2	2.4 3.2	4.2 5.6	4.3 5.6
Operation								
Endurance	Electrical	cycles	415V AC		10,000		4,500	
	Mechanical	cycles			30,000		15,000	

① MCCB cannot be used in IT systems at this voltage *Applies only to 20A and 32A models – Not available

TB2 S250		TB2 S/H/L 250				
S250	S250	S125	H125	L125	H160	L160
NJ	GJ	RJ	NJ	NJ	NJ	NJ
3,4	3,4	3,4	3,4	3,4	3,4	3,4
160,200,250	160,200,250	20,32,50,63,100,125			160	160
690	690	690	690	690	690	690
250	250	250	250	250	250	250
800	800	800	800	800	800	800
8	8	8	8	8	8	8
7.5	7.5	20	20	25	20	25
25	25	35	45	65	45	65
25	50	65	120	180	120	180
36	65	65	125	200	125	200
65	85	100	150	200	150	200
40	40	40	40	40	40	40
7.5	7.5	15	15	20	15	20
25	25	35	45	65	45	65
25	25	65	80	135	80	135
36	36	65	85	150	85	150
65	85	100	150	150	150	150
40	40	40	40	40	40	40
22	25	35	45	65	45	65
65	85	100	150	200	150	200
A	A	A	A	A	A	A
165	165	165	165	165	165	165
105	105	105	105	105	105	105
140	140	140	140	140	140	140
68	68	103	103	103	103	103
1.5	1.5	2.4	2.4	2.4	2.5	2.5
1.9	1.9	3.2	3.2	3.2	3.3	3.3
10,000		30,000			20,000	
30,000		30,000			30,000	



Thermal protection is adjustable from 63% to 100% of rated current. We can supply MCCBs with thermal protection sealed and fixed at specific values (for example 40A, 80A,300A) by special request.

TB2 E/S 630			TB2 1000		
S400	S400	S400	S800	S800	S800
NJ	GJ	PJ	CJ	NJ	RJ
3,4	3,4	3,4	3,4	3,4	3,4
250,400	250,400	250,400	630,800	630,800	630,800
690	690	690	690	690	690
250	250	250	250	250	250
800	800	800	800	800	800
8	8	8	8	8	8
20	20	20	10 ^①	20 ^①	25 ^①
30	30	30	15 ^①	30	45
45	65	80	30	50	65
50	70	85	36	50	70
85	100	100	50	85	100
40	40	40	50	50	50
15	15	15	10 ^①	20 ^①	20 ^①
30	30	30	15 ^①	30	34
45	50	80	30	50	50
50	50	85	36	50	50
85	85	85	50	85	75
40	40	40	50	50	50
25	30	30	15	30	65
85	100	100	50	85	200
A	A	A	A	A	A
260	260	260	273	273	273
140	140	140	210	210	210
185	185	185	280	280	280
103	103	103	103	103	103
4.2	4.2	4.2	8.5	8.5	8.5
5.6	5.6	5.6	11.5	11.5	11.5
4,500			4,000		
15,000			10,000		



TemBreak 2 Lite

Electrical Characteristics to IEC 60947-2, EN 60947-2, JIS C 8201-2-1 ANN.1, AS/NZS 3947-2, NEMA AB-1

Frame Reference	Quantity	Condition	TB2 Lite 160							
			E160	E160	E160	S160	S160	S160	S160	S160
Model			E160	E160	E160	S160	S160	S160	S160	S160
Type			SF	SF	SJ	SCF	SCJ	SHJ	SF	SJ
Number of Poles			1	3,4	3,4	3,4	3,4	3,4	3,4	3,4
Nominal current ratings	I_n (A)	50°C	16,20,25,32,40,50,63,80,100,125	16,20,25,32,40,50,63,80,100,125,160	20,40,63,80,100,125,160	16,20,25,32,40,50,63,80,100,125,160	25,40,63,80,100,125,160	25,40,63,80,100,125,160	16,20,25,32,40,50,63,80,100,125,160	25,40,63,80,100,125,160
Electrical characteristics										
Rated Operational voltage	U_e (V)	AC 50/60 Hz DC	240 –	525 250	525 250	525 250	525 250	525 250	690 250	690 250
Rated insulation voltage	U_i (V)		690	690	690	690	690	690	690	690
Rated impulse withstand voltage	U_{imp} (kV)		8	8	8	8	8	8	8	8
Ultimate breaking capacity (IEC, JIS, AS/NZS)	I_{cu} (kA)	690V AC 525V AC 440V AC 400/415V AC 220/240V AC 250V DC	– – – – 25 –	– 6 10 16 25 13	– – 10 16 25 13	– 7.5 15 25 35 20	– 7.5 15 25 35 20	– 7.5 7.5 25 35 20	6 10 25 40 50 25	6 10 25 40 50 25
Service Breaking Capacity (IEC, JIS, AS/NZS)	I_{cs} (kA)	690V AC 525V AC 440V AC 400/415C AC 220/240V AC 250V DC	– – – – 13 –	– 3 5 8 13 7	– 3 5 8 13 7	– 4 7.5 13 18 10	– 4 7.5 13 18 10	– 4 4 25 25 10	3 7.5 13 20 25 13	3 7.5 13 20 25 13
Rated breaking capacity (NEMA)	(kA)	480V AC 240V AC	– 25	6 25	6 25	7.5 35	7.5 35	– –	10 50	10 50
Protection										
Fixed Thermal, fixed magnetic			☐	☐	–	☐	–	–	☐	–
Adjustable thermal, fixed magnetic			–	–	☐	–	☐	☐	–	☐
Dimensions										
	Height (mm)		130	130	130	130	130	130	130	130
	Width (mm)	3 Pole (4 Pole)	25 (1P)	75, (100)	75, (100)	75, (100)	75, (100)	75, (100)	75, (100)	75, (100)
	Depth (mm)		68	68	68	68	68	68	68	68
	Weight (kg)	3 Pole (4 Pole)	0.3 (1P)	0.8 (1.0)	0.8 (1.0)	0.8 (1.0)	0.8 (1.0)	0.8 (1.0)	0.8 (1.0)	0.8 (1.0)
Endurance										
Electrical	415V		10,000					10,000 ^①		
Mechanical			20,000					20,000		

Frame Reference	Quantity	Condition	TB2 Lite 250					
			E250	E250	E250	E250	S250	S250
Model			E250	E250	E250	E250	S250	S250
Type			SCF	SCJ	SF	SJ	SF	SJ
Number of Poles			3, 4	3, 4	3, 4	3, 4	3, 4	3, 4
Nominal current ratings	I_n	50°C	125,150,175,200,225,250	100,125,160,200,250	125,150,175,200,225,250	100,125,160,200,250	125,150,175,200,225,250	160,200,250
Electrical characteristics								
Rated Operational voltage	U_E (V)	AC 50/60 Hz DC	525 250	525 250	525 250	525 250	690 250	690 250
Rated insulation voltage	U_i (V)		690	800	690	800	690	800
Rated impulse withstand voltage	U_{imp} (kV)		8	8	8	8	8	8
Ultimate breaking capacity (IEC, JIS, AS/NZS)	I_{cu} (kA)	690V AC 525V AC 440V AC 400/415C AC 220/240V AC 250V DC	– 6 10 16 25 13	– 6 10 16 25 13	– 7.5 15 25 35 15	– 7.5 15 25 35 15	4 10 30 40 85 25	4 10 30 40 85 25
Service Breaking Capacity (IEC, JIS, AS/NZS)	I_{cs} (kA)	690V AC 525V AC 440V AC 400/415C AC 220/240V AC 250V DC	– 3 5 8 13 7	– 3 5 8 13 7	– 6 12 19 27 12	– 6 12 19 27 12	4 7.5 15 20 43 13	4 7.5 15 20 43 13
Rated breaking capacity (NEMA)	(kA)	480V AC 240V AC	6 25	6 25	10 35	10 35	25 85	25 85
Protection								
Fixed Thermal, fixed magnetic			☐	–	☐	–	☐	–
Adjustable thermal, adjustable magnetic			–	☐	–	☐	–	☐
Dimensions								
	Height (mm)		165	165	165	165	165	165
	Width (mm)	3 Pole (4 Pole)	105 (140)	105 (140)	105 (140)	105 (140)	105 (140)	105 (140)
	Depth (mm)		68	68	68	68	68	68
Weight	Weight (kg)	3 Pole (4 Pole)	1.5 (1.9)	1.5 (1.9)	1.5 (1.9)	1.5 (1.9)	1.5 (1.9)	1.5 (1.9)
Endurance								
Electrical	415V						6,000	
Mechanical							18,000	

– Not available ☐ Standard ① 14,000 < 125A



Circuit Breakers with Integral Residual Current Protection (CBR)

Electrical Characteristics to IEC 60947-1, IEC 60947-2, IEC 60947-2 ANNEXEB, IEC 60755

Frame Reference	Quantity	Unit	Condition	TB2 S125			TB2 S250		
Model				ZE125	ZS125	ZS125	ZE250	ZS250	ZS250
Type				NJ	NJ	GJ	NJ	NJ	GJ
Number of Poles				3,4	3,4	3,4	3,4	3,4	3,4
Nominal current ratings	I_n	(A)	50°C	20,32,50,63,100,125	20,32,50,63,100,125	20,32,50,63,100,125	160,250	160,250	160,250
Electrical characteristics									
Rated Operational voltage	U_e	(V)	AC 50/60 HZ	525	525	525	525	525	525
Rated insulation voltage	U_i	(V)		525	525	525	525	525	525
Rated impulse withstand voltage	U_{imp}	(kV)		8	8	8	8	8	8
Ultimate breaking capacity (IEC, JIS, AS/NZS)	I_{cu}	(kA)	525V AC	8	22	25	10	25	25
			440V AC	15	25	50	15	25	50
			400/415V AC	25	36	65	25	36	65
Service breaking capacity (IEC, JIS, AS/NZS)	I_{cs}	(kA)	220/240V AC	35	50	85	35	65	85
			525V AC	6	22	22	7.5	25	25
			440V AC	12	25	25	12	25	25
400/415V AC	19	36/30	36/33	19	36	36			
							220/240V AC	27	50
Protection									
Adjustable thermal, fixed magnetic, residual/earth leakage				<input type="checkbox"/>	<input type="checkbox"/>	<input type="checkbox"/>	<input type="checkbox"/>	<input type="checkbox"/>	<input type="checkbox"/>
Dimensions									
Height	(mm)		155	155	155	165	165	165	
			Width	(mm)	3 Pole	90	90	90	105
Depth	(mm)		120	120	120	140	140	140	
			Weight	(kg)	3 Pole	1.1	1.1	1.1	1.5
			1.4	1.4	1.4	1.9	1.9	1.9	
			Operation						
Endurance	Electrical	cycles	415V AC	30,000			10,000		
	Mechanical	cycles		30,000			10,000		

- Not available Standard



Residual current protection settings: 30mA, 100mA, 300mA, 500mA, 1000mA and 3000mA.

What is a CBR?

Integral CBR – “circuit breakers... which incorporate the residual current function as an integrated feature”:

IEC 60947-2 Annex B.

In other words a CBR is a moulded-case circuit breaker equivalent of a DIN-modular RCBO – it includes overload, short-circuit and residual current protection inside a single device.

How can a CBR give me a cost advantage?

When CBR is used as the supply connection device and is set to 30 mA, RCBOs are not required on outgoing load circuits for electric shock protection (unless discrimination is required).

The residual current protection provided by the supply connection device covers all load circuits. MCBs may be used to protect load circuits and the installation will still meet the requirements for electric shock protection “RCD”



Moulded Case Products for Special Applications

Switch-Disconnectors



Every frame size includes a switch-disconnector version without integral protection. Internal and external accessories are compatible with switch-disconnector versions.



Circuit Breakers and Switch Disconnectors up to 1000V DC



We have developed special version of MCCBs to protect systems with DC voltages above 250V. Our range extends to 1000V DC and are often used to protect solar energy plants.



Circuit Breakers with Icu=70kA at 690V AC



High performance at the distribution voltages found in marine applications. Terasaki supply more switchgear to ships than any other manufacturer worldwide.



Circuit Breakers and Switch Disconnectors for 800V and 1000V AC



High AC voltages are used to minimise cable costs for installations where long cable runs are necessary. Terasaki supply MCCBs and switch-disconnectors for large solar farms, mines and railways. The latest addition to our range is the VE400-NE which can interrupt 30kA at 800V AC.



Low Instantaneous



The available short-circuit output of generators is lower than typical transformers. Sometimes MCCBs with sensitive instantaneous protection are necessary for use with generators.





MCCB Accessories

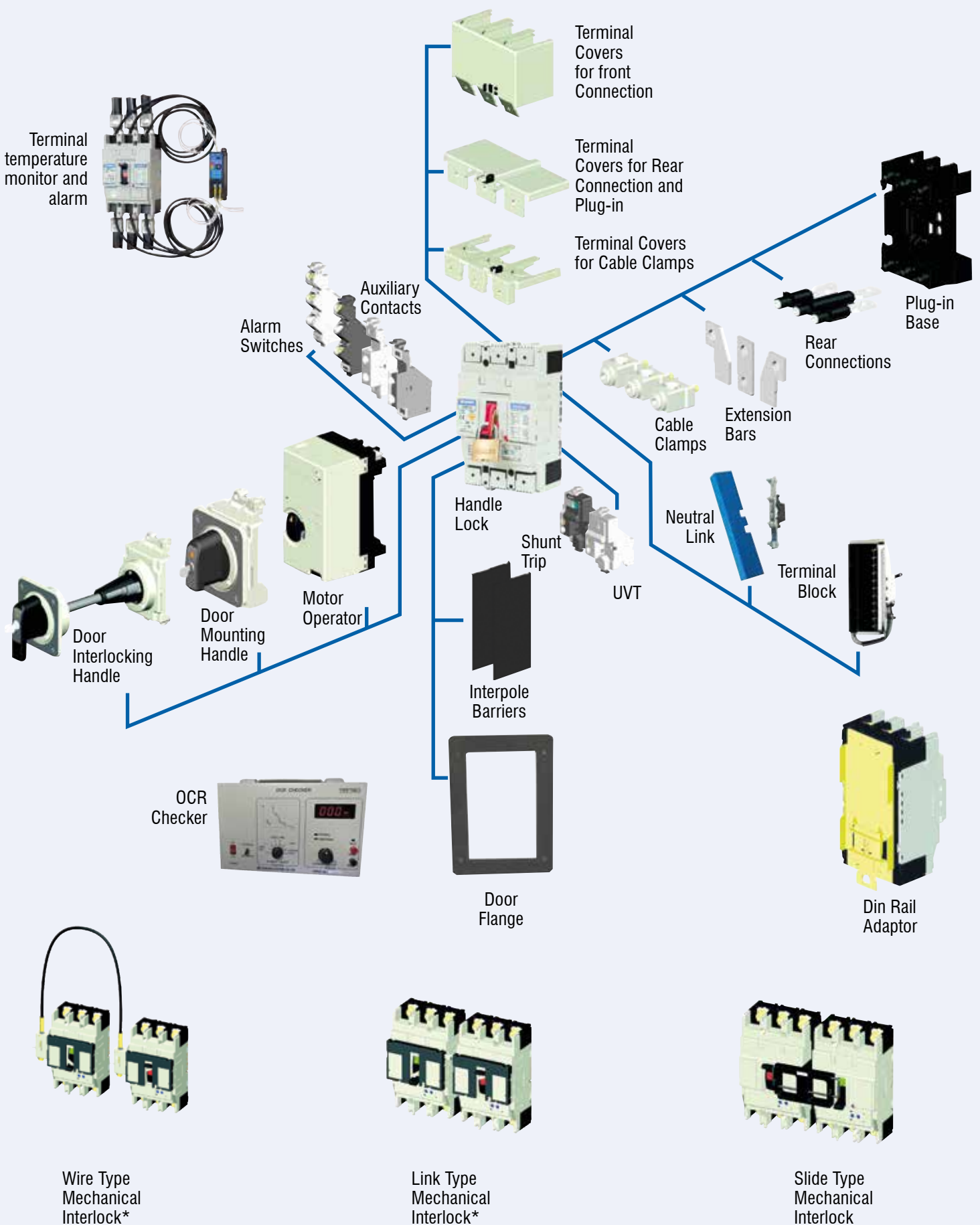

*Compatible with motor operator or either handle.



5 Reasons to use TemPower 2 ACBs



1. Patented High Performance 5000A and 6300A ACBs

The air circuit breaker interrupts the current at two points on the line side while dissipating heat from contacts or terminals by efficient air convection through pressure valve.

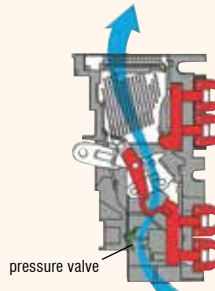

Efficient air convection through a pressure valve

2. Double opening and closing coils

Double Opening and Closing Coils provides extended control system redundancy to an ACB. Double coils allow designers to implement back-up tripping and closing systems. It provides the end-user with ultimate reliability on critical UPS circuits connected to critical loads.



3. Fast interruption by unique "Double Break" system*

The unique "DoubleBreak" main contact system ensures extremely fast interruption of short circuit currents and substantially reduces main contact wear. The internally symmetrical "DoubleBreak" structure means the moving contact is isolated from the supply voltage even when the ACB is reverse connected. TemPower 2 ACBs up to 4000A use DoubleBreak technology.

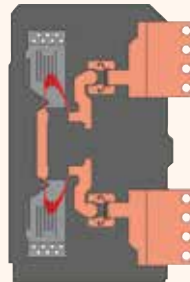

4. Easy Maintenance

The unique design of TemPower 2 incorporates its isolating clusters and main contacts on the ACB body. The main contacts and isolating clusters may be maintained without having to isolate the switchboard.



5. Replacement of the main contacts*

The fixed and moving contacts can easily be replaced in the field, thus prolonging the life on the circuit breaker. Changing each pole takes around 15 minutes.

*Not available on AR6



CUSTOMER ENDORSEMENT

"The performance of Terasaki's ACBs was proven on site when a main busbar failed in one of the switchrooms. The ACB was reclosed on the short-circuit fault twice during fault diagnosis and is still in operation following a service by Terasaki."

Andy Oswald, BAA
(Airport Operating Company, UK)



Air Circuit Breakers Selection Guide



TemPower 2 ACB

Frame Reference	Quantity	Unit	Condition	AR2			AR3		AR4	AR6
ACB Model				AR208, AR212, AR216	AR208, AR212, AR216, AR220	AR212, AR216, AR220	AR325, AR332	AR316, AR320, AR325, AR332	AR440	AR650, AR663
Type				D	S	H	S	H	SB	S
Number of Poles				3, 4	3, 4	3, 4	3, 4	3, 4	3, 4	3, 4
Nominal Current Ratings										
	I_n	A		800,1000,1250,1600	800,1000,1250,1600,2000	1250,1600,2000	2500,3200	1600,2000,2500,3200	4000	5000,6300
Electrical Characteristics										
Rated Operational Voltage	U_e	V		690	690	690	690	690	690	690
Rated Insulation Voltage	U_i	V		1000	1000	1000	1000	1000	1000	1000
Rated Impulse Withstand Voltage	U_{imp}	kV		12	12	12	12	12	12	12
Ultimate Breaking Capacity	I_{cu}	kA	690V AC	42 ^②	50 ^②	55	65 ^②	85	85 ^②	85 ^②
			440V AC	50	65	80	85	100	100	120
			400/415V AC	50	65	80	85	100	100	120
			250V DC ¹	40	40	40	40	40	40	40
Service Breaking Capacity	I_{cs}	kA	690V AC	32 ^②	50 ^②	55	65 ^②	85	85 ^②	85 ^②
			440V AC	36	65	80	85	100	100	120
			400/415V AC	36	65	80	85	100	100	120
			250V DC ¹	40	40	40	40	40	40	40
Making Capacity	I_{cm}	kA	690V AC	88 ^②	105 ^②	121	143	187	187 ^②	187 ^②
			440V AC	105	143	176	187	220	220	264
			400/415V AC	105	143	176	187	220	220	264
Rated Short-time Withstand Current	I_{cw}	kA	1 Second	50	65	80	85	100	100	120
			3 Seconds	36	50	55	65	75	75	85
Breaking Time		seconds		0.03	0.03	0.03	0.03	0.03	0.03	0.05
Spring Charging Time		seconds		10	10	10	10	10	10	10
Closing Time		seconds		0.08	0.08	0.08	0.08	0.08	0.08	0.08
Utilisation Category				B	B	B	B	B	B	B
Dimensions										
Fixed Type	Height	mm		460	460	460	460	460	-	-
	Width	mm	3 pole	360	360	360	466	466	-	-
	Width	mm	4 Pole	445	445	445	586	586	-	-
	Depth	mm		290	290	290	290	290	-	-
	Weight	kg	3 pole	53	54	54	80	80		
	Weight	kg	4 Pole	59	60	60	92	92		
Drawout Type	Height	mm		460	460	460	460	460	460	460
	Width	mm	3 pole	354	354	354	460	460	460	799
	Width	mm	4 Pole	439	439	439	580	580	580	1034
	Depth	mm		345	345	345	345	345	345	380
	Weight	kg	3 pole Drawout	73	79	79	105	105	126	200
	Weight	kg	4 Pole Drawout	86	94	94	125	125	158	285
Endurance										
Mechanical	Cycles		With maintenance	26000	30000	30000 ^③	20000	20000	15000	10000
Mechanical	Cycles		Without maintenance	12500	15000	15000 ^③	10000	10000	8000	5000
Electrical	Cycles		Without maintenance at 440V AC	11000	12000	12000 ^③	7000	7000	3000	1000
Electrical	Cycles		With maintenance at 440V AC	26000	30000	30000 ^③	20000	20000	15000	10000

Notes

1. Special versions are available for use at 600V and 800V DC. Contact us for details
2. Not applicable in unearthed (IT) systems
3. AR220S

Mechanical Endurance: with maintenance - 25000
without maintenance - 12000
Electrical Endurance: with maintenance - 25000
without maintenance - 10000



Protection Relay Guide

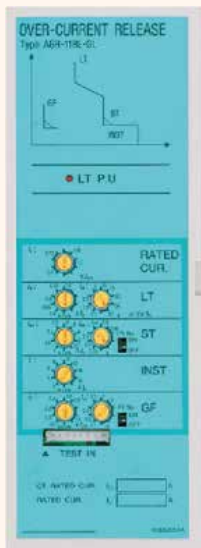

AGR-11B

Protection Functions Dial Adjustment

- L – Long Time
- S – Short Time
- I – Instantaneous

Optional Protection Functions

Unrestricted Ground Fault
Neutral Protection



Manual Reset (option)

AGR-11B-AS, AGR11BL-GS

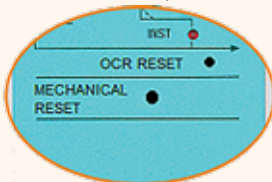

AGR-21B

Protection Functions LCD Ammeter

- L – Long Time
- S – Short Time
- I – Instantaneous
- Pre-Trip (load shedding)
- Fault Indication Contacts

Optional Protection Functions

Ground Fault (Unrestricted or Restricted)
Neutral Protection
Communication
Phase Rotation Protection
Generator Protection Curves
IDMT Protection Curves
Field Test



AGR-31B

Protection Functions Back-Lit Energy Meter

- L – Long Time
- S – Short Time
- I – Instantaneous
- Pre-Trip (load shedding)
- Fault Indication Contacts

Optional Protection Functions

Ground Fault (Unrestricted or Restricted)
Neutral Protection
Under/Over Voltage Alarm
Reverse Power
Zone Interlocking
Contact Temperature Monitoring
Communication
Phase Rotation Protection
Under/Over Frequency
Earth Leakage
Harmonic Monitoring
Generator Protection Curves
IDMT Protection Curves
Field Test

Non-Automatic (switch-disconnector) versions without protection are available in every frame size.



TemPower 2 ACBs for 800V and 1000V AC

High AC voltages are used to minimise cable costs for installations where long cable runs are necessary. Terasaki supply ACBs for large solar farms, mines and railways. The latest additions to our range are the AR316H-V8, AR320H-V8, AR325H-V8 and AR332H-V8, which can all interrupt 30kA at 800V AC.



TemPower 2 AR332H-V8 ACB



ACB Accessories

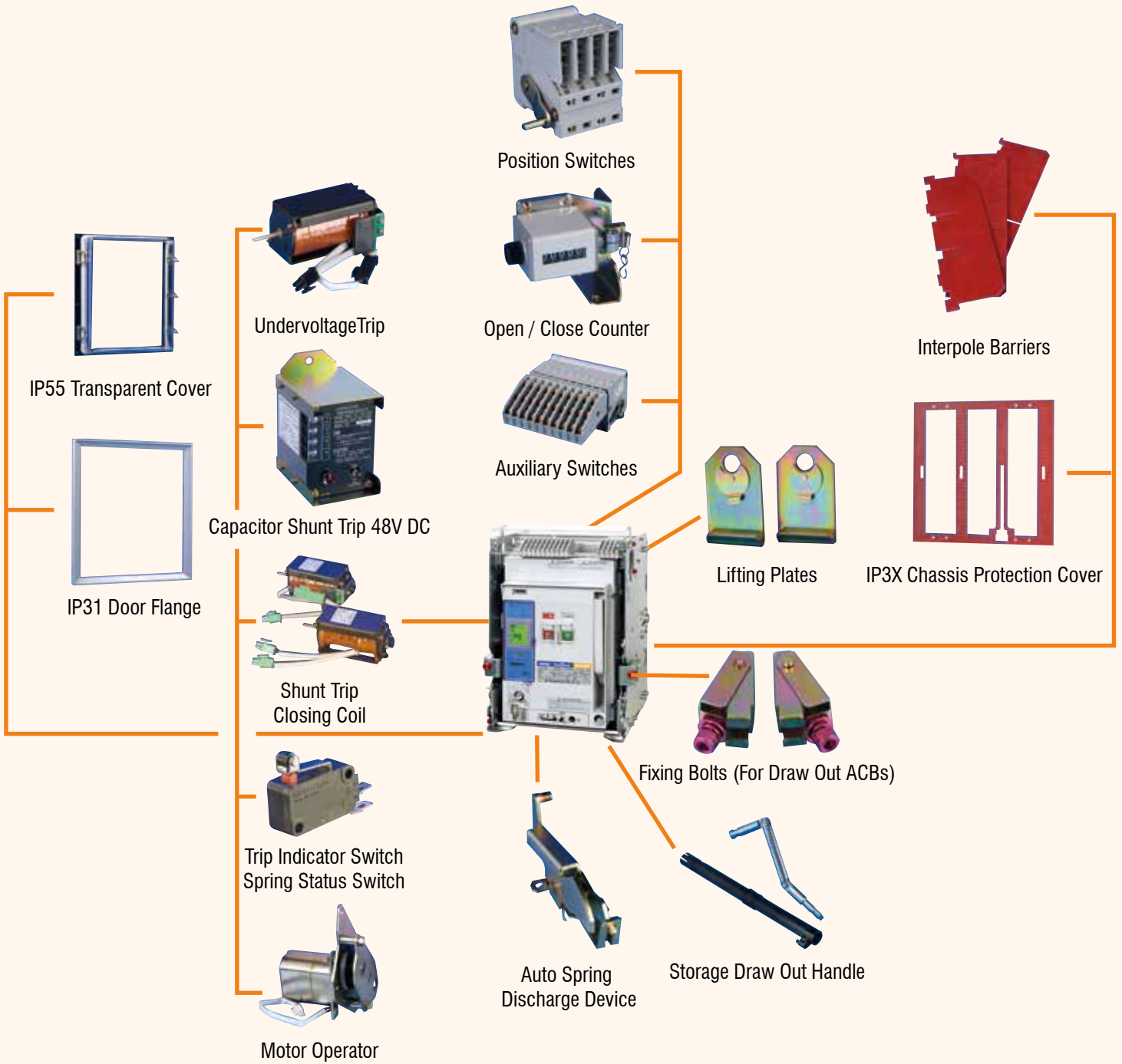

Lifter Loader



Protection Relay Checker



Tropicalisation, Anti-Corrosion, Cold Climate treatments



Test Jumper

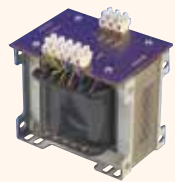

Step Down Transformer 440V to 220V

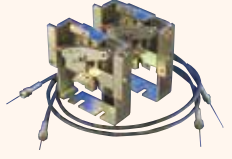

Mechanical Interlock, Key Interlock, Castell Interlock



Retrofit Concept

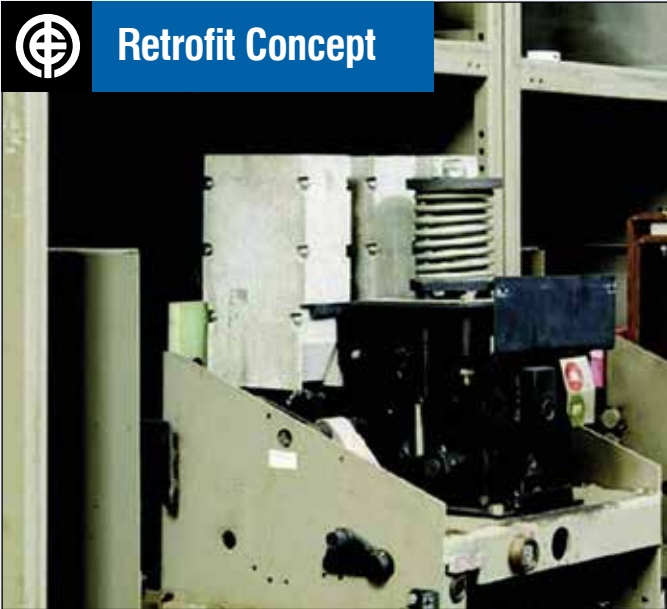

Retrofitting refers to the addition of new technology to older systems. Retrofit ACBs can replace ageing, unsafe switches and circuit breakers.

Top 5 reasons to use Retrofit

- 1. Improve safety and functionality**
Modern circuit breakers offer safer interlocks, remote switching and circuit monitoring.
- 2. Optimise existing plant**
Static components in a switchboard (the steelwork and busbar system) can be retained. Only the functional, moving parts (the circuit breakers) are replaced. Retrofitting is typically 80% cheaper than switchboard replacement with minimum downtime.
- 3. Guaranteed spares availability**
Terasaki guarantee spare parts availability for at least 10 years after the withdrawal from sale of a circuit breaker.
- 4. Modernise the protection system**
Old protection relays can be removed and replaced with modern microprocessor protection which is integral to the ACB. It is then easier to interface the ACB with automatic plc controls.
- 5. Reduce arc flash hazard**
Modern ACBs clear short-circuits much faster than older types. This means that the incident arc energy is correspondingly lower.

Retrofit Services

Terasaki's Retrofit Services

We prefer to conduct a site survey for every retrofit project - even if the breaker to be replaced is already on our design database. This ensures that the installation is as quick as possible, with minimum disruption to the client's supply.

Mechanical and electrical interfaces are modelled using state-of-the-art 3-D CAD.

Manufacture, assembly and routine testing is carried out at Terasaki's facility in Glasgow, Scotland. The factory and processes are certified to the ISO 9001 quality management standard.

Some of our Retrofit designs can be installed without a shutdown. Where this is not possible, our team will ensure that disruption is minimised.

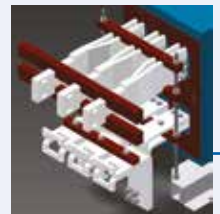

Verified Designs

Third Party Technical Report.

Tested to current standard

ASTA tested to IEC 61439 for short-circuit withstand (Icw)
GEC MPact
Ellison
English Electric

Low voltage arc hazard reduction

1. Remove switching using umbilical cord controller
2. Faster opening time reduces incident arc energy. TemPower 2 ACB can be set to open a short-circuit in less than 30 milliseconds (typically at least twice as fast as the device it will replace).

Modern protection

The AGR Protection relay can replace the functions of several devices in an existing switchboard to provide:

- restricted earth fault protection
- overcurrent protection
- data communication to BMS or SCADA
- plc control

We design retrofit ACBs on request. If you are interested in a brand which is not shown below we would be happy to examine it. New designs are continually added to our portfolio. Check the latest list on the Terasaki website: www.terasaki.co.uk

- Terasaki
- Ellison
- GEC
- Merlin Gerin
- Siemens
- Unelec
- Square D
- Mitsubishi
- Sace
- ABB
- Hyundai
- AEG
- English Electric
- MEM
- Klockner Moeller



Retrofit Case Study

Terasaki Retrofit Project Reference

Client: Royal Bank of Canada
Project: Retrofit
Location: 71 Queen Victoria Street, London
Retrofit: 24 x Merlin Gerin Selpact 1000A
 3 x Merlin Gerin DA 4000A
Type: to TemPower 2

Capability:

- 27 circuit breakers replace by TemPower 2 retrofit ACBs
- Only one week-end shutdown
- No disturbance to switchboard or copperwork
- Safe and fast



Direct Response Engineer Installing Retrofit ACB

REPLACEMENT OF 27 MERLIN GERIN ACBS WITH TERASAKI ACBS

The main electrical incomer to Royal Bank of Canada’s UK headquarters in London was tripping spuriously and engineers became worried that a sudden and complete failure of the power supply could result. The faulty device, a Merlin Gerin DA 4000 ACB, was obsolete and irreparable. 26 other Selpact and DA 4000 ACBs in the switchboard were also obsolete.

Engineers had permission to shut down the main power supply for only one weekend – not long enough for the switchboard to be replaced or for any modifications to be made to the copperwork.

Terasaki’s Direct Response Service Division had what they needed: a retrofit solution. The Terasaki TemPower 2 retrofit ACBs were designed to match the connections and mountings of the existing ACBs exactly. There was no need to modify the switchboard and all 27 ACBs were replaced safely and quickly.

Retrofit Details

- Merlin Gerin DA 4000 x 3
- Merlin Gerin Selpact x 24
- Building power down: 10:00 Friday
- 27 Terasaki TemPower 2 retrofit ACBs installed
- Building re-energised 12:00 Sunday



DA 4000 ACB:
Access Restricted Due to Nuisance Tripping



Obsolete Merlin Gerin Selpact ACBs



Spares Policy (Circuit Breakers)

Terasaki guarantees availability of breaker spare parts for at least 10 years after the breaker’s withdrawal from sale. Beyond that period the Direct Response Service Division will continue to support older products in the field carrying out routine maintenance and repairs on-site.

The Direct Response Service Division can provide a recommended spares list, based on the specification of all breakers on site. We usually recommend a combination of “complete” and “component” spares.

Warranty Extension

Terasaki offers one year standard warranty for our breakers. However you can extend it up to 4 or 5 years depending on project requirements.





Monitoring and Communication: T2ED

T2ED is a new Terasaki external display for TemPower 2 ACBs and TemBreak 2 MCCBs. It displays circuit measurements and information about the installed breaker in an easily readable way. T2ED may be used as a stand-alone local display. T2ED is also able to transfer all this information directly to a Modbus network.

Special Features:

View circuit values and breakers data safely from the outside

- Easy direct connection from breaker to T2ED (no need for communication module)
- Easy direct connection from T2ED to Modbus (no need for communication module)
- Analogue, numerical and bar graph views

Host Network / Commercial Gateway

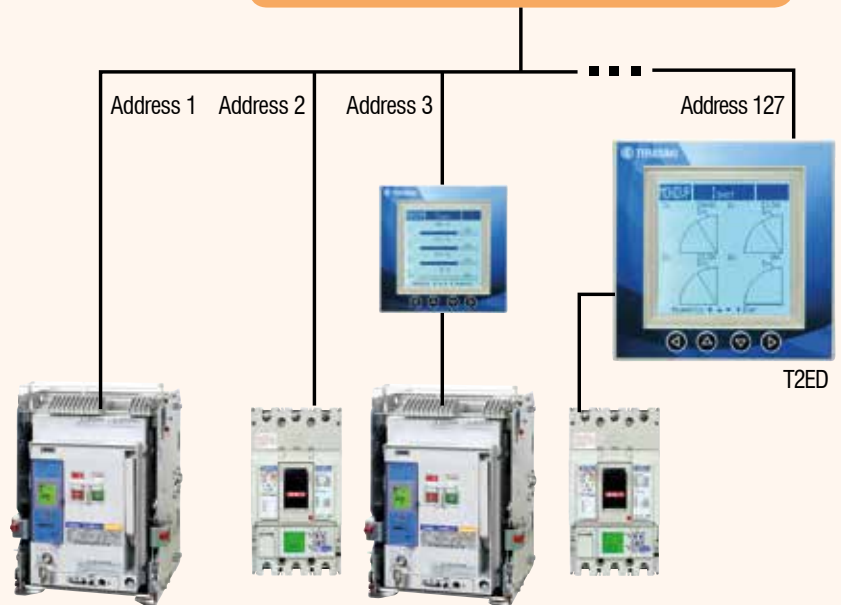

Technical Characteristics:

- Rated voltage: DC24V (Applicable range of voltage: DC18 to DC 31V)
- Consumption (at DC24V): 50mA
- Dimensions (96 x 96 x 50) mm
- Serial Interface: RS485
- Protocol: Modbus-RTU
- Transmission method: Two-wire half duplex

Multi-Protection Relay: TemTrip 2

TemTrip2 is a multi-protection relay for medium or low voltage circuit breakers that is capable of indicating via LEDs that the load current is picked up or the breaker trips open and showing various information including the phase current, line voltage and fault current on the LCD.



The relay is available in three types: for generator protection, feeder circuit protection and transformer protection.

		PRR-1H-G	PRR-1H-F	PRR-1H-T
		Generator protection	Feeder circuit	Transformer protection
Adjustable long time-delay trip	LT	○	○	○
Adjustable short time-delay trip	ST	○	○	○
Adjustable instantaneous trip	INST	○	○	○
Adjustable undervoltage trip	UV(27)	○	◆	—
Adjustable overvoltage trip	OV(59)	○	◆	—
Adjustable reverse power trip	RP(67R)	○	—	—
Adjustable ground fault trip	Overvoltage ground OVGR(64)	○	○	○
	Directional ground DGR(67G)	○	○	○
Ratio differential trip	DIFF(87G)	○	—	—
	(87T)	—	—	○
Pre-trip alarm	(PTA)	○	○	○
	PTA2	○	—	—

○ Standard ◆ Optional

Special Features:

- Multi-protection
- Ground fault detection via zero-phase voltage
- Directional ground fault detection
- Ratio differential characteristic
- Reverse power trip
- Readout of trip/ alarm cause
- Internal clock
- Self-diagnostic



TemContact 2 Contactors

TemContact 2 is a range of magnetic contactors and thermal overload relays. Current ratings from 6A to 800A are available in 9 frame sizes and in 3 or 4 pole versions.

TemContact 2 has upgraded insulation voltage (increased from 690 to 1000V AC) impulse withstand voltage (increased from 6 to 8kV) in contactors over 40A.

Optional Accessories:

- Auxiliary contacts
- Surge absorption unit
- Reversing connection kit
- Mechanical interlock
- Safety cover for front of mechanism
- Overload relays
- Remote mounting kit for overload relay
- Pre-loading resistors for capacitor switching (Any TemContact 2 Contactor can be converted to capacitor duty by adding capacitor unit)
- Mechanical latch
- Remote reset device for overload relays



TemContact 2 Manual Motor Starters

TemContact 2 Manual Motor Starters have integrated short-circuit and overload protection for motors of up to 45kW at 400V AC.

There are three frame sizes, each with three versions which cover the range:

- TMS32S, TMS63S, TMS100S – standard short-circuit performance
- TMS32H, TMS63H, TMS100H – high short-circuit performance
- TMS32HI, TMS63HI, TMS100HI – high short-circuit performance, without overload protection

Optional Accessories:

- Auxiliary switches for front- and side-mounting
- Alarm switches
- Shunt trip
- Undervoltage Trip
- Direct connection adapter for TemContact 2 contactors up to 100A





Contactors Selection Guide 3P



Model	Parameter	Unit	TC-9b	TC-12b	TC-18b	TC-22b	TC-32a	TC-40a	TC-50a	TC-65a
Frame size			22 AF				40 AF		65 AF	
Current and power ratings										
Thermal current	AC1	A	25	25	40	40	50	60	70	100
Switching power	200/240V AC3	kW	2.5	3.5	4.5	5.5	7.5	11	15	18.5
Switching current	200/240V AC3	A	11	13	18	22	32	40	55	65
Switching power	380/440V AC3	kW	4	5.5	7.5	11	15	18.5	22	30
Switching current	380/440V AC3	A	9	12	18	22	32	40	50	65
Switching power	500/550 AC3	kW	4	7.5	7.5	15	18.5	22	30	33
Switching current	500/550 AC3	A	7	12	13	20	28	32	43	60
Switching power	690V AC3	kW	4	7.5	7.5	15	18.5	22	30	33
Switching current	690V AC3	A	6	9	9	18	20	23	28	35
Electrical characteristics										
Rated operational voltage	U_e	V	690				690		690	
Rated insulation voltage	U_i	V	690				1000		1000	
Rated frequency	f	Hz	50/60				50/60		50/60	
Rated impulse withstand voltage	U_{imp}	kV	6				8		8	
Operation										
Maximum operating rate Endurance	AC3	ops/hr	1800				1800		1800	
	Mechanical	million	15				15		12	
	Electrical	million	2.5				2.5		2	
Dimensions										
AC Control	Weight	kg	0.34				0.55		1.05	
	Size (WxHxD)	mm	45 x 73.5 x 86				69 x 83 x 93		79 x 106 x 119	
DC Control	Weight	kg	0.51				0.77		1.3	
	Size (WxHxD)	mm	45 x 73.5 x 104				69 x 83 x 120		79 x 106 x 147	
NEMA size			00	00	0	1	1	1	2	2
Auxiliary Contacts										
Auxiliary Contacts (included as Standard)			1NO 1NC				2NO 2NC		2NO 2NC	

TK Type Thermal Overload relays



Model	Parameter	Unit	TK-32	TK-32	TK-63
Electrical Characteristics					
Rated operational voltage,	U_e	V	690	690	690
Rated insulation voltage	U_i	V	690	690	690
Rated impulse withstand voltage	U_{imp}	kV	6	6	6
Setting range					
Setting range		A	0.1~40	0.1~40	4~65
Trip class			10A,20	10A,20	10A,20
Dimensions					
	Weight	kg	0.17	0.17	0.31/0.33
	Size (WxHxD)	mm	45 x 75 x 90	45 x 75 x 90	55 x 81 x 100



TC-75a	TC-85a	TC-100a	TC-130a	TC-150a	TC-185a	TC-225a	TC-265a	TC-330a	TC-400a	TC-500a	TC-630a	TC-800a
100 AF			150 AF		225 AF		400 AF			800 AF		
110	135	160	160	210	230	275	300	350	450	580	660	900
22	25	30	37	45	55	75	80	90	125	147	190	220
75	85	105	130	150	185	225	265	330	400	500	630	800
37	45	55	60	75	90	132	147	160	200	265	330	440
75	85	105	130	150	185	225	265	330	400	500	630	800
37	45	55	60	70	110	132	147	160	225	265	330	500
64	75	85	90	100	180	200	225	280	350	400	500	720
37	45	55	55	55	110	140	160	200	250	300	400	500
42	45	65	60	60	120	150	185	225	300	380	420	630
690			690		690		690			690		
1000			1000		1000		1000			1000		
50/60			50/60		50/60		50/60			50/60		
8			8		8		8			8		
1800			1200		1200		1200			1200		
12			5		5		5		2.5		2.5	
2			1		1		1		0.5		0.5	
1.9			2.4		5.4		9.2			22.4		
94 x 140 x 137			119 x 158 x 132		138 x 203 x 185		163 x 243 x 205			285 x 312 x 245		
2.8			2.3		5.4		9.2			22.4		
94 x 140 x 172.3			119 x 158.5 x 132		138 x 203 x 185		163 x 243 x 205			285 x 312 x 245		
2	3	3	3	4	4	4	5	5	5	6	6	7
2N0 2NC			2N0 2NC		2N0 2NC		2N0 2NC			2N0 2NC		

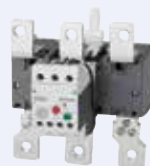

TK-95	TK-150	TK-225	TK-400	TK-800
690	690	690	690	690
690	690	690	690	690
6	6	6	6	6
7~100	34~150	64~240	85~400	200~800A
10A,20	10A,20	10A,20	10A,20	10A,20
0.48/0.5	0.67	2.5	2.6	11.5
70 x 97 x 110	95 x 109 x 113	147 x 141 x 184	151 x 171 x 198	860 x 530 x 212



Contactors Selection Guide 4P



Model	Parameter	Unit	TC-6a/4	TC-9a/4	TC-12a/4	TC-18a/4	TC-22a/4	TC-32a/4	TC-40a/4	TC-50a/4	TC-65a/4	TC-75a/4	TC-85a/4
Frame size			18 AF				22 AF	40 AF		85 AF			
Current and power ratings													
Thermal current		A	25	25	25	40	40	50	60	80	100	110	135
Switching power	200/240V AC1	kW	9	9	9	15	15	18	22	30	37	41	51
Switching current	200/240V AC1	A	25	25	25	40	40	50	60	80	100	110	135
Switching power	380/440V AC1	kW	17	17	17	27	27	35	42	56	70	76	95
Switching current	380/440V AC1	A	25	25	25	40	40	50	60	80	100	110	135
Switching power	200/240V AC3	kW	2.2	2.5	3.5	4.5	5.5	7.5	11	15	18.5	22	25
Switching current	200/240V AC3	A	9	11	13	18	22	32	40	55	65	75	85
Switching power	380/440V AC3	kW	3	4	5.5	7.5	11	15	18.5	22	30	37	45
Switching current	380/440V AC3	A	7	9	12	18	22	32	40	50	65	75	85
Electrical characteristics													
Rated operational voltage	U_e	V	690				690	690		690			
Rated insulation voltage	U_i	V	690				690	690		1000			
Rated frequency	f	Hz	50/60				50/60	50/60		50/60			
Rated impulse withstand voltage	U_{imp}	kV	6				6	6		8			
Operation													
Maximum operating rate Endurance	AC3	ops/hr	1800				1800	1800		1800			
	Mechanical	million	15				15	15		12			
	Electrical	million	2.5				1	1		1			
Dimensions													
AC Control	Weight	kg	0.33				0.4	0.59		1.2			
	Size (WxHxD)	mm	45 x 73.5 x 82				47.2 x 80 x 86.8	59 x 83.5 x 94.5		91 x 123.5 x 117.8			
DC Control	Weight	kg	0.5				0.5	0.7		1.29			
	Size (WxHxD)	mm	45 x 73.5 x 97				47.2 x 80 x 113.2	59 x 83.5 x 121		91 x 123.5 x 117.8			
NEMA size			00	00	0	0	1	1	1	2	2	2	3
Aux Contacts													
Aux Contacts (Standard)			-				-	-		-			

Capacitor Unit



Capacitor Unit is connected to the terminals of the contactor to reduce the high inrush current.

Features of the Capacitor Unit (Pre-loading resistor):

- Damping resistor than can limit the inrush current up to $60 \times I_n$ is connector to the mechanism that closed earlier than the main contact of the contactor
- No heat loss by the serial resistor
- Eliminate the switching surge
- Improving the performance of the capacitor system



TC-100/4	TC-130a/4	TC-150a/4	TC-185a/4	TC-225a/4	TC-265a/4	TC-330a/4	TC-400a/4	TC-500a/4	TC-630a/4	TC-800a/4
225 AF					400 AF			800 AF		
160	165	250	300	330	360	420	500	650	750	900
57	60	76	87	100	115	135	160	245	255	310
150	155	200	230	260	300	350	420	630	660	800
106	110	142	165	185	215	250	300	450	470	570
150	155	200	230	260	300	350	420	630	660	800
30	37	95	55	75	80	90	125	147	190	220
105	125	150	185	225	265	330	400	500	630	800
55	60	75	90	132	147	160	200	265	330	440
105	120	150	185	225	265	330	400	500	630	800
690					690			690		
1000					1000			1000		
50/60					50/60			50/60		
8					8			8		
1200					1200			1200		
15					15			12		
0.8					0.5			2.5		
5.6					9.9			26.3		
175 x 203 x 185					206 x 243 x 205			346 x 310 x 244		
5.6					9.9			26.3		
175 x 203 x 185					206 x 243 x 205			346 x 310 x 244		
3	3	4	4	4	5	5	5	6	6	7
2N02NC					2N02NC			2N02NC		

Capacitor Unit

Operation Sequence:

Capacitor unit: **OFF**
 Contactor: **OFF**

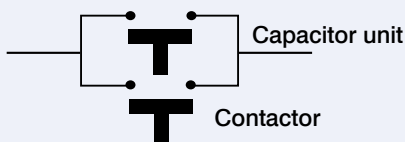

Capacitor unit: **ON**
 Contactor: **OFF**

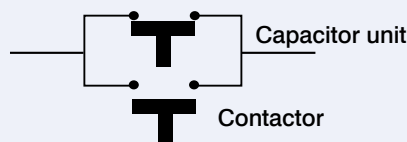

Capacitor unit: **OFF**
 Contactor: **ON**

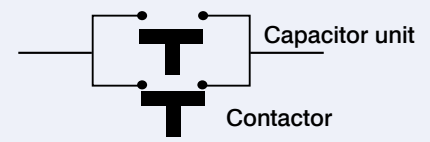



Manual Motor Starters Selection Guide

In accordance with IEC 60947 - 2 & IEC 60947 - 4 - 1

Manual Motor Starters													
Model	Parameter	Unit	Power rating at 400V AC (kW)	TMS -32S TMS -32H TMS -32HI*	Breaking Capacity @ 400/415V AC Icu / Ics (kA) TMS -32S	Breaking Capacity @ 400/415V AC Icu / Ics (kA) TMS -32H/HI	TMS -63S TMS -63H TMS -63HI*	Breaking Capacity @ 400/415V AC Icu / Ics (kA) TMS -63S	Breaking Capacity @ 400/415V AC Icu/Ics (kA) TMS -63H/HI	TMS -100S TMS -100H TMS -100HI*	Breaking Capacity @ 400/415V AC Icu / Ics (kA) TMS -100S	Breaking Capacity @ 400/415V AC Icu / Ics (kA) TMS -100H/HI	
Number of poles				3			3			3			
Frame size				32AF			63AF			100AF			
Current and Power													
Rated operational current (underlined) and protection setting range	I_e	(A)	0.02	0.1 ~ <u>0.16</u>	100/100	100/100							
			0.06	0.16 ~ <u>0.25</u>	100/100	100/100							
			0.09	0.25 ~ <u>0.4</u>	100/100	100/100							
			0.12	0.4 ~ <u>0.63</u>	100/100	100/100							
			0.25	0.63 ~ <u>1.0</u>	100/100	100/100							
			0.55	1.0 ~ <u>1.6</u>	100/100	100/100							
			0.75	1.6 ~ <u>2.5</u>	100/100	100/100							
			1.5	2.5 ~ <u>4</u>	100/100	100/100							
			2.2	4 ~ <u>6</u>	100/100	100/100							
			3	5 ~ <u>8</u>	100/100	100/100							
			4	6 ~ <u>10</u>	50/38	100/100	6 ~ <u>10</u>	100/100	100/100				
			5.5	9 ~ <u>13</u>	50/38	100/100	9 ~ <u>13</u>	50/38	100/100				
			7.5	11 ~ <u>17</u>	20/15	50/38	11 ~ <u>17</u>	25/19	50/50	11 ~ <u>17</u>	50/38	100/100	
			7.5	14 ~ <u>22</u>	15/11	50/38	14 ~ <u>22</u>	25/19	50/50	14 ~ <u>22</u>	50/38	100/50	
			11	18 ~ <u>26</u>	15/11	50/38	18 ~ <u>26</u>	25/19	50/50	18 ~ <u>26</u>	50/38	100/50	
			15	22 ~ <u>32</u>	15/11	50/38	22 ~ <u>32</u>	25/19	50/50	22 ~ <u>32</u>	50/38	100/50	
			18.5	28 ~ <u>40</u>	10/8	40/30	28 ~ <u>40</u>	25/19	50/50	28 ~ <u>40</u>	50/38	100/50	
			22				34 ~ <u>50</u>	25/19	50/50	34 ~ <u>50</u>	50/38	100/50	
			30				45 ~ <u>63</u>	25/19	50/50	45 ~ <u>63</u>	50/38	100/50	
			30				47 ~ 65	25/19	35/27				
			37							55 ~ <u>75</u>	50/38	75/50	
			45							70 ~ <u>90</u>	50/38	75/50	
			45							80 ~ <u>100</u>	50/38	75/50	
Electrical Characteristics													
Rated operational voltage	U_e	V			690			690			690		
Rated insulation voltage	U_i	V			690			690			1000		
Rated frequency	f	Hz			50/60			50/60			50/60		
Rated impulse withstand	U_{imp}	kV			6			8			8		
Utilisation category	IEC 60 947 - 2 (Breaker)				Cat. A			Cat. A			Cat. A		
	IEC 60 947 - 4 (Motor Starter)				AC 3			AC 3			AC 3		
Protection													
					Thermal magnetic (Except HI = Magnetic only)								
Operation													
Endurance	Mechanical				100,000			50,000			50,000		
	Electrical				100,000			25,000			25,000		
	Max operating frequency per hour				25			25			25		
Weight		g			320			360			1000		
Handle Type					Rocker	Rotary		Rotary			Rotary		
Terminal					Screw			Lug			Lug		
Accessories													
Optional (auxiliary , alarm contacts)					yes			yes			yes		

* TMS-**HI models have no overload protection or protection setting range. Rated operational current, I_e , (underlined) applies to TMS-**HI models



Automatic Transfer Controller

TemTransfer 2 Automatic Changeover Controller for TemPower 2 ACBs, TemBreak 2 MCCBs and TemContact 2 Contactors

TemTransfer 2 is fully configurable Automatic Changeover Controller (ACC) for use in standby power applications. The module will monitor the voltage and frequency of the incoming AC mains (utility) supply and in the event of a failure will issue a start command to the generator control system.

Once the generator set is available and producing an output within limits, TemTransfer 2 will control the circuit breaker or contactor and switch the load from the mains (utility) to the generating set.

When the mains (utility) supply returns to within limits, the module will command a return to the mains (utility) supply and shut down the generator after a suitable cooling run. Various timing sequences are available to prevent nuisance starting unnecessary supply breaks.

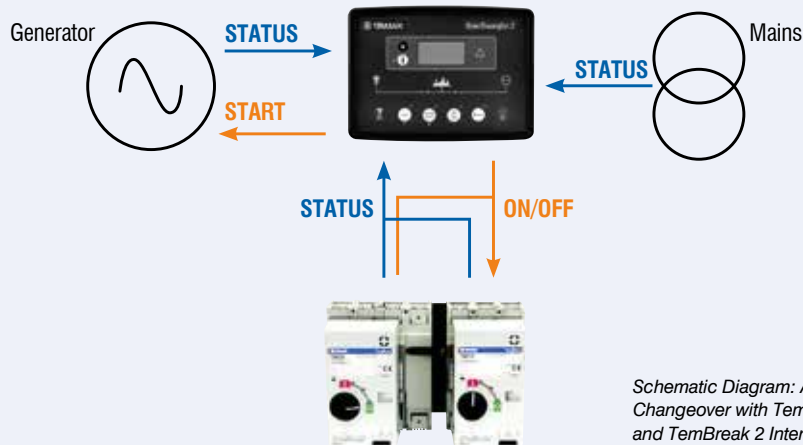

Schematic Diagram: Automatic Changeover with TemTransfer 2 and TemBreak 2 Interlocked MCCBs



Earth Leakage Protection Relays

Terasaki TemProtect monitoring and control devices provide earth leakage protection and monitoring for most industrial and commercial applications. They are used to monitor earth currents to protect electrical equipment and personnel against dangers such as electric faults.

TemProtect has been designed to be as flexible as possible to suit a wide range of applications. The range includes Din Rail, Panel or base mount versions, relays suitable for use in AC systems (unaffected by DC components which may be present).

All relays comply with international standards including IEC 60255.

ELR-1E



Flush mounted DIN 96x96x60mm unit

ELRC-1

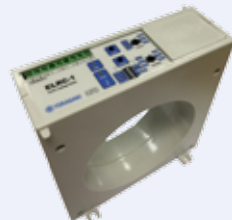

Relay with built-in Toroidal Transformer Space Saving

ELR-3C



DIN rail mounted unit (DIN 43880 standard) the three modules width 17.5mm

CTM



Supervision Relay monitors circuit breakers tripping circuit

- Adjustable tripping current and time delay setting
- Selectable automatic or manual reset facility
- Adjustable time/current multiplier setting
- Test button
- LEDs to indicate the units status



Safety and protection are the prime purposes of Terasaki products. Our range of DIN modular Protection products covers ratings from 0.5A to 125A and includes:

- Circuit breakers for overload and short-circuit protection,
- Residual current devices for the prevention of electric shock and fires,
- Circuit breakers combining overload, short-circuit and residual current protection.

With more than 500 items in the range, there is a solution for most applications.

Accessories

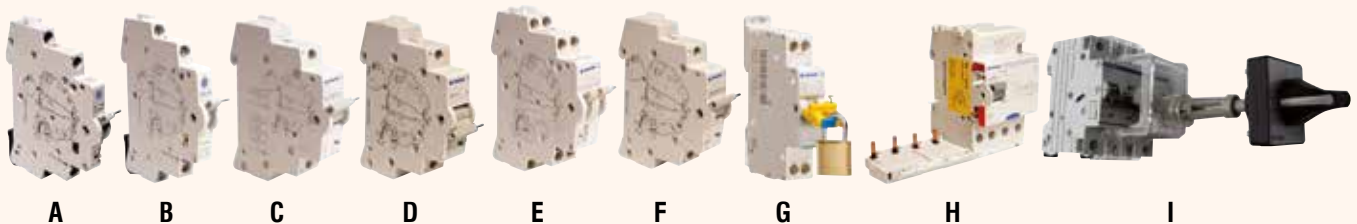

- A** Auxiliary contact 1NO, 1NC. 6A, 230V AC. Not suitable for TD3RCCB
- B** Alarm contact, 1NO, 1NC. 6A, 230V AC. Not suitable for TD3RCCB
- C** RCCB switch. Combined auxiliary contact (1NO, 1NC, 6A, 230V AC) + Alarm contact (1NO, 1NC, 6A, 230V AC)
- D** Shunt trip. RCCB switch (C) must be fitted before fitting the shunt trip to the TD3RCCB
- E** Undervoltage trip. RCCB switch (C) must be fitted before fitting the shunt trip to the TD3RCCB
- F** Overvoltage trip. Rated voltage, U_n , 230V AC. Opens the circuit breaker if supply voltage exceeds 280V AC. RCCB switch (C) must be fitted before fitting the shunt trip to the TD3RCCB
- G** Padlock. Suitable for TD3 M06, M10, XA (open and closed) and for TD31P1M (in open position only)
- H** Residual current block for TD3 M06 and M10
- I** Rotary handle for TD3 ICP



Din Modular Protection Selection Guide

Miniature Circuit Breakers

Type				MCB			MCB			MCB			MCB			MCB		
Model	Quantity	Unit		TD3 M06			TD3 M10			TD3 1P1M			TD3 XA			TD3 ICP		
Poles (Modules)				1 (1), 1+N (2), 2 (2), 3 (3), 3+N(4), 4 (4)			1 (1), 1+N (2), 2 (2), 3 (3), 3+N(4), 4 (4)			1+N (1)			1 (1.5), 2 (3), 3 (4.5), 4 (6)			1 (1), 2 (2), 3 (3), 4 (4)		
Electrical Characteristics																		
Standard				IEC/EN 60898			IEC/EN 60898			IEC/EN 60898			IEC/EN 60898 IEC/EN 60947-2			UNE EN 20317		
Nominal Rated Current	I_n	A		6, 10, 16, 20, 25, 32, 40, 50, 63			0.5*, 1*, 2*, 3*, 4*, 6, 10, 16, 20, 25, 32, 40, 50, 63			6, 10, 16, 20, 25, 32, 40			80, 100, 125			5, 7.5, 10, 15, 20, 25, 30, 35, 40, 45, 50, 63		
Rated Voltage	U_c	V		230/400 - 240/415			230/400 - 240/415			230/400 - 240/415			230/400 - 240/415			230/400 - 240/415		
Rated Frequency		Hz		50/60			50/60			50/60			50/60			50/60		
Breaking Capacity	I_{cn} (I_{cu})	kA		6			10			6			10 (10)			6		
Protection																		
Thermal- Magnetic Characteristic	Type			B, C			B, C, D			B, C			C, D			UNE EN 20317		
Connection																		
Rigid Conductor	Terminal	mm ²		25			35			16			70			25		
Flexible Conductor	Size	mm ²		16			25			10			35			16		
Dimensions																		
Per Module	HxDxW	mm		85 x 74 x 17.5			84 x 74 x 17.5			84 x 74 x 17.5			90 x 72 x 26.5			85 x 74 x 17.5		

*Only for "D" type

Residual Current Devices and Modular Switches

Type				RCCB			RCCB			RCBO			RCBO			Modular Switch			
Model	Quantity	Unit		TDURCCB			TDURCCB			TD3 RCBO			TDURCBO			TD3 MS			
Poles (Modules)				2 (2)			4 (4)			1+N (1)			1+N (2)			1 (1), 2 (2), 3 (3), 4 (4)			
Electrical Characteristics																			
Standard				IEC/EN 61008			IEC/EN 61008			IEC/EN 61009			IEC/EN 61009			IEC EN 60947-3			
Rated Sensitivity	$I_{\Delta n}$	mA		30	100	300	30	100	300	30		30	300						
Nominal Rated Current	I_n	A	AC type	25, 40, 63	40, 63, 100	25, 40, 63	25, 40, 63, 80, 100	25, 40, 63, 80, 100	25, 40, 63, 80, 100	6 - 40		6 - 40	6 - 40			32	63	100	125
	I_n	A	A type	25, 40, 63	-	-	25, 40, 63, 100	-	25, 40, 63, 100	-		-	-			-			
	I_n	A	Ai type	25, 40, 63	-	-	40	-	40	-		-	-			-			
	I_n	A	S type	-	-	40, 63	-	-	40	-		-	-			-			
Rated Voltage	U_n	V		230/400 - 240/415			230/400 - 240/415			230 - 240			230 - 240			230/400 - 240/415			
Breaking Capacity	I_{cn} (I_m)	kA		S (0.63) others: (0.8)			S (0.63) others: (0.8)			10			10			-			
Energy Withstand (EN 61008)	I_t	kA ² s		> 22.5			> 22.5			-			-			-			
Peak Current Withstand (EN 61008)	I_{peak}	kA		> 3			> 3			-			-			-			
Short-circuit Withstand Capacity	I_{cw} (rms)	kA		-			-			-			-			0.48 0.94 1.2 1.5			
Rated Frequency		Hz		50/60			50/60			50/60			50/60			50/60			
Protection																			
Thermal-Magnetic Characteristic	Type			-			-			B, C			C			-			
Connection																			
Rigid Conductor	Terminal	mm ²		25			25			16			25			25 50 50 50			
Flexible Conductor	Size	mm ²		25			25			10			25			16 35 35 35			
Dimensions																			
Per module	H x D x W	mm		85 x 68 x 17.5 (100A) 87.5x 68 x 18 (25-63A)			85 x 68 x 17.5 (100A) 87.5 x 68 x 18 (25-80A)			115 x 72 x 17.5			88 x 69 x 17.5			83 x 72 x 17.5			



TERASAKI

Innovators in Protection Technology

TERASAKI ELECTRIC (EUROPE) LTD.

80 Beardmore Way, Clydebank Industrial Estate,
Clydebank, Glasgow, G81 4HT, Scotland (UK)
Telephone: 44-141-941-1940
Fax: 44-141-952-9246
Email: marketing@terasaki.co.uk
<http://www.terasaki.com>

TERASAKI MIDDLE EAST

Saif Zone Q3-168, PO Box 120860
Sharjah, UAE
Telephone: 971-56-676-4825
Fax: 976-655-78141
Email: middleeast@terasaki.co.uk
<http://www.terasaki.com>

TERASAKI ELECTRIC (EUROPE) LTD. (FILIALE ITALIA)

Via Ambrosoli, 4A-20090, Rodano, Milano, Italy
Telephone: 39-02-92278300
Fax: 39-02-92278320
Email: info@terasaki.it
<http://www.terasaki.it>

TERASAKI ELECTRIC (EUROPE) LTD. (SUCURSAL EN ESPAÑA)

Pol. Ind. Coll de la Manyà, C/Cal Ros dels Ocells 5
08403 Granollers, (Barcelona) España
Telephone: 34-93-879-60-50
Fax: 34-93-870-39-05
Email: terasaki@terasaki.es
<http://www.terasaki.es>

TERASAKI ELECTRIC (EUROPE) LTD. (FILIAL SVERIGE)

Snickarvägen 2, SE-132 38 SALTSJÖ-BOO, Sweden
Telephone: 46-8-556-282-30
Fax: 46-8-556-282-39
Email: info@terasaki.se
<http://www.terasaki.se>

TERASAKI CIRCUIT BREAKERS (S) PTD. LTD.

17 Tuas Street, Singapore, 638454
Telephone: 65-6744-9752
Fax: 65-6748-7592
Email: tecs@pacific.net.sg

TERASAKI ELECTRIC CO., LTD.

Head Office & Circuit Breaker Division
6-13-47 Kamihigashi, Hirano-ku,
Osaka 547-0002, Japan
Telephone: 81-6-6791-2763
Fax: 81-6-6791-2732
Email: int-sales@terasaki.co.jp
<http://www.terasaki.co.jp>

TERASAKI ELECTRIC (M) SDN, BHD.

Lot 3, Jalan 16/13D, 40000 Shah Alam,
Selangor Darul Ehsan, Malaysia
Telephone: 60-3-5549-3820
Fax: 60-3-5549-3960
Email: terasaki@terasaki.com.my

TERASAKI DO BRASIL LTDA.

Rua Cordovil, 259-Parada De Lucas,
21250-450, Rio De Janeiro-R.J., Brazil
Telephone: 55-21-3301-9898
Fax: 55-21-3301-9861
Email: terasaki@terasaki.com.br
<http://www.terasaki.com.br>

TERASAKI ELECTRIC (CHINA) LTD.

72 Pacific Industrial Park, Xin Tang Zengcheng,
Guangzhou 511340, China
Telephone: 86-20-8270-8556
Fax: 86-20-8270-8586
Email: terasaki@public.guangzhou.gd.cn

TERASAKI ELECTRIC GROUP SHANGHAI REPRESENTATIVE OFFICE

Room No. 1405-6, Tomson Commercial Building,
710 Dong Fang Road, Pudong, Shanghai,
200122, China
Telephone: 86-21-58201611
Fax: 86-21-58201621
Email: terasaki@vip.163.com



www.terasaki.com

CAT REF. 17-G00EN

©Copyright Terasaki Electric (Europe) Ltd 2017

Ratings and specifications are subject to change without notice.