

Micro Motion® Fork Density Meters

Direct insertion density meter

Rugged, accurate density and concentration measurement

- Continuous, real-time measurement in pipelines, bypass loops and tanks
- Accurate measurement of density ($\pm 1 \text{ kg/m}^3$) and concentration ($\pm 0.1\%$)
- Wide range of corrosion-resistant materials for aggressive liquid measurement

Superior multi-variable I/O, meter health, and application capabilities

- Hazardous-area approved, head-mounted transmitter that supports local configuration and display
- Internal diagnostics for fast verification of meter health and installation
- Application-specific factory configurations ensure fit-for-purpose operation

Installation flexibility and compatibility

- Optimized design – insensitive to vibration, temperature and pressure variations
- Unique direct insertion design in lengths of up to 4 m (13 ft)
- Supports multiple protocols for connection to DCS, PLC, and flow computers
- Optional stainless steel transmitter housing for corrosion resistance in harsh environments



Compact Density Meter

Peak performance
precision density meter

Fork Density Meter

Direct insertion
density meter

Gas Density Meter

Fiscal gas
density meter

Specific Gravity Meter

Gas specific gravity
meter

Fork Viscosity Meter

High performance multi-variable
viscosity meter

Heavy Fuel Viscosity Meter

Multi-variable marine and power
HFO viscosity meter

Micro Motion® Fork Density Meters

Micro Motion® fork density meters provide precision liquid density measurement in tank and pipeline applications. The fork density meters use vibrating fork technology to measure density directly, and can be used in process control where density is the primary control parameter for the end product or as an indicator of another quality control parameter, such as %solids or %concentration.

Application configurations

Integral HART I/O allows direct input of external temperature, pressure, and flow measurements to provide enhanced readings.

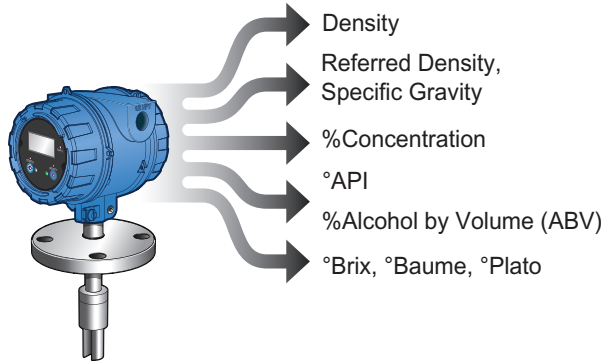

Retrofit capabilities

Full backwards compatibility that provides the same form and fit as the Micro Motion 7826/7828 direct insertion density meters.

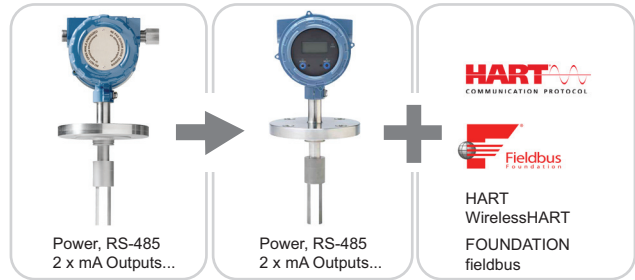

Integral transmitter

Supports Time Period Signal (TPS), Analog (4-20 mA), HART, WirelessHART®, Modbus RS-485 and FOUNDATION fieldbus™ communications.

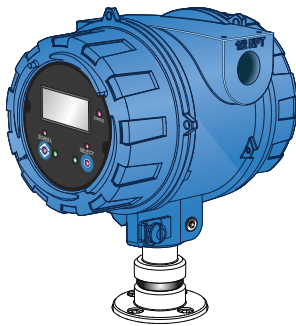

Interconnectivity

Integral HART I/O allows direct input of external temperature, pressure, and flow measurements for enhanced measurements.

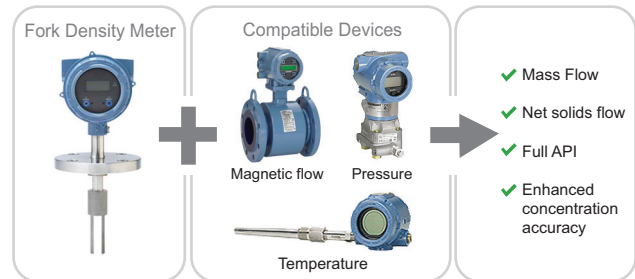

Meter diagnostics

Ensure measurement health through known density verification (KDV) and other meter and installation diagnostic capabilities.

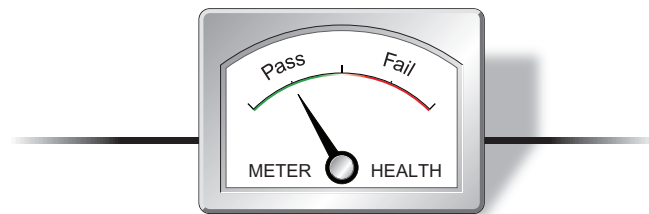

ProLink® III software

An easy-to-use interface that allows you to view key process variables and diagnostics data.

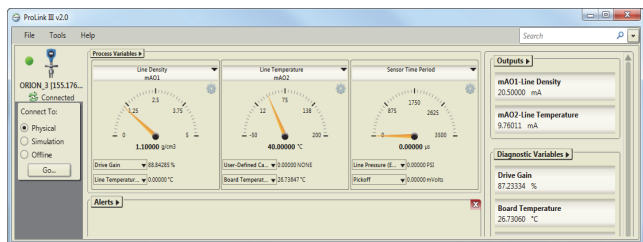

Operating principle

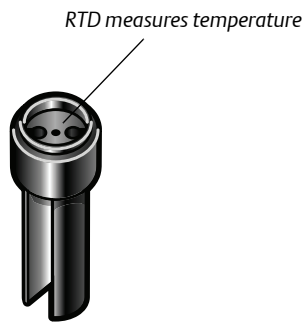
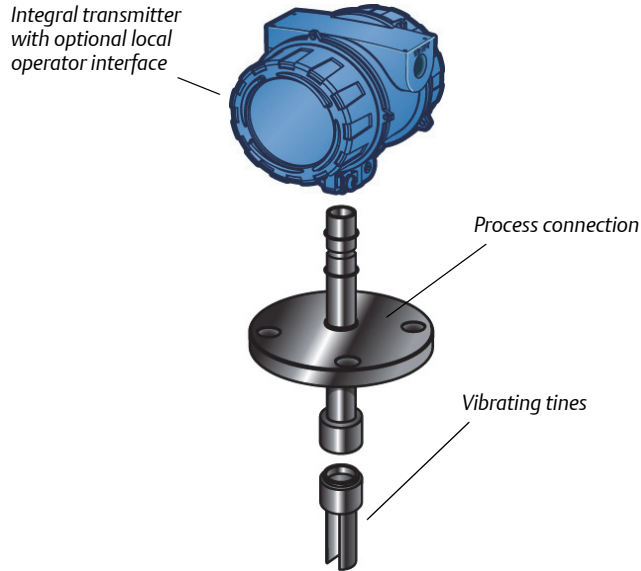

Vibrating fork technology

- A fully welded fork assembly is mounted directly into the liquid to be measured.
- The fork tines are vibrated piezo-electrically at its natural frequency.
- The tines' natural frequency changes with the density of the surrounding liquid.

Temperature measurement

- An integral class 'B' RTD measures the vibrating fork temperature.
- Micro Motion transmitters use this reading to optimize performance over a wide range of process conditions.

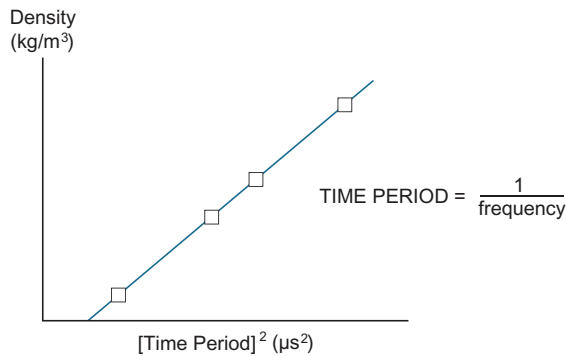

Density calibration

- Micro Motion transmitters accurately measure time period.
- Measured time periods are converted into density readings using meter calibration coefficients.

Performance specifications

Density measurement

Specification	Value	
Accuracy ⁽¹⁾	±1.0 kg/m ³	±0.001 g/cm ³
Operating density range ⁽²⁾	0–3000 kg/m ³	0–3 g/cm ³
Repeatability	±0.1 kg/m ³	±0.0001 g/cm ³
Process viscosity effect ⁽³⁾	<ul style="list-style-type: none"> ■ No effect for 0–50 cP ■ ±4 kg/m³ (±0.004 g/cm³) for 50–200 cP 	
Process temperature effect (corrected) ⁽⁴⁾	±0.1 kg/m ³ per °C	±0.0001 g/cm ³ per °C
Process pressure effect (corrected)	None	

(1) Stated accuracy is for calibrated range 600–1250 kg/m³ (0.6–1.25 g/cm³). Accuracy can be affected by the liquid viscosity. See the product configuration manual for more detail on entering an offset for the effects.

(2) The viscosity of the liquid can be up to a maximum of 500 cP.

(3) For viscosities between 200–500 cP, the process viscosity effect increases with the viscosity up to a maximum of ±19 kg/m³ (±0.019 g/cm³). This effect can be significantly reduced by performing an onsite calibration. Viscosity effect shown is for long tine (FDM1). For short tine (FDM2), no effect for 0–100 cP and reduced effect for 100–500 cP.

(4) Temperature effect is the maximum measurement offset due to process fluid temperature changing away from the factory calibration temperature.

Temperature measurement

Specification	Value	
Operating temperature range – short stem	–50 °C to +200 °C	–58 °F to +392 °F
Operating temperature range – long stem	–40 °C to +150 °C	–40 °F to +302 °F
Integral temperature measurement	<ul style="list-style-type: none"> ■ Technology: 100 Ω RTD ■ Accuracy: BS1904 Class, DIN 43760 Class B 	

Pressure ratings

Actual maximum operating pressures are limited by the process connection rating. For Zirconium flanges, the maximum operating pressure is dependent on the working temperature.

Specification	Value	
Maximum operating pressure – short stem ⁽¹⁾	207 bar	3000 psi
Maximum operating pressure – long stem	100 bar	1450 psi
Test pressure	Tested to 1.5 times the maximum operating pressure	
PED compliance	Not applicable	

(1) For short-stem meters with a cone seat fitting, the maximum operating pressure is 100 bar (1450 psi).

Transmitter specifications

Available transmitter versions

Typical application	Transmitter version ⁽¹⁾	Output channels		
		A	B	C
<ul style="list-style-type: none"> ■ General purpose measurement ■ DCS/PLC connection 	Analog	4–20 mA + HART (passive)	4–20 mA (passive)	Modbus/RS-485
	Processor for remote-mount 2700 FOUNDATION fieldbus™ transmitter	Disabled	Disabled	Modbus/RS-485
<ul style="list-style-type: none"> ■ General purpose measurement with output switch ■ DCS/PLC connection 	Discrete	4–20 mA + HART (passive)	Discrete output	Modbus/RS-485
<ul style="list-style-type: none"> ■ Flow Computer/Signal Converter connection 	Time Period Signal (TPS)	4–20 mA + HART (passive)	Time Period Signal (TPS)	Modbus/RS-485

(1) For more information on the transmitter outputs and ordering codes, see the product ordering information.

Local display

Design	Features
Physical	<ul style="list-style-type: none"> ■ Segmented two-line LCD screen ■ Can be rotated on transmitter, in 90-degree increments, for ease of viewing ■ Suitable for hazardous area operation ■ Optical switch controls for hazardous area configuration and display ■ Glass lens ■ Three-color LED indicates meter and alert status
Functions	<ul style="list-style-type: none"> ■ View process variables ■ View and acknowledge alerts ■ Configure mA and RS-485 outputs ■ Supports Known Density Verification (KDV) ■ Supports multiple languages

Process measurement variables

Variables	Value
Standard	<ul style="list-style-type: none"> ■ Density ■ Temperature ■ Drive gain ■ External temperature (when external device connected)
Derived	<p>The derived output variables vary, depending on the application configuration of the meter.</p> <ul style="list-style-type: none"> ■ Referred density (Concentration) ■ Referred density (API Tables 53A, 53B) ■ Specific gravity (Concentration) ■ %Alcohol ■ Alcohol proof ■ °API ■ °Balling ■ °Baume ■ °Brix ■ °Plato ■ %Mass ■ %Solids ■ °Twaddle ■ User-defined calculation output
Derived (when external device connected)	<ul style="list-style-type: none"> ■ Mass flow ■ Net solids flow ■ Enhanced concentration accuracy ■ Referred density (API Tables 53A, 53B with live pressure input) ■ Tank mass



















Additional communication options

The following communications accessories are purchased separately from the meter.

Type	Description
FOUNDATION™ fieldbus	Micro Motion® remote-mount Model 2700 transmitter with FOUNDATION fieldbus <ul style="list-style-type: none"> ■ One FOUNDATION fieldbus H1 connection provided.
WirelessHART®	Wireless HART is available via the THUM adapter
HART® Tri-Loop	Three additional 4–20 mA outputs are available via connection to a HART Tri-Loop

Hazardous area approvals

Ambient and process temperature limits are defined by temperature graphs for each meter and electronics interface option. Refer to the detailed approval specifications, including temperature graphs for all meter configurations, and safety instructions that can be found on the product page at the Micro Motion web site (at www.micromotion.com).

ATEX	
Zone 1 Flameproof	Without display (all transmitters)   0575  ■ II 1/2G Ex db IIC T6 Ga/Gb
	With display (Analog, TPS, Discrete versions with stainless steel transmitter housing material only)   0575  ■ II 1/2G Ex db IIC T6 Ga/Gb
	Remote connection to 2700 FOUNDATION fieldbus transmitters   0575  ■ II 1/2G Ex db [ib] IIC T6 Ga/Gb
Zone 2	Without display (All transmitter versions)    ■ II 3G Ex nA IIC T6 Gc
	With display (Analog, TPS, Discrete versions with aluminum housing only)    ■ II 3G Ex nA IIC T4 Gc
	With display (Analog, TPS, Discrete versions with stainless steel transmitter housing material only)    ■ II 3G Ex nA IIC T4 Gc

CSA	
Explosion proof	With display (Analog, TPS, Discrete versions with stainless steel transmitter housing material only) or without display (all transmitter versions) <ul style="list-style-type: none"> ■ Class I, Division 1, Groups C & D ■ Class I, Division 2, Groups A, B, C & D ■ Class II, Division 1, Groups E, F & G
Non-incendive	With display (Analog, TPS, Discrete versions) or without display (all transmitter versions) <ul style="list-style-type: none"> ■ Class I, Division 2, Groups A, B, C & D

IECEX	
Zone 1 Flameproof	Without display (all transmitters) <ul style="list-style-type: none"> ■ Ex db IIC T6 Ga/Gb
	With display (Analog, TPS, Discrete versions with stainless steel transmitter housing material only) <ul style="list-style-type: none"> ■ Ex db IIC T6 Ga/Gb
	Remote connection to 2700 FOUNDATION fieldbus transmitters: <ul style="list-style-type: none"> ■ Ex db [ib] IIC T6 Ga/Gb
Zone 2	Without display (all transmitter versions) <ul style="list-style-type: none"> ■ Ex nA IIC T6 Gc
	With display (Analog, TPS, Discrete versions with aluminum housing only) <ul style="list-style-type: none"> ■ Ex nA IIC T4 Gc
	With display (Analog, TPS, Discrete versions with stainless steel transmitter housing material only) <ul style="list-style-type: none"> ■ Ex nA IIC T4 Gc

Environmental specifications

Type	Rating
Electromagnetic compatibility	All versions conform to the latest international standards for EMC, and are certified compliant with EN 61326
Humidity limits	5 to 95% relative humidity, non-condensing at 140 °F (60 °C)
Ambient temperature	-40 °C to +65 °C -40 °F to +149 °F
Ingress protection rating	IP66/67, NEMA4 aluminum housing; NEMA4X stainless steel housing

Power requirements

Type	Description
DC Power requirements	<ul style="list-style-type: none"> ■ 24 VDC, 0.65 W typical, 1.1 W maximum ■ Minimum recommended voltage: 21.6 VDC with 1000 ft of 24 AWG (300 m of 0.20 mm²) power-supply cable ■ At startup, power source must provide a minimum of 0.5 A of short-term current at a minimum of 19.6 V at the power input terminals.

Physical specifications

Materials of construction

Component	Material
Wetted parts	Short-stem meter <ul style="list-style-type: none"> ■ 304 or 316L stainless steel ■ Alloy C22 ■ Titanium ■ Zirconium
	Long-stem meter <ul style="list-style-type: none"> ■ Alloy C22 for meters up to 6.5 ft (2 m) long ■ 316L stainless steel for meters up to 13 ft (4 m) long
Tine finish	Standard, DLC (Diamond-like carbon) ⁽¹⁾ coated, or electro-polished
Transmitter housing	Polyurethane-painted aluminum or 316L stainless steel

(1) DLC coating are applied only to the tines for anti-stick properties, not for corrosion protection.

Weight

Specification	Weight with aluminum housing	Weight with stainless steel housing
Weight – short stem (typical)	Approximately 15 lbs (7 kg)	Approximately 21 lbs (10 kg)
Weight – long stem	Dependent on stem length (contact Micro Motion)	

Dimensions

These dimensional drawings are intended to provide a basic guideline for sizing and planning. Complete and detailed dimensional drawings can be found through the product drawings link in our online store (www.micromotion.com/onlinestore).

Short-stem meter (standard tines)

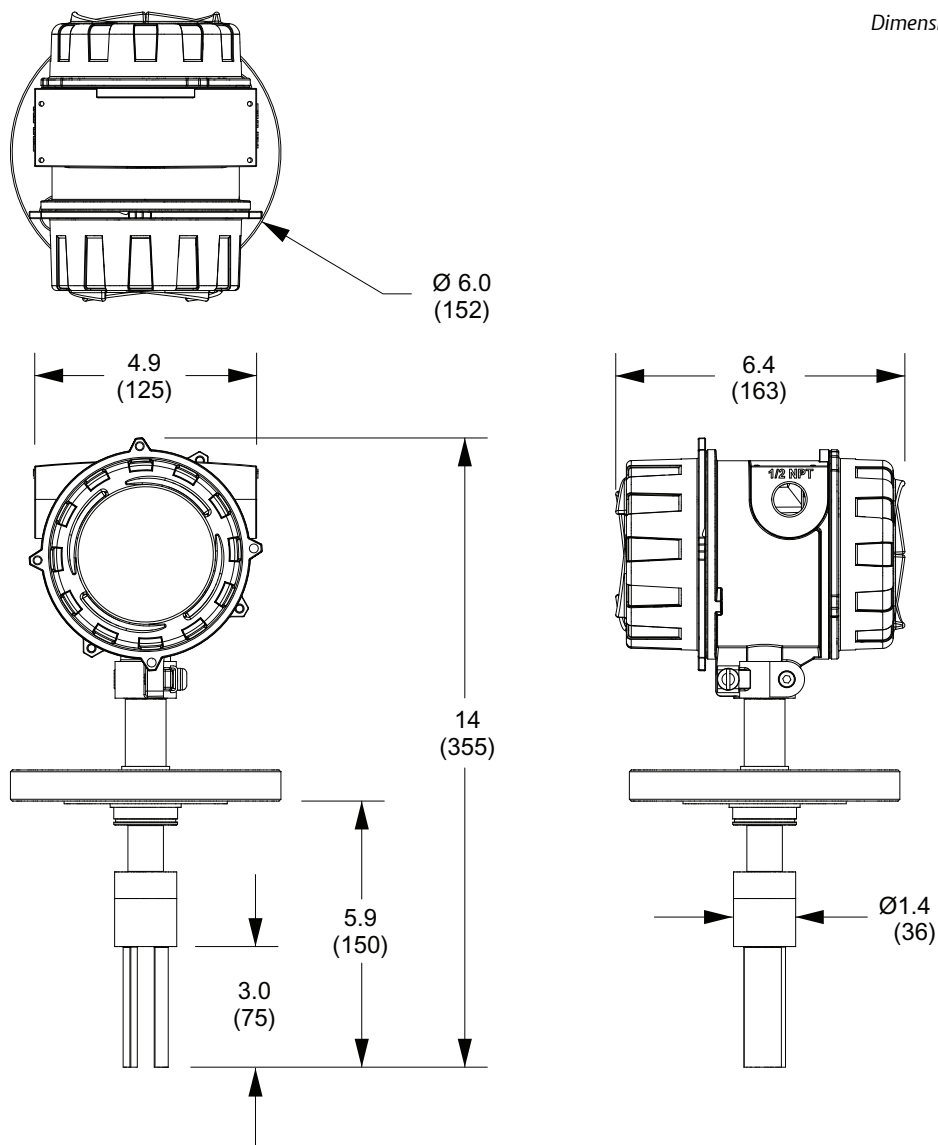

Note:

Diagrams include the 2-inch (51 mm) CL 150 flange.

Short-stem meter (short tines)

Dimensions in inches (mm)

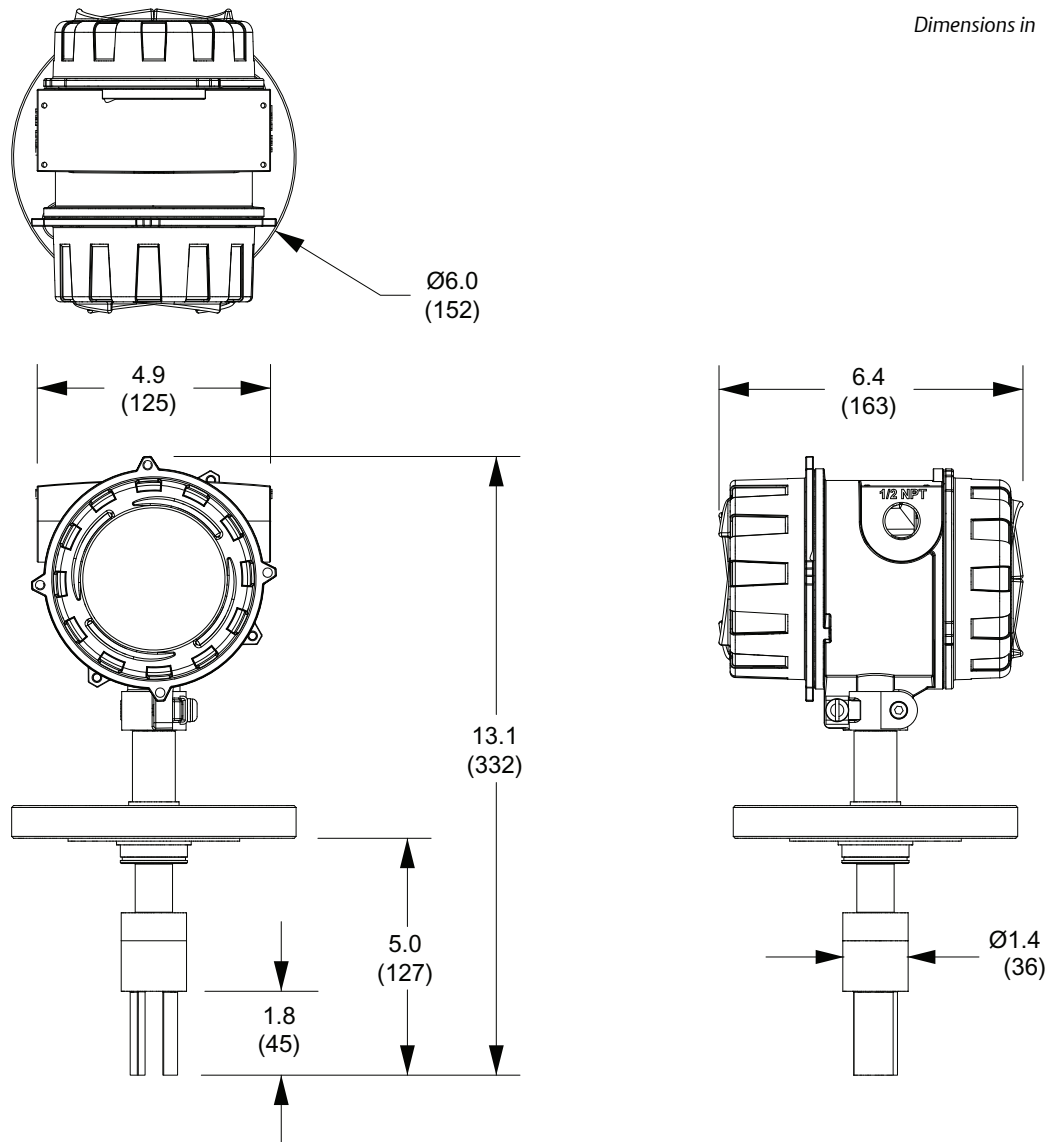

Note:
Diagrams include the 2-inch (51 mm) CL 150 flange.

Long-stem meter

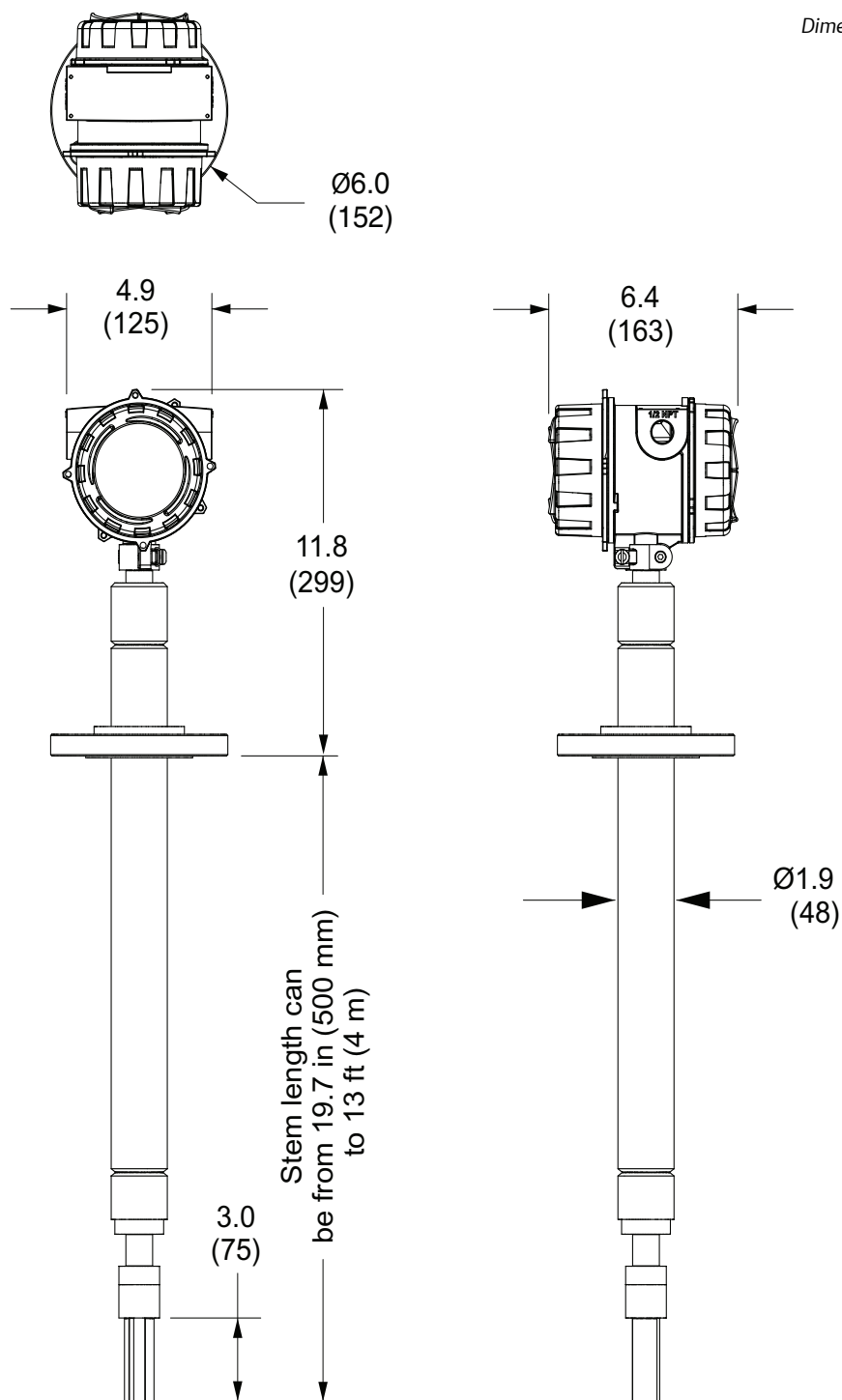

Dimensions in inches (mm)

Note: Diagrams include the 2-inch (51 mm) CL 150 flange.

Ordering information

Model	Description
FDM	Insertion Fork Density Meter

Code	Sensor calibration range and performance
1	Viscosity limit 500 cP, [Standard tine length: 75 mm (3 in) Standard - Accuracy $\pm 0.001\text{g/cc}$ ($\pm 1\text{ kg/m}^3$) over Density Range 0.6-1.25g/cc (600-1250kg/m ³)
2	Viscosity limit 20,000cP, [Short tine length = 45mm (1.8 in)] Standard - Accuracy $\pm 0.001\text{g/cc}$ ($\pm 1\text{ kg/m}^3$) over Density Range 0.6-1.25g/cc (600-1250kg/m ³)

Code	Stem length
1	0 mm: no stem extension and with standard spigot
2	500 mm (19.7 in) with removable transit cover
3	750 mm (29.5 in) with removable transit cover
4	1000 mm (39.4 in) with removable transit cover
5	1500 mm (59.1 in) with removable transit cover
6	2000 mm (78.7 in) with removable transit cover
X ⁽¹⁾	Special order (ETO) stem length — available up to 4 m (13 ft)

(1) Requires factory option X.

Code	Materials of wetted parts (including process connection)
Available with all stem length codes	
A	316L stainless steel, standard finish tines
C	316L stainless steel, electro-polished tines
L	316L stainless steel, DLC (diamond-like carbon) coated tines
E	Alloy C22, standard finish tines
Available with only stem length code 1 or X	
D	Alloy C22, electro-polished tines
V ⁽¹⁾⁽²⁾	304 stainless steel, standard finish tines
Available with only stem length code 1	
T ⁽¹⁾⁽³⁾	Titanium, standard finish tines
N ⁽¹⁾⁽³⁾	Zirconium, Zr 702 standard finish tines
X ⁽⁴⁾	Special order (ETO) Material of wetted parts

(1) Available with process connections 720, 721, 723, 724 and 999 only.

(2) With stem length X is available only with process connection 999.

(3) Not available with sensor calibration range and performance code 2.

(4) Requires factory option X.

Code	Process connections
Available with all stem length codes	
720	2-inch, CL150, ASME B16.5, blind flange, raised face
721	2-inch, CL300, ASME B16.5, blind flange, raised face
722	2-inch, CL600, ASME B16.5, blind flange, raised face
723	DN50, PN16, EN 1092-1, blind flange, Type B1
724	DN50, PN40, EN 1092-1, blind flange, Type B1
725	DN50, PN100, EN 1092-1, blind flange, Type B1
999 ⁽¹⁾	Special order (ETO) process connection
Available with only stem length code 1	
726	2-inch, CL900, ASME B16.5, blind flange, raised face
727	2-inch, CL1500, ASME B16.5, blind flange, raised face
728 ⁽²⁾⁽³⁾	3-inch, Tri-clamp compatible, ASME BPE, Hygienic flange
729	1-1/2 inch, Cone-seat compression fitting, 316/316L
740 ⁽⁴⁾⁽⁵⁾	3-inch, CL150, ASME B16.5, blind flange, raised face
741 ⁽⁴⁾⁽⁵⁾	3-inch, CL300, ASME B16.5, blind flange, raised face
743 ⁽⁴⁾⁽⁵⁾	DN80, PN16, EN1092-1, blind flange, raised face
744 ⁽⁴⁾⁽⁵⁾	DN80, PN40, EN1092-1, blind flange, raised face
Available with only stem length codes 2, 3, 4, 5, 6, or X	
730 ⁽⁶⁾	No connections (for open tanks)

- (1) Requires factory option X.
- (2) Available with only calibration types A or G.
- (3) Available with only materials of wetted parts codes A, C, F, and L.
- (4) Available with only calibration type E.
- (5) Available with only materials of wetted parts codes A, C, L and E.
- (6) Available with only approvals code M. Not available with HT Special Test Option.

Code	Sensor calibration types
Available with all stem lengths	
A	Free stream
B	2-inch schedule 40 boundary [Viscosity limits = 200 cSt (T piece), 1000 cSt (782791 Flow Through Chamber)]
D	2-inch schedule 80 boundary [Viscosity limit = 200 cSt (T piece)]
E ⁽¹⁾	3-inch schedule 80 boundary [Viscosity limit = 1000 cSt (T-Piece or 782791 Flow Through Chamber)]
X ⁽²⁾	Special order (ETO) calibration type
Available only with stem length codes 1 or X	
G ⁽³⁾	3-inch hygienic (viscosity limits = 1000 cSt)

- (1) For tine length 3-inches (75mm) (FDM 1), viscosity limit is 500 cSt.
- (2) Requires factory option X.
- (3) Available with only process connection 728.

Code	Transmitter housing option
A	Integral, aluminum alloy
B	Integral, stainless steel

Code	Transmitter outputs option
A ⁽¹⁾ (2) (3)	Integral processor for remote mount 2700 FOUNDATION™ fieldbus transmitter (Channels A and B inactive)
B	Integral transmitter, Channel B = Time Period Signal, Channel A = mA + HART, Channel C = Modbus/RS-485
C	Integral transmitter, Channel B = mA output, Channel A = mA + HART, Channel C = Modbus/RS-485
D	Integral transmitter, Channel B = Discrete output, Channel A = mA + HART, Channel C = Modbus/RS-485

- (1) Requires Model 2700 with mounting option H [4-wire connection option (power and communications)].
 (2) With transmitter output options code A, all signal outputs on the integrally mounted transmitter are disabled, except for the Modbus/RS-485 communications, which is used for communication to the Model 2700 transmitter.
 (3) Available only with application configuration code 00.

Code	Display option (available with all approval codes)
2 ⁽¹⁾ (2)	Two-line display (non-backlit)
3	No display

- (1) For transmitter housing option code A, available with only approval codes M, 2, V and 3.
 (2) Not available with transmitter output option code A.

Code	Approvals
M	Micro Motion standard (safe area – no approval)
A ⁽¹⁾	CSA (US and Canada) - Explosion-proof
F ⁽²⁾	ATEX - Zone 1 IIC flameproof
I ⁽²⁾	IECEX - Zone 1 IIC flameproof
2	CSA Class 1, Div 2 (US and Canada)
V	ATEX - Equipment category 3 (Zone 2)
3	IECEX - Zone 2
G	Country-specific approval – requires a selection from <i>Special tests and certificates, tests, calibrations and services (optional)</i>

- (1) For transmitter output options code A, CSA approvals code A (C1D1) is valid only for groups C and D.
 (2) For transmitter output options code A, approvals codes F & I indicate Exd [ib], not Exd.

Code	Application configuration ⁽¹⁾ (2)
Available with all wetted materials codes	
00	No application configuration
11	API degrees (Americas) (4mA = 0°, 20mA = 100°): (Process temperature = 0 °C to 60 °C)
12	Line density (4mA = 500kg/m ³ , 20mA = 1500kg/m ³): (Process temperature = -40 °C to +140 °C)
13	Referred density to API tables (metric) (4mA = 500kg/m ³ , 20mA = 1500kg/m ³): (Process temperature = -40 °C to +140 °C)
50 ⁽³⁾	% NaOH Concentration (4mA = 0%, 20mA = 50%): (Process temperature = 0 °C to 80 °C)
59 ⁽³⁾	% KOH Concentration (4mA = 0%, 20mA = 40%): (Process temperature = 0 °C to 90 °C)
XX ⁽⁴⁾	Special order (ETO) analog output configuration (customer data required)
Available with wetted materials codes A, C, F, L, E, D, and G only	
21	% Alcohol (4mA = 0%, 20mA = 20%): (Process temperature = 0 °C to 40 °C)
22	% Alcohol (4mA = 50%, 20mA = 100%): (Process temperature = 40 °C to 70 °C)
23	% Alcohol (4mA = 80%, 20mA = 100%): (Process temperature = 50 °C to 90 °C)
24	Alcohol proof (4mA = 100%, 20mA = 200%): (Process temperature = 5 °C to 70 °C)

Code	Application configuration ^{(1) (2)}
25	Alcohol proof (4mA = 160%, 20mA = 200%): (Process temperature = 50 °C to 90 °C)
26	% Methanol Concentration (4mA = 35%, 20mA = 60%): (Process temperature = 0 °C to 40 °C)
27	% Ethylene Glycol Concentration (4mA = 10%, 20mA = 50%): (Process temperature = -20 °C to 40 °C)
31	°Brix (sucrose) (4mA = 0°, 20mA = 40°): (Process temperature = 0 °C to 100 °C)
32	°Brix (sucrose) (4mA = 30°, 20mA = 80°): (Process temperature = 0 °C to 100 °C)
41	°Balling (4mA = 0°, 20mA = 20°): (Process temperature = 0 °C to 100 °C)
64	% HFCS - 42 (4mA = 0%, 20mA = 50%): (Process temperature = 0 °C to 100 °C)
65	% HFCS - 55 (4mA = 0%, 20mA = 50%): (Process temperature = 0 °C to 100 °C)
66	% HFCS - 90 (4 mA = 0%, 20 mA = 50%): (Process temperature = 0 °C to 100 °C)
71	°Plato (4mA = 0°, 20mA = 30°): (Process temperature = 0 °C to 100 °C)
Available with wetted materials codes A, C, F, L, E, D, G, and N only	
53	% H2SO4 Concentration (4mA = 0%, 20mA = 20%): (Process temperature = 0 °C to 24 °C)
Available with wetted materials codes E, D, and G only	
54	% H2SO4 Concentration (4mA = 0%, 20mA = 93%): (Process temperature = 0 °C to 38 °C)
Available with wetted materials codes E, D, G, and N only	
55	% H2SO4 Concentration (4mA = 0%, 20mA = 25%): (Process temperature = 0 °C to 50 °C)
Available with wetted materials codes A, C, F, L, E, D, and G only	
56	% H2SO4 Concentration (4mA = 75%, 20mA = 93%): (Process temperature = 24 °C to 38 °C)
Available with wetted materials codes N and A only	
57	% HNO3 Concentration (4mA = 0%, 20mA = 70%): (Process temperature = 0 °C to 50 °C)
Available with wetted materials code N only	
58	% HNO3 Concentration (4mA = 0%, 20mA = 100%): (Process temperature = 5 °C to 30 °C)
61	% HCl Concentration (4mA = 0%, 20mA = 5%): (Process temperature = 0 °C to 90 °C)
62	% HCl Concentration (4mA = 0%, 20mA = 32%): (Process temperature = 0 °C to 49 °C)
Available with all wetted materials and transmitter output options code B only	
96	Process temperature (4 mA = -50 °C, 20 mA = 200 °C)
97	Process temperature (4 mA = -50 °C, 20 mA = 150 °C)
98	Process temperature (4 mA = 0 °C, 20 mA = 100 C °F)

(1) When Transmitter Output Options code is C or D, the chosen Application configuration code 4mA & 20mA are programmed as the Channel A mA output 4mA and 20mA points.

(2) When Transmitter Output Options model code A is chosen, all signal outputs on the integrally-mounted transmitter are disabled apart from the RS485 modbus communications used for communication.

(3) Not available with Materials of Wetted Parts code T (Titanium).

(4) Requires X factory option.

Code	Language (manual and software)
Transmitter display language English	
E	English installation manual and English configuration manual
I	Italian quick installation manual and English configuration manual
M	Chinese quick installation manual and English configuration manual
R	Russian quick installation manual and English configuration manual
Transmitter display language French	
F	French quick installation manual and English configuration manual
Transmitter display language German	
G	German quick installation manual and English configuration manual
Transmitter display language Spanish	
S	Spanish quick installation manual and English configuration manual

Code	Future option 1
Z	Reserved for future use

Code	Conduit connections
Z	Standard 1/2-inch NPT fittings (no adapters)
B	M20 stainless steel adapters

Code	Factory options
Z	Standard product
X	Special order (ETO) product

Code	Special tests and certificates, tests, calibrations and services (optional) ⁽¹⁾
Material quality examination tests and certificates	
MC	Material Inspection Certificate 3.1 (Supplier Lot Traceability per EN 10204)
NC	NACE Certificate 2.1 (MR0175 and MR0103)
Pressure testing	
HT	Hydrostatic Test Certificate 3.1
Dye penetrant examination	
D1	Dye Penetrant Test Package 3.1 (Sensor only; Liquid Dye Penetration NDE Qualification)
Weld examination	
WP	Weld Procedure Package (Weld Map, Weld Procedure Specification, Weld Procedure Qualification Record, Welder Performance Qualification)
Positive material testing (select only one from this group)	
PM	Positive Material Test Certificate 3.1 (without carbon content)
PC	Positive Material Test Certificate 3.1 (including carbon content)
Sensor completion options	
WG	Witness General
SP	Special Packaging
Instrument tagging	
TG	Instrument Tagging - customer information required (max. 24 characters)
Country-specific approvals (select only one when approval option G is selected)	
R2 ⁽²⁾⁽³⁾	EAC Zone 1 - Hazardous area approval
R3 ⁽²⁾⁽³⁾	EAC Zone 2 - IIC modified - Hazardous area approval

(1) Multiple test or certificate options may be selected.

(2) Available only with approval G.

(3) Not available with transmitter housing option B.

Emerson Automation Solutions Americas

7070 Winchester Circle
Boulder, Colorado USA 80301
www.MicroMotion.com
www.Rosemount.com
T: +1 800 522 6277
T: +1 (303) 527 5200
F: +1 (303) 530 8459

Mexico T: 52 55 5809 5300
Argentina T: 54 11 4837 7000
Brazil T: 55 15 3413 8000
Venezuela T: 58 26 1300 8100
Chile T: 56 2 2928 4800

Emerson Automation Solutions Europe/Middle East

Central & Eastern Europe T: +41 41 7686 111
Dubai T: +971 4 811 8100
Abu Dhabi T: +971 2 697 2000
France T: 0800 917 901
Germany T: 0800 182 5347
Italy T: 8008 77334
The Netherlands T: +31 (0) 70 413 6666
Belgium T: +322 716 77 11
Spain T: +34 913 586 000
U.K. T: 0870 240 1978
Russia/CIS T: +7 495 981 9811

Emerson Automation Solutions Asia Pacific

Australia T: (61) 3 9721 0200
China T: (86) 21 2892 9000
India T: (91) 22 6662 0566
Japan T: (81) 3 5769 6803
South Korea T: (82) 2 3438 4600
Singapore T: (65) 6 777 8211

© 2017 Micro Motion, Inc. All rights reserved.

The Emerson logo is a trademark and service mark of Emerson Electric Co. Micro Motion, ELITE, ProLink, MVD and MVD Direct Connect marks are marks of one of the Emerson Automation Solutions family of companies. All other marks are property of their respective owners.

Micro Motion supplies this publication for informational purposes only. While every effort has been made to ensure accuracy, this publication is not intended to make performance claims or process recommendations. Micro Motion does not warrant, guarantee, or assume any legal liability for the accuracy, completeness, timeliness, reliability, or usefulness of any information, product, or process described herein. We reserve the right to modify or improve the designs or specifications of our products at any time without notice. For actual product information and recommendations, please contact your local Micro Motion representative.