



# PWM-200/NPF-200 OWA-200 Series

Rex Lin | Product Manger | Product Strategy Center  
Rex.lin@meanwell.com



MEAN WELL  
HAVE GOOD INTENTIONS.  
YOUR RELIABLE POWER PARTNER



# 200W Class II Plastic Housing

## PWM-200



- **Constant voltage output**, suitable for LED strip application
- With **3 in 1 or DALI 2.0+ Push Dim** dimming function
- **Flicker free design** compliant IEEE1789-2015 >4K HZ
- Complete **lighting safety** EN61347/UL8750/GB19510

## NPF-200



- **Constant voltage + Constant current output**, suitable for LED strip or LED lamp application
- With linear constant voltage dimming function, **flicker free design**, suitable for poultry lighting
- Complete **lighting safety** EN61347/UL8750/GB19510

## OWA-200



- **Constant voltage output**, suitable for general electrical and industrial appliances.
- Comply with **Energy star level VI and CoC V5 Tier 2** energy regulation
- US type : Comply with **UL 62386-1** listed ITE product safety
- EU type : Comply with **EN61558 / EN60335** Industrial and household appliance product safety

- Class II ,Comply with **SELV** and **primary and secondary isolation** design
- Fully potted design, comply with **IP67 Waterproof and dustproof** test
- Release Date : Apr/2021

# PWM-200 meets IEEE 1789-2015 (No Flicker Risk)

- PWM Constant Voltage Output : 4K Hz

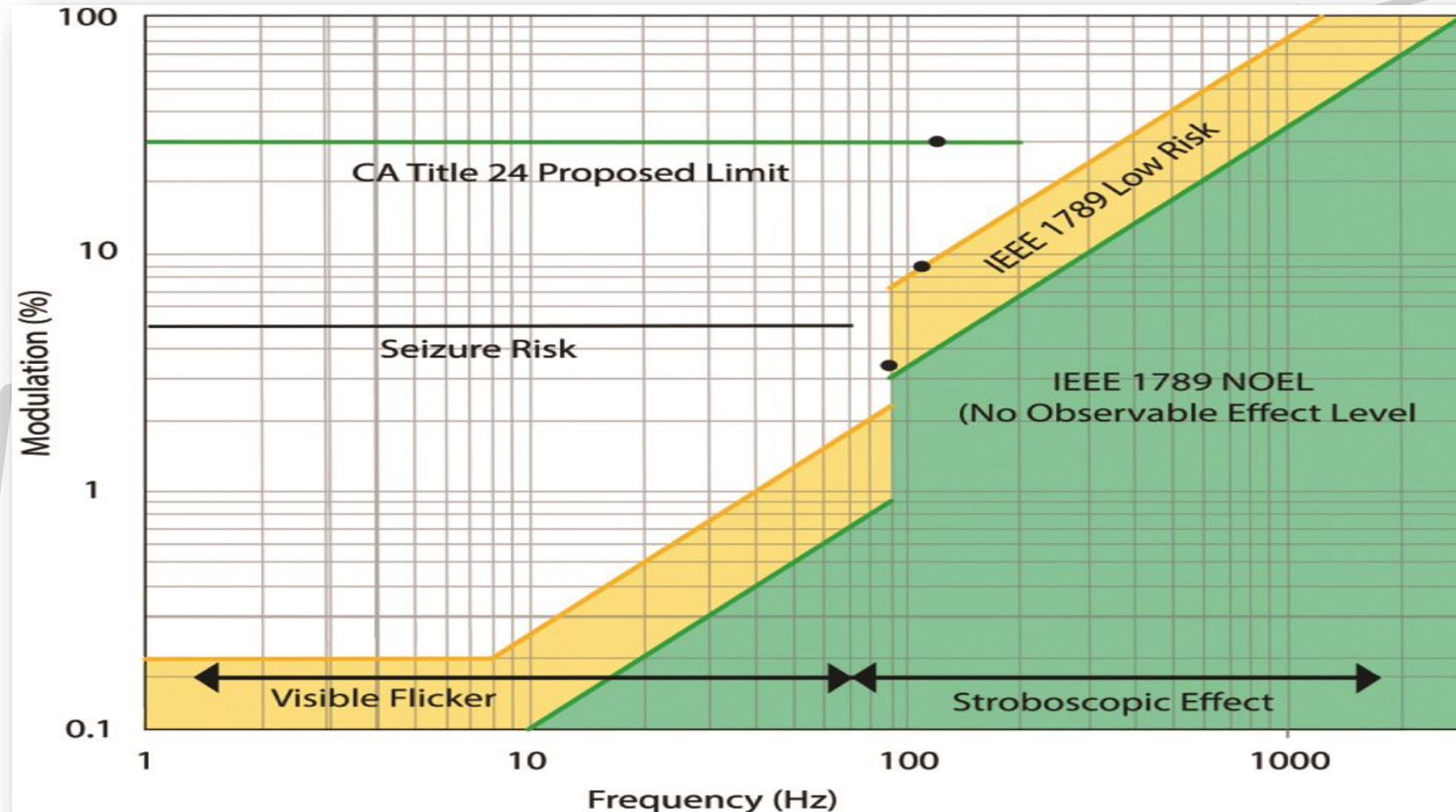

# NPF-200 Linear Voltage Dimming Flicker Free

## Traditional constant voltage PWM dimming

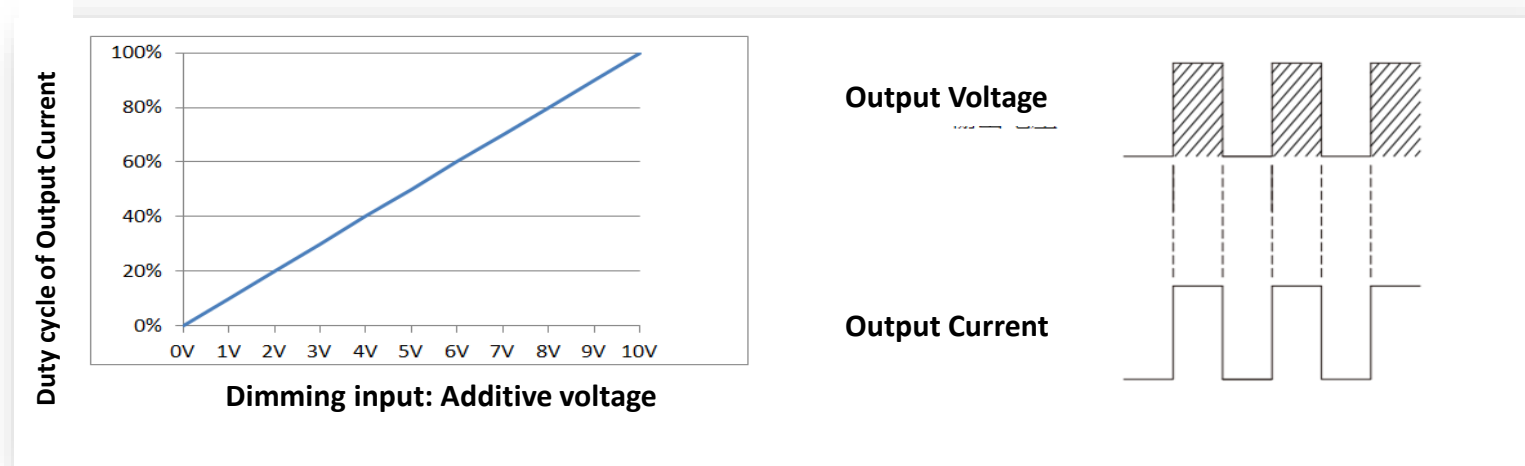

## Linear constant voltage dimming **NPF-200V**

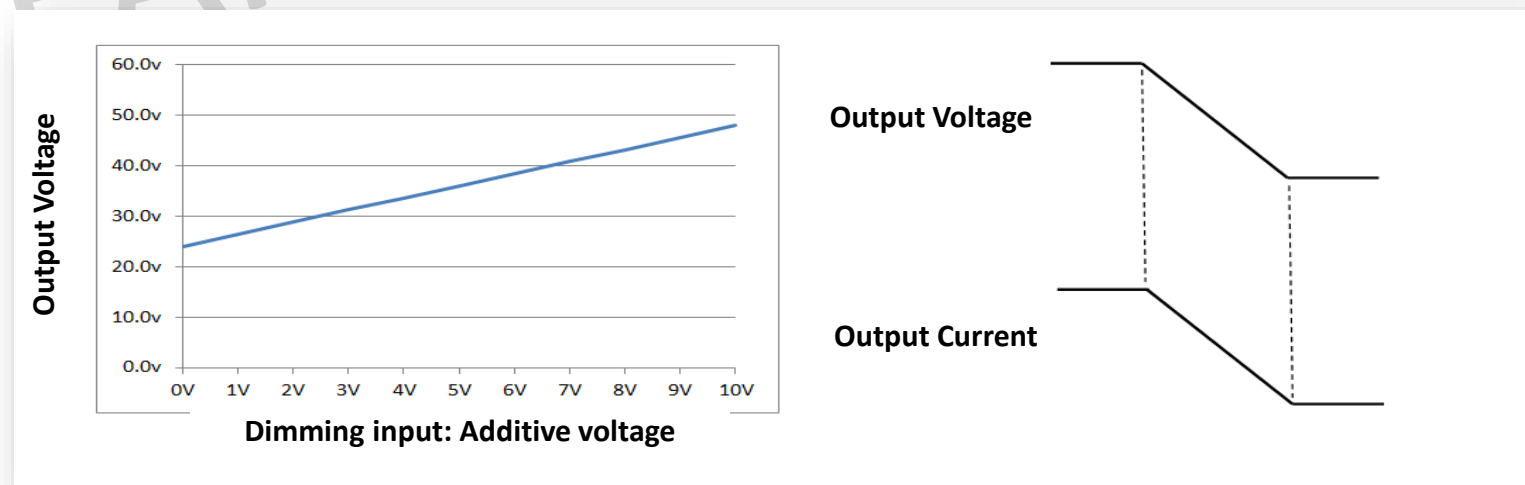

# OWA-200 Wire Comparison

## OWA-200U—U.S.A Plug 110~264 V AC

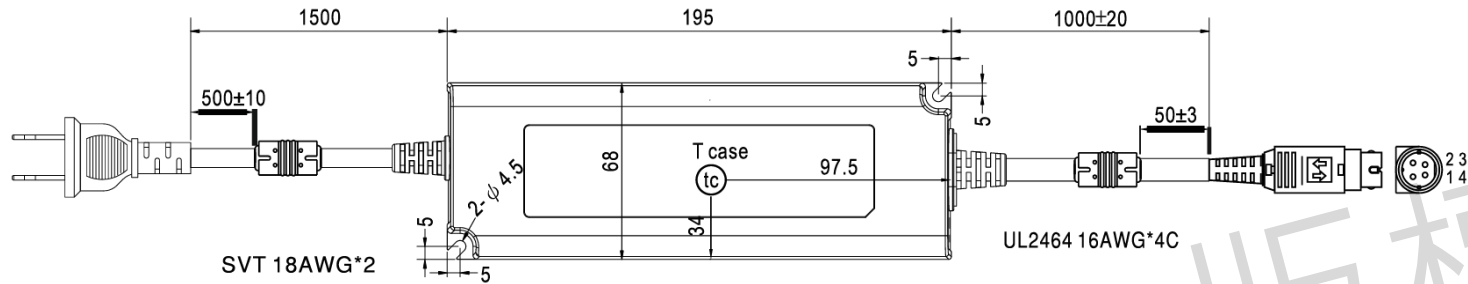

All models : power DIN 4 pins with lock type, KYCON KPPX-4P, or equivalent

Standard plug: R7B

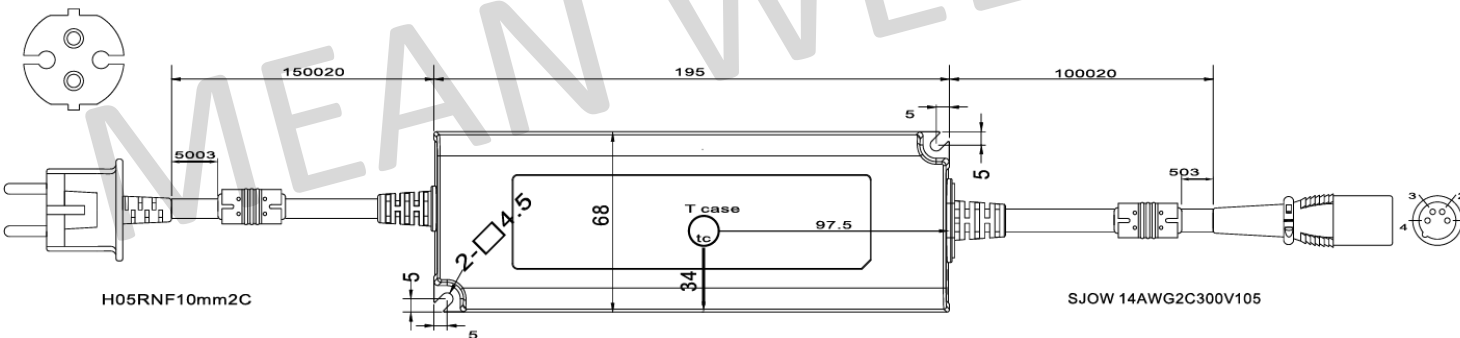

PIN NO.	OUTPUT
1,4	+V
2,3	-V

## OWA-200E—EU Plug 180~264 V AC

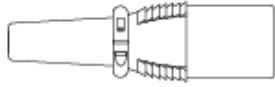
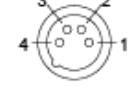



Plug Picture	PIN NO.	OUTPUT
	1,2	+V
	3,4	-V

## OWA-200—DC Output M15/M19 Waterproof connector option available

	1	+V
	2	-V

# 200W Class II Plastic Housing PSU Certification and Application

Series	Safety standard	Application industry	Application Figure
PWM-200	EN61347 UL8750 GB19510	<ul style="list-style-type: none"> <li>-LED strip</li> <li>-LED decorative lighting</li> <li>-Advertising light box</li> </ul>	
NPF-200(V)		<ul style="list-style-type: none"> <li>-LED strip</li> <li>-LED poultry lighting</li> <li>-LED decorative lighting</li> <li>-LED luminaire</li> </ul>	 <p>Agricultural Lighting</p>
OWA-200 (UL listed)	U type : EN62368-1  E type : EN61558 EN60335	<ul style="list-style-type: none"> <li>-IoT field PC adaptor</li> <li>-POS/Kiosk system</li> <li>-Small-Cell base station</li> <li>-Charger for electric lawn mower/robot vacuum/robot carrier</li> </ul>	



*Your Reliable Power Partner*

MEAN WELL 版權所有