

TO



TORNADO

Quality and accuracy - consistently and quickly

TORNADO

Advanced Lathe Technology

TORNADO

These superbly designed machines are the perfect choice for anyone who needs to perform turning, milling, back turning or multiple operations to produce accurate one offs, short batches or large production run of turned parts at a low cost per unit.

THESE ARE THE MOST CAPABLE AND VERSATILE CNC
MACHINES WE HAVE EVER PRODUCED

Turning and Mill-Turning

Tornado CNC Turning Centers provide greater consistency and accuracy because they are built using Colchester-Harrison's unique "**Duo-Stable**" advanced machine tool construction which provides thermal and dynamic stability up to 300% greater than cast iron. Components produced on a "**Duo-Stable**" machine are typically more accurate, have better surface finish and less tendency for thermal drift. For 3 axis turning the T6M, T8M and T10M CNC Turning Centers are perfect as they have full C axis, spindle disc brake and driven tooling to make radial and axial milling, drilling, boring and tapping easier than ever.

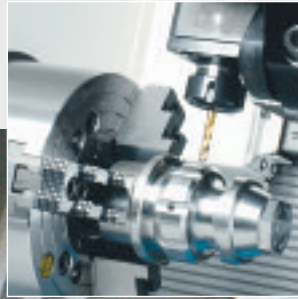

TO

Sub Spindle Turning

5 Axis single hit machining on the T6MS and T8MS allows powerful productivity gains by completing both sides of components in a 'single hit'. Automatic transfer of the workpiece from the main spindle to the sub spindle allows turning, milling and drilling to continue on the second side of the component. (Sub spindle machines are also available without driven tools, T6S and T8S).

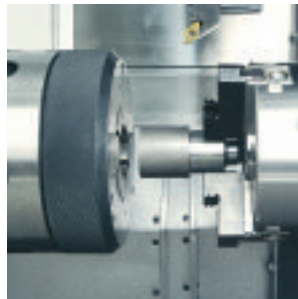
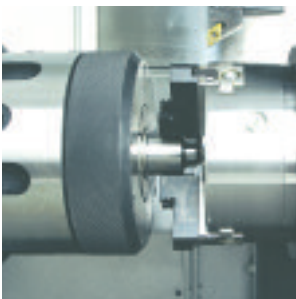

Y Axis Machining

The Tornado Y axis option (T8MY and T8MSY only) allows you to take full advantage of the machines milling capability by providing 'off center line' ($\pm 1.57''/40\text{mm}$ maximum) milling for the accurate machining of keyways, flat and contoured surfaces.

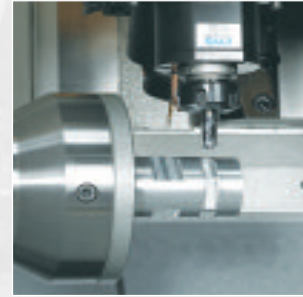

Automated Turning

LIGHTS OUT

Our renowned and proven productivity package provides you with the true 24/7 unmanned automation you need to increase your productivity, instantly.

Advanced Lathe Technology

TORNADO

MBF 1000 BARFEEDER

The world's first and most advanced all electric and fully integrated barfeeder, features work scheduling, tool management, automatic bar scheduling and component quantity calculation.

CUSTOM AUTOMATION

A wide range of barfeeders, robots and load/unload mechanisms can be integrated with your Tornado as well as special workholding applications.



The Tornado T Series

Today you are required to make ever shorter runs of more complex and more accurate parts, but at the same time reduce your cost. Does this sound familiar? You need a Turning Center that will give you capability, productivity and accuracy, but above all consistency of the finished product.

Here is your solution. The new, restyled Colchester-Harrison Tornado CNC Lathes are the most stable and consistent machines in their class, all with new guarding for improved ergonomics and maintainability with the latest Fanuc CNC control with Manual Guide **i** as standard, which gives you a wide range of configurations for even the most complex of parts.

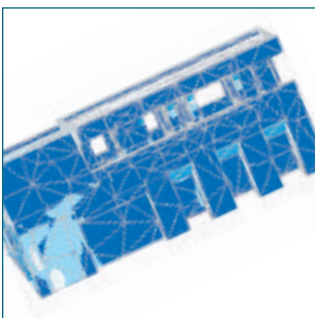
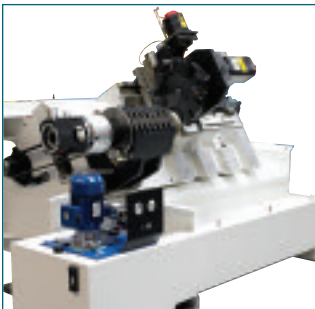
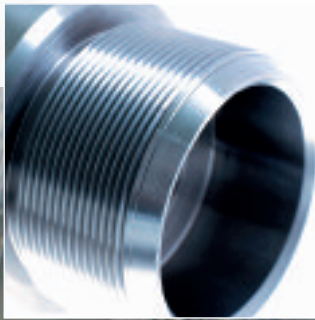

Thermal Stability Time Graph

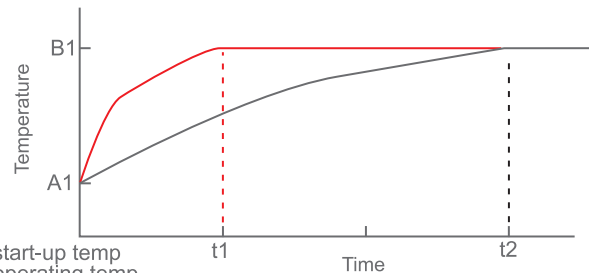

A1 = start-up temp
B1 = operating temp

t1 = time to thermal stability - Duo-Stable
t2 = time to thermal stability - conventional cast iron

“DUO-STABLE” CONSTRUCTION

Tornado users around the world are achieving higher accuracy and greater process stability as a result of Colchester-Harrison’s unique “**Duo-Stable**” construction. This method features a massive cast iron bed casting mounted on a substantial fabrication filled with specially developed polymer concrete. The result is a reduction in the thermal mass of the lathe and the creation of a built-in foundation to isolate both the mechanical and thermal effects from the cutting process.

The complete assembly has been developed using **FEA** (Finite Element Analysis) techniques to provide maximum stiffness even under the heaviest cutting conditions.

PRODUCTIVITY SOLUTIONS

Whatever your production application, you will find a Tornado to suit every your need. Every Tornado has Fanuc's highly capable CNC control with Manual Guide **i** control for quick set up times and efficient short runs. For longer runs, bar feeder and auto loader versions are available, and both B-axis and Y-axis milling can be specified for more complex geometries. The powerful second spindles makes 'single-hit' machining a reality, while the "**Duo-Stable**" construction means that the Tornado is ideally suited for hard turning applications.

If you want to achieve minimum manning, Colchester-Harrison's "lights-out" could be right for you.

The Tornado T Series is the most advanced and capable range of modern turning centers that money can buy.

TORNADO

Advanced Lathe Technology

TORNADO



TORNADO MODEL SELECTOR

	Chuck Capacity	Bar Cap	2 Axis	Mill/Turn	Sub Spindle	Y Axis
T2	5"/6.7" (125/170mm)	1.65" (42mm)	✓			
T4/4HD	6.7"/8.26" (170/210mm)	2.12" (54mm)	✓			
T6	6.7"/8.26" (170/210mm)	2.12" (54mm)		✓	✓	
T8	8.28"/10" (210mm/254mm)	2.59" (66mm)	✓	✓	✓	✓
T8B	10"/12" (254mm/305mm)	3.25" (82.5mm)	✓	✓	✓	✓
T10	10"/12" (254mm/305mm)	3.25" (82.5mm)	✓	✓		

Fanuc Technology

Two and three axis Tornado models are fitted with the GE Fanuc 21iTB control while the five and six axis 'MS & MSY' models are fitted with the 18iTB control. These ultra-compact controls from the world's leading CNC supplier are all digital with twice the processing speed of the previous 'A' model controls and incorporate the latest Manual Guide *i* as standard.

Users the world over appreciate the performance of the easy to use CNC control with a 10.4" LCD color display. Optical fiber connections ensure ultra-high-speed serial data transfer and reliable operation under even the harshest workshop conditions.

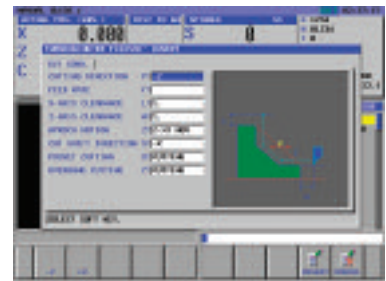
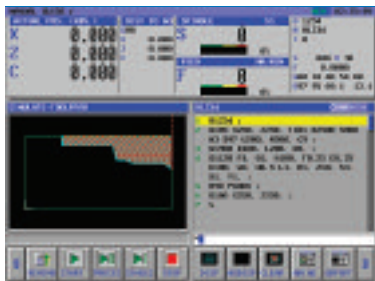

Manual Guide *i* is the very latest in conversational programming from FANUC and allows the operator to generate part programs quickly and efficiently through the use of easy to understand conversational cycle prompts.

Although the Manual Guide *i* system has enormous power, our engineers have been able to bring their turning experience into play to develop customized cycles especially for the needs of CNC type of lathe. These Colchester-Harrison developed cycles will save you a considerable amount of time and button pushing.

RNADO

Advanced Lathe Technology

TORNADO



Benefits of Manual Guide *i* include:

- Quick and easy tool setup
- Minimum ISO programming knowledge required
- Easy to use graphics allow the operator to simulate part prior to machining
- Tool path verification
- Programming one-offs made simple
- Interface with CAD/CAM systems
- Cut, copy and paste sections of programs with ease

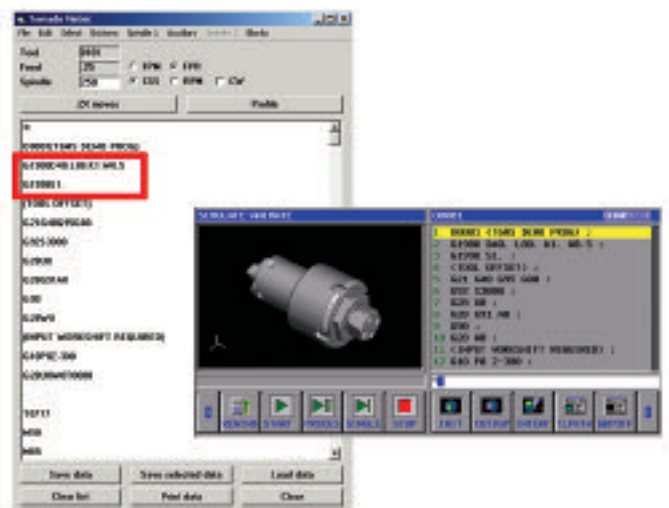

Tornado T2, T4, T8 & T10 2 Axis Turning

The Tornado T2, T4, T8 and T10 2 Axis CNC Lathes are precision turning machines with the state-of-the-art G.E. Fanuc 21i TB control, available in Chucking, Bar Feed and 'Lights-Out' Models with the versatility that can handle your most demanding turning needs



TO

- Powerful G.E. Fanuc spindle drive gives acceleration time of 2 sec. to top speed
- New generation G.E. Fanuc 'B' Series 21i TB CNC control system with 'Manual Guide i' has twice the processing speed as the 'A' series
- Twelve station high speed turret
- Quick changeover and set-up with VDI tooling
- High performance slideway and carriageway assemblies
- One of the smallest footprint of any machine in its range
- High quality hydraulic chucking system
- Massive cast iron 60° bed with precision ground surfaces is mounted on an extra heavy-duty unstressed, fabricated Duo-stable™ engineered base, designed for strength, vibration absorption and thermal and mechanical stability. As a result, the Tornado is over 20 percent heavier than comparable machines.
- Easy installation and set-up...The base design allows easy fork lift access and the three point floor mount allows quick set-up, no leveling required
- Optional CAM system software package, designed to run on virtually any PC

Specifications

	Tornado 2 Axis	T2	T4	T8	T10
Capacity					
Swing over bed cover	16.14"(410mm)	16.14"(410mm)	20.07"(510mm)	23.62"(600mm)	23.62"(600mm)
Max. turned diameter	6.69"(170mm)	6.69"(170mm)	9.05"(230mm)	10.23"(260mm)	14.17"(360mm)
X axis travel	6.69"(170mm)	6.69"(170mm)	7.87"(200mm)	9.25"(235mm)	10.63"(270mm)
Max. turning length	13.78"(350mm)	13.78"(350mm)	17.72"(450mm)	21.26"(540mm)	23.62"(600mm)
Spindle					
Spindle nose	A2-5	A2-5	A2-6	A2-6	A2-8
Power chuck (type A/B)	5"/6.7"(125/170mm)	6.7"/8.26"(170/210mm)	8.26"/10"(210/254mm)	10"/12"(254/305mm)	10"/12"(254/305mm)
Front bearing I/D	3.185"(80mm)	3.54"(90mm)	4.33"(110mm)	5.12"(130mm)	5.12"(130mm)
Spindle bore	2.13"(54mm)	2.40"(61mm)	3.05"(77.5mm)	3.56"(90.5mm)	3.56"(90.5mm)
Bar capacity	1.65"(42mm)	2.12"(54mm)	2.59"(66mm)	3.25"(82.5mm)	3.25"(82.5mm)
Max. spindle speed (A/B) (rpm)	6000/4000	6000/4000	5000/3500	4000/3000	4000/3000
Spindle motor (Cont./30 min.)	5/7.5 hp(4/5.5kW)	10/15 hp(7.5/11kW)	25/30 hp(18.5/22kW)	30/35 hp(22/26kW)	30/35 hp(22/26kW)
Spindle speed @ full Hp (A/B)	1500/1000 rpm	1500/1000 rpm	1250/875 rpm	597/448 rpm	597/448 rpm
Axes					
Rapid traverse X-axis	787 in/min(20mpm)	787 in/min(20mpm)	984 in/min(25mpm)	984 in/min(25mpm)	984 in/min(25mpm)
Rapid traverse Z-axis	984 in/min(25mpm)	984 in/min(25mpm)	1181 in/min(30mpm)	1181 in/min(30mpm)	1181 in/min(30mpm)
X-axis thrust (continuous)	565 lbf(2.51kN)	565 lbf(2.51kN)	850 lbf(3.77kN)	850 lbf(3.77kN)	850 lbf(3.77kN)
Z-axis thrust (continuous)	848 lbf(3.77kN)	848 lbf(3.77kN)	1,607 lbf(7.16kN)	1,607 lbf(7.16kN)	1,607 lbf(7.16kN)
X-axis ballscrew	25x4 mm	25x4 mm	32x8 mm	32x5 mm	32x5 mm
Z-axis ballscrew	32x10 mm	32x10 mm	40x10mm	40x10mm	40x10mm
X/Z-axis encoder feedback	rotary	rotary	rotary	rotary	rotary
Positioning accuracy	±0.0002(0.005mm)	±0.0002(0.005mm)	±0.0002(0.005mm)	±0.0002(0.005mm)	±0.0002(0.005mm)
Repeatability	±0.0001(0.002mm)	±0.0001(0.002mm)	±0.0001(0.002mm)	±0.0001(0.002mm)	±0.0001(0.002mm)
Construction					
Carriage inclination	60°	60°	60°	60°	60°
Spindle center height	35.43"(900mm)	35.43"(900mm)	37.79"(960mm)	38.46"(977mm)	38.46"(977mm)
Cross slide width	8.27"(210mm)	8.27"(210mm)	10.35"(263mm)	10.35"(263mm)	10.35"(263mm)
Cross slide type	20mm roller guides	20mm roller guides	35mm roller guides	35mm roller guides	35mm roller guides
Width across cross guide ways	7.32"(186mm)	7.32"(186mm)	8.9"(226mm)	8.9"(226mm)	8.9"(226mm)
Z-axis type	25mm roller guides	25mm roller guides	35mm roller guides	35mm roller guides	35mm roller guides
Bed width - linear guide rails	11.81"(300mm)	11.81"(300mm)	15.35"(390mm)	15.35"(390mm)	15.35"(390mm)
Tool Turret					
Turret disc diameter	13.38"(340mm)	13.38"(340mm)	16.14"(410mm)	18.3"(470mm)	18.3"(470mm)
Tooling system	VDI 30	VDI 30	VDI 40	VDI 40	VDI 40
No. of turret tool stations	12 bi-directional	12 bi-directional	12 bi-directional	12 bi-directional	12 bi-directional
Index time	0.6 sec	0.6 sec	0.45 sec	0.45 sec	0.45 sec
Tool shank size	3/4"x3/4" (20x20mm)	3/4"x3/4" (20x20mm)	1"x1"(25.4x25.4mm)	1"x1"(25.4x25.4mm)	1"x1"(25.4x25.4mm)
Max. boring bar	1.25"(32mm)	1.25"(32mm)	1.57"(40mm)	1.57"(40mm)	1.57"(40mm)
Travel past center line	0.87"(22mm)	0.87"(22mm)	1.06"(27mm)	1.06"(27mm)	1.06"(27mm)
Coolant, Space & Weight					
Coolant tank capacity	26 gal.(100 liters)	26 gal.(100 liters)	40 gal.(150 liters)	40 gal.(150 liters)	40 gal.(150 liters)
Coolant pump delivery	6.6 gal/min(25liters)	6.6 gal/min(25liters)	6.6 gal/min(25liters)	6.6 gal/min(25liters)	6.6 gal/min(25liters)
Maximum power consumption	13kVA	20kVA	37kVA	37kVA	37kVA
Dimensions: L x W	95"x52"(2413x1321mm)	95"x52"(2413x1321mm)	107"x62"(2718x1575mm)	113"x61"(2870x1550mm)	113"x61"(2870x1550mm)
Approx. net weight	6,019 lbs.(2730kg)	6,173 lbs.(2800kg)	9,810 lbs.(4450kg)	10,030 lbs.(4550kg)	10,030 lbs.(4550kg)
Optional Tailstock (retrofitable)					
Tailstock quill diameter	2.48"(63mm)	2.48"(63mm)	3.74"(95mm)	3.74"(95mm)	3.74"(95mm)
Tailstock quill taper	3MT	3MT	5MT	5MT	5MT
Tailstock quill stroke	4.13"(105mm)	4.13"(105mm)	4.92"(125mm)	4.92"(125mm)	4.92"(125mm)
Tailstock body travel	17.72"(450mm)	17.72"(450mm)	23.62"(600mm)	23.62"(600mm)	23.62"(600mm)
Max. tailstock quill thrust	1,131 lbf(5.03kN)	1,131 lbf(5.03kN)	1,768 lbf(7.86kN)	1,768 lbf(7.86kN)	1,768 lbf(7.86kN)

Model No.	Chuck Type	rpm	Max Bar
T2A	5" Hyd	6000	1.65" (42mm)
T2B	6.7" Hyd	4000	1.65" (42mm)
T2AB Bar Feed	Collet	6000	1.65" (42mm)
T2BB Bar Feed	Collet	4000	1.65" (42mm)
T2AL Lights-Out	Collet	6000	1.65" (42mm)
T2BL Lights-Out	Collet	4000	1.65" (42mm)
T4A	6.7" Hyd	6000	2.04" (52mm)
T4B	8.26" Hyd	4000	2.04" (52mm)
T4AB Bar Feed	Collet	6000	2.12" (54mm)
T4BB Bar Feed	Collet	4000	2.12" (54mm)
T4AL Lights-Out	Collet	6000	2.12" (54mm)
T4BL Lights-Out	Collet	4000	2.12" (54mm)
T8A	8.26" Hyd	5000	2.59" (66mm)
T8B	10" Hyd	3500	2.59" (66mm)
T8AB Bar Feed	Collet	5000	2.59" (66mm)
T8BB Bar Feed	Collet	3500	2.59" (66mm)
T8AL Lights-Out	Collet	5000	2.59" (66mm)
T8BL Lights-Out	Collet	3500	2.59" (66mm)
T10A	10" Hyd	4000	3.25" (82.5mm)
T10B	12" Hyd	3000	3.25" (82.5mm)
T10AB Bar Feed	Collet	4000	3.25" (82.5mm)
T10BB Bar Feed	Collet	3000	3.25" (82.5mm)
T10AL Lights-Out	Collet	4000	3.25" (82.5mm)
T10BL Lights-Out	Collet	3000	3.25" (82.5mm)

Tornado T6M, T8M & T10M 3 Axis Turning

The Tornado T6M, T8M & T10M 3 Axis CNC Lathes are true precision turning centers with Turret Mounted Powered Tooling, controlled from the state-of-the-art G.E. Fanuc 21i TB control. 'M' models have all the machine design features as the 2 axis models with the added production flexibility of live tooling.

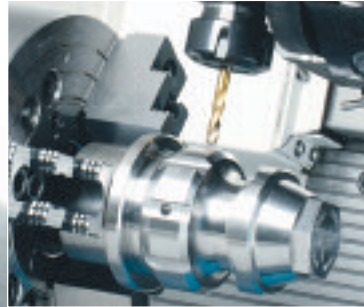

TO

- Tornado T6M, T8M & T10M offers milling power for both radial and axial milling, drilling, boring and tapping operations
- Live turret mounted tooling adds flexibility and large production gains by cutting the number of set-ups and operations
- Tornado "M" models are fitted with a linear scale on the X axis to maintain high accuracy even during 'off center' operations
- Powerful live tooling drive motor for real milling power, 5 hp on T6M & T8M, 7.5 hp on T10M
- High powered tool cutting speeds, up to 5000 rpm on T6M models and 4000 rpm on T8M & T10M models
- Twelve station high speed bi-directional turret with 12 powered stations on T6M & T10M models and 6 powered stations on T8M
- C axis positioning increment of 0.001° is fully programmable
- C axis contouring selected by M-code
- Quick changeover and set-up with VDI 30 tooling on T6M models and VDI 40 on T8M & T10M models
- Optional CAM system software package, designed to run on virtually any PC, developed for more complex 3 axis programming
- Available in Chucker, Barfeed and Unmanned 'Lights-Out' models

Specifications



TORNADO

	Tornado 3 Axis	T6M	T8M	T10M
Capacity				
Swing over bed cover	17.32"(440mm)	20.07"(510mm)	23.62"(600mm)	
Max. turned diameter	8.46"(215mm)	11.42"(290mm)	14.17"(360mm)	
X axis travel	7.87"(200mm)	9.25"(235mm)	10.63"(270mm)	
Max. turning length	17.72"(450mm)	21.26"(540mm)	23.62"(600mm)	
Spindle				
Spindle nose	A2-5	A2-6	A2-8	
Power chuck (type A/B)	6.7"/8.27"(170/210mm)	8.26"/10"(210/254mm)	10"/12"(254/305mm)	
Front bearing I/D	3.54"(90mm)	4.33"(110mm)	5.12"(127mm)	
Spindle bore	2.52"(64mm)	3.05"(77.5mm)	3.56"(90.5mm)	
Bar capacity	2.12"(54mm)	2.59"(65mm)	3.25"(82.5mm)	
Max. spindle speed (A/B) (rpm)	6000/4000	5000/3500	4000/3000	
Spindle motor (Cont./30 min.)	15/20 hp(11/15kW)	25/30 hp(19/22kW)	30/35 hp(19/22kW)	
Spindle speed @ full Hp (A/B)	1500/1000 rpm	1250/880 rpm	597/448 rpm	
Axes				
Rapid traverse X/Z-axis	984/1181 ipm(25/25mpm)	984/1181 ipm(30/25mpm)	984/1181 ipm(30/25mpm)	
X/Z-axis thrust (continuous)	800/1,000 lbf(3.75/4.44 kN)	1,330/1,610 lbf(5.91/7.15 kN)	1,330/1,610 lbf(5.91/7.15 kN)	
X/Z-axis ballscrew	32x8/32x10 mm	32x8/40x10 mm	32x8/40x10 mm	
X/Z-axis encoder feedback	linear/rotary	linear/rotary	linear/rotary	
Positioning accuracy	±0.0002(0.005mm)	±0.0002(0.005mm)	±0.0002(0.005mm)	
Repeatability	±0.0001(0.002mm)	±0.0001(0.002mm)	±0.0001(0.002mm)	
Construction				
Carriage inclination	60°	60°	60°	
Spindle center height	37.40"(950mm)	37.79"(960mm)	38.46"(977mm)	
Cross slide width	9.45"(240mm)	10.35"(263mm)	10.35"(263mm)	
Cross slide type	20mm roller guides	35mm roller guides	35mm roller guides	
Width across cross guides ways	8.15"(207mm)	8.9"(226mm)	8.9"(226mm)	
Z-axis type	20mm roller guides	35mm roller guides	35mm roller guides	
Bed width - linear guide rails	12.91"(328mm)	15.35"(390mm)	15.35"(390mm)	
Tool Turret				
Turret disc diameter	14.57"(370mm)	17.32"(440mm)	18.58"(472mm)	
Tooling system	VDI 30	VDI 40	VDI 40	
No. of turret tool stations	12 bi-directional	12 bi-directional	12 bi-directional	
Index time	0.45 sec	0.45 sec	0.45 sec	
Tool shank size	3/4"x3/4"(20x20mm)	1"x1"(25.4x25.4mm)	1"x1"(25.4x25.4mm)	
Max. boring bar	1.25"(32mm)	1.57"(40mm)	1.57"(40mm)	
Travel past center line	1.06"(27mm)	1.06"(27mm)	1.06"(27mm)	
Live Tooling				
C-axes min. increment	.001°	.001°	.001°	
Power driven stations	12	6	12	
Power station servo motor	5 hp	5hp	7.5hp	
Rotating tool shank size	DIN5482 15x12	DIN5482 17x14	DIN5482 20x0.8	
Maximum tool speed	5000 rpm	4000 rpm	4000 rpm	
Maximum collet size	0.625"(16mm)	0.75"(20mm)	0.75"(20mm)	
Coolant, Space & Weight				
Coolant tank capacity	26 gal.(100 litres)	40 gal.(150 litres)	40 gal.(150 litres)	
Coolant pump delivery	6.6 gal/min(25 litres/min)	6.6 gal/min(25 litres/min)	6.6 gal/min(25 litres/min)	
Maximum power consumption	28kVA	50kVA	37kVA	
Dimensions: L x W	103"x65"(2616x1651mm)	107"x62"(2719x1575mm)	107"x62"(2719x1575mm)	
Approx. net weight	8,818 lbs.(4000kg)	10,031 lbs.(4550kg)	10,251 lbs.(4650kg)	
Optional Tailstock (retrofittable)				
Tailstock quill diameter	2.48"(63mm)	3.74"(95mm)	3.74"(95mm)	
Tailstock quill taper	3MT	5MT	5MT	
Tailstock quill stroke	4.13"(105mm)	4.92"(125mm)	4.92"(125mm)	
Tailstock body travel	21.25"(540mm)	23.62"(600mm)	23.62"(600mm)	
Max. tailstock quill thrust	1,131 lbf(5.0 kN)	1,768 lbf(7.85 kN)	1,768 lbf	

Model No.	Chuck Type	rpm	Max Bar
T6MA	6.7" Hyd	6000	2.04"(52mm)
T6MB	8.26" Hyd	4000	2.04"(52mm)
T6MAB Bar Feed	Collet	6000	2.12"(54mm)
T6MBB Bar Feed	Collet	4000	2.12"(54mm)
T6MAL Lights-Out	Collet	6000	2.12"(54mm)
T6MBL Lights-Out	Collet	4000	2.12"(54mm)
T8MA	8.26" Hyd	5000	2.59"(66mm)
T8MB	10" Hyd	3500	2.59"(66mm)
T8MAB Bar Feed	Collet	5000	2.59"(66mm)
T8MBB Bar Feed	Collet	3500	2.59"(66mm)
T8MAL Lights-Out	Collet	5000	2.59"(66mm)
T8MBL Lights-Out	Collet	3500	2.59"(66mm)
T10MA	10" Hyd	4000	3.25"(82.5mm)
T10MB	12" Hyd	3000	3.25"(82.5mm)
T10MAB Bar Feed	Collet	4000	3.25"(82.5mm)
T10MBB Bar Feed	Collet	3000	3.25"(82.5mm)
T10MAL Lights-Out	Collet	4000	3.25"(82.5mm)
T10MBL Lights-Out	Collet	3000	3.25"(82.5mm)

Tornado T6MS & T8MS 5 Axis Turning

The Tornado T6MS and T8MS 5 Axis CNC Lathes are true 'Single-hit' turning centers. The addition of a powerful sub spindle, controlled from the state-of-the-art G.E. Fanuc 18i TB control, allows 5 axis programming. 'MS' models have all the machine design features of the 2 & 3 axis models but with the added production flexibility of a sub-spindle and live tooling.



- The addition of the sub spindle allows 'Single-hit' machining. By transferring the workpiece to the sub spindle for additional turning and milling, the part can be completed in a single operation
- Tornado T6MS and T8MS offer milling power for both radial and axial milling, drilling, boring and tapping operations on either spindle
- The sub spindle is driven by a powerful 7.5 hp (5kW) drive motor on the T6MS and 10 hp (7.5kW) drive motor on the T8MS
- High speed turning: up to 6000 rpm on T6MS models and 5000 rpm on T8MS models
- Sub-spindle chuck and collet capacity: 5.1" (130mm) chuck and 1.3" (33mm) collet on T6MS models and 6.7" (170mm) chuck and 1.69" (43mm) collet on T8MS models
- Tornado 'MS' models are fitted with a linear scale on the X axis to maintain high accuracy even during 'off center' operations
- Twelve station high speed bi-directional turret with 12 power stations
- B & C axis positioning increment of 0.001° is fully programmable
- Quick changeover and set-up with VDI 30 tooling on T6MS models and VDI 40 on T8MS models
- Optional CAM system software package, designed to run on virtually any PC, developed for more complex 5 axis programming
- Available in Chucker, Barfeed and Unmanned 'Lights-Out' models
- Ethernet Link allows remote access to the CNC control for part program transfer, supervisory control, data acquisition, diagnostic and maintenance functions.

Specifications

	T6MS	T8MS
Sub-Spindle Linear Pos. (A-axis)		
Width across cross guide ways	9.44"(240mm)	9.44"(240mm)
Guide way type	35mm roller guide	35mm roller guide
Min/max jaw to jaw travel	.75"/18.5"(20/470mm)	0"-23.62"(0/600mm)
Travel	17.7"(450mm)	24.61"(625mm)
A-axis ballscrew	32 x 10 mm	32 x 10 mm
A-axis rapid traverse	1,181 in/min(30m/min)	1,181 in/min(25m/min)
Sub-Spindle Rotational (B-axis)		
Spindle	DIN 6353	DIN 6353
Chuck size	5.1"(130mm)	6.7"(170mm)
Collet size	1.30"(33mm)	1.69"(43mm)
Spindle bore	2.165"(55mm)	2.165"(55mm)
Drawtube (diameter x length)	1.57"x14.57"(40x370mm)	1.57"x17.08"(40x370mm)
Spindle speed	6000 rpm	5000 rpm
Spindle motor	7.5 hp(5kW)	10 hp(7.5kW)
Spindle speed @ full Hp	1500 rpm	1500 rpm
B-axis min increment	.001°	.001°

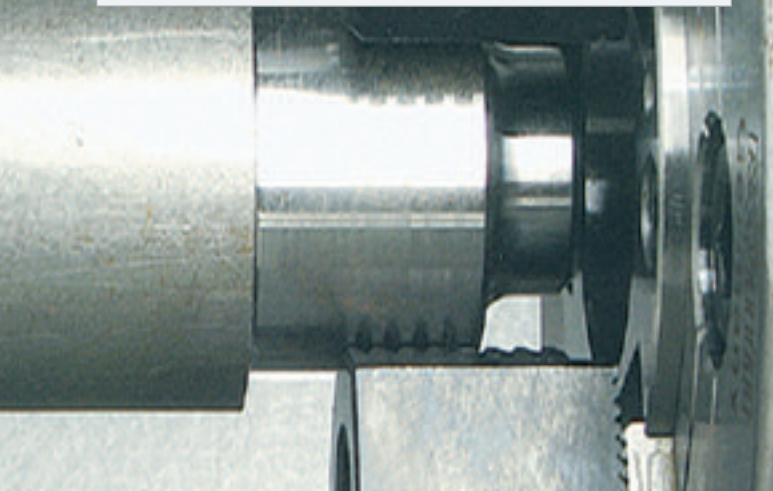

Model No.	Chuck Type	rpm	Max Bar
T6MSA	6.7" Hyd	6000	2.04"(52mm)
T6MSB	8.26" Hyd	4000	2.04"(52mm)
T6MSAB Bar Feed	Collet	6000	2.12"(54mm)
T6MSBB Bar Feed	Collet	4000	2.12"(54mm)
T6MSAL Lights-Out	Collet	6000	2.12"(54mm)
T6MSBL Lights-Out	Collet	4000	2.12"(54mm)
T8MSA	8.26" Hyd	5000	2.59"(66mm)
T8MSB	10" Hyd	3500	2.59"(66mm)
T8MSAB Bar Feed	Collet	5000	2.59"(66mm)
T8MSBB Bar Feed	Collet	3500	2.59"(66mm)
T8MSAL Lights-Out	Collet	5000	2.59"(66mm)
T8MSBL Lights-Out	Collet	3500	2.59"(66mm)

	T6MS	T8MS
Capacity		
Swing over bed cover	17.32"(440mm)	20.07"(510mm)
Max. turned diameter	8.66"(220mm)	11.81"(300mm)
X axis travel	7.87"(200mm)	9.44"(240mm)
Max. turning length	17.72"(450mm)	21.26"(540mm)
Spindle		
Spindle nose	A2-5	A2-6
Power chuck (type A/B)	6.7"/8.26"(170/210mm)	8.26"/10"(210/254mm)
Front bearing I/D	3.54"(90mm)	4.33"(110mm)
Spindle bore	2.52"(64mm)	3.05"(77.5mm)
Bar capacity	2.12"(54mm)	2.59"(65mm)
Max. spindle speed (A/B) (rpm)	6000/4000	5000/3500
Spindle motor (Cont./30 min.)	15/20 hp(11/15kW)	25/30 hp(19/22kW)
Spindle speed @ full Hp (A/B)	1167/1000 rpm	1250/880 rpm
Axes		
Rapid traverse X/Z-axis	984/1181 ipm(25/30mpm)	984/1181 ipm(25/30mpm)
X/Z-axis thrust (continuous)	800/1,000 lbf(3.75/4.44 kN)	1,330/1,610 lbf(5.91/7.15 kN)
X/Z-axis ballscrew	32x8/32x10 mm	32x8/40x10 mm
X/Z-axis encoder feedback	linear/rotary	linear/rotary
Positioning accuracy	±0.0002(0.005mm)	±0.0002(0.005mm)
Repeatability	±0.0001(0.002mm)	±0.0001(0.002mm)
Construction		
Carriage inclination	60°	60°
Spindle center height	37.40"(950mm)	37.79"(960mm)
Cross slide width	9.45"(240mm)	10.23"(259mm)
Cross slide type	30mm roller guide	35mm roller guide
Width across cross guide ways	8.15"(207mm)	8.9"(226mm)
Z-axis type	30mm roller guide	35mm roller guide
Bed width - linear guide rails	12.91"(328mm)	15.31"(389mm)
Tool Turret		
Turret disc diameter	10.63"(270mm)	12.6"(320mm)
Tooling system	VDI 30	VDI 40
No. of turret tool stations	12 bi-directional	12 bi-directional
Index time	0.33 sec	0.33 sec
Tool shank size	3/4" x 3/4"(20x20mm)	1" x 1"(25.4x25.4mm)
Max. boring bar	1.25"(32mm)	1.57"(40mm)
Travel past center line	.866"(22mm)	1.06"(27mm)
Live Tooling		
C-axes min. increment	.001°	.001°
Power driven stations	12	12
Power station servo motor	5 hp	5 hp
Rotating tool shank size	DIN5480 16x0.8	DIN5482 20x0.8
Maximum tool speed	5000 rpm	4000 rpm
Maximum collet size	0.630(16mm)	0.75(20mm)
Coolant, Space & Weight		
Coolant tank capacity	26 gal.(100 litres)	40 gal.(150 litres)
Coolant pump delivery	6.6 gal/min(25 litres/min)	6.6 gal/min(25 litres/min)
Maximum power consumption	26kVA	50kVA
Dimensions: L x W	103"x65"(2616x1651mm)	115"x66"(2916x1651mm)
Approx. net weight	9,920 lbs.(4500kg)	11,023 lbs.(4650kg)

TORNADO

Tornado T8MSY 6 Axis Turning

The Tornado T8MSY 6 Axis CNC Lathe is the ultimate turning center. The addition of with Y-axis machining, allows the operator to take full advantage of the machine's milling capability by providing 'off center line' machining controlled by the state-of-the-art G.E. Fanuc 18i TB control. The T8MSY has all the machine design features of the 2, 3 & 5 axis models.



- The T8MSY turning center offers Y-axis machining, allowing you to take full advantage of the machines milling capability by providing 'off center line' $\pm 1.57''$ ($\pm 40\text{mm}$) milling for the accurate machining of keyways, flat and contoured surfaces
- The sub spindle is driven by a powerful 10 hp (7.5kW) drive motor
- Tornado T8MSY offer milling power for both radial and axial milling, drilling, boring and tapping operations on either spindle
- High speed turning, up to 5000 rpm
- Sub-spindle has 6.7" (170mm) chuck and 1.69" (43mm) collet capacity
- Tornado 'MSY' is fitted with a linear scale on the X axis to maintain high accuracy even during 'off center' operations
- Twelve station high speed bi-directional turret with 12 power stations
- B & C axis positioning increment of 0.001° is fully programmable
- Quick changeover and set-up with VDI 30 tooling
- Optional CAM system software package, designed to run on virtually any PC, developed for more complex 5 axis programming
- Available in Chucker, Barfeed and Unmanned 'Lights-Out' models
- Ethernet Link allows remote access to the CNC control for part program transfer, supervisory control, data acquisition, diagnostic and maintenance functions.

Specifications

Tornado 6 Axis T8MSY	
Sub-Spindle Linear Pos. (A-axis)	
Width across cross guide ways	9.52"(242mm)
Guide way type	35mm roller guide
Min/max jaw to jaw travel	0"-23.62"(0/600mm)
Travel	24.60"(625mm)
A-axis ballscrew	32 x 10 mm
A-axis rapid traverse	1,181 in/min(30m/min)
Sub-Spindle Rotational (B-axis)	
Spindle	DIN 6353
Chuck dia.	6.7"(170mm)
Optional collet chuck	CDC42
Spindle bore	2.165"(55mm)
Drawtube (diameter x length)	1.57"x17.08"(40x370mm)
Spindle speed	6000 rpm
Spindle motor	10 hp(7.5kW)
Spindle speed @ full Hp	1500 rpm
B-axis min increment	.001°
Y Axis Specification	
Y axis stroke	±1.57" (40mm)
Tooling type	VDI 30
Tooling stations	12 power driven
Max power tool speed	5000 rpm
Y-axis ballscrew	32 x 5 mm
Y-axis rapid traverse	393 ipm(10mpm)

Tornado 6 Axis T8MSY	
Capacity	
Swing over bed cover	20.07"(510mm)
Max. turned diameter	10.23"(260mm)
X axis travel	6.69"(170mm)
Max. turning length	21.26"(540mm)
Spindle	
Spindle nose	A2-6
Power chuck (type A/B)	8.26"/10"(210/254mm)
Front bearing ID	4.33"(110mm)
Spindle bore	3.05"(77.5mm)
Bar capacity	2.59"(65mm)
Max. spindle speed (A/B) (rpm)	5000/3500
Spindle motor (Cont./30 min.)	25/30 hp(19/22kW)
Min spindle speed for full power	1250/880 rpm
Axes	
Rapid traverse X/Z-axis	984/1181 ipm(25/30mpm)
X/Z-axis thrust (continuous)	1,330/1,610 lbf(5.73/1.15 kN)
X/Z-axis ballscrew	32x8/40x10 mm
X/Z-axis encoder feedback	linear/rotary
Positioning accuracy	±0.0002(0.005mm)
Repeatability	±0.0001(0.002mm)
Construction	
Carriage inclination	60°
Spindle center height	38.45"(977mm)
Cross slide width	10.23"(259mm)
Cross slide type	35mm roller guide
Width across cross guide ways	8.9"(226mm)
Z-axis type	35mm roller guide
Bed width - linear guide rails	15.31"(389mm)
Tool Turret	
Turret disc diameter	10.63"(270mm)
Tooling system	VDI 40
No. of turret tool stations	12 bi-directional
Index time	0.33 sec
Tool shank size	.75" x .75"(20x20mm)
Max. boring bar	1.57"(40mm)
Travel past center line	1.06"(27mm)
Live Tooling	
C-axes min. increment	.001°
Power driven stations	12
Power station servo motor	5 hp
Rotating tool shank size	DIN5480 16x0.8
Maximum tool speed	5000 rpm
Maximum collet size	0.625(16mm)
Coolant, Space & Weight	
Coolant tank capacity	40 gal.(150 litres)
Coolant pump delivery	6.6 gal/min(25 litres/min)
Maximum power consumption	35kVA
Dimensions: L x W	115"x66"(2616x1651mm)
Approx. net weight	11,023 lbs.(5000kg)

Model No.	Chuck Type	rpm	Max Bar
T8MSYA	8.26" Hyd	5000	2.59"(66mm)
T8MSYB	10" Hyd	3500	2.59"(66mm)
T8MSYAB Bar Feed	Collet	5000	2.59"(66mm)
T8MSYBB Bar Feed	Collet	3500	2.59"(66mm)
T8MSYAL Lights-Out	Collet	5000	2.59"(66mm)
T8MSYBL Lights-Out	Collet	3500	2.59"(66mm)

Automated Turning



Magazine Barfeed Unit, Completely Integrated with the Tornado CNC Turning Center, Operated and Controlled Directly from the FANUC 21i/18i TB Control System...

- No mechanical stops to set
- Automatic measurement of each bar loaded
- Automatic calculation of pieces to be machined from each bar
- Text pages on screen for production schedule facility
- Work scheduling to produce a variety of components automatically

The Innovative 'Lights-Out' Package Integrates the TORNADO Turning Center and the MBF1000 Barfeed System to offer 24 Hour Unmanned Operation...

- Cost efficient and unmatched productivity
- Colchester/Harrison MBF1000 barfeed automation software
- Part probing plus probing routines
- Chip and parts management system
- Production scheduling
- Tool management system
 - Tool setting probe
 - Sister tool replacement routines
- In process gauging

Specification	T2	T4/T6M/MS	T8/M/MS/T10/M
Bar Capacity			
Round inch	.23"-1.65"(6-42mm)	.23"-2.12"(6-54mm)	.23"-2.59"(6-66mm)
Hexagonal A/F Max	1.41"(36mm)	1.77"(45mm)	2.20"(56mm)
Square A/F Max	1.14"(29mm)	1.41"(36mm)	1.77"(45mm)
Maximum length of bar stock		39.37"(1000mm) (T2/T4)	43.3"(1100mm) (T6/T8/T10)
Material rack capacity		1"(25mm) - 20 pieces	1.5"(45mm) - 12 pieces
		2.5"(65mm) - 7 pieces	
3 Push Rod diameters		.23"(6mm), .39"(10mm), .71"(18mm)	
Master liner		For supporting bar stock in headstock spindle	
Feed/load			
Bar feed to spindle liner		Full positioning by integral servo drive	
Bar load to guide vee		Electrically driven multi-vee pick and place from adjustable table	
Bar stock preparation		Chamfer not required - de-burr only	
Bar guide within spindle		.0197"(.05mm) -.0394"(1mm) clear support bushings or liners	
Vee guide adjustment		Manual unclamp/clamp lever with handwheel height adjustment	
Total working travel		46.69"(118mm)	
Bar pusher rapid traverse rate		Same as lathe	
Programming		Programming pages on G.E.Fanuc 21i/18i TB for operation and unmanned running including height adjustment	
Overall dimensions		66.9"(170mm) L x 40.2"(102mm) W x 46.1"(117mm) H	

TORNADO

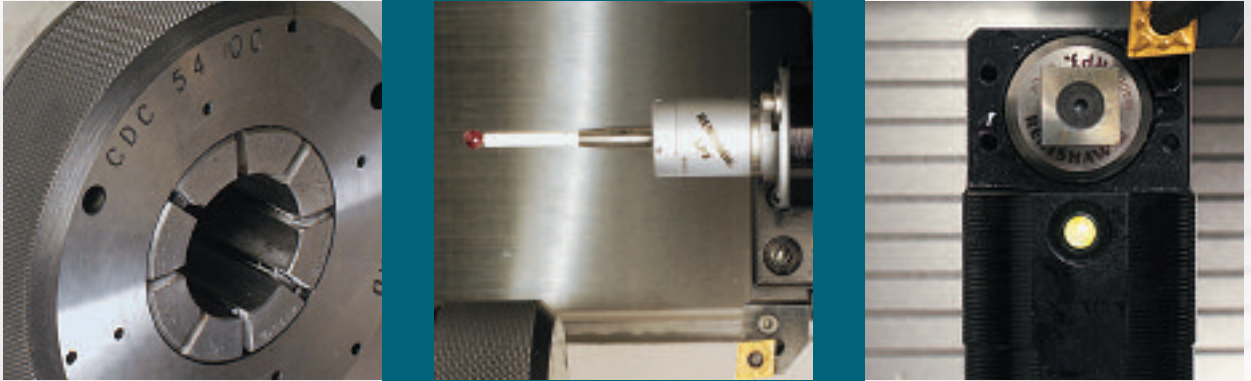

Optional Equipment

Colchester-Harrison offers a wide range of optional equipment to customize your Tornado into exactly the right specification for your particular application.

MACHINE OPTIONS

Speed range. Every Tornado is offered with either high or low speed ranges and is supplied with the appropriate chuck for your chosen spindle speed. This is a no cost option. (The lower speed option offers higher torque and larger chuck capacity).

Hydraulic tailstock. Suitable for bar and shaft turning, it is manually positioned complete with hydraulic quill.

Fully programmable tailstock. Full servo driven positioning for automated operations (T6M and T8M).

Full stroke tailstock travel. Through hydraulic activation and linear rail mount.

Chip conveyor. Ultra simple and reliable slat type conveyor for the automatic removal of chips and other debris.

Renishaw motorized tool setting arm. Automatic in-cycle tool setting and data update.

Renishaw workpiece measuring probe. Optically coupled LP2 probe providing component measurement and automatic compensation.

PARTS HANDLING OPTIONS

MBF 1000T bar feeder. All electric fully integrated bar feeder featuring work scheduling software, automatic bar measurement and calculation of the number of components that can be made from the available bar.

Gantry system. Gantry system for feeding, unloading and storing bulk components.

Robot Loader. Fanuc articulated robot (model depends on application) for auto loading chucking applications.

Parts catcher. New high capacity parts catcher supplied with removable container.

Parts conveyor. For the safe and accurate discharge of parts.

Generic bar feeder interfaces. Suitable for all popular makes of bar feeders. e.g. Lemca, LNS, Hydrafeed, FMB.

SAUTER TURRET & TOOLING

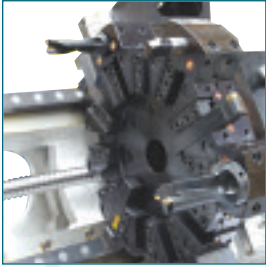

T4 HD TURRET

- 12 station automatic indexing static tool turret
- AC servo motor drive for indexing
- Hydraulic locking
- Ultra high speed indexing
- Block type, face mounted tooling

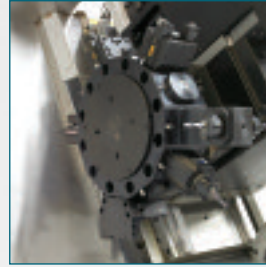

T6/8MS(Y) TURRET

- 12 station automatic indexing driven tool turret with or without integrated Y axis
- AC servo motor drive for indexing
- Hydraulic locking
- Ultra high speed indexing
- Tools individually driven
- Radial tool mounting (for back turning)
- VDI type tooling

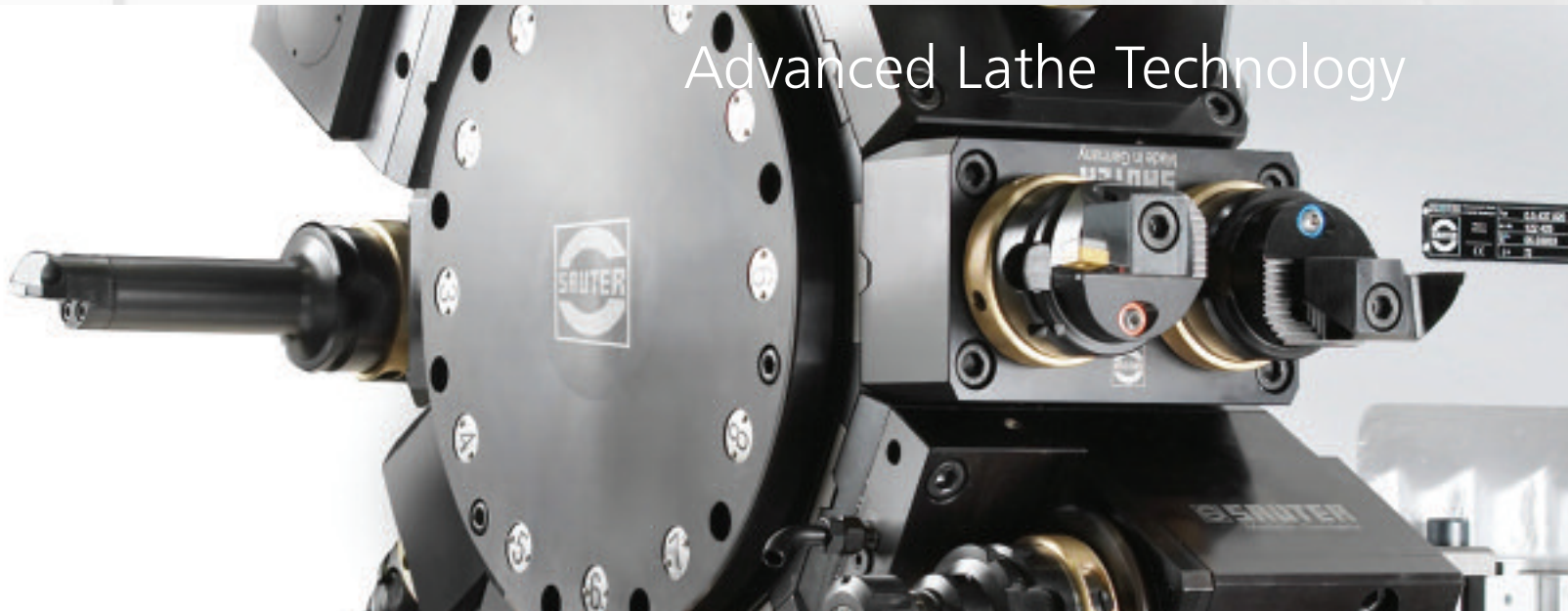

Advanced Lathe Technology



T6/8/10M TURRET

- 12 station automatic indexing driven tool turret
- AC servo motor drive for indexing
- Hydraulic locking
- Ultra high speed indexing
- Tools individually driven
- Axial tool mounting disc
- VDI type tooling



T8MS HIGH SPEED, HEAVY-DUTY TURRET

- 12 station automatic indexing driven tool turret
- Integrated AC servo motor drive for indexing
- Integrated motor for high speed, high power tool drive
- Hydraulic locking
- Ultra high speed indexing
- Tools individually driven
- Radial tool mounting (for back turning)
- BMT tooling standard HSK 63 type optional
- Max rpm driven tools 10,000 rpm
- Max power driven tools 14.5Hp (10kW)

Tornado T Series Dimensions

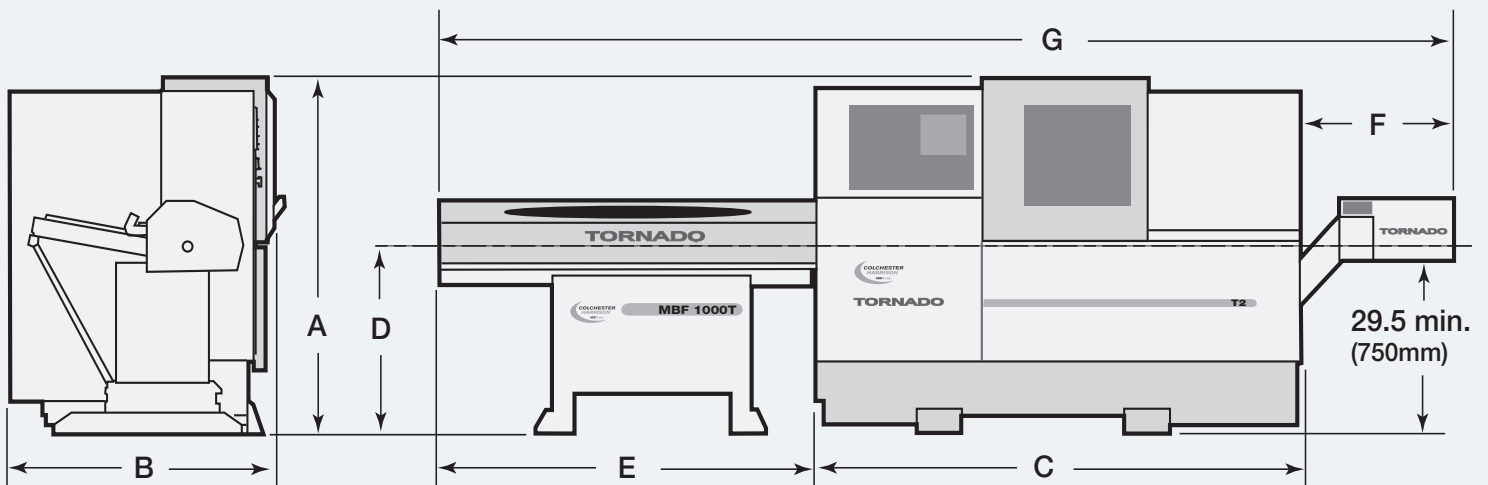

Model	T2	T4	T6M	T6MS	T8/T8M	T8MS/MSY	T10/MS
Machine Height A	66.9" (1700mm)	69.9" (1700mm)	73.2" (1860mm)	73.2" (1860mm)	76.8" (1955mm)	77.8" (1975mm)	77.8" (1975mm)
Machine Width B	51.6" (1312mm)	51.6" (1312mm)	64.8" (1647mm)	64.8" (1647mm)	61.8" (1570mm)	65.7" (1670mm)	65.7" (1670mm)
Machine Length C	94.7" (2405mm)	94.7" (2405mm)	102.6" (2605mm)	102.6" (2605mm)	106.3" (2700mm)	114.6" (2910mm)	114.6" (2910mm)
Center Height from Floor D	35.24" (895mm)	35.24" (895mm)	36.81" (935mm)	36.81" (935mm)	37.79" (960mm)	38.78" (985mm)	38.78" (985mm)
MBF1000 Barfeed Length E	66" (1675mm)	66" (1675mm)	66" (1675mm)	66" (1675mm)	66" (1675mm)	66" (1675mm)	66" (1675mm)
Chip Conveyor Length F	30.1" (765mm)	30.1" (765mm)	38.4" (975mm)	38.4" (975mm)	35.6" (905mm)	42.3" (1075mm)	42.3" (1075mm)
Length with Barfeed & Chip Conveyor G	190.7" (4845mm)	190.7" (4845mm)	206.9" (5255mm)	206.9" (5255mm)	207.9" (5280mm)	222.8" (5660mm)	222.8" (5660mm)

Specifications and design are subject to change without notice or obligation.

Tornado T Series Turret/Tooling Dimensions

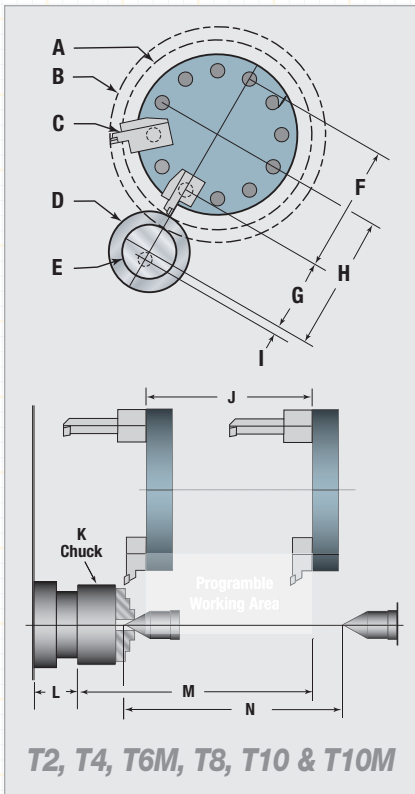

Model	T2	T4	T6M	T8	T10	T10M
Standard Tool A	15.75" (400mm)	15.75" (400mm)	16.38" (476mm)	18.35 (466mm)	20.71" (526mm)	20.31" (516mm)
Extended Tool B	17.91" (455mm)	17.91" (455mm)	18.74" (476mm)	20.94" (532mm)	23.31" (592mm)	22.91" (582mm)
VDI Tooling C	#30	#30	#30	#40	#40	#40
Max. Standard Tool D	6.69" (170mm)	9.06" (230mm)	9.06" (230mm)	10.23" (260mm)	7.07" (179.5mm)	7.26" (184.5mm)
Max. Extended Tool E	4.53" (115mm)	6.89" (175mm)	6.1" (155mm)	7.64" (194mm)	5.77" (146.5mm)	5.96 (151.5mm)
F	10.63" (270mm)	10.63" (270mm)	11.81" (300mm)	13.39" (340mm)	15.75" (400mm)	15.35" (390mm)
G	5.91" (150mm)	7.09" (180mm)	6.5" (165mm)	7.6" (193mm)	9.56" (242.5mm)	9.74" (247.5mm)
H	11.22" (285mm)	12.4" (315mm)	12.4" (315mm)	14.29" (363mm)	17.42" (442.5mm)	17.42" (442.5mm)
I	1.06" (27mm)	1.06" (27mm)	1.06" (27mm)	1.65" (42mm)	1.08" (27.5mm)	1.08" (27.5mm)
Work Travel J	13.78" (350mm)	17.72" (450mm)	17.72" (450mm)	21.26" (540mm)	23.62" (600mm)	23.62" (600mm)
Chuck K	6.7" (170mm)	6.7" (170mm)	6.7" (170mm)	8.27" (210mm)	10" (265mm)	10" (265mm)
L	3.7" (94mm)	3.7" (94mm)	3.5" (89mm)	2.05" (52mm)	2.36" (60mm)	2.36" (60mm)
M	19.49" (495mm)	23.43" (595mm)	23.62" (600mm)	27.36" (695mm)	27.8" (706mm)	27.8" (706mm)
Tailstock Body Travel N	21.26" (540mm)	21.26" (540mm)	21.26" (540mm)	23.62" (600mm)	23.62" (600mm)	23.62" (600mm)

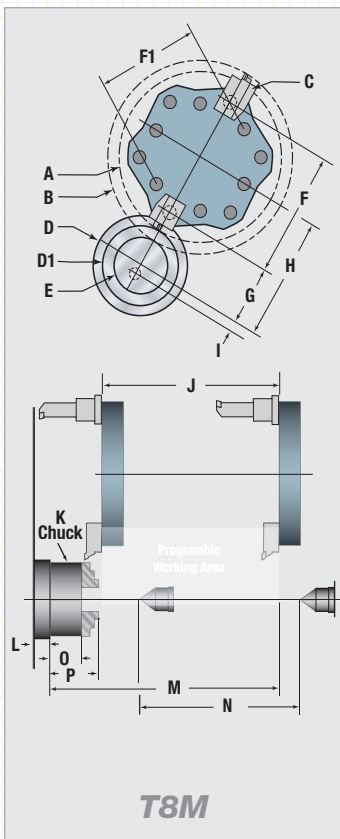

Model	T8M
Standard Tool A	19.52" (496mm)
Extended Tool B	22.13" (562mm)
VDI Tooling C	#40
Max. Dia. Std. Holder Inner Position D	11.42" (290mm)
Max. Dia. Std. Holder Outer Position D1	9.05" (230mm)
Max. Extended Tool E	6.44" (164mm)
F	14.57" (370mm)
F1	12.2" (310mm)
G	7.01" (178mm)
H	14.29" (363mm)
I	2.24" (363mm)
Work Travel J	21.26 (540mm)
Chuck K	8.26 (210mm)
L	2.05" (52mm)
M	27.36" (695mm)
Tailstock Body Travel N	23.62" (600mm)
O	3.66" (93mm)
P	5.74" (146mm)

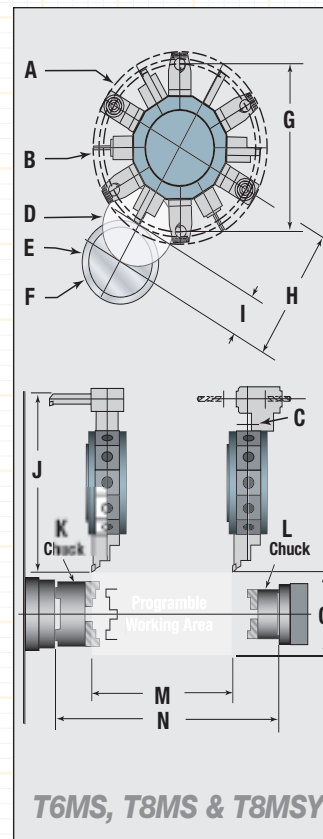

Model	T6MS	T8MS	T8MSY
Tool Tip Swing Over Cover A	19.88" (505mm)	26.06" (662mm)	19.88" (505mm)
Tool Tip Swing Over Saddle Wing B	18.35" (466mm)	23.77" (544mm)	18.35" (466mm)
VDI Tooling C	#30	#40	#30
To Clear B.Bar D	8.07" (205mm)	9.25" (235mm)	8.07" (205mm)
Max. Turned Diameter E	8.66" (220mm)	11.81" (300mm)	8.66" (220mm)
To Clear Index F	7.28" (185mm)	6.16" (182mm)	7.28" (185mm)
G	17.32" (440mm)	20.47" (520mm)	17.32" (440mm)
H	13.58" (345mm)	16.61" (422mm)	13.58" (345mm)
I	4.92" (125mm)	6.38" (162mm)	4.92" (125mm)
Standard Tooling J	18.5" (470mm)	21.77" (553mm)	18.5" (470mm)
Chuck K	6.7" (170mm)	10" (254mm)	10" (254mm)
Sub. Spindle Chuck L	5.12" (130mm)	6.7" (170mm)	6.7" (170mm)
M	17.72" (450mm)	21.02" (534mm)	21.02" (534mm)
Tailstock Body Travel N	27.09" (450mm)	35.04" (890mm)	35.04" (890mm)
O	8.66" (220mm)	11.81" (299mm)	11.81" (299mm)

Tornado T Series Power Diagrams

