

AVerMedia

AVerTV CaptureHD
AVer3D CaptureHD
H727E

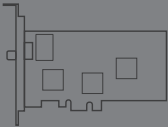

English
Deutsch
Français
Italiano
Español
Português
Ελληνική
Română
Русский

Quick Guide

European Community Compliance Statement



Class B

This product is herewith confirmed to comply with the requirements set out in the Council Directives on the Approximation of the laws of the Member States relating to Electromagnetic Compatibility Directive 2004/108/EC.

Responsible manufacturer:

AVerMedia Technologies, Inc.

No. 135, Jian 1st Rd., Zhonghe Dist., New Taipei City 23585, Taiwan

TEL: +886-2-2226-3630

European Community contact:

AVerMedia Technologies Europe B.V.

Kwartsweg 50, 2665 NN, Bleiswijk, The Netherlands

Technical Support: <http://www.avermedia.com/averty/Support/>



№ РОСС ТW.MP18.B15321
Срок действия с 26.11.2012г
по 25.11.2013г
MP18 Москва



The mark of Crossed-out wheeled bin indicates that this product must not be disposed of with your other household waste. Instead, you need to dispose of the waste equipment by handing it over to a designated collection point for the recycling of waste electrical and electronic equipment. For more information about where to drop off your waste equipment for recycling, please contact your household waste disposal service or the shop where you purchased the product.

WARNING

To prevent fire or shock hazard do not expose the unit to rain or moisture. Dangerously high voltages are present inside the unit. Do not open the unit. Refer servicing to qualified personnel only.

DISCLAIMER

All the screen shots in this documentation are only example images. The images may vary depending on the product and software version. Information presented in this documentation has been carefully checked for reliability; however, no responsibility is assumed for inaccuracies. The information contained in this documentation is subject to change without notice.

COPYRIGHT

©2013 by AVerMedia Technologies, Inc. All rights reserved.

No part of this document may be reproduced or transmitted in any form, or by any means (Electronic, mechanical, photocopy, recording, or otherwise) without prior written permission of AVerMedia Technologies, Inc.

Information in this document is subject to change without notice. AVerMedia Technologies, Inc. reserves the right to modify, change, improve or enhance its products and to make changes in the content without obligation to notify any person or organization of such changes. Please visit www.avermedia.com to get the updates of the operation and use of AVerMedia products.

"AVerMedia" is a trademark and logo of AVerMedia Technologies, Inc. DVB is a registered trademark of the DVB Project. Apple, the Apple logo, iPod, iPhone, iPad and Apple TV are trademarks and/or registered trademark of Apple Inc., registered in the U.S. and other countries. Other trademarks used herein for description purpose only belong to each of their companies. Made in Taiwan (Expect Accessories).

Picture shown may vary from actual product



IMPORTANT SAFETY INSTRUCTIONS

- Read Instructions - Read all the safety and operating instructions before connecting and operating your TV tuner to help ensure your own personal safety and to protect your product from potential damage.
- Retain Instructions - Retain all the safety and operating instructions for future reference.
- Heed Warnings - Adhere to all warnings on the product and the operating instructions.
- Grounding - For continued protection against risk of electric shock and fire, this accessory should be installed/connected only to the products, such as a computer, equipped with a three-wire grounding plug, a plug having a third (grounding) pin. This plug will only fit into a grounding-type power outlet. This is a safety feature. If you are unable to insert the plug into the outlet, contact your electrician to replace the obsolete outlet. Do not defeat the safety purpose of the grounding-type plug.
- Lightning - For added protection and to prevent damage due to lightning and power-line surges, unplug the host system, such as a computer, from the wall power outlet and disconnect the antenna or cable system. Unplug the host system from the wall power outlet when left unattended or unused for long periods of time.
- Never insert anything metallic into the TV tuner openings. Doing so may create the danger of electric shock.
- Openings in the TV tuner cabinet are provided for ventilation. To prevent overheating, these openings should not be blocked or covered. Avoid using the TV tuner on a bed, sofa, rug, or other soft surface, as doing so may block the ventilation openings in the cabinet. If you place the TV tuner in a bookcase or an enclosed space, be sure to provide adequate ventilation and air flow.
- Power Lines - An outside antenna system should not be located in the vicinity of overhead power lines or other light or power circuits, or where it can fall into such power lines or circuits.
- Antenna Installation - When installing an outside antenna system, extreme care should be taken to prevent it from touching such power lines or circuits, as contact with them may be fatal.
- Outdoor Antenna Grounding - If an outside antenna is connected to the product, ensure that the antenna system is grounded so as to provide some protection against voltage surges and built up static charges. Article 810.21 of the National Electric Code, ANSI/NFPA No.70, provides information with regard to proper grounding of the mast and supporting structure, grounding of the lead-in wire to the antenna discharge unit, size of grounding conductors, location of antenna-discharge unit, connection of grounding electrodes, and requirements for the grounding electrode.
- Caution for users/installers in Norway - In Norway, there exists a possibility of a hazardous situation due to voltage difference between the screen of the coaxial cable of the cable distribution system and the local equipment earth (typically, earthed chassis of the computer). To avoid any hazards, antenna/cable input connection from the TV tuner card to a Cable Distribution System must be provided through a galvanic isolator (not included).



Note: (for CATV system installer) This reminder is provided to call the CATV systems installer's attention to Section 820.93 of the National Electric Code, ANSI/NFPA 70:2005 (for US/Canada) and/or EN60728-11:2005 standard (for Europe), which provide guidelines for proper grounding and, in particular, specify that the coaxial cable shield shall be connected to the grounding system of the building, as close to the point of cable entry as practical.

Package Contents

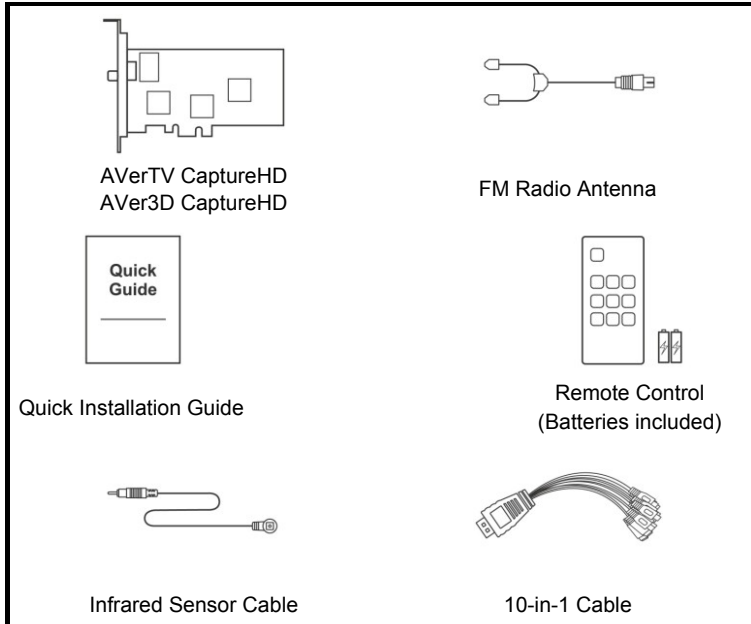

System Requirements

System requirements are described in detail on the package box. Before installing AVerTV CaptureHD/AVer3D CaptureHD, verify that your PC meets the described requirements.

Hardware Installation

Step 1. Installing the TV Tuner Card

1. Turn off the PC.
2. Remove the tower PC case.
3. Insert the tuner card into an empty PCI Express expansion slot on the motherboard.
4. Place the case back.

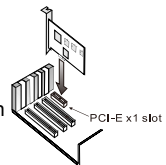

AVerTV CaptureHD / AVer3D CaptureHD

Step 2. Making the Connections

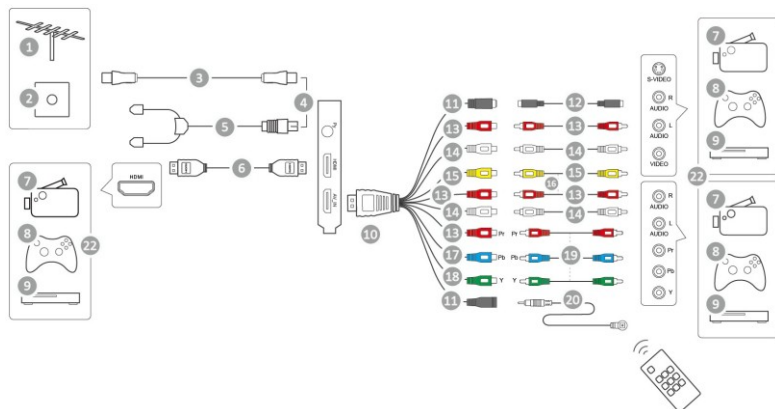

1	TV Antenna	12	S-Video Cable (not supplied)
2	TV Antenna Port	13	(Red)
3	TV Cable	14	(White)
4	OR	15	(Yellow)
5	FM Radio Antenna	16	Composite Cable (not supplied)
6	HDMI Cable (not supplied)	17	(Blue)
7	Camcorder	18	(Green)
8	Video Game	19	Component Cable (not supplied)
9	VCR/VCD/DVD Player	20	Infrared Sensor Cable
10	10-in-1 Cable	21	Remote Control
11	(Black)	22	Example

NOTE:

1. Video from component input that contains the Macrovision copy protection cannot be previewed.
2. HDMI source with HDCP (High-Bandwidth Digital Content Protection) cannot be recorded.
3. You can simultaneously enjoy HDMI or Component video in one window and watch TV, composite video or S-video video in the other window in PIP (Picture-in-Picture) / PBP (Picture-by-Picture) display mode. For more information, please refer to the user's manual.

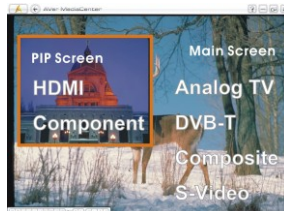

Installing Drivers and the TV Software Utility

After the device is installed properly, turn on the computer. The system will automatically detect the new device. Simply skip the wizard, and launch the application you download from AVerMedia website <http://q.avermedia.com/h727-download> to install the driver and TV software utility simultaneously.

Installing Drivers and the Application in Windows® XP / Windows® XP Media Center Edition

1. The “Found New Hardware Wizard” dialog box will appear. Just click **Cancel** to skip the Wizard installation procedures.
2. Launch the application you download from AVerMedia website.
3. When the installation main screen appears, choose **Install AVer MediaCenter 3D**.
4. Click **Next** to continue the installation process.
5. Read the license agreement and if you agree to the terms, select “I accept the terms of the license agreement” and then click **Next**.
6. Choose **Complete** to install all the necessary softwares, including **AVer MediaCenter 3D**, **DirectX 9.0c** and **Drivers**. Then click **Next**. For advanced users, it is recommended to choose **Custom** to select the software you want. To choose a different destination folder, click **Browse**.
7. In the “InstallShield Wizard” dialog box, if you are instructed to restart your computer, select **Yes**. Then click **Finish** to complete the installation.

Installing Drivers and Application in Windows® 7 / Windows® 8

1. The “Found New Hardware Wizard” dialog box will appear. Just click **Cancel** to skip the Wizard installation procedures.
2. Launch the application you download from AVerMedia website.
3. When the “AutoPlay” dialog box appears, select **Run Autorun.exe**.
4. When the installation main screen appears, choose **Install AVer MediaCenter 3D**.
5. If the “User Account Control” dialog box appears, select **Allow** to continue the process.
6. Click **Next** to continue the installation process.
7. Read the license agreement and if you agree to the terms, select “I accept the terms of the license agreement” and then click **Next**.

AVerTV CaptureHD / AVer3D CaptureHD

8. Choose **Complete** to install all the necessary softwares, including **AVer MediaCenter 3D**, **DirectX 9.0c** and **Driver**. Then click **Next**. For advanced users, it is recommended that you choose **Custom** to select the software you want. To choose a different destination folder, click **Browse**.
9. Then click **Finish** to complete the installation.

NOTE:

1. Make sure your system has DirectX 9.0c or above installed so that the TV software utility can function properly.
 2. The product does not come with a software DVD decoder. If users can playback DVD or MPEG-2 video files on the computer, there is no need to install a DVD decoder. However, if the Decoded Error message appears on the screen, please install the compatible DVD decoder via the Windows[®] XP Media Center Edition Partners site.
 3. The 3DTV functions in AVer MediaCenter 3D are not supported in the Windows[®] XP operating system.
-

Activating AVer MediaCenter 3D Application

Windows[®] XP / Windows[®] 7

To run the application from the Programs menu, choose **Start → Programs → AVerMedia → AVer MediaCenter → AVer MediaCenter 3D**.

Windows[®] 8

Click on **AVer MediaCenter 3D** on the Metro Start screen or double click on **AVer MediaCenter 3D** on the Desktop.

Uninstalling Application and Drivers

Windows[®] XP / Windows[®] XP Media Center Edition

To remove the installed TV software utility from the system, simply choose **Start → Programs → AVerMedia → AVer MediaCenter 3D → Uninstaller → Remove All → Next → OK → Finish**.

Windows[®] 7

1. To remove the installed TV software utility from the system, simply choose **Start → All Programs → AVerMedia → AVer MediaCenter 3D → Uninstaller**.
2. When the "User Account Control" dialog box appears, select **Allow**.



3. Select **Remove All** → **Next** → **OK** → **Finish**.

Windows® 8

1. Right click on **AVer MediaCenter 3D** on the Metro Start screen, and click on **Uninstall**.
2. In **Programs and Features**, select **AVer MediaCenter 3D** → **Uninstall/Change**.
3. Select **Remove All** → **Next** → **OK** → **Finish**.

Remote Control

After installing drivers and applications, you can use a remote control to turn on/off the programs, select channels, adjust volume and so on.



























- ◆ **Remote Turn-on Function:** When the PC is in turn-off mode, users can use remote control to turn on the PC and the application. To use, just point the remote control at the receiver and press  button to turn on the PC. Then press  button again to turn on the application.

NOTE:

1. The Remote Turn-On Function may be disabled depending on your PC motherboard.
 2. To enable the Remote Turn-On Function, please make sure you've enabled the PCI wake-up function in the BIOS setting. To do so, first enter the BIOS setting; then choose Power Management Setup and set PCI device to "Power On" (please note that the BIOS setting and descriptions may vary).
-













AVerTV CaptureHD / AVer3D CaptureHD

Remote Control Buttons



	Button	Description
	(1) 	Turn on/off the application.
	(2) 	Turn off/on the sound.
	(3) 	Use numeric buttons to select a channel.
	(4) 	Display TV in full screen.
	(5) 	Change between available audio modes.
	(6) 	<p>Main Screen: Use the arrow button to navigate all on-screen items. Use OK to confirm the selection.</p> <p>PIP Mode: Change size or position of the selected screen by the arrow buttons.</p>
	(7) 	Volume up / Volume down.
	(8) 	<p>Main Screen: A shortcut to the main menu-- "Video".</p> <p>Teletext Mode: Jump to the teletext page of the corresponding color according to this button.</p>
	(9) 	<p>Main Screen: A shortcut to the main menu--"TV".</p> <p>Teletext Mode: Jump to the teletext page of the corresponding color according to this button.</p>
	(10) 	View Teletext / Close Caption information.
	(11) 	View EPG information. (This function is only available for digital TV)
	(12) 	Record the current program.
	(13) 	Play the selected file or temporarily freeze the playback.

Quick Installation Guide



- (14)  - Go to the previous item in the playlist.
- Set the time to bring your computer out of Stand By or Hibernate mode. (This function is only available for AVerTV 3D)
-
- (15)  Move backwards in intervals.
-
- (16)  Skip forward in intervals.
-
- (17)  - Go to the next item in the playlist.
- Set the time to put your computer into Stand By / Hibernate mode, exit the application or turn off the computer. (This function is only available for AVerTV 3D)
-
- (18)  Stop the playback, recording, TimeShift, etc.
-
- (19)  - Switch from real-time TV or Radio to TimeShift mode.
- Temporarily freeze the playback. (This function is only available for AVerTV 3D)
-
- (20)  - Activate the Picture in Picture (PIP)
- Multi-Channel Display function.
-
- (21)  Capture an image or a continuous sequence of images.
-
- (22)  **Main Screen:** A shortcut to the main menu—"Pictures".
Teletext Mode: Jump to the teletext page of the corresponding color according to this button.
-
- (23)  **Main Screen:** A shortcut to the main menu—"Music".
Teletext Mode: Jump to the teletext page of the corresponding color according to this button.
-
- (24)  Channel up and channel down.
-
- (25)  Go back to the previous page.

AVerTV CaptureHD / AVer3D CaptureHD

- | | | |
|------|---|--|
| (26) |  | - Go to the main menu.
- Exit from CI/CA Information dialog.
(This function is only available for the device supporting CI/CA interface) |
| (27) |  | Return to previously accessed channel. |
| (28) |  | Change between available signal sources. |
-

Battery Safety Information:

- Store the batteries in a cool dry place.
- Do not dispose of used batteries in domestic waste. Dispose of batteries at special collection points or return to point of sale if applies.
- Remove the batteries during long periods of non-use. Always remove exhausted batteries from the remote control. Battery leakage and corrosion can damage this remote control, dispose of batteries safely.
- Do not mix old and new batteries.
- Do not mix different types of batteries: alkaline, standard (carbon-zinc) or rechargeable (nickel-cadmium).
- Do not dispose of batteries in a fire. The batteries may explode or leak.
- Never short circuit the battery terminals.

Packungsinhalt

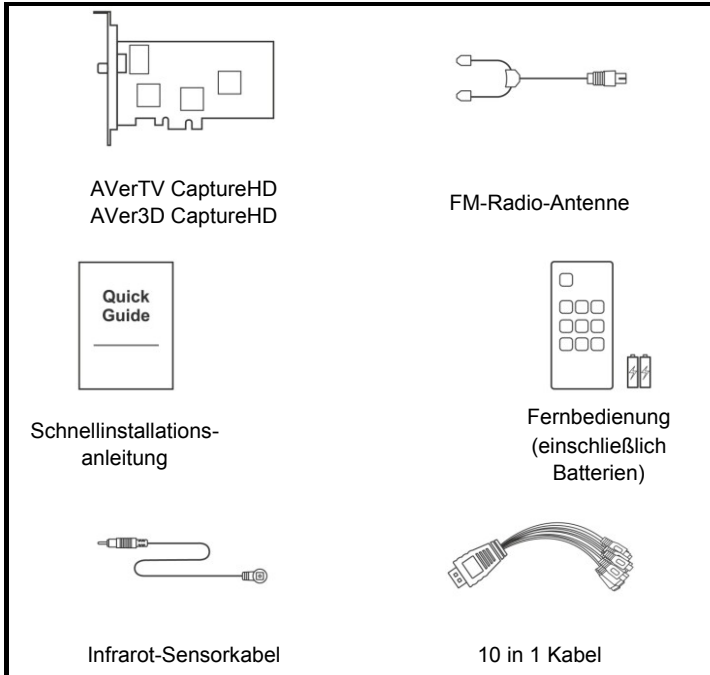

Deutsch

Systemvoraussetzungen

Systemvoraussetzungen sind auf dem Verpackungskarton angegeben. Bevor Sie die AVerTV CaptureHD/AVer3D CaptureHD installieren, stellen Sie sicher, dass Ihr PC die angegebenen Voraussetzungen erfüllt.

Hardware Installation

Schritt 1. Installieren der TV-Tunerkarte

1. Schalten Sie den Computer aus.
2. Entfernen Sie den Gehäusedeckel.
3. Stecken Sie die TV-Karte in einen freien PCI-Steckplatz Ihres Mainboards.
4. Schließen Sie den Gehäusedeckel wieder.

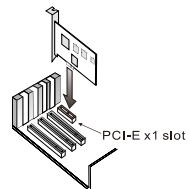

AVerTV CaptureHD / AVer3D CaptureHD

Schritt 2. Anschlüsse

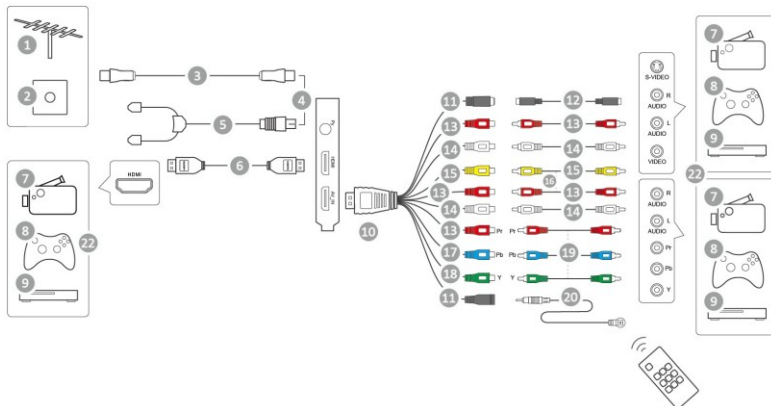

1	TV-Antenne	12	S-Video-Kabel (Nicht beiliegend)
2	TV Antennenanschluss	13	(Rot)
3	TV Kabel	14	(Weiß)
4	Oder	15	(Gelb)
5	FM-Radio-Antenne	16	Composite Kabel (Nicht beiliegend)
6	HDMI Kabel (Nicht beiliegend)	17	(Blau)
7	Camcorder	18	(Grün)
8	Videospielkonsole	19	Komponenten Kabel (Nicht beiliegend)
9	Videorecorder/ VCD/ DVD-Spieler	20	Infrarot-Sensorkabel
10	10 in 1 Kabel	21	Fernbedienung
11	(Schwarz)	22	Beispiele

HINWEIS:

1. Video vom Component Eingang, das den Macrovision Kopierschutz enthält kann nicht in einer Vorschau gesehen werden.
2. HDMI Quellen mit HDCP (High-Bandwidth Digital Content Protection) kann nicht aufgenommen werden.
3. Sie können gleichzeitig HDMI oder Component Video in einem Fenster und das TV Programm, Composite oder S-Video in einem anderen Fenster mit dem PIP (Picture-in-Picture) oder PBP (Picture-by-Picture) Modus sehen. Für mehr Informationen lesen Sie bitte die Bedienungsanleitung.

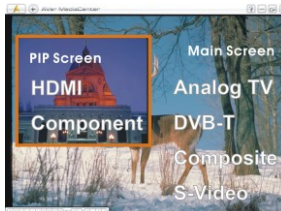

Installieren von Treibern und dem TV-Anwenderprogramm

Sobald Sie die Karte korrekt eingebaut haben, können Sie ihren Computer einschalten. Überspringen Sie den Assistenten einfach und starten zum gleichzeitigen Installieren von Treiber und TV-Softwaredienstprogramm die Applikation, die Sie von der AVerMedia-Website <http://q.avermedia.com/h727-download-de> heruntergeladen haben.

Installieren von Treibern und Anwenderprogramm unter Windows® XP / Windows® XP Media Center Edition

1. Die Dialogbox "Assistent für das Suchen neuer Hardware" erscheint. Klicken Sie auf Abbrechen, um den Installationsassistenten zu beenden.
2. Starten Sie die Applikation, die Sie von der AVerMedia-Website heruntergeladen haben.
3. Wenn das Installationsfenster erscheint, wählen Sie **Installieren AVer MediaCenter 3D**.
4. Klicken Sie auf **Weiter** um mit dem Installationsprozess fortzufahren.
5. Lesen Sie bitte die Lizenzbestimmungen und wenn Sie diesen zustimmen, wählen Sie „Ich akzeptieren die Lizenzbestimmungen“ und klicken dann auf **Weiter**.
6. Wählen Sie **Vollständig** um alle benötigten Softwarekomponenten zu installieren, inclusive **AVer MediaCenter 3D**, **DirectX 9.0c** und **Treiber**. Dann klicken Sie auf **Weiter**. Erfahrenen Anwendern wird empfohlen, **Individuell** anzuklicken und so die gewünschte Software auszuwählen. Um ein anderes Installationsverzeichnis zu wählen, klicken Sie auf **Durchsuchen**.
7. Wenn Sie in der Dialogbox "Installationsassistent" angewiesen werden, den Computer neu zu starten, klicken Sie auf Ja. Klicken Sie dann auf Beenden, um mit der Installation fortzufahren.

Installieren von Treibern und Anwenderprogramm unter Windows® 7 / Windows® 8

1. Die Dialogbox "Assistent für das Suchen neuer Hardware" erscheint. Klicken Sie auf Abbrechen, um den Installationsassistenten zu beenden.
2. Starten Sie die Applikation, die Sie von der AVerMedia-Website heruntergeladen haben.
3. Wenn die "AutoPlay" Anwendung erscheint, wählen Sie Run **Autorun.exe**.

AVerTV CaptureHD / AVer3D CaptureHD

4. Wenn das Installationsfenster erscheint, wählen Sie **Installieren AVer MediaCenter 3D**.
5. Wenn das "Nutzer Zugangskontrolle" Fenster erscheint, wählen Sie „Zulassen“ um fort zu fahren.
6. Klicken Sie auf **Weiter** um mit dem Installationsprozess fortzufahren.
7. Lesen Sie bitte die Lizenzbestimmungen und wenn Sie diesen zustimmen, wählen Sie „Ich akzeptieren die Lizenzbestimmungen“ und klicken dann auf **Weiter**.
8. Wählen Sie **Vollständig** um alle benötigten Softwarekomponenten zu installieren, inclusive **AVer MediaCenter 3D, DirectX 9.0c und Treiber**. Dann klicken Sie auf **Weiter**. Erfahrenen Anwendern wird empfohlen, **Individuell** anzuklicken und so die gewünschte Software auszuwählen. Um ein anderes Installationsverzeichnis zu wählen, klicken Sie auf **Durchsuchen**.
9. Klicken Sie dann auf **Beenden**, um mit der Installation fortzufahren.

HINWEIS:

1. Stellen Sie sicher, dass in Ihrem System DirectX 9.0c oder eine neuere Version installiert ist, so dass die TV-Software-Utility korrekt funktionieren kann.
2. Dieses Produkt wird ohne DVD Decoder geliefert. Wenn Sie DVD oder MPEG-2 Filme auf Ihrem Rechner abspielen können, müssen Sie keinen DVD Decoder installieren. Wenn jedoch ein Decoder Fehler in Windows® Media Center Edition erscheint, dann überprüfen Sie bitte auf der MCE Partnerseite, ob Ihr DVD Decoder Windows® Media Center Edition kompatibel ist.
3. Unter Windows® XP werden die 3DTV-Funktionen unter AVer MediaCenter 3D nicht unterstützt.

Aufrufen des AVer MediaCenter 3D-Anwenderprogramms

Windows® XP / Windows® 7

Um die TV-Applikation aus dem Programm Menü heraus zu starten, klicken Sie auf **Start**, wählen **Programme, AVerMedia, AVer MediaCenter** und klicken dort auf

AVer MediaCenter 3D.

Windows® 8

Klicken Sie am Metro-Startbildschirm auf **AVer MediaCenter 3D** oder doppelklicken Sie am Desktop auf **AVer MediaCenter 3D**.

Deinstallation von Anwendung und Treibern

Windows® XP / Windows® XP Media Center Edition

Um das installierte Programm von Ihrem System zu entfernen, wählen Sie **Start → Programme → AVerMedia → AVer MediaCenter 3D → Uninstaller → Alles entfernen → Weiter → OK → Beenden**.

Windows® 7



1. Um das installierte Programm von Ihrem System zu entfernen, wählen Sie **Start → Alles Programme → AVerMedia → AVer MediaCenter 3D → Uninstaller**.
2. Wenn das "Nutzer Zugangskontrolle" Fenster erscheint, wählen Sie „Zulassen“.
3. Wählen Sie **Alles entfernen → Weiter → OK → Beenden**.

Windows® 8

1. Rechtsklicken Sie am Metro-Startbildschirm auf **AVer MediaCenter 3D**, klicken Sie dann auf **Deinstallieren**.
2. Wählen Sie unter **Programme und Features** die Option **AVer MediaCenter 3D → Deinstallieren/ändern**
3. Wählen Sie **Alles entfernen → Weiter → OK → Beenden**.

Fernbedienung

Nach Installation der Treiber und Anwendungen können Sie die Fernbedienung verwenden, um Programme ein- und auszuschalten, Sender auszuwählen, die Lautstärke zu regeln usw.

- ◆ **Anschaltfunktion Fernbedienung:** Wenn der PC ausgeschaltet ist, kann der Nutzer über die Einschalttaste der Fernbedienung den Rechner und das Programm starten. Richten Sie die Fernbedienung auf den Receiver und drücken Sie die  Taste. Drücken Sie die  Taste ein weiteres Mal, um das Programm zu starten.

HINWEIS:

1. Die Funktion des Anschaltens per Fernbedienung könnte, abhängig vom Motherboard, deaktiviert sein.
 2. Um die Funktion zu aktivieren, vergewissern Sie sich, dass die PCI Aufweckfunktion im Bios aktiviert ist. Um diese zu aktivieren wählen sie „Power Managment Setup“ im Bios und setzen sie die PCI Schnittstelle als „Power On“. (Bitte beachten Sie die Anleitung ihres Computers, da die Einstellungen im Bios unterschiedlich sein können).
-

AVerTV CaptureHD / AVer3D CaptureHD

Fernbedienungsstasten

	Taste	Beschreibung
	(1)  Power	Anwendung ein-/ausschalten
	(2)  Mute	Schalten Sie den Ton ein/aus.
	(3) 	Wählen Sie einen TV-Sender.
	(4) 	Zeigen Sie TV- oder Video-Vollbildschirm an.
	(5)  Audio	Wechseln zwischen den verfügbaren Audiomodi.
	(6) 	Hauptmenü: Bewegen Sie sich mit den Pfeiltasten zwischen den Unterpunkten auf dem Bildschirm. Ihre Auswahl bestätigen Sie dann mit OK . PIP (Bild-im-Bild) Modus: Position oder Größe des ausgewählten Bildfensters ändern Sie mit den Pfeiltasten.
	(7) 	Lauter / Leiser.
	(8)  Video	Hauptmenü: Direktverbindung zum Menü - "Video". Teletext-Modus: Springen Sie zur Teletextseite der entsprechenden Farbe dieser Schaltfläche.
	(9)  TV	Hauptmenü: Direktverbindung zum Menü - "TV". Teletext-Modus: Springen Sie zur Teletextseite der entsprechenden Farbe dieser Schaltfläche.
	(10)  Text	Teletext / Closed Caption anzeigen.
	(11)  EPG	EPG-Informationen anzeigen. (Diese Funktion ist nur bei digitalem Fernsehen und Radio nutzbar)
	(12) 	Aktuelles Programm aufnehmen.
	(13) 	Abspielen der ausgewählten Datei oder

Schnellinstallationsanleitung

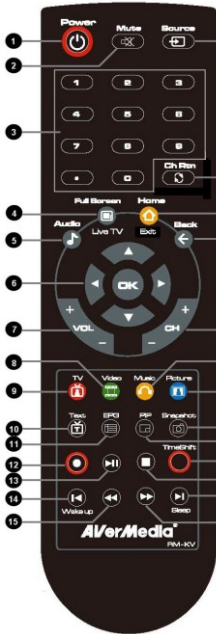

- kurzes Pausieren.
- (14)  Zurück zur vorigen Datei in der Wiedergabeliste.
- (15)  In Intervallen zurückspringen.
- (16)  In Intervallen vorspringen.
- (17)  Zur nächsten Datei auf der Wiedergabeliste.
- (18)  Anhalten von Wiedergabe, Aufnahme, TimeShift etc.
- (19)  Wechseln Sie von Echtzeit-TV- oder Radio- zum TimeShift-Modus.
- (20)  Bild-im-Bild (PIP) / Multi Kanal-Anzeigefunktion aktivieren.
- (21)  Nimmt Einzelbild oder Bildsequenz auf.
- (22)  **Hauptmenü:** Direktverbindung zum Menü - "Bilder".
Teletext-Modus: Springen Sie zur Teletextseite der entsprechenden Farbe dieser Schaltfläche.
- (23)  **Hauptmenü:** Direktverbindung zum Menü - "Musik".
Teletext-Modus: Springen Sie zur Teletextseite der entsprechenden Farbe dieser Schaltfläche.
- (24)  Kanal aufwärts und Kanal abwärts.
- (25)  Zurück zur vorherigen Seite.
- (26)  Zurück zum Hauptmenü.
- (27)  Zurück zum vorher angezeigten Kanal.
- (28)  Wechsel zwischen verschiedenen Signalquellen.

AVerTV CaptureHD / AVer3D CaptureHD



DER SICHERE UMGANG MIT BATTERIEN:

- **Achtung!** Im Lieferumfang befinden sich Batterien. Batterien gehören nicht in den Hausmüll. Sie werden vom Hersteller, Händler oder deren Beauftragten kostenlos zurückgenommen, um sie einer Verwertung bzw. Entsorgung zuzuführen.
- Wenn Sie Fragen zur Entsorgung haben, wenden Sie sich bitte an Ihre Verkaufsstelle oder an unseren Service.
- Batterien können brennbare Stoffe enthalten. Bei unsachgemäßer Behandlung können Batterien auslaufen, sich stark erhitzen, entzünden oder gar explodieren, was Schäden für Ihr Gerät und ihre Gesundheit zur Folge haben könnte.
- Bitte befolgen Sie unbedingt folgende Hinweise: Vermeiden Sie Hitze und werfen Sie die Batterien nicht ins Feuer.
- Zerlegen oder verformen Sie die Batterien nicht. Ihre Hände oder Finger könnten verletzt werden oder Batterieflüssigkeit könnte in Ihre Augen oder auf Ihre Haut gelangen. Sollte dies passieren, spülen Sie die entsprechenden Stellen mit einer großen Menge klaren Wassers und informieren Sie umgehend Ihren Arzt.
- Vermeiden Sie starke Stöße und Erschütterungen.
- Entfernen Sie die Batterie aus der Fernbedienung, wenn diese über einen längeren Zeitraum nicht benutzt wird.

Contenu de l'emballage

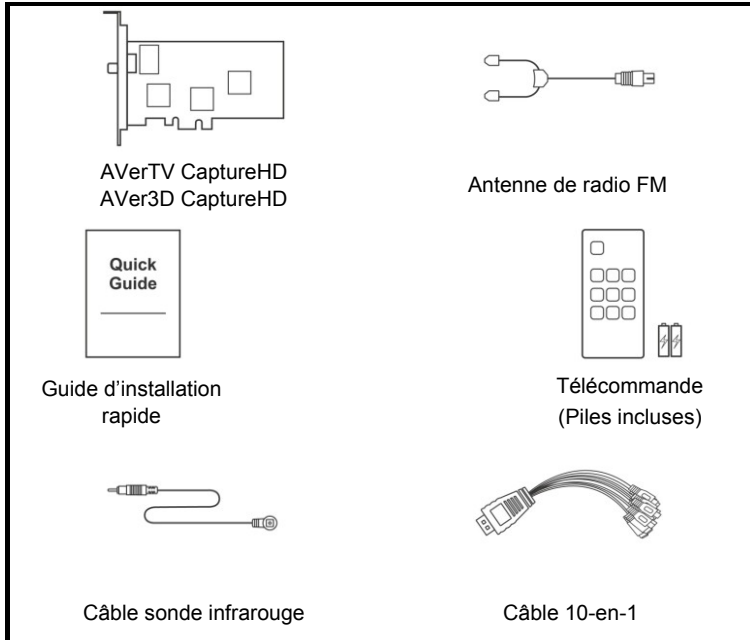

Configuration système requise

La configuration système requise est décrite en détails sur la boîte de l'emballage. Avant d'installer AVerTV CaptureHD/AVer3D CaptureHD, vérifiez que votre ordinateur possède la configuration requise donnée.

Installation du matériel

Etape 1. Installation de la carte tuner TV

1. Mettez votre ordinateur hors tension.
2. Retirez le couvercle du boîtier.
3. Insérez la carte tuner dans le port PCI-E de la carte mère.
4. Remplacez le couvercle.

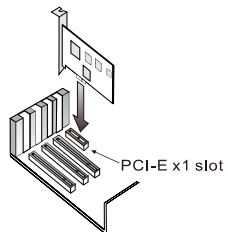

AVerTV CaptureHD / AVer3D CaptureHD

Etape 2. Les connexions

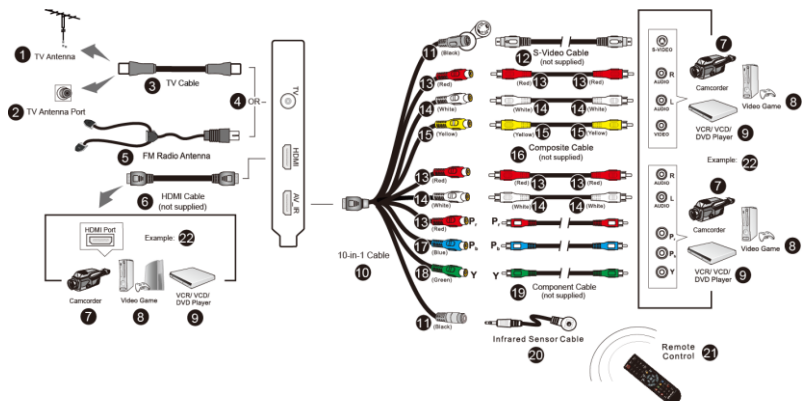

1	Antenne TV	12	Câble S-vidéo (non fourni)
2	Port d'antenne TV	13	(Rouge)
3	Câble TV	14	(Blanc)
4	OU	15	(Jaune)
5	Antenne de radio FM	16	Câble Composite (non fourni)
6	Câble HDMI (non fourni)	17	(Bleu)
7	Camescope	18	(Vert)
8	Jeux vidéo	19	Câble composant (non fourni)
9	Joueur du Magnétoscope VCD/ DVD	20	Câble sonde infrarouge
10	Câble 10-en-1	21	Télécommande
11	(Noir)	22	Exemple

REMARQUE:

- Les vidéos importées à partir de l'entrée composante ne pourront pas être prévisualisées si elles sont protégées par le système d'anti-piratage Macrovision.
- Les sources HDMI avec HDCP (Protection des Données Numériques) ne pourront pas être enregistrées.
- La fonction PIP (Picture in Picture) / PBP (Picture by Picture) vous permet de regarder simultanément une vidéo provenant d'une source HDMI ou composante dans une première fenêtre et, dans une autre fenêtre, vous pourrez regarder la TV, ou une vidéo provenant d'une source vidéo composite/s-vidéo. Pour plus d'informations, merci de vous référer au manuel d'utilisation.



Installation des pilotes et du logiciel utilitaire TV

Une fois la carte correctement installée, mettez l'ordinateur sous tension. Le système détectera automatiquement le nouveau périphérique. Ignorez simplement l'assistant d'installation, et lancez l'application que vous avez téléchargée sur le site Avermedia pour installer <http://q.avermedia.com/h727-download-fr> le pilote et le logiciel TV simultanément.

Installation des pilotes et Application sous Windows® XP / Windows® XP Media Center Edition

1. La boîte de dialogue "Assistant du nouveau matériel trouvé" apparaît. Cliquez simplement sur Annuler pour passer les procédures d'installation de l'assistant.
2. Lancez l'application que vous avez téléchargée depuis le site AVerMedia.
3. Lorsque l'écran d'installation apparaît, choisissez **Installer AVer MediaCenter 3D**.
4. Cliquez sur **Suivant** pour poursuivre le processus d'installation.
5. Lisez l'accord de licence et si vous êtes d'accord avec ses termes, sélectionnez « J'accepte les termes de l'accord de licence » et cliquez ensuite sur **Suivant**.
6. Choisissez **Complète** pour installer tous les composants nécessaires, **AVer MediaCenter 3D**, **DirectX9.0c** et **les Drivers**. Cliquez ensuite sur **Suivant**. Pour les utilisateurs expérimentés, il est recommandé de choisir « Personnalisé » pour sélectionner les composants désirés. Pour choisir un répertoire de destination différent, cliquez sur **Parcourir**.
7. Dans la boîte de dialogue "Assistant InstallShield ", si vous êtes invité à redémarrer votre ordinateur, sélectionner **Oui**. Puis cliquez sur Terminer pour achever l'installation.

Installation des pilotes et Application sous Windows® 7 / Windows® 8

1. La boîte de dialogue "Assistant du nouveau matériel trouvé" apparaît. Cliquez simplement sur Annuler pour passer les procédures d'installation de l'assistant.
2. Lancez l'application que vous avez téléchargée depuis le site AVerMedia.
3. Lorsque la boîte de dialogue "AutoPlay" apparaît, sélectionnez **Run Autorun.exe**.
4. Lorsque l'écran d'installation apparaît, choisissez **Installer AVer MediaCenter 3D**.
5. Si la boîte de dialogue "Paramètres du Compte Utilisateur" apparaît, choisissez "Autoriser" pour continuer la procédure.
6. Cliquez sur **Suivant** pour poursuivre le processus d'installation.
7. Lisez l'accord de licence et si vous êtes d'accord avec ses termes, sélectionnez « J'accepte les termes de l'accord de licence » et cliquez ensuite sur **Suivant**.
8. Choisissez **Complète** pour installer tous les composants nécessaires,

AVerTV CaptureHD / AVer3D CaptureHD

AVer MediaCenter 3D, DirectX9.0c et les Drivers. Cliquez ensuite sur **Suivant**.

Pour les utilisateurs expérimentés, il est recommandé de choisir « Personnalisé » pour sélectionner les composants désirés. Pour choisir un répertoire de destination différent, cliquez sur **Parcourir**.

9. Puis cliquez sur Terminer pour achever l'installation.

REMARQUE:

1. Assurez-vous que votre système possède DirectX 9.0c ou supérieur installé pour que le logiciel utilitaire de télévision puisse fonctionner correctement.
 2. Le produit n'est pas fourni avec un décodeur DVD. Si l'utilisateur peut lire des DVD et des fichiers vidéo MPEG-2 sur son ordinateur, il n'est pas nécessaire d'installer un décodeur DVD. Cependant, si le message Erreur de décodage apparaît sur l'écran, veuillez installer le décodeur DVD compatible par le site Windows® XP Media Center Edition Partners.
 3. Les fonctions TV 3D d' AVerMediaCenter 3D ne sont pas prises en charge par le système d'exploitation Windows® XP.
-

Activation de l'Application AVer MediaCenter 3D

Windows® XP / Windows® 7

Pour lancer l'application depuis le menu Programmes, cliquez sur **Start**, pointez sur **Programmes**, choisissez **AVerMedia**, **AVer MediaCenter** et cliquez ensuite sur **AVer MediaCenter 3D**.

Windows® 8

Cliquez sur **AVer MediaCenter 3D** sur l'écran de démarrage en carreaux ou faites un clic double sur **AVer MediaCenter 3D** sur le bureau.

Désinstallation de l'application et des pilotes

Windows® XP / Windows® XP Media Center Edition

Pour désinstaller le logiciel TV de votre système, choisissez simplement **Démarrer → Programmes → AVerMedia → AVer MediaCenter 3D → Désinstaller → Supprimer Tout → Suivant → OK → Terminer**.

Windows® 7

1. Pour désinstaller l'application TV installée de votre système, choisissez simplement **Démarrer → Tous les programmes → AVerMedia → AVer MediaCenter 3D → Désinstaller**.
2. Lorsque la fenêtre "Paramètres du Compte Utilisateur" apparaît, choisissez

Autoriser.



3. Choisissez simplement **Supprimer Tout** → **Suivant** → **OK** → **Terminer**.

Windows® 8

1. Faites un clic droit sur **AVer MediaCenter 3D** sur l'écran de démarrage en carreaux puis cliquez sur **Désinstaller**.
2. Dans **Programmes et fonctionnalités**, sélectionnez **AVer MediaCenter 3D** → **Désinstaller/Modifier**.

Télécommande

Après avoir installé les pilotes et les applications, vous pouvez utiliser la télécommande pour activer/désactiver les programmes, sélectionner les chaînes, ajuster le volume, etc.













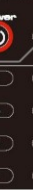

- ◆ **Fonction "Power On" télécommandée:** Lorsque le PC est éteint, les utilisateurs peuvent utiliser la télécommande pour allumer le PC à distance et lancer automatiquement l'application TV. Pour l'utiliser, dirigez simplement la télécommande vers le récepteur infrarouge et appuyez sur le bouton sur  pour allumer le PC. Ensuite, appuyez sur le bouton  pour lancer l'application.

REMARQUE:

1. La fonction de mise en route à distance depuis la télécommande peut être désactivée par défaut, en fonction de la carte mère de votre PC.
 2. Pour activer la fonction de mise à distance depuis la télécommande, veuillez vérifier que la fonction de réveil automatique PCI est activée dans les paramètres du BIOS. Pour ce faire, entrez dans le menu de paramétrage du BIOS, ensuite choisissez « Power Management SetUp » et mettez le matériel PCI sous « Power On » (Merci de tenir compte que les paramètres des menus peuvent varier d'un BIOS à l'autre).
-



















AVerTV CaptureHD / AVer3D CaptureHD

Boutons de la télécommande

Boutons	Description
	(1) Power Activer/Désactiver l'application.
	(2) Mute Couper/remettre le son.
	(3) Utilisez les touches numériques pour sélectionner une chaîne.
	(4) Affichage de la télévision ou de la vidéo en plein écran.
	(5) Audio Basculer entre les modes audio disponibles.
	(6) Écran principal: Utilisez les touches fléchées pour naviguer parmi tous les éléments à l'écran. Appuyez sur OK pour valider la sélection. Mode PIP: Déplacez ou redimensionnez l'écran sélectionné à l'aide des touches fléchées.
	(7) Augmenter le volume / Réduire le volume.
	(8) Écran principal: Raccourci vers le menu principal "Vidéo". Mode Télétexte: Sauter à la page télétexte de la couleur correspondante conformément à ce bouton.
	(9) Écran principal: Raccourci vers le menu principal "TV". Mode Télétexte: Sauter à la page télétexte de la couleur correspondante conformément à ce bouton.
	(10) Afficher les informations Télétexte / le sous-titrage "Close Caption"
	(11) Afficher les informations EPG. (Cette fonction n'est disponible qu'en radio et TV numérique).
	(12) Enregistrer le programme en cours.
	(13) Lire le fichier sélectionné ou suspendre temporairement la lecture.
	(14) - Revenir au titre précédent de la liste de lecture. - Réglez l'heure de fin du mode veille partielle ou prolongée de votre ordinateur. (cette fonction concerne uniquement AVerTV 3D)

Guide d'installation rapide



- (15)  Reculer par intervalles.
- (16)  Avancer par intervalles.
- (17)  - Passer au titre suivant de la liste de lecture.
 - Régler l'heure à laquelle il faut mettre votre ordinateur en mode Veille/Veille prolongée, quitter l'application ou éteindre l'ordinateur. (cette fonction concerne uniquement AVerTV 3D)
- (18)  Arrête la lecture, l'enregistrement, la programmation, etc.
- (19)  - Bascule de la télévision ou de la radio en temps réel au mode TimeShift (programmation).
 - Suspendre temporairement la lecture. (cette fonction concerne uniquement AVerTV 3D)
- (20)  Activer la fonction d'Incrustation PIP / Affichage multi-chaînes.
- (21)  Capturez une image (ou une séquence continue d'images).
- (22)  **Écran principal:** Raccourci vers votre menu principal "Photos".
 **Mode Télétexte:** Sauter à la page télétexte de la couleur correspondante conformément à ce bouton.
- (23)  **Écran principal:** Raccourci vers votre menu principal "Musique".
 **Mode Télétexte:** Sauter à la page télétexte de la couleur correspondante conformément à ce bouton.
- (24)  Chaîne suivante et chaîne précédente.
- (25)  Retourner à la page précédente.
- (26)  - Aller au menu principal.
 - Sortie de la dialogue information CI/CA. (cette fonction marche uniquement avec le matériel équipé avec un slot CI/CA)
- (27)  Revenir à la chaîne précédemment choisie.
- (28)  Basculer entre les sources de signal disponibles.

AVerTV CaptureHD / AVer3D CaptureHD

Informations sur la sécurité des piles :

- Stockez les piles dans un endroit frais et sec.
- Ne jetez pas les piles avec les ordures ménagères. Mettez les piles au rebut dans les points de récupération des piles ou, éventuellement, ramenez-les chez le détaillant.
- En cas de non utilisation prolongée, sortez les piles. Sortez toujours les piles épuisées de la télécommande. Les fuites des piles et la corrosion risqueraient d'endommager la télécommande, mettez les piles au rebut en toute sécurité.
- Ne pas mélanger piles usagées et neuves.
- Ne pas mélanger des piles de types différents : alcaline, standard (carbone-zinc) ou rechargeables (nickel-cadmium).
- Ne pas jeter les piles au feu. Les piles risquent d'exploser ou de fuir.
- Ne jamais court-circuiter les terminaux des piles.

Contenuto della confezione

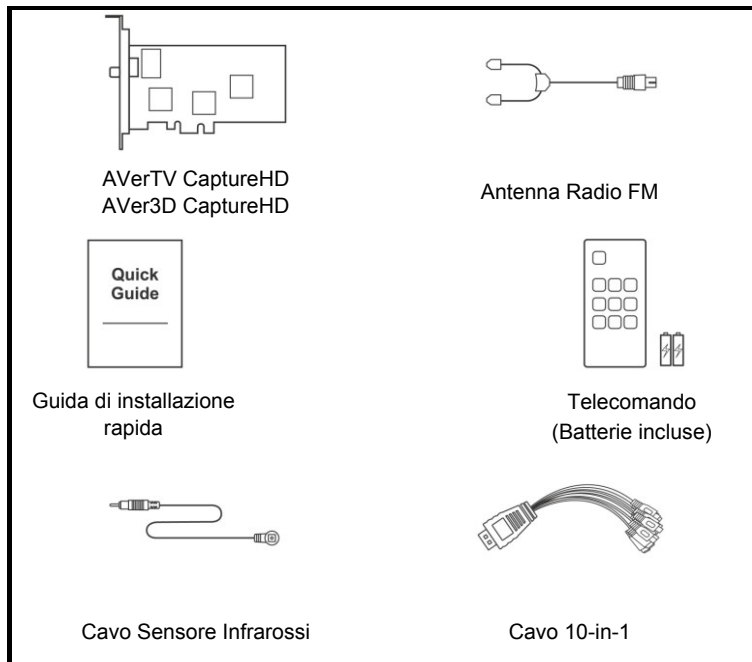

Italiano

Requisiti di sistema

I requisiti di sistema sono descritti dettagliatamente nella scatola della confezione. Prima di installare AVerTV CaptureHD/AVer3D CaptureHD, verificare che il computer soddisfi i requisiti necessari.

Installazione dell'Hardware

Fase 1. Installazione della scheda del sintonizzatore TV

1. Spegnete il PC.
2. Rimuovete il coperchio.
3. Inserire la scheda del sintonizzatore nello slot di espansione PCI-E vuoto della scheda madre.
4. Rimettete a posto il coperchio.

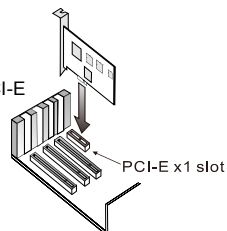

AVerTV CaptureHD / AVer3D CaptureHD

Fase 2 : Creazione di una connessione

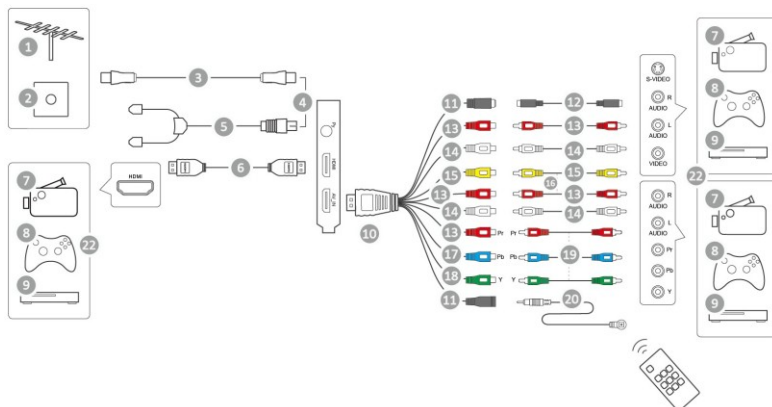

1	TV Antenna	12	Cavo S-Video (non in dotazione)
2	Ingresso Antenna TV	13	(Rosso)
3	Cavo TV	14	(Bianco)
4	O	15	(Giallo)
5	Antenna Radio FM	16	Cavo composito (non in dotazione)
6	Cavo HDMI (non in dotazione)	17	(Blu)
7	Camcorder	18	(Verde)
8	Videogioco	19	Cavo component (non in dotazione)
9	Riproduttore VCR/ VCD/ DVD	20	Cavo Sensore Infrarossi
10	Cavo 10-in-1	21	Telecomando
11	(Nero)	22	Esempio

NOTA:

1. Video di ingresso component che contengono il Macrovision di protezione da copia non possono essere visti in anteprima.
2. La ricezione in HDMI con HDCP (High-Bandwidth Digital Content Protection) non può essere registrata
3. È possibile guardare contemporaneamente guardare la TV, HDMI o component video in una finestra e in video composito o S-video in altra finestra di PIP (Picture-in-Picture) / PBP (Picture-by-Picture) modalità di visualizzazione. Per ulteriori informazioni, si prega di consultare il manuale utente.

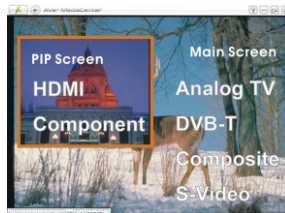

Installazione dei driver e delle utility TV

Dopo che la scheda è installata in modo corretto, accendete il computer. Basta saltare la procedura guidata e avviare l'applicazione scaricata dal sito web AVerMedia <http://q.avermedia.com/h727-download> per installare contemporaneamente il driver e l'utility del software TV.

Installazione dei driver e dell'applicazione in Windows® XP / Windows® XP Media Center Edition

1. Appare la finestra di dialogo "Installazione guidata nuovo hardware". Basta fare clic su **Annulla** per ignorare le procedure di installazione guidata.
2. Avviare l'applicazione scaricata dal sito web AVerMedia.
3. Quando sullo schermo principale dell'installazione compare, scegli installa **AVer MediaCenter 3D**.
4. Fare clic su **Avanti** per continuare con la procedura d'installazione.
5. Leggere il contratto di licenza, selezionare "Accetto i termini dell'accordo di licenza" e poi fare clic su **Avanti**.
6. Scegli completo installa tutti i softwares necessari, compreso **AVer MediaCenter 3D, DirectX 9.0c and Drivers**. Poi clicca su **Avanti**. Per utenti avanzati, si raccomanda di scegliere **Personalizza** per selezionare il software desiderato. Per scegliere un'altra cartella di destinazione, fare clic su **Sfoggia**.
7. Se nella finestra di dialogo "Installazione guidata InstallShield" viene chiesto di riavviare il computer, scegliere **Sì**.

Installazione dei driver e dell'applicazione in Windows® 7 / Windows® 8

1. Appare la finestra di dialogo "Installazione guidata nuovo hardware". Basta fare clic su **Annulla** per ignorare le procedure di installazione guidate.
2. Avviare l'applicazione scaricata dal sito web AVerMedia.
3. Quando appare la finestra di dialogo "AutoPlay" (Esecuzione automatica), selezionare **Run Autorun.exe (Esegui Autorun.exe)**.
4. Quando sullo schermo principale dell'installazione compare, scegli installa **AVer MediaCenter 3D**.
5. Se appare la finestra di dialogo "User Account Control" (Controllo account utente), selezionare **Allow (Consenti)** per continuare la procedura.
6. Fare clic su **Avanti** per continuare con la procedura d'installazione.
7. Leggere il contratto di licenza, selezionare "Accetto i termini dell'accordo di licenza" e

AVerTV CaptureHD / AVer3D CaptureHD

poi fare clic su **Avanti**.

8. Scegli completo installa tutti i softwares necessari, compreso **AVer MediaCenter 3D**, **DirectX 9.0c** and **Drivers**. Poi clicca su **Avanti**. Per utenti avanzati, si raccomanda di scegliere **Personalizza** per selezionare il software desiderato. Per scegliere un'altra cartella di destinazione, fare clic su **Sfoglia**.
9. Fare clic su **Fine** per completare l'installazione.

NOTA:

1. Per il corretto funzionamento dell'utilità software TV, accertarsi che sul sistema sia installato DirectX 9.0c o versione successiva.
2. Il prodotto non viene fornito con un software per decoder DVD. Se gli utenti possono presincronizzare un DVD o dei file video MPEG-2 sul computer non c'è alcuna necessità di installare un decoder DVD. Comunque se sullo schermo compare un messaggio di Errore Decodificazione si prega di installare un decoder DVD compatibile attraverso il sito Windows® XP Media Center Edition Partners.
3. Le funzioni 3DTV in AVer MediaCenter 3D non sono supportate nel sistema operativo Windows® XP.

Come lanciare l'applicazione AVer MediaCenter 3D

Windows® XP / Windows® 7

Per eseguire l'applicazione dal menu Programmi, fare clic su **Start → Programs (Programmi) → AVerMedia → AVer MediaCenter → AVer MediaCenter 3D**.

Windows® 8

Fare clic su **AVer MediaCenter 3D** nella schermata Metro Start oppure fare doppio clic su **AVer MediaCenter 3D** sul desktop.

Rimozione dell'applicazione e dei driver

Windows® XP / Windows® XP Media Center Edition

Se si è in modalità Media Center (Centro multimediale), uscire e passare a Windows. Per rimuovere dal sistema l'utilità software TV installata, scegliere **Start → Programs (Programmi) → AVerMedia → AVer MediaCenter 3D → Uninstaller (Rimozione) → Remove All (Rimuovi tutto) → Next (Avanti) → OK → Finish (Fine)**.

Windows® 7



1. Per rimuovere dal sistema l'utilità software TV installata, scegliere **Start** → **All Programs (Tutti i programmi)** → **AVerMedia** → **AVer MediaCenter 3D** → **Uninstaller (Rimozione)**.
2. Quando appare la finestra di dialogo "User Account Control" (Controllo account utente), selezionare **Allow (Consenti)**.
3. Scegliere **Remove All (Rimuovi tutto)** → **Next (Avanti)** → **OK** → **Finish (Fine)**.

Windows® 8

1. Fare clic col tasto destro del mouse su **AVer MediaCenter 3D** nella schermata Metro Start, quindi fare clic su **Uninstall (Rimuovi)**.
2. In **Programs and Features (Programmi e funzioni)**, selezionare **AVer MediaCenter 3D** → **Uninstall/Change (Rimuovi/Cambia)**.

Telecomando

Dopo aver installato i driver e le applicazioni, è possibile utilizzare il telecomando per attivare o disattivare i programmi, selezionare i canali, regolare il volume e così via.





- **Funzione di accensione Remota:** Quando il PC è in modalità di turn-off, gli utenti possono utilizzare il controllo remoto per attivare il PC e l'applicazione. Per utilizzarlo, basta puntare il telecomando verso il ricevitore e premere il tasto  per accendere il PC. Quindi premere nuovamente il tasto  per attivare l'applicazione.

NOTA:









1. La funzione di accensione remota potrebbe essere disabilitata, questo potrebbe dipendere dalla vostra scheda madre nel PC.
 2. Per attivare la funzione di accensione nel telecomando, bisogna assicurarsi di aver abilitato il risveglio del bus PCI nella impostazione del BIOS. Per farlo, bisogna aprire impostazione dal BIOS, quindi scegliere il programma di installazione e di gestione della potenza impostata sulla periferica PCI a "Power On" (si prega di notare che l'impostazione del BIOS e le descrizioni possono variare).
-

AVerTV CaptureHD / AVer3D CaptureHD



Pulsanti del telecomando

	Pulsante	Descrizione
1		(1) Power Attivazione/Disattivazione dell'applicazione
2		(2) Mute Attivare/disattivare il suono.
3		(3) Usare i tasti numerici per selezionare un canale.
4		(4) Passa alla modalità schermo intero.
5		(5) Audio Scelta modalità audio
6		(6) Schermata principale: Usare la freccia per scorrere tra tutte le voci su schermo. Usare OK per confermare la selezione. Modalità PIP: Sposta o cambia le dimensioni della schermata selezionata usando le frecce.
7		(7) Volume su / Volume giù.
8		(8) Schermata principale: Collegamento al menu principale -- "Video". Modalità Televideo: Passa alla pagina teletext del colore corrispondente al pulsante.
9		(9) Schermata principale: Collegamento al menu principale -- "TV". Modalità Televideo: Passa alla pagina teletext del colore corrispondente al pulsante.
10		(10) Text Visualizza Televideo / informazioni Didascalie.
11		(11) EPG Visualizza informazioni guida TV elettronica (EPG). (Questa funzione è disponibile solo per TV)
12		(12) Registra lo spettacolo TV attuale.
13		(13) Esegue il file selezionato oppure blocca temporaneamente la riproduzione.
14		(14) - Va alla voce precedente dell'elenco d'esecuzione. - Imposta il tempo che deve trascorrere prima che il computer esca dalla

Guida di installazione rapida

	<p>modalità Standby (Standby) o Ibernata (Hibernate). (Questa funzione è disponibile esclusivamente per AVerTV 3D)</p>
	<p>(15)  Va indietro ad intervalli.</p>
	<p>(16)  Va avanti ad intervalli</p>
	<p>(17)  Bleep</p> <p>- Va alla voce successiva dell'elenco d'esecuzione - Impostare l'orario in cui il computer accederà alla modalità di Standby/Ibernazione. (Questa funzione è disponibile esclusivamente per AVerTV 3D)</p>
	<p>(18)  Interrompi riproduzione, registrazione, time shift ecc.</p>
	<p>(19)  TimeShift</p> <p>- Passa dalla modalità Radio o TV in tempo reale alla modalità Differita. - Sospende la riproduzione. (Questa funzione è disponibile esclusivamente per AVerTV 3D)</p>
	<p>(20)  Attiva la funzione PIP (Picture in Picture) / Visualizzazione di più canali.</p>
	<p>(21)  Snapshot Cattura un'immagine (o una sequenza continua d'immagini).</p>
	<p>(22)  Picture</p> <p>Schermata principale: Collegamento al menu principale -- "Immagini". Modalità Televideo: Passa alla pagina teletext del colore corrispondente al pulsante.</p>
	<p>(23)  Music</p> <p>Schermata principale: Collegamento al menu principale -- "Musica". Modalità Televideo: Passa alla pagina teletext del colore corrispondente al pulsante.</p>
	<p>(24)  Canale successivo e canale precedente.</p>
	<p>(25)  Back Torna alla pagina precedente.</p>
	<p>(26)  Home EXIT</p> <p>- Va al menu principale. - Esci dalla finestra di dialogo con le informazioni CI/CA. (Questa funzione è disponibile esclusivamente per CI/CA)</p>

AVerTV CaptureHD / AVer3D CaptureHD

(27)	 Ch. Prev	Torna al canale selezionato in precedenza.
(28)	 Source	Cambia tra le origini del segnale disponibili.



Informazioni sulla sicurezza della batteria:

- Conservare le batterie in un luogo fresco asciutto.
- Non gettare le batterie usate tra i rifiuti domestici. Gettare le batterie nei punti di raccolta predisposta o riportarle, se possibile, al luogo di vendita.
- Rimuovere le batterie in caso di inutilizzo prolungato. Ricordarsi di rimuovere le batterie scariche dal telecomando. Fuoriuscite o corrosione delle batterie potrebbero danneggiare il telecomando, procedere correttamente allo smaltimento.
- Non utilizzare congiuntamente batterie nuove e usate.
- Non utilizzare congiuntamente batterie di tipo diverso: alcaline, standard (zinco-carbonio) o ricaricabili (nickel-cadmio).
- Non gettare le batterie nel fuoco. Le batterie potrebbero esplodere o causare fuoriuscite.
- Non mettere in corto circuito i terminali della batteria.

Contenido del paquete

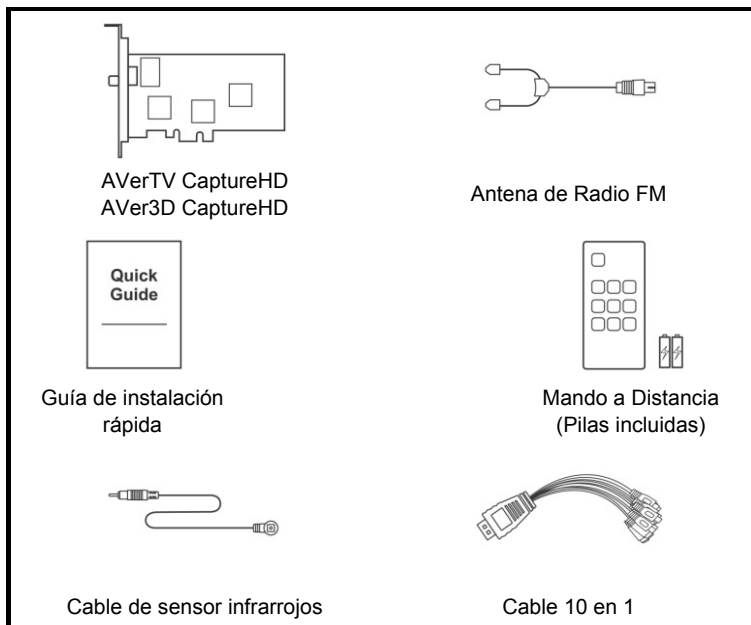

Español

Requisitos del sistema

Los requisitos del sistema están descritos con detalle en la caja. Antes de instalar AVerTV CaptureHD/AVer3D CaptureHD, verifique si su PC cumple los requisitos descritos.

Instalación del Hardware

Paso 1. Instalando la Tarjeta sintonizadora de TV

1. Apague el PC.
2. Quite la carcasa.
3. Inserte la tarjeta sintonizadora en un slot PCI libre de la placa base.
4. Vuelva a colocar la carcasa.

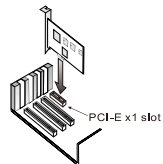

Instalando los drivers y el programa de utilidades de TV

Después de la correcta instalación de la tarjeta, encienda su PC. Simplemente abandona el asistente y ejecuta la aplicación que has descargado desde la web de AVerMedia <http://g.avermedia.com/h727-download> para instalar el driver y software.

Instalando los drivers y la aplicación en Windows® XP / Windows® XP Media Center Edition

1. Aparecerá el "Asistente de Nuevo Hardware encontrado". Simplemente presione **Cancelar** para omitir el asistente de instalación.
2. Ejecuta la aplicación descargada desde la web de AVerMedia.
3. Cuando la pantalla principal de instalación aparezca, elija **Instalar AVer MediaCenter 3D**.
4. Pulse en **Siguiente** para continuar con el proceso de instalación.
5. Lea los términos de licencia y si está de acuerdo seleccione: "Acepto los términos de licencia" y pulse en **Siguiente**.
6. Elija "**Completa**" para instalar todo el software necesario, incluido **AVer MediaCenter 3D, DirectX 9.0c** y los controladores. Después pulse en **Siguiente**. Para usuarios avanzados, es recomendable seleccionar **Personalizada** para elegir los programas que desea. Para elegir un directorio diferente de instalación elija **Explorar**.
7. Si fuera necesario reiniciar el PC, seleccione **Sí** en el cuadro de diálogo "**Asistente de instalación**". Luego, haga clic en **Finalizar** para completar la instalación.

Instalando los drivers y la aplicación en Windows® 7 / Windows® 8

1. Aparecerá el "Asistente de Nuevo Hardware encontrado". Simplemente presione **Cancelar** para omitir el asistente de instalación.
2. Ejecuta la aplicación descargada desde la web de AVerMedia.
3. Cuando aparezca el cuadro de diálogo de "**Reproducción automática**", seleccione **Ejecutar Autorun.exe**.
4. Cuando la pantalla principal de instalación aparezca, elija **Instalar AVer MediaCenter 3D**.
5. Si el cuadro de diálogo "Control de cuentas de usuario" aparece, seleccione **Permitir/ Sí** para continuar el proceso.
6. Pulse en **Siguiente** para continuar con el proceso de instalación.
7. Lea los términos de licencia y si está de acuerdo seleccione: "Acepto los términos de licencia" y pulse en **Siguiente**.
8. Elija "**Completa**" para instalar todo el software necesario, incluido **AVer MediaCenter 3D, DirectX 9.0c** y los controladores. Después pulse en **Siguiente**. Para usuarios avanzados, es recomendable seleccionar

AVerTV CaptureHD / AVer3D CaptureHD

Personalizada para elegir los programas que desea. Para elegir un directorio diferente de instalación elija **Explorar**.

9. Luego, haga clic en **Finalizar** para completar la instalación.

NOTA:

1. Asegúrese de que el sistema tiene DirectX 9.0c o superior para que el software de TV pueda funcionar de manera apropiada.
 2. El producto no incluye un descodificador de DVD de software. Si los usuarios pueden reproducir DVD o archivos de vídeo MPEG-2 en el equipo, no es necesario instalar un descodificador de DVD. No obstante, si aparece el mensaje de error de descodificación en la pantalla, instale el descodificador de DVD compatible a través del sitio de Windows® XP Media Center Edition Partners.
 3. Las funciones de televisión tridimensional en AVerTV 3D no se admiten en el sistema operativo Windows® XP.
-

Activando la aplicación AVer MediaCenter 3D

Windows® XP / Windows® 7

Para ejecutar la aplicación desde el menú programas, pulse en **Inicio → programas → AVerMedia → AVer MediaCenter 3D → AVer MediaCenter 3D**.

Windows® 8

Haga clic en **AVer MediaCenter 3D** en la pantalla de inicio (Metro) o haga doble clic en **AVer MediaCenter 3D** en el Escritorio.

Para desinstalar la aplicación y los controladores

Windows® XP / Windows® XP Media Center Edition

Si está en el modo Media Center, por favor salga y cambie al modo Windows.

Para eliminar la aplicación de software de TV del sistema elija, **Inicio →**

Programas → AVerMedia → AVer MediaCenter 3D →

Uninstaller(Desinstalador) → Eliminar todo → Siguiente → OK → Finalizar.

/ Windows® 7



1. Para eliminar la utilidad de software de TV del sistema, simplemente elija **Inicio → Todos los programas → AVerMedia → AVer MediaCenter 3D → Uninstaller (Desinstalador)**.
2. Cuando aparezca el cuadro de diálogo "Control de cuentas de usuario", seleccione Permitir / Sí.
3. Pulse en **Eliminar todo → Siguiente → OK → Finalizar**.

Windows® 8

1. Haga clic con el botón secundario en **AVer MediaCenter 3D** en la pantalla de inicio (Metro) y, a continuación, haga clic en **Desinstalar**.
2. En **Programas y características**, seleccione **AVer MediaCenter 3D** → **Desinstalar o cambiar**.

Control remoto

Después de instalar los controladores y las aplicaciones, use el control remoto para encender / apagar los programas, seleccionar canales, ajustar el volumen, etc.

- ◆ **Función Encendido:** Cuando el PC está en modo apagado, los usuarios pueden encender el PC y la aplicación con el mando a distancia. Para utilizarlo, basta con apuntar con el mando a distancia al receptor y presionar  para encender el PC. Entonces presione nuevamente  para iniciar la aplicación.













NOTA:

1. La función de Encendido del mando a distancia puede ser desactivada dependiendo de su placa base.
 2. Para habilitar la función de Encendido del mando a distancia compruebe en la configuración de la BIOS, que está habilitada la opción PCI "Despertar" (Wake up). Para ello entre en la BIOS, vaya a "Configuración de administración de energía" y establezca para el dispositivo PCI la función de "Encendido" (tenga en cuenta que la descripción de las funciones de la BIOS puede variar según el modelo)
-

AVerTV CaptureHD / AVer3D CaptureHD

Botones del control remoto



Botón	Descripción
(1) 	Activa/Desactiva la aplicación
(2) 	Apaga/enciende el sonido.
(3) 	Utilice el teclado numérico para seleccionar un canal.
(4) 	Visualización de la televisión o el video a pantalla completa.
(5) 	Cambia entre los modos de sonido disponibles.
(6) 	Pantalla principal: Utilice las flechas para navegar a través de los elementos de la pantalla. Utilice el botón OK (Aceptar) para confirmar su selección. Modo PIP: Mueve o cambia el tamaño de la pantalla seleccionada utilizando las flechas.
(7) 	Sube/baja el volumen.
(8) 	Pantalla principal: Un acceso directo al menú principal—"Video". Modo teletexto: Saltar a la página de teletexto del color correspondiente a este botón.
(9) 	Pantalla principal: Un acceso directo al menú principal—"TV". Modo teletexto: Saltar a la página de teletexto del color correspondiente a este botón.
(10) 	Ver información de teletexto/subtítulos
(11) 	Visualiza información EPG. (Esta función sólo está disponible en televisión y radio digital)
(12) 	Grabar el programa actual de TV.
(13) 	Reproduce el archivo seleccionado o congela temporalmente la reproducción

Guía de instalación rápida



- | | | |
|------|--|--|
| (14) | | Se desplaza al elemento anterior de la lista de reproducción. |
| (15) | | Se desplaza hacia atrás en intervalos. |
| (16) | | Salta hacia adelante a intervalos. |
| (17) | | Pasa al elemento siguiente de la lista de reproducción. |
| (18) | | Para la reproducción, grabación, TimeShift, etc. |
| (19) | | Alterna entre los modos TV o radio en tiempo real y TimeShift |
| (20) | | Activar la función de Imagen en Imagen (PIP) / Pantalla multicanal. |
| (21) | | Capturar una imagen (o una secuencia continuada de imágenes). |
| (22) | | Pantalla principal: Acceso directo al submenú principal—"Imágenes".
Modo teletexto: Saltar a la página de teletexto del color correspondiente a este botón. |
| (23) | | Pantalla principal: Acceso directo al submenú principal—"Música".
Modo teletexto: Saltar a la página de teletexto del color correspondiente a este botón. |
| (24) | | Sube o baja un canal. |
| (25) | | Volver a la página anterior. |
| (26) | | Vuelve al menú principal. |
| (27) | | Vuelve al canal accedido anteriormente. |
| (28) | | Cambia entre las fuentes de señal disponibles. |

AVerTV CaptureHD / AVer3D CaptureHD



Información acerca de la seguridad de las pilas

- Almacene las pilas en un lugar fresco y seco.
- No tire las pilas usadas junto a los desperdicios domésticos. Tire las pilas en lugares especiales acondicionados para ello o devuélvalas al lugar donde las compró si procede.
- Quite las pilas en periodos largos en los que no utilice el mando a distancia. Quite siempre las pilas gastadas del mando a distancia. Si las pilas gotean y la corrosión puede dañar el mando a distancia, guárdelas en lugar seguro.
- No mezcle pilas viejas y nuevas
- No mezcle diferentes tipos de pilas: alcalinas, estándar (carbono-zinc) o recargables (níquel-cadmio).
- No tire las pilas al fuego. Las pilas podrías explotar o derramar líquidos.
- Nunca haga cortocircuitos en los terminales de las pilas.

Conteúdo do Pacote

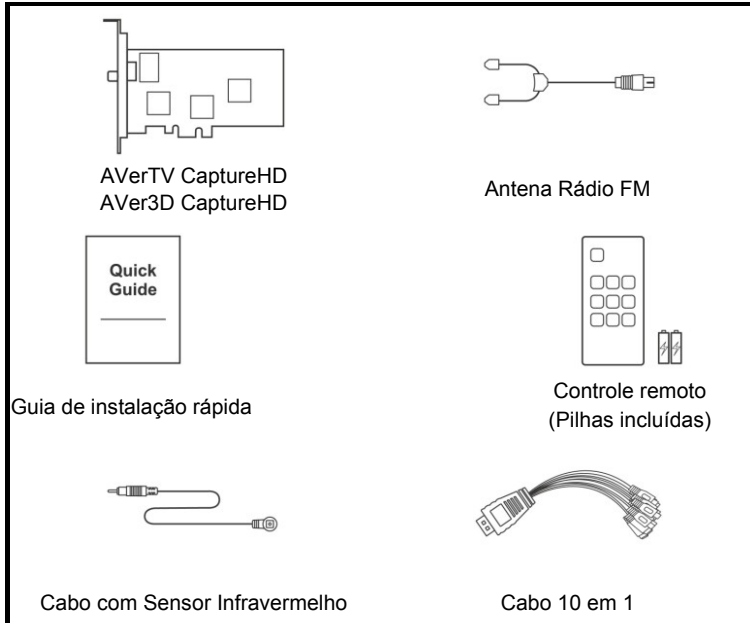

Requisitos do sistema

Os requisitos do sistema estão descritos em detalhes na embalagem. Antes de instalar o AVerTV CaptureHD/AVer3D CaptureHD, verifique se seu computador atende aos requisitos indicados.

Instalação de hardware

Etapa 1. Instalação da placa sintonizadora de TV

1. Desligue a ficha do cabo de alimentação do PC da tomada de parede.
2. Extraia o invólucro do PC.
3. Introduza o dispositivo dentro de uma ranhura de expansão PCI-E vazia na placa-mãe (motherboard).
4. Volte a colocar o invólucro.

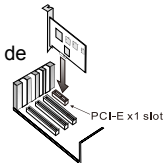

AVerTV CaptureHD / AVer3D CaptureHD

Etapa 2 : Conexão

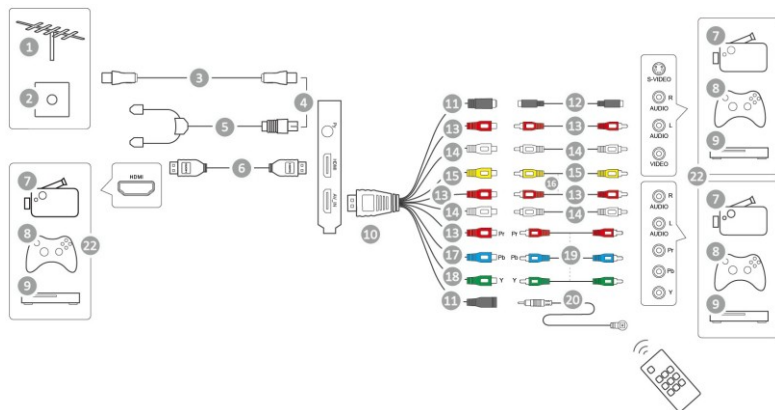

1	Antena de TV	12	Cabo S-Video (não fornecido)
2	Porta da Antena da TV	13	(Vermelho)
3	Tv a Cabo	14	(Branco)
4	OU	15	(Amarelo)
5	Antena Rádio FM	16	Cabo composto (Não Fornecido)
6	Cabo HDMI (Não Fornecido)	17	(Azul)
7	Câmara de vídeo	18	(Verde)
8	Video Game	19	Component Cable (Não Fornecido)
9	VCR/VCD/DVD Player	20	Cabo com Sensor Infravermelho
10	Cabo 10 em 1	21	Controle remoto
11	(Preto)	22	Exemplo

OBSERVAÇÃO:

- Vídeo da entrada componente que contém a proteção contra cópia Macrovision não pode ser visualizado.
- Fonte HDMI com HDCP (High-Bandwidth Digital Content Protection), não pode ser gravada.
- Você pode desfrutar simultaneamente HDMI ou vídeo componente em uma janela e assistir TV, vídeo composto ou S-video na outra janela em PIP (Picture-in-Picture) / PBP (Picture-by-Picture) modo de exibição. Para mais informações, consulte o manual do usuário.

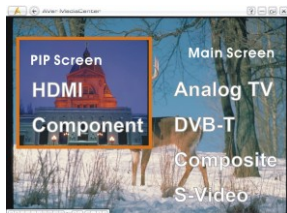

Instalação dos controladores e do software de TV

Ligue o computador depois de instalar corretamente a placa. Ignore o assistente e execute a aplicação transferida a partir do Web site AVerMedia <http://q.avermedia.com/h727-download> para instalar o controlador e o software utilitário de TV em simultâneo.

Instalação dos controladores e da aplicação do Windows® XP / Windows® XP Media Center Edition

1. Aparecerá a caixa de diálogo “Assistente para adicionar novo hardware”. Clique em **Cancelar** para ignorar o assistente de instalação.
2. Execute a aplicação transferida a partir do Web site AVerMedia.
3. Quando visualizar o ecrã principal, escolha **Instalar AVer MediaCenter 3D**.
4. Clique em **Seguinte** para prosseguir a instalação.
5. Leia o contrato relativo à licença e, caso esteja de acordo, seleccione “Aceito os termos do contrato de licença”. A seguir, clique em **Seguinte**.
6. Escolha Concluir para instalar todo o software necessário, incluindo **AVer MediaCenter 3D, DirectX 9.0c** e os **controladores**. A seguir, clique em **Seguinte**. Aos utilizadores avançados, recomendamos a opção **Personalizada** para selecção do software a instalar. Para escolher uma pasta de destino diferente, clique em **Pesquisar**.
7. Na caixa de diálogo “InstallShield Wizard Complete” (Assistente do InstallShield concluído), se for solicitado a reiniciar seu computador, seleccione **Sim**. Em seguida clique em **Concluir** para finalizar a instalação.

Instalação dos controladores e da aplicação do Windows® 7 / Windows® 8

1. Aparecerá a caixa de diálogo “Assistente para adicionar novo hardware”. Clique em **Cancelar** para ignorar o assistente de instalação.
2. Execute a aplicação transferida a partir do Web site AVerMedia.
3. Quando surgir a caixa de diálogo “AutoPlay” seleccione **Run Autorun.exe**.
4. Quando visualizar o ecrã principal, escolha **Instalar AVer MediaCenter 3D**.
5. Caso surja a caixa de diálogo “User Account Control” (“Controlar Conta de Utilizador”), seleccione **Allow (Permitir) / Yes (Sim)** para continuar o processo.
6. Clique em **Seguinte** para prosseguir a instalação.
7. Leia o contrato relativo à licença e, caso esteja de acordo, seleccione “Aceito os

AVerTV CaptureHD / AVer3D CaptureHD

termos do contrato de licença". A seguir, clique em **Seguinte**.

- Escolha **Concluir** para instalar todo o software necessário, incluindo **AVer MediaCenter 3D, DirectX 9.0c** e os **controladores**. A seguir, clique em **Seguinte**. Aos utilizadores avançados, recomendamos a opção **Personalizada** para selecção do software a instalar. Para escolher uma pasta de destino diferente, clique em **Pesquisar**.
- Em seguida clique em **Concluir** para finalizar a instalação.

OBSERVAÇÃO:

- Certifique-se de que seu sistema tenha o DirectX 9.0c ou superior instalado para que o software utilitário de TV possa funcionar corretamente.
- Este produto não é fornecido com um software de descodificador de DVD. Se o utilizador conseguir reproduzir DVD ou ficheiros de vídeo MPEG-2 no computador, não haverá necessidade de instalar um descodificador de DVD. No entanto, caso apareça no ecrã a mensagem de Erro de Descodificação, deverá instalar o descodificador de DVD compatível no site dos parceiros do Windows® XP Media Center Edition.
- As funções 3DTV em AVerTV 3D não são suportadas no sistema operativo Windows® XP.

Activação da aplicação AVer MediaCenter 3D

Windows® XP / Windows® 7

Para executar a aplicação a partir do menu Programas, clique em **Início** → **Programas** → **AVerMedia** → **AVer MediaCenter 3D** → **AVer MediaCenter 3D**.

Windows® 8

Clique em **AVer MediaCenter 3D** no ecrã Iniciar Metro ou faça duplo clique em **AVer MediaCenter 3D** no Ambiente de trabalho.

Desinstalação do aplicativo e dos drivers

Windows® XP / Windows® XP Media Center Edition

Se estiver no Modo Media Center deverá sair e comutar primeiro para o modo Windows. Para remover do sistema o software utilitário de TV instalado, basta escolher **Início** → **Programas** → **AVerMedia** → **AVer MediaCenter 3D** → **Desinstalador** → **Remover Tudo** → **Seguinte** → **OK** → **Terminar**.

Windows® 7



1. Para remover do sistema a utilidade do software de TV basta escolher **Início** → **Todos os Programas** → **AVerMedia** → **AVer MediaCenter 3D** → **Desinstalar**.
2. Quando surgir a caixa de diálogo “**User Account Control**” (“**Controlar Conta de Utilizador**”), seleccione **Permitir (Allow) / Sim (Yes)**.
3. Basta escolher **Remover Tudo** → **Seguinte** → **OK** → **Terminar**.

Windows® 8

1. Clique com o botão direito em **AVer MediaCenter 3D** no ecrã Iniciar Metro e clique em **Desinstalar**.
2. Em **Programas e Funcionalidades**, seleccione **AVer MediaCenter 3D** → **Desinstalar/Alterar**.
3. Basta escolher **Remover Tudo** → **Seguinte** → **OK** → **Terminar**.

Controle remoto

Após a instalação dos drivers e aplicativos, você pode usar o controle remoto para abrir e fechar os programas, seleccionar canais, ajustar o volume e assim por diante.



- ◆ **Função de ligação remota:** sempre que o PC se encontre no modo desligado, o utilizador poderá utilizar o telecomando para ligar o PC e a aplicação. Para o efeito, apontar o telecomando para o receptor e premir o botão  para ligar o PC. Seguidamente, premir de novo o botão  para ligar a aplicação.

OBSERVAÇÃO:

1. A função de Ligação Remota pode ser desligada, dependendo da placa mãe do seu PC.
 2. Para habilitar a Função de Ligação Remota, assegure-se de ter activado a função de “despertar” do PCI nos atributos da BIOS. Para tal, introduza em primeiro lugar os atributos da BIOS; a seguir, escolha “Power Management Setup” (Configurar a gestão do consumo de energia) e coloque o dispositivo PCI na posição “Power On” (ligado) (tenha em conta, por favor, que os atributos da BIOS e as descrições poderão variar).
-











AVerTV CaptureHD / AVer3D CaptureHD

Botões do controle remoto





	BOTÃO	Descrição
	(1) 	Ligar/desligar a aplicação.
	(2) 	Desligar/ligar o som.
	(3) 	Utilize os botões numéricos para seleccionar um canal.
	(4) 	Exibir TV ou vídeo em tela inteira.
	(5) 	Mudar entre modos de áudio disponíveis.
	(6) 	Écrã Principal: Utilize a tecla de seta para navegar por todos os itens do ecrã. Confirme a selecção com OK. Modo PIP: Mover ou alterar o tamanho do ecrã seleccionado com as teclas de setas.
	(7) 	Subir volume / Descer volume.
	(8) 	Écrã Principal: Um atalho para o menu principal-"Video". Modo Teletexto: Salta para a página de tele-texto da cor correspondente de acordo com esse botão.
	(9) 	Écrã Principal: Um atalho para o menu principal-"TV". Modo Teletexto: Salta para a página de tele-texto da cor correspondente de acordo com esse botão.
	(10) 	Ver informação de Teletexto / Legendas Codificadas.
	(11) 	Ver informação de EPG. (Esta função só se encontra disponível para TV e rádio digital)
	(12) 	Grava o programa de televisão em curso.
	(13) 	Reproduzir o ficheiro seleccionado ou

Guia de instalação rápida



- congelar temporariamente a reprodução.
- (14)  - Ir para o item anterior da lista de reprodução.
- Regula o tempo para retirar o computador do modo de reserva ou de hibernação. (Esta função só se encontra disponível para AVerTV 3D)
- (15)  Retrocede por intervalos..
- (16)  Avança por intervalos.
- (17)  - Ir para o item seguinte da lista de reprodução.
- Configurar o tempo para colocar o computador no Modo de Espera / Hibernação, sair da aplicação ou desligar o computador. (Esta função só se encontra disponível para AVerTV 3D)
- (18)  Detém a reprodução, a gravação, a função TimeShift, etc.
- (19)  Comutar do modo TV ou Rádio em tempo real para o modo TimeShift. / Congela a reprodução.
- (20)  Activar a função Imagem na Imagem (PIP) (Esta função só se encontra disponível para AVerTV 3D) / Visualização Multicanal
- (21)  Captura uma imagem simples ou uma sequência de imagens.
- (22)  **Écrã Principal:** Um atalho para o seu menu principal --"Imagens".
Modo Teletexto: Salta para a página de tele-texto da cor correspondente de acordo com esse botão.
- (23)  **Écrã Principal:** Um atalho para o seu menu principal --"Música".
Modo Teletexto: Salta para a página de tele-texto da cor correspondente de acordo com esse botão.

AVerTV CaptureHD / AVer3D CaptureHD

- | | | |
|------|---|---|
| (24) |  | Subir canal e descer canal. |
| (25) |  | Regressar à página anterior |
| (26) |  | - Ir para o menu principal.
- Sair do diálogo de Informação CI/CA.
(Esta função só se encontra disponível para r CI/CA) |
| (27) |  | Regressa ao canal previamente acedido. |
| (28) |  | Mudar entre fontes de sinais disponíveis. |
-



Informação de segurança relativa às pilhas:

- Guarde as pilhas num local fresco e seco.
- Não deposite as pilhas gastas juntamente com o lixo doméstico. Deposite as pilhas nos pontos de recolha próprios para o efeito ou entregue-as nos pontos de venda, se for o caso.
- Retire as pilhas quando se prevejam períodos longos de não utilização. Retire sempre as pilhas gastas do comando a distância. O derramamento a corrosão das pilhas poderão danificar o comando a distância.
- Não misture pilhas novas com pilhas já gastas.
- Não misture tipos de pilhas diferentes: alcalinas, standard (carvão-zinco) ou recarregáveis (níquel-cádmio).
- Não lance as pilhas nas chamas, pois poderão ocorrer explosões ou derramamentos.
- Nunca provoque curto-circuitos nos terminais da pilha.

Περιεχόμενο Συσκευασίας

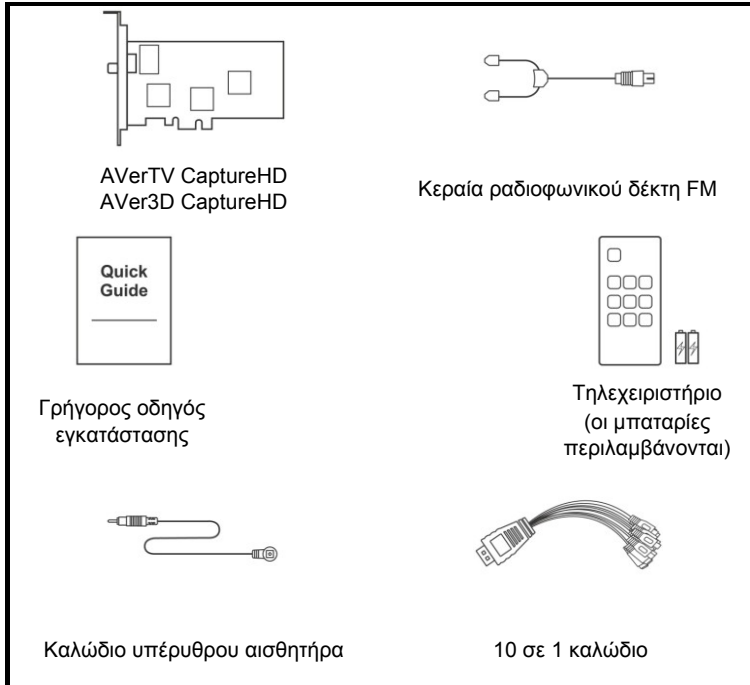

Απαιτήσεις Συστήματος

Οι απαιτήσεις του συστήματος περιγράφονται λεπτομερώς πάνω στο κουτί της συσκευασίας. Πριν από την εγκατάσταση της κάρτας επιλογή TV και του λογισμικού, βεβαιωθείτε ότι ο προσωπικός υπολογιστής πληροί τις απαραίτητες προϋποθέσεις.

Εγκατάσταση Συσκευών Εξοπλισμού

Βήμα 1. Εγκατάσταση της κάρτας τηλεόρασης

1. Σβήστε τον υπολογιστή.
2. Αφαιρέστε το καπάκι.
3. Τοποθετήστε την κάρτα τηλεόρασης σε μία άδεια θύρα επέκτασης PCI-E στη μητρική.
4. Τοποθετήστε ξανά το καπάκι.

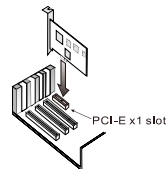

AVerTV CaptureHD / AVer3D CaptureHD

Βήμα 2. Συνδέσεις

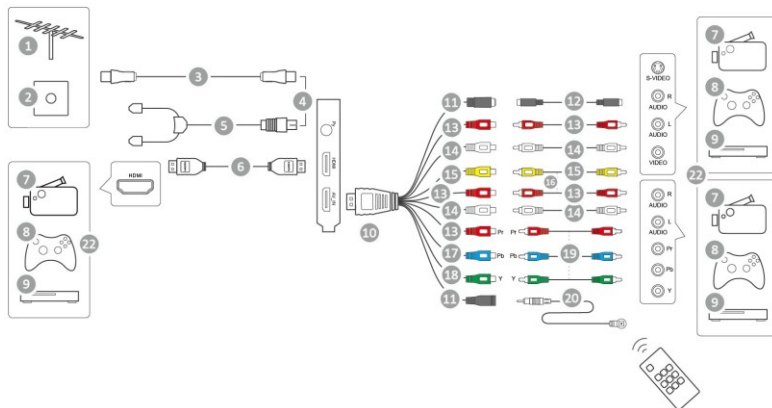

1	Κεραία TV	12	Καλώδιο S-Video (δεν παρέχεται)
2	Υποδοχή κεραίας	13	(Κόκκινο)
3	Καλώδιο κεραίας	14	(Λευκό)
4	Ή	15	(Κίτρινο)
5	Κεραία ραδιοφωνικού δέκτη FM	16	Καλώδιο Composite (δεν παρέχεται)
6	Καλώδιο HDMI (δεν παρέχεται)	17	(Μπλε)
7	Φορητή βιντεοκάμερα	18	(Πράσινο)
8	Παιχνίδι-Βίντεο	19	Καλώδιο Component (δεν παρέχεται)
9	Αναπαραγωγέας VCR/ VCD/ DVD	20	Καλώδιο υπέρυθρου αισθητήρα
10	10 σε 1 καλώδιο	21	Τηλεχειριστήριο
11	(Μαύρο)	22	Παράδειγμα

Σημείωση:

1. Βίντεο απο θύρα component input το οποίο περιχει προστασια Macrovision δεν μπορεί να γίνει θεαση.
2. HDMI πηγη με δυναποτητα HDCP (High-Bandwidth Digital Content Protection) Macrovision δεν μπορεί να γίνει εγγραφη.
3. Για ταυτοχρονη θεαση HDMI ή Component video σε ενα παραθυρο εργασιας για παρακολουθηση TV, composite video ή S-video σε δευτερο παραθυρο ,διαλεξτε την επιλογη PIP (Picture-in-Picture) / PBP (Picture-by-Picture) Για περισσοτερες πληροφοριες δεπτε το εγχειριδιο οδηγιων.

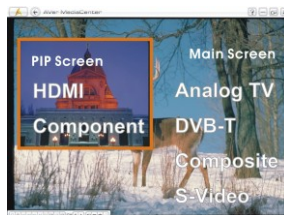

Εγκατάσταση Οδηγών και Βοηθητικού Προγράμματος Λογισμικού TV

Μετά από την κατάλληλη τοποθέτηση της κάρτας, ενεργοποιήστε τον Η/Υ. Απλώς παρακάμψτε τον οδηγό και κάντε εκκίνηση της εφαρμογής που έχετε λάβει από την τοποθεσία Web της AVerMedia <http://g.avermedia.com/h727-download> για να εγκαταστήσετε το πρόγραμμα οδήγησης και το βοηθητικό πρόγραμμα λογισμικού τηλεόρασης ταυτόχρονα.

Εγκατάσταση Οδηγών και Εφαρμογής στα Windows® XP / Windows® XP Media Center Edition

1. Εμφανίζεται το πλαίσιο διαλόγου "Found New Hardware Wizard" (Οδηγός Εύρεσης Νέας Συσκευής Εξοπλισμού). Κάντε κλικ στην ένδειξη Άκυρο για να παρακάμψετε τις διαδικασίες εγκατάστασης του Οδηγού.
2. Εκκίνηση της εφαρμογής που έχετε λάβει από την τοποθεσία Web της AVerMedia.
3. Όταν εμφανιστεί η κεντρική οθόνη της εγκατάστασης, επιλέξτε το **Install AVer MediaCenter 3D (Εγκατάσταση AVer MediaCenter 3D)**.
4. Κάντε κλικ στο **Next(Επόμενο)** για να συνεχίσετε με την εγκατάσταση.
5. Διαβάστε την άδεια χρήστης και αν συμφωνείτε με τους όρους της, επιλέξτε το "I accept the terms of the license agreement" (Αποδέχομαι τους όρους της άδειας χρήσης) και κάντε κλικ στο **Next(Επόμενο)**.
6. Επιλέξτε το Complete για να εγκατασταθεί όλο το λογισμικό, που περιλαμβάνει τα **AVer MediaCenter 3D, DirectX 9.0c και Drivers (Προγράμματα οδήγησης)**. Έπειτα κάντε κλικ στο **Next (Επόμενο)**. Για προχωρημένους χρήστες, συνιστάται να επιλέξετε το **Custom (Προσαρμοσμένη)** για να επιλέξετε το λογισμικό που θέλετε. Για να επιλέξετε άλλο φάκελο προορισμού, κάντε κλικ στο **Browse (Αναζήτηση)**.
7. Στο πλαίσιο διαλόγου "InstallShield Wizard", αν σας ζητηθεί να επανεκκινήσετε τον υπολογιστή σας, επιλέξτε το **Yes(Ναι)**. Έπειτα, κάντε κλικ στο **Finish(Τέλος)** για να ολοκληρώσετε την εγκατάσταση.

Εγκατάσταση Οδηγών και Εφαρμογής στα Windows® 7 / Windows® 8

1. Εμφανίζεται το πλαίσιο διαλόγου "Found New Hardware Wizard" (Οδηγός Εύρεσης Νέας Συσκευής Εξοπλισμού). Κάντε κλικ στην ένδειξη Άκυρο για να παρακάμψετε τις διαδικασίες εγκατάστασης του Οδηγού.
2. Εκκίνηση της εφαρμογής που έχετε λάβει από την τοποθεσία Web της AVerMedia.

AVerTV CaptureHD / AVer3D CaptureHD

3. Όταν εμφανιστεί το παράθυρο διαλόγου με την ένδειξη “AutoPlay” (αυτόματη αναπαραγωγή), επιλέξτε Run Autorun.exe
4. Όταν εμφανιστεί η κεντρική οθόνη της εγκατάστασης, επιλέξτε το **Install AVer MediaCenter 3D (Εγκατάσταση AVer MediaCenter 3D)**.
5. Εάν εμφανιστεί το παράθυρο διαλόγου “**User Account Control**” (**έλεγχος λογαριασμού χρήστη**) επιλέξτε **Allow (επιτρέπω)** για να συνεχίσει η διαδικασία.
6. Κάντε κλικ στο **Next(Επόμενο)** για να συνεχίσετε με την εγκατάσταση.
7. Διαβάστε την άδεια χρήστης και αν συμφωνείτε με τους όρους της, επιλέξτε το “I accept the terms of the license agreement” (Αποδέχομαι τους όρους της άδειας χρήσης) και κάντε κλικ στο **Next(Επόμενο)**.
8. Επιλέξτε το Complete για να εγκατασταθεί όλο το λογισμικό, που περιλαμβάνει τα **AVer MediaCenter 3D, DirectX 9.0c** και **Drivers (Προγράμματα οδήγησης)**. Έπειτα κάντε κλικ στο **Next (Επόμενο)**. Για προχωρημένους χρήστες, συνιστάται να επιλέξετε το **Custom (Προσαρμοσμένη)** για να επιλέξετε το λογισμικό που θέλετε. Για να επιλέξετε άλλο φάκελο προορισμού, κάντε κλικ στο **Browse (Αναζήτηση)**.
9. Έπειτα, κάντε κλικ στο **Finish(Τέλος)** για να ολοκληρώσετε την εγκατάσταση.

Σημείωση:

1. Βεβαιωθείτε ότι το σύστημά σας διαθέτει το DirectX 9.0c ή πιο πρόσφατη έκδοση με σκοπό τη σωστή λειτουργία του βοηθητικού προγράμματος λογισμικού TV.
2. Το προϊόν δεν περιλαμβάνει λογισμικό αποκωδικοποίησης DVD. Αν οι χρήστες μπορούν να αναπαράγουν DVD ή MPEG-2 αρχεία βίντεο στον υπολογιστή, δεν είναι αναγκαίο να εγκαταστήσουν αποκωδικοποιητή DVD. Όμως, αν εμφανιστεί στην οθόνη μήνυμα Σφάλματος Αποκωδικοποίησης, εγκαταστήστε συμβατό αποκωδικοποιητή DVD μέσω του ιστότοπου Windows® XP Media Center Edition Partners.
3. Οι λειτουργίες 3DTV δεν υποστηρίζονται στο AVer MediaCenter 3D όταν χρησιμοποιείτε το λειτουργικό σύστημα Windows® XP.

Ενεργοποίηση της Εφαρμογής AVer MediaCenter 3D

Windows® XP / Windows® 7

Για να εκτελέσετε την εφαρμογή από το μενού Προγράμματα κάντε κλικ στο **Start (Έναρξη)**, πηγαίνετε στο **Programs(Προγράμματα)**, **AVerMedia**, **AVer MediaCenter** και έπειτα κάντε κλικ στο **AVer MediaCenter 3D**.

Windows® 8

Κάντε κλικ στο στοιχείο **AVer MediaCenter 3D** στην οθόνη έναρξης του Metro ή κάντε διπλό κλικ στο στοιχείο **AVer MediaCenter 3D** από την επιφάνεια εργασίας.

Απεγκατάσταση του Βοηθητικού Προγράμματος Λογισμικού TV

Windows® XP / Windows® XP Media Center Edition

Για να καταργήσετε την εγκατάσταση της εφαρμογής λογισμικού τηλεόρασης από το σύστημα, απλά επιλέξτε το **Start (Έναρξη) → Programs(Προγράμματα) → AVerMedia → AVer MediaCenter 3D → Uninstaller (Πρόγραμμα απεγκατάστασης) → Remove All (Κατάργηση όλων) → Next(Επόμενο) → OK → Finish (Τέλος).**

Windows® 7



1. Για να αφαιρέσετε την εγκατεστημένη εφαρμογή Τηλεόρασης από το σύστημά σας, απλώς επιλέξτε **Start (Έναρξη) → All Programs (Προγράμματα) → AVerMedia → AVer MediaCenter 3D → Uninstaller (απεγκατάσταση).**
2. Όταν εμφανιστεί το παράθυρο διαλόγου “**User Account Control!**” (έλεγχος λογαριασμού χρήστη) επιλέξτε **Allow (επιτρέπω)**
3. Επιλέξτε **Remove All (αφαίρεση όλων) → Next (επόμενο) → OK → Finish (τέλος).**

Windows® 8

1. Κάντε δεξί κλικ στο στοιχείο **AVer MediaCenter 3D** στην οθόνη έναρξης του Metro και, στη συνέχεια, επιλέξτε **Uninstall (Κατάργηση εγκατάστασης).**
2. Στην περιοχή **Programs and Features (Προγράμματα και δυνατότητες)**, επιλέξτε **AVer MediaCenter 3D** για **Uninstall/Change (Κατάργηση εγκατάστασης/Αλλαγή)**
3. Επιλέξτε **Remove All (αφαίρεση όλων) → Next (επόμενο) → OK → Finish (τέλος).**

Τηλεχειριστήριο

Μετά την εγκατάσταση των προγραμμάτων οδήγησης και των εφαρμογών, μπορείτε να χρησιμοποιήσετε το τηλεχειριστήριο για να ανάψετε/σβήσετε τα προγράμματα, να επιλέξετε κανάλια, να ρυθμίσετε την ένταση του ήχου και ούτω καθεξής.

- ◆ Εάν το PC σας είναι σε Turn-off mode μπορείτε με το τηλεχειριστήριο να θέσετε σε λειτουργία το PC και τις άλλες εφαρμογές. Απλά στρέψτε το τηλεχειριστήριο στη TV και πατήστε  το κουμπί έναρξης για ανοίξει το PC. Μετά πατήστε  ξανά το κουμπί έναρξης για να θέσετε σε λειτουργία τις εφαρμογές.

AVerTV CaptureHD / AVer3D CaptureHD

Σημείωση:

1. Η μακρινή λειτουργία μπορεί να τεθεί εκτός λειτουργίας ανάλογα με τη μητρική κάρτα PC σας.
2. Για να επιτρέψετε τη μακρινή λειτουργία, παρακαλώ σιγουρευτείτε ότι είναι σε λειτουργία η wake-up PCI στο BIOS setting , Εισάγετε αρχικά τη ρύθμιση BIOS setting κατόπιν επιλέξτε Power Management Setup και την PCI σε «Power On» (παρακαλώ σημειώστε ότι η ρύθμιση και οι περιγραφές BIOS setting μπορούν να ποικίλουν).

Πλήκτρα Τηλεχειριστηρίου

Κουμπί	Περιγραφή
 (1)	Ενεργοποιεί/απενεργοποιεί την εφαρμογή
 (2)	Ενεργοποίηση/απενεργοποίηση ήχου.
 (3)	Χρησιμοποιήστε τα αριθμητικά πλήκτρα για επιλογή καναλιού.
 (4)	Απεικόνιση TV ή βίντεο σε πλήρη οθόνη.
 (5)	Μετακίνηση μεταξύ διαθέσιμων λειτουργιών ήχου
 (6)	Κεντρική οθόνη: Χρησιμοποιήστε το βελάκι για πλοήγηση σε όλα τα στοιχεία της οθόνης. Χρησιμοποιήστε το OK για επιβεβαίωση της επιλογής σας. Λειτουργία PIP: Αλλαγή μεγέθους ή θέσης της επιλεγμένης οθόνης με τα βελάκια.
 (7)	Αύξηση/μείωση έντασης ήχου.
 (8)	Κεντρική οθόνη: Συντόμηση στο κεντρικό μενού-"Video"(Βίντεο). Λειτουργία Τελετέξτ: Μετακινήθειτε στη σελίδα εκπεμπόμενης τηλεοπτικογραφίας (teletext) του αντίστοιχου χρώματος σύμφωνα με το πλήκτρο αυτό.
 (9)	Κεντρική οθόνη: Συντόμηση στο κεντρικό μενού-"TV". Λειτουργία Τελετέξτ: Μετακινήθειτε στη σελίδα εκπεμπόμενης τηλεοπτικογραφίας (teletext) του αντίστοιχου χρώματος σύμφωνα με το πλήκτρο αυτό

Γρήγορος οδηγός εγκατάστασης



- | | | |
|------|---|---|
| (10) |  | Προβολή πληροφοριών Τελετέξτ/Κλειστών Υποτίτλων. |
| (11) |  | Εμφανίζει τις πληροφορίες EPG. (Η λειτουργία αυτή είναι διαθέσιμη μόνο στην ψηφιακή τηλεόραση) |
| (12) |  | Εγγραφή του τρέχοντος προγράμματος. |
| (13) |  | Αναπαραγωγή του επιλεγμένου αρχείου ή προσωρινό πάγωμα της αναπαραγωγής. |
| (14) |  | - Μετάβαση στο προηγούμενο στοιχείο στη λίστα αναπαραγωγής.
- Ρυθμίστε την ώρα για να ανάψετε την εφαρμογή AVerTV. (AVerTV 3D μόνο) |
| (15) |  | Μετακίνηση προς τα πίσω ανά διαστήματα. |
| (16) |  | Προώθηση ανά διαστήματα. |
| (17) |  | - Μετάβαση στο επόμενο στοιχείο στη λίστα αναπαραγωγής.
- Ρυθμίστε την ώρα για να βάλετε τον υπολογιστή σας σε λειτουργία Αναμονής/Αδρανοποίησης, για έξοδο από την εφαρμογή ή για απενεργοποίηση του υπολογιστή. (AVerTV 3D μόνο) |
| (18) |  | Διακόπτει την αναπαραγωγή, εγγραφή, λειτουργία TimeShift κ.λπ. |
| (19) |  | - Αλλαγή από ζωντανή τηλεόραση ή ραδιόφωνο σε λειτουργία Χρονικής Μετατόπισης.
- Πάγωμα της αναπαραγωγής. (AVerTV 3D μόνο) |
| (20) |  | Ενεργοποίηση της λειτουργίας Εικόνας στην Εικόνα (PIP) / Προβολής Πολλών Καναλιών. |
| (21) |  | Καταγραφή μιας μονής εικόνας ή μιας αλληλουχίας εικόνων. |
| (22) |  | Κεντρική οθόνη: Συντόμευση στο κεντρικό μενού-"Pictures"(Εικόνες).
Λειτουργία Τελετέξτ: Μετακινηθείτε στη σελίδα εκπεμπόμενης τηλεοπτικογραφίας (teletext) του αντίστοιχου χρώματος σύμφωνα με το πλήκτρο αυτό |

AVerTV CaptureHD / AVer3D CaptureHD

(23)		Κεντρική οθόνη: Συντόμευση στο κεντρικό μενού-“Pictures”(Εικόνες). Λειτουργία Τελετέξτ: Μετακινηθείτε στη σελίδα εκπνευμένης τηλεοπτικογραφίας (teletext) του αντίστοιχου χρώματος σύμφωνα με το πλήκτρο αυτό
(24)		Πάνω και κάτω κανάλι.
(25)		Επιστροφή στην προηγούμενη σελίδα.
(26)		- Μετάβαση στο κεντρικό μενού. - Έξοδος από το διάλογο πληροφοριών CI/CA (CI/CA μόνο)
(27)		Επιστροφή στο προηγούμενο κανάλι που επιλέχθηκε.
(28)		Εναλλαγή μεταξύ των διαθέσιμων πηγών σήματος.

Πληροφορίες Ασφάλειας Μπαταρίας

- Φυλάσσετε τις μπαταρίες σε ένα δροσερό, ξηρό μέρος.
- Μην απορρίπτετε τις χρησιμοποιημένες μπαταρίες μαζί με τα οικιακά σκουπίδια. Απορρίπτετε τις μπαταρίες σε ειδικά σημεία συλλογής ή επιστρέφετέ τις στο μέρος που τις αγοράσατε, αν τις δέχονται εκεί για απόρριψη.
- Αφαιρείτε τις μπαταρίες αν δε θα χρησιμοποιήσετε το προϊόν για παρατεταμένη χρονική περίοδο. Αφαιρείτε πάντα τις τελειωμένες μπαταρίες από το τηλεχειριστήριο. Η διαρροή της μπαταρίας και η διάβρωση μπορούν να προκαλέσουν ζημιά σε αυτό το τηλεχειριστήριο, οπότε να απορρίπτετε τις μπαταρίες με ασφάλεια.
- Μη χρησιμοποιείτε μαζί παλιές και καινούριες μπαταρίες.
- Μη χρησιμοποιείτε μαζί διαφορετικούς τύπους μπαταριών: αλκαλικές, κανονικές (άνθρακα-ψευδάργυρου) ή επαναφορτιζόμενες (νικελίου-καδμίου).
- Μη πετάτε τις μπαταρίες στη φωτιά. Μπορεί να εκραγούν ή να υποστούν διαρροή.
- Ποτέ μη βραχυκυκλώνετε τους ακροδέκτες της μπαταρίας.

Conținutul pachetului

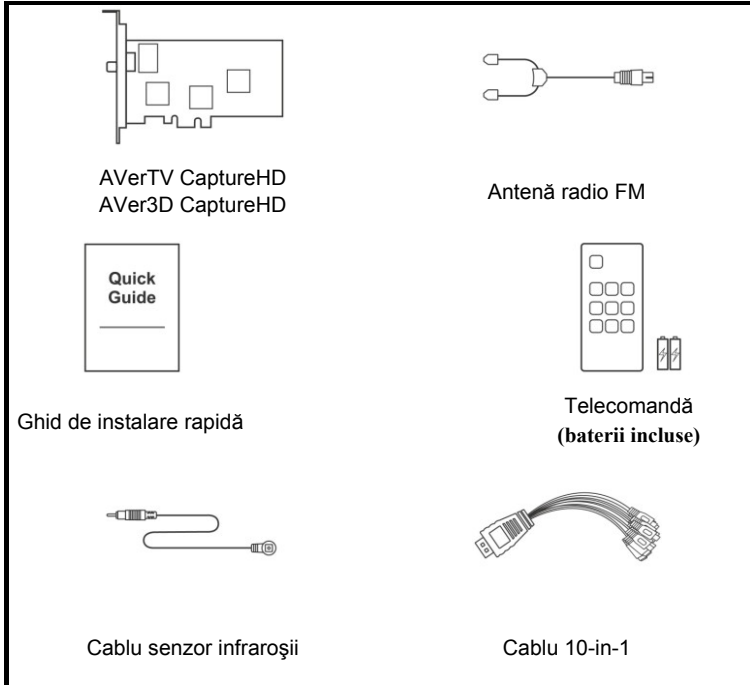

Cerințe sistem

Cerințele de sistem sunt descrise în detaliu pe cutia pachetului. Înainte de instalarea plăcii tuner TV și a programelor, verificați dacă sistemul dv. îndeplinește cerințele descrise.

Instalare componente hardware

Pasul 1. Instalarea plăcii tuner

1. Opriți calculatorul.
2. Scoateți panoul lateral al carcasei.
3. Introduceți placa tuner într-un slot PCI-E liber de pe placa de bază.
4. Puneți la loc panoul lateral al carcasei.

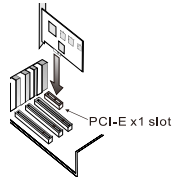

AVerTV CaptureHD / AVer3D CaptureHD

Pasul 2. Efectuați conexiunile

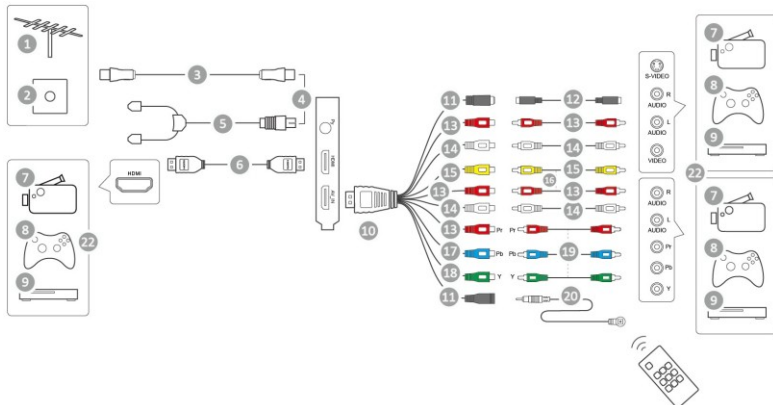

1	Antenă TV	12	Cablu S-Video (nu sunt incluse)
2	Port Antena TV	13	(Roșu)
3	Cablu TV	14	(Alb)
4	Arba	15	(Galben)
5	Antenă radio FM	16	Cablu Composite (nu sunt incluse)
6	Cablu HDMI (nu sunt incluse)	17	(Albastru)
7	Camera video	18	(Verde)
8	Joc Video	19	Cablu Component (nu sunt incluse)
9	VCR/VCD/DVD Player	20	Cablu senzor infraroșii
10	Cablu 10-in-1	21	Telecomandă
11	(Negru)	22	Exemplu

NOTĂ:

1. Sursa video de la intrarea Component ce conține protecția anti copiere Macrovision nu poate fi văzută în preview.
2. Sursa HDMI cu HDCP (High-Bandwidth Digital Content Protection) nu poate fi înregistrată.
3. Te poți bucura simultan de HDMI sau video Component în aceeași fereastră și să urmărești programe TV, video Composite sau S-video în alta fereastră în modul de afișare PIP (Picture-in-Picture) / PBP (Picture-by-Picture). Pentru mai multe informații, vă rugăm să consultați manualul.

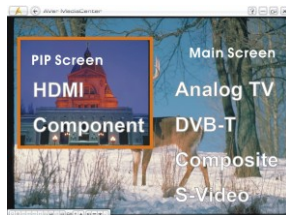

Instalarea driver-elor și a programului utilitar TV

Dupa instalarea corespunzatoare a cardului, porniti calculatorul. Pur și simplu, săriți peste ghid și lansați aplicația descărcată de pe site-ul AVerMedia

<http://q.avermedia.com/h727-download-ro> pentru a instala driver-ul și aplicația software simultan.

Instalarea driver-elor și a aplicației pentru Windows® XP / Windows® XP Media Center Edition

1. Este afișată caseta de dialog „Found New Hardware Wizard” (“Interfața de detectare a unui nou hardware”). Apăsați pe **Revocare** pentru a anula procedurile de instalare ale hardware-ului.
2. Lansați aplicația descărcată de pe site-ul AVerMedia.
3. Când ecranul principal de instalare apare, selectați **Install (Instalare) AVer MediaCenter 3D**.
4. Apăsați **Next (Următorul)** pentru a continua procesul de instalare.
5. Citiți termenii licenței de folosire și dacă sunteți de acord cu aceștia, selectați “Accept termenii licenței de folosire” și apoi apăsați **Next (Următorul)**.
6. Selectați **Complete** pentru a instala tot software-ul necesar, inclusiv **AVer MediaCenter 3D, DirectX 9.0c și Driver-ele**. Apoi apăsați **Next (Următorul)**. Pentru utilizatorii avansați, se recomandă alegerea instalării în modul **Custom (Personalizat)** pentru a selecta software-ul dorit. Pentru a alege un alt folder de destinație, click **Browse**.
7. În fereastra de dialog “InstallShield Wizard” (Interfața de instalare), dacă se cere repornirea calculatorului, selectați **Yes (Da)**. Apoi apăsați **Finish (Terminare)** pentru a încheia instalarea.

Instalarea driver-elor și a aplicației pentru Windows® 7 / Windows® 8

1. Este afișată caseta de dialog „Found New Hardware Wizard” (“Interfața de detectare a unui nou hardware”). Apăsați pe **Revocare** pentru a anula procedurile de instalare ale hardware-ului.
2. Lansați aplicația descărcată de pe site-ul AVerMedia.
3. Când apare caseta de dialog „AutoPlay”, selectați Run Autorun.exe.
4. Când ecranul principal de instalare apare, selectați **Install (Instalare) AVer MediaCenter 3D**.
5. Dacă apare caseta de dialog „Control cont utilizator”, selectați Permiteți continuarea procesului.

AVerTV CaptureHD / AVer3D CaptureHD

6. Apăsați **Next (Următorul)** pentru a continua procesul de instalare.
7. Citiți termenii licenței de folosire și dacă sunteți de acord cu aceștia, selectați "Accept termenii licenței de folosire" și apoi apăsați **Next (Următorul)**.
8. Selectați **Complete** pentru a instala tot software-ul necesar, inclusiv **AVer MediaCenter 3D, DirectX 9.0c** și **Driver-ele**. Apoi apăsați **Next (Următorul)**. Pentru utilizatorii avansați, se recomandă alegerea instalării în modul **Custom (Personalizat)** pentru a selecta software-ul dorit. Pentru a alege un alt folder de destinație, click **Browse**.
9. Apoi apăsați **Finish (Terminare)** pentru a încheia instalarea.

NOTĂ:

1. Asigurați-vă că aveți instalat pe sistem DirectX 9.0c sau o versiune mai recentă pentru ca programul utilitar TV să poată funcționa corect.
2. Produsul nu vine însoțit de un software pentru decodare DVD. Dacă utilizatorii pot reda pe calculator fișiere video DVD sau MPEG-2, nu este necesară instalarea unui decodor DVD. Totuși, dacă pe ecran apare mesajul Decoded Error (Eroare decodare), vă rugăm să instalați decodorul DVD compatibil, pentru detalii, consultați site-ul: Windows® XP Media Center Edition Partners site.
3. Funcțiile 3DTV din AVer MediaCenter 3D nu sunt acceptate de sistemul de operare Windows® XP.

Activarea aplicației AVer MediaCenter 3D

Windows® XP / Windows® 7

Pentru a porni aplicația AVer MediaCenter din meniul **Programs (Programare)**, apăsați **Start**, duceți cursorul pe **Programs (Programare)**, selectați **AVerMedia**, **AVer MediaCenter** și apoi apăsați pe **AVer MediaCenter 3D**.

Windows® 8

Apăsați pe **AVer MediaCenter 3D** în ecranul de Start al interfeței Metro sau efectuați dublu click pe **AVer MediaCenter 3D** pe Desktop.

Dezinstalarea programului utilitar TV

Windows® XP / Windows® XP Media Center Edition

Pentru a dezinstala utilitarul TV din sistemul dumneavoastră, selectați **Start** → **Programs (Programare)** → **AVerMedia** → **AVer MediaCenter 3D** → **Uninstaller**

Ghid de instalare rapidă

(Dezinstalare) → **Remove All** (Dezinstalare Toate) → **Next** → **OK** → **Finish**
(Terminare).

Windows® 7



1. Pentru a dezinstala din sistem utilitarul software-ul TV instalat, alegeți **Start** → **Toate programele** → **AVerMedia** → **AVer MediaCenter 3D** → **Dezinstalare**.
2. Când apare caseta de dialog „Control cont utilizator”, selectați **Permiteți**.
3. Selectați **Îndepărtare toate** → **Următorul** → **OK** → **Terminare**.

Windows® 8

1. Efectuați click dreapta pe **AVer MediaCenter 3D** în ecranul de Start al interfeței Metro, iar apoi selectați **Uninstall**.
2. În **Programs and Features**, selectați **AVer MediaCenter 3D** și **Uninstall/Change**.
3. Selectați **Îndepărtare toate** → **Următorul** → **OK** → **Terminare**.

Telecomandă

După instalarea driverelor și a aplicațiilor, puteți folosi telecomanda pentru a porni/opri programul, pentru a selecta canale, ajusta voloumul, ș.a.m.d.

◆**Funcția de pornire din Telecomanda:** Cand PC-ul este oprit, utilizatorii pot folosi telecomanda pentru a porni PC-ul si aplicatia. Pentru utilizare, indreptati telecomanda catre receptor si apoi apasati butonul  pentru a porni PC-ul. Apoi apasati inca o data butonul  pentru a deschide aplicatia.















NOTĂ:

1. Funcția de telecomanda poate fi dezactivata in functie de placa de baza a PC-ului dvs.
 2. Pentru a active functia de telecomanda, va rugam sa va asigurati ca a-ti activate functia de Pornire PCI (PCI wake-up) din setarile BIOS. Pentru aceasta, mai intai intrati in setarile BIOS, alegeți "Power Management Setup" si setati dispozitivul PCI ca "Power On" (setarile BIOS pot varia in diferite feluri).
-

AVerTV CaptureHD / AVer3D CaptureHD

Butoanele telecomenzii



Buton	Descriere
(1) 	Executare program utilitar TV sau ieșire.
(2) 	Pornire/Oprire sunet.
(3) 	Se folosesc butoanele numerice pentru a selecta un canal.
(4) 	Afișare TV sau video pe tot ecranul.
(5) 	Comutare între modurile audio disponibile.
(6) 	Ecran Principal: Se folosesc săgețile pentru a comuta între elementele de pe ecran. Se apasă OK pentru a confirma selecția. Modul PIP: Se schimbă mărimea sau poziția ecranului selectat cu ajutorul săgeților.
(7) 	Volum plus / Volum minus.
(8) 	Ecran Principal: Scurtătura către meniul principal - "Video" Modul Teletext: Salt la pagina de teletext corespunzând culorii butonului.
(9) 	Ecran Principal: Scurtătura către meniul principal - "TV" Modul Teletext: Salt la pagina de teletext corespunzând culorii butonului.
(10) 	Vizualizare Teletext / Închidere informație Subtitlu.
(11) 	Vizualizare informație EPG.
(12) 	Înregistrare program curent.
(13) 	Redare fișier selectat sau oprire temporară a redării.
(14) 	Comutare către elementul anterior din listă.
(15) 	Comutare înapoi în intervale.

Ghid de instalare rapidă



- (16)  Comutare înainte în intervale.

- (17)  Comutare către următorul element din listă.
Sleep

- (18)  Oprire redare, înregistrare, TimeShift, etc.

- (19)  Comutați între TV sau Radio în timp real și modul TimeShift. / Înghețare derulare (Această funcție este disponibilă doar pentru AVerTV 3D)

- (20)  **Modul PIP:** Pornire/Oprire funcție de dimensionare PIP. / Când este activată, se poate mari sau micșora ecranul selectat folosind săgețile.

- (21)  **Snapshot:** Capturare imagine sau mai multe secvențe consecutive de imagini.

- (22)  **Ecran Principal:** Scurtătura către meniul principal -"Pictures".
Modul Teletext: Salt la pagina de teletext corespunzând culorii butonului.

- (23)  **Ecran Principal:** Scurtătura către meniul principal -"Music".
Ecran Principal: Salt la pagina de teletext corespunzând culorii butonului.

- (24)  Canal + si canal -.

- (25)  Înapoi la pagina anterioară.

- (26)  Comutare către meniul principal.

- (27)  Revenire la canal accesat anterior.

- (28)  Alegerea sursei de semnal din cele disponibile.

AVerTV CaptureHD / AVer3D CaptureHD



Informații siguranță baterie

- Pastrati bateriile într-un loc răcoros și uscat.
- Nu aruncați bateriile uzate în gunoiul menajer. Aruncați bateriile în punctele speciale de colectare sau la punctul de vânzare, dacă este cazul.
- Scoateți bateriile atunci când nu veți folosi aparatul pentru o lungă perioadă. Îndepărtați întotdeauna din telecomandă bateriile consumate. Scurgerea bateriilor și corodarea pot afecta telecomanda, aruncați bateriile de o manieră sigură.
- Nu amestecați bateriile noi cu altele vechi.
- Nu amestecați baterii de tipuri diferite: alcaline, standard (carbon-zinc) sau reîncărcabile (nichel-cadmium).
- Nu aruncați bateriile în foc. Bateriile pot exploda sau se pot scurge.
- Nu scurtcircuitați niciodată terminalele bateriilor.

9 Комплект поставки

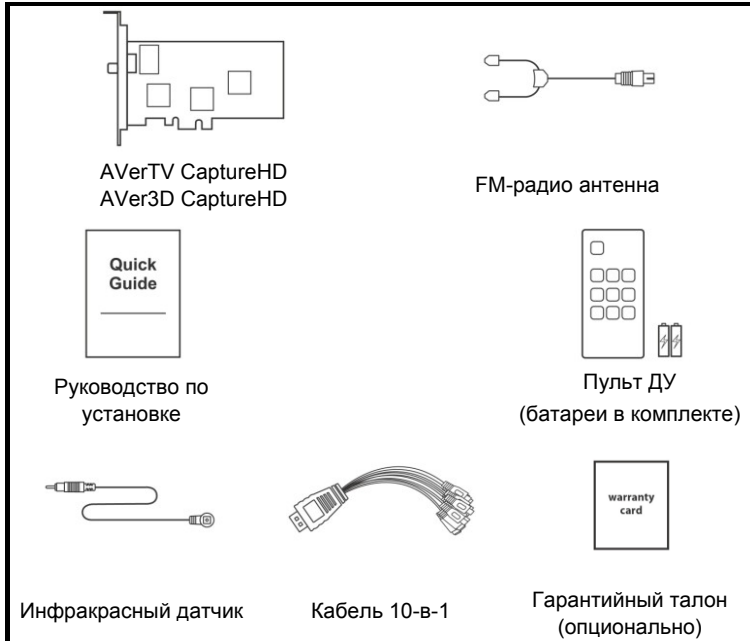

Требования к системе

Требования к системе подробно описаны на коробке. Перед установкой тюнера убедитесь, что ваш ПК полностью отвечает указанным требованиям.

Установка оборудования

Шаг 1. Установка AVerTV CaptureHD

1. Выключите ПК.
2. Снимите крышку.
3. Установите плату в свободный PCI-E slot на материнской плате.
4. Закройте крышку ПК.

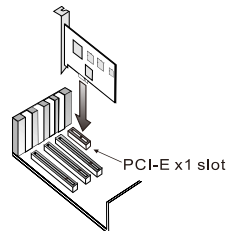

AVerTV CaptureHD / AVer3D CaptureHD

Шаг 2. Подсоединение кабелей

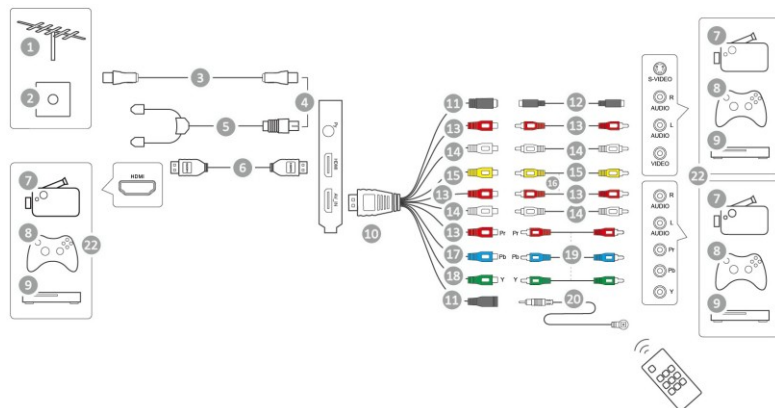

1	TV-антенна	12	Кабель S-Video (не поставляется)
2	Вход для ТВ антенны	13	(Красный)
3	ТВ кабель	14	(Белый)
4	Или	15	(Желтый)
5	FM-радио антенна	16	Композитный кабель (не поставляется)
6	HDMI кабель (не поставляется)	17	(Синий)
7	Видеокамера	18	(Зеленый)
8	Видеоигры	19	Компонентный кабель (не поставляется)
9	Видео/CD/DVD плеер	20	Инфракрасный датчик
10	Кабель 10-в-1	21	Пульт ДУ
11	(Черный)	22	ПРИМЕРЫ

Примечание:

- Предпросмотр видеосигнала, передаваемого по компонентному входу и содержащего защиту от копирования Macrovision, невозможен.
- Запись видеосигнала, передаваемого по HDMI и содержащего цифровую защиту HDCP, невозможна.
- Вы можете одновременно смотреть HDMI или компонентное видео в одном окне и телевизионные программы, композитное видео или S-video в другом окне в режиме PIP (Картинка-в-картинке) / PBP (Картинка-за-картинкой). Более подробную информацию Вы сможете найти в Руководстве пользователя.

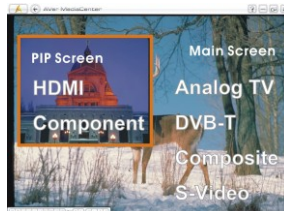

Установка драйверов и ПО

После установки устройства включите компьютер. Просто пропустите настройки и запустите программное обеспечение, которое вы загрузили с официального сайта AVerMedia <http://q.avermedia.com/h727-download-ru> для установки драйверов и ТВ утилиты одновременно.

Установка драйвера и программного приложения под Windows® XP / Windows® XP Media Center Edition

1. Появится диалоговое окно мастера подключения нового оборудования. Нажмите кнопку **«Отмена»**, чтобы отменить работу мастера.
2. Запустите программное обеспечение, которое вы загрузили с официального сайта AVerMedia.
3. После запуска установочной программы выберите **Программное обеспечение AVer MediaCenter 3D**.
4. Нажмите **«Далее»** для продолжения процесса установки.
5. После ознакомления с лицензионным соглашением выберите «Я принимаю условия данного лицензионного соглашения» и нажмите **«Далее»**.
6. Выберите **«Полная»** (Complete), чтобы установить все программное обеспечение, включая **AVer MediaCenter 3D, DirectX 9.0c и Драйвер**. Нажмите кнопку **«Далее»**. Продвинутым пользователям рекомендуется выбрать **«Выборочная»**, чтобы выбрать нужные программы. Для выбора другой директории для установки нажмите **«Обзор»** (Browse).
7. Если предлагается перезапустить компьютер в диалоговом окне мастера установки, выберите **«Да»**. Затем нажмите **«Завершить»**, чтобы закончить установку.

Установка драйвера и программного приложения под Windows® 7 / Windows® 8

1. Появится диалоговое окно мастера подключения нового оборудования. Нажмите кнопку **«Отмена»**, чтобы отменить работу мастера.
2. Запустите программное обеспечение, которое вы загрузили с официального сайта AVerMedia.
3. В диалоговом окне «AutoPlay» (Автозапуск) выберите **«Запустить Autorun.exe» (Run Autorun.exe)**.
4. После запуска установочной программы выберите **Программное обеспечение AVer MediaCenter 3D**.

AVerTV CaptureHD / AVer3D CaptureHD

5. В случае появления диалогового окна "User Account Control" (Управление учетной записью пользователя) выберите **«Разрешить» (Allow)**.
6. Нажмите **«Далее»** для продолжения процесса установки.
7. После ознакомления с лицензионным соглашением выберите "Я принимаю условия данного лицензионного соглашения" и нажмите **«Далее»**.
8. Выберите **«Полная» (Complete)**, чтобы установить все программное обеспечение, включая **AVer MediaCenter 3D, DirectX 9.0c и Драйвер**. Нажмите кнопку «Далее». Продвинутым пользователям рекомендуется выбрать **«Выборочная»**, чтобы выбрать нужные программы. Для выбора другой директории для установки нажмите **«Обзор» (Browse)**.
9. Затем нажмите **«Завершить»**, чтобы закончить установку.

Примечание:

1. Убедитесь, что в системе установлен DirectX 9.0 или выше, иначе программное обеспечение к ТВ-тюнеру не сможет корректно работать.
2. В комплекте к устройству не поставляется программный DVD декодер. Если вы можете проигрывать DVD или MPEG-2 видео файлы на компьютере, то в установке DVD декодера нет необходимости. Однако если вы видите сообщение об ошибке, пожалуйста, установите совместимый DVD декодер с сайта Windows® XP Media Center Edition Partners.
3. Функции 3DTV в ПО AVerMediaCenter 3D не поддерживаются в ОС Windows® XP.

Активация приложения AVer MediaCenter 3D

Windows® XP / Windows® 7

Чтобы запустить приложение из меню Программы, просто выберите **Пуск → Программы → AVerMedia → AVer MediaCenter → AVer MediaCenter 3D**.

Windows® 8

Щелкните на значке **AVer MediaCenter 3D** на экране Пуск или на Рабочем столе.

Удаление программного обеспечения

Windows® XP / Windows® XP Media Center Edition

Если вы находитесь в режиме Media Center, то необходимо переключиться в стандартный режим Windows. Чтобы удалить установленное программное обеспечение ТВ-тюнера, просто выберите **Пуск → Программы → AVerMedia → AVer MediaCenter 3D → Uninstaller (Программа удаления) →**

Руководство по установке

Remove All (Удалить все) → Далее → ОК → Готово.

Windows® 7



1. Чтобы удалить программное обеспечение из системы компьютера выберите **Пуск (Start) → Программы (Programs) → AVerMedia → AVer MediaCenter 3D → Uninstaller (Удаление программы).**
2. При появлении диалогового окна **“User Account Control” (Управление учетной записью пользователя)** выберите **«Разрешить» (Allow).**
3. Выберите **Удалить все → Далее → ОК → Готово.**

Windows® 8

1. Щелкните правой кнопкой на значке **AVer MediaCenter 3D** на экране Пуск и выберите **Uninstall.**
2. В разделе **Programs and Features**, выберите **AVer MediaCenter 3D → Uninstall/Change.**
3. Выберите **Удалить все → Далее → ОК → Готово.**

Пульт ДУ

После установки драйверов и приложений можно использовать пульт дистанционного управления для включения/выключения программ, выбора каналов, регулировки громкости и т.п.

- ◆ **Функция включения с пульта:** Если Ваш компьютер выключен, Вы можете включить его и запустить приложение с помощью пульта. Нажмите кнопку  на пульте для включения Вашего компьютера. Нажмите кнопку  еще раз для запуска приложения.















Примечание:

1. Функция «Включение с пульта» может быть отключена в BIOS вашей материнской платы.
2. Для активации функции «Включение с пульта», пожалуйста, проверьте включена ли функция 'PCI wake-up' в BIOS Вашего ПК. Для этого войдите в настройки BIOS в разделе "Power management" (Управление питанием) и удостоверьтесь, что функция "Power On" включена. (Подробнее смотрите в инструкции к вашему ПК.)

AVerTV CaptureHD / AVer3D CaptureHD

Кнопки пульта ДУ



Кнопки	Описание
(1) 	Включение/выключение приложения.
(2) 	Отключение/включение звука.
(3) 	Используйте цифровые клавиши для выбора канала.
(4) 	Переключиться в полноэкранный режим.
(5) 	Выбор между доступными режимами аудио.
(6) 	Основной: Вы можете использовать стрелки для выбора функций на экране и нажать «OK» для подтверждения выбора. Режим PIP: Перемещение или изменение размера окна PIP.
(7) 	Управление уровнем громкости.
(8) 	Основной: Переход на экран «Видео» в главном меню. Режим телетекста: Переход на страницу телетекста, отмеченную зеленым.
(9) 	Основной: Переход на экран «ТВ» в главном меню. Режим телетекста: Переход на страницу телетекста, отмеченную красным.
(10) 	Отображение информации Телетекст/ субтитры.
(11) 	Телепрограмма (доступно только для цифрового ТВ и радио).
(12) 	Запись текущей программы.
(13) 	Воспроизведение/Пауза выбранного файла.
(14) 	- Предыдущий файл. - Установите время выхода компьютера из ждущего режима или спящего режима. (Эта функция доступна только в AVerTV 3D)

Руководство по установке



- (15) Переход на шаг назад
- (16) Переход на шаг вперёд.
- (17) - Следующий файл.
- Установка таймера перехода ПК в ждущий/спящий режим или закрытия приложений и выключения ПК (Эта функция доступна только в AVerTV 3D)
- (18) Остановка воспроизведения, записи, Сдвига по времени и др.
- (19) TimeShift: - Запуск функции «Сдвиг по времени»
- Приостановка воспроизведения. (Эта функция доступна только в AVerTV 3D)
- (20) PIP Включение/Выключение функции PIP (Картинка в картинке).
- (21) Snapshot: Получение снимка или последовательности снимков.
- (22) Picture: **Основной:** Переход на экран «Изображение» в главном меню.
Режим телетекста: Переход на страницу телетекста, отмеченную синим.
- (23) Music: **Основной:** Переход на экран «Музыка» в главном меню.
Режим телетекста: Переход на страницу телетекста, отмеченную желтым.
- (24) Переключение каналов.
- (25) Back: Возврат на предыдущую страницу.
- (26) Home: - Переход в главное меню.
Exit: - Выход из диалогового окна CI/CA. (Эта функция доступна только с устройствами, поддерживающими интерфейс CI/CA)
- (27) Ch Men: Возврат к предыдущему выбранному каналу.
- (28) Source: Переключение между доступными источниками.

AVerTV CaptureHD / AVer3D CaptureHD



Информация о безопасности батарей:

- Храните батареи в сухом прохладном месте.
- Не выбрасывайте использованные батареи вместе с бытовыми отходами. Батареи следует утилизировать в специальных пунктах приема или возвращать продавцу, если возможно.
- Извлекайте батареи, если прибор не используется длительное время. Севшие батареи необходимо извлекать из пульта дистанционного управления. Утечка электролита из батареи и коррозия может вызвать повреждение пульта дистанционного управления; батареи необходимо безопасно утилизировать.
- Не устанавливайте вместе старые и новые батареи.
- Не используйте вместе батареи разных типов: щелочные, стандартные (угольно-цинковые) или аккумуляторные (никель-кадмиевые).
- Не сжигайте батареи. Батареи могут взорваться или протечь.
- Никогда не замыкайте накоротко контакты батарей.



Model No.: H727E
P/N 300AH727ED4G
Made in Taiwan