

Installing the Enphase Envoy-S Metered

Multiphase for Europe | Multiphase +DRM for Australia and New Zealand

To install the Enphase Envoy-S Metered™ gateway with integrated meter, read and follow all warnings and instructions in this Guide and in the *Enphase Envoy-S Installation and Operation Manual* at: enphase.com/support. Safety warnings are listed on the back of this guide.

How It Works

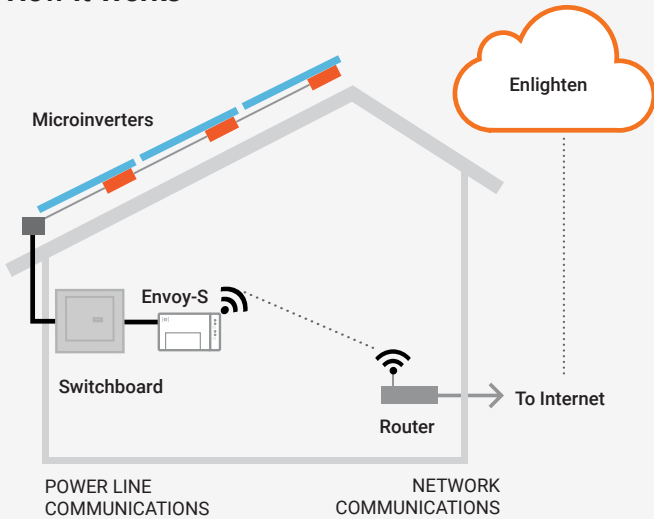

Envoy-S Display and Controls

Track system installation progress with the **Enphase Installer Toolkit™** mobile app. The LEDs on the Envoy-S are solid green when a function is enabled or performing as expected, flashing when an operation is in progress, or solid amber when troubleshooting with Installer Toolkit is required. For a legend of all LED states, see *Troubleshooting*

Network Communications LED
Green when Envoy-S is connected to Enphase Enlighten™.

AP Mode LED
Green when Envoy's AP Wi-Fi network is available.

AP Mode Button
Press to enable Envoy's AP Mode for connecting with a mobile device. Hold for 5 seconds to start WPS connection to a router.

Power Production LED
Green when microinverters are producing power.

Device Communications LED
Green when devices are communicating with Envoy-S.

Device Scan Button
Press to start/stop 15 minute scan for devices over the power line.



Enphase Installer Toolkit mobile app

PREPARATION



- A) Download the latest version of the Enphase Installer Toolkit mobile app and open it to log in to your Enlighten account. With this app, you can connect to the Envoy-S to track system installation progress. To download, go to enphase.com/toolkit or scan the QR code at right.
- B) Check the box for the following items:
 - Enphase Envoy-S Metered gateway
 - Two split-core current transformers (CTs) for production and consumption metering
 - Length of DIN rail for mounting
 - Ferrite bead to attach to your Ethernet Cable, if used
 - *Quick Install Guide* (this document)
- C) Check that there is enough space in the switchboard to install CTs. Do not install the CTs in a panel where they exceed 75% of the wiring space of any cross-sectional area within the panel.
- D) Install the Envoy-S Metered in an IP54-rated, or better enclosure with conduit attachment when installing outdoors. Do not drill holes on the top of the enclosure or anywhere that allows moisture ingress. Metallic enclosures may impair Wi-Fi signal strength. Use an appropriately rated enclosure if installing the Envoy-S indoors.
- E) If you are installing the Envoy-S in a multi-phase application, make sure you have the following items:
 - Additional CTs (CT-100-SPLIT) for multi-phase installations. Make sure you have one CT for each phase monitored, for both production and consumption.
 - A phase coupler. Install a phase coupler on the load side of the over-current protection device. See the Technical Brief on Phase Coupling for your region at enphase.com/support. Consult Enphase support for compatible devices.
- F) Decide how to connect the Envoy-S to the Internet: choose to use Wi-Fi, an Enphase Mobile Connect modem, or Ethernet.
- G) Make sure you have the following optional items, if needed:
 - Enphase Mobile Connect™ modem (order CELLMODEM-02)
 - Ethernet over power line communication (PLC) bridge with Ethernet cables [order EPLC-02 (EU), EPLC-03 (UK) or EPLC-04 (AU/NZ)]
 - Ethernet cable [802.3, Cat5E or Cat6, unshielded twisted pair (UTP)]. Do not use shielded twisted pair (STP) cable.
- H) Install the PV system as directed by the installation manuals.
- I) If an Enphase PV system is or will be installed at the site, create a paper installation map to record device serial numbers and positions in the array. You will scan this map later using Installer Toolkit and your mobile device.
 - As you did with the microinverters (and Enphase AC Batteries, if installed), peel the removable label from the bottom of the Envoy-S and affix it to the paper installation map.
 - Always keep a copy of the installation map for your records.

NOTE: If needed, you can find an installation map with any *Enphase Microinverter Quick Install Guide*.



148-88891-82

INSTALLATION

1 Choose a location for the Envoy-S

- A) Install the Envoy-S Metered near the switchboard and consider the length of the CT leads (4 meters) when choosing the location. If you need to extend the leads (up to 148 meters), refer to the *Enphase Envoy-S Installation and Operation Manual* at: enphase.com/support.
- B) Install the Envoy-S Metered in a protected dry space. If outdoors, install the Envoy-S in an IP54-rated, or better, enclosure with conduit attachment. Use an appropriately rated enclosure if hard wiring the Envoy-S indoors.
NOTE: Metallic enclosures may impair Wi-Fi signal strength.
- C) Mount the Envoy-S horizontally using the included DIN rail.

2 Wire the Envoy-S for Power and Metering

For this step, refer to the **Wiring Instruction Sheet** for your region.

3 Energise the Envoy-S

- A) Close the terminal block door, and secure it with the screw.
- B) Turn on the circuit feeding the Envoy-S.
- C) All four LEDs flash amber during boot up (approximately 2 minutes). When boot up is complete, the Device Communications LED  lights solid amber, indicating that devices are not yet detected.

4 Launch Installer Toolkit and Start AP Mode

- A) Launch the Installer Toolkit app and tap **View Systems**.
- B) The Envoy's AP (Access Point) Wi-Fi network allows you to connect your mobile device (smart phone or tablet) to the Envoy-S. The AP Mode LED  lights solid green when the network is available.
 - On the Envoy-S, if the AP Mode LED is not lit, press the AP Mode button.
 - On your mobile device, go to Settings and join the Wi-Fi network "Envoy_nnnnnn" (where "nnnnnn" represents the final six digits of the Envoy-S serial number).

5 Detect Devices and Select the Grid Profile

Use one of the following methods to detect devices (Enphase Microinverters and/or Enphase AC Batteries).

Method A // Provision devices with Installer Toolkit

Use the Installer Toolkit mobile app to configure the Envoy-S with the serial numbers of the installed devices.

- A) Select the system you are working with, or tap **[+]** to add a system.
- B) If the serial number for the Envoy-S you are installing is not displayed on the System Overview screen, tap the **[+]** next to the word "Envoys". When the app displays the serial number of the Envoy-S, tap it to add it to the system.
- C) Following the on-screen instructions to create the arrays and scan the serial numbers from the installation map..
- D) Tap the **Connect** button. This provisions the scanned devices on the Envoy-S.
- E) When prompted, confirm the number of devices that you installed and select the grid profile.

The Device Communications LED lights solid green if all of the provisioned devices are communicating or solid amber if any devices are not communicating.

Method B // Discover devices with Installer Toolkit

Use the Installer Toolkit mobile app to set the number of devices the Envoy-S should search for on the power line.

- A) Tap **Connect to an Envoy**.
- B) When prompted, enter the number of devices that you installed and select the grid profile.
- C) When prompted to start a device scan, tap **OK**.

The Device Communications LED flashes green while scanning. It lights solid green when all of the devices you installed are communicating or solid amber if any devices are not communicating.



With all methods

If the Device Communications LED remains solid amber, see *Troubleshooting* **b**.

NOTE: In systems where a central disconnect (or contactor) is installed, you must configure the meters as described in **Step 6** before device discovery can complete.

6 Verify System Configuration

While still connected to the Envoy-S with Installer Toolkit, check the Overview screen for the following:

- A) Confirm that the expected number of devices are detected and communicating.
- B) On the Overview screen, check that the new profile is set on all the devices. This may take up to 5 minutes for a typical system.
- C) Tap the **Meters** button.
- D) If there is a check  next to **Production Meter**, the production meter is enabled. If a gear  is shown, you must enable the meter:
 - Tap **Production Meter**. If the meter mode is **Multi-Phase**, select the number of **Phases Metered**. This is based on how your Envoy-S is wired. For example, if the Envoy-S is wired for three, select three phases.
 - Follow the on-screen instructions to enable the Production Meter.
- E) If you installed consumption metering CT(s), tap **Consumption Meter** to enable the meter.
 - If the meter mode is **Multi-Phase**, select the number of **Phases Metered**. The available options will match or exceed the value selected for the Production Meter.
 - Based on where you installed the consumption CT, indicate whether the circuit that passes through the consumption CT includes:
 - Load with solar production (net) or
 - Load only (total or gross), for example, in the case of a line-side tap.
 - Follow the on-screen instructions to enable the Consumption Meter. If you change the number of **Phases Metered** to exceed the number selected for the Production Meter, the system increases the number for both meters and prompts you to confirm.
- F) Return to the **Overview** screen and verify the meter reading(s).

If you used Installer Toolkit to detect devices, the Power Production LED  lights solid green when all expected microinverters are producing power. If you did not use Installer Toolkit, it lights solid green if all communicating microinverters are producing power. It flashes green when microinverters are upgrading. Check Installer Toolkit for production status details. If the Power Production LED remains solid amber, see *Troubleshooting* **c**.

7 Connect to Enlighten

This section describes using the Envoy-S integrated Wi-Fi or the Mobile Connect modem. For information about using Ethernet PLC bridges, refer to the *Enphase Envoy-S Installation and Operation Manual* at: enphase.com/support.



WARNING: Do not remove power from the Envoy-S if the LEDs are flashing green. This indicates that a software upgrade is in progress.



Method A // Integrated Wi-Fi

Requires a wireless router with an Internet connection.

- On the Envoy-S, verify that no Ethernet cable is plugged into the RJ45 port.
- If the router supports WPS, press and hold the WPS button on the wireless router for a few seconds. On most routers, a WPS indicator begins flashing.
- If you are using the Installer Toolkit mobile app, tap the **Network** button, tap **Wi-Fi**, and then tap your network from the list of available networks. If the wireless router does not support WPS, you may be prompted to enter a password.



If you are not using the Installer Toolkit mobile app, initiate a WPS connection by pressing and holding the Envoy-S AP Mode button for 5 seconds.

The Network Communications LED  begins flashing green. Within three minutes the Network Communications LED lights solid green, indicating a successful connection to Enlighten. If the Network Communications LED remains off or lights solid amber, see *Troubleshooting* .

Method B // Enphase Mobile Connect Modem

(Order CELLMODEM-02 separately)

- Connect the antenna to the antenna connector (marked CELL) on the modem.
- Mount the modem as described in the *Enphase Mobile Connect Installation Guide*.
- First, connect the USB cable to the Envoy-S and then connect the mini-USB connector to the modem. If receiving power from the Envoy-S, the modem power LED lights.

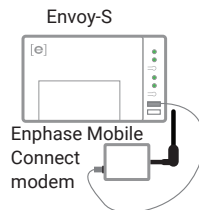

Within three minutes the Network Communications LED lights solid green, indicating a successful connection to Enlighten. If the Network Communications LED remains off or lights solid amber, see *Troubleshooting* in the *Enphase Mobile Connect Installation Guide*.

8 Send System Summary Report

When you have completed your system setup, you can generate and email a summary report.

- From Installer Toolkit, tap **Done** in the upper-right corner of the screen to disconnect from the Envoy. Installer Toolkit will ask if you want to view a summary report.
- Tap **View Report**. The report displays Envoy-S and system information with a list of device serial numbers, their last power reports, and information about the grid profile applied to the devices.
- Tap  to email the report as needed as a record of successful system installation and for evidence of grid profile settings.

ACTIVATE MONITORING

Register the Envoy-S in Enlighten (enlighten.enphaseenergy.com).

Method A // If the Envoy-S is associated with a system in Installer Toolkit

- On your mobile device, go to Settings and disconnect from the Envoy's Wi-Fi network.
- Return to the Installer Toolkit app and tap the **Sync** button on the System Overview screen.
- When you have access to a computer with Internet access, log in to Enlighten and select the system name from the Activation List on the dashboard.
- From the activation form, open Array Builder.

If you used Installer Toolkit to build arrays and scan device serial numbers, the array(s) are built—make any necessary adjustments in Array Builder.

If you did NOT use Installer Toolkit to build arrays and scan microinverter serial numbers, create the virtual array in Array Builder using the installation map as your reference. (You may need to wait if the devices have not yet reported to Enlighten.)

Method B // If the Envoy-S is NOT associated with a system in Installer Toolkit

- Log into Enlighten and click **Add a New System** from the dashboard.
- Enter the System, Installer, Owner, and Location information.
- Enter the Envoy-S serial number.
- Click **Save** to submit the form.
- After the devices have reported to Enlighten, open Array Builder from the activation form, and create the virtual array, using the installation map as your reference.

WIRING INSTRUCTION SHEET FOR AUSTRALIA AND NEW ZEALAND

The Envoy-S uses terminal blocks for power and metering connections. Wire these terminal blocks as described in the following.

You will need to install one split-core CT per monitored phase for production metering and one split-core CT per monitored phase for consumption metering. Use a protected route in conduit (wireway) for the CT wires to the Envoy-S. If you need to extend the leads (up to 148 meters), refer to the *Enphase Envoy-S Installation and Operation Manual* at: enphase.com/support.



DANGER! Risk of electric shock. Always de-energise circuits before wiring for power and CTs.

DANGER! Risk of electrocution! Do not install CTs when current is flowing in the sensed circuit. Always install CT wires in the terminal blocks before energising the sensed circuit.

NOTE: Because of variance in switchboard design and main power feed, there may not always be enough space to install CTs.

NOTE: It is important to match CT and voltage sense phases. Be sure to consistently identify all the AC lines at three points: the main switchboard feed, the Envoy, and the solar production circuit breaker. Wire colours may not always consistently identify Lines 1, 2 and 3. If in doubt, use a multimeter to check.

- A) Before running the CT wires through conduit, use coloured tape to mark each of the CTs and the free ends of its wires, marking each with a different colour. You can run multiple CT wires through a single conduit.
- B) Wire the Envoy-S for **power**
- Depending on the number of phases you will wire, use a one-, two-, or three-pole (20 A maximum) circuit breaker for the supply wiring.
 - Make sure supply wiring is 2.5 mm² copper rated at 75° C or better.
 - Locate the screw on the terminal block door, and loosen it with a screwdriver to unlock the door and flip it open.
 - Connect Line 1 to L1, Line 2 to L2, Line 3 to L3, and Neutral to N, as required.
 - Tighten all connections to 0.56 Nm.**
- C) Install the **production** CTs on phases as required:
- Locate the arrow on the CT label.
 - To monitor production on Line 1:**
 - Connect the white wire to the "I1" terminal and the blue wire to the "I1" terminal.
 - Clamp the CT on active Line 1 of the solar production circuit with the arrow pointing toward the load (away from the solar array).
 - To monitor production on Line 2:**
 - Connect the white wire to the "I2" terminal and the blue wire to the "I2" terminal.
 - Clamp the CT on active Line 2 of the solar production circuit with the arrow pointing towards the load (away from the solar array).
 - To monitor production on Line 3:**
 - Connect the white wire to the "I3" terminal and the blue wire to the "I3" terminal.
 - Clamp the CT on active Line 3 of the solar production circuit with the arrow pointing towards the load (away from the solar array).
 - Tighten all connections to 0.56 Nm**

- D) Install the **consumption** CTs on phases as required:
- Locate the arrow on the CT label.
 - Make sure that the AC mains wire(s) are de-energised until you have secured the CT wires in the terminal blocks.
 - Note:** Only run active conductors of the same phase through each CT. Each CT can monitor multiple active conductors.
 - To monitor consumption on Line 1:**
 - For the first CT, connect the white wire to "I1" and the blue wire to "I1".
 - Clamp the CT on the main supply Line 1 (active). When the consumption CT is on Line 1 (active) conductor, the arrow must point towards the load (away from the grid).
 - To monitor consumption on Line 2:**
 - For the second CT, connect the white wire to "I2" and the blue wire to "I2".
 - Clamp the CT on the main supply Line 2 (active). When the consumption CT is on Line 2 (active) conductor, the arrow must point towards the load (away from the grid).
 - To monitor consumption on Line 3:**
 - For the third CT, connect the white wire to "I3" and the blue wire to "I3".
 - Clamp the CT on the main supply Line 3 (active). When the consumption CT is on Line 3 (active) conductor, the arrow must point towards the load (away from the grid).
 - Tighten all connections to 0.56 Nm.**
- E) Install DRM support and a central disconnect as required for Australia. The multi-phase Envoy-S Metered gateway supports DRM (Demand Response Management). The Envoy-S (ENV-S-WM-230) has a pre-installed 15kΩ resistor that provides DRED bypass when DRED is not required.
- NOTE:** In systems where a central disconnect (contactor) is installed, you must configure the meters as described in Step 6 before device discovery can complete.

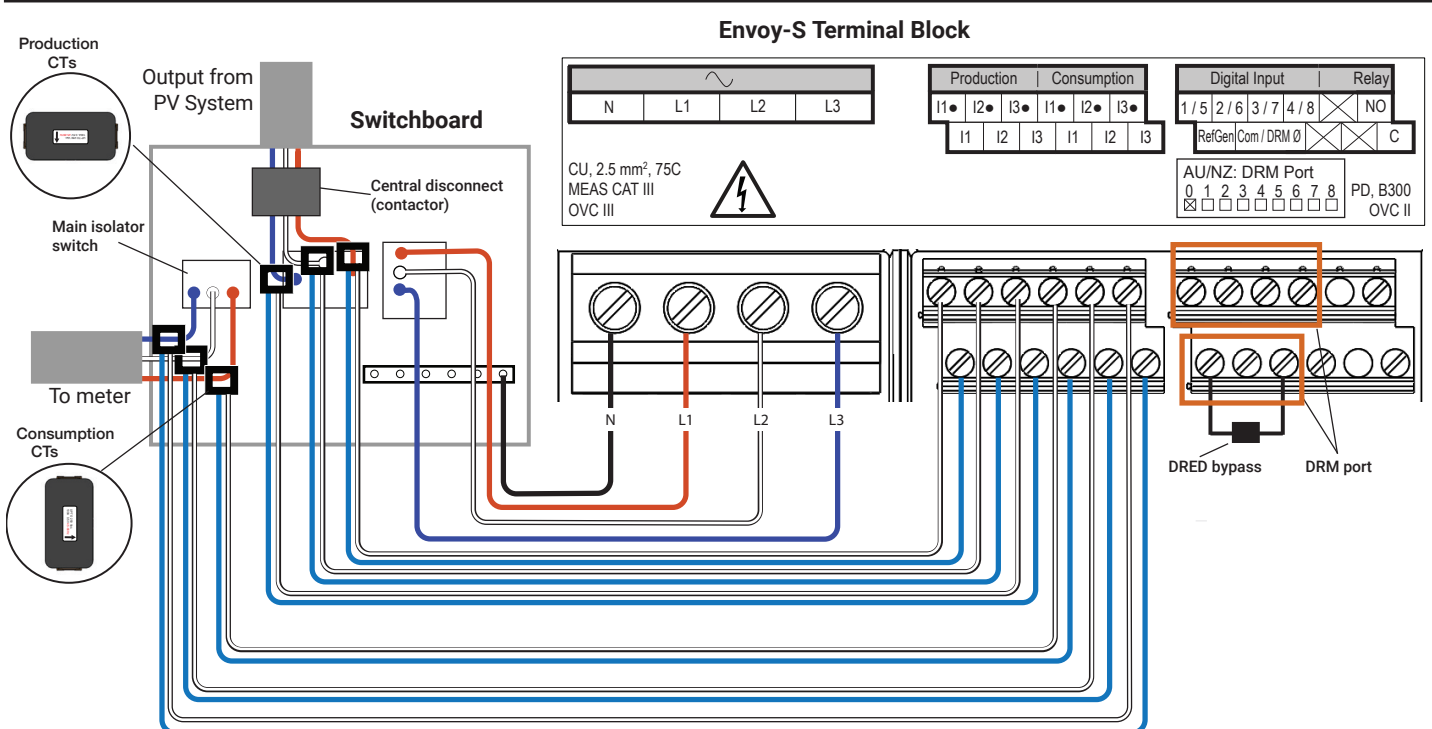

TROUBLESHOOTING

a LED overview

LED	State	Description
All	Flashing amber in unison	The Envoy-S is booting up
	Flashing green sequentially	Software upgrade in progress
Network communications	Solid green	Communicating with Enlighten
	Flashing green	WPS connection in progress or the Envoy-S is attempting to connect to Enlighten
	Solid amber	Local network connection only
	Off	No network connection
AP mode	Solid green	AP mode enabled: Envoy-S Wi-Fi network available
	Off	AP mode disabled: Envoy-S Wi-Fi network unavailable
Power production	Solid green	All communicating microinverters are producing
	Flashing green	Microinverter upgrade in progress
	Solid Amber	At least one microinverter is not producing
	Off	Microinverters are not producing or communicating (low light or night time)
Device communications	Solid Green	All devices are communicating
	Flashing Green	Device scan in progress
	Solid Amber	At least one device is not communicating
	Off	Devices are not communicating (low light or night time)

b Device detection issues

If the Device Communications LED  lights solid amber, it may be a result of low light levels. If there isn't enough sunlight to power up the microinverters, they can't communicate with the Envoy.

If there is sufficient daylight for the microinverters to power up, the issue may be that the Envoy-S is having difficulty communicating over the power lines. To troubleshoot this issue:

- Check the Installer Toolkit mobile app to see which devices are not communicating.
- Check that the circuit breaker(s) for the PV array are in the "ON" position.
- Verify that the PV modules are connected to the microinverters.
- Verify the PV module DC voltage is within the allowable range for the microinverter.

c Power production issues

If the Power Production LED  lights solid amber, check the Installer Toolkit mobile app to see which microinverters are not producing:

- If none of the microinverters are producing power, there may be a grid or wiring issue. First, verify that there is proper input voltage and frequency from the grid. Next, check the breaker and wiring, starting at the switchboard.
- If all of the non-productive microinverters are on the same branch, check the breaker and wiring starting at the junction box for the affected branch.
- If only one or scattered microinverters are not producing power, first check to see that the AC connectors are fully seated in the Engage Cable connectors. Next, check that each module is providing the required startup voltage for the microinverter (22V). A PV module that is failing or that is undersized may not generate enough power for AC conversion.

d Internet connection issues

If you are using Wi-Fi and the Network Communications LED  remains off:

- The WPS connection window may have timed out. Retry the connection steps.
- Make sure that the broadband router is operational by checking that other devices at the site can access the network.
- Be aware that metal enclosures or obstructions impede wireless communication.
- If you cannot see your router or access point in the list on the Envoy, or cannot maintain a connection, it may be necessary to add a wireless repeater to extend the network range.

If you are using Wi-Fi and the Network Communications LED lights solid amber, make sure that the broadband router is connected to the Internet by checking that other devices at the site can access the Internet.



If you are using the Enphase Mobile Connect modem and the Network Communications LED remains off or lights solid amber, see Troubleshooting in the *Enphase Mobile Connect Installation Guide*.

For any connection method, you can troubleshoot network issues with the Installer Toolkit mobile app by tapping the **Network** button, then **Diagnostic Tools**.











If you replace the broadband router, configure the Envoy-S Wi-Fi settings for the new Wireless Network Name (SSID) and password.

SAFETY

Safety and Advisory Symbols

	DANGER: This indicates a hazardous situation, which if not avoided, will result in death or serious injury.
	WARNING: This indicates a situation where failure to follow instructions may be a safety hazard or cause equipment malfunction. Use extreme caution and follow instructions carefully.
	NOTE: This indicates information particularly important for optimal system operation. Follow instructions carefully.

Safety Instructions

	DANGER: Risk of electric shock. Risk of fire. Do not attempt to repair the Envoy-S; it contains no user-serviceable parts. Tampering with or opening the Envoy-S will void the warranty. Warranty void if cover removed. If the Envoy-S fails, contact Enphase Customer Support for assistance (http://enphase.com/global/contact/).
	DANGER: Risk of electrocution! Do not install CTs when current flowing in the sensed circuit. Always install CT wires in the terminal blocks before energizing the sensed circuit.
	DANGER: Risk of electric shock. Do not use Enphase equipment in a manner not specified by the manufacturer. Doing so may cause death or injury to persons, or damage to equipment.
	DANGER: Risk of electric shock. Be aware that installation of this equipment includes risk of electric shock. If you wire the Envoy-S at the sub-board, always de-energise the sub-board before beginning.
	DANGER: Risk of electric shock. Risk of fire. Only qualified personnel should troubleshoot, install, or replace the Envoy-S.
	DANGER: Risk of electric shock. Risk of fire. Do not wire unused terminals or terminal blocks on the Envoy-S.
	WARNING: Before installing or using the Envoy-S, read all instructions and cautionary markings in the technical description and on the Envoy-S.
	WARNING: Risk of equipment damage. If installing the Envoy-S in an enclosure, choose area for installation where ambient temperature does not exceed 46° C.
	NOTE: Do not install the CTs in a panel where they exceed 75% of the wiring space of any cross-sectional area within the panel, or refer to local standards for guidance.
	NOTE: Perform all electrical installations in accordance with all national and local electrical codes.
	NOTE: To ensure optimal reliability and to meet warranty requirements, the Enphase Envoy-S must be installed according to the instructions in this guide.