

*O-Ring Face Seal Fittings*

*Tube Fittings & Adapters*

*Flange Adapters*

*Flareless Bite Type Fittings*

*Instrumentation*

*Conversion Adapters*

*Metric Bite Type*

*NWD*

*Push-to-Connect*

*Test Points*

# **BRENNAN INDUSTRIES**

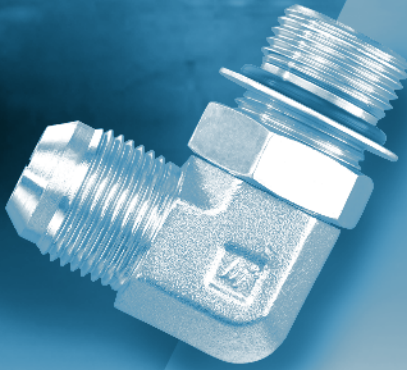

**Quick Reference Product Guide**



## Quick Guide Index

Parts Nomenclature / Glossary of Descriptions .....	1
O-Ring Face Seal Fittings.....	2
Tube Fittings & Adapters .....	3 - 6
Hydraulic Flanges / Accessories.....	6 - 7
Flareless Bite Type Fittings .....	8
Instrumentation.....	8 - 9
Conversion Adapters.....	9 - 10
Metric Bite Type.....	11
NWD.....	12
Push to Connect.....	12 - 14
Test Points.....	14

## Thread Charts • JIC – SAE • Metric/International

Dash Size	2	3	4	5	6	7	8	10	12	14	16	20	24	32	40	48
<b>Tube O.D.</b>	1/8	3/16	1/4	5/16	3/8	7/16	1/2	5/8	3/4	7/8	1	1¼	1½	2	2½	3
<b>Hose I.D.</b>	1/8	3/16	1/4	5/16	3/8		1/2	5/8	3/4		1	1¼	1½	2	2½	3
<b>JIC 37-Flare Thread</b>	5/16 - 24	3/8 - 24	7/16 - 20	1/2 - 20	9/16 - 18		3/4 - 16	7/8 - 14	1 <sup>1</sup> / <sub>16</sub> - 12	1 <sup>3</sup> / <sub>16</sub> - 12	1 <sup>5</sup> / <sub>16</sub> - 12	1 <sup>7</sup> / <sub>16</sub> - 12	1 <sup>9</sup> / <sub>16</sub> - 12	2½ - 12	3 - 12	3½ - 12
<b>SAE O-Ring Thread</b>	5/16 - 24	3/8 - 24	7/16 - 20	1/2 - 20	9/16 - 18		3/4 - 16	7/8 - 14	1 <sup>1</sup> / <sub>16</sub> - 12	1 <sup>3</sup> / <sub>16</sub> - 12	1 <sup>5</sup> / <sub>16</sub> - 12	1 <sup>7</sup> / <sub>16</sub> - 12	1 <sup>9</sup> / <sub>16</sub> - 12	2½ - 12		
<b>NPTF Pipe Thread</b>	1/8 - 27		1/4 - 18		3/8 - 18		1/2 - 14		3/4 - 14		1 - 11½	1¼ - 11½	1½ - 11½	2 - 11½	2½ - 8	3 - 8
<b>NPSM Swivel Thread</b>	1/8 - 27		1/4 - 18		3/8 - 18		1/2 - 14		3/4 - 14		1 - 11½	1¼ - 11½	1½ - 11½	2 - 11½		
<b>Flat Face Thread</b>			9/16 - 18		11/16 - 16		13/16 - 16	1 - 14	1 <sup>3</sup> / <sub>16</sub> - 12		1 <sup>7</sup> / <sub>16</sub> - 12	1 <sup>11</sup> / <sub>16</sub> - 12	2 - 12			
<b>Code 61 Flange Head O.D.</b>							1.19		1.50		1.75	2.00	2.38	2.81	3.31	4.00
<b>Code 62 Flange Head O.D.</b>							1.25		1.62		1.88	2.12	2.50	3.12		
<b>British Thread BSPP/BSPT</b>	1/8 - 28		1/4 - 19		3/8 - 19		1/2 - 14		3/4 - 14		1 - 11	1¼ - 11	1½ - 11			
<b>Copper Nylon Air</b>																
<b>Brake Thread</b>			7/16 - 24		17/32 - 24		11/16 - 20	13/16 - 18	1 - 18							
<b>SAE 45-Flare Thread</b>	5/16 - 24	3/8 - 24	7/16 - 20	1/2 - 20	5/8 - 18	11/16 - 24	3/4 - 16	7/8 - 14	1 <sup>1</sup> / <sub>16</sub> - 14							
<b>Inverted Flare Thread</b>	5/16 - 28	3/8 - 24	7/16 - 24	1/2 - 20	5/8 - 18	11/16 - 18	3/4 - 18	7/8 - 18	1 <sup>1</sup> / <sub>16</sub> - 16							
<b>Compression Thread</b>	5/16 - 24	3/8 - 24	7/16 - 20	1/2 - 20	9/16 - 18	3/4 - 16	1-1 <sup>1</sup> / <sub>16</sub> - 12	1 <sup>5</sup> / <sub>16</sub> - 12	1 <sup>7</sup> / <sub>16</sub> - 12	1 <sup>9</sup> / <sub>16</sub> - 12	2½ - 12					
<b>Metric Thread</b>	<b>10</b>	<b>12</b>	<b>14</b>	<b>16</b>	<b>18</b>	<b>20</b>	<b>22</b>	<b>24</b>	<b>26</b>	<b>27</b>	<b>30</b>	<b>33</b>	<b>36</b>	<b>42</b>	<b>48</b>	
	M 10x1.0	M 12x1.5	M 14x1.5	M 16x1.5	M 18x1.5	M 20x1.5	M 22x1.5	M 24x1.5	M 26x1.5	M 27x2.0	M 30x2.0	M 33x2.0	M 36x2.0	M 42x2.0	M 48x2.0	

## Parts Nomenclature

Brennan Industries, Inc.'s hydraulic tube fitting and adapter part numbers are constructed from symbols that identify the series, size, material and type of product. When ordering part numbers, begin by listing the series followed by the size and the material suffix. Sizes are measured in sixteenths of an inch (example: 4/16 or 4). The standard product is produced in steel and requires no material suffix. If ordering stainless steel products, add the suffix SS, and if you are ordering brass products, add the suffix B. Standard steel shapes such as 90°, 45°, tees and crosses are produced as a forging as well as fitting components brazed together. If you require forged one-piece construction parts, order the part number with the FG suffix. All stainless steel and brass shapes are forged one-piece construction and therefore do not require the FG suffix. Metric Bite Type Fittings are called out by tube size (in millimeters) i.e. 20mm Tube (S20), while Metric Port Fittings are called out by Thread O.D. and Thread Pitch (in millimeters) i.e. 30x2.0 or 30x1.5. BSPP fittings, while different from U.S. threads are still measured fractionally and are therefore called out by sixteenths of an inch.

### 2501-08-08-SS

This is a 2501 Series with a 1/2" male JIC tube and a 1/2" male pipe thread. The part number also indicates that the product is made of stainless steel.

### 2501-12-08-FG

This is a 2501 Series with a 3/4" male JIC tube and a 1/2" male pipe thread. The part number also indicates that the product was produced as a forged one-piece construction, steel adapter.

### 2501-04-04-B

This is a 2501 Series with a 1/4" male JIC tube and a 1/4" male pipe thread. The part number also indicates that the product is made of brass.

## Glossary of Descriptions

**AORB:** Adjustable O-ring Boss (NWO)

**B:** Brass

**BHLN:** Bulk Head Lock Nut

**BSPP:** British Standard Pipe Parallel (G Thread)

**BSPPS:** British Standard Pipe Parallel Swivel

**BSPT:** British Standard Pipe Taper (R Thread)

**BT:** Bite Type

**BT:** Bored Through Connector in Double Ferrule Series

**BTS:** Bite Type Swivel

**BULN:** Back-up Lock Nut (NWO)

**BW:** Butt Weld

**C:** (before number) Bite Type

**C:** (after number) Cap

**COR:** Captive O-Ring (Style DIN 3852, Form E)

**C HEX:** Width Across the Wrench

**D:** Aluminum

**DKO:** 24° Sealing Cone (Female Swivel) with O-Ring

**E:** Extra Light (Metric Fittings)

**F:** (before number) Flare-O

**FBSPP:** Female British Standard Pipe Parallel

**FBSPT:** Female British Standard Pipe Tapered

**FBSPPS:** Female British Standard Pipe Parallel Swivel

**FFS:** Female Face Seal

**FFSS:** Female Face Seal Swivel

**FG:** Forged Flats of the Hex

**FIF:** Female Inverted Flare

**FJ:** Female J.I.C.

**FJIS:** Female J.I.S.

**FJS:** Female J.I.C. Swivel

**FK:** Female Komatsu

**FMS:** Female Metric Swivel

**FO:** Flare-O

**FORB:** Female O-ring Boss

**FP:** Female Pipe

**FPS:** Female Pipe Swivel

**FS:** Face Seal

**FSAES:** Female SAE Swivel, 45° Seat

**H:** Hollow Hex O-ring Plug

**HB:** Hose Barb

**HP:** Hollow Hex Pipe Plug

**I.D.:** Inside Dimension

**JIC:** Joint Industrial Council, 37° Flare

**JIS:** Japanese Industrial Standard, 30° Flare

**L:** Light (7005-04-L06-12)

**L:** Long (6400-L-20-20-0)

**LGTH:** Length

**LH:** Large Hex

**LL:** Extra Long Drop

**LLL:** Extra Extra Long

**LLLL:** Extra Extra Extra Long

**MAORB:** Male Adjustable O-ring Boss (NWO)

**MBT:** Metric Bite Type

**MBSPP:** Male British Standard Pipe Parallel

**MBSPPADJ:** Male British Standard Pipe Parallel Adjustable

**MBSPPAORB:** Male British Standard Pipe Parallel Adjustable O-ring Boss

**MBSPT:** Male British Standard Pipe Tapered

**MFS:** Male Face Seal

**MIFS:** Male Inverted Flare Swivel

**MJ:** Male J.I.C.

**MJIS:** Male J.I.S.

**MKOM:** Male Komatsu

**M.M.:** Millimeters

**MM:** Male Metric

**MMADJ:** Male Metric Adjustable

**MMAORB:** Male Metric Adjustable O-ring Boss use with ISO 6149

**MMORR:** Male Metric O-Ring and Retaining Ring

**MORB:** Male O-ring Boss

**MP:** Male Pipe

**MS:** Metric Swivel

**N:** Used as prefix for Instrumentation fittings series (N2404-04-04-SS)

**N:** Extended Length (5404-N-02x0.750)

**N:** Locknut for NWO Assembly (0306-N-03)

**NBR:** Assembled with Nut and Bite Ring

**NPSM:** American (formerly National) Pipe Straight Mechanical

**NPTF:** American (formerly National) Pipe Taper Fuel

**NWO:** Nut Washer O-ring (MAORB)

**O:** O-Ring

**O.D.:** Outside Dimension

**ORB:** O-Ring Boss

**PC DOT:** SAE DOT Push to Connect Fittings for Vehicle Applications

**PCNY:** Push to Connect Nylon Fittings

**PCNB:** Push to Connect Nickel-Plated Brass Fittings

**PL:** Push Lock

**PLATE MAX:** Recommended Maximum Plate Thickness After Assembling the Bulkhead with the 306 Locknut, 318 Nut & 319 Sleeve

**P:** Plug

**S:** Heavy (7005-04-S06-14)

**S:** Steel

**SAE:** Society of Automotive Engineering

**SHP:** Square Head Plug











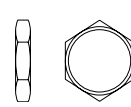



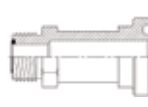
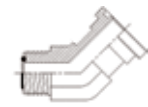





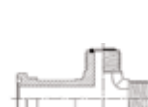
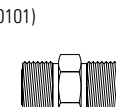
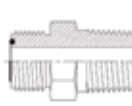

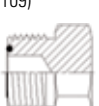
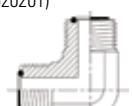
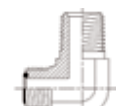

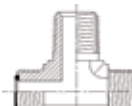
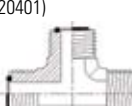

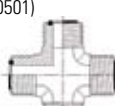
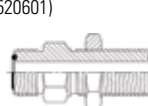
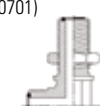

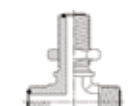
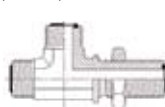



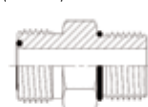
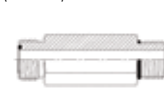

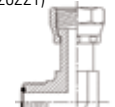

**SS:** Stainless Steel

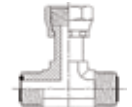
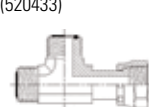
**TS:** Tube Spud

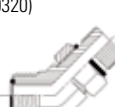
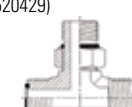
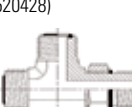
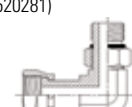
**V:** Versa Flare



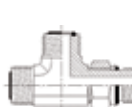













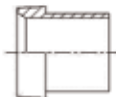

















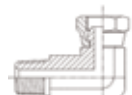



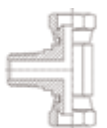
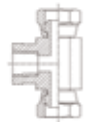



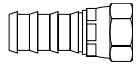



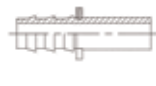

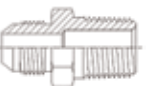
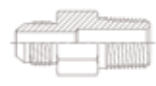

**Y FLATS:** Width Across the Wrench Flats

## O-Ring Face Seal Fittings

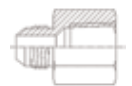





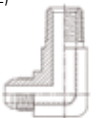
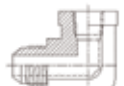





(520112)  <b>FS0304-C</b> Cap Assembly Insert	(520118)  <b>FS0306</b> Bulkhead Lock Nut	(520110)  <b>FS0318</b> Nut	(520115)  <b>FS0319</b> Sleeve	(520104)  <b>FS0403</b> Bore-MFS Straight	 <b>FS1700</b> MFS-Flange Straight Code 61	 <b>FS1703</b> MFS-Flange 45° Code 61
 <b>FS1704</b> MFS-Flange 90° Code 61	 <b>FS1800</b> MFS-Flange Straight Code 62	 <b>FS1803</b> MFS-Flange 45° Code 62	 <b>FS1804</b> MFS-Flange 90° Code 62	 <b>FS1805</b> MFS-MFS- Flange Tee Code 62	 <b>FS1806</b> MFS-MFS- Flange Tee Code 62	(520101)  <b>FS2403</b> MFS-MFS Straight
 <b>FS2404</b> MFS-MP Straight	 <b>FS2406</b> FFS-MFS Tube End Reducer	(520109)  <b>FS2408</b> MFS Plug	(520201)  <b>FS2500</b> MFS-MFS 90°	 <b>FS2501</b> MFS-MP 90°	 <b>FS2503</b> MFS-MP 45°	 <b>FS2601</b> MFS-MFS-MP Tee
(520401)  <b>FS2603</b> MFS-MFS-MFS Tee	 <b>FS2605</b> MFS-MP-MFS Tee	(520501)  <b>FS2650</b> MFS-MFS- MFS-MFS Cross	(520601)  <b>FS2700*</b> MFS-MFS Bulkhead Union	(520701)  <b>FS2701*</b> MFS-MFS Bulkhead 90°	(520801)  <b>FS2702*</b> MFS-MFS Bulkhead 45°	 <b>FS2703*</b> MFS-MFS- MFS Bulkhead Tee
(520201)  <b>FS2704*</b> MFS-MFS- MFS Bulkhead Tee	(J515 Type CH)  <b>FS4000</b> Buna O-Ring	 <b>FS4001</b> Viton O-Ring	 <b>FS6001</b> Silver Braze Ring	(520120)  <b>FS6400-0</b> MFS-MORB Straight	(520122)  <b>FS6400-L-0</b> MFS- MORB Straight Long	 <b>FS6402</b> MFS-FJS Straight
 <b>FS6403</b> MFS-MJ Straight	(520221)  <b>FS6500</b> MFS-FFSS 90°	 <b>FS6503</b> FP-FFSS 90°	 <b>FS6504</b> FFSS-MJ Straight	 <b>FS6505</b> MP-FFSS Straight	 <b>FS6540</b> FFSS-MORB Straight	 <b>FS6600</b> MFS-MFS- FFSS Branch Tee
(520433)  <b>FS6602</b> MFS-FFSS- MFS Run Tee	(520220)  <b>FS6801-NWO</b> MFS-MAORB 90°	(520320)  <b>FS6802-NWO</b> MFS-MAORB 45°	(520429)  <b>FS6803-NWO</b> MFS-MFS-MAORB Tee	(520428)  <b>FS6804-NWO</b> MFS-MAORB-MFS Tee	(520281)  <b>FS6809-NWO</b> FFSS-MAORB 90°	 <b>FS7202-NWO-FG</b> MFS-MBSPP 45°
 <b>FS7205</b> MFS- MMAORB 90° Elbow	 <b>FS7210-NWO-FG</b> MFS-MFS-MMAORB Tee	 <b>FS7215-NWO-FG</b> MFS-MMAORB-MFS Tee	 <b>FS7300-NWO-FG</b> MFS-MMAORB 45° Elbow	 <b>FS7640-0</b> MFS-MMORB ISO 6149		

\* Insert "-LN" in part number to include lock nut when ordering bulkhead fittings. Example: FS2700-LN-04-04.













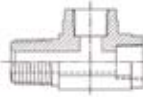

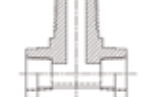

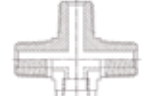
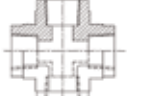
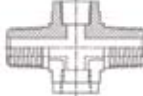
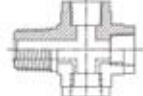

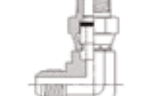
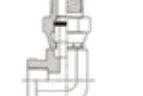



















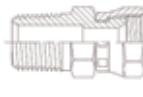



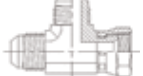

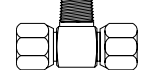





## Tube Fittings & Adapters

 <b>0302</b> Short Nut	(070111)  <b>0304</b> Standard Nut	(070112)  <b>0304-C</b> JIC Cap Nut	(070118/MS #51860)  <b>0306</b> BHLN	(070117)  <b>0306-N</b> BULN	(070110)  <b>0318</b> JIC Tube Nut	(070115)  <b>0319</b> JIC Tube Sleeve
 <b>0403</b> Bore-MJ Straight	 <b>0403-TS</b> MJ Tube Spud	 <b>0404</b> Bore-MP Straight	 <b>0405</b> Bore-FP Straight	 <b>0406</b> Bore-MJ Bulkhead Straight	 <b>0500</b> Bore-MJ 90°	 <b>0501</b> Bore-MP 90°
 <b>0600</b> Bore-Bore-MJ Tee	 <b>0601</b> Bore-Bore-MP Tee	 <b>0602</b> Bore-Bore-FP	 <b>0702</b> Bore-MJ-MJ Tee	 <b>0800</b> Bore-FPS Straight	 <b>0801</b> Bore-FPS 90°	 <b>0900</b> Bore-FJS Straight
(140130)  <b>1404</b> MP-FPS Straight	(140131)  <b>1405</b> FP-FPS Straight	(140230)  <b>1501</b> MP-FPS 90°	 <b>1501-L</b> MP-FPS 90° Long	(140231)  <b>1502</b> FP-FPS 90°	(140330)  <b>1503</b> MP-FPS 90°	(140331)  <b>1504</b> FP-FPS 45°
 <b>1601</b> MP-FPS-FPS Tee	 <b>1602</b> FP-FPS-FPS Tee	 <b>1603</b> FPS-FPS-FPS Tee	 <b>1604</b> MP-FPS-FPS-FPS Cross	(PL = Push Lock) Brass  <b>2111</b> PL-FJS Straight	Brass  <b>2112</b> PL-FSAES Straight	Brass  <b>2113</b> PL-MP Straight
Brass  <b>2114</b> PL-FIF Straight	Brass  <b>2115</b> PL-MIFS Straight	Brass  <b>2116</b> PL-MSAE Straight	Brass  <b>2117</b> PL-Stem Straight	Brass  <b>2118</b> PL-PL Straight	Brass  <b>2119</b> PL-FP Straight	Brass  <b>2120</b> PL-MP 90° Elbow
(070101/MS#51501)  <b>2403</b> MJ-MJ Straight	(070119/MS#51519)  <b>2403-LH</b> MJ-MJ Straight Large Hex	(070102/MS#51500)  <b>2404</b> MJ-MP Straight	 <b>2404-L</b> MJ-MP Straight Long	 <b>2404-LL</b> MJ-MP Straight X-Long	(070103/MS#51503)  <b>2405</b> MJ-FP Straight	 <b>2406</b> FJ-MJ Straight Reducer
(070109/MS#51518)  <b>2408</b> MJ Plug	(070201/MS#51505)  <b>2500</b> MJ-MJ 90°	(070302/MS#51504)  <b>2501</b> MJ-MP 90°	 <b>2501-L</b> MJ-MP 90° Long	(071602)  <b>2501-LL</b> MJ-MP 90° X-Long	(071502)  <b>2501-LLL</b> MJ-MP 90° XX-Long	(070203/MS#51506)  <b>2502</b> MJ-FP 90°











## Tube Fittings & Adapters *continued*

(070302/MS#51508)  <b>2503</b> MJ-MP 45°	 <b>2504</b> MJ-MJ 45°	 <b>2505</b> MJ-FP 45°	(0707425/MS#51512)  <b>2601</b> MJ-MJ-MP Tee	(070427/MS#51513)  <b>2602</b> MJ-MJ-FP Tee	(070401/MS#51510)  <b>2603</b> MJ-MJ-MJ Tee	(070424/MS#51511)  <b>2605</b> MJ-MP-MJ Tee
(070426/MS#51514)  <b>2606</b> MJ-FP-MJ Tee	 <b>2607</b> MJ-MP-MP Tee	 <b>2608</b> MJ-FP-MP Tee	 <b>2609</b> MJ-FP-FP Tee	 <b>2610</b> MP-MP-MJ Tee	 <b>2611</b> MJ-MP-FP Tee	 <b>2612</b> FP-FP-MJ Tee
 <b>2613</b> MP-FP-MJ Tee	 <b>2650</b> MJ-MJ-MJ-MJ Cross	 <b>2651</b> MJ-MP-MJ-MJ Cross	 <b>2652</b> MJ-MJ-MJ-FP Cross	 <b>2653</b> MJ-MJ-MP-MP Cross	 <b>2654</b> MJ-MP-MJ-MP Cross	(070601/MS#51520)  <b>2700</b> MJ-MJ Bulkhead Straight
(070701/MS#51507)  <b>2701</b> MJ-MJ Bulkhead 90°	(070801/MS#51509)  <b>2702</b> MJ-MJ Bulkhead 45°	(0707959/MS#51515)  <b>2703</b> MJ-MJ-MJ Bulkhead Branch Tee	(070958/MS#51516)  <b>2704</b> MJ-MJ-MJ Bulkhead Run Tee	 <b>2705</b> FP-MJ Bulkhead Straight	 <b>2706</b> MP-MJ Bulkhead Straight	 <b>3051</b> MP-FP Low Profile 90°
 <b>3474-NWO</b> MAORB-ORB Straight	(J515 Type I CH/MS#28778)  <b>4000</b> Buna O-Ring	(J515 Type I I H K)  <b>4001</b> Viton O-Ring	 <b>4005</b> Flange O-Ring	 <b>4404</b> HB-MP Straight	 <b>4501</b> HB-MP 90°	 <b>4503</b> HB-MP 45°
 <b>4504</b> HB-HB-HB Tee	 <b>4505</b> HB-MP-HB Tee	 <b>4506</b> HB-HB-MP Tee	 <b>4601-NWO</b> HB-MAORB 90°	 <b>4603-NWO</b> HB-MAORB 45°	 <b>4604-O</b> HB-MORB Straight	(140138)  <b>5000</b> FP-FP Straight
(140137)  <b>5404</b> MP-MP Hex Nipple	 <b>5404-N</b> MP-MP Straight Nipple Long	(140139)  <b>5405</b> MP-FP Straight Expander	(140140)  <b>5406</b> MP-FP Reducer Bushing	 <b>5406-C</b> Pipe Cap	 <b>5406-HP</b> Hollow Hex Pipe Plug	(130109E)  <b>5406-P</b> External Hex Pipe Plug
(130109A)  <b>5406-SHP</b> Square Head Pipe Plug	(140237)  <b>5500</b> MP-MP 90° Elbow	 <b>5501</b> MP-MP 45°	(140239)  <b>5502</b> MP-FP 90° Street Elbow	(140339)  <b>5503</b> MP-FP 45° Street Elbow	(140238)  <b>5504</b> FP-FP 90° Elbow	(140338)  <b>5505</b> FP-FP 45° Elbow











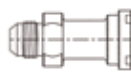

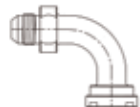

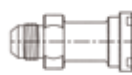

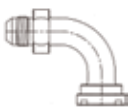





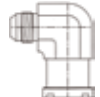

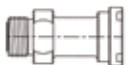









## Tube Fittings & Adapters *continued*

(140437)  <b>5600</b> MP-MP-MP Tee	(140427)  <b>5601</b> MP-MP-FP Tee	(140424)  <b>5602</b> MP-FP-FP Street Tee	(140426)  <b>5603</b> MP-FP-MP Tee	(140425)  <b>5604</b> FP-FP-MP-Branch Tee	(140438)  <b>5605</b> FP-FP-FP Tee	(140537)  <b>5650</b> MP-MP-MP-MP Cross
 <b>5651</b> MP-MP-MP-FP Cross	(140538)  <b>5652</b> FP-FP-FP-FP Cross	 <b>5653</b> MP-MP-FP-FP Cross	 <b>5655</b> MP-FP-FP-FP Cross	 <b>5700</b> MP-MPS 90°	 <b>5701</b> MJ-MPS 90°	 <b>5702</b> FP-MPS 90°
 <b>6000</b> Back-Up Washer	(070120/MS#51525)  <b>6400-O</b> MJ-MORB Straight	(070122/MS#51526)  <b>6400-L-O</b> MJ-MORB Straight Long	 <b>6401-O</b> MORB-MP Straight	 <b>6402-O</b> MORB-FJS Straight	 <b>6404</b> FORB-MP Straight	 <b>6405-O</b> MORB-FP Straight
(090109A)  <b>6408-O</b> MORB External Hex Plug	(090109B)  <b>6408-H-O</b> MORB Hollow Hex Plug	 <b>6410-O</b> MORB-FORB Straight Reducer	 <b>6420</b> FORB-FP Straight	 <b>6425</b> FORB-FORB Straight	 <b>6464</b> MORB-MORB Straight	(070221)  <b>6500</b> MJ-FJS 90°
 <b>6500-L</b> MJ-FJS 90° Long	 <b>6501</b> MP-FJS 90°	(070321/MS#51522)  <b>6502</b> MJ-FJS 45°	 <b>6503</b> FP-FJS 90°	 <b>6504</b> MJ-FJS Straight	 <b>6505</b> MP-FJS Straight	 <b>6506</b> FP-FJS Straight
 <b>6507</b> FP-FJS 45°	 <b>6565</b> FJS-FJS Straight	(070433/MS#51524)  <b>6600</b> MJ-MJ-FJS Tee	(070432/MS#51524)  <b>6602</b> MJ-FJS-MJ Tee	 <b>6603</b> FJS-FJS-MJ Tee	 <b>6604</b> FJS-FJS-MP Tee	 <b>6605</b> FJS-FJS-FP Tee
 <b>6606</b> FJS-FJS-FJS Tee	 <b>6701</b> MJ-FJS Swept 90°	 <b>6701-L</b> MJ-FJS Swept 90° Long	(070220/MS#51527)  <b>6801-NWO</b> MJ-MAORB 90°	 <b>6801-L-NWO</b> MJ-MAORB 90° Long	 <b>6801-LL-NWO</b> MJ-MAORB 90° X-Long	 <b>6801-LLL-NWO</b> MJ-MAORB 90° XX-Long
(070320/MS#51528)  <b>6802-NWO</b> MJ-MAORB 45°	(070429/MS#51529)  <b>6803-NWO</b> MJ-MJ-MAORB Branch Tee	(07048/MS#51530)  <b>6804-NWO</b> MJ-MAORB-MJ Run Tee	 <b>6805-NWO</b> MAORB-FP 90°	 <b>6805-L-NWO</b> MAORB-FP 90° Long	 <b>6806-NWO</b> MAORB-MP 90°	 <b>6807-NWO</b> MAORB-MAORB 90°

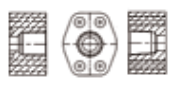
**Tube Fittings & Adapters** *continued*











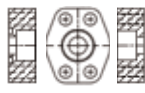

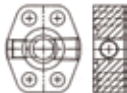
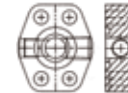

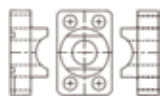
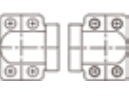
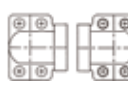
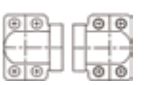
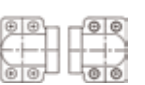

 <p><b>6807-LL-NWO</b> MAORB-MAORB 90° X-Long</p>	 <p><b>6808-NWO</b> MAORB-MAORB 45°</p>	 <p><b>6809-NWO</b> MAORB-FJS 90°</p>	 <p><b>6810-NWO</b> MAORB-FJS 45°</p>	 <p><b>6815-NWO</b> MAORB-FORB 90°</p>	 <p><b>6900-O</b> MORB-FPS Straight</p>	 <p><b>6901-NWO</b> MAORB-FPS 90°</p>
 <p><b>6902-NWO</b> MAORB-FPS 45°</p>	 <p><b>V0318</b> JIC-Flareless Nut</p>	 <p><b>V0319</b> JIC-Flareless Sleeve</p>				(520112)

**Hydraulic Flanges / Accessories**



 <p><b>1700</b> MJ-Flange Straight Code 61</p>	 <p><b>1703</b> MJ-Flange 45° Code 61</p>	 <p><b>1704</b> MJ-Flange 90° Code 61</p>	 <p><b>1710</b> MB-Flange Straight Code 61</p>	 <p>MJ-Flange Straight Code 62</p>	 <p><b>1803</b> MJ-Flange 45° Code 62</p>	 <p><b>1804</b> MJ-Flange 90° Code 62</p>
 <p><b>1810</b> MB-Flange Straight Code 62</p>	 <p><b>1703FG</b> MJ-Flange 45° Code 61</p>	 <p><b>1704FG</b> MJ-Flange 90° Code 61</p>	 <p><b>1724</b> Flange Plug Code 61</p>	 <p><b>1803I</b> MJ-Flange 45° Code 62</p>	 <p><b>1804FG</b> MJ-Flange 90° Code 62</p>	 <p><b>1824</b> Flange Plug Code 62</p>
 <p><b>FS1700</b> MFS-Flange Straight Code 61</p>	 <p><b>FS1703FG</b> MFS-Flange 45° Code 61</p>	 <p><b>FS1704FG</b> MFS-Flange 90° Code 61</p>	 <p><b>FS1800</b> MFS-Flange Straight Code 62</p>	 <p><b>FS1803FG</b> MFS-Flange 45° Code 62</p>	 <p><b>FS1804FG</b> MFS-Flange 90° Code 62</p>	 <p><b>1900-61</b> Hex Head Mounting Kit</p>
 <p><b>1900-62</b> Hex Head Mounting Kit</p>	 <p><b>1900-M</b> Hex Head Mounting Kit Metric</p>	 <p><b>1901</b> Split Flange Kit Code 61</p>	 <p><b>1902</b> Split Flange Kit Code 62</p>	 <p><b>1903/1904-61</b> Captive Flange</p>	 <p><b>1903/1904-62</b> Captive Flange</p>	 <p><b>1914-61</b> Connector Plate</p>
 <p><b>1914-62</b> Connector Plate</p>	 <p><b>1927/1928-61</b> NPTF Port Block</p>	 <p><b>1927/1928-62</b> NPTF Port Block</p>	 <p><b>1929/1930-61</b> SAE Port Block</p>	 <p><b>1929/1930-62</b> SAE Port Block</p>	 <p><b>1933/1934</b> Flat Socket Block - Pipe 500 psi</p>	 <p><b>1935/1936-61</b> Flat Socket Block - Pipe</p>



## Hydraulic Flanges / Accessories continued

 <b>1935/1936-62</b> Flat Socket Block - Pipe	 <b>1937/1938-61</b> Flat Socket Block - Tube	 <b>1937/1938-62</b> Flat Socket Block - Tube	 <b>1940-61</b> Gage Port Spacer	 <b>1940-62</b> Gage Port Spacer	 <b>1942/1943-61</b> Plug Block	 <b>1942/1943-62</b> Plug Block
 <b>1951-61</b> Split Flange	 <b>1951-H</b> Flange Half	 <b>1952-62</b> Split Flange	 <b>1952-H</b> Flange Half	 <b>1959-P</b> Saddle Connector	 <b>1965-61</b> SAE Elbow	 <b>1965-62</b> SAE Elbow
 <b>1967-61</b> NPTF Elbow	 <b>1967-62</b> NPTF Elbow	 <b>1979-61</b> Shipping Plate	 <b>1979-62</b> Shipping Plate	 <b>1990-61</b> Socket Head Mounting Kit	 <b>1990-62</b> Socket Head Mounting Kit	 <b>1990-M</b> Socket Head Mounting Kit Metric
 <b>3300/3301-61</b> Tube Braze Flange Head Connector	 <b>3300/3301-62</b> Tube Braze Flange Head Connector	 <b>4005</b> Flange O-Ring				















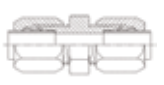
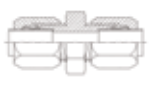
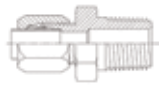
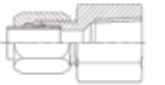
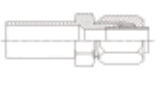



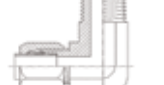



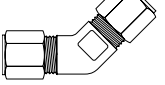

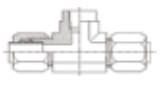



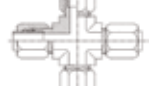







### General Technical

 <b>Code 61</b> Flange Head Detail	 <b>Code 62</b> Flange Head Detail					
---	---	--	--	--	--	--



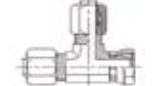



### Additional Available Products

- 1910, Codes 61 & 62** Tube Weld Socket Flange Connector
- 1911, Codes 61 & 62** Pipe Weld Socket Flange Connector
- 1912-O, Code 61** SAE Flange Connector
- 1912-P, Code 61** NPTF Flange Connector
- 1915, 1917 & 1919, Codes 61 & 62** Butt Weld Connector-Variou Pipe Schedules

















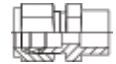

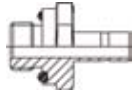
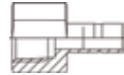





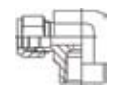
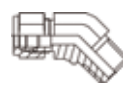

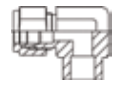
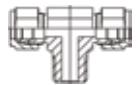
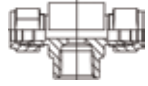
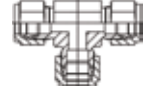
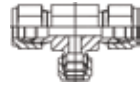
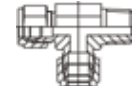
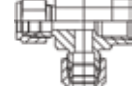
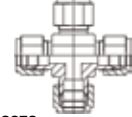
## Flareless Bite Type Fittings

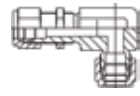
(080112/MS#51590)  <b>C0304-C</b> Cap Nut	(080110/MS#51823)  <b>C0318</b> Nut	(080115A/MS#51825A)  <b>C0319</b> Ferrule	 <b>C2402</b> BT-MJ	(080101/MS#51814)  <b>C2403</b> BT-BT Tube Union Straight	(080119/MS#51856)  <b>C2403-LH</b> BT-BT Tube Union Large Hex Straight	(080102/MS#51819)  <b>C2404</b> BT-MP Adapter Straight
(080103)  <b>C2405</b> BT-FP Adapter Straight	(080110/MS#51823)  <b>C2406</b> Tube-BT Reducer	(080109)  <b>C2408</b> Plug	(080201/MS#51820)  <b>C2500</b> BT-BT Elbow 90°	(0802002/MS#51815)  <b>C2501</b> BT-MP Elbow 90°	(071502)  <b>C2501-L</b> BT-MP Elbow 90° Long	(081602)  <b>C2501-LL</b> BT-MP Elbow 90° X-Long
(080203/MS#51813)  <b>C2502</b> BT-FP Elbow 90°	(080302/MS#51817)  <b>C2503</b> BT-MP Elbow 45°	 <b>C2504</b> BT-BT Elbow 45°	(080425/MS#51815)  <b>C2601</b> BT-BT-MP Tee	(080427/MS#51821)  <b>C2602</b> BT-BT-FP Tee	(080401/MS#51811)  <b>C2603</b> BT-BT-BT Tee	(080424/MS#51824)  <b>C2605</b> BT-MP-BT Tee
(080426/MS#51822)  <b>C2606</b> BT-FP-BT Tee	(080501/MS#51894)  <b>C2650</b> BT-BT-BT Cross	 <b>C2700</b> BT-BT Bulkhead Union	(080701/MS#51855)  <b>C2701</b> BT-BT Bulkhead Union 90°	(08081)  <b>C2702</b> BT-BT Bulkhead Union 45°	(080959)  <b>C2703</b> BT-BT-BT Bulkhead Branch Tee	(080958)  <b>C2704</b> BT-BT-BT Bulkhead Tee
 <b>C2705</b> FP-BT Bulkhead	 <b>C2706</b> BT-MP Bulkhead	 <b>C2707</b> BT-MJ Bulkhead	(080120/MS#51843)  <b>C6400-O</b> BT-MORB	(080122)  <b>C6400-L-O</b> BT-MORB Long	(080221/MS#51852)  <b>C6500</b> BT-BTS 90°	(080321)  <b>C6502</b> BT-BTS 45°
(080433/MS#51853)  <b>C6600</b> BT-BT-BTS Tee	(0808432/MS#51854)  <b>C6602</b> BT-BTS-BT Tee	(080220/MS#51839)  <b>C6801-NWO</b> BT-MAORB 90°	(080320/MS#51842)  <b>C6802-NWO</b> BT-MAORB 45°	(080429/MS#51841)  <b>C6803-NWO</b> BT-BT-MAORB Tee	(080428/MS#51892)  <b>C6804-NWO</b> BT-MAORB-BT Tee	

## Instrumentation

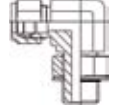
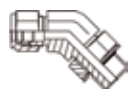
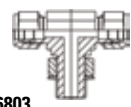

 <b>N0304</b> Plug	 <b>N0318</b> Nut	 <b>N0319-B</b> Back Ferrule	 <b>N0319-F</b> Front Ferrule	 <b>N0319-S</b> Ferrule Set	 <b>N2402</b> Male JIC Connector	 <b>N2403</b> Union
---	--	---	--	---	---	--

## Instrumentation *continued*

 <b>N2403</b> Reducing Union	 <b>N2404</b> Male Connector*	 <b>N2405</b> Female Connector	 <b>N2406</b> Reducer	 <b>N2408</b> Cap	 <b>N2425</b> Butt Weld Male Connector	 <b>N2426</b> Socket Weld Male Connector
 <b>N2427</b> Male JIC Adapter	 <b>N2428</b> Male Adapter	 <b>N2429</b> O-Seal Male Adapter	 <b>N2430</b> Female Adapter	 <b>N2431</b> Female Gage Adapter	 <b>N2440</b> Port Connector	 <b>N2440</b> Reducing Port Connector
 <b>N2500</b> Union Elbow	 <b>N2501</b> Male Elbow	 <b>N2502</b> Female Elbow	 <b>N2503</b> 45 Degree Male Elbow	 <b>N2525</b> Butt Weld Male Elbow	 <b>N2526</b> Socket Weld Male Elbow	 <b>N2601</b> Male Branch Tee
 <b>N2602</b> Female Branch Tee	 <b>N2603</b> Union Tee	 <b>N2603</b> Reducing Union Tee	 <b>N2605</b> Male Run Tee	 <b>N2606</b> Female Run Tee	 <b>N2650</b> Cross	 <b>N2700-LN</b> Bulkhead Union
 <b>N2700-LN</b> Bulkhead Reducing Union	 <b>N2701-LN</b> Bulkhead Union Elbow	 <b>N2705-LN</b> Bulkhead Female	 <b>N2706-LN</b> Bulkhead Male Connector	 <b>N2707-LN</b> Bulkhead Male JIC	 <b>N2709-LN</b> Bulkhead Reducer	 <b>N6400</b> O Seal Male Connector
 <b>N6801</b> Positionable Male Elbow	 <b>N6802</b> 45 Degree Pos. Male Elbow	 <b>N6803</b> Positionable Male Branch Tee	 <b>N6804</b> Positionable Male Run Tee	 <b>N7002</b> BSPP Male Connector		

\*Bored Through Male Connectors for Thermocouples are available. Example: N2404-04-04-BT-SS.

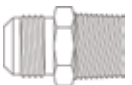
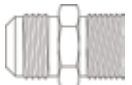
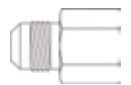
## Conversion Adapters

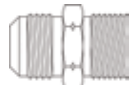
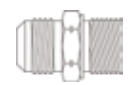
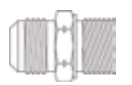















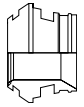





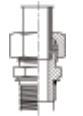
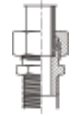

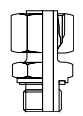
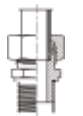
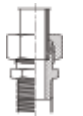
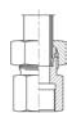
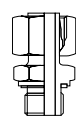
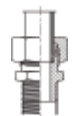

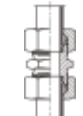

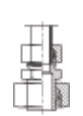

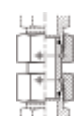
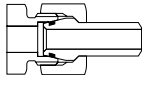
 <b>7000</b> MJ-MBSPT	 <b>7002</b> MJ-MBSPP	 <b>7003</b> MJ-FBSPP	 <b>7004</b> MJ-FBSPPS	 <b>7005</b> MJ-MM Metric Port	 <b>7005-L</b> MJ-MM Light Metric (Dual)	 <b>7005-S</b> MJ-MM Heavy Metric (Dual)
--	--	--	---	--	---	---

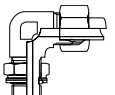
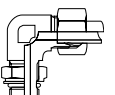
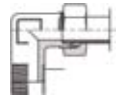
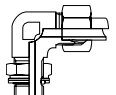
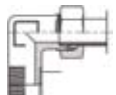
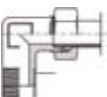
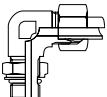
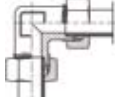
**Conversion Adapters** *continued*

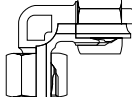
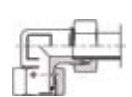
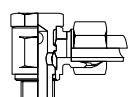
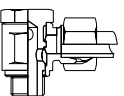
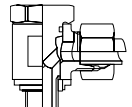
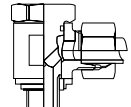
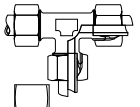
 <b>7007</b> MJ-FMS Metric	 <b>7008</b> MJ-MJIS Union	 <b>7008-F</b> MJ-FJIS*	 <b>7009</b> Komatsu MJ-MK Union	 <b>7009-F</b> Komatsu MJ-FK*	 <b>7022</b> FJS-MBSPP	 <b>7023</b> FJS-FBSPPS
 <b>7025</b> FJS-MM Metric	 <b>7030</b> MP-MBSPT Nipple	 <b>7032</b> MP-MBSPP	 <b>7033</b> MP-FBSPP	 <b>7034</b> MP-FBSPPS	 <b>7040</b> FP-MBSPT	 <b>7042</b> FP-MBSPP
 <b>7045</b> FP-MM Metric	 <b>7062</b> MORB-MBSPP	 <b>7100</b> MJ-MBSPT 45° Elbow	 <b>7102-NWO</b> MJ-MBSPPADJ 45°	 <b>7200</b> MJ-MBSPT 90° Elbow	 <b>7202-NWO</b> MJ-MBSPPADJ 90°	 <b>7204-NWO</b> MJ-MBSPPADJ 90°
 <b>7205-NWO</b> MJ-MMADJ 90° Elbow	 <b>7220</b> FJS-MBSPT 90° Elbow	 <b>7222</b> FJS-MBSPP 90° Elbow	 <b>7588-P</b> MJIS Plug	 <b>7599-P</b> Komatsu MK Plug	 <b>7688-C</b> FJIS Cap	 <b>7699-C</b> Komatsu FK Cap
 <b>8055</b> Metric MM-MM Nipple	 <b>8080</b> MJIS-MBSPT	 <b>8088</b> MJIS-MJIS Union	 <b>8180</b> MJIS-MBSPT 45° Elbow	 <b>8280</b> MJIS-MBSPT 90° Elbow	 <b>8555-H</b> Metric MM Hollow Hex Plug	 <b>8555-P</b> Metric Plug
 <b>8800</b> Metric Bonded Seal	 <b>9000</b> MBSPT-MBSPT Nipple	 <b>9001</b> MBSPT-FBSPT Bushing	 <b>9002</b> MBSPT 90° Elbow	 <b>9020</b> MBSPP-MBSPT Straight	 <b>9022</b> MBSPP-MBSPT Nipple	 <b>9023</b> MBSPP-FBSPP w/60° Seat
 <b>9024</b> MBSPP-FBSPPS	 <b>9025</b> Metric MBSPP- MM Nipple	 <b>9033</b> FBSPP-FBSPP Coupling	 <b>9124</b> MBSPP-FBSPPS Swept 45°	 <b>9222</b> MBSPP 90°	 <b>9224</b> MBSPP-FBSPPS 90°	 <b>9224-L</b> MBSPP-FBSPPS 90° Long
 <b>9322</b> MBSPP-MBSPP-MBSPP	 <b>9344</b> FBSPP-FBSPP- FBSPP Tee	 <b>9500-P</b> MBSPT Plug	 <b>9522-H</b> MBSPP Hollow Hex Plug	 <b>9522-P</b> MBSPP Hollow Hex Plug	 <b>9644-C</b> FBSPP Cap	 <b>9900</b> British Bonded Seal

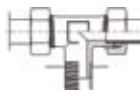
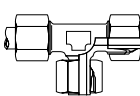

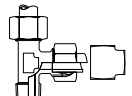
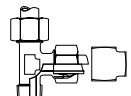
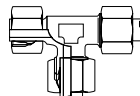
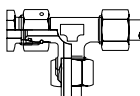





























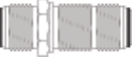







\*Swivel style available upon request. Also available 9621-NWO MBSP60° - MBSPPAORR 90° Adj. Elbow.

## Metric Bite Type

 <b>D8000</b> Reinforcing Sleeve	 <b>D8002</b> Met. Bulkhead Lock Nut	 <b>D8003</b> Blanking Cap-DKO	 <b>D8004</b> Tube End Plug	 <b>D8006</b> Double Bite Ring	 <b>D8008</b> Tube Nut	 <b>D8009</b> 37°/24° Metric Flare Insert
 <b>D8010</b> 37° Metric Flare Sleeve	 <b>D8011</b> 37° Metric Flare Nut	 <b>D8020-NBR</b> MBT-FBSPP (Rigid) Gauge Cplg.	 <b>D8021</b> FMS-FBSPP (Rigid) Gauge Cplg.	 <b>D8031-O-NBR</b> MBT-MMCOR Strt.	 <b>D8032-O-NBR</b> MBT-MMISO 6149	 <b>D8033-NBR</b> MBT-Met. Taper Strt.
 <b>D8034-NBR</b> MBT-F. Met. (Rigid)	 <b>D8036-O</b> FMS-MMCOR Strt.	 <b>D8041-O-NBR</b> MBT-MBSPCOR Strt.	 <b>D8043-NBR</b> MBT-MBSPT Strt.	 <b>D8044-NBR</b> MBT-FBSPP (Rigid)	 <b>D8046-O</b> FMS-MBSPCOR Strt.	 <b>D8050-NBR</b> MBT-MP Strt.
 <b>D8051-O-NBR</b> MBT-MORB Strt.	 <b>D8060-NBR</b> MBT-MBT Strt. Union	 <b>D8061-LN-NBR</b> MBT-MBT Bulkhead Strt.	 <b>D8062-NBR</b> FMS-MBT Strt. Standpipe Reducer	 <b>D8064</b> Met. Internal Cplg. Nut	 <b>D8067</b> F. SWV CPLG-DKO	 <b>D8096</b> Straight Weld Nipple
 <b>D8097-NBR</b> MBT-Butweld Strt.	 <b>D8098-NBR</b> MBT Butweld Bulkhead	 <b>D8231-NWO-NBR</b> MMORR 90° Adj Elbow	 <b>D8232-NWO-NBR</b> MMISO 6149 90° Adj. Elbow	 <b>D8233-NBR</b> MBT-Met. Taper 90° Elbow	 <b>D8241-NWO-NBR</b> MBSPORR 90° Adj. Elbow	 <b>D8243-NBR</b> MBT-MBSPT 90° Elbow
 <b>D8250-NBR</b> MBT-MP 90° Elbow	 <b>D8251-NWO-NBR</b> MAORB 90° Adj. Elbow	 <b>D8260-NBR</b> MBT-MBT Equal Elbow	 <b>D8261-LN-NBR</b> MBT-MBT Bulkhead 90°	 <b>D8263-NBR</b> MBT-FMS 90° Adj. Elbow	 <b>D8269-NBR</b> MBT-FMS Adj. 90-DKO	 <b>D8290-NBR</b> Met. Parallel Low Press. Banjo
 <b>D8291-NBR</b> BSPP Low Press Banjo Elbow	 <b>D8292-NBR</b> Met. Parallel High Press. Banjo Elbow	 <b>D8293-NBR</b> BSPP High Pressure Banjo Elbow	 <b>D8360-NBR</b> MBT-MBT-MBT Equal Tee	 <b>D8433-NBR</b> MBT-MBT-MK BR. Tee	 <b>D8443-NBR</b> MBT-MBT-MBSPT BR. Tee	 <b>D8463-NBR</b> MBT-MBT-FMS Adj. Branch Tee
 <b>D8469-NBR</b> MBT-MBT-FMS Adj. BR. Tee-DKO	 <b>D8533-NBR</b> MBT-MK-MBT Run Tee	 <b>D8543-NBR</b> MBT-MBSPT-MBT Run Tee	 <b>D8563-NBR</b> MBT-FMS-MBT Adj. Run Tee	 <b>D8569-NBR</b> MBT-FMS-MBT Adj. Run Tee-DKO	 <b>D8660-NBR</b> MBT Equal Cross	







Metric Bite Type Fittings are also available as body only by omitting the NBR suffix.

## NWD

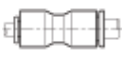
 <b>F0403</b> Bore-FO Straight	 <b>F0500</b> Bore-FO 90°	 <b>F0600</b> Bore-Bore-FO	 <b>F2403</b> FO-FO Straight	 <b>F2403-LH</b> FO-FO Straight Large Hex	 <b>F2404</b> FO-MP Straight	 <b>F2405</b> FO-FP Straight
 <b>F2406</b> FJ-FO Straight Reducer	 <b>F2408</b> FO Plug	 <b>F2500</b> FO-FO 90°	 <b>F2501</b> FO-MP 90°	 <b>F2501-L</b> FO-MP 90° Long	 <b>F2501-LL</b> FO-MP 90° X-Long	 <b>F2501-LLL</b> FO-MP 90° XX-Long
 <b>F2502</b> FO-FP 90°	 <b>F2503</b> FO-MP 45°	 <b>F2601</b> FO-FO-MP Tee	 <b>F2602</b> FO-FO-FP Tee	 <b>F2603</b> FO-FO-FO Tee	 <b>F2605</b> FO-MP-FO Tee	 <b>F2606</b> FO-FP-FO Tee
 <b>F2650</b> FO-FO-FO-FO Cross	 <b>F2700</b> FO-FO Bulkhead Straight	 <b>F2701</b> FO-FO Bulkhead 90°	 <b>F2702</b> FO-FO Bulkhead 45°	 <b>F2703</b> FO-FO-FO Bulkhead Tee	 <b>F2706</b> MP-FO Bulkhead Straight	 <b>F4003</b> Flare-O Buna
 <b>F4004</b> Flare-O Viton	 <b>F6400-O</b> FO-MORB Straight	 <b>F6400-L-O</b> FO-MORB Straight	 <b>F6500</b> FO-FJS 90°	 <b>F6502</b> FO-FJS 45°	 <b>F6600</b> FO-FO-FJS Tee	 <b>F6602</b> FO-FJS-FO Tee
 <b>F6801-NWO</b> FO-MAORB 90°	 <b>F6801-L-NWO</b> FO-MAORB 90° Long	 <b>F6801-LL-NWO</b> FO-MAORB 90° X-Long	 <b>F6802-NWO</b> FO-MAORB 45°	 <b>F6803-NWO</b> FO-FO-MAORB Tee	 <b>F6804-NWO</b> FO-MAORB-FO Tee	













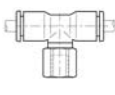
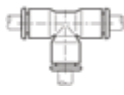
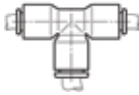

## Push-to-Connect

*Nylon Push-To-Connect Fittings For Industrial Applications - PCNY SERIES (Metric - PCNYM)*

 <b>2403</b> Union - Fractional Inch Tube To Tube	 <b>2403</b> Unequal Union - Fractional Inch Tube To Tube	 <b>2404</b> Male Connector - Fractional Inch Tube To Male NPT	 <b>2405</b> Straight Female Connector - Fractional Inch Tube To NPT	 <b>2406</b> Plug-in Reducer	 <b>2408</b> Plug	 <b>2428</b> Standpipe
--	---	--	--	--	--	---



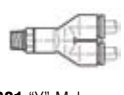
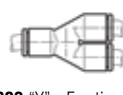





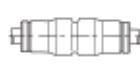

**Push-to-Connect** *continued*

*Nylon Push-To-Connect Fittings For Industrial Applications - PCNY SERIES (Metric - PCNYM)*

 <b>2500</b> Union Elbow - Fractional Inch To Tube	 <b>2500</b> Unequal Union Elbow - Fractional Inch Tube To Tube	 <b>2501</b> Male Elbow - Fractional Inch Tube To Male NPT	 <b>2501</b> Extended Male Elbow - Fractional Inch Tube To Male NPT	 <b>2502</b> Female Elbow - Fractional Inch Tube To NPT	 <b>2503</b> 45° Male Elbow - Fractional Inch Tube To Male NPT or UNF	 <b>2601</b> Male Branch Tee - Fractional Inch Tube To Male NPT or UNF To Tube
 <b>2602</b> Female Branch Tee - Fractional Inch Tube To Male NPT	 <b>2603</b> Tee - Fractional Inch Tube To Tube To Tube	 <b>2603</b> Unequal Tee - Fractional Inch Tube To Tube To Tube	 <b>2605</b> Male Run Tee - Fractional Inch Tube To Tube To Male NPT or UNF	 <b>2650</b> Cross	 <b>2700</b> Bulkhead Union - Tube To Tube	 <b>2701</b> Equal Bulkhead Elbow - Tube To Tube
 <b>2705</b> Female Bulkhead Connector - Tube To NPT	 <b>2801</b> "Y" Male - Fractional Inch Tube To NPT	 <b>2803</b> "Y" - Fractional Inch Tube To Tube	 <b>2805</b> Banjo - Fractional Inch Tube To NPT			

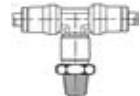
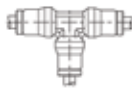

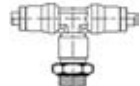
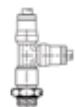

Brennan Tubing PC1094, 1/8", 1/4" and 3/8" sizes are stock in black or white in 100 ft. rolls.

*Nickel-Plated Brass Push-To-Connect Fittings For Industrial Applications - PCNB SERIES (Metric - PCNBM)*

 <b>2403</b> Straight Union - Fractional Inch Tube To Tube	 <b>2404</b> Male Connector - Fractional Inch Tube To NPT	 <b>2405</b> Female Connector - Fractional Inch Tube To NPT	 <b>2406</b> Plug-in Reducer	 <b>2428</b> Standpipe	 <b>2500</b> Union Elbow - Fractional Inch Tube To Tube	 <b>2501</b> Male Elbow - Fractional Inch Tube To NPT
 <b>2601</b> Male Branch Tee - Fractional Inch Tube To NPT To Tube	 <b>2603</b> Tee - Fractional Inch Tube To Tube To Tube	 <b>2605</b> Male Run Tee - Fractional Inch Tube To Tube To NPT	 <b>2700</b> Bulkhead Connector - Fractional Inch Tube To Tube	 <b>6400</b> Male Connector - Fractional Inch Tube To UNF	 <b>6801</b> Male Elbow - Fractional Inch Tube To UNF	 <b>6803</b> Male Branch Tee - Fractional Inch Tube To UNF To Tube
 <b>6804</b> Male Run Tee - Fractional Inch Tube To Tube To UNF						

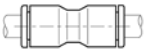

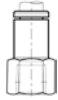
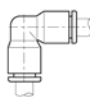
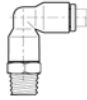
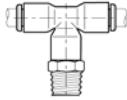
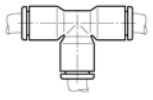

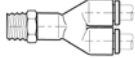
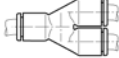





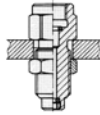

Brennan Tubing PC1094, 1/8", 1/4" and 3/8" sizes are stock in black or white in 100 ft. rolls.

**Push-to-Connect** *continued*
*SAE and DOT Push-To-Connect Fittings For Vehicle Applications - PCDT SERIES*

 <b>2403 Union - Fractional Inch Tube To Tube</b>	 <b>2404 Male Connector - Fractional Inch Tube To Male NPT</b>	 <b>2405 Straight Female Connector - Fractional Inch Tube To NPT</b>	 <b>2500 Union Elbow - Fractional Inch Tube To Tube</b>	 <b>2501 Male Elbow - Fractional Inch Tube To Male NPT</b>	 <b>2601 Male Branch Tee - Fractional Inch Tube To Male NPT</b>	 <b>2603 Union Tee - Fractional Inch Tube To Tube To Tube</b>
 <b>2605 Male Run Tee - Fractional Inch Tube To Male NPT</b>	 <b>2700 Bulkhead Union - Fractional Inch</b>	 <b>2801 "Y" Male Connector - Fractional Inch Tube To NPT</b>	 <b>2803 Union "Y" - Fractional Inch Tube To Tube</b>			

Brennan Tubing PC1094, 1/8", 1/4" and 3/8" sizes are stock in black or white in 100 ft. rolls.

**Test Points**

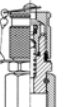
 <b>Test Hose</b> TPH Series	 <b>Gauge Adapter</b> TPA Series	 <b>Direct Gauge Adapter</b> TPD Series	 <b>Pressure Gauge</b> TPG Series	 <b>Single Gauge Kit</b> TPK-1	 <b>Double Gauge Kit</b> TPK-2	 <b>Triple Gauge Kit</b> TPK-3
 <b>TPS-1 Test Coupling</b> TPS-MNPT	 <b>TPS-5 Test Coupling</b> TPS-MORB	 <b>TPS-A Test Coupling</b> TPS-MBSPP	 <b>TPS-B Test Coupling</b> TPS-MBSPT	 <b>TPS-C Test Coupling</b> TPS-MMETRIC	 <b>TPS-6 Test Coupling</b> TPS-FJS	 <b>TPS-E Test Coupling</b> TPS-FFS

OTHER TEST POINTS AVAILABLE: **TPT-362 SERIES** MJ-FJS-FNPTF **TPT-369 SERIES** MJ-FJS-FORB



6701 Cochran Road • Solon, Ohio 44139 U.S.A.  
 Phone: 440.248.1880 • Toll Free: 888.331.1523 • Fax: 440.248.7282 • www.brennaninc.com  
 e-commerce: sales.brennaninc.com

**DISTRIBUTION CENTERS**

California  
 11-A Goodyear  
 Irvine, California 92618  
 Phone: 949.595.0901  
 Fax: 949.595.0933  
 Toll Free: 1.800.942.5321

Georgia  
 5369 Penn Circle  
 Decatur, Georgia 30035  
 Phone: 770.981.8451  
 Fax: 770.987.0926  
 Toll Free: 1.800.458.1988

Ohio  
 30205 Solon Road  
 Solon, Ohio 44139  
 Phone: 440.248.7088  
 Fax: 440.248.9375  
 Toll Free: 1.800.331.1523

Texas  
 1189 108th Street  
 Grand Prairie, Texas 75050  
 Phone: 972.988.8311  
 Fax: 972.660.6638  
 Toll Free: 1.800.443.9937

Washington  
 1516 45th Street E.  
 Sumner, Washington 98390  
 Phone: 253.826.2001  
 Fax: 253.826.4884  
 Toll Free: 1.800.445.7107