

Quick Start Guide
Evaluation Board (EVB) PAN1311/21 USB

No. DS-PAN1311/21USB	REV. 1.1
PAGE	1 of 11
DATE	15.09.2011

Quick Start Guide
Evaluation Board (EVB) PAN1311/21 USB

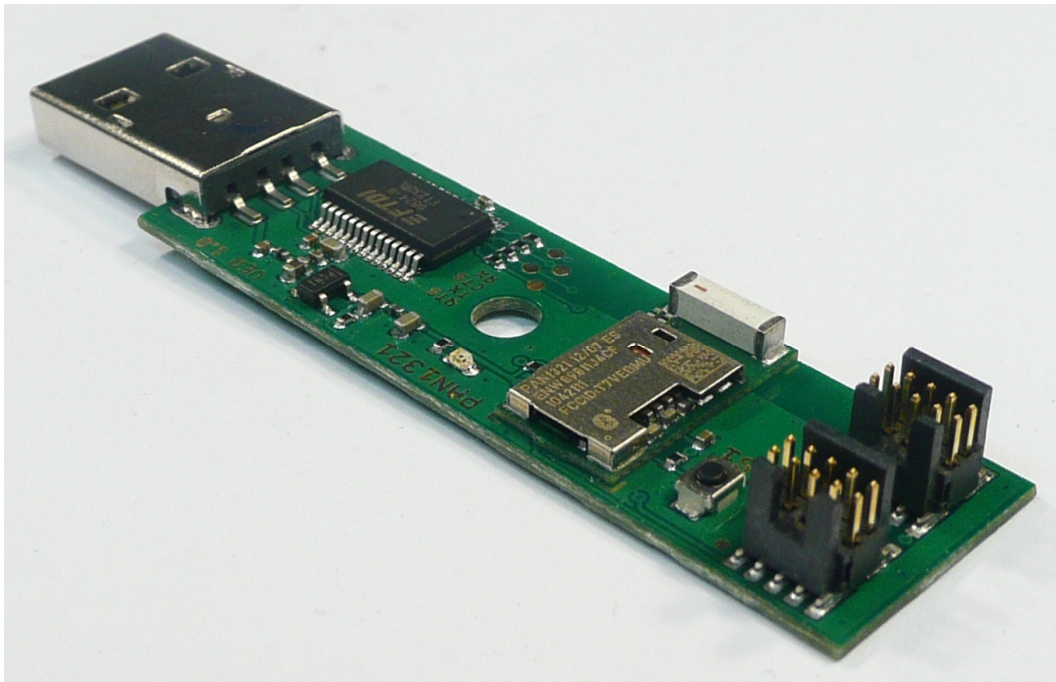

Quick Start Guide Evaluation Board (EVB) PAN1311/21 USB	No. DS-PAN1311/21USB	REV. 1.1
	PAGE 2 of 11	
	DATE 15.09.2011	

1. CONTENT

1. Content.....	2
2. Introduction	3
2.1 Related documents.....	3
4. Functional overview.....	3
5. Connection setup	4
5.1 Software start and navigation	4
5.2 Port configuration	5
5.3 Firmware handling.....	6
5.4 Command tab navigation.....	7
5.5 Creating a connection.....	8
6. Schematic	9
7. Document Information	10
8. General Information.....	11
8.1 Waiver.....	11
9. Life Support Policy	11

PANASONIC ELECTRONIC DEVICES EUROPE GmbH			DESIGNED Erstellt IW
---	--	--	----------------------------

Quick Start Guide

Evaluation Board (EVB) PAN1311/21 USB

2. INTRODUCTION

This document should provide the minimum knowledge needed to establish a simple connection between two PAN1321ETU USB Evaluation Boards (EVB) using Infineon *eBMU_SPP_Toolbox* software. For this limited information is granted. To learn about all aspects of the software please refer to the related documents listed below.

2.1 RELATED DOCUMENTS

For further information on Infineon *eBMU_SPP_Toolbox* software and it's implemented AT command set please refer to:

- *PAN13x1_ReleaseNote_SPP_AT_SW08_V1.8_RN_Rev1.0_DRAFT*
- *PAN13x1_ReleaseNote_SPP_AT_SW21_V2.1_RN_Rev1.0_DRAFT -iPhone version*
- *PAN13x1_SPP_AT_UserManual_SoftwareDescription_Rev5.0 DRAFT*
- *PAN1321_AN_DesignGuide_Rev2 1*
- *User's Manual_PAN1311_V20.xx_Rev1.1*
- *User's Manual_PAN1321_V20.xx_Rev3.1*

4. FUNCTIONAL OVERVIEW

The figure below shows an overview of the Evaluation Board. If there is the need to connect your μ Controller to the EVB please de-solder R1, R2, R3, R4.

For more details please refer also to the schematic in chapter Schematic.

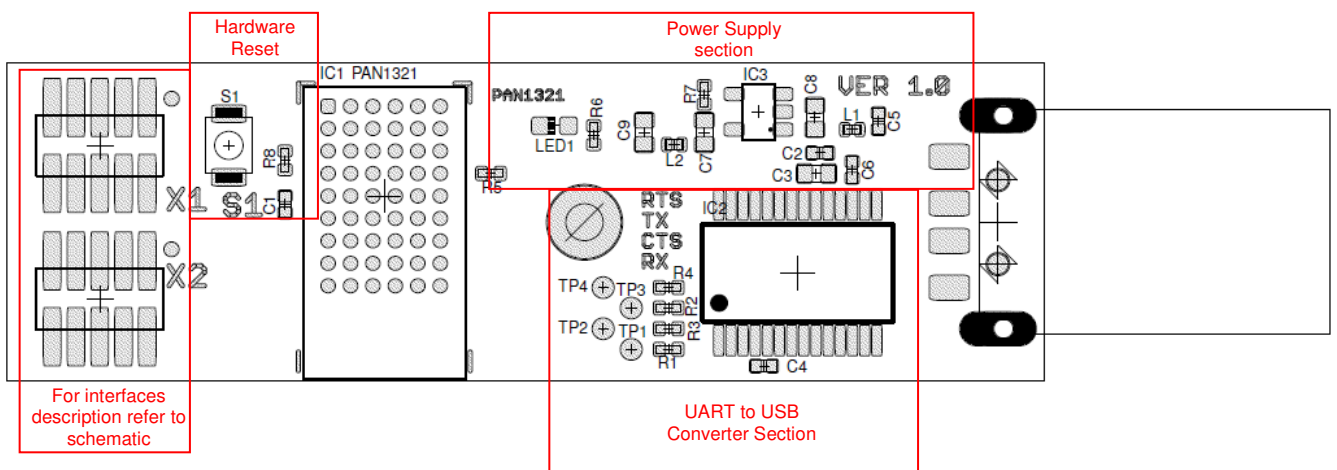

Figure 2 : Evaluation Board Overview

Quick Start Guide

Evaluation Board (EVB) PAN1311/21 USB

No. DS-PAN1311/21USB	REV. 1.1
PAGE 4 of 11	
DATE 15.09.2011	

5. CONNECTION SETUP

This chapter describes how to use the *eBMU_SPP_Toolbox* software in order to send simple data packages from one EVB to the other.

5.1 SOFTWARE START AND NAVIGATION

Browse to the folder where the *eBMU_SPP_Toolbox.exe* file is located and start it. The user interface (figure 2) is shown.

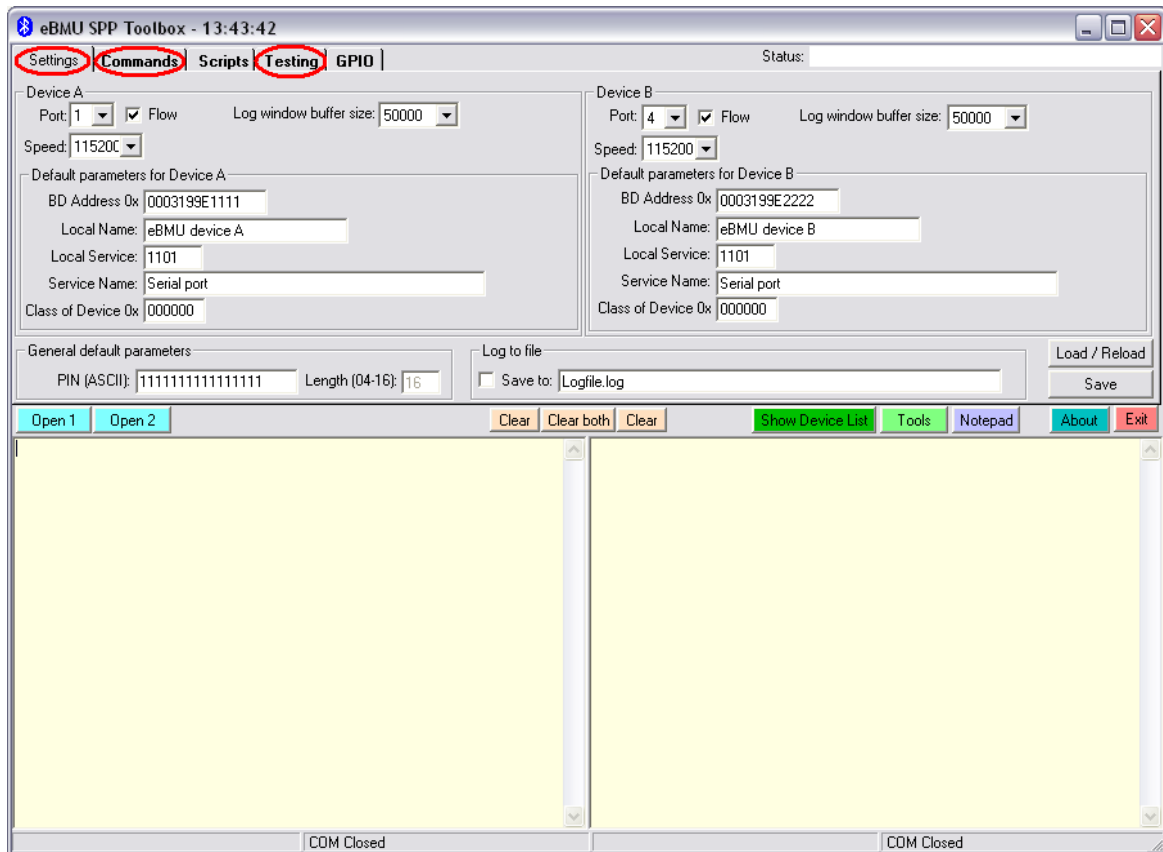

Figure 4 : Toolbox start up screen

Quick Start Guide

Evaluation Board (EVB) PAN1311/21 USB

No. DS-PAN1311/21USB	REV. 1.1
PAGE 5 of 11	
DATE 15.09.2011	

5.2 PORT CONFIGURATION

Please note that the eBMU Toolbox can handle only COM port numbers below 10. You can configure in the System Hardware settings in your operating system. The USB driver can be found in the installation folder.

On the *settings* tab the communication via COM port is handled. It is possible to set a number of default parameters for both EVBs and to save/load all the changes made to this page (saving the settings will also make the program remember the selected port numbers). Please select the right port numbers for both EVBs (found at Windows OS: control panel → system → hardware → device manager → Ports (COM & LPT)) and click the buttons *open/close 1* & *open/close 2*. A status message should appear below the text fields (figure 3). Leave the rest unchanged for now.

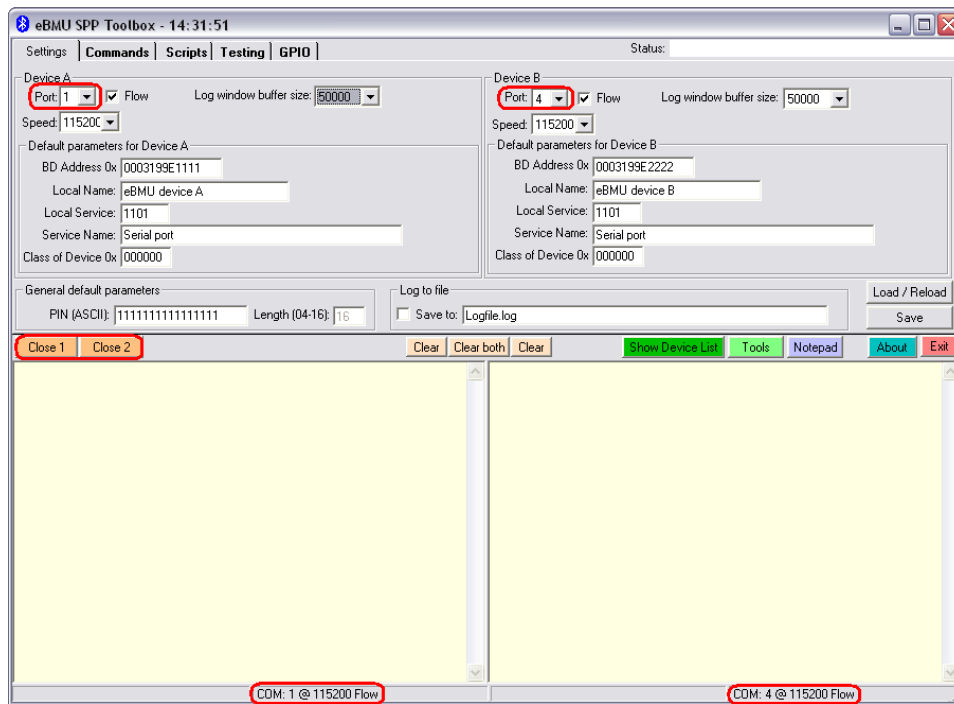

Figure 5 : COM port setup

Quick Start Guide

Evaluation Board (EVB) PAN1311/21 USB

5.3 FIRMWARE HANDLING

At the *testing* tab firmware can be downloaded (*Download image*) to the EVB and a number of changes can be made to it (*Change BD-data*) like assigning a unique BT address (e.g. 0003199E8B73) and oscillator trim value. Make sure that the *Production mode* is enabled before any of these buttons on this tab are used. To do this mark *On* and confirm with a click on *Production mode*. The text field should inform you about of success of this procedure. Be advised to do a hardware reset (push button on EVB) after all changes were made.

Please note:

The *BD_Address* and *OSC_Trim* value have to be read out by “Read BD Address” command before downloading. They have to be programmed by “Change BD-data” command after writing the new image.

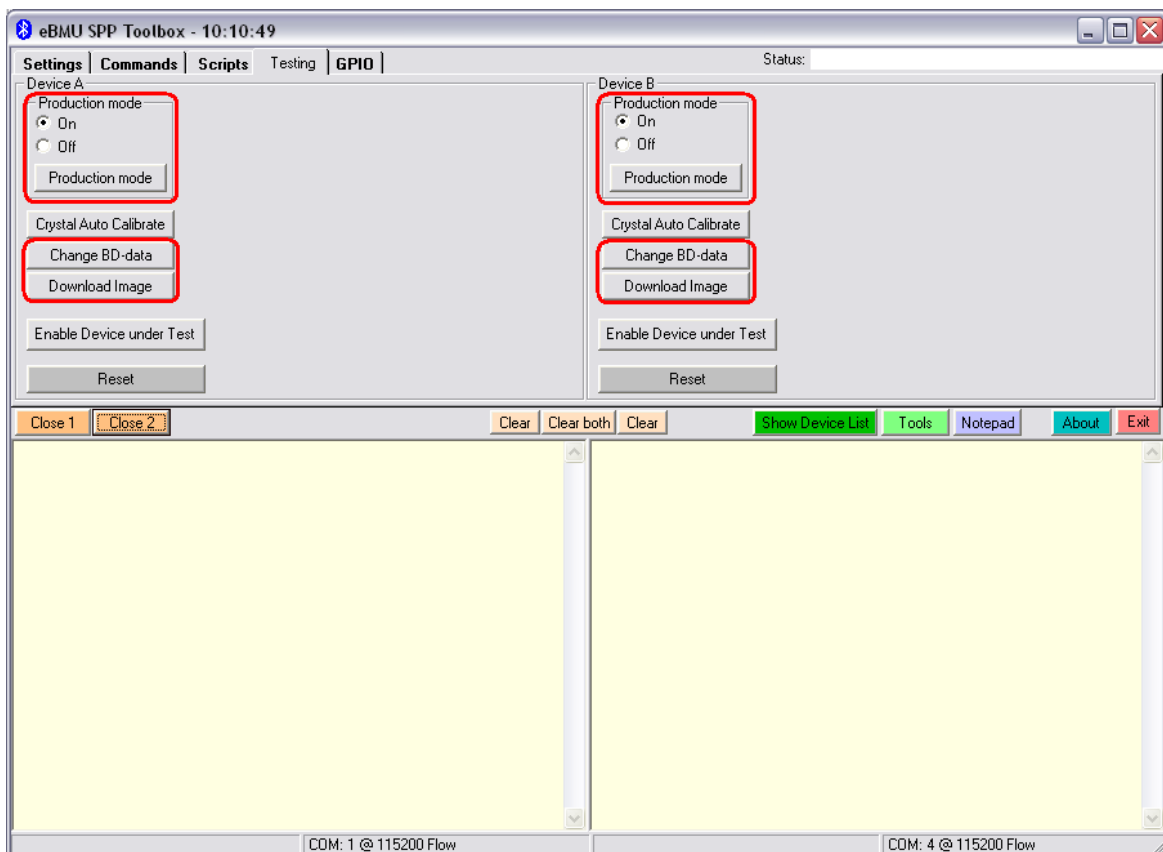

Figure 6 : Testing tab

Quick Start Guide

Evaluation Board (EVB) PAN1311/21 USB

No. DS-PAN1311/21USB	REV. 1.1
PAGE	7 of 11
DATE	15.09.2011

5.4 COMMAND TAB NAVIGATION

At the *Commands* tab are several commands listed for easy click-and-use. Note the colour coding identifying commands by their intended usage:

- Yellow: Settings and informational commands.
- Pink: Security related commands.
- Green: Connection related.
- Red: Disconnection commands.
- Blue: Data transfer
- Light blue: Accept connection
- White: Sniff (during connection)

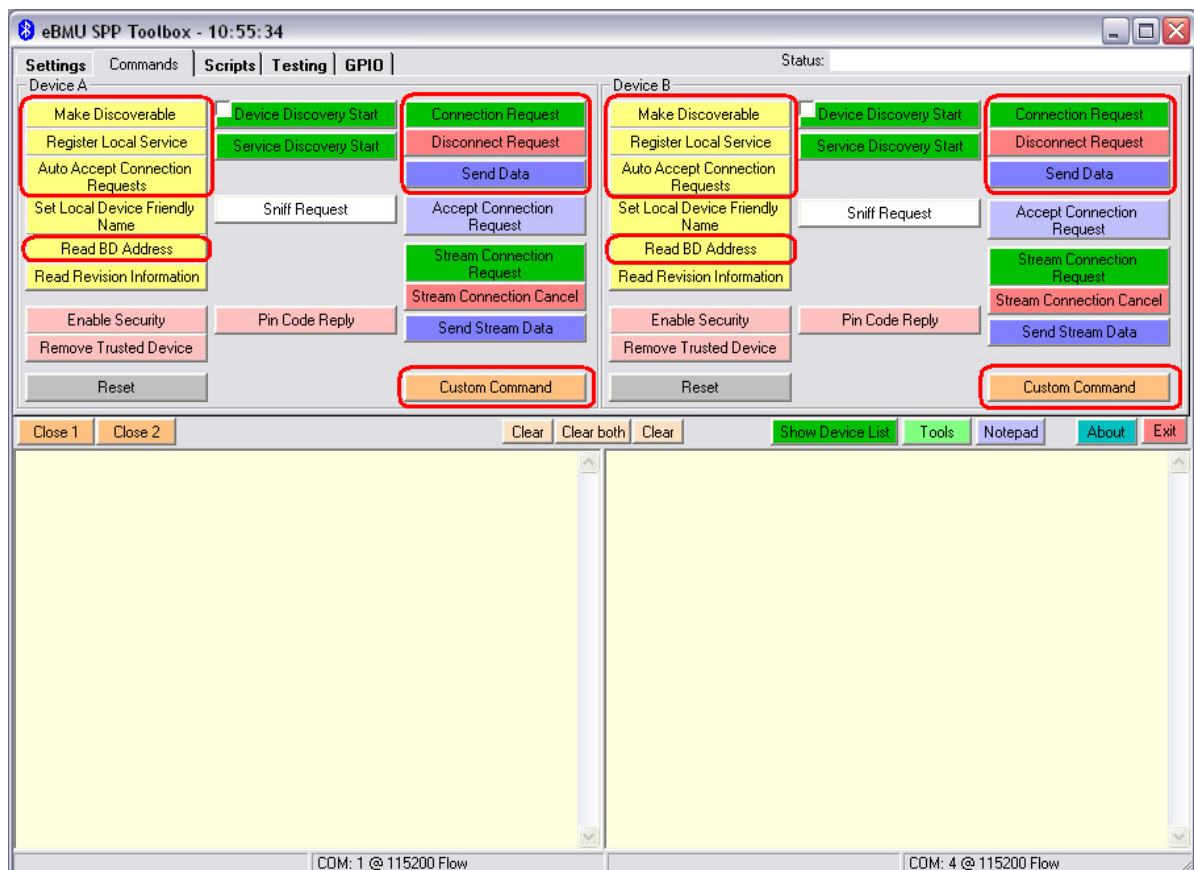

Figure 7 : Command tab and used commands

For simple data transfer find the needed commands marked in figure 5. The Custom Command button can be used to issue any command of the command set (refer to *PMB8753-2_SPP_AT_specification_R1.pdf*).

5.5 CREATING A CONNECTION

To send data from one EVB to the other one of them must be prepared for connection, while the other will request a connection. Follow these steps:

1. Click on *Make Discoverable* on Device A. Choose option 3: *Inquiry_Page Scan enabled*. The text field should state the issued command sent (→ arrow) and the OK response (← arrow). Now device A can be found by other devices by both available scan methods.
2. Click on *Register Local Service*. There are some options to change identification of the new service but the default values are ok. Simply choose *Send*. This service now can be found by other devices of the network.
3. Click the *Auto Accept Connection Requests* command and choose option 1. EVB A will auto accept connection requests from now on. Device A is now ready for connection!
4. Get the address of EVB A with the help of *Read BD Address*. In the text field you will find the desired information (e.g. “[...] <-- +RRBDRES=0003199E8B73, [...]”). With this Device A can be addressed when...
5. ...issuing *Connection Request* from **Device B**. Type or copy the BD address of Device A into the *BD Address 0x* text field. Name the *service channel* under which the service of Device A was registered in step 2. If no changes were in step 2 *service channel 01* should do. Click *send*. After a short while both Devices should state *connected*.
6. Done! Now data strings can be sent from one EVB to the other with the *Send Data* command. Data send and received will be displayed in the text fields. Another click on *Send Data* will close its dialog box.

Your text fields should look like Figure 6 or alike after step 1 to 5 were made. If problems or errors are encountered feel free to hardware reset (EVB push button) both boards and start over with step 1.

```

[10:02:22:113] --> AT+JDI5=3 -[Make Discoverable]
[10:02:22:144] <-- OK
[10:02:23:661] --> AT+JRL5=1101,11,Serial port,01,000000 -[Register Local Service]
[10:02:23:677] <-- OK
[10:02:25:225] --> AT+JAAC=1 -[Auto Accept Connection requests]
[10:02:25:225] <-- OK
[10:02:28:525] --> AT+JRB0 -[Read Bluetooth Device address]
[10:02:28:525] <-- +RRBDRES=0003199E8B73,038A -[BD-address and Osc_Trim]
[10:02:35:453] <-- +RCOI=0003199E8B72 -[Connection indication]
[10:02:35:453] <-- +RCCRCNF=256,0 -[Connected, MTU: 256]

[10:02:33:999] --> AT+JCCR=0003199E8B73,01 -[Create Connection Request]
[10:02:33:999] <-- OK
[10:02:35:485] <-- +RCCRCNF=256,0 -[Connected, MTU: 256]

```

Figure 8 : text field output from step 1 to 6

Quick Start Guide

Evaluation Board (EVB) PAN1311/21 USB

No. DS-PAN1311/21USB	REV. 1.1
PAGE 9 of 11	
DATE 15.09.2011	

6. SCHEMATIC

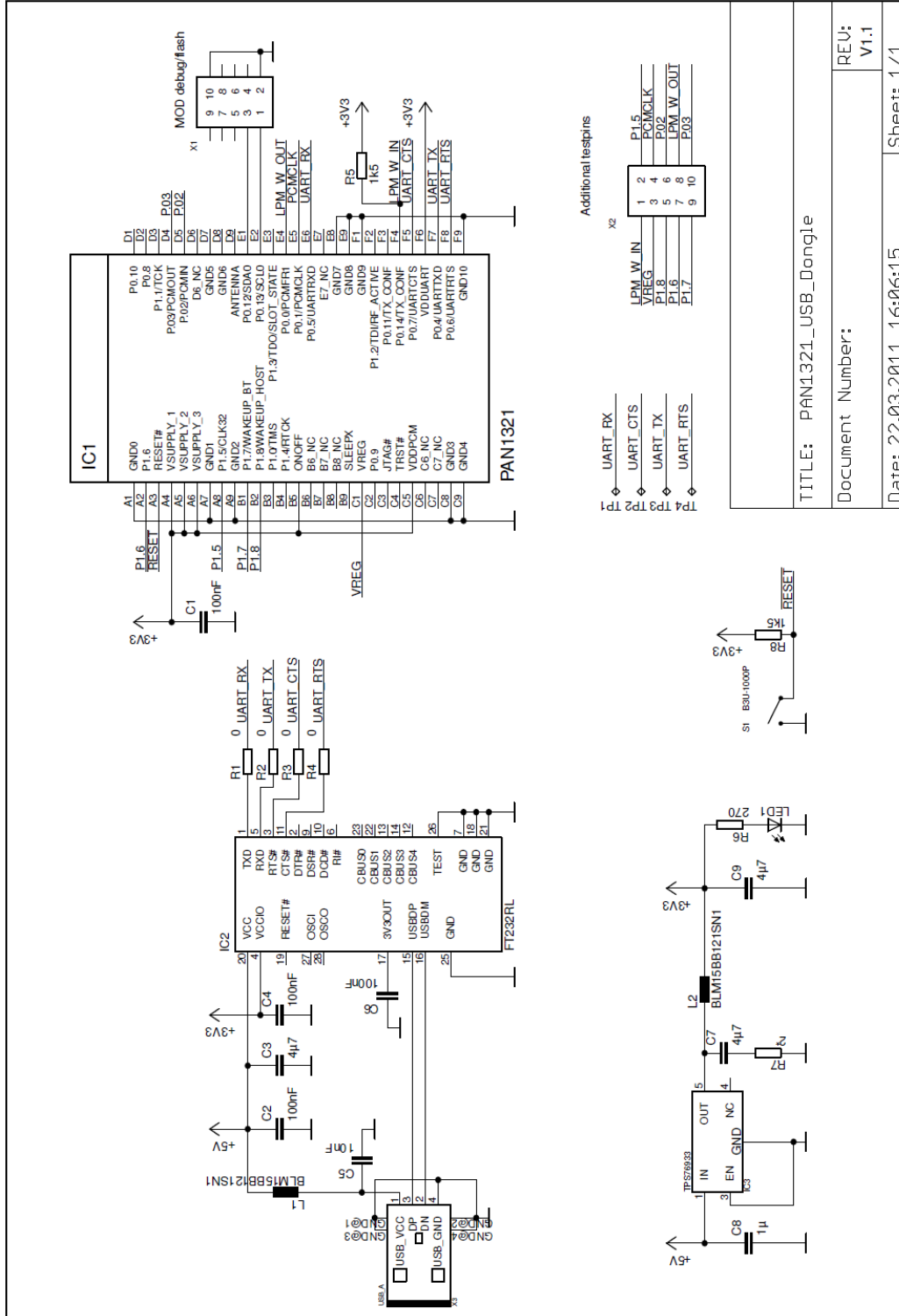

TITLE: PAN1321_USB_Dongle	REV: V1.1
Document Number:	Sheet: 1/1
Date: 22.03.2011 16:06:15	

Quick Start Guide
Evaluation Board (EVB) PAN1311/21 USB

No. DS-PAN1311/21USB	REV. 1.1
PAGE 10 of 11	
DATE 15.09.2011	

7. DOCUMENT INFORMATION

Revision Version	Date Datum	Modification / Remarks Änderungen / Bemerkungen
1.0	18.04.2011	Initial version
1.1	15.09.2011	Updated documentation information in chapter 2.1

Table 3 : Document version

Quick Start Guide Evaluation Board (EVB) PAN1311/21 USB	No. DS-PAN1311/21USB	REV. 1.1
	PAGE 11 of 11	
	DATE 15.09.2011	

8. GENERAL INFORMATION

© Panasonic Electronic Devices Europe GmbH 2011.

All rights reserved.

This product description does not lodge the claim to be complete and free of mistakes.

Please contact the related product manager in every case.

If we deliver samples to the customer, these samples have the status Engineering Samples. This means, the design of this product is not yet concluded. Engineering Samples may be partially or fully functional, and there may be differences to be published Data Sheet.

Engineering Samples are not qualified and are not to be used for reliability testing or series production.

8.1 WAIVER

Customer acknowledges that samples may deviate from the Data Sheet and may bear defects due to their status of development and the lack of qualification mentioned above.

Panasonic rejects any liability or product warranty for Engineering Samples. In particular, Panasonic waives liability for damages caused by

- the use of the Engineering Sample other than for Evaluation Purposes, particularly the installation or integration in an other product to be sold by Customer,
- deviation or lapse in function of Engineering Sample,
- improper use of Engineering Samples.

Panasonic waives any liability for consequential and incidental damages.

In case of any questions, please contact your local sales partner or the related product manager.

9. LIFE SUPPORT POLICY

This Panasonic product is not designed for use in life support appliances, devices, or systems where malfunction can reasonably be expected to result in a significant personal injury to the user, or as a critical component in any life support device or system whose failure to perform can be reasonably expected to cause the failure of the life support device or system, or to affect its safety or effectiveness. Panasonic customers using or selling these products for use in such applications do so at their own risk and agree to fully indemnify Panasonic for any damages resulting.

PANASONIC ELECTRONIC DEVICES EUROPE GmbH			DESIGNED Erstellt IW
---	--	--	----------------------------