



**550-510, 550-511, & 550-516**

## **QUICKSTART MANUAL SNIPER EFI INSTALLATION INSTRUCTIONS**

Congratulations on your purchase of a new Sniper EFI Throttle Body System built by craftsmen to exacting standards in our Bowling Green, Kentucky facility. Every Sniper EFI System is 100% tested before it leaves our facility for “bolt on and go” performance.

Should you experience any problems or need parts assistance that this quickstart manual or the complete installation manual does not address, please feel free to contact our technical service department at 1-866-464-6553 Monday through Friday, 8 a.m. to 5 p.m. CST or log on to [www.holley.com](http://www.holley.com) for a database of technical information and online support.

## INTRODUCTION & SYSTEM REQUIREMENTS

Holley Performance Products has written this manual for the installation of the **Sniper EFI** TBI fuel injection system. This manual contains the information necessary for the installation of the throttle body, wiring, sensors, and fuel system. It also contains all tuning information. Please read all the **WARNINGS** and **NOTES**, as they contain valuable information that can save you time and money. It is our intent to provide the best possible products for our customer; products that perform properly and satisfy your expectations.

### **Engine Requirements**

Before moving forward with the installation, please verify your vehicle meets the engine and fuel system requirements below:

- Engine is a naturally aspirated (no supercharger, turbocharger, etc.) V8
- Engine horsepower is between 250 – 650
- Engine has a 4 BBL, 4150 style square flange or universal flanged spread bore intake manifold\*
- Unleaded fuel only
- Any RTV silicone sealants used on the engine are sensor safe

\* Any square flange Holley type intake manifold will work. A spread bore intake manifold may work with no adapter as long as it is an aftermarket "universal flange" (meaning it has dual bolt patterns), and as long as it has enough material such that no vacuum leaks occur along the perimeter of the throttle body. If there is not enough material, a sealing plate (Weiand® PN 9006) can be used. Factory dual plane intakes will require an adapter (PN 17-6).

### **Fuel System Requirements**

The Sniper EFI system requires a high pressure fuel pump capable of operating at 60 psi. When selecting a pump, and lines, be sure each component is designed to perform at high pressure. Holley offers a variety of fuel pumps, hoses and accessories to complete your installation. For best results, Holley strongly recommends an in-tank pump. Installing the fuel pump in the tank results in quieter operation, less chance of cavitation and a reduction in pump temperature. If mounting the pump in the tank is not an option, install the pump as close as possible to the tank. Within 2-feet of sending unit is recommended.

The **550-510K** and **550-511K** fuel injection systems include the complete fuel system. The fuel system parts identification and instructions can be found in the Sniper EFI Reference Manual.

## TOOLS REQUIRED FOR INSTALLATION

- |   |   |   |
|---|---|---|
| <ul style="list-style-type: none"><li>• Standard Wrench Set</li><li>• Medium Blade Screwdriver</li><li>• Drill and Assorted Bit Sizes</li><li>• Factory Service Manual for your vehicle</li></ul> | <ul style="list-style-type: none"><li>• Small Blade Screwdriver</li><li>• #2 Phillips Screwdriver</li><li>• Hole Saw (2") (depending on ECU location)</li><li>• 7/8" Drill Bit (step-bit recommended)</li></ul> | <ul style="list-style-type: none"><li>• Allen Wrench Set</li><li>• Digital Voltmeter</li><li>• Terminal Crimping Tool</li></ul> |
|---|---|---|

An assistant is necessary for some installation and adjustment procedures and should be present for safety reasons.

**WARNING! Disconnect battery before proceeding with any installation.**

# Sniper EFI Wiring Harness Overview

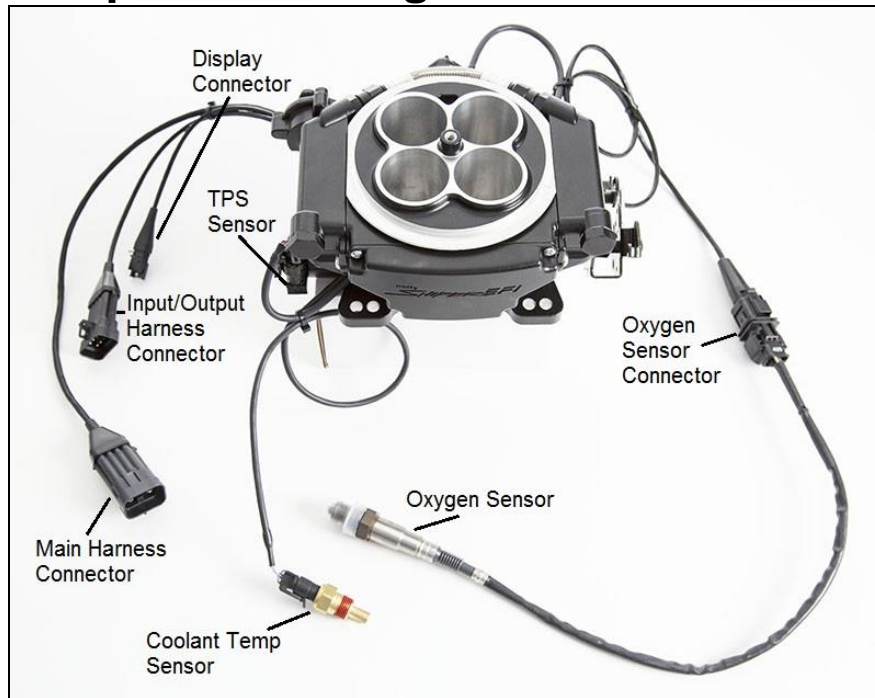

## **Before you get started – Are you experiencing any underlying problem?**

Holley Performance highly recommends the following items be checked and/or corrected prior to installation of your new Sniper EFI system to ensure optimum performance from your engine.

Many times a carburetor is looked at as the prime culprit or the main cause for a myriad of other engine-related difficulties that might exist. Therefore, it's best to check and verify the condition of the complete engine system before proceeding with an EFI Conversion. There should be no ***vacuum leaks, the ignition timing should be properly set, and the engine should be in sound mechanical condition.*** Converting to EFI won't cure bad valves, damaged head gaskets, worn piston rings, or cracked and leaking vacuum lines.

## **INSTALLATION:**

**NOTE:** Please see the enclosed instruction manual for complete removal, installation, and tuning instructions.

**NOTE:** This Quickstart Manual covers **NON-Timing Control Ignition Options**. We highly recommend first starting the engine with one of the two NON-Timing Control Ignition types shown in step 8 for your first start-up!

**Before beginning the Sniper EFI installation, we recommend that you locate a CLEAN Switched 12v Ignition source. This source needs to have 12v while cranking, and with the key in the run position. Label this source now, as you will need to use it for Step 9. Do NOT Connect the switch 12v wire to a source such as the ignition coil, or starter solenoid.**

**WARNING – Disconnect the NEGATIVE battery cable before any work is performed to the vehicle.**

1. Start by labeling all vacuum lines for easy identification. If any lines appear damaged, now is the time to replace them. Next, remove the carburetor, clean the gasket mating surface, and install the provided intake flange gasket on the intake manifold.
2. Place the Sniper EFI throttle body on top of the new flange gasket on the manifold. Install the hold down nuts and snug down progressively in a "criss-cross" pattern (60-80 in./lbs.). Depending on your application, this is also the time to install your throttle bracket and transmission kickdown brackets provided with your Sniper EFI Kit. You may be able to re-use the stock style throttle stud or transmission studs from your carburetor. If not, we have provided several universal throttle ball/stud options.

### Throttle Linkage/Bracket Side View

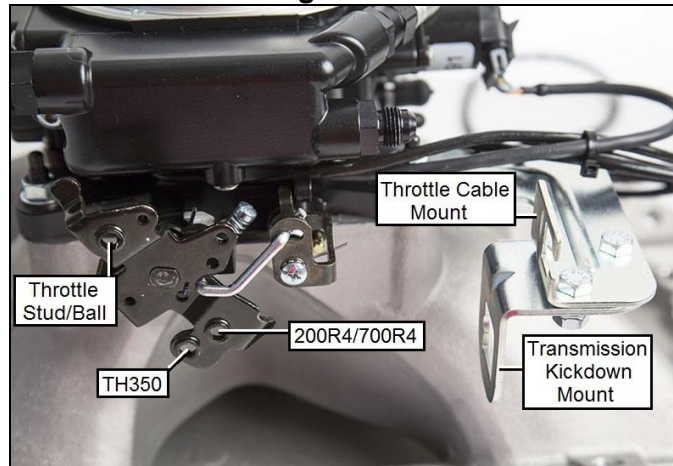

3. Reconnect the throttle and transmission kick-down linkage. Be sure to check for any binding conditions and correct before proceeding.
4. Install the **Coolant Temperature Sensor** into a 3/8" NPT coolant passage in either the intake manifold or cylinder head. Do not overtighten or damage to the cylinder head or intake may occur. It is best to drain the some of the coolant before the sensor is installed. Use thread sealer or a small amount of thread tape. Do not install the sensor in the thermostat housing, or in an area that will not see a constant flow of coolant.
5. Reconnect the appropriate vacuum hoses to the Sniper EFI throttle body. **Be sure to plug any vacuum sources not used.**

### Vacuum Port Side View

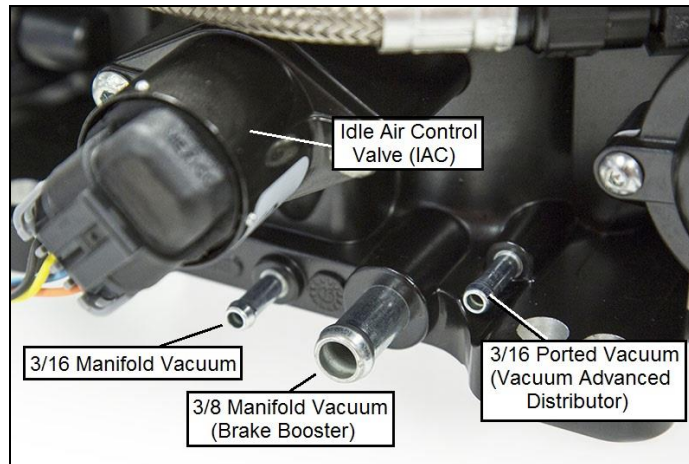

6. Connect fuel feed and return hose. The fuel inlets can be used in any configuration, however it is mandatory that the fuel outlet/return comes from the fuel pressure regulator, marked in **Fuel Fitting Overviews** below. Only one of the three fuel inlets **must** be used. If you would like to "Dual Feed" fuel to each fuel rail, that is acceptable also. The Sniper EFI System comes with a built in fuel pressure regulator, factory set at 58.5psi. We recommend at least a 3/8" feed line and 5/16" return line. Refer to the Sniper EFI Reference Manual for a detailed fuel system installation guide.

### Fuel Fitting Overviews

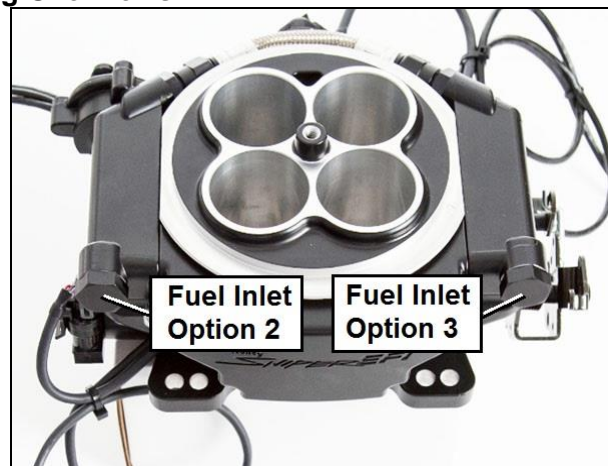
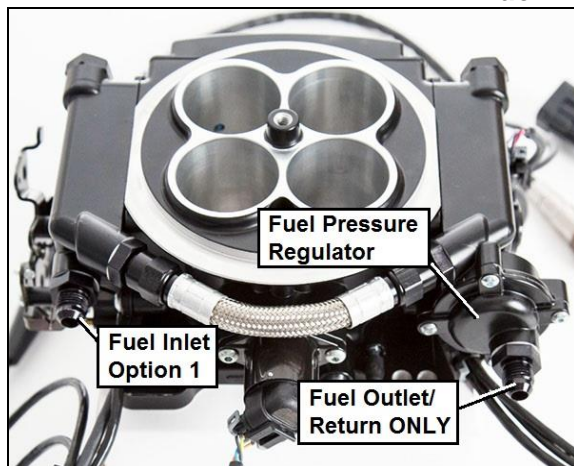

7. Locate a position for the oxygen sensor as close to the engine as possible. The oxygen sensor should be mounted at a point where it can read a good average of all the cylinders on one bank. This would be slightly after all the cylinders merge. If you have long tube headers, mount the sensor approximately 1-10" after the collector. You must have at least 18" of exhaust pipe after the sensor.
8. If your vehicle has catalytic converters, the oxygen sensor MUST be located between the engine and the catalytic converters. It is also CRITICAL that the oxygen sensor is NOT installed in the bottom of the exhaust tube. This will help prevent condensation in the exhaust tubing from entering the sensor. The clamp-on kit installation requires a 3/4 hole to be drilled in the exhaust system. Refer to main installation manual for more details.

**Oxygen Sensor Bung**



**Clamp-On Oxygen Sensor Bung**

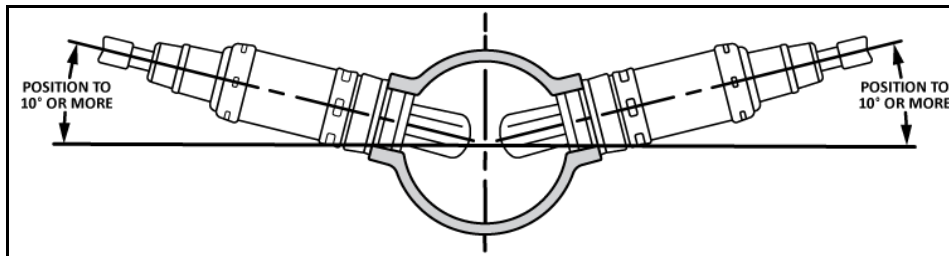

**WARNING! Only use ONE of the following Ignition Installation Options. NEVER connect the Purple wire to the Ignition Coil!**

9. **Option 1. Coil (-) Ignition** - Locate the YELLOW wire on the Main Harness, this wire will be labeled Coil (-) Input. This wire can either go to the NEGATIVE side of your ignition coil, or to "Tach" label on a GM Large Cap HEI distributor w/ internal coil. **NEVER** run the YELLOW wire to the negative side of a coil while using a CD Ignition box.

## *Ignition Option 1*

**Canister Style Coil**

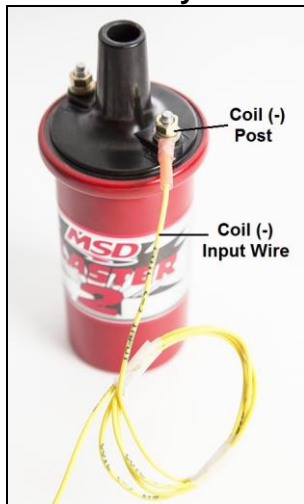

**GM Large Cap HEI w/ Internal Coil**

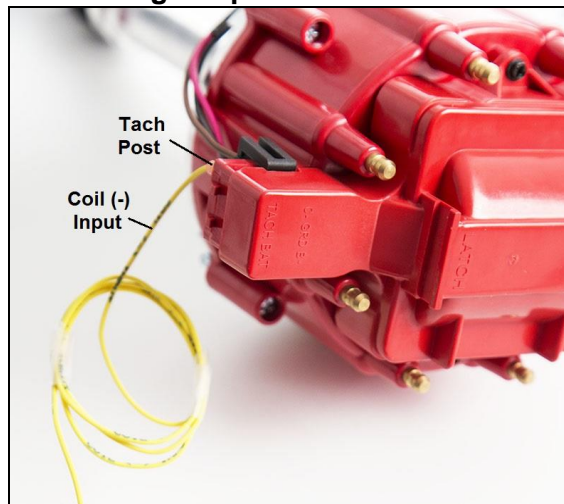

**OR**

## **Ignition Option 2**

10. **Option 2. Capacitive Discharge Ignition – “C/D Box”** - Locate the small 1 wire ignition adapter. It has a single PURPLE wire attached to a 2 pin connector (shown below). Connect this wire to the distributor connector on the main harness. The PURPLE wires should plug into each other – the GREEN wire will be unused. The loose end of the PURPLE wire will then be terminated to the tach output wire on the C/D Box. On an MSD 6AL (shown below) this wire is GREY. Refer to the ignition box instructions for more information on the tach output wiring. If using this step, **NEVER connect the PURPLE wire to the ignition coil!**

**C/D Box w/ Tach Adapter to Main Harness**

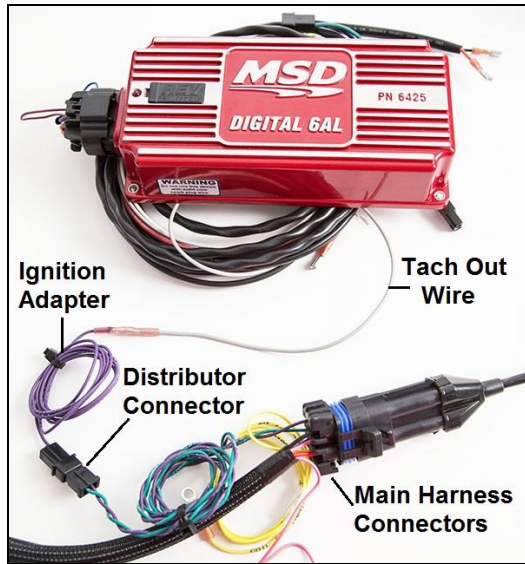

**Main Harness Overview**

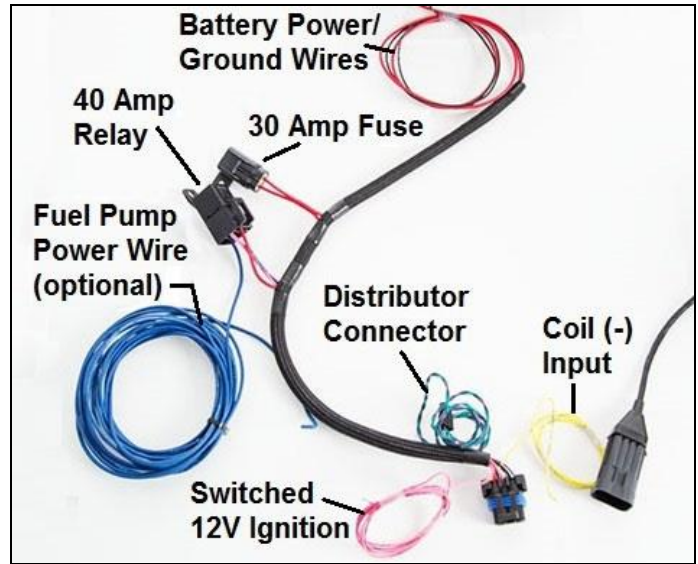

11. The PINK wire labeled “Switched Ignition” needs to be terminated to the ignition source found and labeled from page 1. We STRONGLY recommend that you do not stack this wire with other switched 12v accessories. This wire needs to be isolated on its own individual switched 12v power source. Failure to do this may result in a “no start” condition.
12. Connect the 3.5” Sniper EFI Handheld to the main harness. This is a simple plug and play connection. If you are going to permanently leave the handheld in the vehicle, you will need to find a factory grommet in your firewall to pass the Display CAN bus connector through. If no factory grommets can be utilized we recommend installing one.

**Sniper EFI 3.5” Touchscreen LCD Display**

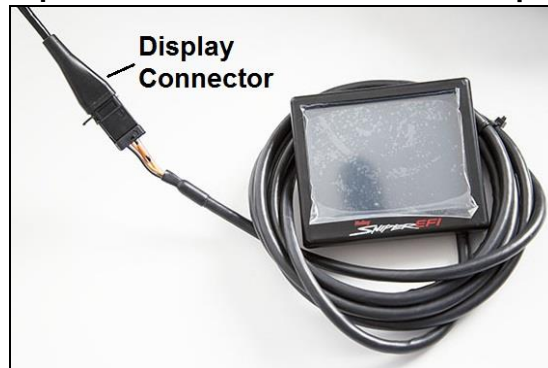

13. At this point you are ready to install the battery power and ground cables, these wires must go **DIRECTLY** to the physical battery terminals.

**Battery connections MUST physically go the battery!**

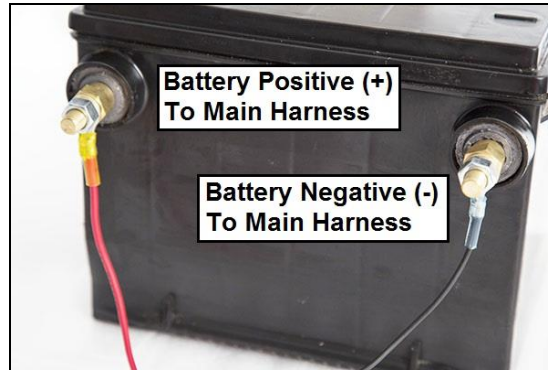

**ADDITIONAL INPUTS AND OUTPUTS**

The following tables outline the functions of each wire on the Sniper harnesses. For detailed information, please see referenced sections of the Sniper EFI Reference Manual included with your kit.

**7 Pin Connector**

Color	Labeled Name	Function
Red	Battery Positive (+)	Connects directly to battery positive terminal
Black	Battery Negative (-)	Connects directly to battery negative terminal
Blue	Fuel Pump Output (+)	+12v Fuel Pump Supply from Relay
Violet	Crank Signal Positive (+)	Engine Speed Signal Input (see Ignition Wiring Section)
Dark Green	Crank Signal Negative (-)	Engine Speed Signal Ground (see Ignition Wiring section)
Yellow	Coil (-) Input	Engine Speed Input (see Ignition Wiring section)
Pink	Switched Ignition (+12v)	<b>NOTE: must remain powered during cranking</b>

**10 Pin Connector** – 8 wires are populated. This connector contains:

Color	Labeled Name	Function
Orange	Input #1 (-)	Optional - Connect to a ground triggered A/C relay
Yellow	Input #2 (-)	Optional - Connect to a programmable ground input
Light Blue	Output #1 (-)	Optional – Connect to Fan #1 relay ground trigger
Light Green	Output #2 (-)	Optional – Connect to Fan #2 relay ground trigger
White	Points Output	Used to trigger a CD ignition box or the included Coil Driver Module
Grey	Output #6 (-)	Optional – Connect to ground side trigger of A/C shutdown relay
Dark Brown	Tach Output	Used to drive an aftermarket tachometer
Tan	Digital Gauge Output	Used to drive Holley EFI analog gauges via 554-130 Gauge Module

**INITIAL POWER-UP AND WIZARD**

Turn the ignition key to the “run” position. This should apply power to the ECU as well as the Sniper EFI Handheld control module. The handheld should power up and the Home Screen (**figure below**) should appear.







The Home screen contains icons which will navigate to different functional features of the 3.5 Touch Screen. These features will be discussed in detail throughout the main manual.





## It is now time to begin the Calibration Wizard!

**NOTE:** DO NOT ATTEMPT TO START THE VEHICLE UNTIL YOU ARE TOLD TO DO SO IN THE INSTRUCTIONS BELOW.

**NOTE:** The handheld has a SD memory card installed in the side. This card contains specific information that is required for the use of the Sniper EFI product. DO NOT replace this card with another. There should be no need to remove this card for normal use.

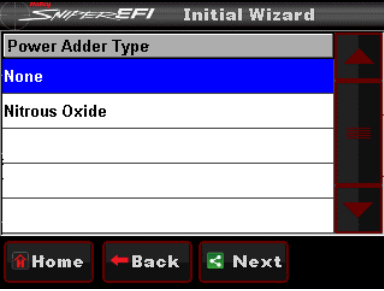
<b>STEP 1</b>	Select <b>WIZARD</b> from the main menu
<b>STEP 2</b>	 <p>Select your Sniper system type</p>
<b>STEP 3</b>	 <p>Select the number of cylinders your engine has</p>
<b>STEP 4</b>	 <p>Use the slider bar to input the displacement of your engine</p>
<b>STEP 5</b>	 <p>Use the slider bar to set your desired HOT idle speed. This is the RPM the Sniper will target at coolant temperatures above 160 °F</p>
<b>STEP 6</b>	 <p>Select your camshaft type:</p> <ul style="list-style-type: none"><li>• Stock/Mild = This selection will work well on most applications equipped with stock or “street performance” camshafts. Choose Stock/Mild if you are unsure of your camshaft specs</li><li>• Street/Strip = Select this if your engine has between 8” and 13” of manifold vacuum</li><li>• Race = Select this if your engine has less than 7” of manifold vacuum. Race oriented camshafts may require laptop tuning for optimal idle stability</li></ul>

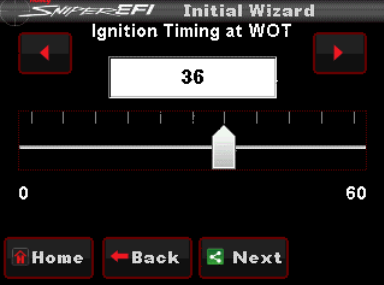

<p><b>STEP 7</b></p>		<p>Select Power Adder Type</p> <p>*550-510 &amp; 550-511 Sniper kits support the use of Wet Nitrous without the need for laptop tuning.</p>
<p><b>STEP 8</b></p>		<p>Select your ignition type:</p> <ul style="list-style-type: none"> <li>• Coil (-) [no timing control] <i>Skip to Step 11</i></li> <li>• CD Ignition Box [no timing control] <i>Skip to Step 11</i></li> <li>• Magnetic [timing control optional] <i>Proceed to Step 9</i></li> <li>• Holley Dual Sync [timing control optional] <i>Proceed to Step 9</i></li> </ul>
<p><b>STEP 9</b></p>		<p>Choose whether your Sniper will control engine timing. For more details on this feature, refer to the Ignition Wiring Section of the Reference Manual</p> <ul style="list-style-type: none"> <li>• Yes <i>Proceed to Step 10</i></li> <li>• No <i>Skip to Step 11</i></li> </ul> <p><b>Note: We highly recommend first starting the engine with one of the two NON-Timing Control Ignition types shown in step 8 for your first start-up!</b></p>
<p><b>STEP 10</b></p>		<p>Use the slider bar to set your desired ignition timing at Wide Open Throttle (WOT)</p>
<p><b>STEP 11</b></p>		<p>After answering all questions in the Wizard, your calibration will be created. Press the “Start” button to send the calibration to the ECU. Once this process is completed, you will see a screen indicating the file has been uploaded.</p>

## SENSOR VERIFICATION

Before starting the vehicle, verify that all of the sensors are reading properly. To do this, turn the key off, and cycle it back on. You should hear the fuel pump come on and run for 5 seconds.

**Note: This is a great time to check for fuel leaks!**

On the HOME SCREEN, select the MONITOR icon, then select the “Monitors” screen. You will see an icon named “Initial Startup”. Select this. With the key on and the engine off, these sensors should read as follows:

- **Engine RPM** – This gauge should show “Stall!”, once you begin cranking the engine it will show actual engine RPM
- **TPS** (Throttle Position Sensor) – Should read 0. Slowly depress the throttle to wide open. It should read between 85 and 100% at wide open throttle. If it does not, please verify your throttle linkage is allowing full travel of the throttle arm.
- **MAP** (Manifold Air Pressure Sensor) – Should read from 95-102. At high elevations it could read as low as 75.
- **CTS** (Coolant Temperature Sensor) – reads engine temperature.
- **IAC Position** – See Idle Setting/Throttle Plate Setting section in this manual.
- **Battery** – Will read battery voltage. Should be 12.0 volts minimum.

If ANY of these sensors are not reading properly, it must be resolved before the engine is started.

## STARTUP

With the handled still on the “Initial Startup” screen, crank the engine and look at the RPM parameter. It should change to “Syncng”, indicating the ECU is syncing with the RPM signal for an instant, then show an RPM signal. The engine should fire and run and come to an idle.

If you do not get an RPM signal, there is an error in the wiring or system setup. Call Holley Tech service for advice.

If the engine starts but is idling too low and appears to be struggling for air, you may have to open the throttle body idle speed screw at this time.

**Fuel Prime occurs 2.5 seconds after key-on (which is also the amount of time it takes for the 3.5” touch screen to load). If you quickly turn the ignition key without waiting for the full 2.5 seconds, the prime will not occur and it may take longer for the engine to start.**

**Caution! Multiple key cycles without firing the engine could potentially cause a flooded condition**

## AFTER-STARTUP

Once the vehicle has started, look for any fuel or coolant leaks. Let the vehicle warm up and look at some other parameters to make everything is operating properly. Go into the MONITOR, MULTI GAUGE, and select the “AIR/FUEL RATIO” icon.

- **Closed Loop Status** – Indicates whether the engine is “Closed Loop” or “Open Loop”. Closed Loop indicates that the ECU is adding or subtracting fuel to maintain the target air/fuel ratio. The Sniper EFI calibrations are such that the system should be operating closed loop almost all of the time.
- **CL Comp** – This is the percentage of fuel that the ECU is adding or subtracting to maintain the target air/fuel ratio at any specific moment. A value with a minus (-) sign in front indicates the ECU is removing fuel. A value with no minus sign indicates the ECU is adding fuel. When in open loop operation, this will always stay at 0%.
- **Target Air/Fuel Ratio** – This is the target AFR (air/fuel ratio) the ECU is trying to maintain. This will vary depending on the engine speed and load.
- **AFR, A/F** – This will show the air/fuel ratio the wideband oxygen sensor is reading. The Closed Loop Compensation should be adding or subtracting fuel all the time such that the AFR Left should always be close to the Target AFR value.
- **Fuel Learn Status** – This indicates the status of the Sniper EFI “Self Tuning” operation (Learn Status). The system will automatically tune itself as you drive around. There are several conditions that must occur in order for the Self Tuning to occur. The engine temperature must exceed 160° F. The system must be operating in a closed loop mode, and the Self Tuning must be enabled. The base Sniper EFI setups have the Self Tuning enabled. Once the engine reaches 160° F, the Self Tuning should be active. The Learn Stat will show “NoLearn” when Self Tuning is not active and “Learn” if Self-tuning is active.

If any of these parameters are not showing a proper value, find out why before further driving the vehicle.

## ***IDLE SETTING/THROTTLE PLATE SETTING***

Once the engine is up to operating temperature, the idle speed can be set to what was configured in the Wizard. To do this, open up the Initial Startup gauge screen that was used in section 17.0. With the vehicle in neutral, adjust the idle screw until the IAC Position reads between 2 and 10%. While adjusting the screw if the TPS position reads begins to read higher than 0% cycling the ignition switch will recalibrate the TPS back to zero.

NOTE: Do not attempt to set the target idle speed and IAC position until the engine is above 160°F!

## ***FIRST DRIVE***

Congratulations on a successful installation of your Sniper EFI system!

Next, you need to simply drive your car and let the Sniper's self-tuning occur. It is best to drive in an area without much traffic where you can drive under different conditions.

It's always a good idea to have a passenger present to look at things like coolant temperatures, battery voltage, etc, on the first drive.

Start the car and let it idle. Let the car get up to operating temperature (coolant temperature over 160 degrees F) so that the self-tuning can occur. If you'd like, have a passenger look at the handheld display and look at the "CI Comp" value. Once this value is close to zero, the self-tuning process has been completed in that engine operating area. Next, put the car into gear if it's an automatic and let it run there. If the vehicle has air conditioning, you can turn it on, which will put the engine in a different tuning area as well.

Next, slowly accelerate from a stop. If the transmission is a manual, do some slow clutch engagements away from a stop. Then cruise the vehicle at a steady speed, varying the speeds after a few minutes of steady driving. You can also drive in different gears. What you are trying to do is run the vehicle at different engine speed and loads.

After driving under various driving conditions, you can perform some harder acceleration runs including WOT runs.

After this, the Sniper EFI will have performed most of the self-tuning needed to occur.

Just performing routine driving will accomplish this process. After the engine is up and running minor tuning refinements can be performed to optimize fuel economy and power.

# SYSTEM INSTALLATION OVERVIEW

