

# R&S®FSV-K10x (LTE Downlink) LTE Downlink Measurement Application User Manual



1176766102

This manual describes the following firmware applications:

- R&S®FSV-K100 EUTRA / LTE FDD Downlink Measurement Application (1308.9006.02)
- R&S®FSV-K102 EUTRA / LTE MIMO Downlink Measurement Application (1309.9000.02)
- R&S®FSV-K104 EUTRA / LTE TDD Downlink Measurement Application (1309.9422.02)

This manual describes the following R&S FSV/FSVA models with firmware version 3.30 and higher:

- R&S®FSVA4 (1321.3008K05)
- R&S®FSVA7 (1321.3008K08)
- R&S®FSVA13 (1321.3008K14)
- R&S®FSVA30 (1321.3008K31)
- R&S®FSVA40 (1321.3008K41)
- R&S®FSV4 (1321.3008K04)
- R&S®FSV7 (1321.3008K07)
- R&S®FSV13 (1321.3008K13)
- R&S®FSV30 (1321.3008K30)
- R&S®FSV40 (1321.3008K39/1321.3008K40)

It also applies to the following R&S®FSV models. However, note the differences described in [Chapter 1.4, "Notes for Users of R&S FSV 1307.9002Kxx Models"](#), on page 13.

- R&S®FSV3 (1307.9002K03)
- R&S®FSV7 (1307.9002K07)
- R&S®FSV13 (1307.9002K13)
- R&S®FSV30 (1307.9002K30)
- R&S®FSV40 (1307.9002K39/1307.9002K40)

© 2019 Rohde & Schwarz GmbH & Co. KG

Mühlhofstr. 15, 81671 München, Germany

Phone: +49 89 41 29 - 0

Fax: +49 89 41 29 12 164

Email: [info@rohde-schwarz.com](mailto:info@rohde-schwarz.com)

Internet: [www.rohde-schwarz.com](http://www.rohde-schwarz.com)

Subject to change – Data without tolerance limits is not binding.

R&S® is a registered trademark of Rohde & Schwarz GmbH & Co. KG.

Trade names are trademarks of the owners.

1176.7661.02 | Version 06 | R&S®FSV-K10x (LTE Downlink)

The following abbreviations are used throughout this manual: R&S®FSV/FSVA is abbreviated as R&S FSV/FSVA.

# Contents

<b>1</b>	<b>Preface</b> .....	<b>9</b>
<b>1.1</b>	<b>Documentation Overview</b> .....	<b>9</b>
1.1.1	Quick Start Guide.....	9
1.1.2	Operating Manuals and Help.....	9
1.1.3	Service Manual.....	9
1.1.4	Instrument Security Procedures.....	10
1.1.5	Basic Safety Instructions.....	10
1.1.6	Data Sheets and Brochures.....	10
1.1.7	Release Notes and Open Source Acknowledgment (OSA).....	10
1.1.8	Application Notes, Application Cards, White Papers, etc.....	10
<b>1.2</b>	<b>Conventions Used in the Documentation</b> .....	<b>10</b>
1.2.1	Typographical Conventions.....	10
1.2.2	Conventions for Procedure Descriptions.....	11
1.2.3	Notes on Screenshots.....	11
<b>1.3</b>	<b>How to Use the Help System</b> .....	<b>11</b>
<b>1.4</b>	<b>Notes for Users of R&amp;S FSV 1307.9002Kxx Models</b> .....	<b>13</b>
<b>2</b>	<b>Introduction</b> .....	<b>14</b>
<b>2.1</b>	<b>Requirements for UMTS Long-Term Evolution</b> .....	<b>14</b>
<b>2.2</b>	<b>Long-Term Evolution Downlink Transmission Scheme</b> .....	<b>16</b>
2.2.1	OFDMA.....	16
2.2.2	OFDMA Parameterization.....	17
2.2.3	Downlink Data Transmission.....	19
2.2.4	Downlink Reference Signal Structure and Cell Search.....	19
2.2.5	Downlink Physical Layer Procedures.....	21
<b>2.3</b>	<b>References</b> .....	<b>21</b>
<b>3</b>	<b>Welcome</b> .....	<b>23</b>
<b>3.1</b>	<b>Installing the Software</b> .....	<b>23</b>
<b>3.2</b>	<b>Application Overview</b> .....	<b>23</b>
<b>3.3</b>	<b>Support</b> .....	<b>25</b>
<b>4</b>	<b>Measurement Basics</b> .....	<b>26</b>

<b>4.1</b>	<b>Symbols and Variables</b>	<b>26</b>
<b>4.2</b>	<b>Overview</b>	<b>27</b>
<b>4.3</b>	<b>The LTE Downlink Analysis Measurement Application</b>	<b>27</b>
4.3.1	Synchronization	27
4.3.2	Channel Estimation and Equalization	29
4.3.3	Analysis	29
<b>4.4</b>	<b>Performing Time Alignment Measurements</b>	<b>30</b>
<b>4.5</b>	<b>Performing Transmit On/Off Power Measurements</b>	<b>32</b>
<b>5</b>	<b>Measurements and Result Displays</b>	<b>35</b>
<b>5.1</b>	<b>Numerical Results</b>	<b>35</b>
<b>5.2</b>	<b>Measuring the Power Over Time</b>	<b>38</b>
<b>5.3</b>	<b>Measuring the Error Vector Magnitude (EVM)</b>	<b>42</b>
<b>5.4</b>	<b>Measuring the Spectrum</b>	<b>46</b>
5.4.1	Frequency Sweep Measurements	46
5.4.2	I/Q Measurements	50
<b>5.5</b>	<b>Measuring the Symbol Constellation</b>	<b>53</b>
<b>5.6</b>	<b>Measuring Statistics</b>	<b>54</b>
<b>5.7</b>	<b>3GPP Test Scenarios</b>	<b>56</b>
<b>6</b>	<b>Configuring and Performing the Measurement</b>	<b>59</b>
<b>6.1</b>	<b>Performing Measurements</b>	<b>59</b>
<b>6.2</b>	<b>Defining General Measurement Characteristics</b>	<b>60</b>
6.2.1	Defining Signal Characteristics	61
6.2.2	Configuring the Input Level	62
6.2.3	Configuring the Data Capture	64
6.2.4	Configuring On/Off Power Measurements	65
6.2.5	Triggering Measurements	66
<b>6.3</b>	<b>Configuring MIMO Setups</b>	<b>67</b>
<b>6.4</b>	<b>Configuring Spectrum Measurements</b>	<b>68</b>
6.4.1	General ACLR and SEM Configuration	69
6.4.2	Configuring SEM Measurements	69
6.4.3	Configuring ACLR Measurements	71
<b>6.5</b>	<b>Defining Advanced Measurement Characteristics</b>	<b>72</b>
6.5.1	Controlling I/Q Data	73

6.5.2	Controlling the Input.....	73
6.5.3	Configuring the Digital I/Q Input.....	74
<b>6.6</b>	<b>Configuring the Signal Demodulation.....</b>	<b>75</b>
6.6.1	Configuring the Data Analysis.....	75
6.6.2	Compensating Measurement Errors.....	78
6.6.3	Configuring MIMO Setups.....	79
<b>6.7</b>	<b>Configuring Downlink Frames.....</b>	<b>80</b>
6.7.1	Configuring TDD Signals.....	80
6.7.2	Configuring the Physical Layer Cell Identity.....	81
6.7.3	PDSCH Subframe Configuration.....	82
<b>6.8</b>	<b>Defining Advanced Signal Characteristics.....</b>	<b>85</b>
6.8.1	Defining the PDSCH Resource Block Symbol Offset.....	85
6.8.2	Configuring the Reference Signal.....	86
6.8.3	Configuring the Synchronization Signal.....	86
6.8.4	Configuring the Control Channels.....	87
6.8.5	Configuring the Shared Channel.....	91
<b>7</b>	<b>Analysis.....</b>	<b>93</b>
7.1	Signal Part Selection.....	93
7.2	Measurement Units.....	94
7.3	Miscellaneous Analysis.....	94
7.4	Constellation Diagram Filter.....	95
7.5	Y-Axis Scale.....	96
7.6	Markers.....	96
<b>8</b>	<b>File Management.....</b>	<b>99</b>
8.1	File Manager.....	99
8.2	SAVE/RECALL Key.....	100
8.3	Test Models.....	100
<b>9</b>	<b>Remote Commands.....</b>	<b>102</b>
9.1	Common Suffixes.....	102
9.2	Introduction.....	103
9.2.1	Conventions used in Descriptions.....	103
9.2.2	Long and Short Form.....	104

9.2.3	Numeric Suffixes.....	104
9.2.4	Optional Keywords.....	104
9.2.5	Alternative Keywords.....	105
9.2.6	SCPI Parameters.....	105
<b>9.3</b>	<b>General Configuration.....</b>	<b>107</b>
<b>9.4</b>	<b>Measurement Control.....</b>	<b>111</b>
<b>9.5</b>	<b>Numeric Result Query.....</b>	<b>113</b>
<b>9.6</b>	<b>Measurement Result Query.....</b>	<b>122</b>
9.6.1	Using the TRACe[:DATA] Command.....	122
9.6.2	Reading Results.....	133
<b>9.7</b>	<b>General Settings.....</b>	<b>137</b>
9.7.1	Defining Signal Characteristics.....	137
9.7.2	Configuring the Input Level.....	139
9.7.3	Configuring the Data Capture.....	142
9.7.4	Configuring On/Off Power Measurements.....	144
<b>9.8</b>	<b>MIMO Setups.....</b>	<b>144</b>
<b>9.9</b>	<b>Advanced Settings.....</b>	<b>145</b>
9.9.1	Controlling I/Q Data.....	145
9.9.2	Controlling the Input.....	146
9.9.3	Configuring the Digital I/Q Input.....	147
<b>9.10</b>	<b>Trigger Configuration.....</b>	<b>148</b>
<b>9.11</b>	<b>Spectrum Measurements.....</b>	<b>151</b>
<b>9.12</b>	<b>Signal Demodulation.....</b>	<b>156</b>
9.12.1	Configuring the Data Analysis.....	156
9.12.2	Compensating Measurement Errors.....	159
9.12.3	Configuring MIMO Setups.....	160
<b>9.13</b>	<b>Frame Configuration.....</b>	<b>160</b>
9.13.1	Configuring TDD Signals.....	160
9.13.2	Configuring the Physical Layer Cell Identity.....	161
9.13.3	Configuring PDSCH Subframes.....	163
<b>9.14</b>	<b>Advanced Signal Characteristics.....</b>	<b>166</b>
9.14.1	Defining the PDSCH Resource Block Symbol Offset.....	166
9.14.2	Configuring the Reference Signal.....	166

9.14.3	Configuring the Synchronization Signal.....	167
9.14.4	Configuring the Control Channel.....	168
9.14.5	Configuring the Shared Channel.....	172
<b>9.15</b>	<b>Measurement Result Analysis.....</b>	<b>173</b>
9.15.1	Selecting Displayed Data.....	173
9.15.2	Selecting Units.....	175
9.15.3	Using Markers.....	176
9.15.4	Using Delta Markers.....	178
9.15.5	Scaling the Vertical Diagram Axis.....	181
	<b>List of Commands.....</b>	<b>183</b>
	<b>Index.....</b>	<b>187</b>





# 1 Preface

## 1.1 Documentation Overview

This section provides an overview of the R&S FSVA/FSV user documentation. Unless specified otherwise, you find the documents on the R&S FSVA/FSV product page at:

[www.rohde-schwarz.com/manual/FSVA](http://www.rohde-schwarz.com/manual/FSVA)

### 1.1.1 Quick Start Guide

Introduces the R&S FSVA/FSV and describes how to set up and start working with the product. Includes basic operations, typical measurement examples, and general information, e.g. safety instructions, etc. A printed version is delivered with the instrument. A PDF version is available for download on the Internet.

### 1.1.2 Operating Manuals and Help

Separate operating manuals are provided for the base unit and the firmware applications:

- Base unit manual  
Contains the description of all instrument modes and functions. It also provides an introduction to remote control, a complete description of the remote control commands with programming examples, and information on maintenance, instrument interfaces and error messages. Includes the contents of the getting started manual.
- Firmware application manual  
Contains the description of the specific functions of a firmware application. Basic information on operating the R&S FSVA/FSV is not included.

The contents of the operating manuals are available as help in the R&S FSVA/FSV. The help offers quick, context-sensitive access to the complete information for the base unit and the firmware applications.

All operating manuals are also available for download or for immediate display on the Internet.

### 1.1.3 Service Manual

Describes the performance test for checking the rated specifications, module replacement and repair, firmware update, troubleshooting and fault elimination, and contains mechanical drawings and spare part lists.

The service manual is available for registered users on the global Rohde & Schwarz information system (GLORIS, <https://gloris.rohde-schwarz.com>).

### 1.1.4 Instrument Security Procedures

Deals with security issues when working with the R&S FSVA/FSV in secure areas. It is available for download on the Internet.

### 1.1.5 Basic Safety Instructions

Contains safety instructions, operating conditions and further important information. The printed document is delivered with the instrument.

### 1.1.6 Data Sheets and Brochures

The data sheet contains the technical specifications of the R&S FSVA/FSV. It also lists the firmware applications and their order numbers, and optional accessories.

The brochure provides an overview of the instrument and deals with the specific characteristics.

See [www.rohde-schwarz.com/brochure-datasheet/FSV](http://www.rohde-schwarz.com/brochure-datasheet/FSV)

### 1.1.7 Release Notes and Open Source Acknowledgment (OSA)

The release notes list new features, improvements and known issues of the current firmware version, and describe the firmware installation.

The open source acknowledgment document provides verbatim license texts of the used open source software.

See [www.rohde-schwarz.com/firmware/FSV](http://www.rohde-schwarz.com/firmware/FSV)

### 1.1.8 Application Notes, Application Cards, White Papers, etc.

These documents deal with special applications or background information on particular topics.

See [www.rohde-schwarz.com/application/FSV](http://www.rohde-schwarz.com/application/FSV)

## 1.2 Conventions Used in the Documentation

### 1.2.1 Typographical Conventions

The following text markers are used throughout this documentation:

Convention	Description
"Graphical user interface elements"	All names of graphical user interface elements on the screen, such as dialog boxes, menus, options, buttons, and softkeys are enclosed by quotation marks.
[Keys]	Key and knob names are enclosed by square brackets.
Filenames, commands, program code	Filenames, commands, coding samples and screen output are distinguished by their font.
<i>Input</i>	Input to be entered by the user is displayed in italics.
<a href="#">Links</a>	Links that you can click are displayed in blue font.
"References"	References to other parts of the documentation are enclosed by quotation marks.

## 1.2.2 Conventions for Procedure Descriptions

When operating the instrument, several alternative methods may be available to perform the same task. In this case, the procedure using the touchscreen is described. Any elements that can be activated by touching can also be clicked using an additionally connected mouse. The alternative procedure using the keys on the instrument or the on-screen keyboard is only described if it deviates from the standard operating procedures.

The term "select" may refer to any of the described methods, i.e. using a finger on the touchscreen, a mouse pointer in the display, or a key on the instrument or on a keyboard.

## 1.2.3 Notes on Screenshots

When describing the functions of the product, we use sample screenshots. These screenshots are meant to illustrate as many as possible of the provided functions and possible interdependencies between parameters. The shown values may not represent realistic usage scenarios.

The screenshots usually show a fully equipped product, that is: with all options installed. Thus, some functions shown in the screenshots may not be available in your particular product configuration.

# 1.3 How to Use the Help System

## Calling context-sensitive and general help

- ▶ To display the general help dialog box, press the [HELP] key on the front panel. The help dialog box "View" tab is displayed. A topic containing information about the current menu or the currently opened dialog box and its function is displayed.



For standard Windows dialog boxes (e.g. File Properties, Print dialog etc.), no context-sensitive help is available.

- ▶ If the help is already displayed, press the softkey for which you want to display help.

A topic containing information about the softkey and its function is displayed.



If a softkey opens a submenu and you press the softkey a second time, the submenu of the softkey is displayed.

### Contents of the help dialog box

The help dialog box contains four tabs:

- "Contents" - contains a table of help contents
- "View" - contains a specific help topic
- "Index" - contains index entries to search for help topics
- "Zoom" - contains zoom functions for the help display

To change between these tabs, press the tab on the touchscreen.

### Navigating in the table of contents

- To move through the displayed contents entries, use the [UP ARROW] and [DOWN ARROW] keys. Entries that contain further entries are marked with a plus sign.
- To display a help topic, press the [ENTER] key. The "View" tab with the corresponding help topic is displayed.
- To change to the next tab, press the tab on the touchscreen.

### Navigating in the help topics

- To scroll through a page, use the rotary knob or the [UP ARROW] and [DOWN ARROW] keys.
- To jump to the linked topic, press the link text on the touchscreen.

### Searching for a topic

1. Change to the "Index" tab.
2. Enter the first characters of the topic you are interested in. The entries starting with these characters are displayed.
3. Change the focus by pressing the [ENTER] key.
4. Select the suitable keyword by using the [UP ARROW] or [DOWN ARROW] keys or the rotary knob.
5. Press the [ENTER] key to display the help topic.

The "View" tab with the corresponding help topic is displayed.

### Changing the zoom

1. Change to the "Zoom" tab.
2. Set the zoom using the rotary knob. Four settings are available: 1-4. The smallest size is selected by number 1, the largest size is selected by number 4.

### Closing the help window

- ▶ Press the [ESC] key or a function key on the front panel.

## 1.4 Notes for Users of R&S FSV 1307.9002Kxx Models

Users of R&S FSV 1307.9002Kxx models should consider the following differences to the description of the newer R&S FSVA/FSV 1321.3008Kxx models:

- Functions that are based on the Windows 10 operating system (e.g. printing or setting up networks) may have a slightly different appearance or require different settings on the Windows XP based models. For such functions, refer to the Windows documentation or the documentation originally provided with the R&S FSV instrument.
- The R&S FSV 1307.9002K03 model is restricted to a maximum frequency of 3 GHz, whereas the R&S FSVA/FSV1321.3008K04 model has a maximum frequency of 4 GHz.
- The bandwidth extension option R&S FSV-B160 (1311.2015.xx) is not available for the R&S FSV 1307.9002Kxx models. The maximum usable I/Q analysis bandwidth for these models is 28 MHz, or with option R&S FSV-B70, 40 MHz.

## 2 Introduction

Currently, UMTS networks worldwide are being upgraded to high speed downlink packet access (HSDPA) in order to increase data rate and capacity for downlink packet data. In the next step, high speed uplink packet access (HSUPA) will boost uplink performance in UMTS networks. While HSDPA was introduced as a 3GPP Release 5 feature, HSUPA is an important feature of 3GPP Release 6. The combination of HSDPA and HSUPA is often referred to as HSPA.

However, even with the introduction of HSPA, the evolution of UMTS has not reached its end. HSPA+ will bring significant enhancements in 3GPP Release 7. The objective is to enhance the performance of HSPA-based radio networks in terms of spectrum efficiency, peak data rate and latency, and to exploit the full potential of WCDMA-based 5 MHz operation. Important features of HSPA+ are downlink multiple input multiple output (MIMO), higher order modulation for uplink and downlink, improvements of layer 2 protocols, and continuous packet connectivity.

In order to ensure the competitiveness of UMTS for the next 10 years and beyond, concepts for UMTS long term evolution (LTE) have been investigated. The objective is a high-data-rate, low-latency and packet-optimized radio access technology. Therefore, a study item was launched in 3GPP Release 7 on evolved UMTS terrestrial radio access (EUTRA) and evolved UMTS terrestrial radio access network (EUTRAN). LTE/EUTRA will then form part of 3GPP Release 8 core specifications.

This introduction focuses on LTE/EUTRA technology. In the following, the terms LTE or EUTRA are used interchangeably.

In the context of the LTE study item, 3GPP work first focused on the definition of requirements, e.g. targets for data rate, capacity, spectrum efficiency, and latency. Also commercial aspects such as costs for installing and operating the network were considered. Based on these requirements, technical concepts for the air interface transmission schemes and protocols were studied. Notably, LTE uses new multiple access schemes on the air interface: orthogonal frequency division multiple access (OFDMA) in downlink and single carrier frequency division multiple access (SC-FDMA) in uplink. Furthermore, MIMO antenna schemes form an essential part of LTE. In an attempt to simplify protocol architecture, LTE brings some major changes to the existing UMTS protocol concepts. Impact on the overall network architecture including the core network is being investigated in the context of 3GPP system architecture evolution (SAE).

- [Requirements for UMTS Long-Term Evolution](#)..... 14
- [Long-Term Evolution Downlink Transmission Scheme](#)..... 16
- [References](#).....21

### 2.1 Requirements for UMTS Long-Term Evolution

LTE is focusing on optimum support of packet switched (PS) services. Main requirements for the design of an LTE system are documented in 3GPP TR 25.913 [1] and can be summarized as follows:

- **Data Rate:** Peak data rates target 100 Mbps (downlink) and 50 Mbps (uplink) for 20 MHz spectrum allocation, assuming two receive antennas and one transmit antenna are at the terminal.
- **Throughput:** The target for downlink average user throughput per MHz is three to four times better than Release 6. The target for uplink average user throughput per MHz is two to three times better than Release 6.
- **Spectrum efficiency:** The downlink target is three to four times better than Release 6. The uplink target is two to three times better than Release 6.
- **Latency:** The one-way transit time between a packet being available at the IP layer in either the UE or radio access network and the availability of this packet at IP layer in the radio access network/UE shall be less than 5 ms. Also C-plane latency shall be reduced, e.g. to allow fast transition times of less than 100 ms from camped state to active state.
- **Bandwidth:** Scaleable bandwidths of 5 MHz, 10 MHz, 15 MHz, and 20 MHz shall be supported. Also bandwidths smaller than 5 MHz shall be supported for more flexibility.
- **Interworking:** Interworking with existing UTRAN/GERAN systems and non-3GPP systems shall be ensured. Multimode terminals shall support handover to and from UTRAN and GERAN as well as inter-RAT measurements. Interruption time for handover between EUTRAN and UTRAN/GERAN shall be less than 300 ms for realtime services and less than 500 ms for non-realtime services.
- **Multimedia broadcast multicast services (MBMS):** MBMS shall be further enhanced and is then referred to as E-MBMS.
- **Costs:** Reduced CAPEX and OPEX including backhaul shall be achieved. Cost-effective migration from Release 6 UTRA radio interface and architecture shall be possible. Reasonable system and terminal complexity, cost, and power consumption shall be ensured. All the interfaces specified shall be open for multivendor equipment interoperability.
- **Mobility:** The system should be optimized for low mobile speed (0 to 15 km/h), but higher mobile speeds shall be supported as well, including high speed train environment as a special case.
- **Spectrum allocation:** Operation in paired (frequency division duplex / FDD mode) and unpaired spectrum (time division duplex / TDD mode) is possible.
- **Co-existence:** Co-existence in the same geographical area and co-location with GERAN/UTRAN shall be ensured. Also, co-existence between operators in adjacent bands as well as cross-border co-existence is a requirement.
- **Quality of Service:** End-to-end quality of service (QoS) shall be supported. VoIP should be supported with at least as good radio and backhaul efficiency and latency as voice traffic over the UMTS circuit switched networks.
- **Network synchronization:** Time synchronization of different network sites shall not be mandated.

## 2.2 Long-Term Evolution Downlink Transmission Scheme

### 2.2.1 OFDMA

The downlink transmission scheme for EUTRA FDD and TDD modes is based on conventional OFDM.

In an OFDM system, the available spectrum is divided into multiple carriers, called sub-carriers, which are orthogonal to each other. Each of these subcarriers is independently modulated by a low rate data stream.

OFDM is used as well in WLAN, WiMAX and broadcast technologies like DVB. OFDM has several benefits including its robustness against multipath fading and its efficient receiver architecture.

Figure 2-1 shows a representation of an OFDM signal taken from 3GPP TR 25.892 [2]. In this figure, a signal with 5 MHz bandwidth is shown, but the principle is of course the same for the other EUTRA bandwidths. Data symbols are independently modulated and transmitted over a high number of closely spaced orthogonal subcarriers. In EUTRA, downlink modulation schemes QPSK, 16QAM, and 64QAM are available.

In the time domain, a guard interval may be added to each symbol to combat inter-OFDM-symbol-interference due to channel delay spread. In EUTRA, the guard interval is a cyclic prefix which is inserted prior to each OFDM symbol.

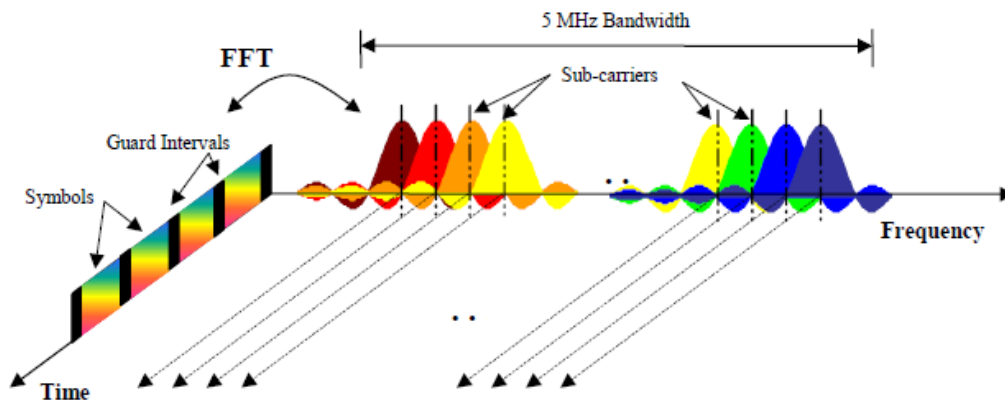

Figure 2-1: Frequency-Time Representation of an OFDM Signal

In practice, the OFDM signal can be generated using the inverse fast Fourier transform (IFFT) digital signal processing. The IFFT converts a number  $N$  of complex data symbols used as frequency domain bins into the time domain signal. Such an  $N$ -point IFFT is illustrated in Figure 2-2, where  $a(mN+n)$  refers to the  $n^{\text{th}}$  subchannel modulated data symbol, during the time period  $mT_u < t \leq (m+1)T_u$ .



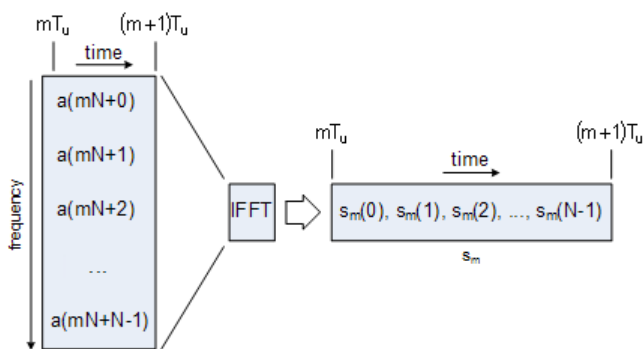

Figure 2-2: OFDM useful symbol generation using an IFFT

The vector  $s_m$  is defined as the useful OFDM symbol. It is the time superposition of the  $N$  narrowband modulated subcarriers. Therefore, from a parallel stream of  $N$  sources of data, each one independently modulated, a waveform composed of  $N$  orthogonal subcarriers is obtained, with each subcarrier having the shape of a frequency sinc function (see Figure 2-1).

Figure 2-3 illustrates the mapping from a serial stream of QAM symbols to  $N$  parallel streams, used as frequency domain bins for the IFFT. The  $N$ -point time domain blocks obtained from the IFFT are then serialized to create a time domain signal. Not shown in Figure 2-3 is the process of cyclic prefix insertion.

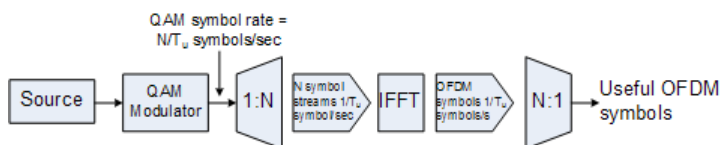

Figure 2-3: OFDM Signal Generation Chain

In contrast to an OFDM transmission scheme, OFDMA allows the access of multiple users on the available bandwidth. Each user is assigned a specific time-frequency resource. As a fundamental principle of EUTRA, the data channels are shared channels, i.e. for each transmission time interval of 1 ms, a new scheduling decision is taken regarding which users are assigned to which time/frequency resources during this transmission time interval.

## 2.2.2 OFDMA Parameterization

A generic frame structure is defined for both EUTRA FDD and TDD modes. Additionally, an alternative frame structure is defined for the TDD mode only. The EUTRA frame structures are defined in 3GPP TS 36.211. For the generic frame structure, the 10 ms radio frame is divided into 20 equally sized slots of 0.5 ms. A subframe consists of two consecutive slots, so one radio frame contains 10 subframes. This is illustrated in Figure 2-4 ( $T_s$  expresses the basic time unit corresponding to 30.72 MHz).

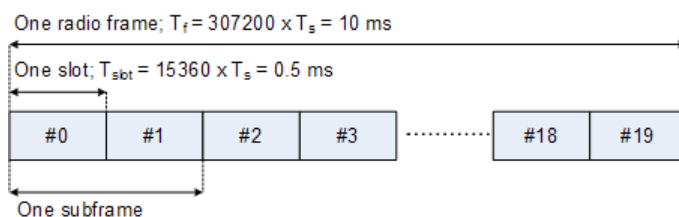

Figure 2-4: Generic Frame Structure in EUTRA Downlink

Figure 2-5 shows the structure of the downlink resource grid for the duration of one downlink slot. The available downlink bandwidth consists of  $N_{BW}^{DL}$  subcarriers with a spacing of  $\Delta f = 15$  kHz. In the case of multi-cell MBMS transmission, a subcarrier spacing of  $\Delta f = 7.5$  kHz is also possible.  $N_{BW}^{DL}$  can vary in order to allow for scalable bandwidth operation up to 20 MHz. Initially, the bandwidths for LTE were explicitly defined within layer 1 specifications. Later on a bandwidth agnostic layer 1 was introduced, with  $N_{BW}^{DL}$  for the different bandwidths to be specified by 3GPP RAN4 to meet performance requirements, e.g. for out-of-band emission requirements and regulatory emission limits.

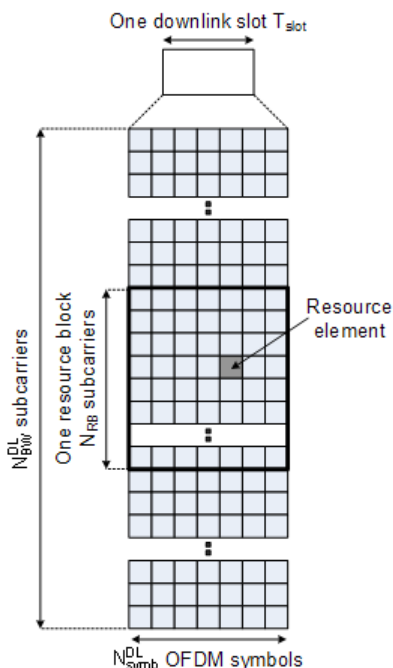

Figure 2-5: Downlink Resource Grid

One downlink slot consists of  $N_{symb}^{DL}$  OFDM symbols. To each symbol, a cyclic prefix (CP) is appended as guard time, compare Figure 2-1.  $N_{symb}^{DL}$  depends on the cyclic prefix length. The generic frame structure with normal cyclic prefix length contains  $N_{symb}^{DL} = 7$  symbols. This translates into a cyclic prefix length of  $T_{CP} \approx 5.2 \mu s$  for the first symbol and  $T_{CP} \approx 4.7 \mu s$  for the remaining 6 symbols. Additionally, an extended cyclic prefix is defined in order to cover large cell scenarios with higher delay spread and MBMS transmission. The generic frame structure with extended cyclic prefix of  $T_{CP-E} \approx 16.7 \mu s$  contains  $N_{symb}^{DL} = 6$  OFDM symbols (subcarrier spacing 15 kHz). The generic frame struc-

ture with extended cyclic prefix of  $T_{CP-E} \approx 33.3 \mu\text{s}$  contains  $N_{\text{Sym}}^{\text{DL}} = 3$  symbols (subcarrier spacing 7.5 kHz). Table 2-1 gives an overview of the different parameters for the generic frame structure.

**Table 2-1: Parameters for Downlink Generic Frame Structure**

Configuration	Number of Symbols $N_{\text{Sym}}^{\text{DL}}$	Cyclic Prefix Length in Samples	Cyclic Prefix Length in $\mu\text{s}$
Normal cyclic prefix $\Delta f=15$ kHz	7	160 for first symbol 144 for other symbols	5.2 $\mu\text{s}$ for first symbol 4.7 $\mu\text{s}$ for other symbols
Extended cyclic prefix $\Delta f=15$ kHz	6	512	16.7 $\mu\text{s}$
Extended cyclic prefix $\Delta f=7.5$ kHz	3	1024	33.3 $\mu\text{s}$

### 2.2.3 Downlink Data Transmission

Data is allocated to the UEs in terms of resource blocks. A physical resource block consists of 12 (24) consecutive subcarriers in the frequency domain for the  $\Delta f=15$  kHz ( $\Delta f=7.5$  kHz) case. In the time domain, a physical resource block consists of DL  $N_{\text{Sym}}^{\text{DL}}$  consecutive OFDM symbols, see Figure 2-5.  $N_{\text{Sym}}^{\text{DL}}$  is equal to the number of OFDM symbols in a slot. The resource block size is the same for all bandwidths, therefore the number of available physical resource blocks depends on the bandwidth. Depending on the required data rate, each UE can be assigned one or more resource blocks in each transmission time interval of 1 ms. The scheduling decision is done in the base station (eNodeB). The user data is carried on the physical downlink shared channel (PDSCH). Downlink control signaling on the physical downlink control channel (PDCCH) is used to convey the scheduling decisions to individual UEs. The PDCCH is located in the first OFDM symbols of a slot.

### 2.2.4 Downlink Reference Signal Structure and Cell Search

The downlink reference signal structure is important for cell search, channel estimation and neighbor cell monitoring. Figure 2-6 shows the principle of the downlink reference signal structure for one-antenna, two-antenna, and four-antenna transmission. Specific predefined resource elements in the time-frequency domain carry the reference signal sequence. Besides first reference symbols, there may be a need for second reference symbols. The different colors in Figure 2-6 represent the sequences transmitted from up to four transmit antennas.

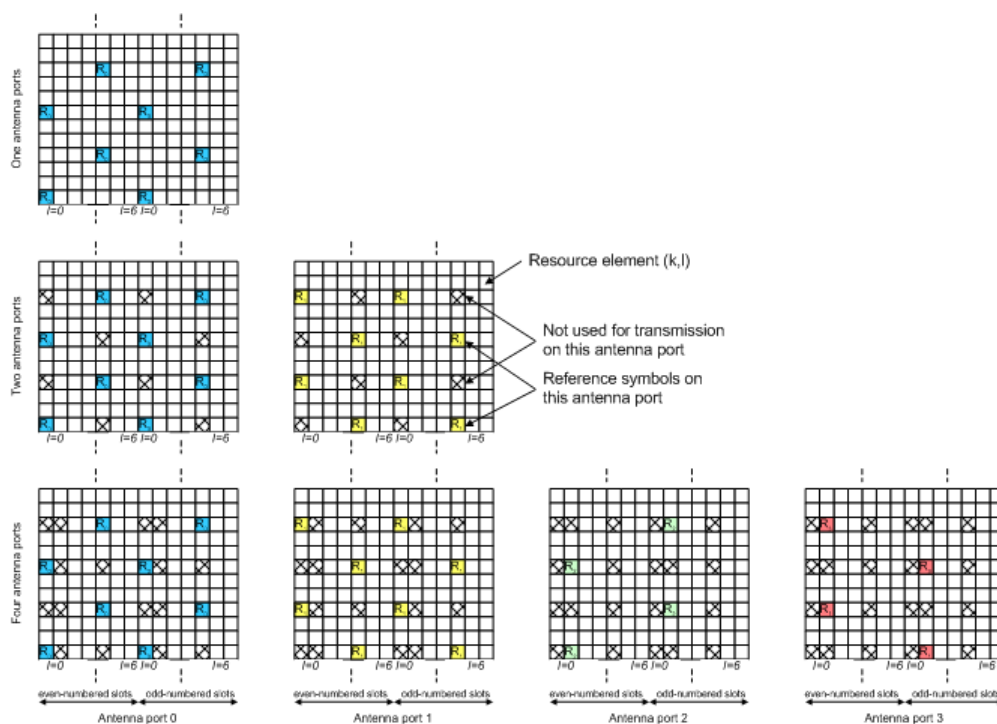

Figure 2-6: Downlink Reference Signal Structure (Normal Cyclic Prefix)

The reference signal sequence carries the cell identity. Each reference signal sequence is generated as a symbol-by-symbol product of an orthogonal sequence  $r^{OS}$  (three of them existing) and a pseudo-random sequence  $r^{PRS}$  (170 of them existing). Each cell identity corresponds to a unique combination of one orthogonal sequence  $r^{OS}$  and one pseudo-random sequence  $r^{PRS}$ , allowing 510 different cell identities.

Frequency hopping can be applied to the downlink reference signals. The frequency hopping pattern has a period of one frame (10 ms).

During cell search, different types of information need to be identified by the handset: symbol and radio frame timing, frequency, cell identification, overall transmission bandwidth, antenna configuration, and cyclic prefix length.

Besides the reference symbols, synchronization signals are therefore needed during cell search. EUTRA uses a hierarchical cell search scheme similar to WCDMA. This means that the synchronization acquisition and the cell group identifier are obtained from different synchronization signals. Thus, a primary synchronization signal (P-SYNC) and a secondary synchronization signal (S-SYNC) are assigned a predefined structure. They are transmitted on the 72 center subcarriers (around the DC subcarrier) within the same predefined slots (twice per 10 ms) on different resource elements, see [Figure 2-7](#).

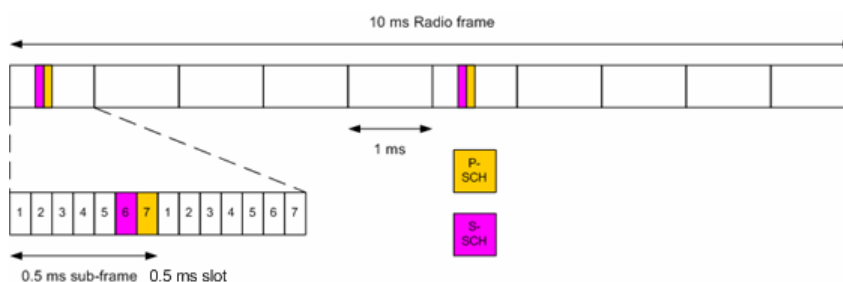

Figure 2-7: P-SYNC and S-SYNC Structure

As additional help during cell search, a common control physical channel (CCPCH) is available which carries BCH type of information, e.g. system bandwidth. It is transmitted at predefined time instants on the 72 subcarriers centered around the DC subcarrier.

In order to enable the UE to support this cell search concept, it was agreed to have a minimum UE bandwidth reception capability of 20 MHz.

## 2.2.5 Downlink Physical Layer Procedures

For EUTRA, the following downlink physical layer procedures are especially important:

- **Cell search and synchronization**  
See above.
- **Scheduling**  
Scheduling is done in the base station (eNodeB). The downlink control channel PDCCH informs the users about their allocated time/frequency resources and the transmission formats to use. The scheduler evaluates different types of information, e.g. quality of service parameters, measurements from the UE, UE capabilities, and buffer status.
- **Link adaptation**  
Link adaptation is already known from HSDPA as adaptive modulation and coding. Also in EUTRA, modulation and coding for the shared data channel is not fixed, but rather is adapted according to radio link quality. For this purpose, the UE regularly reports channel quality indications (CQI) to the eNodeB.
- **Hybrid automatic repeat request (ARQ)**  
Downlink hybrid ARQ is also known from HSDPA. It is a retransmission protocol. The UE can request retransmissions of incorrectly received data packets.

## 2.3 References

- [1] 3GPP TS 25.913: Requirements for E-UTRA and E-UTRAN (Release 7)
- [2] 3GPP TR 25.892: Feasibility Study for Orthogonal Frequency Division Multiplexing (OFDM) for UTRAN enhancement (Release 6)
- [3] 3GPP TS 36.211 v8.3.0: Physical Channels and Modulation (Release 8)

- [4] 3GPP TS 36.300: E-UTRA and E-UTRAN; Overall Description; Stage 2 (Release 8)
- [5] 3GPP TS 22.978: All-IP Network (AIPN) feasibility study (Release 7)
- [6] 3GPP TS 25.213: Spreading and modulation (FDD)
- [7] Speth, M., Fechtel, S., Fock, G., and Meyr, H.: Optimum Receiver Design for Wireless Broad-Band Systems Using OFDM – Part I. IEEE Trans. on Commun. Vol. 47 (1999) No. 11, pp. 1668-1677.
- [8] Speth, M., Fechtel, S., Fock, G., and Meyr, H.: Optimum Receiver Design for OFDM-Based Broadband Transmission – Part II: A Case Study. IEEE Trans. on Commun. Vol. 49 (2001) No. 4, pp. 571-578.

## 3 Welcome

The LTE measurement application uses the I/Q capture functionality of the following spectrum and signal analyzers to enable LTE TX measurements conforming to the 3GPP specification.

- R&S FSV

This manual contains all information necessary to configure, perform and analyze such measurements.

- [Installing the Software](#).....23
- [Application Overview](#).....23
- [Support](#).....25

### 3.1 Installing the Software

For information on the installation procedure see the release notes of the R&S FSVA/FSV.

### 3.2 Application Overview

#### Starting the application

Access the application via the "Mode" menu.

- ▶ Press the [MODE] key and select "LTE".  
Note that you may have to browse through the "Mode" menu with the "More" softkey to find the LTE entry.



#### Second LTE channel

The application provides a second LTE channel that you can access via the Mode menu with the softkey labeled "LTE2".

This second channel has the same functionality as the LTE channel. You can use it to perform measurements on two LTE channels with a different configuration, for example to test carrier aggregation.

#### Presetting the software

When you first start the software, all settings are in their default state. After you have changed any parameter, you can restore the default state with the [PRESET] key.

[CONFigure:PRESet](#) on page 109

## Elements and layout of the user interface

The user interface of the LTE measurement application is made up of several elements.

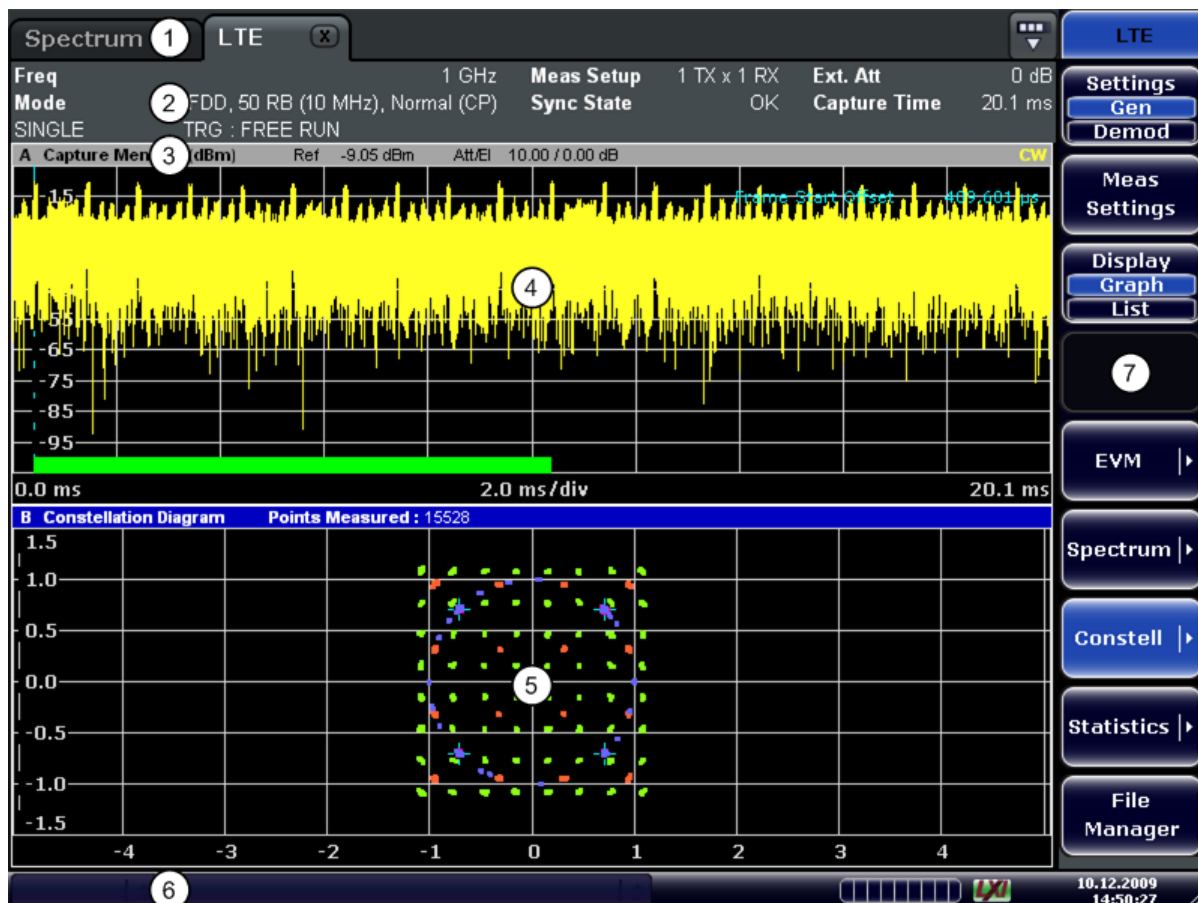

- 1 = Channel Bar: contains all currently active measurement applications
- 2 = Table Header: shows basic measurement information, e.g. the frequency
- 3 = Result Display Header: shows information about the trace
- 4 = Result Display Screen A: shows the measurement results
- 5 = Result Display Screen B: shows the measurement results
- 6 = Status Bar: shows the measurement progress, software messages and errors
- 7 = Softkeys: open settings dialogs and select result displays

### The status bar

The status bar is located at the bottom of the display. It shows the current measurement status and its progress in a running measurement. The status bar also shows warning and error messages. Error messages are generally highlighted.

### Display of measurement settings

The header table above the result displays shows information on hardware and measurement settings.



LTE <span style="float: right;">x</span>						
<b>Freq</b>		1 GHz	<b>Meas Setup</b>	1 TX x 1 RX	<b>Ext. Att</b>	0 dB
<b>Mode</b>	DL FDD, 50 RB (10 MHz), Normal (CP)		<b>Sync State</b>	OK	<b>Capture Time</b>	20.1 ms
<b>SINGLE</b>	TRG : FREE RUN					

**Table 3-1: Information displayed in the channel bar in the LTE measurement application**

<b>Freq</b>	The analyzer RF frequency.
<b>Mode</b>	Link direction, duplexing, cyclic prefix and maximum number of physical resource blocks (PRBs) / signal bandwidth.
<b>Meas Setup</b>	Number of transmitting and receiving antennas.
<b>Sync State</b>	<p>The following synchronization states can occur:</p> <ul style="list-style-type: none"> <li>• <b>OK</b> The synchronization was successful.</li> <li>• <b>FAIL (C)</b> The cyclic prefix correlation failed.</li> <li>• <b>FAIL (P)</b> The P-SYNC correlation failed.</li> <li>• <b>FAIL (S)</b> The S-SYNC correlation failed.</li> </ul> <p>Any combination of C, P and S can occur.</p> <p>Remote command:  <a href="#">[SENSe:] SYNC[:CC&lt;cc&gt;] [:STATe]? on page 112</a></p>
<b>Ext. Att</b>	External attenuation in dB.
<b>Capture Time</b>	Capture length in ms.

### 3.3 Support

If you encounter any problems when using the application, you can contact the Rohde & Schwarz support to get help for the problem.

To make the solution easier, use the "R&S Support" softkey to export useful information for troubleshooting. The R&S FSVA/FSV stores the information in a number of files that are located in the R&S FSVA/FSV directory

C:\R\_S\Instr\user\LTE\Support. If you contact Rohde & Schwarz to get help on a certain problem, send these files to the support in order to identify and solve the problem faster.

## 4 Measurement Basics

• <a href="#">Symbols and Variables</a> .....	26
• <a href="#">Overview</a> .....	27
• <a href="#">The LTE Downlink Analysis Measurement Application</a> .....	27
• <a href="#">Performing Time Alignment Measurements</a> .....	30
• <a href="#">Performing Transmit On/Off Power Measurements</a> .....	32

### 4.1 Symbols and Variables

The following chapters use various symbols and variables in the equations that the measurements are based on. The table below explains these symbols for a better understanding of the measurement principles.

$a_{l,k}, \hat{a}_{l,k}$	data symbol (actual, decided)
$b_{l,k}$	boosting factor
$\Delta f, \Delta \hat{f}_{\text{coarse}}$	carrier frequency offset between transmitter and receiver (actual, coarse estimate)
$\Delta f_{\text{res}}$	residual carrier frequency offset
$\zeta$	relative sampling frequency offset
$H_{l,k}, \hat{H}_{l,k}$	channel transfer function (actual, estimate)
$i$	time index
$\hat{t}_{\text{coarse}}, \hat{t}_{\text{fine}}$	timing estimate (coarse, fine)
$k$	subcarrier index
$l$	OFDM symbol index
$N_{\text{FFT}}$	length of FFT
$N_g$	number of samples in cyclic prefix (guard interval)
$N_s$	number of Nyquist samples
$N_{\text{RE}}$	number of resource elements
$n$	subchannel index, subframe index
$n_{l,k}$	noise sample
$\Phi_l$	common phase error
$r(i)$	received sample in the time domain
$r_{l,k}, r'_{l,k}, r''_{l,k}$	received sample (uncompensated, partially compensated, equalized) in the frequency domain
$T$	useful symbol time

$T_g$	guard time
$T_s$	symbol time

## 4.2 Overview

The digital signal processing (DSP) involves several stages until the software can present results like the EVM.



The contents of this chapter are structured like the DSP.

## 4.3 The LTE Downlink Analysis Measurement Application

The block diagram in [Figure 4-1](#) shows the EUTRA/LTE downlink measurement application from the capture buffer containing the I/Q data to the actual analysis block. The outcome of the fully compensated reference path (orange) is the estimate  $\hat{a}_{i,k}$  of the transmitted data symbols  $a_{i,k}$ . Depending on the user-defined compensation, the received samples  $r_{i,k}$  of the measurement path (blue) still contain the transmitted signal impairments of interest. The analysis block reveals these impairments by comparing the reference and the measurement path. Prior to the analysis, diverse synchronization and channel estimation tasks have to be accomplished.

### 4.3.1 Synchronization

The first of the synchronization tasks is to estimate the OFDM symbol timing, which coarsely estimates both timing and carrier frequency offset. The frame synchronization block determines the position of the P-/S-Sync symbols in time and frequency by using the coarse fractional frequency offset compensated capture buffer and the timing estimate  $\hat{t}_{\text{coarse}}$  to position the window of the FFT. If no P-/S-Sync is available in the signal, the reference signal is used for synchronization. The fine timing block prior to the FFT allows a timing improvement and makes sure that the EVM window is centered on the measured cyclic prefix of the considered OFDM symbol. For the 3GPP EVM calculation according to 3GPP TS 36.211 (v8.9.0), the block “window” produces three signals taken at the timing offsets  $\Delta t^c$ ,  $\Delta t^i$  and  $\Delta t^h$ . For the reference path, only the signal taken at the timing offset  $\Delta t^c$  is used.

The LTE Downlink Analysis Measurement Application

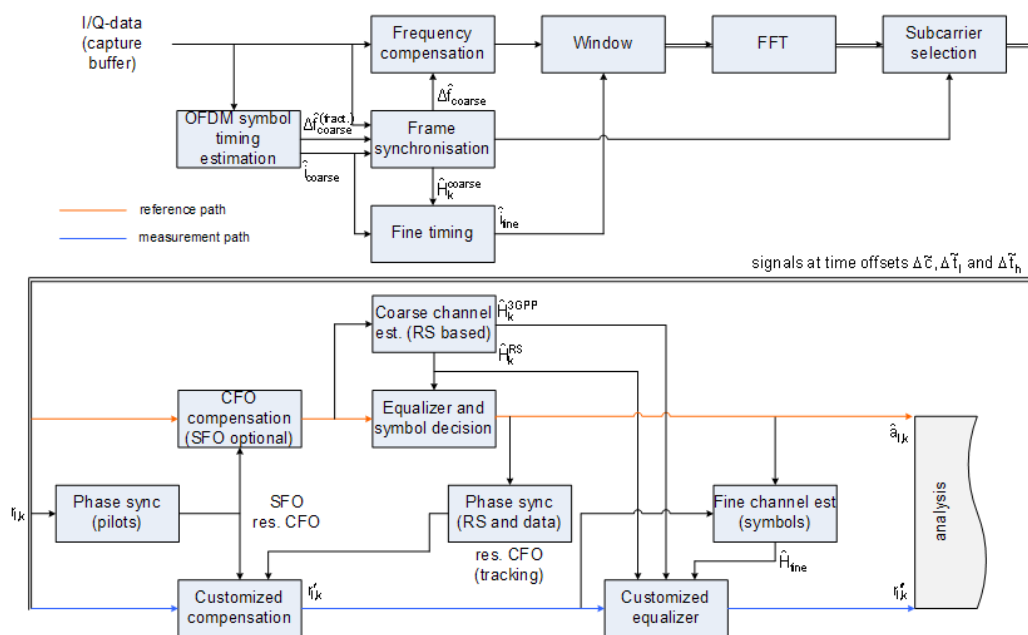

Figure 4-1: Block diagram for the LTE DL measurement application

After the time to frequency transformation by an FFT of length  $N_{FFT}$ , the phase synchronization block is used to estimate the following:

- The relative sampling frequency offset  $\zeta$  (SFO)
- The residual carrier frequency offset  $\Delta f_{res}$  (CFO)
- The common phase error  $\Phi_1$  (CPE)

According to 3GPP TS 25.913 and 3GPP TR 25.892, the uncompensated samples can be expressed as

$$R_{l,k} = A_{l,k} \cdot H_{l,k} \cdot \underbrace{e^{j\Phi_1}}_{CPE} \cdot \underbrace{e^{j2\pi \cdot N_s / N_{FFT} \cdot \zeta \cdot k \cdot l}}_{SFO} \cdot \underbrace{e^{j2\pi \cdot N_s / N_{FFT} \cdot \Delta f_{res} \cdot T \cdot l}}_{res. CFO} + N_{l,k}$$

Equation 4-1:

where

- The data symbol is  $a_{l,k}$ , on subcarrier  $k$  at OFDM symbol  $l$
- The channel transfer function is  $H_{l,k}$
- The number of Nyquist samples is  $N_s$  within the symbol time  $T_s$
- The useful symbol time  $T = T_s - T_g$
- The independent and Gaussian distributed noise sample is  $n_{l,k}$

Within one OFDM symbol, both the CPE and the residual CFO cause the same phase rotation for each subcarrier, while the rotation due to the SFO depends linearly on the subcarrier index. A linear phase increase in symbol direction can be observed for the residual CFO as well as for the SFO.

The results of the tracking estimation block are used to compensate the samples  $r_{l,k}$

Whereas a full compensation is performed in the reference path, the signal impairments that are of interest to the user are left uncompensated in the measurement path.

After having decided the data symbols in the reference path, an additional phase tracking can be utilized to refine the CPE estimation.

### 4.3.2 Channel Estimation and Equalization

As shown in [Figure 4-1](#), there is one coarse and one fine channel estimation block. The reference signal-based coarse estimation is tapped behind the CFO compensation block (SFO compensation can optionally be enabled) of the reference path. The coarse estimation block uses the reference signal symbols to determine estimates of the channel transfer function by interpolation in both time and frequency direction. A special channel estimation ( $\hat{h}_k^{\text{3GPP}}$ ) as defined in 3GPP TS 36.211 is additionally generated. The coarse estimation results are used to equalize the samples of the reference path prior to symbol decision. Based on the decided data symbols, a fine channel estimation is optimally performed and then used to equalize the partially compensated samples of the measurement path.

### 4.3.3 Analysis

The analysis block of the EUTRA/LTE downlink measurement application allows to compute a variety of measurement variables.

#### EVM

The error vector magnitude (EVM) measurement results 'EVM PDSCH QPSK/16-QAM/64-QAM' are calculated according to the specification in 3GPP TS 36.211.

All other EVM measurement results are calculated according to

$$EVM_{l,k} = \frac{|r_{l,k}'' - \hat{a}_{l,k}|}{b_{l,k} \sqrt{E \left\{ \left| \frac{a_{l,k}}{b_{l,k}} \right|^2 \right\}}}$$

#### Equation 4-2:

on subcarrier k at OFDM symbol l, where  $b_{l,k}$  is the boosting factor. Since the average power of all possible constellations is 1 when no boosting is applied, the equation can be rewritten as

$$EVM_{n,l} = \frac{|r_{l,k}'' - \hat{a}_{l,k}|}{b_{l,k}}$$

#### Equation 4-3:

The average EVM of all data subcarriers is then

$$EVM_{data} = \sqrt{\frac{1}{N_{REdata}} \sum_l \sum_{k_{data}} EVM_{l,k_{data}}^2}$$

**Equation 4-4:**

The number of resource elements taken into account is denoted by  $N_{RE\ data}$ .

### I/Q imbalance

The I/Q imbalance can be written as

$$r(t) = I \Re\{s(t)\} + jQ \Im\{s(t)\}$$

**Equation 4-5:**

where  $s(t)$  is the transmit signal,  $r(t)$  is the received signal, and  $I$  and  $Q$  are the weighting factors. We define that  $I:=1$  and  $Q:=1+\Delta Q$ .

The I/Q imbalance estimation makes it possible to evaluate the

$$\text{modulator gain balance} = |1 + \Delta Q|$$

**Equation 4-6:**

and the

$$\text{quadrature mismatch} = \arg\{1 + \Delta Q\}$$

**Equation 4-7:**

based on the complex-valued estimate  $\Delta \hat{Q}$ .

### Other measurement variables

Without going into detail, the EUTRA/LTE downlink measurement application additionally provides the following results.

- Total power
- Constellation diagram
- Group delay
- I/Q offset
- Crest factor
- Spectral flatness

## 4.4 Performing Time Alignment Measurements

The measurement application allows you to perform time alignment measurements between different antennas.

The measurement supports setups of up to four Tx antennas.

The result of the measurement is the time alignment error. The time alignment error is the time offset between a reference antenna (for example antenna 1) and another antenna.

The time alignment error results are summarized in the result summary. A schematic description of the results is provided in [Figure 4-2](#).

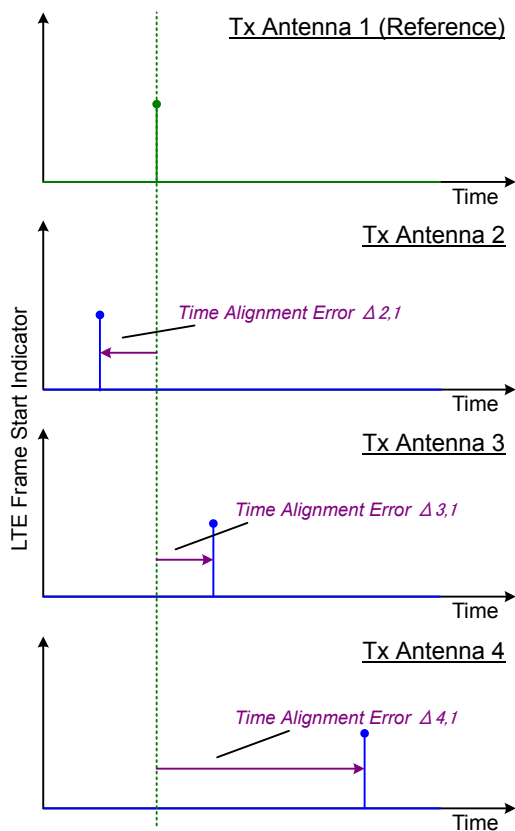

Figure 4-2: Time Alignment Error (4 Tx antennas)

**Test setup**

Successful Time Alignment measurements require a correct test setup.

A typical hardware test setup is shown in [Figure 4-3](#). Note that the dashed connections are only required for MIMO measurements on 4 Tx antennas.

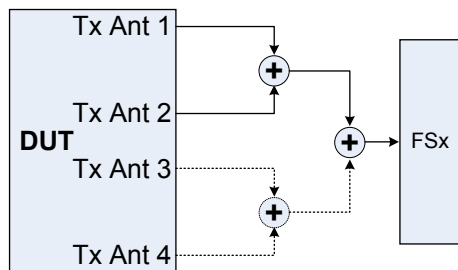

Figure 4-3: Hardware setup

For best measurement result accuracy, it is recommended to use cables of the same length and identical combiners as adders.

In the application, make sure to correctly apply the following settings.

- Select a reference antenna in the [MIMO Configuration](#) dialog box (**not** "All")
- Set the [Subframe Selection](#) to "All"
- Turn on [Compensate Crosstalk](#) in the "Demodulation Settings"
- Note that the Time Alignment measurement only evaluates the reference signal and therefore ignores any PDSCH settings - for example, it does not have an influence on this measurement if the PDSCH MIMO scheme is set to transmit diversity or spatial multiplexing.

## 4.5 Performing Transmit On/Off Power Measurements

The technical specification in 3GPP TS 36.141 describes the measurement of the transmitter "Off" power and the transmitter transient period of an EUTRA/LTE TDD base transceiver station (BTS) operating at its specified maximum output power.

A special hardware setup is required for this measurement. During the transmitter "Off" periods (the interesting parts of the signal for this measurement), the signal power is very low - measuring such low powers requires a low attenuation at the RF input. On the other hand, the signal power is very high during the transmitter "On" periods - in fact the signal power is usually higher than the maximum allowed RF input level. Measuring high signal levels requires an appropriate test setup as described below.

---

### **NOTICE**

#### **Risk of instrument damage**

The signal power during the "On" transmitter periods in this test scenario is usually higher than the maximum power allowed at the RF input of a spectrum analyzer.

Make sure to set up the measurement appropriately. Not doing so can cause severe damage to the spectrum analyzer.

---



**Test setup**

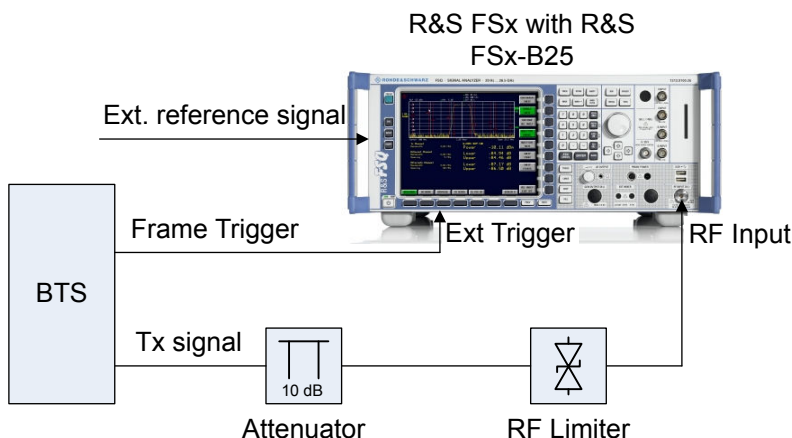

**Figure 4-4: Test setup for transmit on / off power measurement**

- Connect an RF limiter to the RF input to protect the RF input from damage (see [Figure 4-4](#)). [Table 4-1](#) shows the specifications that the limiter has to fulfill.
- Insert an additional 10 dB attenuator in front of the RF limiter to absorb possible reflected waves (because of the high VSWR of the limiter). The maximum allowed CW input power of the attenuator must be lower than the maximum output power of the BTS.

**Table 4-1: Specifications of the RF limiter in the test setup**

Min. acceptable CW input power	BTS output power minus 10 dB
Min. acceptable peak input power	BTS peak output power minus 10 dB
Max. output leakage	20 dBm
Max. response time	1 μs
Max. recovery time	1 μs

**Measuring the on / off power**

- Use test model E-TM1.1 for transmit on / off power measurements according to 36.141, 6.4.  
For more information about loading test model settings, see [Chapter 8, "File Management"](#), on page 99.
- If you are using an external trigger, you have to [adjust the timing](#) before you can start the actual measurement.  
The status message in the diagram header shows if timing adjustment is required or not. After timing was successfully adjusted, you can start the measurement. Note that relevant changes of settings might require another timing adjustment. If timing adjustment fails for any reason, the application shows a corresponding message in the diagram header. To find out what causes the synchronization failure, you should perform a regular EVM measurement (i.e. leave the ON/OFF Power measurement). Then you can use all the measurement results like "EVM vs

Carrier" to get more detailed information about the failure. The timing adjustment will succeed if the synchronization state in the header is OK.

- If you are using an R&S FSQ or R&S FSG for the measurement, it is recommended to use the external trigger mode, because for high power signals a successful synchronization is not guaranteed under certain circumstances.

When you start the measurement ("Run Single"), the R&S FSVA/FSV starts the measurement. The number of measurements that trace averaging is based on depends on the [number of frames](#) you have defined. When all measurements are done, the R&S FSVA/FSV indicates in the numerical result table if the measurement has failed or passed.

## 5 Measurements and Result Displays

The LTE measurement application features several measurements to examine and analyze different aspects of an LTE signal.

The source of the data that is processed is either a live signal or a previously recorded signal whose characteristics have been saved to a file. For more information see "Selecting the Input Source" on page 73.

For more information on the functionality to actually perform the measurement see Chapter 6.1, "Performing Measurements", on page 59.

- [Numerical Results](#).....35
- [Measuring the Power Over Time](#)..... 38
- [Measuring the Error Vector Magnitude \(EVM\)](#)..... 42
- [Measuring the Spectrum](#).....46
- [Measuring the Symbol Constellation](#).....53
- [Measuring Statistics](#)..... 54
- [3GPP Test Scenarios](#)..... 56

### 5.1 Numerical Results

- [Result Summary](#).....35

#### Result Summary

The Result Summary shows all relevant measurement results in numerical form, combined in one table.

► Press the "Display (List Graph)" softkey so that the "List" element is highlighted to view the Result Summary.

Remote command:

`DISPlay[:WINDow<n>]:TABLE` on page 109

#### Contents of the result summary

Result Summary						
Frame Result 1/1	Min	Mean	Limit	Max	Limit	Unit
EVM PDSCH QPSK		0.35	17.50			%
EVM PDSCH 16QAM			12.50			%
EVM PDSCH 64QAM			8.00			%
Time Alignment Error 2,1						ns
Time Alignment Error 3,1						ns
Time Alignment Error 4,1						ns
Results for Selection	Subframe(s)	ALL	Selection	Antenna 1	Frame Result 1/1	
EVM All	0.34	0.35		0.36		%
EVM Phys. Channel	0.34	0.35		0.36		%
EVM Phys. Signal	0.33	0.35		0.36		%
Frequency Error	-35.44	-35.36		-35.26		Hz
Sampling Error	-0.07	-0.04		-0.01		ppm
IQ Offset	-68.33	-67.16		-66.53		dB
IQ Gain Imbalance	-0.00	-0.00		-0.00		dB
IQ Quadrature Error	0.02	0.02		0.02		°
RSTP	-57.96	-57.95		-57.95		dBm
OSTP	-30.17	-30.17		-30.17		dBm
Power	-30.25	-30.23		-30.22		dBm
Crest Factor		10.05				dB

The table is split in two parts. The first part shows results that refer to the complete frame. For each result, the minimum, mean and maximum values are displayed. It also indicates limit check results where available. The font of 'Pass' results is green and that of 'Fail' results is red.

In addition to the red font, the application also puts a red star (**\* 25.60**) in front of failed results.

<b>EVM PDSCH QPSK</b>	Shows the EVM for all QPSK-modulated resource elements of the PDSCH channel in the analyzed frame. <a href="#">FETCh[:CC&lt;cc&gt;]:SUMMary:EVM:DSQP[:AVERage]?</a> on page 116
<b>EVM PDSCH 16QAM</b>	Shows the EVM for all 16QAM-modulated resource elements of the PDSCH channel in the analyzed frame. <a href="#">FETCh[:CC&lt;cc&gt;]:SUMMary:EVM:DSSST[:AVERage]?</a> on page 116
<b>EVM PDSCH 64QAM</b>	Shows the EVM for all 64QAM-modulated resource elements of the PDSCH channel in the analyzed frame. <a href="#">FETCh[:CC&lt;cc&gt;]:SUMMary:EVM:DSSF[:AVERage]?</a> on page 116
<b>EVM PDSCH 256QAM</b>	Shows the EVM for all 256QAM-modulated resource elements of the PDSCH channel in the analyzed frame. <a href="#">FETCh[:CC&lt;cc&gt;]:SUMMary:EVM:DSTS[:AVERage]?</a> on page 117
<b>EVM PDSCH 1024QAM</b>	Shows the EVM for all 1024QAM-modulated resource elements of the PDSCH channel in the analyzed frame. <a href="#">FETCh[:CC&lt;cc&gt;]:SUMMary:EVM:DS1K[:AVERage]?</a> on page 117
<b>Time Alignment Error 2,1 / 3,1 / 4,1</b>	Shows the timing difference in MIMO setups between antenna 1 and another antenna (2, 3 or 4). <a href="#">FETCh[:CC&lt;cc&gt;]:SUMMary:TAE&lt;ant&gt;?</a> on page 121

By default, all EVM results are in %. To view the EVM results in dB, change the [EVM Unit](#).

The second part of the table shows results that refer to a specific selection of the frame.

The statistic is always evaluated over the subframes.

The header row of the table contains information about the selection you have made (like the subframe).

<b>EVM All</b>	Shows the EVM for all resource elements in the analyzed frame. <a href="#">FETCh[:CC&lt;cc&gt;]:SUMMary:EVM[:ALL][:AVERage]?</a> on page 115
<b>EVM Phys Channel</b>	Shows the EVM for all physical channel resource elements in the analyzed frame.  A physical channel corresponds to a set of resource elements carrying information from higher layers. PDSCH, PBCH or PDCCH, for example, are physical channels. For more information, see 3GPP 36.211. <a href="#">FETCh[:CC&lt;cc&gt;]:SUMMary:EVM:PCHannel[:AVERage]?</a> on page 117
<b>EVM Phys Signal</b>	Shows the EVM for all physical signal resource elements in the analyzed frame.  The reference signal, for example, is a physical signal. For more information, see 3GPP 36.211. <a href="#">FETCh[:CC&lt;cc&gt;]:SUMMary:EVM:PSIGnal[:AVERage]?</a> on page 118
<b>Frequency Error</b>	Shows the difference in the measured center frequency and the reference center frequency. <a href="#">FETCh[:CC&lt;cc&gt;]:SUMMary:FERRor[:AVERage]?</a> on page 118
<b>Sampling Error</b>	Shows the difference in measured symbol clock and reference symbol clock relative to the system sampling rate. <a href="#">FETCh[:CC&lt;cc&gt;]:SUMMary:SERRor[:AVERage]?</a> on page 121
<b>I/Q Offset</b>	Shows the power at spectral line 0 normalized to the total transmitted power. <a href="#">FETCh[:CC&lt;cc&gt;]:SUMMary:IQOFFset[:AVERage]?</a> on page 119
<b>I/Q Gain Imbalance</b>	Shows the logarithm of the gain ratio of the Q-channel to the I-channel. <a href="#">FETCh[:CC&lt;cc&gt;]:SUMMary:GIMBalance[:AVERage]?</a> on page 119
<b>I/Q Quadrature Error</b>	Shows the measure of the phase angle between Q-channel and I-channel deviating from the ideal 90 degrees. <a href="#">FETCh[:CC&lt;cc&gt;]:SUMMary:QUADerror[:AVERage]?</a> on page 120
<b>RSTP</b>	Shows the reference signal transmit power as defined in 3GPP TS 36.141. It is required for the "DL RS Power" test.  It is an average power and accumulates the powers of the reference symbols within a subframe divided by the number of reference symbols within a subframe. <a href="#">FETCh[:CC&lt;cc&gt;]:SUMMary:RSTP[:AVERage]?</a> on page 121
<b>OSTP</b>	Shows the OFDM symbol transmit power as defined in 3GPP TS 36.141.  It accumulates all subcarrier powers of the 4th OFDM symbol. The 4th (out of 14 OFDM symbols within a subframe (for frame type 1, normal CP length)) contains exclusively PDSCH. <a href="#">FETCh[:CC&lt;cc&gt;]:SUMMary:OSTP[:AVERage]?</a> on page 119

<b>Power</b>	Shows the average time domain power of the analyzed signal. <a href="#">FETCh[:CC&lt;cc&gt;]:SUMMary:POWer[:AVERAge]?</a> on page 120
<b>Crest Factor</b>	Shows the peak-to-average power ratio of captured signal. <a href="#">FETCh[:CC&lt;cc&gt;]:SUMMary:CRESt[:AVERAge]?</a> on page 115

## 5.2 Measuring the Power Over Time

This chapter contains information on all measurements that show the power of a signal over time.

<a href="#">Capture Buffer</a> .....	38
<a href="#">Transmit On / Off Power</a> .....	39
L <a href="#">Numerical results</a> .....	39
L <a href="#">Transmit power on / off diagram</a> .....	41
L <a href="#">Transition diagram</a> .....	41
L <a href="#">Adjust Timing</a> .....	42
L <a href="#">Noise Cancellation</a> .....	42

### Capture Buffer

The "Capture Buffer" shows the complete range of captured data for the last data capture.

The x-axis represents time. The maximum value of the x-axis is equal to the [Capture Time](#).

The y-axis represents the amplitude of the captured I/Q data in dBm (for RF input).

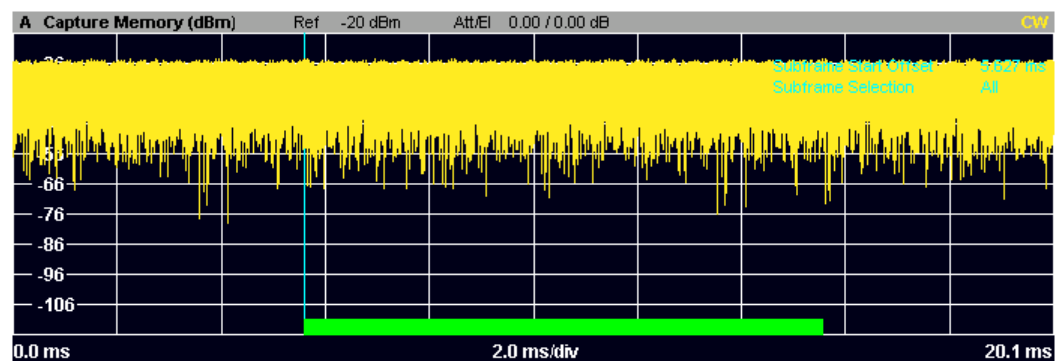

Figure 5-1: Capture buffer without zoom

A green bar at the bottom of the diagram represents the frame that is currently analyzed.

A green vertical line at the beginning of the green bar in the capture buffer represents the subframe start. The diagram also contains the "Start Offset" value. This value is the time difference between the subframe start and capture buffer start.

When you zoom into the diagram, you will see that the bar is interrupted at certain positions. Each small bar indicates the useful parts of the OFDM symbol.

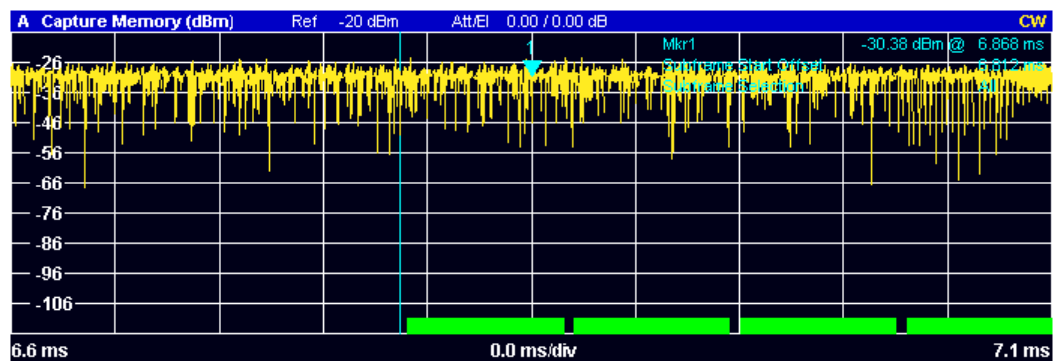

Figure 5-2: Capture buffer after a zoom has been applied

Remote command:

Selection: `CALCulate<n>:FEED 'PVT:CBUF'`

Query (y-axis): `TRACe:DATA?`

Subframe start offset: `FETCh[:CC<cc>]:SUMMARY:TFRame?` on page 122

### Transmit On / Off Power

The transmit on / off power measurement analyzes the transition from transmission ("on" periods) to reception ("off" periods) of an LTE TDD signal over time. Because this transition must happen very fast to use resources efficiently, it can be an issue in TDD systems.

During the transmit power on / off measurement, the R&S FSVA/FSV verifies if the "off" periods (= no signal transmission) comply to the limits defined by 3GPP. Note that you have to apply a signal to the RF input for this measurement, because the R&S FSVA/FSV has to capture new I/Q data instead of using the data other I/Q measurements are based on.

For more information on setting up the measurement, see [Chapter 4.5, "Performing Transmit On/Off Power Measurements"](#), on page 32.

The results for the transmit on / off power measurement are available in the following displays.

- ["Numerical results"](#) on page 39
- ["Transmit power on / off diagram"](#) on page 41
- ["Transition diagram"](#) on page 41

Remote command:

Selection: `CALCulate<n>:FEED 'PVT:OOP'`

Query: `TRACe:DATA?`

### Numerical results ← Transmit On / Off Power

The result summary shows the measurement results in a table. Each line in the table corresponds to one "off" period.

The result summary shows the following information for each "off" period.

- "Start Off Period Limit"  
Shows the beginning of the "off" period relative to the frame start (0 seconds).
- "Stop Off Period Limit"  
Shows the end of the "off" period relative to the frame start (0 seconds).

The time from the start to the stop of the "off" period is the period over which the limits are checked. It corresponds to the yellow trace in the diagram.

- "Time at  $\Delta$  to Limit"  
Shows the trace point at which the lowest distance between trace and limit line has been detected. The result is a time relative to the frame start.
- "OFF Power"  
Shows the absolute power of the signal at the trace point with the lowest distance to the limit line.
- "OFF Power  $\Delta$  to Limit"  
Shows the distance between the trace and the limit line of the trace point with the lowest distance to the limit line in dB.
- "Falling Transition Period"  
Shows the length of the falling transient.
- "Rising Transition Period"  
Shows the length of the rising transient.

Results that comply with the limits are displayed in green. Any results that violate the limits defined by 3GPP are displayed in red.

A ON/OFF Power						
Start OFF Period Limit	Stop OFF Period Limit	Time at $\Delta$ to Limit	OFF Power Abs[dBm]	OFF Power $\Delta$ to Limit	Falling Trans. Period	Rising Trans. Period
1.838 ms	4.948 ms	2.962891 ms	-86.21 dBm	11.21 dB	2.41 $\mu$ s	2.44 $\mu$ s

Note that the beginning and end of a transition period is determined based on the "Off Power Density Limit". This limit is defined in 3GPP 36.141 as the maximum allowed mean power spectral density. The length of the transient from "on" to "off" period is, for example, the distance from the detected end of the subframe to the last time that the signal power is above the measured mean power spectral density.

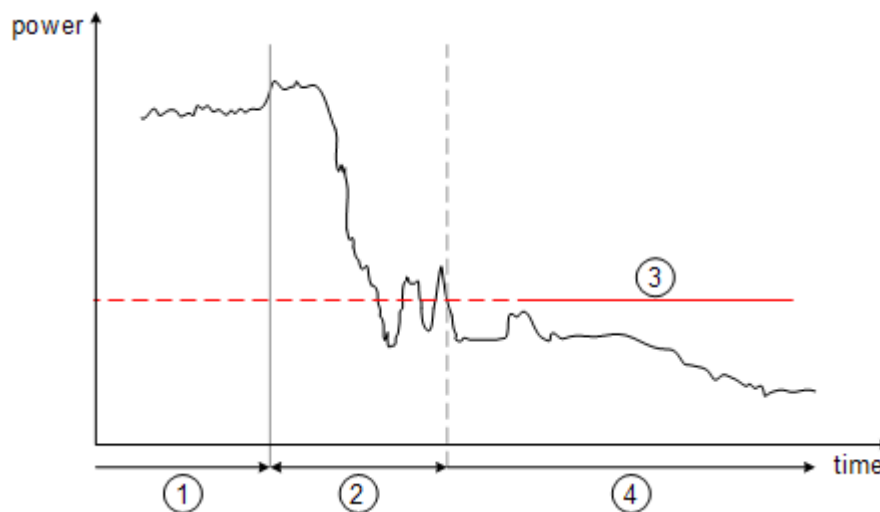

**Figure 5-3: Power profile of a TD-LTE On-to-Off transition. The transition lasts from the end of the ON period until the signal is completely below the Off Power Density limit.**

- 1 = subframe ("on" power period)
- 2 = transient (transition length)
- 3 = "off" power density limit
- 4 = "off" power period



**Transmit power on / off diagram ← Transmit On / Off Power**

The diagram shows all TDD frames that were captured and analyzed and contains several elements.

- Yellow trace  
The yellow trace represents the signal power during the "off" periods. The calculation of the trace also accounts for filtering as defined in 3GPP 36.141.
- Blue trace  
The blue trace represents the transition periods (falling and rising). Note that the blue trace might be visible only after zooming into the diagram because of its steep flank and small horizontal dimensions.
- Blue rectangles  
The blue rectangles represent the "on" periods. Because of the overload during the "on" periods, the actual signal power is only hinted at, not shown.
- Red lines  
Limits as defined by 3GPP.
- Other information  
In addition to these elements, the diagram also shows the overall limit check, the average count and the limit for the mean power spectral density ("Off Power Density Limit").  
The overall limit check only passes if all "off" periods (including the transients) comply with the limits.

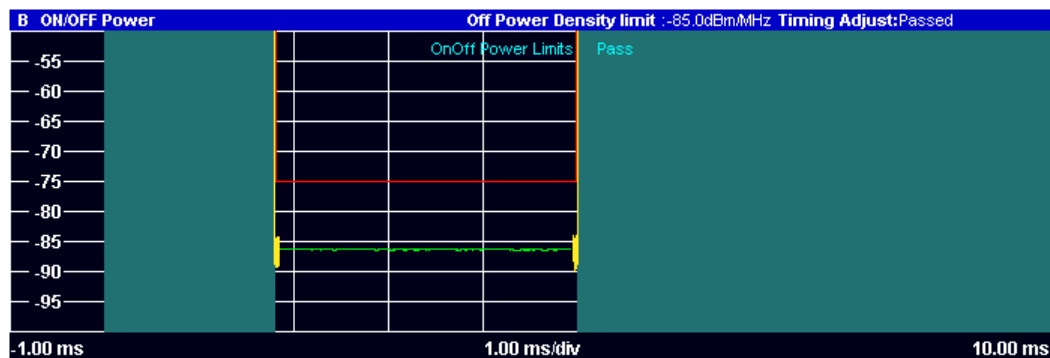

**Transition diagram ← Transmit On / Off Power**

The transition diagrams show the rising and falling periods for each TDD frame in more detail.

You can display the transitions for up to two TDD frames.

The diagrams contain the following elements.

- Blue trace  
The blue trace represents the transition periods (falling and rising).
- Red lines  
Limits as defined by 3GPP.

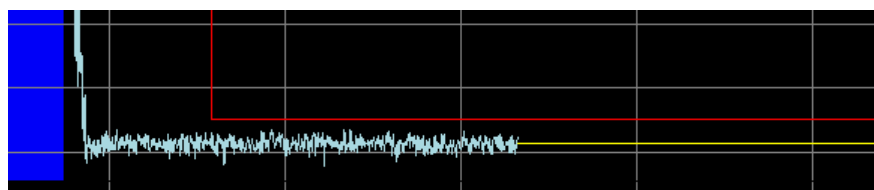

**Adjust Timing ← Transmit On / Off Power**

**Access:** [Sweep] > "Adjust Timing"

If you are using an external trigger for the on / off power measurement, you have to determine the offset of the trigger time to the time the LTE frame starts. You can do this with the "Adjust Timing" function. When the application has determined the offset, it corrects the results of the on / off power measurement accordingly.

Adjust timing also captures data with a reference level optimized for the "on" period to increase the probability for successful synchronization.

Remote command:

[SENSe:] [LTE:] OOPower:ATIMing on page 112

**Noise Cancellation ← Transmit On / Off Power**

**Access:** [Meas COnfig] > "Noise Cancellation"

Noise cancellation corrects the results by removing the inherent noise of the analyzer, which increases the dynamic range.

To do this, the R&S FSVA/FSV measures its inherent noise and subtracts the measured noise power from the power in the channel that is being analyzed.

Remote command:

[SENSe:] [LTE:] OOPower:NCORrection on page 144

### 5.3 Measuring the Error Vector Magnitude (EVM)

This chapter contains information on all measurements that show the error vector magnitude (EVM) of a signal.

The EVM is one of the most important indicators for the quality of a signal. For more information on EVM calculation methods refer to [Chapter 4, "Measurement Basics"](#), on page 26.

<a href="#">EVM vs Carrier</a> .....	42
<a href="#">EVM vs Symbol</a> .....	43
<a href="#">Frequency Error vs Symbol</a> .....	44
<a href="#">EVM vs Subframe</a> .....	45
<a href="#">EVM vs RB</a> .....	45

**EVM vs Carrier**

The "EVM vs Carrier" result display shows the error vector magnitude (EVM) of the subcarriers. With the help of a marker, you can use it as a debugging technique to identify any subcarriers whose EVM is too high.

The results are based on an average EVM that is calculated over the resource elements for each subcarrier. This average subcarrier EVM is determined for each analyzed subframe in the capture buffer.

If you analyze all subframes, the result display contains three traces.

- Average EVM  
This trace shows the subcarrier EVM, averaged over all subframes.
- Minimum EVM

## Measuring the Error Vector Magnitude (EVM)

This trace shows the lowest (average) subcarrier EVM that has been found over the analyzed subframes.

- Maximum EVM

This trace shows the highest (average) subcarrier EVM that has been found over the analyzed subframes.

If you select and analyze one subframe only, the result display contains one trace that shows the subcarrier EVM for that subframe only. Average, minimum and maximum values in that case are the same. For more information, see "[Subframe Selection](#)" on page 93.

The x-axis represents the center frequencies of the subcarriers. The y-axis shows the EVM in % or in dB, depending on the [EVM Unit](#).

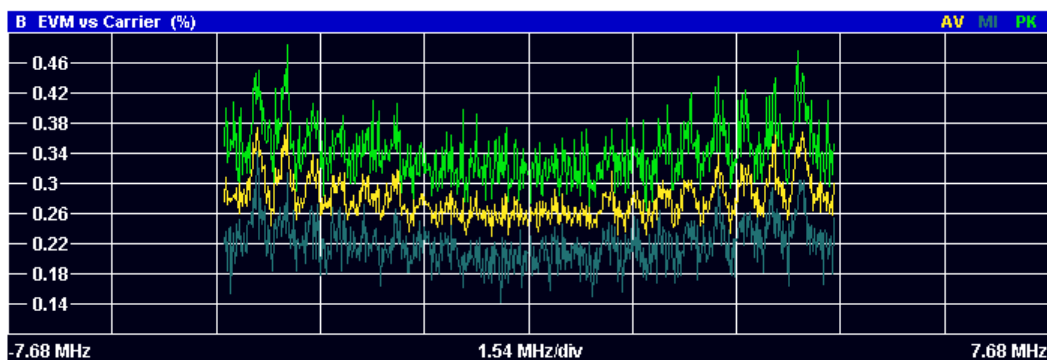

Remote command:

Selection: `CALCulate<n>:FEED 'EVM:EVCA'`

Query (y-axis): `TRACe:DATA?`

### EVM vs Symbol

The "EVM vs Symbol" result display shows the error vector magnitude (EVM) of the OFDM symbols. You can use it as a debugging technique to identify any symbols whose EVM is too high.

The results are based on an average EVM that is calculated over all subcarriers that are part of a certain OFDM symbol. This average OFDM symbol EVM is determined for all OFDM symbols in each analyzed subframe.

The x-axis represents the OFDM symbols, with each symbol represented by a dot on the line. Any missing connections from one dot to another mean that the R&S FSV/FSA could not determine the EVM for that symbol.

The number of displayed symbols depends on the subframe selection and the length of the cyclic prefix.

For TDD signals, the result display does not show OFDM symbols that are not part of the measured link direction.

On the y-axis, the EVM is plotted either in % or in dB, depending on the [EVM Unit](#).

Measuring the Error Vector Magnitude (EVM)

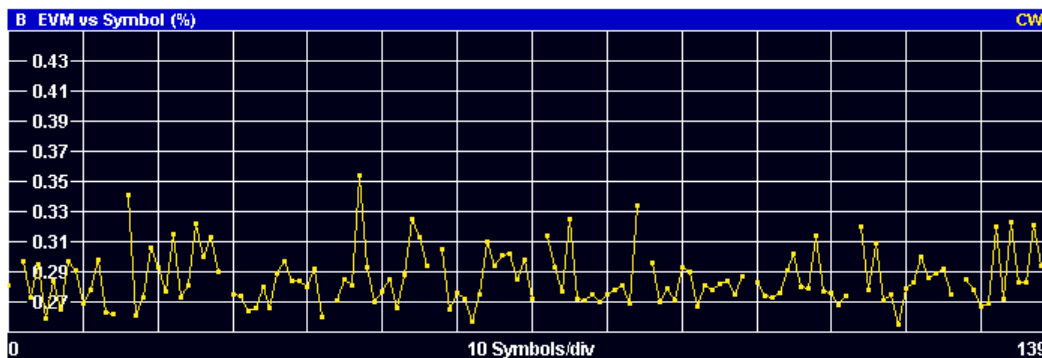

Remote command:

Selection: `CALCulate<n>:FEED 'EVM:EVS'`

Query (y-axis): `TRACe:DATA?`

**Frequency Error vs Symbol**

The "Frequency Error vs Symbol" result display shows the frequency error of each symbol. You can use it as a debugging technique to identify any frequency errors within symbols.

The result is an average over all subcarriers in the symbol.

The x-axis represents the OFDM symbols, with each symbol represented by a dot on the line. The number of displayed symbols depends on the [subframe selection](#) and the length of the [cyclic prefix](#). Any missing connections from one dot to another mean that the R&S FSV/FSV could not determine the frequency error for that symbol.

On the y-axis, the frequency error is plotted in Hz.

Note that the variance of the measurement results in this result display can be much higher compared to the frequency error display in the numerical result summary, depending on the PDSCH and control channel configuration. The potential difference is caused by the number of available resource elements for the measurement on symbol level.

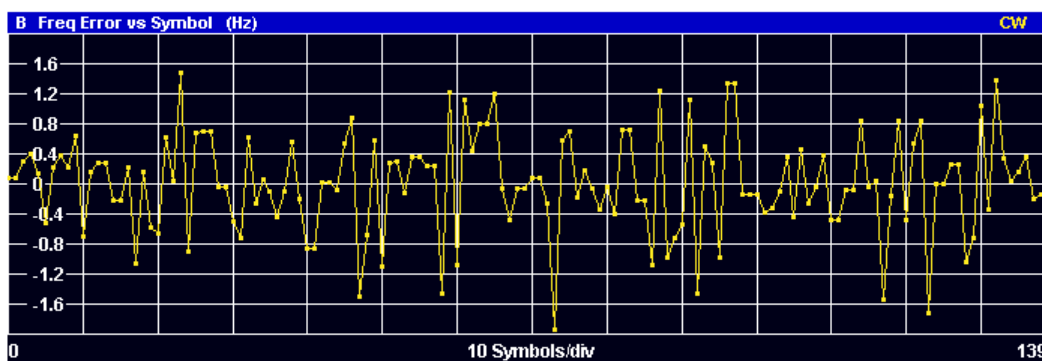

Remote command:

Selection: `CALCulate<n>:FEED 'EVM:FEVS'`

Query (y-axis): `TRACe:DATA?`

### EVM vs Subframe

The "EVM vs Subframe" result display shows the Error Vector Magnitude (EVM) for each subframe. You can use it as a debugging technique to identify a subframe whose EVM is too high.

The result is an average over all subcarriers and symbols of a specific subframe.

The x-axis represents the subframes, with the number of displayed subframes being 10.

On the y-axis, the EVM is plotted either in % or in dB, depending on the [EVM Unit](#).

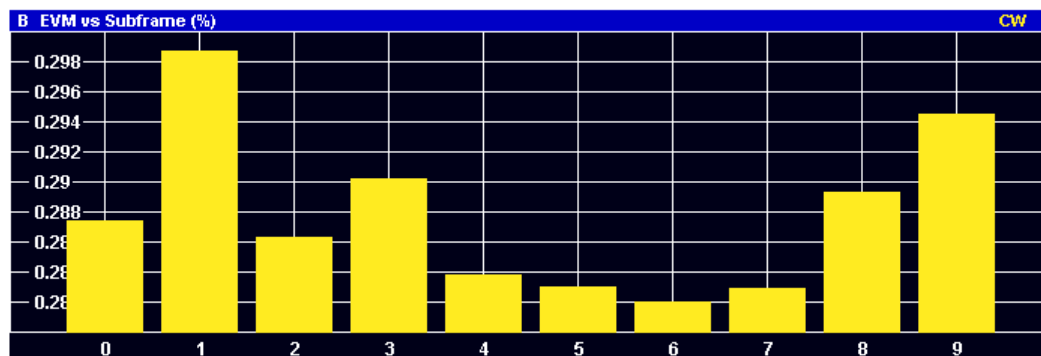

Remote command:

Selection: `CALCulate<n>:FEED 'EVM:EVSU'`

Query (y-axis): `TRACe:DATA?`

### EVM vs RB

The "EVM vs RB" result display shows the Error Vector Magnitude (EVM) for all resource blocks that can be occupied by the PDSCH.

The results are based on an average EVM that is calculated over all resource elements in the resource block. This average resource block EVM is determined for each analyzed subframe. If you analyze all subframes, the result display contains three traces.

- Average EVM  
This trace shows the resource block EVM, averaged over all subframes.
- Minimum EVM  
This trace shows the lowest (average) resource block EVM that has been found over the analyzed subframes.
- Maximum EVM  
This trace shows the highest (average) resource block EVM that has been found over the analyzed subframes.

If you select and analyze one subframe only, the result display contains one trace that shows the resource block EVM for that subframe only. Average, minimum and maximum values in that case are the same. For more information, see "[Subframe Selection](#)" on page 93.

The x-axis represents the PDSCH resource blocks. On the y-axis, the EVM is plotted either in % or in dB, depending on the [EVM Unit](#).

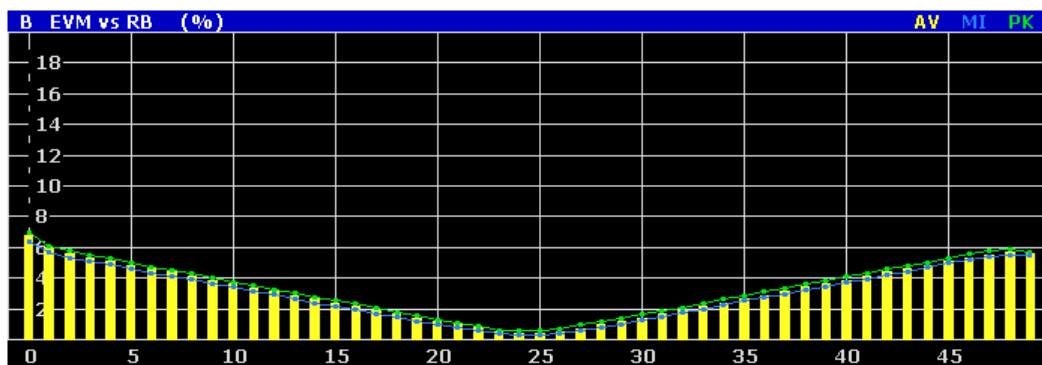

Remote command:  
 Selection: `CALCulate<n>:FEED 'EVM:EVRP'`  
 Query (y-axis): `TRACe:DATA?`

## 5.4 Measuring the Spectrum

This chapter contains information on all measurements that show the power of a signal in the frequency domain.

In addition to the I/Q measurements, spectrum measurements also include two frequency sweep measurements, the Spectrum Emission Mask and the Adjacent Channel Leakage Ratio.

- [Frequency Sweep Measurements](#)..... 46
- [I/Q Measurements](#).....50

### 5.4.1 Frequency Sweep Measurements

The Spectrum Emission Mask (SEM) and Adjacent Channel Leakage Ratio (ACLR) measurements are the only frequency sweep measurements available for the LTE measurement application. They do not use the I/Q data all other measurements use. Instead those measurements sweep the frequency spectrum every time you run a new measurement. Therefore it is not possible to to run an I/Q measurement and then view the results in the frequency sweep measurements and vice-versa. Also because each of the frequency sweep measurements uses different settings to obtain signal data it is not possible to run a frequency sweep measurement and view the results in another frequency sweep measurement.

Frequency sweep measurements are available if RF input is selected.

#### 5.4.1.1 Available Measurements

- [Spectrum Emission Mask \(SEM\)](#)..... 47
  - └ [Result diagram](#).....47
  - └ [Result summary](#)..... 47

Adjacent Channel Leakage Ratio (ACLR).....48  
 L Result diagram.....49  
 L Result summary.....49

**Spectrum Emission Mask (SEM)**

The "Spectrum Emission Mask" (SEM) measurement shows the quality of the measured signal by comparing the power values in the frequency range near the carrier against a spectral mask that is defined by the 3GPP specifications. In this way, you can test the performance of the DUT and identify the emissions and their distance to the limit.

For a comprehensive description of the SEM measurement, refer to the user manual of the R&S FSVA/FSV.

Remote command:

Selection: `CALCulate<n>:FEED 'SPEC:SEM'`

**Result diagram ← Spectrum Emission Mask (SEM)**

The result diagram is a graphic representation of the signal with a trace that shows the measured signal. The SEM is represented by a red line.

If any measured power levels are above that limit line, the test fails. If all power levels are inside the specified limits, the test passes. The application labels the limit line to indicate whether the limit check has passed or failed.

The x-axis represents the frequency with a frequency span that relates to the specified LTE channel bandwidths. The y-axis shows the signal power in dBm.

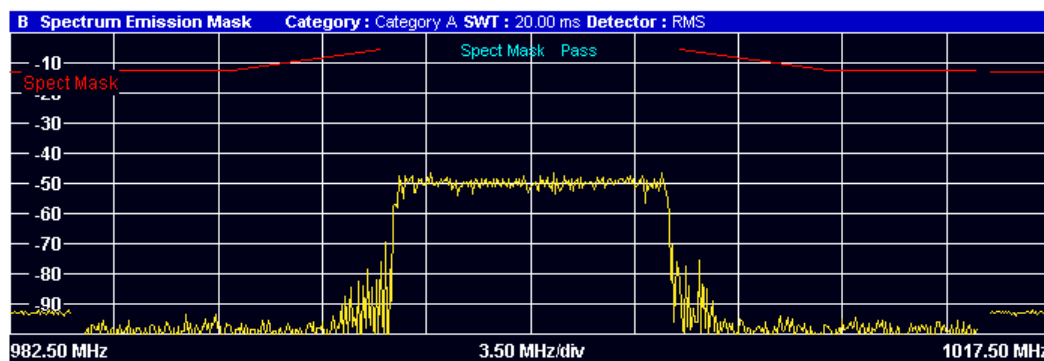

Remote command:

Result query: `TRACe:DATA?`

**Result summary ← Spectrum Emission Mask (SEM)**

The result summary shows the signal characteristics in numerical form. Each row in the table corresponds to a certain SEM range. The columns contain the range characteristics. If a limit fails, the range characteristics turn red.

- **Start / Stop Freq Rel**  
Shows the start and stop frequency of each section of the spectrum emission mask relative to the center frequency.
- **RBW**  
Shows the resolution bandwidth of each section of the spectrum emission mask.
- **Freq at Δ to Limit**

Shows the absolute frequency whose power measurement being closest to the limit line for the corresponding frequency segment.

- **Power Abs**  
Shows the absolute measured power of the frequency whose power is closest to the limit. The application evaluates this value for each frequency segment.
- **Power Rel**  
Shows the distance from the measured power to the limit line at the frequency whose power is closest to the limit. The application evaluates this value for each frequency segment.
- **Δ to Limit**  
Shows the minimal distance of the tolerance limit to the SEM trace for the corresponding frequency segment. Negative distances indicate that the trace is below the tolerance limit, positive distances indicate that the trace is above the tolerance limit.

A Spectrum Emission Mask List			Ref	-26.2 dBm	Att/EI	0.00 / 0.00 dB
Start Freq. Rel.	Stop Freq. Rel.	RBW	Freq. at Δ to Limit	Power Abs.	Power Rel.	Δ to Limit
-17.50 MHz	-15.50 MHz	1.00 MHz	983.453504000 MHz	-92.05 dBm	-61.65 dB	-79.05 dB
-15.05 MHz	-10.05 MHz	100.00 kHz	989.399040000 MHz	-93.46 dBm	-63.05 dB	-80.96 dB
-10.05 MHz	-5.05 MHz	100.00 kHz	994.950016000 MHz	-75.77 dBm	-45.37 dB	-70.27 dB
5.05 MHz	10.05 MHz	100.00 kHz	1.005665088 GHz	-75.44 dBm	-45.03 dB	-69.08 dB
10.05 MHz	15.05 MHz	100.00 kHz	1.010937472 GHz	-94.43 dBm	-64.03 dB	-81.93 dB
15.50 MHz	17.50 MHz	1.00 MHz	1.016883008 GHz	-92.15 dBm	-61.74 dB	-79.15 dB

### Adjacent Channel Leakage Ratio (ACLR)

The adjacent channel leakage ratio (ACLR) measurement is designed to analyze signals that contain multiple signals for different radio standards. Using the ACLR measurement, you can determine the power of the transmit (Tx) channel and the power of the neighboring (adjacent) channels to the left and right of the Tx channel. Thus, the ACLR measurement provides information about the power in the adjacent channels as well as the leakage into these adjacent channels.

In the LTE application, you can analyze the power of up to two Tx channels and up to two adjacent channels. If you analyze two Tx channels, they have to be next to each other. The distance between the two Tx channels is variable and is defined as a Tx offset. In the diagram, the Tx channels are labeled C0 and Cu0. For measurements on two Tx channels, the lower adjacent channels (cl1 and cl2) are to the left of the first Tx channel. The upper adjacent channels (cu1 and cu2) are to the right of the second Tx channel.

When you measure the ACLR in the LTE application, the R&S FSVA/FSV automatically selects appropriate ACLR settings based on the selected channel bandwidth.

For a comprehensive description of the ACLR measurement, refer to the user manual of the R&S FSVA/FSV.

Remote command:

Selection: `CALCulate<n>:FEED 'SPEC:ACP'`



**Result diagram ← Adjacent Channel Leakage Ratio (ACLR)**

The result diagram is a graphic representation of the signals with a trace that shows the measured signal. Individual channels (Tx and adjacent channels) are indicated by vertical lines and corresponding labels.

The x-axis represents the frequency with a frequency span that relates to the specified LTE channel and adjacent channel bandwidths. On the y-axis, the power is plotted in dBm.

The power for the Tx channel is an absolute value in dBm. The power of the adjacent channels is relative to the power of the Tx channel.

For measurements on two Tx channels, the power of the adjacent channels to the left of the Tx channels are values relative to the power of the left Tx channel. The power of the adjacent channels on the right of the TX channels are values relative to the power of the right Tx channel.

In addition, the R&S FSV/FSV tests the ACLR measurement results against the limits defined by 3GPP.

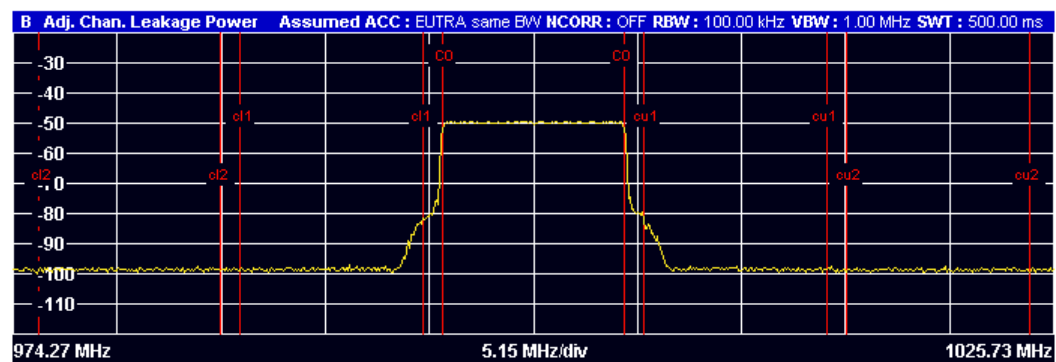

Remote command:

Result query: [TRACe:DATA?](#)

**Result summary ← Adjacent Channel Leakage Ratio (ACLR)**

The result summary shows the signal characteristics in numerical form. Each row in the table corresponds to a certain channel type (Tx, adjacent channel). The columns contain the channel characteristics.

- **Channel**  
Shows the channel type (Tx, adjacent or alternate channel).  
Note that if you measure two Tx channels, each Tx channel only has one set of adjacent channels. The first Tx channel (C0) those to its left, the second Tx channel (Cu0) those to its right.
- **Bandwidth**  
Shows the channel bandwidth.
- **Spacing**  
Shows the channel spacing.
- **Power**  
Shows the power of the Tx channel.
- **Lower / Upper**  
Shows the relative power of the lower and upper adjacent and alternate channels. The values turn red if the power violates the limits.

- **Limit**  
Shows the limit of that channel, if one is defined.

A Adj. Chan. Leakage Power Ratio List					
Channel	Bandwidth	Ref	Att/EI	Lower	Upper
TX	9.015 MHz	-26.2 dBm	0.00 / 0.00 dB	-30.53 dB	
Adjacent	9.015 MHz	10.00 MHz		-44.30 dB	-44.72 dB
Alternate	9.015 MHz	20.00 MHz		-46.75 dB	-46.86 dB
					Limit
					...
					-45.00 dB
					-45.00 dB

Remote command:

Result query: `CALCulate<n>:MARKer<m>:FUNCTION:POWER<sb>:RESULT[:CURRENT]?`

### 5.4.2 I/Q Measurements

- Power (Spec | RB RS | RB PDSCH).....50
- Flatness (Flat | Grdel | Diff).....52

#### 5.4.2.1 Power (Spec | RB RS | RB PDSCH)

The Power (Spec | RB RS | RB PDSCH) softkey selects one of three result displays. The currently selected result display is highlighted.

#### Power Spectrum

The "Power Spectrum" shows the power density of the complete capture buffer in dBm/Hz.

The displayed bandwidth depends on the selected [channel bandwidth](#).

The x-axis represents the frequency. On the y-axis, the power level is plotted.

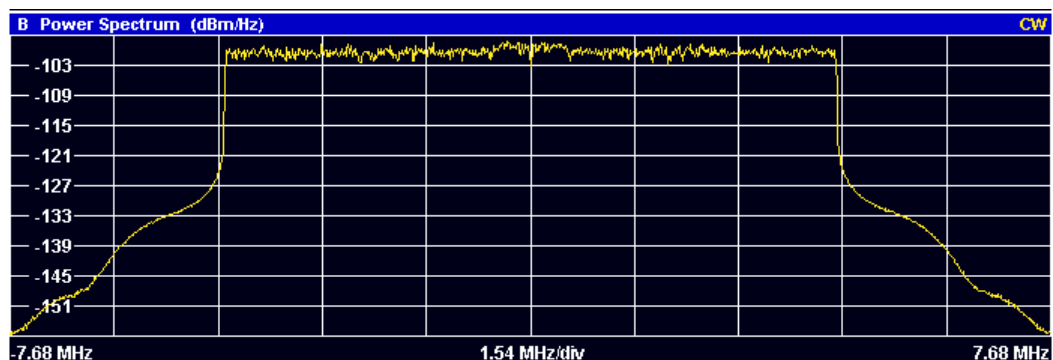

Remote command:

Selection: `CALCulate<screenid>:FEED 'SPEC:PSPE'`  
 Query (y-axis): `TRACe:DATA?`

**Power vs Resource Block PDSCH**

The "Power vs Resource Block PDSCH" result display shows the power of the physical downlink shared channel per resource element averaged over one resource block.

By default, three traces are shown. One trace shows the average power. The second and the third traces show the minimum and maximum powers respectively. You can select to display the power for a specific subframe in the Subframe Selection dialog box. In that case, the application shows the powers of that subframe only.

The x-axis represents the resource blocks. The displayed number of resource blocks depends on the channel bandwidth or number of resource blocks you have set. On the y-axis, the power is plotted in dBm.

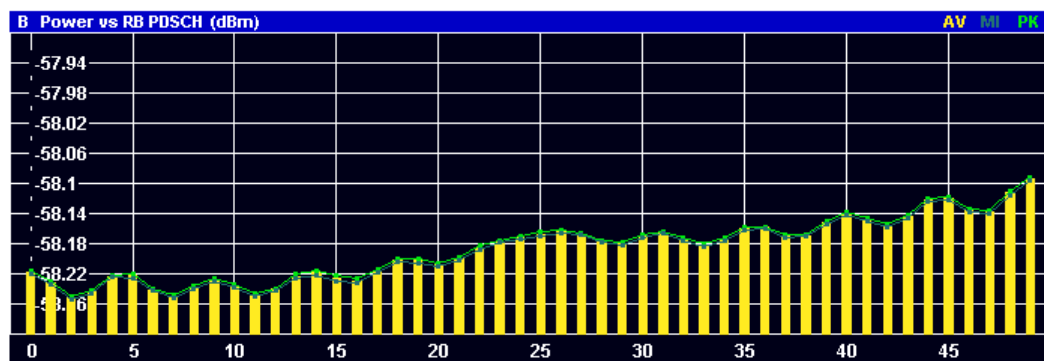

Remote command:

Selection: `CALCulate<n>:FEED 'SPEC:PVRP'`

Query (y-axis): `TRACe:DATA?`

**Power vs Resource Block RS**

The "Power vs Resource Block RS" result display shows the power of the reference signal per resource element averaged over one resource block.

By default, three traces are shown. One trace shows the average power. The second and the third traces show the minimum and maximum powers respectively. You can select to display the power for a specific subframe in the Subframe Selection dialog box. In that case, the application shows the power of that subframe only.

The x-axis represents the resource blocks. The displayed number of resource blocks depends on the channel bandwidth or number of resource blocks you have set. On the y-axis, the power is plotted in dBm.

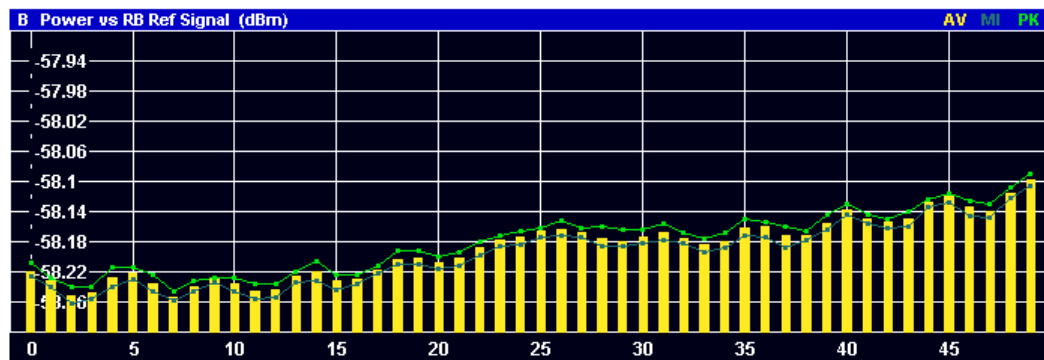

Remote command:

Selection: `CALCulate<n>:FEED 'SPEC:PVRR'`

Query (y-axis): `TRACe:DATA?`

### 5.4.2.2 Flatness (Flat | Grdel | Diff)

#### Channel Flatness

The "Channel Flatness" shows the relative power offset caused by the transmit channel.

The currently selected subframe depends on your [selection](#).

The x-axis represents the frequency. On the y-axis, the channel flatness is plotted in dB.



Remote command:

Selection: `CALCulate<n>:FEED 'SPEC:FLAT'`

Query (y-axis): `TRACe:DATA?`

#### Group Delay

This "Group Delay" shows the group delay of each subcarrier.

The measurement is evaluated over the currently selected slot in the currently selected subframe.

The currently selected subframe depends on your [selection](#).

The x-axis represents the frequency. On the y-axis, the group delay is plotted in ns.

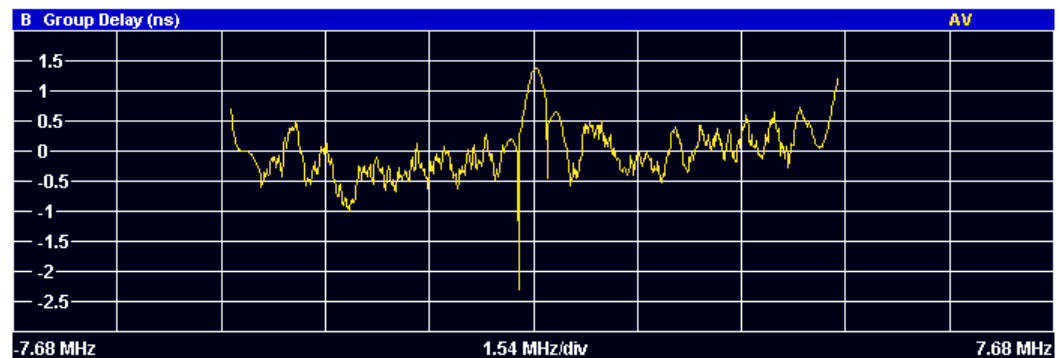

Remote command:

Selection: `CALCulate<n>:FEED 'SPEC:GDEL'`

Query (y-axis): `TRACe:DATA?`

**Channel Flatness Difference**

The "Channel Flatness Difference" shows the level difference in the spectrum flatness result between two adjacent physical subcarriers.

The currently selected subframe depends on your [selection](#).

The x-axis represents the frequency. On the y-axis, the power is plotted in dB.

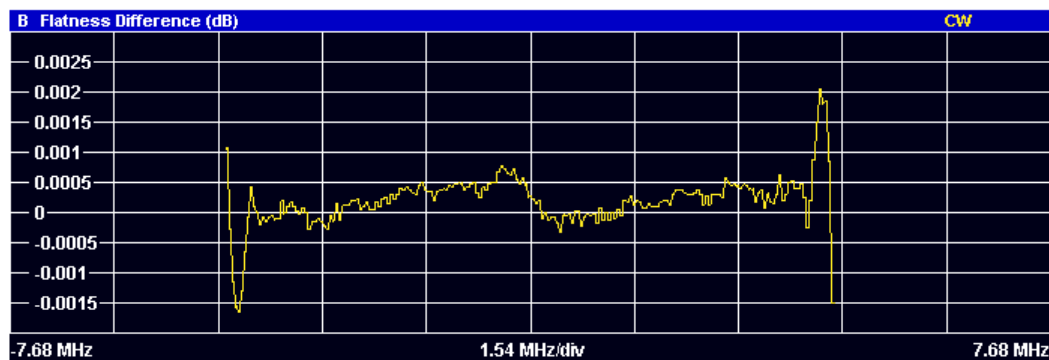

Remote command:

Selection: `CALCulate<n>:FEED 'SPEC:FDIF'`

Query (y-axis): `TRACe:DATA?`

## 5.5 Measuring the Symbol Constellation

This chapter contains information on all measurements that show the constellation of a signal.

[Constellation Diagram](#).....53

**Constellation Diagram**

The "Constellation Diagram" shows the in-phase and quadrature phase results and is an indicator of the quality of the modulation of the signal.

In the default state, the result display evaluates the full range of the measured input data.

The ideal points for the selected modulation scheme are displayed for reference purposes.

Each color represents a modulation type.

- █: BPSK
- █: RBPSK
- █: MIXTURE
- █: QPSK
- █: 16QAM
- █: 64QAM
- █: 256QAM

- █: 1024QAM
- █: PSK (CAZAC)

You can filter the results by changing the [evaluation range](#).

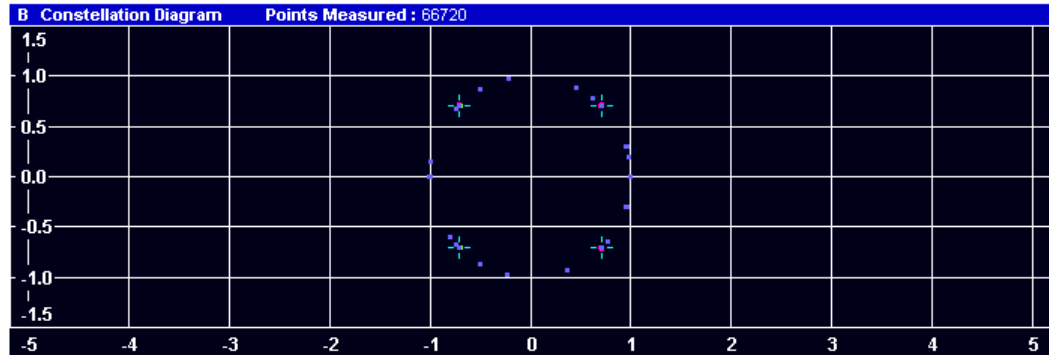

The constellation diagram also contains information about the current [evaluation range](#), including the number of points that are displayed in the diagram.

Remote command:

Selection: `CALCulate<n>:FEED 'CONS:CONS'`

Query: `TRACe:DATA?`

## 5.6 Measuring Statistics

This chapter contains information on all measurements that show the statistics of a signal.

<a href="#">CCDF</a> .....	54
<a href="#">Allocation Summary</a> .....	55
<a href="#">Bitstream</a> .....	55

### CCDF

The "Complementary Cumulative Distribution Function (CCDF)" shows the probability of an amplitude exceeding the mean power. For the measurement, the complete capture buffer is used.

The x-axis represents the power relative to the measured mean power. On the y-axis, the probability is plotted in %.

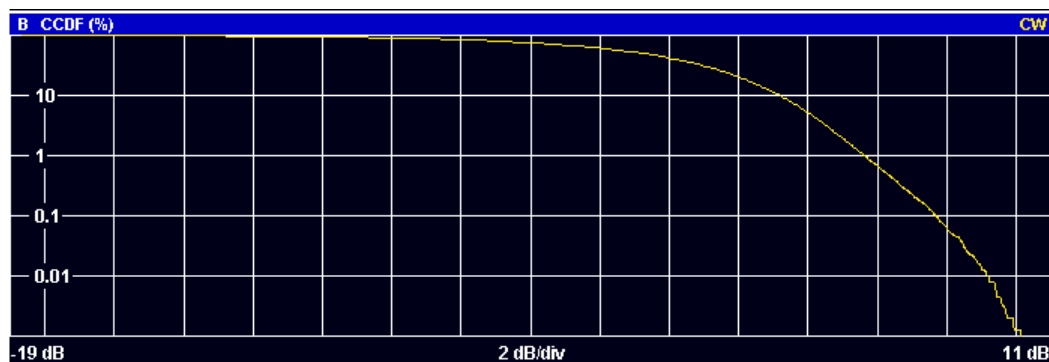

Remote command:

Selection: `CALCulate<n>:FEED 'STAT:CCDF'`

Query (y-axis): `TRACe:DATA?`

### Allocation Summary

The "Allocation Summary" shows various parameters of the measured allocations in a table.

Each row in the allocation table corresponds to an allocation. A set of several allocations make up a subframe. A horizontal line indicates the beginning of a new subframe.

Special allocations summarize the characteristics of all allocations in a subframe ("ALL") and the complete frame (allocation "ALL" at the end of the table).

B Allocation Summary						
Sub-frame	Allocation ID	Number of RB	Rel. Power/dB	Modulation	Power per RE [dBm]	EVM [%]
0	RS Ant1		0.000	QPSK	-58.081	0.328
	S-SYNC		0.005	RBPSK	-58.054	0.349
	PBCH		0.003	QPSK	-58.059	0.330
	PCFICH		-0.003	QPSK	-58.112	0.364
	PHICH		0.000	MIXTURE	-58.131	0.333
	PDCCH		-0.001	QPSK	-58.079	0.375
	PDSCH 0	50	0.000	QPSK	-58.081	0.348
	ALL	50				0.350
-----						
1	RS Ant1		0.000	QPSK	-58.084	0.330
	P-SYNC		0.002	CAZAC	-58.059	0.372

The columns of the table show the following properties for each allocation.

- The location of the allocation (subframe number).
- The ID of the allocation (channel type).
- Number of resource blocks used by the allocation.
- The relative power of the allocation in dB.

The R&S FSV/FSV does not calculate the **PHICH power** if you turn on **boosting estimation**.

- The modulation of the allocation.
- The power of each resource element in the allocation in dBm.
- The EVM of the allocation.

The unit depends on the **EVM unit**

Click **once** on the header row to open a dialog box that allows you to add and remove columns.

Remote command:

Selection: `CALCulate<n>:FEED 'STAT:ASUM'`

Query: `TRACe:DATA?`

### Bitstream

The "Bitstream" shows the demodulated data stream for the data allocations.

Depending on the **bitstream format**, the numbers represent either bits (bit order) or symbols (symbol order).

For the bit format, each number represents one raw bit. For the symbol format, the bits that belong to one symbol are shown as hexadecimal numbers with two digits.

Resource elements that do not contain data or are not part of the transmission are represented by a "-".

If a symbol could not be decoded because the number of layers exceeds the number of receive antennas, the application shows a "#" sign.

B Bit Stream						
Sub-frame	Allocation ID	Code-word	Modulation	Symbol Index	Bit Stream	
0	PBCH	1/1	QPSK	0	02 00 00 00 01 00 00 02 00 03 00 00 02 01 03 00	
0	PBCH	1/1	QPSK	16	02 02 02 03 00 00 03 01 03 02 02 01 02 03 02 01	
0	PBCH	1/1	QPSK	32	00 01 01 00 00 02 02 03 01 00 03 03 03 01 02 01	
0	PBCH	1/1	QPSK	48	00 02 01 01 02 03 03 03 00 02 01 02 02 02 01 02	
0	PBCH	1/1	QPSK	64	01 02 00 00 00 03 00 01 02 01 01 00 01 02 02 01	
0	PBCH	1/1	QPSK	80	01 03 03 03 01 00 01 01 02 00 03 02 02 03 00 02	
0	PBCH	1/1	QPSK	96	03 00 03 03 00 01 03 03 01 03 01 00 00 01 02 02	
0	PBCH	1/1	QPSK	112	03 01 02 03 02 03 00 00 01 01 02 02 03 03 02 02	
0	PBCH	1/1	QPSK	128	02 02 02 00 00 01 01 00 02 02 03 03 00 02 03 02	
0	PBCH	1/1	QPSK	144	03 02 00 00 01 03 00 03 02 02 01 00 03 03 01 01	
0	PBCH	1/1	QPSK	160	03 01 01 00 01 00 02 00 01 02 01 03 00 00 02 03	

The table contains the following information:

- **Subframe**  
Number of the subframe the bits belong to.
- **Allocation ID**  
Channel the bits belong to.
- **Codeword**  
Code word of the allocation.
- **Modulation**  
Modulation type of the channels.
- **Symbol Index or Bit Index**  
Indicates the position of the table row's first bit or symbol within the complete stream.
- **Bit Stream**  
The actual bit stream.

Remote command:

Selection: `CALCulate<n>:FEED 'STAT:BSTR'`

Query: `TRACe:DATA?`

## 5.7 3GPP Test Scenarios

3GPP defines several test scenarios for measuring base stations. These test scenarios are described in detail in 3GPP TS 36.141.

The following table provides an overview which measurements available in the LTE application are suited to use for the test scenarios in the 3GPP documents.

*Table 5-1: Test scenarios for E-TMs as defined by 3GPP (3GPP TS 36.141)*

Test Model	Test scenario	Test described in	Measurement
E-TM1.1	Base station output power	chapter 6.2	Power (→ "Result Summary")
	Transmit on/off power	chapter 6.4	On/Off Power
	DL RS power	chapter 6.5.4	RSTP (→ "Result Summary")



Test Model	Test scenario	Test described in	Measurement
	Time alignment	chapter 6.5.3	Time alignment error
	Transmitter intermodulation	chapter 6.7	ACLR
	Occupied bandwidth	chapter 6.6.1	Occupied bandwidth <sup>1</sup>
	ACLR	chapter 6.6.2	ACLR
	Operating band unwanted emissions	chapter 6.6.3	Spectrum emission mask
	Transmitter spurious emissions	chapter 6.6.4	Spurious emissions <sup>1</sup>
<b>E-TM1.2</b>	ACLR	chapter 6.6.2	ACLR
	Operating band unwanted emissions	chapter 6.6.2	Spectrum emission mask
<b>E-TM2</b>	RE power control dynamic range	chapter 6.3.1	Power results
	Frequency error	chapter 6.5.1	Frequency Error (→ "Result Summary")
	Total power dynamic range	chapter 6.3.2	OSTP (→ "Result Summary")
	Error vector magnitude	chapter 6.5.2	EVM results
<b>E-TM2a</b>	Total power dynamic range	chapter 6.3.2	OSTP (→ "Result Summary")
	Error vector magnitude	chapter 6.5.2	EVM results
	Frequency error	chapter 6.5.1	Frequency error (→ "Result Summary")
<b>E-TM3.1</b>	RE power control dynamic range	chapter 6.3.1	Power results
	Total power dynamic range	chapter 6.3.2	OSTP (→ "Result Summary")
	Frequency error	chapter 6.5.1	Frequency error (→ "Result Summary")
	Error vector magnitude	chapter 6.5.2	EVM results
<b>E-TM3.1a</b>	Total power dynamic range	chapter 6.3.2	OSTP (→ "Result Summary")
	Error vector magnitude	chapter 6.5.2	EVM results
	Frequency error	chapter 6.5.1	Frequency error (→ "Result Summary")
<b>E-TM3.2</b>	RE power control dynamic range	chapter 6.3.1	Power results
	Frequency error	chapter 6.5.1	Frequency error (→ "Result Summary")
	Error vector magnitude	chapter 6.5.2	EVM results
<b>E-TM3.3</b>	RE power control dynamic range	chapter 6.3.1	Power results

Test Model	Test scenario	Test described in	Measurement
	Frequency error	chapter 6.5.1	Frequency error (→ "Result Summary")
	Error vector magnitude	chapter 6.5.2	EVM results

<sup>1</sup>these measurements are available in the spectrum application of the Rohde & Schwarz signal and spectrum analyzers (for example the R&S FSW)

## 6 Configuring and Performing the Measurement

Before you can start a measurement, you have to configure the R&S FSVA/FSV in order to get valid measurement results. This chapter contains detailed information on all settings available in the application.

You can access the two main settings dialog boxes via the "Settings (Gen Demod)" softkey. Pressing the softkey once opens the "General Settings" dialog box. The "Gen" label in the softkey turns orange to indicate an active "General Settings" dialog box. Pressing the softkey again opens the "Demod Settings" dialog box. When the "Demod Settings" dialog box is active, the "Demod" label in the softkey turns orange.

In the "General Settings" dialog box, you can set all parameters that are related to the overall measurement. The dialog box is made up of three tabs, one for general settings, one for MIMO settings and one for advanced settings. By default, the "General" tab is the active one.

In the "Demod Settings" dialog box you can set up the measurement in detail, e.g. the demodulation configuration. The dialog box is made up of three tabs, one for configuring the signal configuration, one for setting up the frame configuration and one for configuring the control channels and miscellaneous settings. By default, the "DL Demod" tab is the active one.

You can switch between the tabs by touching the tab on the touchscreen or with the cursor keys.

- [Performing Measurements](#).....59
- [Defining General Measurement Characteristics](#).....60
- [Configuring MIMO Setups](#).....67
- [Configuring Spectrum Measurements](#).....68
- [Defining Advanced Measurement Characteristics](#).....72
- [Configuring the Signal Demodulation](#).....75
- [Configuring Downlink Frames](#).....80
- [Defining Advanced Signal Characteristics](#).....85

### 6.1 Performing Measurements

**Access:** [SWEEP]

The sweep menu contains functions that control the way the R&S FSVA/FSV performs a measurement.

- [Single Sweep and Continuous Sweep](#).....60
- [Auto Level](#).....60
- [Refresh](#).....60
- [Adjust Timing](#).....60

**Single Sweep and Continuous Sweep**

In continuous sweep mode, the R&S FSVA/FSV continuously captures data, performs measurements and updates the result display according to the trigger settings.

To activate single sweep mode, press the "Run Single" softkey. In single sweep mode, the R&S FSVA/FSV captures data, performs the measurement and updates the result display exactly once after the trigger event. After this process, the R&S FSVA/FSV interrupts the measurement.

You can always switch back to continuous sweep mode with the "Run Cont" softkey.

Remote command:

`INITiate:CONTinuous` on page 111

**Auto Level**

The "Auto Level" softkey initiates a process that sets an ideal reference level for the current measurement.

For more information, see "Reference Level" on page 63.

Remote command:

`[SENSe:]POWer:AUTO[:STATe]` on page 142

**Refresh**

Updates the current result display in single sweep mode without capturing I/Q data again.

If you have changed any settings after a single sweep and use the Refresh function, the R&S FSVA/FSV updates the current measurement results regarding the new settings. It does not capture I/Q data again but uses the data captured last.

Remote command:

`INITiate:REFresh` on page 112

**Adjust Timing**

Adjusts the timing when you measure the Transmit On/Off Power.

For more information, see "Measuring the on / off power" on page 33.

Adjust timing is available for measurements with an external trigger.

Remote command:

`[SENSe:] [LTE:] OOPower:ATIMing` on page 112

## 6.2 Defining General Measurement Characteristics

The "General Settings" contain settings to describe the basic measurement configuration.

- [Defining Signal Characteristics](#)..... 61
- [Configuring the Input Level](#)..... 62
- [Configuring the Data Capture](#)..... 64
- [Configuring On/Off Power Measurements](#)..... 65
- [Triggering Measurements](#)..... 66

## 6.2.1 Defining Signal Characteristics

The general signal characteristics contain settings to describe the general physical attributes of the signal.

The signal characteristics are part of the "General" tab of the "General Settings" dialog box.

General	MIMO	Advanced	Trigger	Spectrum
<b>Signal Characteristics</b>				
Standard	3GPP LTE TDD Downl ▾			
Frequency	1.8 GHz			
Channel Bandwidth <i>BW</i>	10 MHz			
Number of RB	50			
FFT Size <i>N<sub>FFT</sub></i>	1024			
Sampling Rate	15.36 MHz			
Cyclic Prefix	Auto			

Selecting the LTE mode.....	61
Signal Frequency.....	61
L Center Frequency.....	62
Channel Bandwidth / Number of Resource Blocks.....	62
Cyclic Prefix.....	62

### Selecting the LTE mode

The "Mode" selects the LTE standard you are testing.

The choices you have depend on the set of options you have installed.

- Option xxx-K100 enables testing of 3GPP LTE FDD signals on the downlink
- Option xxx-K101 enables testing of 3GPP LTE FDD signals on the uplink
- Option xxx-K102 enables testing of 3GPP LTE MIMO signals on the downlink
- Option xxx-K104 enables testing of 3GPP LTE TDD signals on the downlink
- Option xxx-K105 enables testing of 3GPP LTE TDD signals on the uplink

FDD and TDD are **duplexing** methods.

- FDD mode uses different frequencies for the uplink and the downlink.
- TDD mode uses the same frequency for the uplink and the downlink.

Downlink (DL) and Uplink (UL) describe the **transmission path**.

- Downlink is the transmission path from the base station to the user equipment.  
The physical layer mode for the downlink is always OFDMA.
- Uplink is the transmission path from the user equipment to the base station.  
The physical layer mode for the uplink is always SC-FDMA.

Remote command:

Link direction: `CONFigure[:LTE]:LDIRection` on page 139

Duplexing mode: `CONFigure[:LTE]:DUPLexing` on page 138

### Signal Frequency

For measurements with an RF input source, you have to match the **center frequency** of the analyzer to the frequency of the signal.

**Center Frequency ← Signal Frequency**

Defines the center frequency of the signal and thus the frequency the R&S FSV/FSA tunes to.

The frequency range depends on the hardware configuration of the analyzer you are using.

Remote command:

Center frequency: `[SENSe:] FREQuency:CENTer [:CC<cc>]` on page 139

**Channel Bandwidth / Number of Resource Blocks**

Specifies the channel bandwidth and number of resource blocks (RB).

The channel bandwidth and number of resource blocks (RB) are interdependent. Currently, the LTE standard recommends six bandwidths (see table below).

The application also calculates the FFT size and sampling rate from the channel bandwidth. Those are read only.

Channel Bandwidth [MHz]	1.4	3	5	10	15	20
Number of Resource Blocks	6	15	25	50	75	100
Sample Rate [MHz]	1.92	3.84	7.68	15.36	30.72	30.72
FFT Size	128	256	512	1024	2048	2048

Remote command:

`CONFigure[:LTE]:DL[:CC<cc>]:BW` on page 137

**Cyclic Prefix**

The cyclic prefix serves as a guard interval between OFDM symbols to avoid interferences. The standard specifies two cyclic prefix modes with a different length each.

The cyclic prefix mode defines the number of OFDM symbols in a slot.

- Normal  
A slot contains 7 OFDM symbols.
- Extended  
A slot contains 6 OFDM symbols.  
The extended cyclic prefix is able to cover larger cell sizes with higher delay spread of the radio channel.
- Auto  
The application automatically detects the cyclic prefix mode in use.

Remote command:

`CONFigure[:LTE]:DL[:CC<cc>]:CYCPrefix` on page 138

**6.2.2 Configuring the Input Level**

The level settings contain settings that control the input level of the analyzer.

The level settings are part of the "General" tab of the "General Settings" dialog box.

General	Advanced	Trigger	Spectrum
<b>Level Settings</b>			
Ref. Level (RF)	Auto Level <input checked="" type="checkbox"/>	-10 dBm	
Ext Att	0 dB		

Reference Level.....	63
L Auto Level.....	63
Attenuating the Signal.....	63
L External Attenuation.....	64
L RF Attenuation.....	64

### Reference Level

The reference level is the power level the analyzer expects at the RF input. Keep in mind that the power level at the RF input is the peak envelope power for signals with a high crest factor like LTE.

To get the best dynamic range, you have to set the reference level as low as possible. At the same time, make sure that the maximum signal level does not exceed the reference level. If it does, it will overload the A/D converter, regardless of the signal power. Measurement results can deteriorate (e.g. EVM), especially for measurements with more than one active channel near the one you are trying to measure ( $\pm 6$  MHz).

Note that the signal level at the A/D converter can be stronger than the level the application displays, depending on the current resolution bandwidth. This is because the resolution bandwidths are implemented digitally after the A/D converter.

The reference level is a value in dBm.

Remote command:

Reference level: `DISPlay[:WINDow<n>]:TRACe<t>:Y[:SCALE]:RLEVel`  
on page 139

### Auto Level ← Reference Level

Automatically determines the ideal reference level. The automatic leveling process measures the signal and defines the ideal reference signal for the measured signal.

Automatic level detection also optimizes RF attenuation.

Auto leveling slightly increases the measurement time, because of the extra leveling measurement prior to each sweep. By default, the R&S FSVA/FSV automatically defines the time for auto leveling, but you can also define it manually ("Auto Leveling Track Time").

Remote command:

Automatic: `[SENSe:]POWer:AUTO[:STATe]` on page 142

Auto Level Track Time: `[SENSe:]POWer:AUTO:TIME` on page 142

### Attenuating the Signal

Attenuation of the signal becomes necessary if you have to reduce the power of the signal that you have applied. Power reduction is necessary, for example, to prevent an overload of the input mixer.

For a comprehensive information about signal attenuation, refer to the user manual of the R&S FSVA/FSV.

The LTE measurement application provides several attenuation modes.

**External Attenuation ← Attenuating the Signal**

External attenuation controls an external attenuator if you are using one.

Remote command:

`DISPlay[:WINDow<n>]:TRACe<t>:Y[:SCALe]:RLEVel:OFFSet` on page 140

**RF Attenuation ← Attenuating the Signal**

Controls the RF (or mechanical) attenuator at the RF input.

If you select automatic signal attenuation, the attenuation level is coupled to the reference level.

If you select manual signal attenuation, you can define an arbitrary attenuation (within the supported value range).

Positive values correspond to signal attenuation and negative values correspond to signal gain.

Remote command:

Level: `INPut<ip>:ATTenuation<ant>` on page 140

**6.2.3 Configuring the Data Capture**

The data capture settings contain settings that control the amount of data and the way that the application records the LTE signal.

The data capture settings are part of the "General" tab of the "General Settings" dialog box.

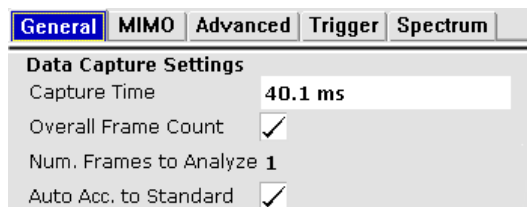

[Capture Time](#)..... 64  
[Overall Frame Count](#)..... 64  
[Number of Frames to Analyze](#)..... 65  
[Auto According to Standard](#)..... 65

**Capture Time**

The "Capture Time" corresponds to the time of one measurement. Therefore, it defines the amount of data the application captures during a single measurement (or sweep).

By default, the application captures 20.1 ms of data to make sure that at least one complete LTE frame is captured in the measurement.

Remote command:

`[SENSe:]SWEep:TIME` on page 143

**Overall Frame Count**

The "Overall Frame Count" turns the manual selection of the number of frames to capture (and analyze) on and off.



When you turn on the overall frame count, you can define the [number of frames to capture and analyze](#). The measurement runs until all frames have been analyzed, even if it takes more than one capture.

The results are an average of the captured frames.

When you turn off the overall frame count, the application analyzes all LTE frames found in one capture buffer.

The overall frame count is always off when you measure component carrier signals.

Remote command:

[\[SENSe:\] \[LTE:\] FRAMe:COUNT:STATe](#) on page 143

**Number of Frames to Analyze**

Defines the number of frames you want to capture and analyze.

If the number of frames you have set last longer than a [single measurement](#), the application continues the measurement until all frames have been captured.

The parameter is read only in the following cases:

- If you turn off the [overall frame count](#).
- If you capture the data [according to the standard](#).

Remote command:

[\[SENSe:\] \[LTE:\] FRAMe:COUNT](#) on page 142

**Auto According to Standard**

Turns automatic selection of the number of frames to capture and analyze on and off.

When you turn on this feature, the R&S FSVA/FSV captures and evaluates a number of frames the 3GPP standard specifies for EVM tests.

If you want to analyze an arbitrary number of frames, turn off the feature.

This parameter is not available when the overall frame count is inactive.

Remote command:

[\[SENSe:\] \[LTE:\] FRAMe:COUNT:AUTO](#) on page 143

**6.2.4 Configuring On/Off Power Measurements**

The On/Off power measurement settings define characteristics of On/Off power measurements.

The On/Off measurement settings are part of the "General" tab of the "General Settings" dialog box.

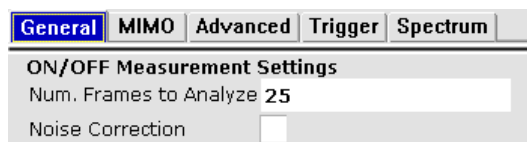

[Number of Frames](#)..... 66  
[Noise Correction](#)..... 66

**Number of Frames**

Defines the number of frames that are averaged to calculate a reliable power trace for On/Off Power measurements.

Remote command:

[CONFigure\[:LTE\]:OOPower:NFRames](#) on page 144

**Noise Correction**

Turns noise correction for on / off power measurements on and off.

Remote command:

[\[SENSe:\] \[LTE:\]OOPower:NCORrection](#) on page 144

**6.2.5 Triggering Measurements**

The trigger settings contain settings that control triggered measurements.

The trigger settings are part of the "Trigger" tab of the "General Settings" dialog box.

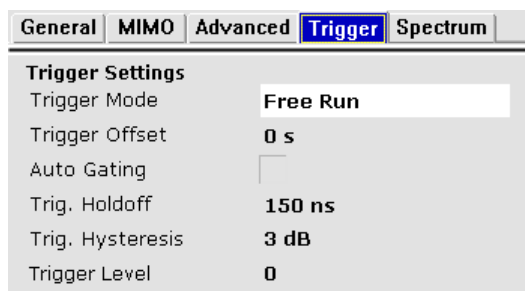

For more information also see [Auto Gating](#) in the "Spectrum" tab of the "General Settings" dialog box.

[Configuring the Trigger](#).....66

    L [Trigger Source](#)..... 66

    L [Trigger Characteristics](#).....67

**Configuring the Trigger**

Triggered measurements allow you to capture those parts of the signal that you are really interested in. While the measurement runs freely and analyzes all signal data, no matter if the signal contains information or not, a trigger initiates a measurement only under certain circumstances (the trigger event).

For a detailed description of the trigger parameters, see the user manual of the I/Q analyzer.

**Trigger Source ← Configuring the Trigger**

The trigger mode, or trigger source, selects the type of event that initiates a measurement. The R&S FSV-A/FSV supports the following trigger sources.

- **Free Run**  
Starts the measurement immediately and measures continuously.
- **External**  
The trigger event is the level of an external trigger signal. The measurement starts when this signal meets or exceeds a specified trigger level at the trigger input.

- **IF Power**  
The trigger event is the level of the intermediate frequency (IF). The measurement starts when the level of the IF meets or exceeds the trigger level.
- **RF Power**  
The trigger event is the level measured at the RF input. The measurement starts when the level of the signal meets or exceeds the trigger level.
- **Power Sensor**  
The trigger event is a specified level measured by a power sensor. The measurement starts when a power sensor measurement meets certain conditions.  
The power sensor as a trigger source is available with option R&S FSV-K9 and a connected power sensor.

Remote command:

`TRIGger [:SEquence] :MODE<ant>` on page 150

### Trigger Characteristics ← Configuring the Trigger

For all trigger sources, except "Free Run", you can define several trigger characteristics.

- The trigger "Level" defines the signal level that initiates the measurement. (The input field to define the trigger level opens when you select the external trigger source.)
- The trigger "Offset" is the time that must pass between the trigger event and the start of the measurement. This can be a negative value (a pretrigger).
- The trigger "Slope" defines whether triggering occurs when the signal rises to the trigger level or falls down to it.
- The trigger "Holdoff" defines a time period that must at least pass between one trigger event and the next.
- The trigger "Hysteresis" is available for the IF power trigger. It defines a distance to the trigger level that the input signal must stay below to fulfill the trigger condition.

Remote command:

Level (external): `TRIGger [:SEquence] :LEVel<ant> [:EXTernal<tp>]`

on page 149

Level (IF power): `TRIGger [:SEquence] :LEVel<ant> :POWer` on page 150

Level (RF power): `TRIGger [:SEquence] :LEVel<ant> :RFPower` on page 150

Offset: `TRIGger [:SEquence] :HOLDoFF<ant> [:TIME]` on page 148

Hysteresis: `TRIGger [:SEquence] :IFPower :HYSTeresis` on page 149

Holdoff: `TRIGger [:SEquence] :IFPower :HOLDoFF` on page 149

## 6.3 Configuring MIMO Setups

MIMO measurements need a special setup that you can configure with the settings available in the MIMO configuration dialog box.

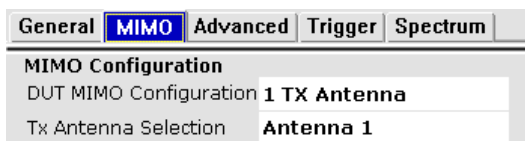

DUT MIMO Configuration.....68  
 Tx Antenna Selection..... 68

**DUT MIMO Configuration**

The "DUT MIMO Configuration" selects the number of antennas in the system you are analyzing.

The number of antennas corresponds to the number of cell-specific reference signals.

The R&S FSVA/FSV supports measurements on one, two or four antennas.

Remote command:

[CONFigure\[:LTE\]:DL\[:CC<cc>\]:MIMO:CONFig](#) on page 145

**Tx Antenna Selection**

The "Tx Antenna Selection" selects the antenna(s) you want to analyze. The number of menu items depends on the [number of antennas](#) in the system.

Each antenna corresponds to a cell-specific reference signal.

For automatic detection, the R&S FSVA/FSV analyzes the reference signal to select the antenna. It also determines the order in which the antennas are tested.

Antenna 1	Tests antenna 1 only.
Antenna 2	Tests antenna 2 only.
Antenna 3	Tests antenna 3 only.
Antenna 4	Tests antenna 4 only.
Auto	Analyzes the reference signal to select the correct antenna.

Remote command:

[CONFigure\[:LTE\]:DL\[:CC<cc>\]:MIMO:ASElection](#) on page 144

## 6.4 Configuring Spectrum Measurements

The Spectrum settings contain parameters to configure spectrum measurements (ACLR and SEM) in particular.

- [General ACLR and SEM Configuration](#).....69
- [Configuring SEM Measurements](#)..... 69
- [Configuring ACLR Measurements](#)..... 71

### 6.4.1 General ACLR and SEM Configuration

The gate settings settings are part of the "Spectrum" tab of the "General Settings" dialog box.



Auto Gating..... 69  
 Span..... 69

#### Auto Gating

Turns gating for SEM and ACLR measurements on and off.

If on, the application evaluates the on-periods of an LTE TDD signal only. The application determines the location and length of the on-period from the "TDD UL/DL Allocations" and the "Configuration of the Special Subframe".

Note that the automatic cyclic prefix mode detection is not supported if you have turned on Auto Gating. In that case, you have to select the cyclic prefix mode manually.

Auto gating is available for TDD measurements in combination with an external or IF power trigger.

If you are using an external trigger, the DUT has to send an LTE frame trigger.

Remote command:

[SENSe:] SWEep:EGATe:AUTO on page 156

#### Span

Defines the frequency span that is displayed in the frequency sweep result displays (SEM and ACLR).

When the "Auto Span" is on, the application automatically calculates the ideal span for the measured signal. The ideal span for the signal depends on the [channel bandwidth](#) that you have selected.

Alternatively, you can define the span manually when you turn the "Auto Span" off. When you define the span manually, you can enter any number that is greater than the span that would be calculated automatically. This mechanism makes sure that the span is not too small for the signal bandwidth and the complete signal is displayed.

Note that changing the span only takes effect when you start a new measurement after you have changed the span.

Remote command:

[SENSe]: FREQuency: SPAN: AUTO on page 152

[SENSe]: FREQuency: SPAN on page 152

### 6.4.2 Configuring SEM Measurements

The SEM settings are part of the "Spectrum" tab of the "General Settings" dialog box.

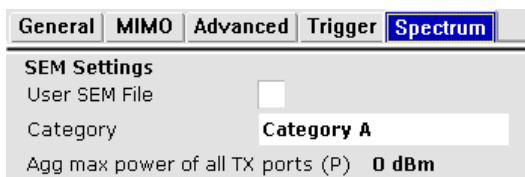

User SEM File..... 70  
 Category..... 70  
 Aggregated Maximum Power Of All TX Ports (P)..... 71  
 Tx Power..... 71

**User SEM File**

Turns the evaluation of a custom Spectrum Emission Mask (SEM) on and off.

When you turn the feature on, the application tests the signal against a custom SEM instead of the SEM that complies to the standard.

To use a custom SEM, you have to design one in the Spectrum application and then import it in the LTE application with the "Load SEM File" softkey available in the "File" menu.

- ▶ Press the MEAS key.
- ▶ Press the "File Manager" softkey.
- ▶ Press the "Load SEM file" softkey and select the required SEM from the file manager.
- ▶ Turn on the "User SEM File" feature in the "General Settings" dialog box.

The R&S FSVA/FSV evaluates the custom SEM mask.

For a comprehensive description about designing a custom SEM in xml format, please refer to the User Manual of the R&S FSVA/FSV.

Remote command:

Load file: `MMEMory:LOAD:SEMsettings` on page 151

State: `[SENSe:]POWer:SEM:USERfile` on page 155

**Category**

Selects the type and category and option of the limit definitions for SEM measurements.

The software supports limit definitions for the following types of base stations:

- Wide areas base stations (category A and B)
- Local area base stations
- Home base stations
- Medium range base stations

Categories A and B are defined in ITU-R recommendation SM.329. For category B operating band unwanted emissions, there are two options for the limits that can be applied regionally (Opt1 and Opt2).

The type and category you should use for the measurement depends on the category and option that the base station you are testing supports.

For home area base stations, you can define an additional [Aggregated Maximum Power Of All TX Ports \(P\)](#) for all antenna ports of a home area base station. The aggregated maximum power is the aggregated power of all antenna ports and defines the shape of the SEM.

For medium range base station, you can automatically measure or manually enter the power of the carrier [Tx Power](#).

Remote command:

[\[SENSe:\]POWer:SEM:CATegory](#) on page 154

Home BS power: [\[SENSe:\]POWer:SEM:CHBS:AMPower](#) on page 155

Medium BS power mode: [\[SENSe:\]POWer:SEM:CHBS:AMPower:AUTO](#) on page 155

Medium BS power value: [\[SENSe:\]POWer:SEM:CHBS:AMPower](#) on page 155

### Aggregated Maximum Power Of All TX Ports (P)

Defines the aggregated maximum power of all TX ports of home base stations. The aggregate maximum power is required to calculate limit line values for SEM measurements on home base stations.

The parameter is available only if you have selected [SEM Category](#) "Home".

Remote command:

[\[SENSe:\]POWer:SEM:CHBS:AMPower](#) on page 155

### Tx Power

Defines the Tx channel power for medium range base stations. The selected channel power has an effect on the shape of the SEM limit line.

You can define the channel power either manually or automatically. For automatic detection, the R&S FSV/FVA measures the power of the transmission channel.

Remote command:

State: [\[SENSe:\]POWer:SEM:CHBS:AMPower:AUTO](#) on page 155

Power: [\[SENSe:\]POWer:SEM:CHBS:AMPower](#) on page 155

## 6.4.3 Configuring ACLR Measurements

The ACLR settings are part of the "Spectrum" tab of the "General Settings" dialog box.

General	MIMO	Advanced	Trigger	Spectrum
<b>ACLR Settings</b>				
Assumed Adj. Ch. Carr.	EUTRA same BW			
Num. of Tx Channels	1			
Tx2 Bandwidth	10 MHz			
Tx2 Offset	10 MHz			
Noise Correction	<input type="checkbox"/>			
Sweep Time	500 ms			

<a href="#">Assumed Adjacent Channel Carrier</a> .....	72
<a href="#">Number of TX Channels</a> .....	72
<a href="#">Noise Correction</a> .....	72
<a href="#">Sweep Time</a> .....	72

**Assumed Adjacent Channel Carrier**

Selects the assumed adjacent channel carrier for the ACLR measurement.

The supported types are EUTRA of same bandwidth, 1.28 Mcps UTRA, 3.84 Mcps UTRA and 7.68 Mcps UTRA.

Note that not all combinations of LTE channel bandwidth settings and assumed adjacent channel carrier settings are defined in the 3GPP standard.

Remote command:

`[SENSe:]POWER:ACHannel:AACHannel` on page 152

**Number of TX Channels**

The application allows you to perform ACLR and SEM measurements on systems that support carrier aggregation.

The number of TX channels defines the number of transmission (TX) channels to include in ACLR measurements.

Measurements on one or two TX channels are supported.

For measurements on two TX channels, you can additionally define the bandwidth of the second TX channel and the distance between the two TX channels.

For the second TX channel, you can select the bandwidths as defined by 3GPP. For more information see "[Channel Bandwidth / Number of Resource Blocks](#)" on page 62.

Remote command:

`[SENSe:]POWER:ACHannel:BANDwidth:CHANnel2` on page 153

`[SENSe:]POWER:ACHannel:SPACing:CHANnel` on page 153

`[SENSe:]POWER:ACHannel:TXChannels:COUNT` on page 154

**Noise Correction**

Turns noise correction on and off.

Note that the input attenuator makes a clicking noise after each sweep if you are using the noise correction in combination with the auto leveling process.

Remote command:

`[SENSe:]POWER:NCORrection` on page 154

**Sweep Time**

Defines a sweep time for ACLR measurements.

A longer sweep time may increase the probability that the measured value converges to the true value of the adjacent channel power, but obviously increases measurement time.

Remote command:

`[SENSe:]SWEep:TIME` on page 143

## 6.5 Defining Advanced Measurement Characteristics

The "Advanced" settings contain parameters to configure more complex measurement setups.



- [Controlling I/Q Data](#).....73
- [Controlling the Input](#).....73
- [Configuring the Digital I/Q Input](#).....74

### 6.5.1 Controlling I/Q Data

The I/Q settings contain settings that control the I/Q data flow.

The I/Q settings are part of the "Advanced Settings" tab of the "General Settings" dialog box.



- [Swap I/Q](#).....73

#### Swap I/Q

Swaps the real (I branch) and the imaginary (Q branch) parts of the signal.

Remote command:

`[SENSe:]SWAPiQ` on page 146

### 6.5.2 Controlling the Input

The input settings contain settings that control the input source.

The input settings are part of the "Advanced Settings" tab of the "General Settings" dialog box.

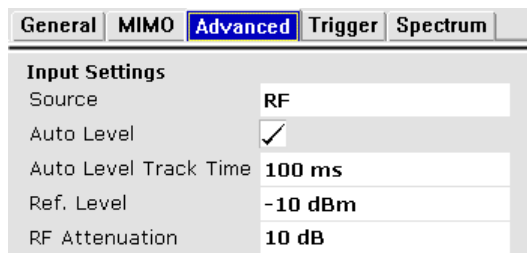

For more information on reference level see "[Reference Level](#)" on page 63.

For more information on signal attenuation see "[Attenuating the Signal](#)" on page 63.

- [Selecting the Input Source](#).....73
- [Yig Filter](#).....74

#### Selecting the Input Source

The input source selects the source of the data you would like to analyze. You can either analyze a live signal or a signal that has been recorded previously and whose characteristics have been saved to a file.

You can select the input source from the "Source" dropdown menu.

- RF

- Captures and analyzes the data from the RF input of the spectrum analyzer in use.
- Baseband (BB)  
Captures and analyzes the data from the baseband input of the spectrum analyzer in use.
- Digital I/Q  
Captures and analyzes the data from the digital baseband input of the spectrum analyzer in use.  
The digital baseband input is available with option R&S FSVA/FSV-B17.

For more information on using hardware option R&S FSVA/FSV-B17, see the manual of the R&S FSVA/FSV.

Remote command:

`INPut<ip>:SElect` on page 146

### Yig Filter

#### R&S FSVA only

Configures the YIG filter.

If you want to measure broadband signals, you can configure the YIG filter for a greater bandwidth.

The process of configuring the YIG filter consists of two steps.

- **Selecting the mode**  
You can select either manual or automatic control of the YIG filter.
- **Selecting the state**  
Turns the YIG filter on and off.  
If inactive, you can use the maximum bandwidth. However, image frequency rejection is no longer ensured.

If you have selected automatic YIG filter control, the R&S FSVA/FSV automatically resolves whether to use the YIG filter or not. Manual selection of the YIG filter state is not available in that case.

Note that the R&S FSVA/FSV uses the YIG filter only for frequencies greater than 3.6 GHz. If the frequency is smaller, these settings have no effect.

Remote command:

`INPut<ip>:FILTer:YIG[:STATe]` on page 147

`INPut<n>:FILTer:YIG:AUTO` on page 146

## 6.5.3 Configuring the Digital I/Q Input

The digital I/Q settings contain settings that configure the digital I/Q input.

The digital I/Q settings are part of the "Advanced Settings" tab of the "General Settings" dialog box.

General	MIMO	Advanced	Trigger	Spectrum
<b>Baseband Digital Settings</b>				
Input Data Rate	10 MHz			
Full Scale Level	1 V			

Sampling Rate (Input Data Rate).....	75
Full Scale Level.....	75

### Sampling Rate (Input Data Rate)

Defines the data sample rate at the digital baseband input.

The sample rate is available for a digital baseband input source.

Remote command:

[INPut<ip>:DIQ:SRATe](#) on page 147

### Full Scale Level

Defines the voltage corresponding to the maximum input value of the digital baseband input.

Remote command:

[INPut<ip>:DIQ:RANGe\[:UPPer\]](#) on page 148

## 6.6 Configuring the Signal Demodulation

The downlink demodulation settings contain settings that describe the signal processing and the way the signal is measured.

You can find the demodulation settings in the "Demod Settings" dialog box.

- [Configuring the Data Analysis](#).....75
- [Compensating Measurement Errors](#).....78
- [Configuring MIMO Setups](#).....79

### 6.6.1 Configuring the Data Analysis

The data analysis settings contain settings that determine the way the captured signal is analyzed.

The data analysis settings are part of the "Downlink Demod" tab of the "Demodulation Settings" dialog box.

DL Demod	DL Frame Config	DL Adv Sig Config
<b>Data Analysis</b>		
Channel Estimation	EVM 3GPP Definition	
EVM Calculation Method	EVM 3GPP Definition	
Coded Bits Scrambling	<input checked="" type="checkbox"/>	
Auto PDSCH Demod	<input checked="" type="checkbox"/>	
PDSCH Subframe Detect	Physical Detection	
Boosting Estimation	<input checked="" type="checkbox"/>	
PDSCH Reference Data	Auto Detect	
Multicarrier Filter	<input type="checkbox"/>	

Channel Estimation..... 76

EVM Calculation Method..... 76

Scrambling of Coded Bits..... 76

Auto PDSCH Demodulation..... 77

PDSCH Subframe Configuration Detection..... 77

Boosting Estimation..... 78

PDSCH Reference Data..... 78

Multicarrier Filter..... 78

**Channel Estimation**

Selects the method of channel estimation.

- **EVM 3GPP Definition**  
Channel estimation according to 3GPP TS 36.141. This method is based on averaging in frequency direction and linear interpolation. Examines the reference signal only.
- **Optimal, Pilot only**  
Optimal channel estimation method. Examines the reference signal only.
- **Optimal, Pilot and Payload**  
Optimal channel estimation method. Examines both the reference signal and the payload resource elements.

Remote command:

```
[SENSe:] [LTE:] DL:DEMod:CESTimation on page 157
```

**EVM Calculation Method**

Selects the method to calculate the EVM.

- **EVM 3GPP Definition**  
Calculation of the EVM according to 3GPP TS 36.141. Evaluates the EVM at two trial timing positions and then uses the maximum EVM of the two.
- **At Optimal Timing Position**  
Calculates the EVM using the optimal timing position.

Remote command:

```
[SENSe:] [LTE:] DL:DEMod:EVMCalc on page 158
```

**Scrambling of Coded Bits**

Turns the scrambling of coded bits for all physical channels like PDSCH on and off. The scrambling of coded bits affects the bitstream results.

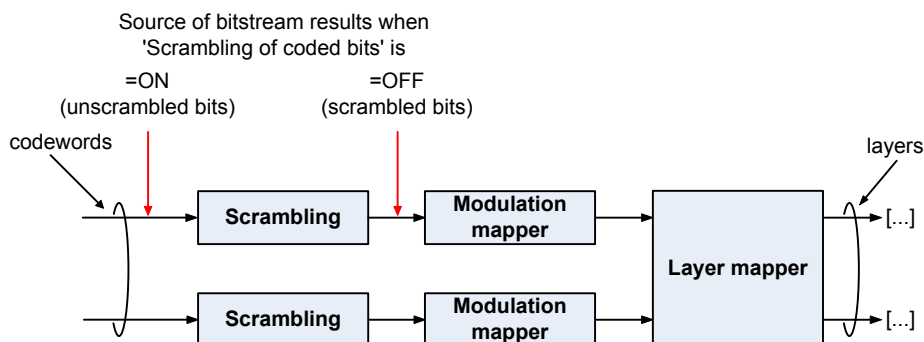

Figure 6-1: Source for bitstream results if scrambling for coded bits is on and off

Remote command:

[\[SENSe:\] \[LTE:\] DL:DEMod:CBSCrambling](#) on page 157

### Auto PDSCH Demodulation

Turns automatic demodulation of the PDSCH on and off.

When you turn on this feature, the application automatically detects the PDSCH resource allocation. This is possible by analyzing the protocol information in the PDCCH or by analyzing the physical signal. The application then writes the results into the [PDSCH Configuration Table](#).

You can set the way the application identifies the PDSCH resource allocation with [PDSCH Subframe Configuration Detection](#).

When you turn off automatic demodulation of the PDSCH, you have to configure the PDSCH manually. In that case, the application compares the demodulated LTE frame to the customized configuration. If the "PDSCH Subframe Configuration Detection" is not turned off, the application analyzes the frame only if both configurations are the same.

Remote command:

[\[SENSe:\] \[LTE:\] DL:DEMod:AUTO](#) on page 156

### PDSCH Subframe Configuration Detection

Selects the method of identifying the PDSCH resource allocation.

- Off  
Uses the user configuration to demodulate the PDSCH subframe. If the user configuration does not match the frame that was measured, a bad EVM will result.
- PDCCH protocol  
Sets the PDSCH configuration according to the data in the protocol of the PDCCH DCIs.
- Physical detection  
The physical detection is based on power and modulation detection. Physical detection makes measurements on TDD E-TMs without a 20 ms trigger signal possible.  
[More information.](#)

Remote command:

[\[SENSe:\] \[LTE:\] DL:FORMat:PSCD](#) on page 158

**Boosting Estimation**

Turns boosting estimation on and off.

Boosting estimation, when you turn it on, automatically sets the relative power settings of all physical channels, the P-Sync and S-Sync by analyzing the signal.

Remote command:

[SENSe:] [LTE:] DL:DEMod:BEStimation on page 157

**PDSCH Reference Data**

Selects the type of reference data to calculate the EVM for the PDSCH.

- Auto detect  
Automatically identifies the reference data for the PDSCH by analyzing the signal.
- All 0 (E-TM)  
Sets the PDSCH reference data to a fixed value of 0. This value is according to the test model definition.  
To get valid results, you have to use a DUT that transmits an all-zero data vector.  
This setting is a good way if you are expecting signals with a high EVM because the automatic detection is not reliable in that case.

Remote command:

[SENSe:] [LTE:] DL:DEMod:PRData on page 158

**Multicarrier Filter**

Turns the suppression of interference of neighboring carriers for tests on multiradio base stations on and off (e.g. LTE, WCDMA, GSM etc.).

Remote command:

[SENSe:] [LTE:] DL:DEMod:MCFilter on page 158

**6.6.2 Compensating Measurement Errors**

The tracking settings contain settings that compensate for various common measurement errors that may occur.

The tracking settings are part of the "Downlink Demod" tab of the "Demodulation Settings" dialog box.

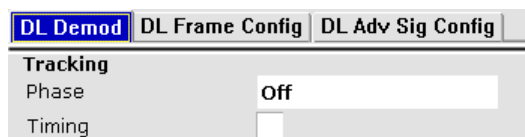

Phase.....78  
Timing.....79

**Phase**

Turns phase tracking on and off.

When you turn on phase tracking, the application compensates the measurement results for the phase error on a symbol level.

"Off" Phase tracking is not applied.

- "Pilot Only" Only the reference signal is used for the estimation of the phase error.
- "Pilot and Payload" Both reference signal and payload resource elements are used for the estimation of the phase error.

Remote command:  
[\[SENSe:\] \[LTE:\] DL:TRACking:PHASe](#) on page 159

**Timing**

Turns timing tracking on and off.  
 When you turn on timing tracking, the application compensates the measurement results for the timing error on a symbol level.

Remote command:  
[\[SENSe:\] \[LTE:\] DL:TRACking:TIME](#) on page 159

**6.6.3 Configuring MIMO Setups**

The MIMO settings contain settings that configure MIMO measurement setups. The MIMO settings are part of the "Downlink Demod" tab of the "Demodulation Settings" dialog box.

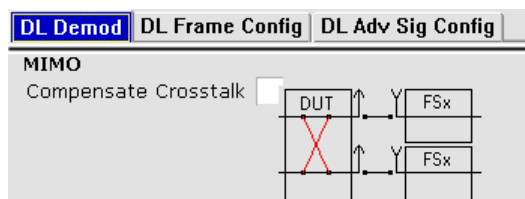

[Compensate Crosstalk](#).....79

**Compensate Crosstalk**

Turns compensation of crosstalk produced by one of the components in the test setup on and off.

Turn on this feature, if you expect crosstalk from the DUT or another component in the test setup. This can become necessary, for example, for over-the-air measurements.

If you connect the DUT to the analyzer by cable, turn off crosstalk compensation. In that case, the only crosstalk results from the DUT itself and contributes as distortion to the measurement results.

Crosstalk compensation must be activated for Time Alignment Error measurements. For more information, see [Chapter 4.4, "Performing Time Alignment Measurements"](#), on page 30.

Remote command:  
[CONFigure\[:LTE\]:DL\[:CC<cc>\]:MIMO:CROSstalk](#) on page 160

## 6.7 Configuring Downlink Frames

The frame configuration contains settings that define the structure of the downlink LTE signal.

You can find the frame structure in the "Demod Settings" dialog box.

- [Configuring TDD Signals](#).....80
- [Configuring the Physical Layer Cell Identity](#).....81
- [PDSCH Subframe Configuration](#).....82

### 6.7.1 Configuring TDD Signals

The TDD settings define the characteristics of an LTE TDD signal.

The TDD settings are part of the "Frame Configuration" tab of the "Demodulation Settings" dialog box.

DL Demod	<b>DL Frame Config</b>	DL Adv Sig Config
<b>TDD Configuration</b>		
TDD UL/DL Allocations	Conf. 0 - DL,S,UL,UL,UL, DL,S,UL,UL,UL	
Conf. Special Subframe	Conf. 0	

- [Configuring TDD Frames](#)..... 80
  - ↳ [TDD UL/DL Allocations](#)..... 80
  - ↳ [Conf. of Special Subframe](#)..... 81

#### Configuring TDD Frames

TDD frames contain both uplink and downlink information separated in time with every subframe being responsible for either uplink or downlink transmission. The standard specifies several subframe configurations or resource allocations for TDD systems.

#### TDD UL/DL Allocations ← Configuring TDD Frames

Selects the configuration of the subframes in a radio frame in TDD systems.

The UL/DL configuration (or allocation) defines the way each subframe is used: for uplink, downlink or if it is a special subframe. The standard specifies seven different configurations.

Configuration	Subframe Number and Usage									
	0	1	2	3	4	5	6	7	8	9
0	D	S	U	U	U	D	S	U	U	U
1	D	S	U	U	D	D	S	U	U	D
2	D	S	U	D	D	D	S	U	D	D
3	D	S	U	U	U	D	D	D	D	D
4	D	S	U	U	D	D	D	D	D	D
5	D	S	U	D	D	D	D	D	D	D
6	D	S	U	U	U	D	S	U	U	D



U = uplink  
 D = downlink  
 S = special subframe

Remote command:

Subframe: `CONFigure[:LTE]:DL[:CC<cc>]:TDD:UDConf` on page 161

**Conf. of Special Subframe ← Configuring TDD Frames**

In combination with the cyclic prefix, the special subframes serve as guard periods for switches from uplink to downlink. They contain three parts or fields.

- DwPTS  
 The DwPTS is the downlink part of the special subframe. It is used to transmit downlink data.
- GP  
 The guard period makes sure that there are no overlaps of up- and downlink signals during a switch.
- UpPTS  
 The UpPTS is the uplink part of the special subframe. It is used to transmit uplink data.

The length of the three fields is variable. This results in several possible configurations of the special subframe. The LTE standard defines 10 different configurations for the special subframe. However, configurations 8 and 9 only work for a normal cyclic prefix.

If you select configurations 8 or 9 using an extended cyclic prefix or automatic detection of the cyclic prefix, the application will show an error message.

Remote command:

Special subframe: `CONFigure[:LTE]:DL[:CC<cc>]:TDD:SPSC` on page 160

**6.7.2 Configuring the Physical Layer Cell Identity**

The physical signal characteristics contain settings to describe the physical attributes of an LTE signal.

The physical settings are part of the "Frame Configuration" tab of the "Demodulation Settings" dialog box.

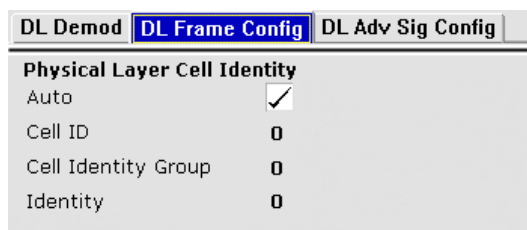

[Configuring the Physical Layer Cell Identity](#).....81

**Configuring the Physical Layer Cell Identity**

The "Cell ID", "Cell Identity Group" and physical layer "Identity" are interdependent parameters. In combination, they are responsible for synchronization between network and user equipment.

The physical layer cell ID identifies a particular radio cell in the LTE network. The cell identities are divided into 168 unique cell identity groups. Each group consists of 3 physical layer identities. According to:

$$N_{ID}^{cell} = 3 \cdot N_{ID}^{(1)} + N_{ID}^{(2)}$$

$N^{(1)}$  = cell identity group, {0...167}

$N^{(2)}$  = physical layer identity, {0...2}

there is a total of 504 different cell IDs.

If you change one of these three parameters, the application automatically updates the other two.

For automatic detection of the cell ID, turn on the "Auto" function.

Before it can establish a connection, the user equipment must synchronize to the radio cell it is in. For this purpose, two synchronization signals are transmitted on the downlink. These two signals are reference signals whose content is defined by the "Physical Layer Identity" and the "Cell Identity Group".

The first signal is one of 3 possible Zadoff-Chu sequences. The sequence that is used is defined by the physical layer identity. It is part of the P-Sync.

The second signal is one of 168 unique sequences. The sequence is defined by the cell identity group. This sequence is part of the S-Sync.

In addition to the synchronization information, the cell ID also determines:

- The cyclic shifts for PCFICH, PHICH and PDCCH mapping,
- The frequency shifts of the reference signal.

Remote command:

Cell ID: `CONFigure[:LTE]:DL[:CC<cc>]:PLC:CID` on page 161

Cell Identity Group (setting): `CONFigure[:LTE]:DL[:CC<cc>]:PLC:CIDGroup` on page 162

Cell Identity Group (query): `FETCh[:CC<cc>]:PLC:CIDGroup?` on page 114

Identity (setting): `CONFigure[:LTE]:DL[:CC<cc>]:PLC:PLID` on page 162

Identity (query): `FETCh[:CC<cc>]:PLC:PLID?` on page 115

### 6.7.3 PDSCH Subframe Configuration

The application allows you to configure individual subframes that are used to carry the information of the PDSCH. The PDSCH (Physical Downlink Shared Channel) primarily carries all general user data. It therefore takes up most of the space in a radio frame.

When you turn on "Auto Demodulation", the application automatically determines the subframe configuration for the PDSCH. In the default state, automatic configuration is on (→ [More information](#)).

DL Demod	DL Frame Config	DL Adv Sig Config
<b>PDSCH Subframe Configuration</b>		
Configurable Subframes	<b>1</b>	
Selected Subframe	<b>0</b>	
Used Allocations	<b>1</b>	
Error in Subframes		

Every LTE frame (FDD and TDD) contains 10 subframes. (In TDD systems, some subframes are used by the uplink, however.) Each downlink subframe consists of one or more (resource) allocations. The application shows the contents for each subframe in the configuration table. In the configuration table, each row corresponds to one allocation.

ID / N_RNTI	Code Word	Modulation	Number of RB	Offset RB	Rho A (Power)/dB	Confl.
0	1/1	QPSK	6	0	0 dB	

If there are any errors or conflicts between allocations in one or more subframes, the application shows the number of errors and the number of the corrupt subframe in the "Error in Subframes" field. It does not show the kind of error.

Before you start to work on the contents of each subframe, you should define the number of subframes you want to customize with the "Configurable Subframes" parameter. The application supports the configuration of up to 40 subframes.

Then you can select a particular subframe that you want to customize in the "Selected Subframe" field. Enter the number of the subframe (starting with 0). The application updates the contents of the configuration table to the selected subframe.

Remote command:

Number of subframes: `CONFigure[:LTE]:DL[:CC<cc>]:CSUBframes`  
on page 163

Number of allocations: `CONFigure[:LTE]:DL[:CC<cc>]:SUBFrame<sf>:ALCount`  
on page 163

- [PDSCH Allocations](#)..... 83

### 6.7.3.1 PDSCH Allocations

In the default state, each subframe contains one allocation. Add allocations with the "Used Allocations" parameter. The application expands the configuration table accordingly with one row representing one allocation. You can define a different number of allocations for each subframe you want to configure and configure up to 110 allocations in every subframe.

The configuration table contains the settings to configure the allocations.

<a href="#">ID/N_RNTI</a> .....	83
<a href="#">Code Word</a> .....	84
<a href="#">Modulation</a> .....	84
<a href="#">Number of RB</a> .....	84
<a href="#">Offset RB</a> .....	84
<a href="#">Power</a> .....	84
<a href="#">Conflict</a> .....	85

#### ID/N\_RNTI

Selects the allocation's ID. The ID corresponds to the N\_RNTI.

By default, the application assigns consecutive numbers starting with 0.

The ID, or N\_RNTI, is the user equipment identifier for the corresponding allocation and is a number in the range from 0 to 65535. The order of the numbers is irrelevant. You can combine allocations by assigning the same number more than once. Combining allocations assigns those allocations to the same user.

Allocations with the same N\_RNTI have the same modulation scheme and power settings.

Remote command:

```
CONFigure[:LTE]:DL[:CC<cc>]:SUBFrame<sf>:ALLoc<al>:UEID
on page 165
```

### Code Word

Shows the code word of the allocation.

The code word is made up out of two numbers. The first number is the number of the code word in the allocation. The second number is the total number of code words that the allocation contains. Thus, a table entry of "1/2" would mean that the row corresponds to code word 1 out of 2 code words in the allocation.

### Modulation

Selects the modulation scheme for the corresponding allocation.

The modulation scheme for the PDSCH is either QPSK, 16QAM, 64QAM, 256QAM or 1024QAM.

Remote command:

```
CONFigure[:LTE]:DL[:CC<cc>]:SUBFrame<sf>:ALLoc<al>[:CW<cw>]:
MODulation on page 163
```

### Number of RB

Defines the number of resource blocks the allocation covers. The number of resource blocks defines the size or bandwidth of the allocation.

If you allocate too many resource blocks compared to the bandwidth you have set, the application shows an error message in the "Conflicts" column and the "Error in Subframes" field.

Remote command:

```
CONFigure[:LTE]:DL[:CC<cc>]:SUBFrame<sf>:ALLoc<al>:RBCount
on page 164
```

### Offset RB

Sets the resource block at which the allocation begins.

A wrong offset for any allocation would lead to an overlap of allocations. In that case, the application shows an error message.

Remote command:

```
CONFigure[:LTE]:DL[:CC<cc>]:SUBFrame<sf>:ALLoc<al>:RBOffset
on page 165
```

### Power

Sets the boosting of the allocation.

Boosting is the allocation's power relative to the reference signal power.

Remote command:

```
CONFigure[:LTE]:DL[:CC<cc>]:SUBFrame<sf>:ALLoc<al>:POWer
```

on page 164

**Conflict**

In case of a conflict, the application shows the type of conflict and the ID of the allocations that are affected. Possible conflicts are:

- bandwidth error (">BW")  
A bandwidth error occurs when the number of resource blocks in the subframe exceeds the bandwidth you have set.

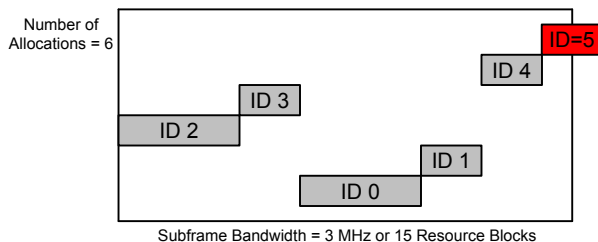

- RB overlap errors  
An RB overlap error occurs if one or more allocations overlap. In that case, check if the length and offset values of the allocations are correct.

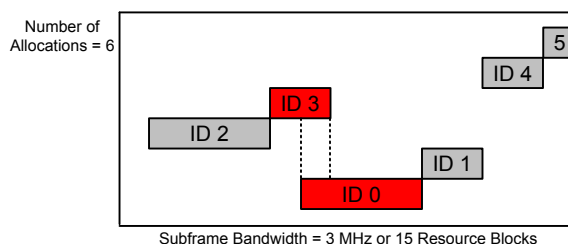

## 6.8 Defining Advanced Signal Characteristics

The downlink advanced signal characteristics contain settings that describe the detailed structure of a downlink LTE signal.

You can find the advanced signal characteristics in the "Demod Settings" dialog box.

- [Defining the PDSCH Resource Block Symbol Offset](#).....85
- [Configuring the Reference Signal](#).....86
- [Configuring the Synchronization Signal](#).....86
- [Configuring the Control Channels](#).....87
- [Configuring the Shared Channel](#).....91

### 6.8.1 Defining the PDSCH Resource Block Symbol Offset

The PDSCH Resource Block (PRB) symbol offset is part of the global settings in the "Downlink Adv Sig Config" tab of the "Demodulation Settings" dialog box.



PRB Symbol Offset..... 86

### PRB Symbol Offset

PRB Symbol Offset specifies the symbol offset of the PDSCH allocations relative to the subframe start. This setting applies to all subframes in a frame.

With this setting, the number of OFDM symbols used for control channels is defined, too. For example, if this parameter is set to "2" and the PDCCH is enabled, the number of OFDM symbols actually used by the PDCCH is "2".

Special control channels like the PCFICH or PHICH require a minimum number of control channel OFDM symbols at the beginning of each subframe. If PRB Symbol Offset is lower than the required value, the control channel data overwrites some resource elements of the PDSCH.

If Auto is selected, the Control Region for PDCCH (PRB Symbol Offset) value is detected from the PCFICH. For correct demodulation of a PCFICH signal conforming to 3GPP, the Scrambling of Coded Bits has to be enabled.

Remote command:

[CONFigure\[:LTE\]:DL\[:CC<cc>\]:PSOffset](#) on page 166

## 6.8.2 Configuring the Reference Signal

The reference signal settings contain settings to describe the physical attributes and structure of the reference signal.

The reference signal settings are part of the "Downlink Adv Sig Config" tab of the "Demodulation Settings" dialog box.

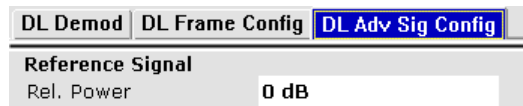

Rel Power (Reference Signal).....86

### Rel Power (Reference Signal)

Defines the relative power of the reference signal compared to all the other physical signals and physical channels.

Note that this setting gives you an offset to all other relative power settings.

Remote command:

[CONFigure\[:LTE\]:DL\[:CC<cc>\]:REFSig:POWer](#) on page 166

## 6.8.3 Configuring the Synchronization Signal

The synchronization signal settings contain settings to describe the physical attributes and structure of the synchronization signal.

The synchronization signal settings are part of the "Downlink Adv Sig Config" tab of the "Demodulation Settings" dialog box.

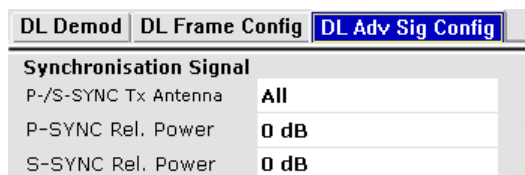

P-/S-SYNC Tx Antenna..... 87  
 P-Sync Relative Power..... 87  
 S-Sync Relative Power..... 87

**P-/S-SYNC Tx Antenna**

Selects the antenna that transmits the synchronization signal (P-SYNC or S-SYNC). When selecting the antenna, you implicitly select the synchronization method. If the selected antenna transmits no synchronization signal, the application uses the reference signal to synchronize. Note that automatic cell ID detection is not available if synchronization is based on the reference signal.

Remote command:  
[CONFigure\[:LTE\]:DL\[:CC<cc>\]:SYNC:ANTenna](#) on page 167

**P-Sync Relative Power**

Defines the power of the primary synchronization signal (P-Sync) relative to the reference signal.

Remote command:  
[CONFigure\[:LTE\]:DL\[:CC<cc>\]:SYNC:PPOWer](#) on page 167

**S-Sync Relative Power**

Defines the power of the secondary synchronization signal (S-Sync) relative to the reference signal.

Remote command:  
[CONFigure\[:LTE\]:DL\[:CC<cc>\]:SYNC:SPOWer](#) on page 167

**6.8.4 Configuring the Control Channels**

The control channel settings contain setting that describe the physical attributes and structure of the control channel.

The control channel settings are part of the "Downlink Signal Characteristics" tab of the "Demodulation Settings" dialog box.

- [PBCH Configuration](#)..... 88
- [PCFICH Configuration](#)..... 88
- [PHICH Configuration](#)..... 89
- [PDCCH Configuration](#)..... 90

### 6.8.4.1 PBCH Configuration

The physical broadcast channel (PBCH) carries system information for the user equipment. You can include or exclude the PBCH in the test setup and define the relative power of this channel.

DL Demod	DL Frame Config	DL Adv Sig Config
<b>PBCH</b>		
Present	<input checked="" type="checkbox"/>	
Rel. Power		0 dB

PBCH Present.....	88
PBCH Relative Power.....	88

#### PBCH Present

Includes or excludes the PBCH from the test setup.

Remote command:

[CONFigure\[:LTE\]:DL\[:CC<cc>\]:PBCH:STAT](#) on page 168

#### PBCH Relative Power

Defines the power of the PBCH relative to the reference signal.

Remote command:

[CONFigure\[:LTE\]:DL\[:CC<cc>\]:PBCH:POWer](#) on page 168

### 6.8.4.2 PCFICH Configuration

The physical control format indicator channel (PCFICH) carries information about the format of the PDCCH. You can include or exclude the PCFICH in the test setup and define the relative power of this channel.

DL Demod	DL Frame Config	DL Adv Sig Config
<b>PCFICH</b>		
Present	<input checked="" type="checkbox"/>	
Rel. Power		0 dB

PCFICH Present.....	88
PCFICH Relative Power.....	88

#### PCFICH Present

Includes or excludes the PCFICH from the test setup.

Remote command:

[CONFigure\[:LTE\]:DL\[:CC<cc>\]:PCFich:STAT](#) on page 169

#### PCFICH Relative Power

Defines the power of the PCFICH relative to the reference signal.

Remote command:

[CONFigure\[:LTE\]:DL\[:CC<cc>\]:PCFich:POWer](#) on page 169



### 6.8.4.3 PHICH Configuration

The physical hybrid ARQ indicator channel (PHICH) contains the hybrid ARQ indicator. The hybrid ARQ indicator contains the acknowledgement / negative acknowledgments for uplink blocks.

You can set several specific parameters for the PHICH.



#### Turning off the PHICH

If you set the value of the **PHICH N<sub>g</sub>** to "Custom" and at the same time define "0" **PHICH groups**, the PHICH is excluded from the signal.

DL Demod	DL Frame Config	DL Adv Sig Config
<b>PHICH</b>		
Duration	Normal	
TDD m <sub>i</sub> =1 (E-TM)	<input type="checkbox"/>	
PHICH N <sub>g</sub>	1/6	
Number of Groups	0	
Rel. Power	-3.01 dB	

PHICH Duration.....	89
PHICH TDD m <sub>i</sub> =1 (E-TM).....	89
PHICH N <sub>g</sub> .....	90
PHICH Number of Groups.....	90
PHICH Rel Power.....	90

#### PHICH Duration

Selects the duration of the PHICH. Normal and extended durations are supported.

With a normal duration, all resource element groups of the PHICH are allocated on the first OFDM symbol.

With an extended duration, the resource element groups of the PHICH are distributed over three OFDM symbols for a normal subframe or over two symbols within a special subframe.

If you select Auto, the duration of PHICH is automatically determined and based on the PBCH decoding results.

Note that you have to turn on the PBCH for an automatic determination of the PHICH duration.

Remote command:

`CONFigure[:LTE]:DL[:CC<cc>]:PHICH:DURation` on page 170

#### PHICH TDD m<sub>i</sub>=1 (E-TM)

Turns the special setting of the PHICH for the enhanced test models on and off.

The special setting is defined in 36.141 V9.0.0, 6.1.2.6: "For frame structure type 2 the factor m<sub>i</sub> shall not be set as per TS36.211, Table 6.9-1, but instead shall be set to m<sub>i</sub>=1 for all transmitted subframes".

The parameter is available if you have selected TDD.

Remote command:

[CONFigure\[:LTE\]:DL\[:CC<cc>\]:PHICH:MITM](#) on page 171

### PHICH N<sub>g</sub>

Defines the variable N<sub>g</sub>.

N<sub>g</sub> in combination with the number of resource blocks defines the number of PHICH groups in a downlink subframe. The standard specifies several values for N<sub>g</sub> that you can select from the dropdown menu.

If you need a customized configuration, you can set the number of PHICH groups in a subframe by selecting the "Custom" menu item and define the number of PHICH groups directly with [PHICH Number of Groups](#).

Remote command:

[CONFigure\[:LTE\]:DL\[:CC<cc>\]:PHICH:NGParameter](#) on page 171

### PHICH Number of Groups

Defines the number of PHICH groups in a subframe.

To select the number of groups, you have to set the [PHICH N<sub>g</sub>](#) to "Custom".

Remote command:

[CONFigure\[:LTE\]:DL\[:CC<cc>\]:PHICH:NOGRoups](#) on page 171

### PHICH Rel Power

Defines the power of all PHICHs in a PHICH group relative to the reference signal.

The application measures a separate relative power for each PHICH if [Boosting Estimation](#) is on. In that case, the "Rel. Power / dB" result in the Allocation Summary stays empty, because it refers to the common relative power for all PHICHs.

Note that the PHICH power results are quantized to 1 dB steps based on the PHICH relative power, because only a few PHICH symbols are available for boosting estimation.

#### Example:

The "PHICH Rel Power" is -3.01 dB.

In that case, possible PHICH boostings are -4.01 dB, -3.01 dB, -2.01 dB, etc.

Remote command:

[CONFigure\[:LTE\]:DL\[:CC<cc>\]:PHICH:POWer](#) on page 172

#### 6.8.4.4 PDCCH Configuration

The physical downlink control channel (PDCCH) carries the downlink control information (for example the information about the PDSCH resource allocation).

You can define several specific parameters for the PDCCH.

DL Demod	DL Frame Config	DL Adv Sig Config
<b>PDCCH</b>		
Format	-1	
Number of PDCCHs	0	
Rel. Power	0 dB	

PDCCH Format..... 91  
 Number of PDCCHs..... 91  
 PDCCH Rel Power..... 91

**PDCCH Format**

Defines the format of the PDCCH (physical downlink control channel).

Note that PDCCH format "-1" is not defined in the standard. This format corresponds to the transmission of one PDCCH on all available resource element groups. As a special case for this PDCCH format, the center of the constellation diagram is treated as a valid constellation point.

Remote command:

`CONFigure[:LTE]:DL[:CC<cc>]:PDCCh:FORMat` on page 169

**Number of PDCCHs**

Sets the number of physical downlink control channels.

This parameter is available if the PDCCH format is -1.

Remote command:

`CONFigure[:LTE]:DL[:CC<cc>]:PDCCh:NOPD` on page 170

**PDCCH Rel Power**

Defines the power of the PDCCH relative to the reference signal.

Remote command:

`CONFigure[:LTE]:DL[:CC<cc>]:PDCCh:POWer` on page 170

**6.8.5 Configuring the Shared Channel**

The shared channel characteristics are part of the "Advanced Settings" tab of the "Signal Description" dialog box.

PDSCH Power Ratio..... 91

**PDSCH Power Ratio**

Selects the PDSCH P\_B parameter that defines the cell-specific ratio of rho\_B to rho\_A according to 3GPP TS 36.213, table 5.2-1.

The table below shows the resulting values as a function of the number of antennas.

PDSCH P_B	1 Tx antenna	2 and 4 Tx antennas
0	0.000 dB	0.969 dB
1	-0.969 dB	0.000 dB
2	-2.218 dB	-1.249 dB
3	-3.979 dB	-3.010 dB

If you select "p\_B/p\_A=1", the ratio is always 1, regardless of the number of antennas.

Remote command:

`CONFigure[:LTE]:DL[:CC<cc>]:PDSCh:PB` on page 172

# 7 Analysis

The LTE application provides several tools to analyze the measurement results in more detail.

- [Signal Part Selection](#).....93
- [Measurement Units](#).....94
- [Miscellaneous Analysis](#).....94
- [Constellation Diagram Filter](#).....95
- [Y-Axis Scale](#).....96
- [Markers](#).....96

## 7.1 Signal Part Selection

**Access:** [MEAS CONFIG] > "Meas Settings" > "Selection"

You can select specific parts of the signal you want to analyze.

- [Subframe Selection](#).....93

### Subframe Selection

The "Subframe" selection filters the results by a specific subframe number.

If you apply the filter, only the results for the subframe you have selected are displayed. Otherwise, the R&S FSVA/FSV shows the results for all subframes that have been analyzed.

The R&S FSVA/FSV shows three traces if you display the results for all subframes.

- One trace ("Min") shows the minimum values measured over all analyzed subframes.
- One trace ("Max") shows the maximum values measured over all analyzed subframes.
- One trace ("Avg") shows the average values measured over all subframes.



If you filter by a single subframe, the R&S FSVA/FSV shows one trace that represents the values measured for that subframe only.



You can apply the filter to the following result displays.

- Result Summary
- EVM vs Carrier / EVM vs Symbol / EVM vs Symbol X Carrier
- Channel Flatness / Channel Flatness Difference
- Group Delay
- Power vs Symbol X Carrier

- Constellation Diagram
- Allocation Summary
- Bit Stream
- Time Alignment Error

Remote command:

[SENSe:] [LTE:] [CC<cc>:] SUBFrame:SElect on page 175

## 7.2 Measurement Units

**Access:** [MEAS CONFIG] > "Meas Settings" > "Units"

You can select the unit for various measurements and result displays.

**EVM Unit**..... 94

### EVM Unit

The "EVM Unit" selects the unit for the EVM measurement results in diagrams and numerical result displays.

Possible units are dB and %.

Remote command:

UNIT:EVM on page 176

## 7.3 Miscellaneous Analysis

**Access:** [MEAS CONFIG] > "Meas Settings" > "Misc"

**Bit Stream Format**..... 94

### Bit Stream Format

Selects the way the bit stream is displayed.

The bit stream is either a stream of raw bits or of symbols. In case of the symbol format, the bits that belong to a symbol are shown as hexadecimal numbers with two digits.

**Examples:**

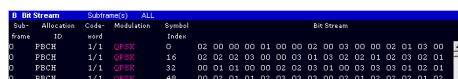

Figure 7-1: Bit stream display in downlink application if the bit stream format is set to "symbols"

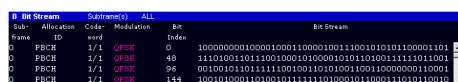

Figure 7-2: Bit stream display in downlink application if the bit stream format is set to "bits"

Remote command:  
[UNIT:BSTP](#) on page 175

## 7.4 Constellation Diagram Filter

**Access:** [MEAS CONFIG] > "Constell" > "Constell Filter"

The evaluation filter selects the contents of the constellation diagram.

[Evaluation range for the constellation diagram](#)..... 95

### Evaluation range for the constellation diagram

The "Evaluation Range" for the constellation diagram selects the information displayed in the [constellation diagram](#).

By default, the constellation diagram contains the constellation points of the complete data that has been analyzed. However, you can filter the results by several aspects.

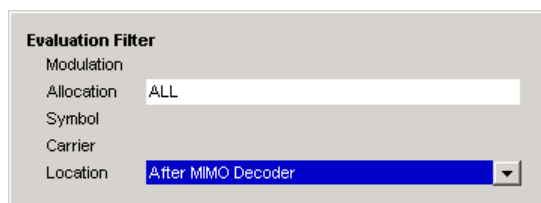
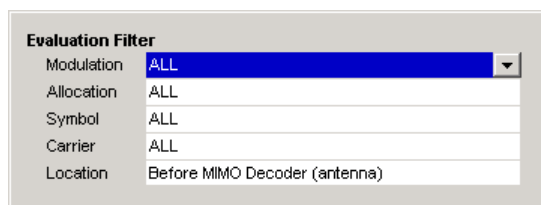

- Modulation  
Filters the results by the selected type of modulation.
- Allocation  
Filters the results by a certain type of allocation.
- Symbol (OFDM)  
Filters the results by a certain OFDM symbol.
- Carrier  
Filters the results by a certain subcarrier.
- Location  
Selects the point in the signal processing at which the constellation diagram is created, before or after the MIMO encoding.  
Note that the PHICH is CDMA encoded. Thus, the constellation points for the PHICH are either created before or after CDMA encoding.  
If you have selected "After MIMO/CDMA Decoder", filtering by "Symbol" and "Carrier" is not available. Instead, you can filter by "Symbol" and "Codeword".

Remote command:  
 Modulation: [\[SENSe:\] \[LTE:\] \[CC<cc>:\]MODulation:SElect](#) on page 174  
 Allocation: [\[SENSe:\] \[LTE:\] \[CC<cc>:\]ALLocation:SElect](#) on page 173

Symbol: [SENSe:] [LTE:] [CC<cc>:] SYMBol:SElect on page 175  
 Carrier: [SENSe:] [LTE:] [CC<cc>:] CARRier:SElect on page 173  
 Location: [SENSe:] [LTE:] [CC<cc>:] LOCation:SElect on page 174

## 7.5 Y-Axis Scale

**Access:** [MEAS CONFIG] > "Meas Settings" > "Y-Axis"

You can define the scale of the y-axis in most result displays.

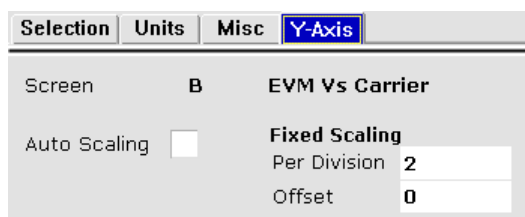

Y-Axis Scale..... 96

### Y-Axis Scale

The y-axis scaling determines the vertical resolution of the measurement results. The scaling you select always applies to the currently active screen and the corresponding result display.

Usually, the best way to view the results is if they fit ideally in the diagram area and display the complete trace. This is the way the application scales the y-axis if you have turned on **automatic scaling**.

But it can become necessary to see a more detailed version of the results. In that case, turn on fixed scaling for the y-axis. **Fixed scaling** becomes available when you turn off automatic scaling. For a fixed scaling, define the distance between two grid lines (scaling **per division**) and the point of origin of the y-axis (the **offset**).

Remote command:

Automatic scaling:

DISPlay[:WINDow]:TRACe:Y:SCALE:AUTO on page 181

Manual scaling:

DISPlay[:WINDow]:TRACe:Y:SCALE:FIXScale:OFFSet on page 181

DISPlay[:WINDow]:TRACe:Y:SCALE:FIXScale:PERDiv on page 182

## 7.6 Markers

**Access:** [MKR]

**Access:** [MKR →]

The firmware application provides marker functionality to work with. You can use a marker to mark specific points on traces or to read out measurement results.



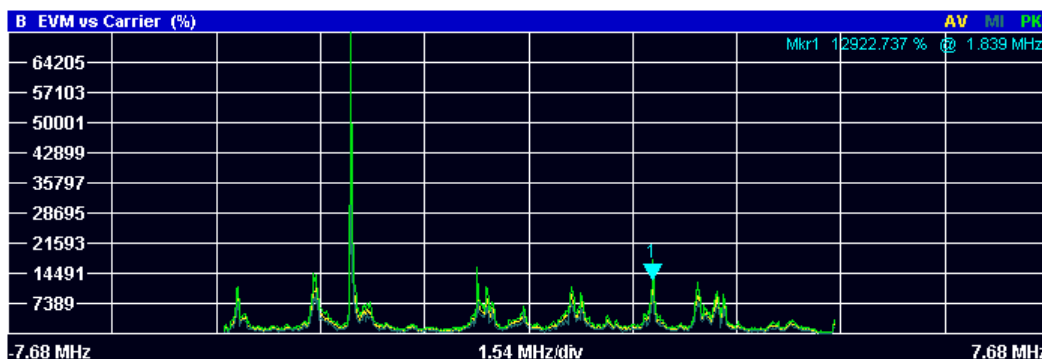

Figure 7-3: Example: Marker

The [MKR] key opens the corresponding submenu. You can activate up to four markers with the "Marker <x>" softkeys. The first marker is always a normal marker. Markers 2 to 4 are delta marker by default. The reference marker for the delta marker is marker 1. You can turn all delta markers into normal markers with the "Marker (Norm Delta)" softkey.

After pressing the "Marker <x>" softkey, you can set the position of the marker in several ways.

- Enter a frequency value in the marker input field.
- Move the marker with the rotary knob.
- Position the marker to the trace minimum or trace maximum with the "Marker Max" or "Marker Min" softkeys.

The current marker frequency and the corresponding level is displayed in the upper right corner of the trace display.

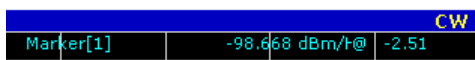

The "Marker <x>" softkey have three possible states:

- If the "Marker <x>" softkey is black, the marker is off.



- After pressing the "Marker <x>" softkey it turns orange to indicate an open dialog box and the the marker is active. The dialog box to specify the marker position on the frequency axis opens.



- After closing the dialog box, the "Marker <x>" softkey turns blue. The marker stays active.



Pressing the "Marker <x>" softkey again deactivates the marker. You can also turn off the marker by pressing the "All Marker Off" softkey.

If you'd like to see the area of the spectrum around the marker in more detail, you can use the Marker Zoom function. Press the "Marker Zoom" softkey to open a dialog box in which you can specify the zoom factor. The maximum possible zoom factor depends on the result display. The "Unzoom" softkey cancels the marker zoom.

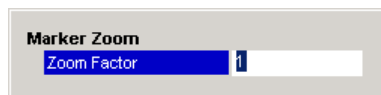

Note that the zoom function is not available for all result displays.

If you have more than one active trace, it is possible to assign the marker to a specific trace. Press the "Marker → Trace" softkey in the marker to menu and specify the trace in the corresponding dialog box.

SCPI commands:

See [Chapter 9.15.4, "Using Delta Markers"](#), on page 178.

## 8 File Management

- [File Manager](#)..... 99
- [SAVE/RECALL Key](#)..... 100
- [Test Models](#)..... 100

### 8.1 File Manager

The root menu of the application includes a File Manager with limited functions for quick access to file management functionality.

#### Loading a Frame Setup

The frame setup or frame description describes the complete modulation structure of the signal, such as bandwidth, modulation, etc.

The frame setup is stored as an XML file. XML files are very commonly used to describe hierarchical structures in an easy-to-read format for both humans and PC.

A typical frame setup file would look like this:

```
<FrameDefinition LinkDirection="downlink" TDDULDLAllocationConfiguration="0"
RessourceBlocks="50" CP="auto" RefSigSubcarrierOffset="Auto" PSYNCBoostingdB="0"
SSYNCBoostingdB="0" ReferenceSignalBoostingdB="0" PBCHSymbolOffset="7" PBCHLength="4"
PCFICHIsPresent="false" PHICHNumGroups="0" PHICHDuration="Normal" PHICHBoostingdB="0"
PDCCHIsPresent="false" PSSYNCRetpetitionPeriod="10" DataSymbolOffsetSubFrame="2"
MIMOConfiguration="1 Tx Antenna" MIMOAntennaSelection="Antenna 1" PhysLayCellIDGrp="Auto"
PhysLayID="Auto" RefSignal3GPPVersion="2" N_c_fastforward="0">
  <Frame>
    <Subframe>
      <PRBs>
        <PRB Start="0" Length="6" Boosting="0" Modulation="QPSK"/>
      </PRBs>
    </Subframe>
  </Frame>
  <stControl PhaseTracking="1" TimingTracking="0" ChannelEstimation="1"
  EVMCCalculationMethod="1" EnableScrambling="1" AutoDemodulation="1"/>
</FrameDefinition>
```

All settings that are available in the "Demod Settings" dialog box are also in the frame setup file. You can enter additional allocations by adding additional PRB entries in the PRBs list.

Note that at least one PRB must exist.

To load a frame setup, press the "File Manager" softkey in the root menu of the application. Select the file you want to load and activate it with the "Load Settings" button.

### Loading an I/Q File

The R&S FSVA/FSV is able to process I/Q data that has been captured with a R&S FSVA/FSV directly as well as data stored in a file. You can store I/Q data in various file formats in order to be able to process it with other external tools or for support purposes.

I/Q data can be formatted either in binary form or as ASCII files. The data is linearly scaled using the unit Volt (e.g. if a correct display of Capture Buffer power is required). For **binary** format, data is expected as 32-bit floating point data, Little Endian format (also known as LSB Order or Intel format). An example for binary data would be: 0x1D86E7BB in hexadecimal notation is decoded to -7.0655481E-3. The order of the data is either IQIQIQ or II...IQQ...Q.

For ASCII format, data is expected as I and Q values in alternating rows, separated by new lines: <I value 1>, <Q value 1>, <I value 2>, <Q value 2>, ...

To use data that has been stored externally, press the "File Manager" softkey in the root menu of the application. Select the file you want to load and activate it with the "Load IQ Data" button.

## 8.2 SAVE/RECALL Key

Besides the file manager in the root menu, you can also manage the data via the [SAVE/RECALL] key.

The corresponding menu offers full functionality for saving, restoring and managing the files on the R&S FSVA/FSV. The save/recall menu is the same as that of the spectrum mode. For details on the softkeys and handling of this file manager, refer to the operating manual of the R&S FSVA/FSV.

## 8.3 Test Models

### Using Test Scenarios

Test scenarios are descriptions of specific LTE signals.

If these test scenarios are specified in the LTE standard, they are also called test models. Various test models are already provided by the LTE application.

The application provides a set of test models defined by 3GPP.

► Select the test model in the "Test Models (E-TM)" dialog box (press the → "File Manager" and → "Load Test Model" softkeys).

Test Model Case	1.1	▼
Test Model Bandwidth	10 MHz	

### Predefined test models

For downlink signals, the 3GPP standard (TS 36.141) already defines several EUTRA test models (E-TM) for specific test scenarios. These test models are split into three

main groups (E-TM1, E-TM2 and E-TM3) and are defined by the following characteristics.

- Single antenna port, single code word, single layer and no precoding
- Duration of one frame
- Normal cyclic prefix
- Localized virtual resource blocks, no intra-subframe hopping for PDSCH
- UE-specific reference signal not used

The data content of the physical channels and signals is defined in the 3GPP standard. Each E-TM is defined for all bandwidths defined in the standard (1.4 MHz / 3 MHz / 5 MHz / 10 MHz / 15 MHz / 20 MHz).

[More information.](#)

Remote command:

Select 3GPP test model: `MMEMoRY:LOAD[:CC<cc>]:TMOd:DL` on page 110

## 9 Remote Commands

• Common Suffixes.....	102
• Introduction.....	103
• General Configuration.....	107
• Measurement Control.....	111
• Numeric Result Query.....	113
• Measurement Result Query.....	122
• General Settings.....	137
• MIMO Setups.....	144
• Advanced Settings.....	145
• Trigger Configuration.....	148
• Spectrum Measurements.....	151
• Signal Demodulation.....	156
• Frame Configuration.....	160
• Advanced Signal Characteristics.....	166
• Measurement Result Analysis.....	173

### 9.1 Common Suffixes

In the LTE measurement application, the following common suffixes are used in remote commands:

**Table 9-1: Common suffixes used in remote commands in the LTE measurement application**

Suffix	Value range	Description
<m>	1..4	Marker
<n>	1..16	Window (in the currently selected channel)
<t>	1..6	Trace
<li>	1 to 8	Limit line
<al>	0..110	Selects a subframe allocation.
<in>		Irrelevant.
<ant>	1..4	Selects an antenna for MIMO measurements.
<cc>	1..5	Irrelevant.
<cluster>	1..2	Selects a cluster (uplink only).
<cw>	1..n	Selects a codeword.
<k>	---	Selects a limit line. Irrelevant for the LTE application.
<sf>	DL: 0..49 UL: 0..9	Selects a subframe.

## 9.2 Introduction

Commands are program messages that a controller (e.g. a PC) sends to the instrument or software. They operate its functions ('setting commands' or 'events') and request information ('query commands'). Some commands can only be used in one way, others work in two ways (setting and query). If not indicated otherwise, the commands can be used for settings and queries.

The syntax of a SCPI command consists of a header and, in most cases, one or more parameters. To use a command as a query, you have to append a question mark after the last header element, even if the command contains a parameter.

A header contains one or more keywords, separated by a colon. Header and parameters are separated by a "white space" (ASCII code 0 to 9, 11 to 32 decimal, e.g. blank). If there is more than one parameter for a command, these are separated by a comma from one another.

Only the most important characteristics that you need to know when working with SCPI commands are described here. For a more complete description, refer to the User Manual of the R&S FSVA/FSV.



### Remote command examples

Note that some remote command examples mentioned in this general introduction may not be supported by this particular application.

---

### 9.2.1 Conventions used in Descriptions

Note the following conventions used in the remote command descriptions:

- **Command usage**  
If not specified otherwise, commands can be used both for setting and for querying parameters.  
If a command can be used for setting or querying only, or if it initiates an event, the usage is stated explicitly.
- **Parameter usage**  
If not specified otherwise, a parameter can be used to set a value and it is the result of a query.  
Parameters required only for setting are indicated as **Setting parameters**.  
Parameters required only to refine a query are indicated as **Query parameters**.  
Parameters that are only returned as the result of a query are indicated as **Return values**.
- **Conformity**  
Commands that are taken from the SCPI standard are indicated as **SCPI confirmed**. All commands used by the R&S FSVA/FSV follow the SCPI syntax rules.
- **Asynchronous commands**  
A command which does not automatically finish executing before the next command starts executing (overlapping command) is indicated as an **Asynchronous command**.
- **Reset values (\*RST)**

Default parameter values that are used directly after resetting the instrument (\*RST command) are indicated as \*RST values, if available.

- **Default unit**  
The default unit is used for numeric values if no other unit is provided with the parameter.
- **Manual operation**  
If the result of a remote command can also be achieved in manual operation, a link to the description is inserted.

## 9.2.2 Long and Short Form

The keywords have a long and a short form. You can use either the long or the short form, but no other abbreviations of the keywords.

The short form is emphasized in upper case letters. Note however, that this emphasis only serves the purpose to distinguish the short from the long form in the manual. For the instrument, the case does not matter.

### Example:

`SENSe:FREQUency:CENTer` is the same as `SENS:FREQ:CENT`.

## 9.2.3 Numeric Suffixes

Some keywords have a numeric suffix if the command can be applied to multiple instances of an object. In that case, the suffix selects a particular instance (e.g. a measurement window).

Numeric suffixes are indicated by angular brackets (<n>) next to the keyword.

If you don't quote a suffix for keywords that support one, a 1 is assumed.

### Example:

`DISPlay[:WINDow<1...4>]:ZOOM:STATe` enables the zoom in a particular measurement window, selected by the suffix at `WINDow`.

`DISPlay:WINDow4:ZOOM:STATe ON` refers to window 4.

## 9.2.4 Optional Keywords

Some keywords are optional and are only part of the syntax because of SCPI compliance. You can include them in the header or not.

Note that if an optional keyword has a numeric suffix and you need to use the suffix, you have to include the optional keyword. Otherwise, the suffix of the missing keyword is assumed to be the value 1.

Optional keywords are emphasized with square brackets.



**Example:**

Without a numeric suffix in the optional keyword:

```
[SENSe:]FREQuency:CENTer is the same as FREQuency:CENTer
```

With a numeric suffix in the optional keyword:

```
DISPlay[:WINDow<1...4>]:ZOOM:STATe
```

DISPlay:ZOOM:STATe ON enables the zoom in window 1 (no suffix).

DISPlay:WINDow4:ZOOM:STATe ON enables the zoom in window 4.

## 9.2.5 Alternative Keywords

A vertical stroke indicates alternatives for a specific keyword. You can use both keywords to the same effect.

**Example:**

```
[SENSe:]BANDwidth|BWIDth[:RESolution]
```

In the short form without optional keywords, BAND 1MHZ would have the same effect as BWID 1MHZ.

## 9.2.6 SCPI Parameters

Many commands feature one or more parameters.

If a command supports more than one parameter, these are separated by a comma.

**Example:**

```
LAYout:ADD:WINDow Spectrum,LEFT,MTABLE
```

Parameters may have different forms of values.

- [Numeric Values](#)..... 105
- [Boolean](#)..... 106
- [Character Data](#)..... 107
- [Character Strings](#)..... 107
- [Block Data](#)..... 107

### 9.2.6.1 Numeric Values

Numeric values can be entered in any form, i.e. with sign, decimal point or exponent. In case of physical quantities, you can also add the unit. If the unit is missing, the command uses the basic unit.

**Example:**

With unit: SENSe:FREQuency:CENTer 1GHZ

Without unit: SENSe:FREQuency:CENTer 1E9 would also set a frequency of 1 GHz.

Values exceeding the resolution of the instrument are rounded up or down.

If the number you have entered is not supported (e.g. in case of discrete steps), the command returns an error.

Instead of a number, you can also set numeric values with a text parameter in special cases.

- **MIN/MAX**  
Defines the minimum or maximum numeric value that is supported.
- **DEF**  
Defines the default value.
- **UP/DOWN**  
Increases or decreases the numeric value by one step. The step size depends on the setting. In some cases you can customize the step size with a corresponding command.

### Querying numeric values

When you query numeric values, the system returns a number. In case of physical quantities, it applies the basic unit (e.g. Hz in case of frequencies). The number of digits after the decimal point depends on the type of numeric value.

#### Example:

Setting: `SENSe:FREQuency:CENTer 1GHZ`

Query: `SENSe:FREQuency:CENTer?` would return `1E9`

In some cases, numeric values may be returned as text.

- **INF/NINF**  
Infinity or negative infinity. Represents the numeric values `9.9E37` or `-9.9E37`.
- **NAN**  
Not a number. Represents the numeric value `9.91E37`. NAN is returned in case of errors.

### 9.2.6.2 Boolean

Boolean parameters represent two states. The "ON" state (logically true) is represented by "ON" or a numeric value 1. The "OFF" state (logically untrue) is represented by "OFF" or the numeric value 0.

#### Querying Boolean parameters

When you query Boolean parameters, the system returns either the value 1 ("ON") or the value 0 ("OFF").

#### Example:

Setting: `DISPlay:WINDow:ZOOM:STATe ON`

Query: `DISPlay:WINDow:ZOOM:STATe?` would return `1`

### 9.2.6.3 Character Data

Character data follows the syntactic rules of keywords. You can enter text using a short or a long form. For more information see [Chapter 9.2.2, "Long and Short Form"](#), on page 104.

#### Querying text parameters

When you query text parameters, the system returns its short form.

#### Example:

Setting: `SENSe:BANDwidth:RESolution:TYPE NORMal`

Query: `SENSe:BANDwidth:RESolution:TYPE?` would return `NORM`

### 9.2.6.4 Character Strings

Strings are alphanumeric characters. They have to be in straight quotation marks. You can use a single quotation mark ( ' ) or a double quotation mark ( " ).

#### Example:

`INSTRument:DELeTe 'Spectrum'`

### 9.2.6.5 Block Data

Block data is a format which is suitable for the transmission of large amounts of data.

The ASCII character # introduces the data block. The next number indicates how many of the following digits describe the length of the data block. In the example the 4 following digits indicate the length to be 5168 bytes. The data bytes follow. During the transmission of these data bytes all end or other control signs are ignored until all bytes are transmitted. #0 specifies a data block of indefinite length. The use of the indefinite format requires an `NL^END` message to terminate the data block. This format is useful when the length of the transmission is not known or if speed or other considerations prevent segmentation of the data into blocks of definite length.

## 9.3 General Configuration

<a href="#">CALCulate&lt;n&gt;:FEED</a> .....	108
<a href="#">CONFigure:PRESet</a> .....	109
<a href="#">DISPlay[:WINDow&lt;n&gt;]:SElect</a> .....	109
<a href="#">DISPlay[:WINDow&lt;n&gt;]:TABLe</a> .....	109
<a href="#">MMEMory:LOAD:IQ:STATe</a> .....	110
<a href="#">MMEMory:STORe&lt;n&gt;:IQ:STATe</a> .....	110
<a href="#">MMEMory:LOAD[:CC&lt;cc&gt;]:TMOD:DL</a> .....	110

**CALCulate<n>:FEED <Result>**

This command selects the measurement and result display.

**Suffix:**

<n> [Window](#)

**Parameters:**

<Result> String containing the short form of the result display. See table below for details.

**Example:**

`CALC2:FEED 'PVT:CBUF'`

Select Capture Buffer to be displayed on screen B.

**Manual operation:**

See ["Capture Buffer"](#) on page 38  
 See ["Transmit On / Off Power"](#) on page 39  
 See ["EVM vs Carrier"](#) on page 42  
 See ["EVM vs Symbol"](#) on page 43  
 See ["Frequency Error vs Symbol"](#) on page 44  
 See ["EVM vs Subframe"](#) on page 45  
 See ["EVM vs RB"](#) on page 45  
 See ["Spectrum Emission Mask \(SEM\)"](#) on page 47  
 See ["Adjacent Channel Leakage Ratio \(ACLR\)"](#) on page 48  
 See ["Power Spectrum"](#) on page 50  
 See ["Power vs Resource Block PDSCH"](#) on page 51  
 See ["Power vs Resource Block RS"](#) on page 51  
 See ["Channel Flatness"](#) on page 52  
 See ["Group Delay"](#) on page 52  
 See ["Channel Flatness Difference"](#) on page 53  
 See ["Constellation Diagram"](#) on page 53  
 See ["CCDF"](#) on page 54  
 See ["Allocation Summary"](#) on page 55  
 See ["Bitstream"](#) on page 55

Result display	Parameter
ACLR	'SPEC:ACP'
Allocation Summary	'STAT:ASUM'
Bitstream	'STAT:BSTR'
Capture Buffer	'PVT:CBUF'
CCDF	'STAT:CCDF'
Constellation Diagram	'CONS:CONS'
CSI RS Weights (Magnitude)	'BEAM:IRWM'
CSI RS Weights (Phase)	'BEAM:IRWP'
EVM vs Carrier	'EVM:EVCA'
EVM vs RB	'EVM:EVRP'
EVM vs Subframe	'EVM:EVSU'

Result display	Parameter
EVM vs Symbol	'EVM:EVSY'
Flatness Difference	'SPEC:FLAT'
Group Delay	'SPEC:GDEL'
On / Off Power	'PVT:OOP'
Power Spectrum	'SPEC:PSPE'
Power vs RB PDSCH	'SPEC:PVRP'
Power vs RB RS	'SPEC:PVRR'
Spectrum Flatness	'SPEC:FLAT'
Spectrum Emission Mask	'SPEC:SEM'
Time Alignment Error	'PVT:TAER'

---

### CONFigure:PRESet

Initiates a preset to the default state of the software, and, if connected to an analyzer, also presets the analyzer.

**Example:**            `CONF:PRES`  
Presets the software.

**Usage:**            Event

---

### DISPlay[:WINDow<n>]:SElect

This command selects the measurement window.

**Example:**            `DISP:WIND2:SEL`  
Selects screen B.

**Usage:**            Event

---

### DISPlay[:WINDow<n>]:TABLe <State>

This command turns the result summary on and off.

**Suffix:**  
<n>                    1..n

**Parameters:**  
<State>

**ON**  
Turns the result summary on and removes all graphical results from the screen.

**OFF**  
Turns the result summary off and restores the graphical results that were previously set.

**Example:**            `DISP:TABL OFF`  
Turns the result summary off.

**Manual operation:** See "[Result Summary](#)" on page 35

#### **MMEMory:LOAD:IQ:STATe** <FileName>

This command restores I/Q data from a file.

##### **Setting parameters:**

<FileName>            String containing the path and name of the source file.

**Example:**            `//Load IQ data`  
`MMEM:LOAD:IQ:STAT 'C:\R_S\Instr\user\data.iqw'`

**Usage:**                Setting only

#### **MMEMory:STORe<n>:IQ:STATe** <Value>, <FileName>

This command saves I/Q data to a file.

##### **Suffix:**

<n>                      irrelevant

##### **Parameters:**

<Value>                1

<FileName>            String containing the path and name of the target file.

**Example:**            `MMEM:STOR:IQ:STAT 'C:`  
`\R_S\Instr\user\data.iq.tar'`  
Saves I/Q data to the specified file.

#### **MMEMory:LOAD[:CC<cc>]:TMOd:DL** <TestModel>

This command loads an EUTRA test model (E-TM).

The test models are in accordance with 3GPP TS 36.141.

##### **Suffix:**

<cc>                    irrelevant

##### **Setting parameters:**

<TestModel>            **'E-TM1\_1\_\_20MHz'**  
EUTRA Test Model 1.1 (E-TM1.1)  
**'E-TM1\_2\_\_20MHz'**  
EUTRA Test Model 1.2 (E-TM1.2)  
**'E-TM2\_\_20MHz'**  
EUTRA Test Model 2 (E-TM2)  
**'E-TM2A\_\_20MHz'**  
EUTRA Test Model 2a (E-TM2)  
**'E-TM3\_1\_\_20MHz'**  
EUTRA Test Model 3.1 (E-TM3.1)

**'E-TM3\_1A\_\_20MHz'**

EUTRA Test Model 3.1a (E-TM3.1)

**'E-TM3\_2\_\_20MHz'**

EUTRA Test Model 3.2 (E-TM3.2)

**'E-TM3\_3\_\_20MHz'**

EUTRA Test Model 3.3 (E-TM3.3)

To select a test model for a different bandwidth, replace "20MHz" with either "1\_4MHz", "3MHz", "5MHz", "10MHz" or "15MHz".

**Example:** `MMEM:LOAD:TMOD:DL 'E-TM2__10MHz'`  
 Selects test model 2 for a 10 MHz bandwidth.

**Usage:** Setting only

**Manual operation:** See ["Using Test Scenarios"](#) on page 100

## 9.4 Measurement Control

<code>INITiate:CONTinuous</code> .....	111
<code>INITiate[:IMMediate]</code> .....	111
<code>INITiate:REFResh</code> .....	112
<code>[SENSe:][LTE:]OOPower:ATIMing</code> .....	112
<code>[SENSe:]SYNC[:CC&lt;cc&gt;][:STATe]?</code> .....	112

---

### `INITiate:CONTinuous` <State>

This command controls the sweep mode.

**Parameters:**

<State>                    ON | OFF

**ON**  
 Continuous sweep

**OFF**  
 Single sweep

\*RST:                    OFF

**Example:** `INIT:CONT OFF`  
 Switches the sequence to single sweep.

`INIT:CONT ON`  
 Switches the sequence to continuous sweep.

**Manual operation:** See ["Single Sweep and Continuous Sweep"](#) on page 60

---

### `INITiate[:IMMediate]`

This command initiates a new measurement sequence.

With a frame count > 0, this means a restart of the corresponding number of measurements.

In single sweep mode, you can synchronize to the end of the measurement with \*OPC. In continuous sweep mode, synchronization to the end of the sweep is not possible.

**Example:**                   INIT  
                                  Initiates a new measurement.

**Usage:**                    Event

### INITiate:REFResh

This command updates the current I/Q measurement results to reflect the current measurement settings.

No new I/Q data is captured. Thus, measurement settings apply to the I/Q data currently in the capture buffer.

The command applies exclusively to I/Q measurements. It requires I/Q data.

**Example:**                   INIT:REFR  
                                  The application updates the IQ results

**Usage:**                    Event

**Manual operation:** See ["Refresh"](#) on page 60

### [SENSe:][LTE:]OOPower:ATIMing

This command adjusts the timing for on / off power measurements.

**Example:**                   //Adjust the on / off power timing  
                                  OOP:ATIM

**Manual operation:** See ["Adjust Timing"](#) on page 42  
                                  See ["Adjust Timing"](#) on page 60

### [SENSe:]SYNC[:CC<cc>][:STATe]?

This command queries the current synchronization state.

**Suffix:**  
<cc>                         irrelevant

**Return values:**  
<State>                    The string contains the following information:

- <OFDMSymbolTiming> is the coarse symbol timing
- <P-SYNCSynchronization> is the P-SYNC synchronization state
- <S-SYNCSynchronization> is the S-SYNC synchronization state

A zero represents a failure and a one represents a successful synchronization.



<b>Example:</b>	//Query synchronization state SYNC:STAT? Would return, e.g. '1,1,0' if coarse timing and P-SYNC were successful but S-SYNC failed.
<b>Usage:</b>	Query only

## 9.5 Numeric Result Query

FETCh[:CC<cc>]:CYCPrefix?	114
FETCh[:CC<cc>]:PLC:CIDGroup?	114
FETCh[:CC<cc>]:PLC:PLID?	115
FETCh[:CC<cc>]:SUMMary:CRESt[:AVERage]?	115
FETCh[:CC<cc>]:SUMMary:EVM[:ALL]:MAXimum?	115
FETCh[:CC<cc>]:SUMMary:EVM[:ALL]:MINimum?	115
FETCh[:CC<cc>]:SUMMary:EVM[:ALL]:AVERage]?	115
FETCh[:CC<cc>]:SUMMary:EVM:DSQP:MAXimum?	116
FETCh[:CC<cc>]:SUMMary:EVM:DSQP:MINimum?	116
FETCh[:CC<cc>]:SUMMary:EVM:DSQP[:AVERage]?	116
FETCh[:CC<cc>]:SUMMary:EVM:DSST:MAXimum?	116
FETCh[:CC<cc>]:SUMMary:EVM:DSST:MINimum?	116
FETCh[:CC<cc>]:SUMMary:EVM:DSST[:AVERage]?	116
FETCh[:CC<cc>]:SUMMary:EVM:DSSF:MAXimum?	116
FETCh[:CC<cc>]:SUMMary:EVM:DSSF:MINimum?	116
FETCh[:CC<cc>]:SUMMary:EVM:DSSF[:AVERage]?	116
FETCh[:CC<cc>]:SUMMary:EVM:DSTS:MAXimum?	117
FETCh[:CC<cc>]:SUMMary:EVM:DSTS:MINimum?	117
FETCh[:CC<cc>]:SUMMary:EVM:DSTS[:AVERage]?	117
FETCh[:CC<cc>]:SUMMary:EVM:DS1K:MAXimum?	117
FETCh[:CC<cc>]:SUMMary:EVM:DS1K:MINimum?	117
FETCh[:CC<cc>]:SUMMary:EVM:DS1K[:AVERage]?	117
FETCh[:CC<cc>]:SUMMary:EVM:PCHannel:MAXimum?	117
FETCh[:CC<cc>]:SUMMary:EVM:PCHannel:MINimum?	117
FETCh[:CC<cc>]:SUMMary:EVM:PCHannel[:AVERage]?	117
FETCh[:CC<cc>]:SUMMary:EVM:PSIGnal:MAXimum?	118
FETCh[:CC<cc>]:SUMMary:EVM:PSIGnal:MINimum?	118
FETCh[:CC<cc>]:SUMMary:EVM:PSIGnal[:AVERage]?	118
FETCh[:CC<cc>]:SUMMary:FERRor:MAXimum?	118
FETCh[:CC<cc>]:SUMMary:FERRor:MINimum?	118
FETCh[:CC<cc>]:SUMMary:FERRor[:AVERage]?	118
FETCh[:CC<cc>]:SUMMary:GIMBalance:MAXimum?	119
FETCh[:CC<cc>]:SUMMary:GIMBalance:MINimum?	119
FETCh[:CC<cc>]:SUMMary:GIMBalance[:AVERage]?	119
FETCh[:CC<cc>]:SUMMary:IQOFfset:MAXimum?	119
FETCh[:CC<cc>]:SUMMary:IQOFfset:MINimum?	119
FETCh[:CC<cc>]:SUMMary:IQOFfset[:AVERage]?	119
FETCh[:CC<cc>]:SUMMary:OSTP:MAXimum?	119
FETCh[:CC<cc>]:SUMMary:OSTP:MINimum?	119

FETCh[:CC<cc>]:SUMMary:OSTP[:AVERage]?	119
FETCh[:CC<cc>]:SUMMary:POWer:MAXimum?	120
FETCh[:CC<cc>]:SUMMary:POWer:MINimum?	120
FETCh[:CC<cc>]:SUMMary:POWer[:AVERage]?	120
FETCh[:CC<cc>]:SUMMary:QUADerror:MAXimum?	120
FETCh[:CC<cc>]:SUMMary:QUADerror:MINimum?	120
FETCh[:CC<cc>]:SUMMary:QUADerror[:AVERage]?	120
FETCh[:CC<cc>]:SUMMary:RSTP:MAXimum?	121
FETCh[:CC<cc>]:SUMMary:RSTP:MINimum?	121
FETCh[:CC<cc>]:SUMMary:RSTP[:AVERage]?	121
FETCh[:CC<cc>]:SUMMary:SERRor:MAXimum?	121
FETCh[:CC<cc>]:SUMMary:SERRor:MINimum?	121
FETCh[:CC<cc>]:SUMMary:SERRor[:AVERage]?	121
FETCh[:CC<cc>]:SUMMary:TAE<ant>?	121
FETCh[:CC<cc>]:SUMMary:TFRame?	122

---

### FETCh[:CC<cc>]:CYCPrefix?

This command queries the cyclic prefix type that has been detected.

**Suffix:**

<cc> irrelevant

**Return values:**

<PrefixType> The command returns -1 if no valid result has been detected yet.

**NORM**

Normal cyclic prefix length detected

**EXT**

Extended cyclic prefix length detected

**Example:**

```
//Query current cyclic prefix length type
FETC:CYCP?
```

**Usage:**

Query only

---

### FETCh[:CC<cc>]:PLC:CIDGroup?

This command queries the cell identity group that has been detected.

**Suffix:**

<cc> irrelevant

**Return values:**

<CIDGroup> The command returns -1 if no valid result has been detected yet.

Range: 0 to 167

**Example:**

```
//Query the current cell identity group
FETC:PLC:CIDG?
```

**Usage:**

Query only

**Manual operation:** See "Configuring the Physical Layer Cell Identity" on page 81

---

**FETCh[:CC<cc>]:PLC:PLID?**

This command queries the cell identity that has been detected.

**Suffix:**

<cc> irrelevant

**Return values:**

<Identity> The command returns -1 if no valid result has been detected yet.  
Range: 0 to 2

**Example:**

```
//Query the current cell identity
FETC:PLC:PLID?
```

**Usage:**

Query only

**Manual operation:** See "[Configuring the Physical Layer Cell Identity](#)" on page 81

---

**FETCh[:CC<cc>]:SUMM:CRESt[:AVERAge]?**

This command queries the average crest factor as shown in the result summary.

**Suffix:**

<cc> irrelevant

**Return values:**

<CrestFactor> <numeric value>  
Crest Factor in dB.

**Example:**

```
//Query crest factor
FETC:SUMM:CRESt?
```

**Usage:**

Query only

**Manual operation:** See "[Result Summary](#)" on page 35

---

**FETCh[:CC<cc>]:SUMM:EVM[:ALL]:MAXimum?  
FETCh[:CC<cc>]:SUMM:EVM[:ALL]:MINimum?  
FETCh[:CC<cc>]:SUMM:EVM[:ALL][:AVERAge]?**

This command queries the EVM of all resource elements.

**Suffix:**

<cc> irrelevant

**Return values:**

<EVM> <numeric value>  
Minimum, maximum or average EVM, depending on the last command syntax element.  
The unit is % or dB, depending on your selection.

**Example:**

```
//Query EVM
FETC:SUMM:EVM?
```

**Usage:**

Query only

**Manual operation:** See "[Result Summary](#)" on page 35

---

**FETCh[:CC<cc>]:SUMMary:EVM:DSQP:MAXimum?**

**FETCh[:CC<cc>]:SUMMary:EVM:DSQP:MINimum?**

**FETCh[:CC<cc>]:SUMMary:EVM:DSQP[:AVERage]?**

This command queries the EVM of all PDSCH resource elements with a QPSK modulation.

**Suffix:**

<cc>                      irrelevant

**Return values:**

<EVM>                      <numeric value>

EVM in % or dB, depending on the unit you have set.

**Example:**

//Query EVM

FETC : SUMM : EVM : DSQP ?

**Usage:**

Query only

**Manual operation:** See "[Result Summary](#)" on page 35

---

**FETCh[:CC<cc>]:SUMMary:EVM:DSST:MAXimum?**

**FETCh[:CC<cc>]:SUMMary:EVM:DSST:MINimum?**

**FETCh[:CC<cc>]:SUMMary:EVM:DSST[:AVERage]?**

This command queries the EVM of all PDSCH resource elements with a 16QAM modulation.

**Suffix:**

<cc>                      irrelevant

**Return values:**

<EVM>                      <numeric value>

EVM in % or dB, depending on the unit you have set.

**Example:**

//Query EVM

FETC : SUMM : EVM : DSST ?

**Usage:**

Query only

**Manual operation:** See "[Result Summary](#)" on page 35

---

**FETCh[:CC<cc>]:SUMMary:EVM:DSSF:MAXimum?**

**FETCh[:CC<cc>]:SUMMary:EVM:DSSF:MINimum?**

**FETCh[:CC<cc>]:SUMMary:EVM:DSSF[:AVERage]?**

This command queries the EVM of all PDSCH resource elements with a 64QAM modulation.

**Suffix:**

<cc>                      irrelevant

**Return values:**

<EVM>                      <numeric value>

EVM in % or dB, depending on the unit you have set.

**Example:** //Query EVM  
FETC : SUMM : EVM : DSSF ?

**Usage:** Query only

**Manual operation:** See "[Result Summary](#)" on page 35

**FETCh[:CC<cc>]:SUMMary:EVM:DSTS:MAXimum?**  
**FETCh[:CC<cc>]:SUMMary:EVM:DSTS:MINimum?**  
**FETCh[:CC<cc>]:SUMMary:EVM:DSTS[:AVERage]?**

This command queries the EVM of all PDSCH resource elements with a 256QAM modulation.

**Suffix:**  
<cc> irrelevant

**Return values:**  
<EVM> <numeric value>  
EVM in % or dB, depending on the unit you have set.

**Example:** //Query EVM  
FETC : SUMM : EVM : DSTS ?

**Usage:** Query only

**Manual operation:** See "[Result Summary](#)" on page 35

**FETCh[:CC<cc>]:SUMMary:EVM:DS1K:MAXimum?**  
**FETCh[:CC<cc>]:SUMMary:EVM:DS1K:MINimum?**  
**FETCh[:CC<cc>]:SUMMary:EVM:DS1K[:AVERage]?**

This command queries the EVM of all resource elements of the PDSCH with a 1024QAM modulation.

**Suffix:**  
<cc> irrelevant

**Return values:**  
<EVM> <numeric value>  
EVM in % or dB, depending on the unit you have set.

**Example:** //Query EVM  
FETC : SUMM : EVM : DS1K ?

**Usage:** Query only

**Manual operation:** See "[Result Summary](#)" on page 35

**FETCh[:CC<cc>]:SUMMary:EVM:PCHannel:MAXimum?**  
**FETCh[:CC<cc>]:SUMMary:EVM:PCHannel:MINimum?**  
**FETCh[:CC<cc>]:SUMMary:EVM:PCHannel[:AVERage]?**

This command queries the EVM of all physical channel resource elements.

**Suffix:**  
<cc> irrelevant

**Return values:**  
<EVM> <numeric value>  
EVM in % or dB, depending on the unit you have set.

**Example:** //Query EVM  
FETC : SUMM : EVM : PCH ?

**Usage:** Query only

**Manual operation:** See "[Result Summary](#)" on page 35

**FETCh[:CC<cc>]:SUMMary:EVM:PSIGnal:MAXimum?**  
**FETCh[:CC<cc>]:SUMMary:EVM:PSIGnal:MINimum?**  
**FETCh[:CC<cc>]:SUMMary:EVM:PSIGnal[:AVERage]?**

This command queries the EVM of all physical signal resource elements.

**Suffix:**  
<cc> irrelevant

**Return values:**  
<EVM> <numeric value>  
Minimum, maximum or average EVM, depending on the last command syntax element.  
The unit is % or dB, depending on your selection.

**Example:** //Query EVM  
FETC : SUMM : EVM : PSIG ?

**Usage:** Query only

**Manual operation:** See "[Result Summary](#)" on page 35

**FETCh[:CC<cc>]:SUMMary:FERRor:MAXimum?**  
**FETCh[:CC<cc>]:SUMMary:FERRor:MINimum?**  
**FETCh[:CC<cc>]:SUMMary:FERRor[:AVERage]?**

This command queries the frequency error.

**Suffix:**  
<cc> irrelevant

**Return values:**  
<FrequencyError> <numeric value>  
Minimum, maximum or average frequency error, depending on the last command syntax element.  
Default unit: Hz

**Example:** //Query average frequency error  
FETC : SUMM : FERR ?

**Usage:** Query only

**Manual operation:** See ["Result Summary"](#) on page 35

---

**FETCh[:CC<cc>]:SUMMary:GIMBalance:MAXimum?**  
**FETCh[:CC<cc>]:SUMMary:GIMBalance:MINimum?**  
**FETCh[:CC<cc>]:SUMMary:GIMBalance[:AVERage]?**

This command queries the I/Q gain imbalance.

**Suffix:**

<cc> irrelevant

**Return values:**

<GainImbalance> <numeric value>

Minimum, maximum or average I/Q imbalance, depending on the last command syntax element.

Default unit: dB

**Example:**

//Query average gain imbalance  
 FETC:SUMM:GIMB?

**Usage:**

Query only

**Manual operation:** See ["Result Summary"](#) on page 35

---

**FETCh[:CC<cc>]:SUMMary:IQOffset:MAXimum?**  
**FETCh[:CC<cc>]:SUMMary:IQOffset:MINimum?**  
**FETCh[:CC<cc>]:SUMMary:IQOffset[:AVERage]?**

This command queries the I/Q offset.

**Suffix:**

<cc> irrelevant

**Return values:**

<IQOffset> <numeric value>

Minimum, maximum or average I/Q offset, depending on the last command syntax element.

Default unit: dB

**Example:**

//Query average IQ offset  
 FETC:SUMM:IQOF?

**Usage:**

Query only

**Manual operation:** See ["Result Summary"](#) on page 35

---

**FETCh[:CC<cc>]:SUMMary:OSTP:MAXimum?**  
**FETCh[:CC<cc>]:SUMMary:OSTP:MINimum?**  
**FETCh[:CC<cc>]:SUMMary:OSTP[:AVERage]?**

This command queries the OSTP.

**Suffix:**

<cc> irrelevant

**Return values:**

<OSTP> <numeric value>  
Minimum, maximum or average OSTP, depending on the last command syntax element.

Default unit: dBm

**Example:**

```
//Query average OSTP
FETC : SUMM : OSTP ?
```

**Usage:**

Query only

**Manual operation:** See ["Result Summary"](#) on page 35

**FETCh[:CC<cc>]:SUMMary:POWer:MAXimum?**  
**FETCh[:CC<cc>]:SUMMary:POWer:MINimum?**  
**FETCh[:CC<cc>]:SUMMary:POWer[:AVERage]?**

This command queries the total power.

**Suffix:**

<cc> irrelevant

**Return values:**

<Power> <numeric value>  
Minimum, maximum or average power, depending on the last command syntax element.

Default unit: dBm

**Example:**

```
//Query average total power
FETC : SUMM : POW ?
```

**Usage:**

Query only

**Manual operation:** See ["Result Summary"](#) on page 35

**FETCh[:CC<cc>]:SUMMary:QUADerror:MAXimum?**  
**FETCh[:CC<cc>]:SUMMary:QUADerror:MINimum?**  
**FETCh[:CC<cc>]:SUMMary:QUADerror[:AVERage]?**

This command queries the quadrature error.

**Suffix:**

<cc> irrelevant

**Return values:**

<QuadratureError> <numeric value>  
Minimum, maximum or average quadrature error, depending on the last command syntax element.

Default unit: deg

**Example:**

```
//Query average quadrature error
FETC : SUMM : QUAD ?
```

**Usage:**

Query only



**Manual operation:** See ["Result Summary"](#) on page 35

---

**FETCh[:CC<cc>]:SUMMary:RSTP:MAXimum?**  
**FETCh[:CC<cc>]:SUMMary:RSTP:MINimum?**  
**FETCh[:CC<cc>]:SUMMary:RSTP[:AVERage]?**

This command queries the RSTP.

**Suffix:**

<cc> irrelevant

**Return values:**

<RSTP> <numeric value>  
 Default unit: dBm

**Example:** //Query RSTP  
 FETC:SUMM:RSTP?

**Usage:** Query only

**Manual operation:** See ["Result Summary"](#) on page 35

---

**FETCh[:CC<cc>]:SUMMary:SERRor:MAXimum?**  
**FETCh[:CC<cc>]:SUMMary:SERRor:MINimum?**  
**FETCh[:CC<cc>]:SUMMary:SERRor[:AVERage]?**

This command queries the sampling error.

**Suffix:**

<cc> irrelevant

**Return values:**

<SamplingError> <numeric value>  
 Minimum, maximum or average sampling error, depending on the last command syntax element.  
 Default unit: ppm

**Example:** //Query average sampling error  
 FETC:SUMM:SERR?

**Usage:** Query only

**Manual operation:** See ["Result Summary"](#) on page 35

---

**FETCh[:CC<cc>]:SUMMary:TAE<ant>?**

This command queries the time alignment error.

**Suffix:**

<cc> 1..n  
 irrelevant

<ant> 1..n  
[Component Carrier](#)  
 Number of the antenna you want to compare to antenna 1.

**Return values:**

<TimeAlignmentError>Time alignment error of antenna 1 and another antenna.

**Usage:** Query only

**Manual operation:** See "[Result Summary](#)" on page 35

**FETCh[:CC<cc>]:SUMMary:TFRame?**

This command queries the (sub)frame start offset as shown in the capture buffer.

**Suffix:**

<cc> irrelevant

**Return values:**

<Offset> Time difference between the (sub)frame start and capture buffer start.  
 Default unit: s

**Example:** //Query subframe start offset  
 FETC:SUMM:TFR?

**Usage:** Query only

**Manual operation:** See "[Capture Buffer](#)" on page 38

## 9.6 Measurement Result Query

- [Using the TRACe\[:DATA\] Command](#)..... 122
- [Reading Results](#)..... 133

### 9.6.1 Using the TRACe[:DATA] Command

This chapter contains information on the TRACe:DATA command and a detailed description of the characteristics of that command.

The TRACe:DATA command queries the trace data or results of the currently active measurement or result display. The type, number and structure of the return values are specific for each result display. In case of results that have any kind of unit, the command returns the results in the unit you have currently set for that result display.

Note also that return values for results that are available for both downlink and uplink may be different.

For several result displays, the command also supports various SCPI parameters in combination with the query. If available, each SCPI parameter returns a different aspect of the results. If SCPI parameters are supported, you have to quote one in the query.

**Example:**

```
TRAC2:DATA? TRACE1
```

The format of the return values is either in ASCII or binary characters and depends on the format you have set with `FORMat [:DATA]`.

Following this detailed description, you will find a short summary of the most important functions of the command (`TRACe [:DATA] ?`).

**Selecting a measurement window**

Before you can query measurement results, you have to select the measurement window that contain the result you would like to query with the command `DISPlay[:WINDow<n>]:SElect`.

• Adjacent Channel Leakage Ratio.....	123
• Allocation Summary.....	124
• Bit Stream.....	125
• Capture Buffer.....	126
• CCDF.....	126
• Channel and Spectrum Flatness.....	126
• Channel and Spectrum Flatness Difference.....	127
• Group Delay.....	127
• Constellation Diagram.....	127
• EVM vs Carrier.....	128
• EVM vs RB.....	128
• EVM vs Subframe.....	129
• EVM vs Symbol.....	129
• Frequency Error vs Symbol.....	129
• On/Off Power.....	130
• Power Spectrum.....	130
• Power vs RB RS.....	130
• Power vs RB PDSCH.....	131
• Spectrum Emission Mask.....	131
• Return Value Codes.....	131

**9.6.1.1 Adjacent Channel Leakage Ratio**

For the ACLR result display, the number and type of returns values depend on the parameter.

- TRACE1  
Returns one value for each trace point.
- LIST  
Returns the contents of the ACLR table.  
For each channel, it returns six values.  
<channel type>, <bandwidth>, <spacing offset>, <power of lower channel>, <power of upper channel>, <limit>, ...  
The unit of the <bandwidth> and <spacing offset> is Hz.

The unit of the power values is either dBm for the TX channel or dB for the neighboring channels.

The unit of the limit is dB.

The <channel type> is encoded. For the code assignment see [Chapter 9.6.1.20, "Return Value Codes"](#), on page 131.

Note that the TX channel does not have a <spacing offset>, <power of lower channel> and <limit>. NaN is returned instead.

### 9.6.1.2 Allocation Summary

For the allocation summary, the command returns several values for each line of the table.

- <subframe>
- <allocation ID>
- <number of RB>
- <relative power>
- <modulation>
- <absolute power>
- <EVM>

The data format of the return values is always ASCII.

The return values have the following characteristics.

- The <allocation ID is encoded.  
For the code assignment, see [Chapter 9.6.1.20, "Return Value Codes"](#), on page 131.
- The unit for <relative power> is always dB.
- The <modulation> is encoded.  
For the code assignment, see [Chapter 9.6.1.20, "Return Value Codes"](#), on page 131.
- The unit for <absolute power> is always dBm.
- The unit for <EVM> depends on `UNIT:EVM`.

#### Example:

Sub-frame	Alloc. ID	Number of RB	Rel. Power/dB	Modulation	Power per RE/dBm	EVM/s
0	RS Ant1		0,000	QPSK	-45,546	0,733
	P-SYNC		-0,007	CAZAC	-42,558	0,254
	S-SYNC		0,005	RBPSK	-42,546	0,251

TRAC:DATA? TRACE1 would return:

```
0, -5, 0, 0.00000000000000, 2, -45.5463829153428, 7.33728660354122E-05,
0, -3, 0, 0.0073997452251, 6, -42.5581007463452, 2.54197349219455E-05,
0, -4, 0, 0.0052647197362, 1, -42.5464220485716, 2.51485275782241E-05,
...
```

### Additional information "ALL"

The allocation summary contains additional lines "ALL" that summarize the number of RB analyzed in each subframe and the average EVM measured in that subframe. This information is added to the return values after all allocations of the subframe have been returned. The "ALL" information has the allocation ID code "-2".

In addition, there is a line at the end of the allocation summary that shows the average EVM over all analyzed subframes. This information is also added as the last return values. The "ALL" information has the subframe ID and allocation ID code "-2".

A query result would thus look like this, for example:

```
//For subframe 0:
0, -40, 10, 2, 2, -84.7431947342849, 2.68723483754626E-06,
0, -41, 0, 0, 6, -84.7431432845264, 2.37549449584568E-06,
(...)
//ALL for subframe 0:
0,-2,20,,,,2.45581475911678E-06
//For subframe 1:
1, -40, 10, 2, 2, -84.7431947342849, 2.68723483754626E-06,
1, -41, 0, 0, 6, -84.7431432845264, 2.37549449584568E-06,
(...)
//ALL for subframe 1:
1,-2,20,,,,2.45581475911678E-06
(...)
//ALL for all subframes
-2,-2,,,,2.13196434228374E-06
```

#### 9.6.1.3 Bit Stream

For the bit stream result display, the command returns five values and the bitstream for each line of the table.

```
<subframe>, <allocation ID>, <codeword>, <modulation>, <# of
symbols/bits>, <hexadecimal/binary numbers>,...
```

All values have no unit. The format of the bit stream depends on [Bit Stream Format](#).

The <allocation ID>, <codeword> and <modulation> are encoded. For the code assignment see [Chapter 9.6.1.20, "Return Value Codes"](#), on page 131.

For symbols or bits that are not transmitted, the command returns

- "FF" if the bit stream format is "Symbols"
- "9" if the bit stream format is "Bits".

For symbols or bits that could not be decoded because the number of layer exceeds the number of receive antennas, the command returns

- "FE" if the bit stream format is "Symbols"
- "8" if the bit stream format is "Bits".

Note that the data format of the return values is always ASCII.

**Example:**

Sub-frame	Allocation ID	Code-word	Modulation	Symbol Index	Bit Stream
0	PBCH	1/1	QPSK	0	01 01 00 02 03 00 01 02 01 02 01 00 03 00 02 02
0	PBCH	1/1	QPSK	16	02 03 02 03 03 03 00 02 00 03 00 02 02 03 01 01
0	PBCH	1/1	QPSK	32	03 02 03 03 03 03 01 03 00 03 00 03 03 00 03 02

TRAC:DATA? TRACE1 would return:

```
0, -12, 0, 2, 0, 01, 01, 00, 02, 03, 00, 01, 02, 01, 02, 01, ...
<continues like this until the next data block starts or the end of data is reached>
0, -12, 0, 2, 32, 03, 02, 03, 03, 03, 03, 01, 03, 00, 03, ...
```

**9.6.1.4 Capture Buffer**

For the capture buffer result display, the command returns one value for each I/Q sample in the capture buffer.

<absolute power>, ...

The unit is always dBm.

The following parameters are supported.

- TRACE1

**9.6.1.5 CCDF**

For the CCDF result display, the type of return values depends on the parameter.

- TRACE1  
Returns the probability values (y-axis).  
<# of values>, <probability>, ...  
The unit is always %.  
The first value that is returned is the number of the following values.
- TRACE2  
Returns the corresponding power levels (x-axis).  
<# of values>, <relative power>, ...  
The unit is always dB.  
The first value that is returned is the number of the following values.

**9.6.1.6 Channel and Spectrum Flatness**

For the channel flatness result display, the command returns one value for each trace point.

<relative power>, ...

The unit is always dB.

The following parameters are supported.

- TRACE1  
Returns the average power over all subframes.
- TRACE2

Returns the minimum power found over all subframes. If you are analyzing a particular subframe, it returns nothing.

- TRACE3  
Returns the maximum power found over all subframes. If you are analyzing a particular subframe, it returns nothing.

#### 9.6.1.7 Channel and Spectrum Flatness Difference

For the channel flatness difference result display, the command returns one value for each trace point.

`<relative power>, ...`

The unit is always dB. The number of values depends on the selected LTE bandwidth.

The following parameters are supported.

- TRACE1  
Returns the average power over all subframes.
- TRACE2  
Returns the minimum power found over all subframes. If you are analyzing a particular subframe, it returns nothing.
- TRACE3  
Returns the maximum power found over all subframes. If you are analyzing a particular subframe, it returns nothing.

#### 9.6.1.8 Group Delay

For the group delay result display, the command returns one value for each trace point.

`<group delay>, ...`

The unit is always ns. The number of values depends on the selected LTE bandwidth.

The following parameters are supported.

- TRACE1  
Returns the group delay.

#### 9.6.1.9 Constellation Diagram

For the constellation diagram, the command returns two values for each constellation point.

```

<I[SF0][Sym0][Carrier1]>, <Q[SF0][Sym0][Carrier1]>, ..., <I[SF0][Sym0][Carrier(n)]>, <Q[SF0][Sym0][Carrier(n)]>,
<I[SF0][Sym1][Carrier1]>, <Q[SF0][Sym1][Carrier1]>, ..., <I[SF0][Sym1][Carrier(n)]>, <Q[SF0][Sym1][Carrier(n)]>,
<I[SF0][Sym(n)][Carrier1]>, <Q[SF0][Sym(n)][Carrier1]>, ..., <I[SF0][Sym(n)][Carrier(n)]>, <Q[SF0][Sym(n)][Carrier(n)]>,
<I[SF1][Sym0][Carrier1]>, <Q[SF1][Sym0][Carrier1]>, ..., <I[SF1][Sym0][Carrier(n)]>, <Q[SF1][Sym0][Carrier(n)]>,
<I[SF1][Sym1][Carrier1]>, <Q[SF1][Sym1][Carrier1]>, ..., <I[SF1][Sym1][Carrier(n)]>, <Q[SF1][Sym1][Carrier(n)]>,
<I[SF(n)][Sym(n)][Carrier1]>, <Q[SF(n)][Sym(n)][Carrier1]>, ..., <I[SF(n)][Sym(n)][Carrier(n)]>, <Q[SF(n)][Sym(n)][Carrier(n)]>

```

With SF = subframe and Sym = symbol of that subframe.

The I and Q values have no unit.

The number of return values depends on the constellation selection. By default, it returns all resource elements including the DC carrier.

The following parameters are supported.

- TRACE1  
Returns all constellation points included in the selection.

#### 9.6.1.10 EVM vs Carrier

For the EVM vs carrier result display, the command returns one value for each subcarrier that has been analyzed.

```
<EVM>, ...
```

The unit depends on [UNIT : EVM](#).

The following parameters are supported.

- TRACE1  
Returns the average EVM over all subframes
- TRACE2  
Returns the minimum EVM found over all subframes. If you are analyzing a particular subframe, it returns nothing.
- TRACE3  
Returns the maximum EVM found over all subframes. If you are analyzing a particular subframe, it returns nothing.

#### 9.6.1.11 EVM vs RB

For the EVM vs RB result display, the command returns one value for each resource block that has been analyzed.

```
<EVM>, ...
```

The unit depends on [UNIT : EVM](#).



The following parameters are supported.

- TRACE1  
Returns the average EVM for each resource block over all subframes.
- TRACE2  
Returns the minimum EVM found over all subframes. If you are analyzing a single subframe, it returns nothing.
- TRACE3  
Returns the maximum EVM found over all subframes. If you are analyzing a single subframe, it returns nothing.

#### 9.6.1.12 EVM vs Subframe

For the EVM vs subframe result display, the command returns one value for each subframe that has been analyzed.

<EVM>, ...

The unit depends on [UNIT:EVM](#).

The following parameters are supported.

- TRACE1

#### 9.6.1.13 EVM vs Symbol

For the EVM vs symbol result display, the command returns one value for each OFDM symbol that has been analyzed.

<EVM>, ...

For measurements on a single subframe, the command returns the symbols of that subframe only.

The unit depends on [UNIT:EVM](#).

The following parameters are supported.

- TRACE1

#### 9.6.1.14 Frequency Error vs Symbol

For the frequency error vs symbol result display, the command returns one value for each OFDM symbol that has been analyzed.

<frequency error>, ...

The unit is always Hz.

The following parameters are supported.

- TRACE1

### 9.6.1.15 On/Off Power

For the on/off power measurement, the number and type of return values depend on the parameter.

- TRACE1  
Returns the power for the Off power regions.  
`<absolute power>, ...`  
The unit is always dBm.
- TRACE2  
Returns the power for the transient regions.  
`<absolute power>, ...`  
The unit is always dBm.
- LIST  
Returns the contents of the on/off power table. For each line, it returns seven values.  
`<off period start limit>, <off period stop limit>, <time at delta to limit>, <absolute off power>, <distance to limit>, <falling transient period>, <rising transient period>, ...`  
The unit for the `<absolute off power>` is dBm. The unit for the `<distance to limit>` is dB. All other values have the unit s.

### 9.6.1.16 Power Spectrum

For the power spectrum result display, the command returns one value for each trace point.

`<power>, ...`

The unit is always dBm/Hz.

The following parameters are supported.

- TRACE1

### 9.6.1.17 Power vs RB RS

For the power vs RB RS result display, the command returns one value for each resource block of the reference signal that has been analyzed.

`<absolute power>, ...`

The unit is always dBm.

The following parameters are supported.

- TRACE1  
Returns the average power over all subframes
- TRACE2  
Returns the minimum power found over all subframes. If you are analyzing a particular subframe, it returns nothing.
- TRACE3

Returns the maximum power found over all subframes. If you are analyzing a particular subframe, it returns nothing.

#### 9.6.1.18 Power vs RB PDSCH

For the power vs RB PDSCH result display, the command returns one value for each resource block of the PDSCH that has been analyzed.

`<absolute power>, ...`

The unit is always dBm.

The following parameters are supported.

- TRACE1  
Returns the average power over all subframes
- TRACE2  
Returns the minimum power found over all subframes. If you are analyzing a particular subframe, it returns nothing.
- TRACE3  
Returns the maximum power found over all subframes. If you are analyzing a particular subframe, it returns nothing.

#### 9.6.1.19 Spectrum Emission Mask

For the SEM measurement, the number and type of returns values depend on the parameter.

- TRACE1  
Returns one value for each trace point.  
`<absolute power>, ...`  
The unit is always dBm.
- LIST  
Returns the contents of the SEM table. For every frequency in the spectrum emission mask, it returns 11 values.  
`<index>, <start frequency in Hz>, <stop frequency in Hz>, <RBW in Hz>, <limit fail frequency in Hz>, <absolute power in dBm>, <relative power in dBc>, <limit distance in dB>, <limit check result>, <reserved>, <reserved>...`  
The `<limit check result>` is either a 0 (for PASS) or a 1 (for FAIL).

#### 9.6.1.20 Return Value Codes

##### **<number of symbols or bits>**

In hexadecimal mode, this represents the number of symbols to be transmitted. In binary mode, it represents the number of bits to be transmitted.

**<ACK/NACK>**

The range is {-1...1}.

- 1 = ACK
- 0 = NACK
- -1 = DTX

**<allocation ID>**

Represents the allocation ID. The range is as follows.

- 0 - 65535 = PDSCH
- -1 = Invalid / not used
- -2 = All
- -3 = P-Sync
- -4 = S-Sync
- -5 = Reference Signal (Antenna 1)
- -6 = Reference Signal (Antenna 2)
- -7 = Reference Signal (Antenna 3)
- -8 = Reference Signal (Antenna 4)
- -9 = PCFICH
- -10 = PHICH
- -11 = PDCCH
- -12 = PBCH

**<channel type>**

- 0 = TX channel
- 1 = adjacent channel
- 2 = alternate channel

**<modulation>**

Represents the modulation scheme.

- 0 = unrecognized
- 1 = RBPSK
- 2 = QPSK
- 3 = 16QAM
- 4 = 64QAM
- 5 = 8PSK
- 6 = CAZAC
- 7 = mixed modulation
- 8 = BPSK
- 14 = 256QAM
- 15 = 1024QAM

**<PHICH duration>**

Represents the PHICH duration. The range is {1...2}.

- 1 = normal
- 2 = extended

**<PHICH resource>**

Represents the parameter  $N_g$ . The range is {1...4}.

- 1 =  $N_g$  1/6
- 2 =  $N_g$  1/2
- 3 =  $N_g$  1
- 4 =  $N_g$  2

FORMat[:DATA]..... 133  
 TRACe[:DATA]?..... 133

**FORMat[:DATA] <Format>**

This command selects the data format for the data transmission between the R&S FSV/FSV and the remote client.

**Parameters:**

<Format>            ASCII | REAL  
 \*RST:            ASCII

**Example:**            //Select data format  
                       FORM REAL

**TRACe[:DATA]? <Result>**

This command returns the trace data for the current measurement or result display.

For more information see [Chapter 9.6.1, "Using the TRACe\[:DATA\] Command"](#), on page 122.

**Query parameters:**

TRACE1 | TRACE2 |  
 TRACE3

LIST

**Usage:**            Query only

**9.6.2 Reading Results**

CALCulate<n>:LIMit<li>:ACPower:ACHannel:RESult?..... 134  
 CALCulate<n>:LIMit<li>:ACPower:ALternate<alt>:RESult?..... 134  
 CALCulate<n>:LIMit<li>:OOPower:OFFPower?..... 135  
 CALCulate<n>:LIMit<li>:OOPower:TRANSient?..... 135  
 CALCulate<n>:MARKer<m>:FUNCTion:POWER<sb>:RESult[:CURRent]?..... 136

**CALCulate<n>:LIMit<li>:ACPpower:ACHannel:RESult? [<Result>]**

This command queries the limit check results for the adjacent channels during ACLR measurements.

**Suffix:**

<n> irrelevant  
<li> irrelevant

**Query parameters:**

<Result> **ALL**  
Queries the overall limit check results.  
**REL**  
Queries the channel power limit check results.  
**ABS**  
Queries the distance to the limit line.

**Return values:**

<LimitCheck> Returns two values, one for the upper and one for the lower adjacent channel.  
**PASSED**  
Limit check has passed.  
**FAILED**  
Limit check has failed.

**Example:** //Query results of the adjacent channel limit check  
CALC:LIM:ACP:ACH:RES?

**Example:** //Query results of the adjacent channel limit check  
CALC:LIM:ACP:ACH:RES? ABS

**Usage:** Query only

**CALCulate<n>:LIMit<li>:ACPpower:ALTErnate<alt>:RESult? [<Result>]**

This command queries the limit check results for the alternate channels during ACLR measurements.

**Suffix:**

<n> irrelevant  
<li> irrelevant  
<alt> irrelevant

**Query parameters:**

<Result> **ALL**  
Queries the overall limit check results.  
**REL**  
Queries the channel power limit check results.

**ABS**

Queries the distance to the limit line.

**Return values:**

<LimitCheck> Returns two values, one for the upper and one for the lower alternate channel.

**PASSED**

Limit check has passed.

**FAILED**

Limit check has failed.

**Example:**

```
//Query results of the alternate channel limit check
CALC:LIM:ACP:ALT:RES?
```

**Example:**

```
//Query results of the alternate channel limit check
CALC:LIM:ACP:ACH:RES? ABS
```

**Usage:**

Query only

**CALCulate<n>:LIMit<li>:OOPower:OFFPower?**

This command queries the results of the limit check in the "Off" periods of On/Off Power measurements.

**Suffix:**

<n> irrelevant

<li> irrelevant

**Return values:**

<Results> Returns one value for every "Off" period.

**PASSED**

Limit check has passed.

**FAILED**

Limit check has failed.

**Example:**

```
//Query the results for the limit check during the signal OFF periods
CALC:LIM:OOP:OFFP?
```

**Usage:**

Query only

**CALCulate<n>:LIMit<li>:OOPower:TRANsient? <Result>**

This command queries the results of the limit check during the transient periods of the On/Off power measurement.

**Suffix:**

<n> irrelevant

<li> irrelevant

**Query parameters:**

<Result> **ALL**  
Queries the overall limit check results.

**FALLing**

Queries the limit check results of falling transients.

**RISing**

Queries the limit check results of rising transients.

**Return values:**

<LimitCheck>

Returns one value for every "Off" period.

**PASSED**

Limit check has passed.

**FAILED**

Limit check has failed.

**Example:**

```
//Query the limit check result of rising transients
CALC:LIM:OOP:TRAN? RIS
```

**Usage:**

Query only

---

**CALCulate<n>:MARKer<m>:FUNction:POWer<sb>:RESult[:CURRent]?**  
 [<Measurement>]

This command queries the results of the ACLR measurement or the total signal power level of the SEM measurement.

To get a valid result, you have to perform a complete measurement with synchronization to the end of the measurement before reading out the result. This is only possible for single sweeps.

**Suffix:**

<n> [Window](#)

<m> [Marker](#)

<sb> irrelevant

**Query parameters:**

<Measurement>

**CPOW**

This parameter queries the channel power of the reference range.

**Return values:**

<Result>

**Results for the Spectrum Emission Mask measurement:**

Power level in dBm.



**Results for the ACLR measurements:**

Relative power levels of the ACLR channels. The number of return values depends on the number of transmission and adjacent channels. The order of return values is:

- <TXChannelPower> is the power of the transmission channel in dBm
- <LowerAdjChannelPower> is the relative power of the lower adjacent channel in dB
- <UpperAdjChannelPower> is the relative power of the upper adjacent channel in dB
- <1stLowerAltChannelPower> is the relative power of the first lower alternate channel in dB
- <1stUpperAltChannelPower> is the relative power of the first lower alternate channel in dB
- (...)
- <nthLowerAltChannelPower> is the relative power of a subsequent lower alternate channel in dB
- <nthUpperAltChannelPower> is the relative power of a subsequent lower alternate channel in dB

**Example:** `CALC1:MARK:FUNC:POW:RES?`  
Returns the current ACLR measurement results.

**Usage:** Query only

**Manual operation:** See "Result summary" on page 49

## 9.7 General Settings

- [Defining Signal Characteristics](#)..... 137
- [Configuring the Input Level](#)..... 139
- [Configuring the Data Capture](#)..... 142
- [Configuring On/Off Power Measurements](#)..... 144

### 9.7.1 Defining Signal Characteristics

Commands to configure signal characteristics described elsewhere.

- `FETCh[:CC<cc>]:CYCPrefix?`
- `CONFigure[:LTE]:DL[:CC<cc>]:BW`..... 137
- `CONFigure[:LTE]:DL[:CC<cc>]:CYCPrefix`..... 138
- `CONFigure[:LTE]:DUPLexing`..... 138
- `CONFigure[:LTE]:LDIRection`..... 139
- `[SENSe]:FREQuency:CENTer[:CC<cc>]`..... 139

---

**CONFigure[:LTE]:DL[:CC<cc>]:BW <Bandwidth>**

This command selects the channel bandwidth.

**Suffix:**  
<CC> irrelevant

**Parameters:**  
<Bandwidth> BW1\_40 | BW3\_00 | BW5\_00 | BW10\_00 | BW15\_00 | BW20\_00  
\*RST: BW10\_00

**Example:** //Single carrier measurement:  
//Define channel bandwidth  
CONF:DL:BW BW1\_40

**Manual operation:** See "[Channel Bandwidth / Number of Resource Blocks](#)" on page 62

---

#### CONFigure[:LTE]:DL[:CC<cc>]:CYCPrefix <PrefixLength>

This command selects the cyclic prefix.

**Suffix:**  
<CC> irrelevant

**Parameters:**  
<PrefixLength> **NORM**  
Normal cyclic prefix length  
**EXT**  
Extended cyclic prefix length  
**AUTO**  
Automatic cyclic prefix length detection  
\*RST: AUTO

**Example:** //Single carrier measurements:  
//Select an extended cyclic prefix  
CONF:DL:CYCP EXT

**Manual operation:** See "[Cyclic Prefix](#)" on page 62

---

#### CONFigure[:LTE]:DUPLexing <Duplexing>

This command selects the duplexing mode.

**Parameters:**  
<Duplexing> **TDD**  
Time division duplex  
**FDD**  
Frequency division duplex  
\*RST: FDD

**Example:** //Select time division duplex  
CONF:DUPL TDD

**Manual operation:** See "[Selecting the LTE mode](#)" on page 61

**CONFigure[:LTE]:LDIRection** <Direction>

This command selects the link direction.

**Parameters:**

<Direction>	<b>DL</b> Selects the mode to analyze downlink signals.
	<b>UL</b> Selects the mode to analyze uplink signals.

**Example:** //Select downlink mode  
CONF:LDIR DL

**Manual operation:** See "[Selecting the LTE mode](#)" on page 61

**[SENSe:]FREQuency:CENTer[:CC<cc>]** <Frequency>

This command sets the center frequency for RF measurements.

Note that the [:CC<cc>] part of the syntax is not supported.

**Suffix:**

<cc> irrelevant

**Parameters:**

<Frequency> <numeric value>  
Range: fmin to fmax  
\*RST: 1 GHz  
Default unit: Hz

**Example:** //Define frequency for measurement on one carrier:  
FREQ:CENT 1GHZ

**Manual operation:** See "[Center Frequency](#)" on page 62

## 9.7.2 Configuring the Input Level

<a href="#">DISPlay[:WINDow&lt;n&gt;]:TRACe&lt;t&gt;:Y[:SCALE]:RLEVel</a> .....	139
<a href="#">DISPlay[:WINDow&lt;n&gt;]:TRACe&lt;t&gt;:Y[:SCALE]:RLEVel:OFFSet</a> .....	140
<a href="#">INPut&lt;ip&gt;:ATTenuation&lt;ant&gt;</a> .....	140
<a href="#">INPut&lt;ip&gt;:EATT&lt;ant&gt;</a> .....	140
<a href="#">INPut&lt;ip&gt;:EATT&lt;ant&gt;:STATe</a> .....	141
<a href="#">INPut&lt;ip&gt;:EATT&lt;ant&gt;:AUTO</a> .....	141
<a href="#">[SENSe:]POWer:AUTO[:STATe]</a> .....	142
<a href="#">[SENSe:]POWer:AUTO:TIME</a> .....	142

**DISPlay[:WINDow<n>]:TRACe<t>:Y[:SCALE]:RLEVel** <ReferenceLevel>

This command defines the reference level (for all traces in all windows).

With a reference level offset  $\neq 0$ , the value range of the reference level is modified by the offset.

**Suffix:**

<n> irrelevant

<t> irrelevant

**Parameters:**

<ReferenceLevel> The unit is variable.  
Range: see datasheet  
\*RST: 0 dBm  
Default unit: DBM

**Example:** `DISP:TRAC:Y:RLEV -60dBm`

**Manual operation:** See ["Reference Level"](#) on page 63

**DISPlay[:WINDow<n>]:TRACe<t>:Y[:SCALE]:RLEVel:OFFSet <Attenuation>**

This command selects the external attenuation or gain applied to the RF signal.

**Parameters:**

<Attenuation> <numeric value>  
\*RST: 0  
Default unit: dB

**Example:** `DISP:TRAC:Y:RLEV:OFFS 10`  
Sets an external attenuation of 10 dB.

**Manual operation:** See ["External Attenuation"](#) on page 64

**INPut<ip>:ATTenuation<ant> <Attenuation>**

This command defines the RF attenuation level.

**Suffix:**

<ip> irrelevant

<ant> irrelevant

**Parameters:**

<Attenuation> \*RST: 10 dB  
Default unit: dB

**Example:** `//Define RF attenuation  
INP:ATT:AUTO OFF  
INP:ATT 10`

**Manual operation:** See ["RF Attenuation"](#) on page 64

**INPut<ip>:EATT<ant> <Attenuation>**

This command defines the electronic attenuation level.

If the current reference level is not compatible with an attenuation that has been set manually, the command also adjusts the reference level.

This command is available with the optional Electronic Attenuator, but not if you are using the optional Digital Baseband Input.

**Suffix:**

<ip> irrelevant  
<ant> Connected instrument

**Parameters:**

<Attenuation> Attenuation level in dB.  
Default unit: dB

**Example:**

```
//Define signal attenuation
INP:EATT 10
```

**INPut<ip>:EATT<ant>:STATe <State>**

This command turns the electronic attenuator on and off.

This command is available with the optional Electronic Attenuator, but not if you are using the optional Digital Baseband Input.

**Suffix:**

<ip> irrelevant  
<ant> 1...4  
Connected instrument

**Parameters:**

<State> ON | OFF  
\*RST: OFF

**Example:**

```
//Turn on electronic attenuation
INP:EATT:STAT ON
```

**INPut<ip>:EATT<ant>:AUTO <State>**

This command turns automatic selection of the electronic attenuation on and off.

If on, electronic attenuation reduces the mechanical attenuation whenever possible.

This command is available with the optional Electronic Attenuator, but not if you are using the optional Digital Baseband Input.

**Suffix:**

<ip> irrelevant  
<ant> 1...4  
Connected instrument

**Parameters:**

<State> ON | OFF | 1 | 0  
\*RST: OFF

**Example:**

```
//Turn on automatic selection of electronic attenuation
INP:EATT:AUTO ON
```

**[SENSe:]POWer:AUTO[:STATe] <State>**

This command initiates a measurement that determines the ideal reference level.

**Parameters:**

<State>	<b>OFF</b> Performs no automatic reference level detection.
	<b>ON</b> Performs an automatic reference level detection before each measurement.
	<b>ONCE</b> Performs an automatic reference level once.
*RST:	ON

**Example:** POW:AUTO2 ON  
Activate auto level for analyzer number 2.

**Manual operation:** See "Auto Level" on page 60  
See "Auto Level" on page 63

**[SENSe:]POWer:AUTO:TIME <Time>**

This command defines the track time for the auto level process.

**Parameters:**

<Time>	<numeric value>
*RST:	100 ms
	Default unit: s

**Example:** POW:AUTO:TIME 200ms  
An auto level track time of 200 ms gets set.

**Manual operation:** See "Auto Level" on page 63

### 9.7.3 Configuring the Data Capture

[SENSe:][LTE:]FRAMe:COUNT.....	142
[SENSe:][LTE:]FRAMe:COUNT:AUTO.....	143
[SENSe:][LTE:]FRAMe:COUNT:STATe.....	143
[SENSe:]SWEp:TIME.....	143

**[SENSe:][LTE:]FRAMe:COUNT <Subframes>**

This command defines the number of frames you want to analyze.

Prerequisites for this command

- Turn on overall frame count ([SENSe:] [LTE:] FRAMe:COUNT:STATe).
- Turn on manual selection of frames to analyze ([SENSe:] [LTE:] FRAMe:COUNT: AUTO).

**Parameters:**

<Subframes> <numeric value> (integer only)

\*RST: 1

**Example:**

//Define number of frames to analyze manually

FRAM:COUN:STAT ON

FRAM:COUN:AUTO OFF

FRAM:COUN 20

**Manual operation:** See ["Number of Frames to Analyze"](#) on page 65

**[SENSe:][LTE:]FRAMe:COUNT:AUTO <State>**

This command turns automatic selection of the number of frames to analyze on and off.

**Parameters:**

<State> **ON | 1**

Selects the analyzed number of frames according to the LTE standard.

**OFF | 0**

Turns on manual selection of the number of frames.

**Example:**

//Turn on automatic selection of analyzed frames

FRAM:COUN:AUTO ON

**Manual operation:** See ["Auto According to Standard"](#) on page 65

**[SENSe:][LTE:]FRAMe:COUNT:STATe <State>**

This command turns manual selection of the number of frames you want to analyze on and off.

**Parameters:**

<State> **ON | 1**

You can set the number of frames to analyze.

**OFF | 0**

The R&S FSVA/FSV analyzes the frames captured in a single sweep.

\*RST: ON

**Example:**

//Turn on manual selection of number of frames

FRAM:COUN:STAT ON

**Manual operation:** See ["Overall Frame Count"](#) on page 64

**[SENSe:]SWEEp:TIME <CaptureLength>**

This command defines the capture time.

When you are performing an ACLR measurement, the command defines the sweep time. (Note that you have to select the ACLR measurement first, before defining a sweep time - otherwise, the command defines the capture time for I/Q measurements.)

**Parameters:**

<CaptureLength> <numeric value>  
 \*RST: 20.1 ms / 40.1 ms (DL TDD)  
 Default unit: s

**Example:**

//Define capture time  
 SWE:TIME 40ms

**Manual operation:**

See "Capture Time" on page 64  
 See "Sweep Time" on page 72

### 9.7.4 Configuring On/Off Power Measurements

CONFigure[LTE]:OOPower:NFRames..... 144  
 [SENSe:][LTE:]OOPower:NCORrection..... 144

---

**CONFigure[LTE]:OOPower:NFRames <Frames>**

This command defines the number of frames that are analyzed for On/Off Power measurements.

**Parameters:**

<Frames> <numeric value>

**Example:**

//Select frames to be analyzed  
 CONF:OOP:NFR 10

**Manual operation:**

See "Number of Frames" on page 66

---

**[SENSe:][LTE:]OOPower:NCORrection <State>**

This command turns noise correction for on/off power measurements on and off.

**Parameters:**

<State> ON | OFF | 1 | 0  
 \*RST: OFF

**Example:**

//Turn on noise correction  
 OOP:NCOR ON

**Manual operation:**

See "Noise Cancellation" on page 42  
 See "Noise Correction" on page 66

## 9.8 MIMO Setups

CONFigure[LTE]:DL[CC<cc>]:MIMO:ASElection..... 144  
 CONFigure[LTE]:DL[CC<cc>]:MIMO:CONFig..... 145

---

**CONFigure[LTE]:DL[CC<cc>]:MIMO:ASElection <Antenna>**

This command selects the antenna for measurements with MIMO setups.



**Suffix:**  
 <CC> irrelevant

**Parameters:**  
 <Antenna> **ANT1 | ANT2 | ANT3 | ANT4**  
 Select a single antenna to be analyzed  
**AUTO**  
 Automatically selects the antenna(s) to be analyzed.  
 \*RST: ANT1

**Example:** //Select a MIMO setup with two antennas and test antenna number two  
 CONF:DL:MIMO:CONF TX2  
 CONF:DL:MIMO:ASEL ANT2

**Manual operation:** See "Tx Antenna Selection" on page 68

**CONFigure[:LTE]:DL[:CC<cc>]:MIMO:CONFig <NoOfAntennas>**

This command sets the number of antennas in the MIMO setup.

**Suffix:**  
 <CC> irrelevant

**Parameters:**  
 <NoOfAntennas> **TX1**  
 Use one Tx-antenna  
**TX2**  
 Use two Tx-antennas  
**TX4**  
 Use four Tx-antennas  
 \*RST: TX1

**Example:** //Select MIMO configuration with two antennas  
 CONF:DL:MIMO:CONF TX2

**Manual operation:** See "DUT MIMO Configuration" on page 68

## 9.9 Advanced Settings

- [Controlling I/Q Data](#)..... 145
- [Controlling the Input](#)..... 146
- [Configuring the Digital I/Q Input](#)..... 147

### 9.9.1 Controlling I/Q Data

[\[SENSe:\]SWAPiq](#)..... 146

**[SENSe:]SWAPiq <State>**

This command turns a swap of the I and Q branches on and off.

**Parameters:**

<State> ON | OFF | 1 | 0  
\*RST: OFF

**Example:** //Swap I and Q branches  
SWAP ON

**Manual operation:** See "[Swap I/Q](#)" on page 73

## 9.9.2 Controlling the Input

For information on the remote commands for reference level and attenuation settings see [Chapter 9.7.2, "Configuring the Input Level"](#), on page 139.

<a href="#">INPut&lt;ip&gt;:SElect.....</a>	146
<a href="#">INPut&lt;n&gt;:FILTer:YIG:AUTO.....</a>	146
<a href="#">INPut&lt;ip&gt;:FILTer:YIG[:STATe].....</a>	147
<a href="#">TRACe&lt;n&gt;:IQ:FILTer:FLATness.....</a>	147

**INPut<ip>:SElect <Source>**

This command selects the signal source.

**Suffix:**

<ip> 1..n

**Parameters:**

<Source> **RF**  
Selects the RF input as the signal source.

**AIQ**  
Selects the analog baseband input as the data source. This source is available only with option R&S FSV-A/FSV-B71.

**DIQ**  
Selects the digital baseband input as the data source. This source is available only with option R&S FSV-A/FSV-B17.

**Example:** INP DIQ  
Selects the digital baseband input.

**Manual operation:** See "[Selecting the Input Source](#)" on page 73

**INPut<n>:FILTer:YIG:AUTO <State>**

This command turns automatic control of the YIG filter on and off.

**Parameters:**

<State> ON | OFF  
\*RST: ON

**Example:** `INP:FILT:YIG:AUTO ON`  
 Activates automatic control of the YIG filter.

**Manual operation:** See "Yig Filter" on page 74

**INPut<ip>:FILTer:YIG[:STATe] <State>**

This command removes or adds the YIG filter from the signal path.

If you remove the filter, you can use the maximum bandwidth, but image frequency rejection is no longer ensured.

**Suffix:**  
 <ip> 1..n

**Parameters:**  
 <State> ON | OFF  
 \*RST: ON

**Example:** `INP:FILT:YIG OFF`  
 Removes the YIG filter from the signal path.

**Manual operation:** See "Yig Filter" on page 74

**TRACe<n>:IQ:FILTer:FLATness <arg0>**

This command turns the wideband filter on and off.

**Suffix:**  
 <n> 1..n

**Parameters:**  
 <arg0> NORMAl | WIDE  
**NORMAl**  
 Uses the normal filter.  
**WIDE**  
 Turns the wideband filter on.  
 \*RST: NORMAl

**Example:** `TRAC:IQ:FILT:FLAT WIDE`  
 Turns the wideband filter on.

### 9.9.3 Configuring the Digital I/Q Input

[INPut<ip>:DIQ:SRATe.....](#) 147  
[INPut<ip>:DIQ:RANGe\[:UPPer\].....](#) 148

**INPut<ip>:DIQ:SRATe <SampleRate>**

This command defines the sampling rate for a digital I/Q signal source.

**Suffix:**  
 <ip> 1..n

**Parameters:**  
 <SampleRate> \*RST: 10 MHz  
 Default unit: Hz

**Example:** INP:DIQ:SRAT 10MHZ  
 Defines a sampling rate of 10 MHz.

**Manual operation:** See "[Sampling Rate \(Input Data Rate\)](#)" on page 75

**INPut<ip>:DIQ:RANGe[:UPPer] <Level>**

This command defines the full scale level for a digital I/Q signal source.

**Suffix:**  
 <ip> 1..n

**Parameters:**  
 <Level> \*RST: 1 V

**Example:** INP:DIQ:RANG 0.7  
 Sets the full scale level to 0.7 V.

**Manual operation:** See "[Full Scale Level](#)" on page 75

## 9.10 Trigger Configuration

The trigger functionality of the LTE measurement application is the same as that of the R&S FSVA/FSV.

For a comprehensive description of the available remote control commands for trigger configuration, see the documentation of the R&S FSVA/FSV.

TRIGger[:SEQuence]:HOLDoff<ant>[:TIME].....	148
TRIGger[:SEQuence]:IFPower:HOLDoff.....	149
TRIGger[:SEQuence]:IFPower:HYSteresis.....	149
TRIGger[:SEQuence]:LEVel<ant>[:EXternal<tp>].....	149
TRIGger[:SEQuence]:LEVel<ant>:POWer.....	150
TRIGger[:SEQuence]:LEVel<ant>:RFPOWer.....	150
TRIGger[:SEQuence]:MODE<ant>.....	150

**TRIGger[:SEQuence]:HOLDoff<ant>[:TIME] <Offset>**

This command defines the trigger offset.

**Suffix:**  
 <ant> irrelevant

**Parameters:**

<Offset> <numeric value>  
 \*RST: 0 s  
 Default unit: s

**Example:** //Define trigger offset  
 TRIG:HOLD 5MS

**Manual operation:** See ["Trigger Characteristics"](#) on page 67

**TRIGger[:SEQuence]:IFPower:HOLDoff <Period>**

This command defines the holding time before the next trigger event.

Note that this command is available for **any trigger source**, not just IF Power.

**Parameters:**

<Period> Range: 150 ns to 10 s  
 \*RST: 150 ns  
 Default unit: s

**Example:** TRIG:IFP:HOLD 1  
 Defines a holdoff of 1 second.

**Manual operation:** See ["Trigger Characteristics"](#) on page 67

**TRIGger[:SEQuence]:IFPower:HYSTeresis <Hysteresis>**

This command defines the trigger hysteresis.

**Parameters:**

<Hysteresis> Range: 3 to 50  
 \*RST: 3  
 Default unit: dB

**Example:** TRIG:IFP:HYST 10  
 Defines a trigger hysteresis of 10 dB.

**Manual operation:** See ["Trigger Characteristics"](#) on page 67

**TRIGger[:SEQuence]:LEVel<ant>[:EXTeRnal<tp>] <Level>**

This command defines the level for an external trigger.

**Suffix:**

<ant> irrelevant

<tp> irrelevant

**Parameters:**

<Level> Range: 0.5 V to 3.5 V  
 \*RST: 1.4 V  
 Default unit: V

**Example:** //Define trigger level  
TRIG:LEV 2V

**Manual operation:** See "[Trigger Characteristics](#)" on page 67

**TRIGger[:SEquence]:LEVel<ant>:POWer <Level>**

This command defines the trigger level for an IF power trigger.

**Suffix:**

<ant> 1..n  
irrelevant

**Parameters:**

<Level> Default unit: DBM

**Example:** TRIG:LEV:POW 10  
Defines a trigger level of 10 dBm.

**Manual operation:** See "[Trigger Characteristics](#)" on page 67

**TRIGger[:SEquence]:LEVel<ant>:RFPower <Level>**

This command defines the power level the RF input must exceed to cause a trigger event. Note that any RF attenuation or preamplification is considered when the trigger level is analyzed. If defined, a reference level offset is also considered.

The input signal must be between 500 MHz and 8 GHz.

**Suffix:**

<ant> irrelevant

**Parameters:**

<Level> <numeric value>

For details on available trigger levels and trigger bandwidths see the data sheet.

\*RST: -20 dBm

Default unit: dBm

**Example:** //Define trigger level  
TRIG:SOUR RFP  
TRIG:LEV:RFP -30dBm

**Manual operation:** See "[Trigger Characteristics](#)" on page 67

**TRIGger[:SEquence]:MODE<ant> <Source>**

This command selects the trigger source.

**Suffix:**  
 <ant> 1..n

**Parameters:**  
 <Source> **EXtErnal**  
 Selects external trigger source.

**IFPower**  
 Selects the IF power trigger source.

**IMMediate**  
 Selects free run trigger source.

**PSEn**  
 Selects power sensor trigger source.

**RFPower**  
 Selects RF power trigger source.

\*RST: IMMediate

**Example:** //Select an external trigger source  
 TRIG:MODE EXT

**Manual operation:** See "Trigger Source" on page 66

## 9.11 Spectrum Measurements

MMEMory:LOAD:SEMsettings.....	151
[SENSe]:FREQuency:SPAN.....	152
[SENSe]:FREQuency:SPAN:AUTO.....	152
[SENSe:]POWer:ACHannel:AACHannel.....	152
[SENSe:]POWer:ACHannel:BANDwidth:CHANnel2.....	153
[SENSe:]POWer:ACHannel:SPACing:CHANnel.....	153
[SENSe:]POWer:ACHannel:TXCHannels:COUnT.....	154
[SENSe:]POWer:NCORrection.....	154
[SENSe:]POWer:SEM:CATegory.....	154
[SENSe:]POWer:SEM:CHBS:AMPower.....	155
[SENSe:]POWer:SEM:CHBS:AMPower:AUTO.....	155
[SENSe:]POWer:SEM:USERfile.....	155
[SENSe:]SWEep:EGATe:AUTO.....	156

---

### MMEMory:LOAD:SEMsettings <FileName>

This command loads a custom SEM file.

The R&S FSVA/FSV only evaluates the custom SEM after you have turned on custom SEM file evaluation with [SENSe:]POWer:SEM:USERfile.

For more information on how to create custom SEM files, refer to the R&S FSVA/FSV User Manual.

**Parameters:**

<FileName> String containing the file name of the SEM.  
Make sure to use double backslashes as separator in the path definition as indicated in the example below.

**Example:**

```
//Load and evaluate custom SEM file
MME:LOAD:SEM 'C:\\SEM\\CustomSEM.xml'
POW:SEM:USER ON
```

**Manual operation:** See "[User SEM File](#)" on page 70

**[SENSe]:FREQuency:SPAN <Span>**

This command defines the frequency span.

Available for ACLR and SEM measurements.

**Parameters:**

<Span> Frequency span in Hz.

**Example:**

```
FREQ:SPAN:AUTO OFF
FREQ:SPAN 20MHZ
Defines a span of 20 MHz.
```

**Manual operation:** See "[Span](#)" on page 69

**[SENSe]:FREQuency:SPAN:AUTO <State>**

This command turns automatic determination of the frequency span on and off.

Available for ACLR and SEM measurements.

**Parameters:**

<State> ON | OFF

**Example:**

```
FREQ:SPAN:AUTO ON
Automatically selects an appropriate span for the measurement.
```

**Manual operation:** See "[Span](#)" on page 69

**[SENSe:]POWer:ACHannel:AACHannel <Channel>**

This command selects the bandwidth of the adjacent channel for ACLR measurements.

For MC ACLR measurements, the command selects the bandwidth of the lower adjacent channel.

**Parameters:**

<Channel>

**EUTRA**

Selects an EUTRA signal of the same bandwidth like the TX channel as assumed adjacent channel carrier.

**UTRA128**

Selects an UTRA signal with a bandwidth of 1.28MHz as assumed adjacent channel carrier.



**UTRA384**

Selects an UTRA signal with a bandwidth of 3.84MHz as assumed adjacent channel carrier.

**UTRA768**

Selects an UTRA signal with a bandwidth of 7.68MHz as assumed adjacent channel carrier.

\*RST: EUTRA

**Example:** //Select assumed adjacent channel  
POW:ACH:AACH UTRA384

**Manual operation:** See "[Assumed Adjacent Channel Carrier](#)" on page 72

**[SENSe]:POWer:ACHannel:BANDwidth:CHANnel2 <Bandwidth>**

This command defines the channel bandwidth of the second TX channel in ACLR measurements.

Before you can use the command, you have to select two TX channels for the ACLR measurement with [\[SENSe\]:POWer:ACHannel:TXChannels:COUNT](#) on page 154.

Note that you have to add a suffix with the value "2" at the CHANnel syntax element.

**Parameters:**

<Bandwidth> Bandwidth of the second TX channel in Hz.  
Supported LTE bandwidths are listed in the description of [CONFigure\[:LTE\]:DL\[:CC<cc>\]:BW](#).

**Example:** POW:ACH:TXCH:COUN 2  
POW:ACH:BAND:CHAN2 BW15\_00  
Defines a bandwidth of 15 MHz for the second TX channel.

**Manual operation:** See "[Number of TX Channels](#)" on page 72

**[SENSe]:POWer:ACHannel:SPACing:CHANnel <Distance>**

This command defines the distance between the first and the second TX channel for ACLR measurements.

Before you can use the command, you have to select two TX channels for the ACLR measurement with [\[SENSe\]:POWer:ACHannel:TXChannels:COUNT](#) on page 154.

**Parameters:**

<Distance> Distance from the center of the first TX channel to the center of the second TX channel in Hz.

**Example:** POW:ACH:TXCH:COUN 2  
POW:ACH:SPAC:CHAN 10MHZ  
Defines a channel spacing of 10 MHz.

**Manual operation:** See "[Number of TX Channels](#)" on page 72

**[SENSe]:POWer:ACHannel:TXChannels:COUNT <TXChannels>**

This command selects the number of transmission (TX) channels in ACLR measurements.

**Parameters:**

<TXChannels>      Number of transmission channels.

**1**  
One TX channel is analyzed in ACLR measurements.

**2**  
Two TX channels are analyzed in ACLR measurements.

**Example:**

```
POW:ACH:TXCH:COUN 2
Selects two TX channels for the ACLR measurement.
```

**Manual operation:** See "[Number of TX Channels](#)" on page 72

**[SENSe:]POWer:NCORrection <State>**

This command turns noise correction for ACLR measurements on and off.

**Parameters:**

<State>            ON | OFF

\*RST:            OFF

**Example:**

```
POW:NCOR ON
Activates noise correction.
```

**Manual operation:** See "[Noise Correction](#)" on page 72

**[SENSe:]POWer:SEM:CATegory <Category>**

This command selects the SEM limit category as defined in 3GPP TS 36.104.

**Parameters:**

<Category>        **A**  
Category A (wide area base station)

**B1**  
Category B Opt 1 (wide area base station)

**B2**  
Category B Opt 2 (wide area base station)

**HOME**  
Home base station

**LARE**  
Local area base station

**MED**  
Medium range base station

\*RST:            A

**Example:**

```
//Select base station category
POW:SEM:CAT MED
```

**Manual operation:** See ["Category"](#) on page 70

---

**[SENSe:]POWer:SEM:CHBS:AMPower** <Power>

This command defines the aggregated maximum power for home base stations.

**Parameters:**

<Power>                      <numeric value>  
                                     Default unit: dBm

**Example:**                    //Define base station power  
 POW:SEM:CAT MED  
 POW:SEM:CHBS:AMP:AUTO OFF  
 POW:SEM:CHBS:AMP 0

**Manual operation:** See ["Category"](#) on page 70  
 See ["Aggregated Maximum Power Of All TX Ports \(P\)"](#)  
 on page 71  
 See ["Tx Power"](#) on page 71

---

**[SENSe:]POWer:SEM:CHBS:AMPower:AUTO** <State>

This command turn automatic detection of the TX channel power on and off.

Prerequisites for this command

- Select medium range base stations ([\[SENSe:\]POWer:SEM:CATegory](#)).

When you turn off automatic detection, you can define the TX channel power manually with [\[SENSe:\]POWer:SEM:CHBS:AMPower](#).

**Parameters:**

<State>                      ON | OFF | 1 | 0  
                                     \*RST:        OFF

**Example:**                    //Turn on automatic detection of the TX channel power  
 POW:SEM:CAT MED  
 POW:SEM:CHBS:AMP:AUTO ON

**Manual operation:** See ["Category"](#) on page 70  
 See ["Tx Power"](#) on page 71

---

**[SENSe:]POWer:SEM:USERfile** <State>

This command turns the evaluation of a custom Spectrum Emission Mask (SEM) on and off.

Before you can use this command, you have to load a custom SEM file with [MMEMory:LOAD:SEMsettings](#).

**Parameters:**

<State>                      ON | OFF  
                                     \*RST:        OFF

**Example:** //Load and evaluate custom SEM file  
 MMEM:LOAD:SEM 'C:\\CustomSEM.xml'  
 POW:SEM:USER ON

**Manual operation:** See "User SEM File" on page 70

**[SENSe:]SWEep:EGATe:AUTO <State>**

This command turns auto gating for SEM and ACLR measurements on and off.

This command is available for TDD measurements in combination with an external or IF power trigger.

**Parameters:**

<State>                      **ON**  
 Evaluates the on-period of the LTE signal only.  
                                  **OFF**  
 Evaluates the complete signal.

**Example:**                      SWE:EGAT:AUTO ON  
 Turns auto gating on.

**Manual operation:** See "Auto Gating" on page 69

## 9.12 Signal Demodulation

- [Configuring the Data Analysis](#)..... 156
- [Compensating Measurement Errors](#)..... 159
- [Configuring MIMO Setups](#)..... 160

### 9.12.1 Configuring the Data Analysis

<a href="#">[SENSe:][LTE:]DL:DEMod:AUTO</a> .....	156
<a href="#">[SENSe:][LTE:]DL:DEMod:BESTimation</a> .....	157
<a href="#">[SENSe:][LTE:]DL:DEMod:CBSCrambling</a> .....	157
<a href="#">[SENSe:][LTE:]DL:DEMod:CESTimation</a> .....	157
<a href="#">[SENSe:][LTE:]DL:DEMod:EVMCalc</a> .....	158
<a href="#">[SENSe:][LTE:]DL:DEMod:MCFilter</a> .....	158
<a href="#">[SENSe:][LTE:]DL:DEMod:PRData</a> .....	158
<a href="#">[SENSe:][LTE:]DL:FORMat:PSCD</a> .....	158

**[SENSe:][LTE:]DL:DEMod:AUTO <State>**

This command turns automatic demodulation on and off.

**Parameters:**

<State>                      ON | OFF | 1 | 0  
                                  \*RST:            ON

**Example:** //Turn on auto demodulation  
DL:DEM:AUTO ON

**Manual operation:** See "[Auto PDSCH Demodulation](#)" on page 77

**[SENSe:][LTE:]DL:DEMod:BEStimation <State>**

This command turns boosting estimation on and off.

**Parameters:**

<State> ON | OFF | 1 | 0  
\*RST: ON

**Example:** //Turn on boosting estimation  
DL:DEM:BESt ON

**Manual operation:** See "[Boosting Estimation](#)" on page 78

**[SENSe:][LTE:]DL:DEMod:CBSCrambling <State>**

This command turns scrambling of coded bits on and off.

**Parameters:**

<State> ON | OFF | 1 | 0  
\*RST: ON

**Example:** //Descramble coded bits  
DL:DEM:CBSC ON

**Manual operation:** See "[Scrambling of Coded Bits](#)" on page 76

**[SENSe:][LTE:]DL:DEMod:CEStimation <Type>**

This command selects the channel estimation type.

**Parameters:**

<Type> **PIL**  
Optimal, pilot only  
**PILP**  
Optimal, pilot and payload  
**TGPP**  
3GPP EVM definition  
\*RST: TGPP

**Example:** //Select channel estimation type  
DL:DEM:CESt TGPP

**Manual operation:** See "[Channel Estimation](#)" on page 76

---

**[SENSe:][LTE:]DL:DEMod:EVMCalc** <Calculation>

This command selects the EVM calculation method.

**Parameters:**

<Calculation>           **TGPP**  
                                   3GPP definition

**OTP**  
                                   Optimal timing position

\*RST:           TGPP

**Example:**           //Select EVM calculation method  
                           DL:DEM:EVMC TGPP

**Manual operation:** See ["EVM Calculation Method"](#) on page 76

---

**[SENSe:][LTE:]DL:DEMod:MCFilter** <State>

This command turns suppression of interfering neighboring carriers on and off (e.g. LTE, WCDMA, GSM etc).

**Parameters:**

<State>                   ON | OFF | 1 | 0

\*RST:           OFF

**Example:**           //Turn on interference suppression  
                           DL:DEM:MCF ON

**Manual operation:** See ["Multicarrier Filter"](#) on page 78

---

**[SENSe:][LTE:]DL:DEMod:PRData** <Reference>

This command selects the type of reference data to calculate the EVM for the PDSCH.

**Parameters:**

<Reference>           **AUTO**  
                                   Automatic identification of reference data.

**ALLO**  
                                   Reference data is 0, according to the test model definition.

**Example:**           //Select reference data for PDSCH demodulation  
                           DL:DEM:PRD ALLO

**Manual operation:** See ["PDSCH Reference Data"](#) on page 78

---

**[SENSe:][LTE:]DL:FORMat:PSCD** <Format>

This command selects the method of identifying the PDSCH resource allocation.

**Parameters:**

<Format>               **OFF**  
                                   Applies the user configuration of the PDSCH subframe regardless of the signal characteristics.

**PDCCH**

Identifies the configuration according to the data in the PDCCH DCIs.

**PHYDET**

Manual PDSCH configuration: analysis only if the actual sub-frame configuration matches the configured one.  
Automatic PDSCH configuration: physical detection of the configuration.

\*RST: PHYD

**Example:** //Select user configuration and do not check the received signal  
DL:FORM:PSCD OFF

**Manual operation:** See "PDSCH Subframe Configuration Detection" on page 77

### 9.12.2 Compensating Measurement Errors

[SENSe:][LTE:]DL:TRACking:PHASe..... 159  
[SENSe:][LTE:]DL:TRACking:TIME..... 159

---

**[SENSe:][LTE:]DL:TRACking:PHASe <Type>**

This command selects the phase tracking type.

**Parameters:**

<Type>                   **OFF**  
Deactivate phase tracking

**PIL**  
Pilot only

**PILP**  
Pilot and payload

\*RST:                   OFF

**Example:** //Select phase tracking type  
DL:TRAC:PHAS PILPAY

**Manual operation:** See "Phase" on page 78

---

**[SENSe:][LTE:]DL:TRACking:TIME <State>**

This command turns timing tracking on and off.

**Parameters:**

<State>                   ON | OFF | 1 | 0

\*RST:                   OFF

**Example:** //Turn on timing tracking  
DL:TRAC:TIME ON

**Manual operation:** See "Timing" on page 79

### 9.12.3 Configuring MIMO Setups

CONFigure[:LTE]:DL[:CC<cc>]:MIMO:CROSstalk..... 160

---

**CONFigure[:LTE]:DL[:CC<cc>]:MIMO:CROSstalk <State>**

This command turns MIMO crosstalk compensation on and off.

**Suffix:**

<cc>                      irrelevant

**Parameters:**

<State>                    ON | OFF | 1 | 0  
 \*RST:                      OFF

**Example:**

```
//Turn on crosstalk compensation
CONF:DL:MIMO:CROS ON
```

**Manual operation:** See "Compensate Crosstalk" on page 79

## 9.13 Frame Configuration

- [Configuring TDD Signals](#).....160
- [Configuring the Physical Layer Cell Identity](#).....161
- [Configuring PDSCH Subframes](#).....163

### 9.13.1 Configuring TDD Signals

CONFigure[:LTE]:DL[:CC<cc>]:TDD:SPSC..... 160

CONFigure[:LTE]:DL[:CC<cc>]:TDD:UDConf..... 161

---

**CONFigure[:LTE]:DL[:CC<cc>]:TDD:SPSC <Configuration>**

This command selects the special TDD subframe configuration.

**Suffix:**

<cc>                      irrelevant

**Parameters:**

<Configuration>            <numeric value> (integer only)  
 Numeric value that defines the subframe configuration.  
 Subframe configurations 7 and 8 are only available if the cyclic  
 prefix is normal.  
 Range:                      0 to 8  
 \*RST:                      0



**Example:**               //Single carrier measurements:  
                           //Select subframe configuration 7, available only with a normal  
                           cyclic prefix  
                           CONF:DL:CYCP NORM  
                           CONF:DL:TDD:SPSC 7

**Manual operation:** See "[Conf. of Special Subframe](#)" on page 81

#### CONFigure[:LTE]:DL[:CC<cc>]:TDD:UDConf <Configuration>

This command selects the subframe configuration for TDD signals.

**Suffix:**

<cc>                       irrelevant

**Parameters:**

<Configuration>       <numeric value> (integer only)

Range:       0 to 6

\*RST:       0

**Example:**               //Single carrier measurements:  
                           //Selects allocation configuration  
                           CONF:DL:TDD:UDC 4

**Manual operation:** See "[TDD UL/DL Allocations](#)" on page 80

### 9.13.2 Configuring the Physical Layer Cell Identity

Commands to configure the physical layer cell ID described elsewhere.

- [FETCh\[:CC<cc>\]:PLC:CIDGroup?](#)
- [FETCh\[:CC<cc>\]:PLC:PLID?](#)

[CONFigure\[:LTE\]:DL\[:CC<cc>\]:PLC:CID](#)..... 161

[CONFigure\[:LTE\]:DL\[:CC<cc>\]:PLC:CIDGroup](#)..... 162

[CONFigure\[:LTE\]:DL\[:CC<cc>\]:PLC:PLID](#)..... 162

#### CONFigure[:LTE]:DL[:CC<cc>]:PLC:CID <CellID>

This command defines the cell ID.

**Suffix:**

<cc>                       irrelevant

**Parameters:**

<CellID>

**AUTO**

Automatically defines the cell ID.

**<numeric value> (integer only)**

Number of the cell ID.

Range:       0 to 503

**Example:** //Select two carriers and define a cell ID for each  
 CONF:NOCC 2  
 CONF:DL:CC1:PLC:CID 12  
 CONF:DL:CC2:PLC:CID 15  
 Selects 2 carriers and defines a cell ID for each one.

**Manual operation:** See ["Configuring the Physical Layer Cell Identity"](#) on page 81

**CONFigure[LTE]:DL[:CC<cc>]:PLC:CIDGroup <GroupNumber>**

This command selects the cell ID group.

**Suffix:**

<cc> irrelevant

**Parameters:**

<GroupNumber> **AUTO**  
 Automatic selection  
**0...167 (integer only)**  
 Manual selection  
 \*RST: AUTO

**Example:** //Select cell identity group  
 CONF:DL:PLC:CIDG 134  
 //Turn on automatic cell identity group detection  
 CONF:DL:PLC:CIDG AUTO

**Manual operation:** See ["Configuring the Physical Layer Cell Identity"](#) on page 81

**CONFigure[LTE]:DL[:CC<cc>]:PLC:PLID <Identity>**

This command defines the physical layer cell identity for downlink signals.

**Suffix:**

<cc> irrelevant

**Parameters:**

<Identity> **AUTO**  
 Automatic selection  
**0...2 (integer only)**  
 Manual selection  
 \*RST: AUTO

**Example:** //Select physical layer cell identity  
 CONF:DL:PLC:PLID 1

**Manual operation:** See ["Configuring the Physical Layer Cell Identity"](#) on page 81

### 9.13.3 Configuring PDSCH Subframes

CONFigure[:LTE]:DL[:CC<cc>]:CSUBframes.....	163
CONFigure[:LTE]:DL[:CC<cc>]:SUBFrame<sf>:ALCount.....	163
CONFigure[:LTE]:DL[:CC<cc>]:SUBFrame<sf>:ALLoc<al>[:CW<cw>]:MODulation.....	163
CONFigure[:LTE]:DL[:CC<cc>]:SUBFrame<sf>:ALLoc<al>:POWER.....	164
CONFigure[:LTE]:DL[:CC<cc>]:SUBFrame<sf>:ALLoc<al>:RBCount.....	164
CONFigure[:LTE]:DL[:CC<cc>]:SUBFrame<sf>:ALLoc<al>:RBOffset.....	165
CONFigure[:LTE]:DL[:CC<cc>]:SUBFrame<sf>:ALLoc<al>:UEID.....	165

---

#### CONFigure[:LTE]:DL[:CC<cc>]:CSUBframes <Subframes>

This command selects the number of configurable subframes in the downlink signal.

**Suffix:**

<cc>                    irrelevant

**Parameters:**

<Subframes>            Range:        0 to 39  
 \*RST:            1

**Example:**            //Define the number of configurable subframes  
 CONF:DL:CSUB 5

---

#### CONFigure[:LTE]:DL[:CC<cc>]:SUBFrame<sf>:ALCount <Allocations>

This command defines the number of allocations in a downlink subframe.

**Suffix:**

<cc>                    irrelevant

<sf>                    [Subframe](#)

**Parameters:**

<Allocations>         <numeric value>  
 \*RST:            1

**Example:**            //Define number of allocations in a subframe  
 CONF:DL:SUBF2:ALC 5

---

#### CONFigure[:LTE]:DL[:CC<cc>]:SUBFrame<sf>:ALLoc<al>[:CW<cw>]:MODulation <Modulation>

This command selects the modulation of an allocation in a downlink subframe.

In case of MIMO there might be more than one codewords which can be configured separately.

**Suffix:**

<cc>                    irrelevant

<sf>                    [Subframe](#)

<al>                    [Allocation](#)

<cw> [Codeword](#)

**Parameters:**

<Modulation> **QPSK**  
QPSK modulation

**QAM16**  
16QAM modulation

**QAM64**  
64QAM modulation

**QAM256**  
256QAM modulation

**Q1K**  
1024QAM modulation

\*RST: QPSK

**Example:** //Select modulation for the second codeword in allocation 5 in subframe 2

```
CONF:DL:SUBF2:ALL5:CW2:MOD QAM64
```

**Manual operation:** See "[Modulation](#)" on page 84

**CONFigure[LTE]:DL[:CC<cc>]:SUBFrame<sf>:ALLoc<al>:POWER <Power>**

This command defines the (relative) power of an allocation in a downlink subframe.

**Suffix:**

<cc> irrelevant

<sf> [Subframe](#)

<al> [Allocation](#)

**Parameters:**

<Power> <numeric value>

\*RST: 0 dB

Default unit: dB

**Example:** //Define relative power for allocation 5 in subframe 2.

```
CONF:DL:SUBF2:ALL5:POW -1.3
```

**Manual operation:** See "[Power](#)" on page 84

**CONFigure[LTE]:DL[:CC<cc>]:SUBFrame<sf>:ALLoc<al>:RBCCount  
<ResourceBlocks>**

This command selects the number of resource blocks of an allocation in a downlink subframe.

**Suffix:**

<cc> irrelevant

<sf> [Subframe](#)

<al> [Allocation](#)

**Parameters:**

<ResourceBlocks> <numeric value>  
 \*RST: 6

**Example:**

//Define resource blocks for allocation 5 in subframe 2  
 CONF:DL:SUBF2:ALL5:RBC 25

**Manual operation:** See "[Number of RB](#)" on page 84

**CONFigure[LTE]:DL[:CC<cc>]:SUBFrame<sf>:ALLoc<al>:RBOffset <Offset>**

This command defines the resource block offset of an allocation in a downlink subframe.

**Suffix:**

<cc> irrelevant  
 <sf> [Subframe](#)  
 <al> [Allocation](#)

**Parameters:**

<Offset> <numeric value>  
 \*RST: 0

**Example:**

//Define resource block offset for allocation 5 in subframe 2  
 CONF:DL:SUBF2:ALL5:RBOF 3

**Manual operation:** See "[Offset RB](#)" on page 84

**CONFigure[LTE]:DL[:CC<cc>]:SUBFrame<sf>:ALLoc<al>:UEID <ID>**

This command defines the ID or N\_RNTI.

**Suffix:**

<cc> irrelevant  
 <sf> [Subframe](#)  
 <al> [Allocation](#)

**Parameters:**

<ID> ID of the user equipment.

**Example:**

//Assign ID to allocation 5 in subframe 2  
 CONF:DL:SUBF2:ALL5:UEID 5

**Manual operation:** See "[ID/N\\_RNTI](#)" on page 83

## 9.14 Advanced Signal Characteristics

- [Defining the PDSCH Resource Block Symbol Offset](#)..... 166
- [Configuring the Reference Signal](#)..... 166
- [Configuring the Synchronization Signal](#)..... 167
- [Configuring the Control Channel](#)..... 168
- [Configuring the Shared Channel](#)..... 172

### 9.14.1 Defining the PDSCH Resource Block Symbol Offset

[CONFigure\[:LTE\]:DL\[:CC<cc>\]:PSOffset](#)..... 166

---

**CONFigure[:LTE]:DL[:CC<cc>]:PSOffset <Offset>**

This command defines the symbol offset for PDSCH allocations relative to the start of the subframe.

The offset applies to all subframes.

**Suffix:**

<cc>                      irrelevant

**Parameters:**

<Offset>                      **AUTO**  
Automatically determines the symbol offset.

**<numeric value>**  
Manual selection of the symbol offset.

                                    Range:        0 to 4

                                    \*RST:        AUTO

**Example:**                      //Define PRB symbol offset  
CONF:DL:PSOF 2

**Manual operation:**        See "[PRB Symbol Offset](#)" on page 86

### 9.14.2 Configuring the Reference Signal

[CONFigure\[:LTE\]:DL\[:CC<cc>\]:REFSig:POWER](#)..... 166

---

**CONFigure[:LTE]:DL[:CC<cc>]:REFSig:POWER <Power>**

This command defines the relative power of the reference signal.

**Suffix:**

<cc>                      irrelevant

**Parameters:**

<Power>                      <numeric value>

                                    \*RST:        0 dB

                                    Default unit: dB

**Example:** //Define a relative power for reference signal  
 CONF:DL:REFS:POW -1.2

**Manual operation:** See "[Rel Power \(Reference Signal\)](#)" on page 86

### 9.14.3 Configuring the Synchronization Signal

CONFigure[:LTE]:DL[:CC<cc>]:SYNC:ANTenna.....	167
CONFigure[:LTE]:DL[:CC<cc>]:SYNC:PPOWer.....	167
CONFigure[:LTE]:DL[:CC<cc>]:SYNC:SPOWer.....	167

---

#### CONFigure[:LTE]:DL[:CC<cc>]:SYNC:ANTenna <Antenna>

This command selects the antenna that transmits the P-SYNC and the S-SYNC.

**Suffix:**

<cc> irrelevant

**Parameters:**

<Antenna> ANT1 | ANT2 | ANT3 | ANT4 | ALL | NONE  
 \*RST: ALL

**Example:** CONF:DL:SYNC:ANT ALL  
 All antennas are used to transmit the P-SYNC and S-SYNC.

**Manual operation:** See "[P-/S-SYNC Tx Antenna](#)" on page 87

---

#### CONFigure[:LTE]:DL[:CC<cc>]:SYNC:PPOWer <Power>

This command defines the relative power of the P-SYNC.

**Suffix:**

<cc> irrelevant

**Parameters:**

<Power> <numeric value>  
 \*RST: 0 dB  
 Default unit: dB

**Example:** //Define relative power for P-SYNC  
 CONF:DL:SYNC:PPOW 0.5

**Manual operation:** See "[P-Sync Relative Power](#)" on page 87

---

#### CONFigure[:LTE]:DL[:CC<cc>]:SYNC:SPOWer <Power>

This command defines the relative power of the S-SYNC.

**Suffix:**

<cc> irrelevant

**Parameters:**

<Power> <numeric value>  
 \*RST: 0 dB  
 Default unit: dB

**Example:**

//Define relative power for S-SYNC  
 CONF:DL:SYNC:SPOW 0.5

**Manual operation:**

See "S-Sync Relative Power" on page 87

### 9.14.4 Configuring the Control Channel

CONFigure[:LTE]:DL[:CC<cc>]:PBCH:Power.....	168
CONFigure[:LTE]:DL[:CC<cc>]:PBCH:STAT.....	168
CONFigure[:LTE]:DL[:CC<cc>]:PCFich:Power.....	169
CONFigure[:LTE]:DL[:CC<cc>]:PCFich:STAT.....	169
CONFigure[:LTE]:DL[:CC<cc>]:PDCCh:FORMat.....	169
CONFigure[:LTE]:DL[:CC<cc>]:PDCCh:NOPD.....	170
CONFigure[:LTE]:DL[:CC<cc>]:PDCCh:POWER.....	170
CONFigure[:LTE]:DL[:CC<cc>]:PHICh:DURation.....	170
CONFigure[:LTE]:DL[:CC<cc>]:PHICh:MITM.....	171
CONFigure[:LTE]:DL[:CC<cc>]:PHICh:NGParameter.....	171
CONFigure[:LTE]:DL[:CC<cc>]:PHICh:NOGRoups.....	171
CONFigure[:LTE]:DL[:CC<cc>]:PHICh:POWER.....	172

---

**CONFigure[:LTE]:DL[:CC<cc>]:PBCH:POWER <Power>**

This command defines the relative power of the PBCH.

**Suffix:**

<cc> irrelevant

**Parameters:**

<Power> <numeric value>  
 \*RST: 0 dB  
 Default unit: dB

**Example:**

//Define PBCH power  
 CONF:DL:PBCH:POW -1.1

**Manual operation:**

See "PBCH Relative Power" on page 88

---

**CONFigure[:LTE]:DL[:CC<cc>]:PBCH:STAT <State>**

This command turns the PBCH on and off.

**Suffix:**

<cc> irrelevant

**Parameters:**

<State> ON | OFF | 1 | 0  
 \*RST: ON



**Example:** //Turn on PBCH  
CONF:DL:PBCH:STAT ON

**Manual operation:** See "[PBCH Present](#)" on page 88

#### CONFigure[LTE]:DL[:CC<cc>]:PCFich:POWer <Power>

This command defines the relative power of the PCFICH.

**Suffix:**  
<cc> irrelevant

**Parameters:**  
<Power> <numeric value>  
\*RST: 0 dB  
Default unit: dB

**Example:** //Define relative PCFICH power  
CONF:DL:PCF:POW 0

**Manual operation:** See "[PCFICH Relative Power](#)" on page 88

#### CONFigure[LTE]:DL[:CC<cc>]:PCFich:STAT <State>

This command turns the PCFICH on and off.

**Suffix:**  
<cc> irrelevant

**Parameters:**  
<State> ON | OFF | 1 | 0  
\*RST: ON

**Example:** //Turn on PCFICH  
CONF:DL:PCF:STAT ON

**Manual operation:** See "[PCFICH Present](#)" on page 88

#### CONFigure[LTE]:DL[:CC<cc>]:PDCCh:FORMat <Format>

This command selects the PDCCH format.

**Suffix:**  
<cc> irrelevant

**Parameters:**  
<Format> -1 | 0 | 1 | 2 | 3  
\*RST: -1

**Example:** //Select PDCCH format  
CONF:DL:PDCCH:FORM 0

**Manual operation:** See "[PDCCH Format](#)" on page 91

---

**CONFigure[:LTE]:DL[:CC<cc>]:PDCCh:NOPD <Quantity>**

This command sets the number of PDCCHs.

**Suffix:**

<cc> irrelevant

**Parameters:**

<Quantity> <numeric value>

\*RST: 0

**Example:**

```
//Select number of PDCCHs
CONF:DL:PDCCH:NOPD 3
```

**Manual operation:** See "[Number of PDCCHs](#)" on page 91

---

**CONFigure[:LTE]:DL[:CC<cc>]:PDCCh:POWer <Power>**

This command defines the relative power of the PDCCH.

**Suffix:**

<cc> irrelevant

**Parameters:**

<Power> <numeric value>

\*RST: 0 dB

Default unit: dB

**Example:**

```
//Define relative power for PDCCH
CONF:DL:PDCCH:POW -1.2
```

**Manual operation:** See "[PDCCH Rel Power](#)" on page 91

---

**CONFigure[:LTE]:DL[:CC<cc>]:PHICH:DURation <Duration>**

This command selects the PHICH duration.

**Suffix:**

<cc> irrelevant

**Parameters:**

<Duration> **NORM**

Normal

**EXT**

Extended

\*RST: NORM

**Example:**

```
//Select PHICH duration
CONF:DL:PHIC:DUR NORM
```

**Manual operation:** See "[PHICH Duration](#)" on page 89

**CONFigure[:LTE]:DL[:CC<cc>]:PHICH:MITM <State>**

This command includes or excludes the use of the PHICH special setting for enhanced test models.

**Suffix:**

<cc> irrelevant

**Parameters:**

<State> ON | OFF | 1 | 0  
\*RST: OFF

**Example:** //Activate PHICH TDD m\_i=1 (E-TM)  
CONF:DL:PHICH:MITM ON

**Manual operation:** See "[PHICH TDD m\\_i=1 \(E-TM\)](#)" on page 89

**CONFigure[:LTE]:DL[:CC<cc>]:PHICH:NGParameter <Method>**

This command selects the method that determines the number of PHICH groups in a subframe.

**Suffix:**

<cc> irrelevant

**Parameters:**

<Method> AUTO | NG1\_6 | NG1\_2 | NG1 | NG2 | NGCustom  
Select `NGCUSTOM` to customize  $N_g$ . You can then define the number of PHICH groups with `CONFigure[:LTE]:DL[:CC<cc>]:PHICH:NOGRoups`.  
\*RST: NG1\_6

**Example:** //Number of PHICH groups in the subframe depends on the number of resource blocks  
CONF:DL:PHICH:NGP NG1\_6  
//Define a custom number of PHICH groups  
CONF:DL:PHICH:NGP NGCUSTOM  
CONF:DL:PHICH:NOGR 5

**Manual operation:** See "[PHICH N\\_g](#)" on page 90

**CONFigure[:LTE]:DL[:CC<cc>]:PHICH:NOGRoups <NoOfGroups>**

This command defines the number of PHICH groups.

**Suffix:**

<cc> irrelevant

**Parameters:**

<NoOfGroups> <numeric value> (integer only)  
\*RST: 0

**Example:** //Define number of PHICH groups  
CONF:DL:PHICH:NOGR 5

**Manual operation:** See "PHICH Number of Groups" on page 90

---

**CONFigure[:LTE]:DL[:CC<cc>]:PHICH:POWer** <Power>

This command defines the relative power of the PHICH.

**Suffix:**

<cc> irrelevant

**Parameters:**

<Power> <numeric value>  
 \*RST: -3.01 dB  
 Default unit: DB

**Example:** //Define the relative power of the PHICH  
 CONF:DL:PHIC:POW -1.3

**Manual operation:** See "PHICH Rel Power" on page 90

### 9.14.5 Configuring the Shared Channel

[CONFigure\[:LTE\]:DL\[:CC<cc>\]:PDSCh:PB](#)..... 172

---

**CONFigure[:LTE]:DL[:CC<cc>]:PDSCh:PB** <PowerRatio>

This command selects the PDSCH power ratio.

Note that the power ratio depends on the number of antennas in the system.

**Suffix:**

<cc> irrelevant

**Parameters:**

<PowerRatio> Numeric value that defines PDSCH P<sub>B</sub> which defines the power ratio in dB.  
**0 | 1 | 2 | 3**  
 See [PDSCH Power Ratio](#) for an overview of resulting power ratios.

**RAT1**

Ratio = 1, regardless of the number of antennas.

**Example:** //Select PDSCH P<sub>B</sub>  
 CONF:DL:PDSCh:PB 3

**Manual operation:** See "PDSCH Power Ratio" on page 91

## 9.15 Measurement Result Analysis

- [Selecting Displayed Data](#)..... 173
- [Selecting Units](#)..... 175
- [Using Markers](#)..... 176
- [Using Delta Markers](#)..... 178
- [Scaling the Vertical Diagram Axis](#)..... 181

### 9.15.1 Selecting Displayed Data

[SENSe:][LTE:][CC<cc>:]ALlocation:SElect.....	173
[SENSe:][LTE:][CC<cc>:]CARRier:SElect.....	173
[SENSe:][LTE:][CC<cc>:]LOCation:SElect.....	174
[SENSe:][LTE:][CC<cc>:]MODulation:SElect.....	174
[SENSe:][LTE:][CC<cc>:]SUBFrame:SElect.....	175
[SENSe:][LTE:][CC<cc>:]SYMBOL:SElect.....	175

---

#### [SENSe:][LTE:][CC<cc>:]ALlocation:SElect <Allocation>

This command filters the displayed results in the constellation diagram by a certain type of allocation.

**Suffix:**

<cc>                      irrelevant

**Parameters:**

<Allocation>

**ALL**

Shows the results for all allocations.

**<numeric\_value> (integer only)**

Shows the results for a single allocation type.

Allocation types are mapped to numeric values. For the code assignment, see [Chapter 9.6.1.20, "Return Value Codes"](#), on page 131.

\*RST:            ALL

**Example:**

```
//Display results for PDCCH
ALL:SEL -11
```

**Manual operation:** See ["Evaluation range for the constellation diagram"](#) on page 95

---

#### [SENSe:][LTE:][CC<cc>:]CARRier:SElect <Carrier>

This command filters the results in the constellation diagram by a certain subcarrier.

**Suffix:**

<cc>                      irrelevant

**Parameters:**

<Carrier>

**ALL**

Shows the results for all subcarriers.

**<numeric\_value> (integer only)**

Shows the results for a single subcarrier.

\*RST: ALL

**Example:** //Display results for subcarrier 1  
CARR:SEL 1

**Manual operation:** See ["Evaluation range for the constellation diagram"](#) on page 95

**[SENSe:][LTE:][CC<cc>:]LOCation:SElect <Location>**

This command selects the data source of the constellation diagram.

**Suffix:**

&lt;cc&gt; irrelevant

**Parameters:**

&lt;Location&gt;

**AMD**

After the MIMO decoder

**BMD**

Before the MIMO decoder

\*RST: BMD

**Example:** //Use data from after the MIMO decoder  
LOC:SEL AMD

**Manual operation:** See ["Evaluation range for the constellation diagram"](#) on page 95

**[SENSe:][LTE:][CC<cc>:]MODulation:SElect <Modulation>**

This command filters the results in the constellation diagram by a certain type of modulation.

**Suffix:**

&lt;cc&gt; irrelevant

**Parameters:**

&lt;Modulation&gt;

**ALL**

Shows the results for all modulation types.

**<numeric\_value> (integer only)**

Shows the results for a single modulation type.

Modulation types are mapped to numeric values. For the code assignment, see [Chapter 9.6.1.20, "Return Value Codes"](#), on page 131.

\*RST: ALL

**Example:** //Display results for all elements with a QPSK modulation  
MOD:SEL 2

**Manual operation:** See ["Evaluation range for the constellation diagram"](#) on page 95

---

**[SENSe:][LTE:][CC<cc>:]SUBFrame:SElect <Subframe>**

This command selects the subframe to be analyzed.

**Suffix:**

<cc>                    irrelevant

**Parameters:**

<Subframe>            ALL | <numeric value>

**ALL**

Select all subframes

**0...39**

Select a single subframe

\*RST:            ALL

**Example:**

//Display results for all subframes

SUBF:SEL ALL

**Manual operation:** See "[Subframe Selection](#)" on page 93

---

**[SENSe:][LTE:][CC<cc>:]SYMBOL:SElect <Symbol>**

This command filters the results in the constellation diagram by a certain OFDM symbol.

**Suffix:**

<cc>                    irrelevant

**Parameters:**

<Symbol>

**ALL**

Shows the results for all subcarriers.

**<numeric\_value> (integer only)**

Shows the results for a single OFDM symbol.

\*RST:            ALL

**Example:**

//Display result for OFDM symbol 2

SYMB:SEL 2

**Manual operation:** See "[Evaluation range for the constellation diagram](#)" on page 95

## 9.15.2 Selecting Units

[UNIT:BSTR](#).....175

[UNIT:EVM](#).....176

---

**UNIT:BSTR <Unit>**

This command selects the way the bit stream is displayed.

**Parameters:**

<Unit>

**SYMBOLs**

Displays the bit stream using symbols

**BITs**

Displays the bit stream using bits

\*RST: SYMBols

**Example:** //Display bit stream as bits  
UNIT:BSTR BIT

**Manual operation:** See "Bit Stream Format" on page 94

**UNIT:EVM <Unit>**

This command selects the EVM unit.

**Parameters:**

<Unit> **DB**  
EVM results returned in dB

**PCT**  
EVM results returned in %

\*RST: PCT

**Example:** //Display EVM results in %  
UNIT:EVM PCT

**Manual operation:** See "EVM Unit" on page 94

**9.15.3 Using Markers**

CALCulate<n>:MARKer<m>:AOFF..... 176

CALCulate<n>:MARKer<m>:MAXimum[:PEAK]..... 176

CALCulate<n>:MARKer<m>:MINimum[:PEAK]..... 177

CALCulate<n>:MARKer<m>[:STATE]..... 177

CALCulate<n>:MARKer<m>:TRACe..... 177

CALCulate<n>:MARKer<m>:X..... 178

CALCulate<n>:MARKer<m>:Y..... 178

**CALCulate<n>:MARKer<m>:AOFF**

This command turns all markers and delta markers off.

**Suffix:**

<n> 1..n

<m> 1..n

**Example:** CALC:MARK:AOFF  
Turns off all markers.

**Usage:** Event

**CALCulate<n>:MARKer<m>:MAXimum[:PEAK]**

This command positions a marker on the peak value of the trace.



**Suffix:**  
 <n> [Window](#)  
 <m> [Marker](#)

**Example:** //Position marker 2 on the peak value  
 CALC:MARK2:MAX

**Usage:** Event

**CALCulate<n>:MARKer<m>:MINimum[:PEAK]**

This command positions a marker on the minimum value of the trace.

**Suffix:**  
 <n> [Window](#)  
 <m> [Marker](#)

**Example:** //Position marker 1 on the minimum value  
 CALC:MARK:MIN

**Usage:** Event

**CALCulate<n>:MARKer<m>[:STATe] <State>**

This command turns markers on and off.

**Suffix:**  
 <n> [Window](#)  
 <m> [Marker](#)

**Parameters:**  
 <State> ON | OFF  
 \*RST: OFF

**Example:** //Turn on a marker  
 CALC:MARK3 ON

**CALCulate<n>:MARKer<m>:TRACe <Trace>**

This command positions the marker on a particular trace.

If necessary, the command turns on the marker first.

**Suffix:**  
 <n> [Window](#)  
 <m> [Marker](#)

**Parameters:**  
 <Trace> 1 | 2 | 3  
 Number of the trace you want the marker positioned on.

**Example:** //Position marker on a trace  
CALC:MARK3:TRAC 2

---

#### CALCulate<n>:MARKer<m>:X <Position>

This command positions a marker on a particular coordinate on the x-axis.

If necessary, the command first turns on the marker.

**Suffix:**

<n> [Window](#)

<m> [Marker](#)

**Parameters:**

<Position> Numeric value that defines the marker position on the x-axis.  
Default unit: The unit depends on the result display.

**Example:** //Move a marker to the frequency of 1 GHz  
CALC:MARK:X 1GHZ

---

#### CALCulate<n>:MARKer<m>:Y <Result>

This command queries the position of a marker on the y-axis.

If necessary, the command activates the marker first.

To get a valid result, you have to perform a complete measurement with synchronization to the end of the measurement before reading out the result. This is only possible for single sweeps.

**Suffix:**

<n> [Window](#)

<m> [Marker](#)

**Parameters:**

<Result>

**Example:** //Select a single measurement  
INIT:CONT OFF  
//Start a measurement and waits until it is done  
INIT;\*WAI  
//Turn on a marker and query its position on the y-axis  
CALC:MARK2 ON  
CALC:MARK2:Y?

### 9.15.4 Using Delta Markers

CALCulate<n>:DELTamarker<m>:AOFF.....	179
CALCulate<n>:DELTamarker<m>:MAXimum[:PEAK].....	179
CALCulate<n>:MARKer<m>:MINimum[:PEAK].....	179
CALCulate<n>:DELTamarker<m>[:STATE].....	179

CALCulate<n>:DELTamarker<m>:TRACe.....	180
CALCulate<n>:DELTamarker<m>:X.....	180
CALCulate<n>:DELTamarker<m>:Y?.....	180

---

#### CALCulate<n>:DELTamarker<m>:AOFF

This command turns all delta markers off.

**Suffix:**

<m> 1

**Example:**

CALC:DELT:AOFF  
Turns off all delta markers.

**Usage:**

Event

---

#### CALCulate<n>:DELTamarker<m>:MAXimum[:PEAK]

This command positions a marker on the peak value of the trace.

**Suffix:**

<m> 1..n

**Example:**

CALC:DELT2:MAX  
Positions delta marker 2 on the trace peak.

**Usage:**

Event

---

#### CALCulate<n>:MARKer<m>:MINimum[:PEAK]

This command positions a delta marker on the minimum value of the trace.

**Suffix:**

<m> 1..n

**Example:**

CALC:DELT2:MIN  
Positions delta marker 2 on the trace minimum.

**Usage:**

Event

---

#### CALCulate<n>:DELTamarker<m>[:STATe] <State>

This command turns delta markers on and off.

**Suffix:**

<m> 1

**Parameters:**

<State> ON | OFF  
\*RST: OFF

**Example:**

CALC:DELT3 ON  
Turns on delta marker 3.

**CALCulate<n>:DELTamarker<m>:TRACe <Trace>**

This command positions a delta marker on a particular trace.

**Suffix:**

<m> 1

**Parameters:**

<Trace> 1 | 2 | 3

Number of the trace you want the delta marker positioned on.

**CALCulate<n>:DELTamarker<m>:X <Position>**

This command positions a delta marker on a particular coordinate on the x-axis.

If necessary, the command first turns on the delta marker.

**Suffix:**

<m> 1

**Parameters:**

<Position> Numeric value that defines the delta marker position on the x-axis.

Default unit: The unit depends on the result display.

**Example:**

```
CALC:DELT2:X 1GHZ
```

Positions delta marker 2 on the frequency of 1 GHz.

**CALCulate<n>:DELTamarker<m>:Y?**

This command queries the position of a delta marker on the y-axis.

If necessary, the command activates the delta marker first.

To get a valid result, you have to perform a complete measurement with synchronization to the end of the measurement before reading out the result. This is only possible for single sweeps.

**Suffix:**

<m> 1

**Example:**

```
INIT:CONT OFF
```

Switches to single measurement mode.

```
CALC:DELT2 ON
```

Turns on delta marker 2.

```
INIT;*WAI
```

Starts a measurement and waits for the end.

```
CALC:MARK2:Y?
```

Queries the measurement result at the position of delta marker 2.

**Usage:**

Query only

## 9.15.5 Scaling the Vertical Diagram Axis

### Programming example to scale the y-axis

```
//Start EVM vs Symbol result display in screen B.
CALC2:FEED 'EVM:EVSY'
//Refresh the measurement results based on the contents of the capture buffer
INIT:IMM
//Select screen B.
DISP:WIND2:SEL
//Select dB as the EVM unit.
UNIT:EVM DB
//Define the point of origin of 5 dB on the y-axis.
DISP:TRAC:Y:SCAL:FIXS:OFFS 5
//Define the distance of 10 dB between two grid lines on the y-axis.
DISP:TRAC:Y:SCAL:FIXS:PERD 10
```

DISPlay[:WINDow]:TRACe:Y:SCALe:AUTO.....	181
DISPlay[:WINDow]:TRACe:Y:SCALe:FIXScale:OFFSet.....	181
DISPlay[:WINDow]:TRACe:Y:SCALe:FIXScale:PERDiv.....	182

---

### DISPlay[:WINDow]:TRACe:Y:SCALe:AUTO

This command automatically adjusts the scale of the y-axis to the current measurement results.

Note that the command only affects the result display selected with `DISPlay[:WINDow<n>]:SElect`.

**Example:**                    `DISP:TRAC:Y:SCAL:AUTO`  
Scales the y-axis of the selected result display.

**Usage:**                    Event

**Manual operation:**    See "[Y-Axis Scale](#)" on page 96

---

### DISPlay[:WINDow]:TRACe:Y:SCALe:FIXScale:OFFSet <Origin>

This command defines the point of origin of the y-axis and thus has an effect on the scale of the y-axis.

Note that the command only affects the result display selected with `DISPlay[:WINDow<n>]:SElect`.

**Parameters:**  
<Origin>                    Point of origin of the y-axis.  
The unit depends on the result display you want to scale.

**Example:**                    See [Chapter 9.15, "Measurement Result Analysis"](#),  
on page 173.

**Manual operation:**    See "[Y-Axis Scale](#)" on page 96

---

**DISPlay[:WINDow]:TRACe:Y:SCALe:FIXScale:PERDiv <Distance>**

This command defines the distance between two grid lines on the y-axis and thus has an effect on the scale of the y-axis.

Note that the command only affects the result display selected with `DISPlay[:WINDow<n>]:SElect`.

**Parameters:**

<Distance>                      The unit depends on the result display you want to scale.

**Example:**

See [Chapter 9.15, "Measurement Result Analysis"](#), on page 173.

**Manual operation:**    See "[Y-Axis Scale](#)" on page 96

## List of Commands

[SENSe:]LTE:]CC<cc>:]ALLocation:SElect.....	173
[SENSe:]LTE:]CC<cc>:]CARRier:SElect.....	173
[SENSe:]LTE:]CC<cc>:]LOCation:SElect.....	174
[SENSe:]LTE:]CC<cc>:]MODulation:SElect.....	174
[SENSe:]LTE:]CC<cc>:]SUBFrame:SElect.....	175
[SENSe:]LTE:]CC<cc>:]SYMBol:SElect.....	175
[SENSe:]LTE:]DL:DEMod:AUTO.....	156
[SENSe:]LTE:]DL:DEMod:BEStimation.....	157
[SENSe:]LTE:]DL:DEMod:CBSCrambling.....	157
[SENSe:]LTE:]DL:DEMod:CEStimation.....	157
[SENSe:]LTE:]DL:DEMod:EVMCalc.....	158
[SENSe:]LTE:]DL:DEMod:MCFilter.....	158
[SENSe:]LTE:]DL:DEMod:PRData.....	158
[SENSe:]LTE:]DL:FORMat:PSCD.....	158
[SENSe:]LTE:]DL:TRACking:PHASe.....	159
[SENSe:]LTE:]DL:TRACking:TIME.....	159
[SENSe:]LTE:]FRAMe:COUNT.....	142
[SENSe:]LTE:]FRAMe:COUNT:AUTO.....	143
[SENSe:]LTE:]FRAMe:COUNT:STATe.....	143
[SENSe:]LTE:]OOPower:ATIMing.....	112
[SENSe:]LTE:]OOPower:NCORrection.....	144
[SENSe:]FREQuency:CENTer[:CC<cc>].....	139
[SENSe:]POWer:ACHannel:AACHannel.....	152
[SENSe:]POWer:AUTO:TIME.....	142
[SENSe:]POWer:AUTO[:STATe].....	142
[SENSe:]POWer:NCORrection.....	154
[SENSe:]POWer:SEM:CATegory.....	154
[SENSe:]POWer:SEM:CHBS:AMPower.....	155
[SENSe:]POWer:SEM:CHBS:AMPower:AUTO.....	155
[SENSe:]POWer:SEM:USERfile.....	155
[SENSe:]SWAPiq.....	146
[SENSe:]SWEep:EGATe:AUTO.....	156
[SENSe:]SWEep:TIME.....	143
[SENSe:]SYNC[:CC<cc>][:STATe]?.....	112
[SENSe:]FREQuency:SPAN.....	152
[SENSe:]FREQuency:SPAN:AUTO.....	152
[SENSe:]POWer:ACHannel:BANDwidth:CHANnel2.....	153
[SENSe:]POWer:ACHannel:SPACing:CHANnel.....	153
[SENSe:]POWer:ACHannel:TXCHannels:COUNT.....	154
CALCulate<n>:DELTamarker<m>:AOFF.....	179
CALCulate<n>:DELTamarker<m>:MAXimum[:PEAK].....	179
CALCulate<n>:DELTamarker<m>:TRACe.....	180
CALCulate<n>:DELTamarker<m>:X.....	180
CALCulate<n>:DELTamarker<m>:Y?.....	180
CALCulate<n>:DELTamarker<m>[:STATe].....	179
CALCulate<n>:FEED.....	108
CALCulate<n>:LIMit<li>:ACPPower:ACHannel:RESult?.....	134

CALCulate<n>:LIMit<li>:ACPoweR:ALTernate<alt>:RESult?	134
CALCulate<n>:LIMit<li>:OOPoweR:OFFPoweR?	135
CALCulate<n>:LIMit<li>:OOPoweR:TRANsient?	135
CALCulate<n>:MARKer<m>:AOFF	176
CALCulate<n>:MARKer<m>:FUNctIon:POWeR<sb>:RESult[:CURRent]?	136
CALCulate<n>:MARKer<m>:MAXimum[:PEAK]	176
CALCulate<n>:MARKer<m>:MINimum[:PEAK]	177
CALCulate<n>:MARKer<m>:MINimum[:PEAK]	179
CALCulate<n>:MARKer<m>:TRACe	177
CALCulate<n>:MARKer<m>:X	178
CALCulate<n>:MARKer<m>:Y	178
CALCulate<n>:MARKer<m>[:STATe]	177
CONFIgure:PRESet	109
CONFIgure[:LTE]:DL[:CC<cc>]:BW	137
CONFIgure[:LTE]:DL[:CC<cc>]:CSUBframes	163
CONFIgure[:LTE]:DL[:CC<cc>]:CYCPrefix	138
CONFIgure[:LTE]:DL[:CC<cc>]:MIMO:ASElection	144
CONFIgure[:LTE]:DL[:CC<cc>]:MIMO:CONFIg	145
CONFIgure[:LTE]:DL[:CC<cc>]:MIMO:CROStalk	160
CONFIgure[:LTE]:DL[:CC<cc>]:PBCH:POWeR	168
CONFIgure[:LTE]:DL[:CC<cc>]:PBCH:STAT	168
CONFIgure[:LTE]:DL[:CC<cc>]:PCFich:POWeR	169
CONFIgure[:LTE]:DL[:CC<cc>]:PCFich:STAT	169
CONFIgure[:LTE]:DL[:CC<cc>]:PDCCh:FORMat	169
CONFIgure[:LTE]:DL[:CC<cc>]:PDCCh:NOPD	170
CONFIgure[:LTE]:DL[:CC<cc>]:PDCCh:POWeR	170
CONFIgure[:LTE]:DL[:CC<cc>]:PDSCh:PB	172
CONFIgure[:LTE]:DL[:CC<cc>]:PHICh:DURation	170
CONFIgure[:LTE]:DL[:CC<cc>]:PHICh:MITM	171
CONFIgure[:LTE]:DL[:CC<cc>]:PHICh:NGParameter	171
CONFIgure[:LTE]:DL[:CC<cc>]:PHICh:NOGRoups	171
CONFIgure[:LTE]:DL[:CC<cc>]:PHICh:POWeR	172
CONFIgure[:LTE]:DL[:CC<cc>]:PLC:CID	161
CONFIgure[:LTE]:DL[:CC<cc>]:PLC:CIDGroup	162
CONFIgure[:LTE]:DL[:CC<cc>]:PLC:PLID	162
CONFIgure[:LTE]:DL[:CC<cc>]:PSOOffset	166
CONFIgure[:LTE]:DL[:CC<cc>]:REFSig:POWeR	166
CONFIgure[:LTE]:DL[:CC<cc>]:SUBFrame<sf>:ALCounT	163
CONFIgure[:LTE]:DL[:CC<cc>]:SUBFrame<sf>:ALLoc<al>:POWeR	164
CONFIgure[:LTE]:DL[:CC<cc>]:SUBFrame<sf>:ALLoc<al>:RBCounT	164
CONFIgure[:LTE]:DL[:CC<cc>]:SUBFrame<sf>:ALLoc<al>:RBOffset	165
CONFIgure[:LTE]:DL[:CC<cc>]:SUBFrame<sf>:ALLoc<al>:UEID	165
CONFIgure[:LTE]:DL[:CC<cc>]:SUBFrame<sf>:ALLoc<al>[:CW<cw>]:MODulation	163
CONFIgure[:LTE]:DL[:CC<cc>]:SYNC:ANTenna	167
CONFIgure[:LTE]:DL[:CC<cc>]:SYNC:PPOWeR	167
CONFIgure[:LTE]:DL[:CC<cc>]:SYNC:SPOWeR	167
CONFIgure[:LTE]:DL[:CC<cc>]:TDD:SPSC	160
CONFIgure[:LTE]:DL[:CC<cc>]:TDD:UDConf	161
CONFIgure[:LTE]:DUPLexing	138
CONFIgure[:LTE]:LDIREction	139



CONFigure[:LTE]:OOPower:NFRames.....	144
DISPlay[:WINDow]:TRACe:Y:SCALE:AUTO.....	181
DISPlay[:WINDow]:TRACe:Y:SCALE:FIXScale:OFFSet.....	181
DISPlay[:WINDow]:TRACe:Y:SCALE:FIXScale:PERDiv.....	182
DISPlay[:WINDow<n>]:SElect.....	109
DISPlay[:WINDow<n>]:TABLE.....	109
DISPlay[:WINDow<n>]:TRACe<t>:Y[:SCALE]:RLEVel.....	139
DISPlay[:WINDow<n>]:TRACe<t>:Y[:SCALE]:RLEVel:OFFSet.....	140
FETCh[:CC<cc>]:CYCPrefix?.....	114
FETCh[:CC<cc>]:PLC:CIDGroup?.....	114
FETCh[:CC<cc>]:PLC:PLID?.....	115
FETCh[:CC<cc>]:SUMMary:CRESt[:AVERage]?.....	115
FETCh[:CC<cc>]:SUMMary:EVM:DS1K:MAXimum?.....	117
FETCh[:CC<cc>]:SUMMary:EVM:DS1K:MINimum?.....	117
FETCh[:CC<cc>]:SUMMary:EVM:DS1K[:AVERage]?.....	117
FETCh[:CC<cc>]:SUMMary:EVM:DSQP:MAXimum?.....	116
FETCh[:CC<cc>]:SUMMary:EVM:DSQP:MINimum?.....	116
FETCh[:CC<cc>]:SUMMary:EVM:DSQP[:AVERage]?.....	116
FETCh[:CC<cc>]:SUMMary:EVM:DSSF:MAXimum?.....	116
FETCh[:CC<cc>]:SUMMary:EVM:DSSF:MINimum?.....	116
FETCh[:CC<cc>]:SUMMary:EVM:DSSF[:AVERage]?.....	116
FETCh[:CC<cc>]:SUMMary:EVM:DSST:MAXimum?.....	116
FETCh[:CC<cc>]:SUMMary:EVM:DSST:MINimum?.....	116
FETCh[:CC<cc>]:SUMMary:EVM:DSST[:AVERage]?.....	116
FETCh[:CC<cc>]:SUMMary:EVM:DSTS:MAXimum?.....	117
FETCh[:CC<cc>]:SUMMary:EVM:DSTS:MINimum?.....	117
FETCh[:CC<cc>]:SUMMary:EVM:DSTS[:AVERage]?.....	117
FETCh[:CC<cc>]:SUMMary:EVM:PCHannel:MAXimum?.....	117
FETCh[:CC<cc>]:SUMMary:EVM:PCHannel:MINimum?.....	117
FETCh[:CC<cc>]:SUMMary:EVM:PCHannel[:AVERage]?.....	117
FETCh[:CC<cc>]:SUMMary:EVM:PSIGnal:MAXimum?.....	118
FETCh[:CC<cc>]:SUMMary:EVM:PSIGnal:MINimum?.....	118
FETCh[:CC<cc>]:SUMMary:EVM:PSIGnal[:AVERage]?.....	118
FETCh[:CC<cc>]:SUMMary:EVM[:ALL]:MAXimum?.....	115
FETCh[:CC<cc>]:SUMMary:EVM[:ALL]:MINimum?.....	115
FETCh[:CC<cc>]:SUMMary:EVM[:ALL][:AVERage]?.....	115
FETCh[:CC<cc>]:SUMMary:FERRor:MAXimum?.....	118
FETCh[:CC<cc>]:SUMMary:FERRor:MINimum?.....	118
FETCh[:CC<cc>]:SUMMary:FERRor[:AVERage]?.....	118
FETCh[:CC<cc>]:SUMMary:GIMBalance:MAXimum?.....	119
FETCh[:CC<cc>]:SUMMary:GIMBalance:MINimum?.....	119
FETCh[:CC<cc>]:SUMMary:GIMBalance[:AVERage]?.....	119
FETCh[:CC<cc>]:SUMMary:IQOFFset:MAXimum?.....	119
FETCh[:CC<cc>]:SUMMary:IQOFFset:MINimum?.....	119
FETCh[:CC<cc>]:SUMMary:IQOFFset[:AVERage]?.....	119
FETCh[:CC<cc>]:SUMMary:OSTP:MAXimum?.....	119
FETCh[:CC<cc>]:SUMMary:OSTP:MINimum?.....	119
FETCh[:CC<cc>]:SUMMary:OSTP[:AVERage]?.....	119
FETCh[:CC<cc>]:SUMMary:POWer:MAXimum?.....	120
FETCh[:CC<cc>]:SUMMary:POWer:MINimum?.....	120

FETCh[:CC<cc>]:SUMMary:POWer[:AVERAge]?	120
FETCh[:CC<cc>]:SUMMary:QUADerror:MAXimum?	120
FETCh[:CC<cc>]:SUMMary:QUADerror:MINimum?	120
FETCh[:CC<cc>]:SUMMary:QUADerror[:AVERAge]?	120
FETCh[:CC<cc>]:SUMMary:RSTP:MAXimum?	121
FETCh[:CC<cc>]:SUMMary:RSTP:MINimum?	121
FETCh[:CC<cc>]:SUMMary:RSTP[:AVERAge]?	121
FETCh[:CC<cc>]:SUMMary:SERRor:MAXimum?	121
FETCh[:CC<cc>]:SUMMary:SERRor:MINimum?	121
FETCh[:CC<cc>]:SUMMary:SERRor[:AVERAge]?	121
FETCh[:CC<cc>]:SUMMary:TAE<ant>?	121
FETCh[:CC<cc>]:SUMMary:TFRame?	122
FORMat[:DATA]	133
INITiate:CONTInuous	111
INITiate:REFResh	112
INITiate[:IMMediate]	111
INPut<ip>:ATTenuation<ant>	140
INPut<ip>:DIQ:RANGe[:UPPer]	148
INPut<ip>:DIQ:SRAtE	147
INPut<ip>:EATT<ant>	140
INPut<ip>:EATT<ant>:AUTO	141
INPut<ip>:EATT<ant>:STATe	141
INPut<ip>:FILTer:YIG[:STATe]	147
INPut<ip>:SElect	146
INPut<n>:FILTer:YIG:AUTO	146
MMEMory:LOAD:IQ:STATe	110
MMEMory:LOAD:SEMSettings	151
MMEMory:LOAD[:CC<cc>]:TMOd:DL	110
MMEMory:STORe<n>:IQ:STATe	110
TRACe[:DATA]?	133
TRACe<n>:IQ:FILTer:FLATness	147
TRIGger[:SEQuence]:HOLDOff<ant>[:TIME]	148
TRIGger[:SEQuence]:IFPower:HOLDOff	149
TRIGger[:SEQuence]:IFPower:HYSteresis	149
TRIGger[:SEQuence]:LEVel<ant>:POWer	150
TRIGger[:SEQuence]:LEVel<ant>:RFPower	150
TRIGger[:SEQuence]:LEVel<ant>[:EXtErnal<tp>]	149
TRIGger[:SEQuence]:MODe<ant>	150
UNIT:BSTr	175
UNIT:EVM	176

# Index

<b>A</b>		
ACLR .....	48	
Adjust timing .....	42	
Allocation		
Filter by .....	95	
Allocation summary .....	55	
Amplitude .....	63	
Antenna selection .....	67	
Application cards .....	10	
Application notes .....	10	
Attenuation .....	63	
Auto Detection (Cell Identity) .....	81	
Auto level .....	63	
Auto PDSCH Demodulation .....	77	
<b>B</b>		
Bit stream .....	55	
Bitstream format .....	94	
Boosting estimation .....	78	
Brochures .....	10	
<b>C</b>		
Capture buffer .....	38	
Capture time .....	64	
Carrier		
Filter by .....	95	
Carrier aggregation .....	72	
CCDF .....	54	
Cell ID .....	81	
Cell Identity Group .....	81	
Center frequency .....	61	
Channel Bandwidth .....	62	
Channel Estimation .....	76	
Channel flatness .....	52	
Channel flatness difference .....	53	
Channel flatness group delay .....	52	
Codeword		
Filter by .....	95	
Configurable Subframes .....	82	
Configuration Table .....	82	
Constellation diagram .....	53	
Configuration .....	95	
Constellation selection .....	95	
Conventions		
SCPI commands .....	103	
<b>D</b>		
Data sheets .....	10	
Dialog		
Marker .....	97	
Marker Zoom .....	98	
Digital Input Data Rate .....	75	
Duplexing .....	61	
<b>E</b>		
Error in Subframes .....	82	
Estimation		
Channel .....	76	
Physical channels .....	78	
EVM calculation method .....	76	
EVM unit .....	94	
EVM vs Carrier .....	42	
EVM vs RB .....	45	
EVM vs subframe .....	45	
EVM vs symbol .....	43	
External Attenuation .....	63	
<b>F</b>		
Filter		
Interference .....	78	
Frequency		
Configuration .....	61	
Frequency error vs symbol .....	44	
Full Scale Level .....	75	
<b>G</b>		
Getting started .....	9	
<b>H</b>		
Hardware settings .....	25	
Header Table .....	24	
Home base station .....	71	
<b>I</b>		
Identity (Physical Layer) .....	81	
Input Source .....	73	
Instrument security procedures .....	10	
Interface .....	23	
Interference suppression .....	78	
<b>K</b>		
Key		
MKR .....	96	
<b>L</b>		
Level configuration .....	63	
Link direction .....	61	
<b>M</b>		
Marker Zoom .....	98	
Measurement		
ACLR .....	48	
allocation summary .....	55	
bit stream .....	55	
Capture buffer .....	38	
CCDF .....	54	
channel flatness .....	52	
channel flatness difference .....	53	
channel flatness group delay .....	52	
constellation .....	53	
EVM vs carrier .....	42	
EVM vs RB .....	45	
EVM vs subframe .....	45	
EVM vs symbol .....	43	
freq err vs symbol .....	44	
numerical .....	35	

on/off power .....	39
power spectrum .....	50
power vs RB PDSCH .....	51
power vs RB RS .....	51
result summary .....	35
spectrum mask .....	47
Measurement time .....	64
MIMO	
Configuration .....	67
MIMO encoding .....	95
MKR Key .....	96
Modulation	
Filter by .....	95
Multicarrier filter .....	78
<b>N</b>	
Noise cancellation .....	42
Number of RB .....	62
Numerical results .....	35
<b>O</b>	
Offset	
Reference level .....	63
On/off power .....	39
Online help	
Working with .....	11
<b>P</b>	
P-/S-SYNC Tx antenna .....	87
PBCH .....	88
PCFICH .....	88
PDSCH reference data .....	78
PDSCH subframe detection .....	77
Phase error .....	78
PHICH .....	89
Power spectrum .....	50
Power vs RB PDSCH .....	51
Power vs RB RS .....	51
PRB symbol offset .....	86
<b>R</b>	
Reference Level .....	63
Relative Power .....	87
Relative power () .....	87
Relative power (reference signal) .....	86
Release notes .....	10
Remote commands	
Basics on syntax .....	103
Boolean values .....	106
Capitalization .....	104
Character data .....	107
Data blocks .....	107
Numeric values .....	105
Optional keywords .....	104
Parameters .....	105
Strings .....	107
Suffixes .....	104
Resource Blocks .....	62
Result summary .....	35
<b>S</b>	
Safety instructions .....	10
Scrambling of coded bits .....	76
Screen Layout .....	23
Security procedures .....	10
Selected Subframe .....	82
Service manual .....	9
Setting	
P-/S-SYNC Tx antenna .....	87
Settings	
Auto .....	81
Auto PDSCH Demod .....	77
Bitstream format .....	94
Boosting estimation .....	78
Capture time .....	64
Channel Bandwidth .....	62
Channel Estimation .....	76
Configurable Subframes .....	82
Configuration Table .....	82
Constellation selection .....	95
Digital Input Data Rate .....	75
Error in Subframe .....	82
EVM calculation method .....	76
EVM unit .....	94
Ext Att .....	63
Frequency .....	61
Full Scale Level .....	75
ID .....	81
Identity .....	81
Identity Group .....	81
Multicarrier filter .....	78
Number of RB .....	62
PBCH .....	88
PCFICH .....	88
PDSCH reference data .....	78
PDSCH subframe detection .....	77
Phase tracking .....	78
PHICH .....	89
PRB symbol offset .....	86
Ref Level .....	63
relative power .....	86, 87
Scrambling of coded bits .....	76
Selected Subframe .....	82
Source .....	73
Standard .....	61
Subframe selection .....	93
Swap I/Q .....	73
TDD UL/DL Allocations .....	80
Timing error .....	79
Trigger level .....	66
Trigger mode .....	66
Trigger offset .....	66
Used Allocations .....	82
YIG Filter .....	74
Softkey	
Marker 1 .....	96
Source (Input) .....	73
Spectrum mask .....	47
Standard selection .....	61
Status Bar .....	24
Subframe Configuration Table .....	82
Subframe Error .....	82
Subframe selection .....	93
Suffixes	
Common .....	102
Remote commands .....	104
Swap I/Q .....	73
Symbol	
Filter by .....	95

**T**

TDD UL/DL Allocations .....	80
Test scenarios .....	100
Timing error .....	79
Title Bar .....	24
Tracking	
Phase .....	78
Timing .....	79
Transmission path .....	61
Trigger level .....	66
Trigger mode .....	66
Trigger offset .....	66

**U**

Used Allocations .....	82
Using the Marker .....	96

**W**

White papers .....	10
--------------------	----

**Y**

YIG Filter .....	74
------------------	----

**Z**

Zoom	
Capture buffer .....	38