



**GOODYEAR**

Radial Truck Tire  
And Retread  
Service Manual

# CONTENTS

<b>Section</b>	<b>Title</b>	<b>Page</b>	<b>Section</b>	<b>Title</b>	<b>Page</b>
<b>1. Radial Truck Tire Terms</b>		<b>5</b>	<b>8. Ride Disturbance</b>		<b>58</b>
	Cross-Sectional View of Typical Tire	6		Ride Test Tips	60
<b>2. Tire Selection</b>		<b>8</b>		Ride Diagnostics: Tires/Wheels	60
	Tire Selection Process	9		Balance Related Vibration	60
	Tire Selection Process Work Sheet	16		Run-Out Related Vibration	60
<b>3. Mounting Procedure</b>		<b>19</b>		Mesuring Radial Run-Out	61
	Safety Instructions	20	<b>9. Factors Affecting Truck Fuel Economy</b>		<b>63</b>
	Wheel Inspection Guidelines	20		Vehicle and Engine Design	64
	Lubrication	20		Vehicle Operation	67
	Tire and Rim Cleaning	21		Tire Selection and Maintenance	70
	Tubes and Flaps	22		Environmental Conditions	74
	Assembly of Tire Tube Flap	22		Tire Description & Specifications	76
	Tubeless Tire Mounting	23		Summary	77
	Installation	23		Appendix	78
	Demounting	24	<b>10. Tire Repairs</b>		<b>80</b>
	Matching of Duals	25		Nail Hole Repair Procedures	82
	Spacing of Duals	26		Section Repair Limits in Sidewall and Shoulder Area	84
	Spacers	26		Application of Center-Over-Injury Section Repairs	85
	Proper Matching of Rim Parts	27		Radial Ply Tires	85
	Safety Precautions	28		Crown Repair Limits	85
	Mounting and Inflation	29	<b>11. Retreading</b>		<b>86</b>
	Operation	31		Introduction	87
	Servicing Tire and Rim	31		Planning A Retread Plant Visit	87
	Inspection Procedures	31		Plant Inspection	87
<b>4. Collecting and Storing Tire Information</b>		<b>34</b>		Definitions	90
	Branding Tires	35		Retread Plant Inspection Checklist	92
	Radio Frequency Identification Tags	36	<b>12. Miscellaneous</b>		<b>94</b>
	RF Tag Usage	36		Use of Chains on Radial Truck Tires	95
<b>5. Inflation</b>		<b>37</b>		Tire Siping	95
	Underinflation	40		Dynamometer Tests	96
	Do's and Don'ts for Maintaining Proper Inflation Pressure	42		Mixing Radial and Bias Ply Tires	96
	Nitrogen Inflation	42		Noise	97
<b>6. Total Vehicle Alignment</b>		<b>43</b>		Tire Storage Recommendations	99
	Steer Axle Alignment	45		When Does The Warranty End?	100
	Loaded vs. Unloaded Alignment Settings	45		Tire Sealants And Balance Materials	100
	Toe	46	<b>13. Standards and Regulations</b>		<b>101</b>
	Camber	46		Federal Motor Vehicle Safety Standards Testing and Certification	102
	Caster	46		Federal Motor Carrier Safety Regulations	102
	Ackerman Steering Effect on Tire Wear	47		Inspection	103
	Drive Axle Alignment	48		Minimum Tread Depths	104
	Trailer Axle Alignment	49		Commercial Vehicle Safety Alliance (CVSA)	104
	In-Service Alignment Recommendations	49		Regrooving/Tire Siping	105
<b>7. Factors Affecting Treadwear</b>		<b>50</b>		<b>Load Ratings and Inflation Data</b>	<b>107</b>
	Steer Tire Wear	52		<b>Truck Type and Weight Class</b>	<b>108</b>
	Setback Steer Axles	53		<b>Index</b>	<b>109</b>
	Drive Tires	54			
	Bearing Adjustment	55			
	Environmental Effects	56			
	How Speed Affects Tire Wear	57			

# Forward

This manual was prepared as a guide to the selection, operation, and maintenance of Goodyear radial truck tires.

The subjects covered are all essential to good tire performance. Detailed explanations on selection, mounting, air pressure, vehicle alignment, and other important issues are supported by illustrations for clarity.

Use this manual often as a reference. It will help you get extended fuel economy, treadwear, and casing life from your Goodyear radial tires.



Radial  
Truck Tire  
Terms

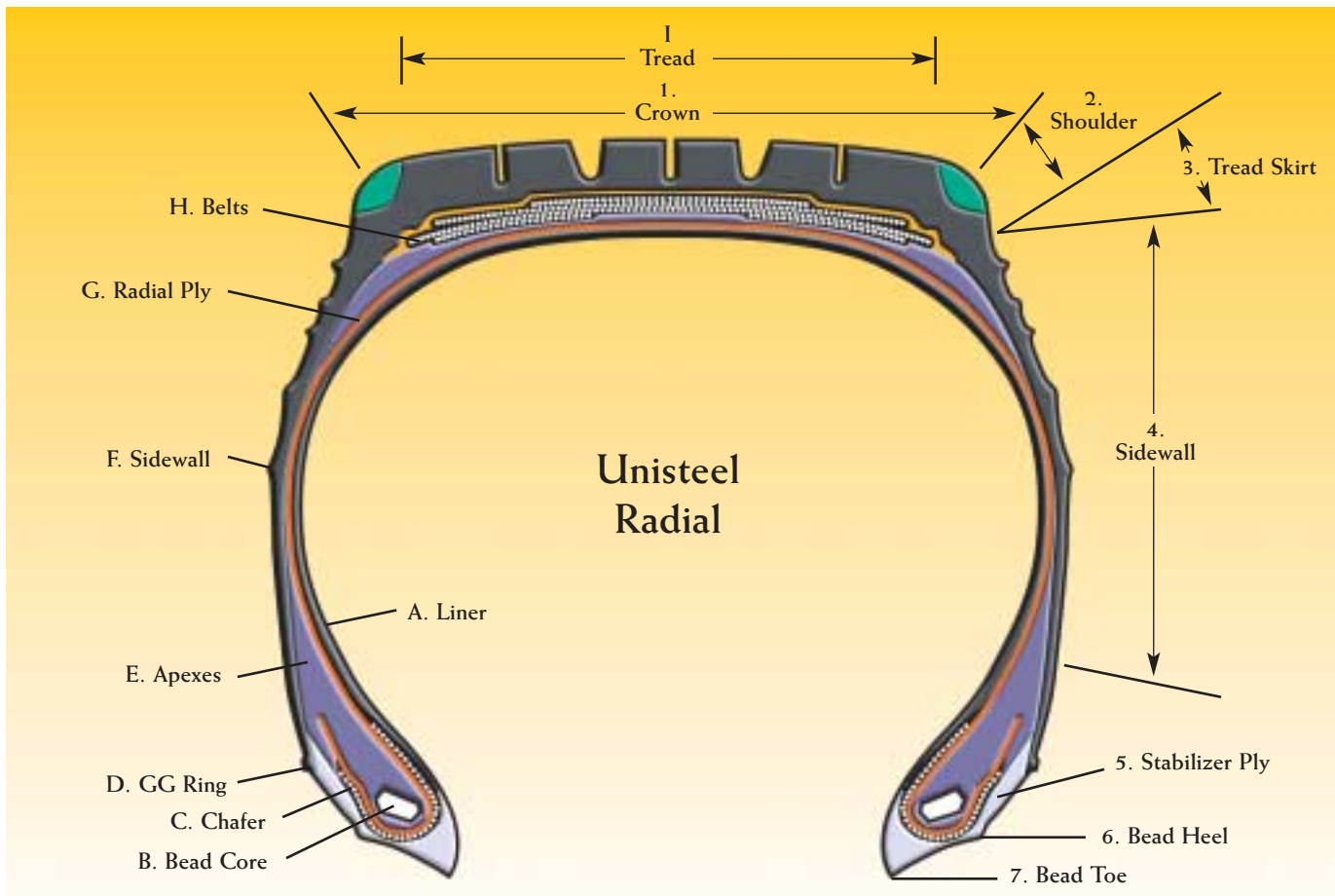

## Tire Components

- A. Liner** — A layer or layers of rubber in tubeless tires that resists air diffusion. The liner in the tubeless tire replaces the innertube of the tube-type tire.
- B. Bead Core** — Made of a continuous high-tensile wire wound to form a high-strength unit. The bead core is the major structural element in the plane of tire rotation and maintains the required tire diameter on the rim.
- C. Chafer** — A layer of hard rubber that resists rim chafing.
- D. GG Ring** — Used as reference for proper seating of bead area on rim.
- E. Apexes** — Rubber pieces with selected characteristics used to fill in the bead and lower sidewall area and provide smooth transition from the stiff bead area to the flexible sidewall.

- F. Sidewall** — The sidewall rubber must withstand flexing and weathering and provide protection for the ply.
- G. Radial Ply** — The radial ply, together with the belt plies, withstands the loads of the tire under operating pressure. The plies must transmit all load, driving, braking and steering forces between the wheel and the tire tread.
- H. Belts** — Steel cord belt plies provide strength, stabilize the tread, and protect the air chamber from punctures.
- I. Tread** — This rubber provides the interface between the tire and the road. Its primary purpose is to provide traction and wear.

## Tire Areas

- 1. Crown** — Area of the tire that contacts the road surface.
- 2. Shoulder** — Transition area between the crown and tread skirt.
- 3. Tread Skirt** — Intersection of tread and sidewall.
- 4. Sidewall** — Area from top of bead to the bottom of the tread skirt.
- 5. Stabilizer Ply** — A ply laid over the radial ply turnup outside of the bead and under the rubber chafer that reinforces and stabilizes the bead-to-sidewall transition zone.
- 6. Bead Heel** — Area of bead that contacts the rim flange, the "sealing point" of the tire/rim.
- 7. Bead Toe** — The inner end of the bead area.

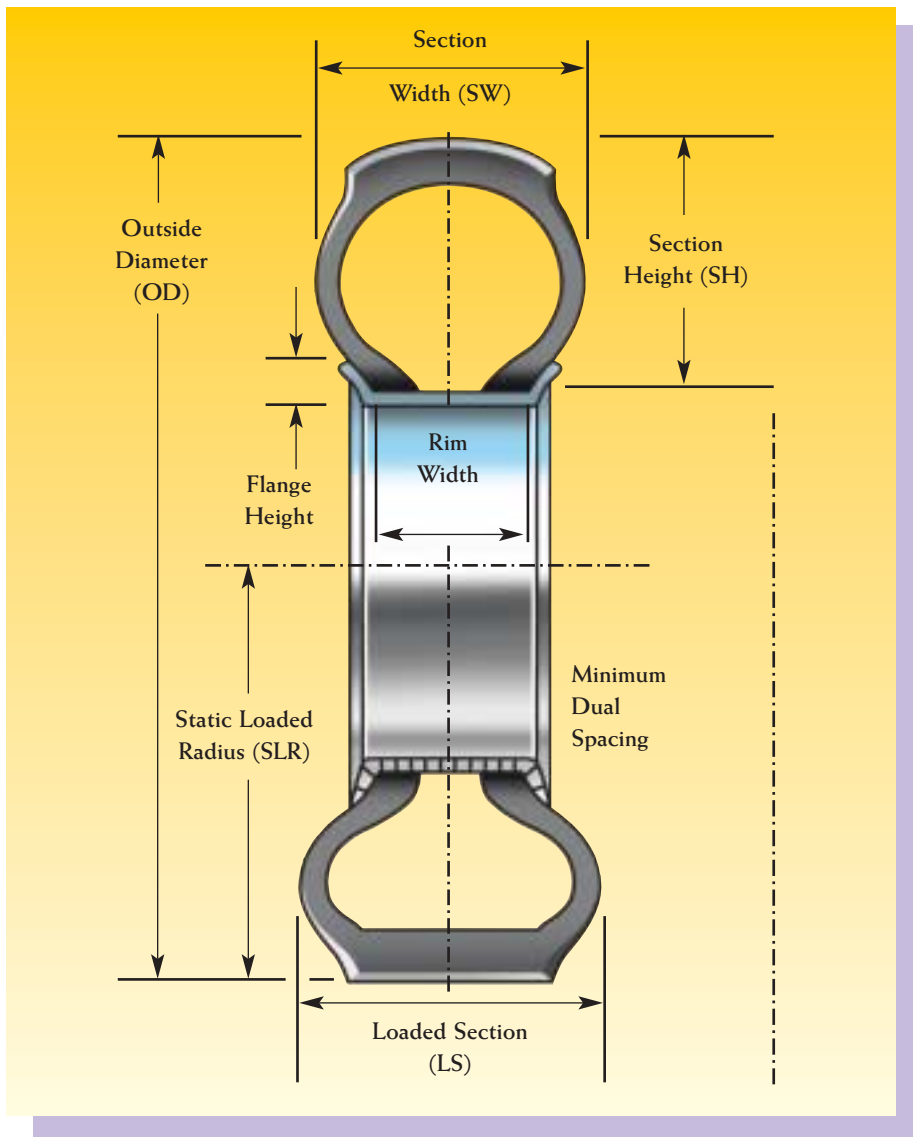

- **Aspect Ratio (AR)** — The section height divided by the section width, expressed as a percentage ( $SH/SW \times 100$  percent).
- **Loaded Section (LS)** — The width of the cross section at the Tire and Rim Association's dual tire load and inflation pressure.
- **Static Loaded Radius (SLR)** — The distance from the road surface to the horizontal centerline of the wheel, under dual load.
- **Minimum Dual Spacing** — The minimum dimension recommended from rim centerline to rim centerline for optimum performance of a dual wheel installation.

### The Tire & Rim Association Yearbook

The Tire & Rim Association Yearbook provides essential information for the interchangeability of tire, wheel and rim products for cars, trucks, buses, cycles, off-the-road, agricultural and industrial vehicles.

To obtain a copy, write or call:

The Tire & Rim Association, Inc.  
175 Montrose West Ave.  
Suite 150  
Copley, OH 44321  
330-666-8121  
[www.us-tra.org](http://www.us-tra.org)

### Definition

- **Footprint** — The surface of the tire in contact with the road surface at any given load and inflation pressure.
- **Tread Width** — Distance across tread surface.
- **Non-Skid** — Tread depth from tread surface to bottom of major grooves.
- **Undertread** — Gauge of rubber between top of belt package and bottom of grooves.
- **Turn Radius** — Curvature of the tread face from shoulder to shoulder.
- **Net/Gross Ratio** — Tread pattern contact area to total tread area.
- **Outside Diameter (OD)** — The unloaded diameter of the tire/rim combination.
- **Section Width (SW)** — The maximum width of the tire section, excluding any lettering or decoration.
- **Section Height (SH)** — The distance from the rim to the maximum height of the tire at the centerline.



## Tire Selection

Selecting the proper tire size, load range and design is very important to insure satisfactory performance. The best guide is to follow past experience and use the advice of professionals who are familiar with the types of tires used in service conditions similar to yours. Goodyear representatives are trained to aid you in this important decision. The following will provide basic guidelines for proper tire selection.

\*Information courtesy of The Maintenance Council (TMC)

— Recommended Practices Book

## TIRE SELECTION PROCESS

### Purpose

This Recommended Practice is intended to make the tire purchaser, fleet operator, or maintenance manager aware of major items for consideration, and to provide a step-by-step thought process for selecting the best type of tire for the application. The following sections provide a brief explanation of the various tire selection criteria that must be addressed. A summary of considerations is also listed to enable the decision-maker to identify advantages and disadvantages of each of the selection criterion.

If higher steer tire pressures are required, this may mean you'll be using different inflation pressures for drive and trailer tires.

While the considerations may not be all-encompassing, they point out the major issues that should be dealt with before selecting a tire. Because of the pace of technology change in the tire industry, certain considerations may become less important while new ones may arise from time to time.

### Introduction

The process of determining which tire to select for a particular job or operation may sometimes seem difficult or complex. Indeed, the proper selection involves a myriad of decisions concerning the size, the type, and the tread design of the tire based upon the intended application. Other considerations are the manufacturer of the tire, the tire dealer, price, availability, and the warranty coverage which comes with the product. However, there is a logical method for selecting which kind of tire would be most appropriate depending upon an assessment of the many considerations surrounding the fleet operation.

Be aware that all tire use selections will have advantages and disadvantages depending upon vehicle design and vocation. Make certain your choices are in line with your perceived fleet needs and contact your tire suppliers for expert assistance in making your selection.

### Tire Clearance Restrictions

**New Equipment** — When specifying a new vehicle, the prospective owner can be quite imaginative in creating a vehicle that meets specific needs. Tires, however, may be the limiting factor to this creativity since they must be capable of carrying the expected load and be made to certain minimum dimensions. The fleet owner can choose from several types of tires that can carry the anticipated load, but may be forced to redesign a vehicle's overall dimensions if the tires that can carry the load are larger than originally desired.

**Existing Equipment** — When changing the type or size of tires used on existing equipment, space restrictions are more inflexible. Not only must a tire be selected that can carry the load, it must fit in an existing space. In addition, when changing tire sizes on an existing power unit, consideration must be given to the effects the new size tire will have on

the gear ratio. Some change may require a different rim (width, pressure limits).

**Tire Clearances** — In order to select a new tire size for a given application, the dimensional clearance of the tire must be acceptable. The following define those areas that must be checked:

1. **Vertical Clearance** is the distance between the top of the tire tread and the vehicle immediately above it. This clearance varies as the axles operate. The vertical movements of the whole axle in relation to the chassis are normally limited by an axle stop. To determine vertical clearance, subtract the axle stop clearance from the total clearance above the tire at rest.
2. **Front Tire Clearances** are the distances between the front tires (on both steering lock positions) and the vehicle. Clearances of front wheels must be checked by turning the wheels from full left lock to full right lock, since the minimum clearance might occur at some intermediate point.
3. **Overall Width** — When fitting larger or wider tires to an existing vehicle, the overall width across the dual tires is increased by half of the increase in the section width of each outside tire and the increase in offset of each outside wheel. The overall width across the tires is measured at the twelve o'clock position and not at the lower side (six o'clock position) where the tires deflect due to load.

When using tire chains, a minimum of two inches more clearance is needed to provide clearance between the dual assembly.



## Rims And Wheels

The selection of rims or disc wheels goes hand-in-hand with the selection of tires. When ordering new equipment, specifying the recommended rim for the tire size selected will ensure optimum performance.

Rims are identified by a diameter and width and, in the case of tube-type rims, also with a type code. The type code designations are used on tube-type products to help identify rings and rims for interchangeability. For example, a 20 x 7.5 FL rim would have a nominal diameter of 20 inches, a width between the flanges of approximately 7.5 inches, and be a FL type rim. Other typical type codes are: CR, 5°, LB, and LW. It is important that the rim size be approved for the tire being used. This assures proper fit and performance of the tire and rim. The tire or rim/wheel manufacturer's data book or *Tire & Rim Association Yearbook* (or equivalent), and [www.goodyear.com/truck](http://www.goodyear.com/truck) specify approved rims for each tire size.

When selecting the correct wheel or rim type, it is important to determine the operating conditions to which the wheel or rim will be subjected. Conditions to consider are loads, speeds, road surfaces, use of bias or radial tires, tire pressure, tire size, and the use of tube-type or tubeless tires.

Caution is necessary in selecting wheel/rim offsets to ensure proper tire spacing, body and chassis clearance, and overall track width. If dual tires are used, dual spacing and tire clearance must be considered.

Take precautions to ensure that the rim and wheel not only have the approved contour, but also have the load and inflation ratings sufficient for the tire in the intended application.

For more detail in selecting the correct wheel/rim, refer to TMC RP211A, *Rim and Wheel Selection and Maintenance*.

## Radial and Bias Tire Construction

There are two basic types of tire construction — radial and bias — that must be considered when choosing either a replacement tire for certain applications or when specifying new tires on an original equipment vehicle **Figure 2.1**.

Bias ply tires are constructed of overlapping crossed layers of cord material and are typically made with nylon, polyester, or other materials. The crossed plies run on a diagonal from tire bead to tire bead and comprise a generally stiff sidewall area. Sometimes, extra crossed plies or breakers are used under the tread area to further stiffen the crown area and provide better wear resistance or other performance parameters (such as puncture resistance, etc.).

Radial ply tires are made with the cord material running in a radial or direct line from bead (at 90 degrees to the centerline of the tire), and are

typically made with one steel body ply or multiple body plies of other materials. Under the tread area, the radial tire usually has three or four crossed plies or belts made of steel cord to stabilize the crown area and offer better puncture resistance. The radial sidewall area is generally less stiff than the bias ply sidewall, though the tread area is normally much stiffer.

Bias ply tires have been designed over the years to perform in many different types of applications from all-highway to on-off road, to all off-road service conditions. With the advent of the radial tire and some of its inherent advantages, the bias tire is now used much less frequently in long haul over-the-road applications. Radial tires typically are used in applications where heat build-up with bias ply tires is a problem. With the many improvements to radial tire construction made in recent years, the radial tire is now used in virtually all types of service conditions.

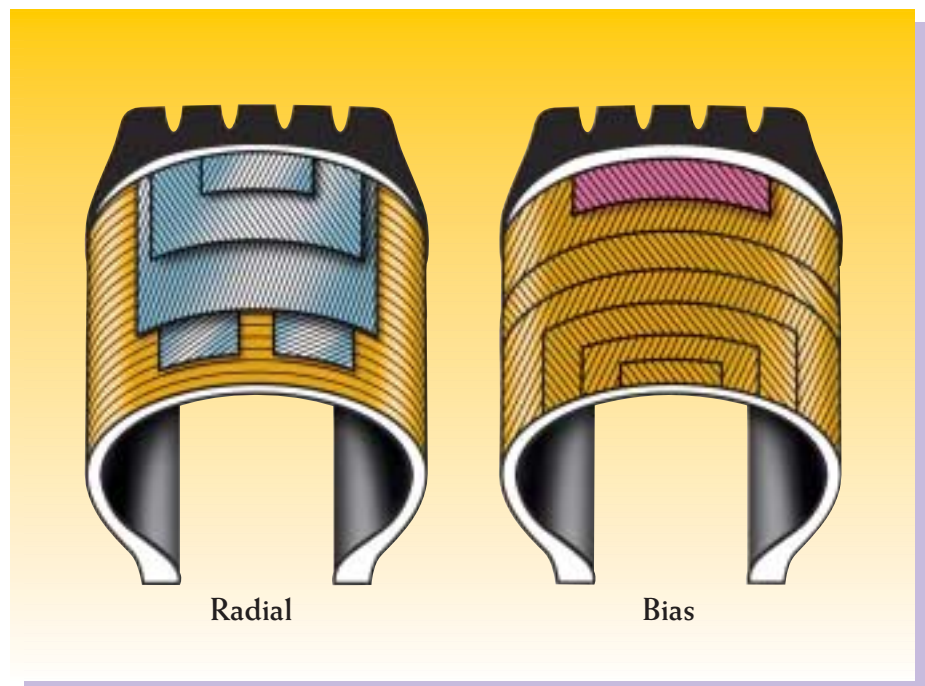

Figure 2.1

### Bias Ply Tire Considerations

- stiffer sidewalls give better driver handling/feel
- lower susceptibility to sidewall snags/hazards/rusting
- lower initial tire purchase price

### Radial Tire Considerations

- better treadwear performance
- higher potential for retreading
- more fuel efficient
- lower susceptibility to tread punctures
- better traction characteristics

## Tubeless And Tube-Type Tires

The tubeless tire is similar in construction to a tube-type tire, except that a thin layer of air and moisture-resistant rubber is used on the inside of the tubeless tire from bead to bead to obtain an internal seal of the casing. This eliminates the need for a tube and flap. The two types of tires require different rim configurations: the tubeless tire uses a single-piece wheel; and the tube-type tire requires a multi-piece wheel assembly **Figure 2.2**. Both tires, in equivalent sizes, can carry the same load at the same inflation pressure. However, tubeless tires generally offer more benefits than tube-type tires in line-haul operations.

### Tubeless Tire Characteristics

vs. Tube-type:

- less complicated mounting process due to use of a single-piece wheel
- decreased weight with lighter tire/wheel assembly
- less maintenance of parts and reduced parts inventory
- improved bead durability potential from less brake drum heat resulting from higher wheel clearance
- improved crown and sidewall durability potential from cooler running tubeless casing
- better lateral stability from lower section height
- reduced downtime from punctures

<b>TABLE 1</b>		
Conventional vs. Low Profile Tire Comparison		
	11R22.5	295/75R22.5 (Low Profile)
Diameter	41.5"	40.0"
Section Width	11.0"	11.2"
Nonskid	19/32"	18/32"
Rim	8.25"	8.25"
SLR	19.4"	18.7"
RPM	501	514

Table 1

### Low Profile Tires

Low aspect ratio tires are a category of radial tubeless tires which feature section widths wider than their section height. The ratio of tire section height to section width for these low aspect ratio tires generally fall between 80% to 70%.

Low aspect ratio tires have shorter sidewall heights and wider tread widths than their "conventional" aspect ratio tire counterparts.

These differences lead to the following tire characteristics:

- improved treadwear (less irregular wear) on steer and trail axles
- lighter weight and less federal excise tax
- better trailer cube potential due to smaller tire diameter on new equipment
- improved stability and handling from higher lateral spring rate
- greater susceptibility to sidewall curb damage

As fleet experience with low profile tires increases, other considerations (such as vehicle geometry, alignment maintenance, and brake wear) may need to be addressed depending on the applications and service requirements of the operation.

Drivetrain/gearing must be taken into account when converting to low profile tires, either at the original equipment or replacement level. These involve engine RPM, transmission, drive axle gear ratio, and tire RPM. The objective is to obtain the most fuel efficient engine RPM/ground speed relationship consistent with service condition requirements.

The effect on road speed at the same engine RPM using a 55 mph base depends upon which conventional aspect ratio and low profile tires are involved. Generally, if the percent change in the tire RPM is 3% or less, a gearing change is not required **Table 1**.

## Wide-Base (Super Single) Tires

A wide-base tire is simply a larger tire with a lower profile by nature. Currently, the primary application in North America is on vehicles whose front axle loads exceed the capacity of standard tires. Construction vehicles such as cement mixers and refuse haulers are prime examples. In addition to increased load capacity, these larger tires provide improved flotation versus conventional size tires.

The common wide-base sizes include: 385/65R22.5, 425/65R22.5, 445/65R22.5, 435/50R22.5, and 445/50R22.5.





Therefore, with conventional tire sizes, it would require at least an 11R22.5 tire with a carrying capacity of 6,175 lbs. at 105 psi on the steer axle (which would be the most critical for load and single application). The 11R22.5 would be more than adequate for drive and trailer axle applications. In low profile sizes, the 285/75R24.5 at 105 psi would have the adequate carrying capacity for the steer as well as the drive and trailer axle loads.

The Tire and Rim Association has established inflation pressures for load limits at various speeds for truck tires used on improved surfaces. Consult the Tire and Rim Association table or individual tire manufacturer for specific recommendations to meet your operating condition. You can contact The Tire and Rim Association at 330-666-8121 or [www.us-tra.org](http://www.us-tra.org).

### Tread Design Selection

The selection of the proper tread design for an intended application is very important to the fleet that wishes to obtain the maximum potential from tires and thereby lower tire expenses. Selection of the proper tread design

is not an exact science, but there are certain general rules and guidelines which, if followed, can lead to selecting a tread design that will give the maximum desired performance for the service application in a particular fleet. In order to help select the right tread design, refer to Technology & Maintenance Council RP (Recommended Practice) 220, *Tire Tread Design Selection*.

### Fleet Operation Considerations

When evaluating the many tire options available for any given vehicle application, there are numerous management considerations in addition to the mechanical considerations already covered. While these considerations apply most directly when specifying out new equipment, they also can be used to reevaluate tire selection prior to tire replacement.

#### Fleet Operation Considerations

- availability of various products and service maintenance
- tire purchase price vs. performance (cost-per-mile)
- financial inventory investment and space requirements

- maintenance training for personnel
- retreadability/repairability costs and servicing
- warranty and adjustment servicing
- leading edge or "experimental" product availability
- effects of non-standardization
- effects of tire down-sizing on vehicle gearing and braking
- timing for phase-in or changeover programs
- legal or contractual requirements

### Retreadable Tires

Retreading your worn tires or purchasing retreads from a dealer can provide new tire service and performance at a fraction of the cost of a new tire. When selecting new tires, purchase those that are designed to be retreadable. To insure retreadability, follow prescribed maintenance and avoid regrooving which may damage the valuable casing.

#### Retreaded Tire Considerations

- provide equivalent service and performance
- reduce overall cost-per-mile
- conserve natural resources
- tread designs available for all applications

Figure 2.2: Tire Construction

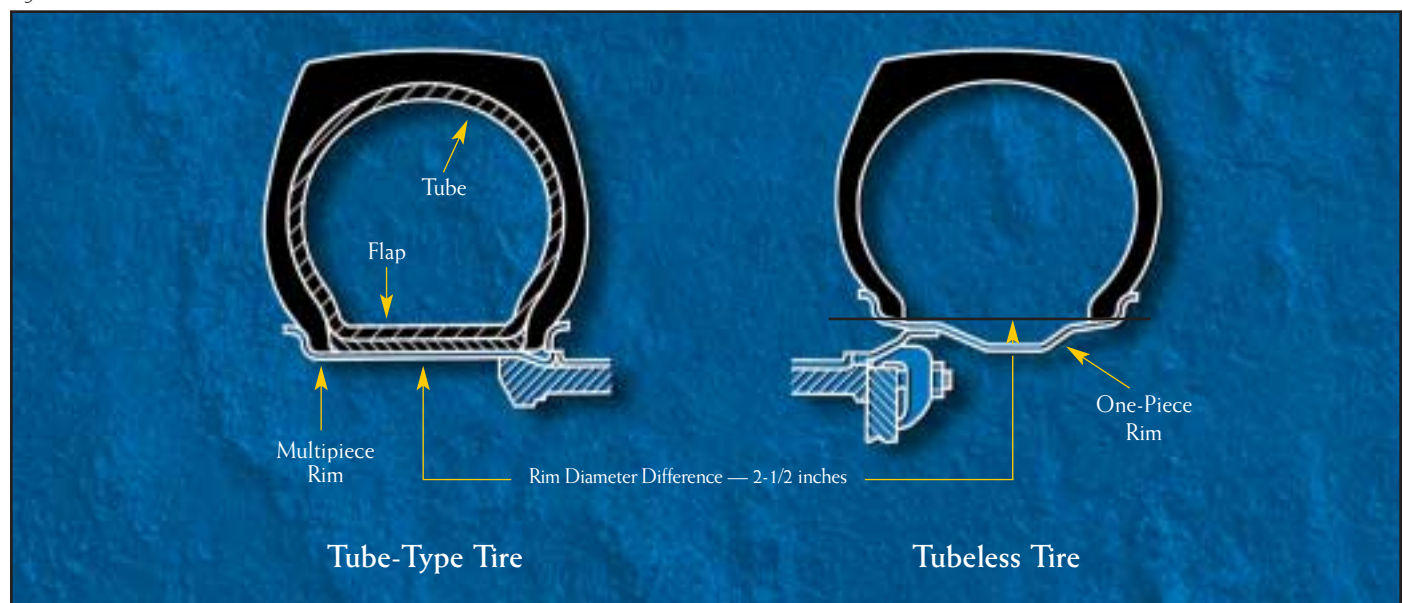

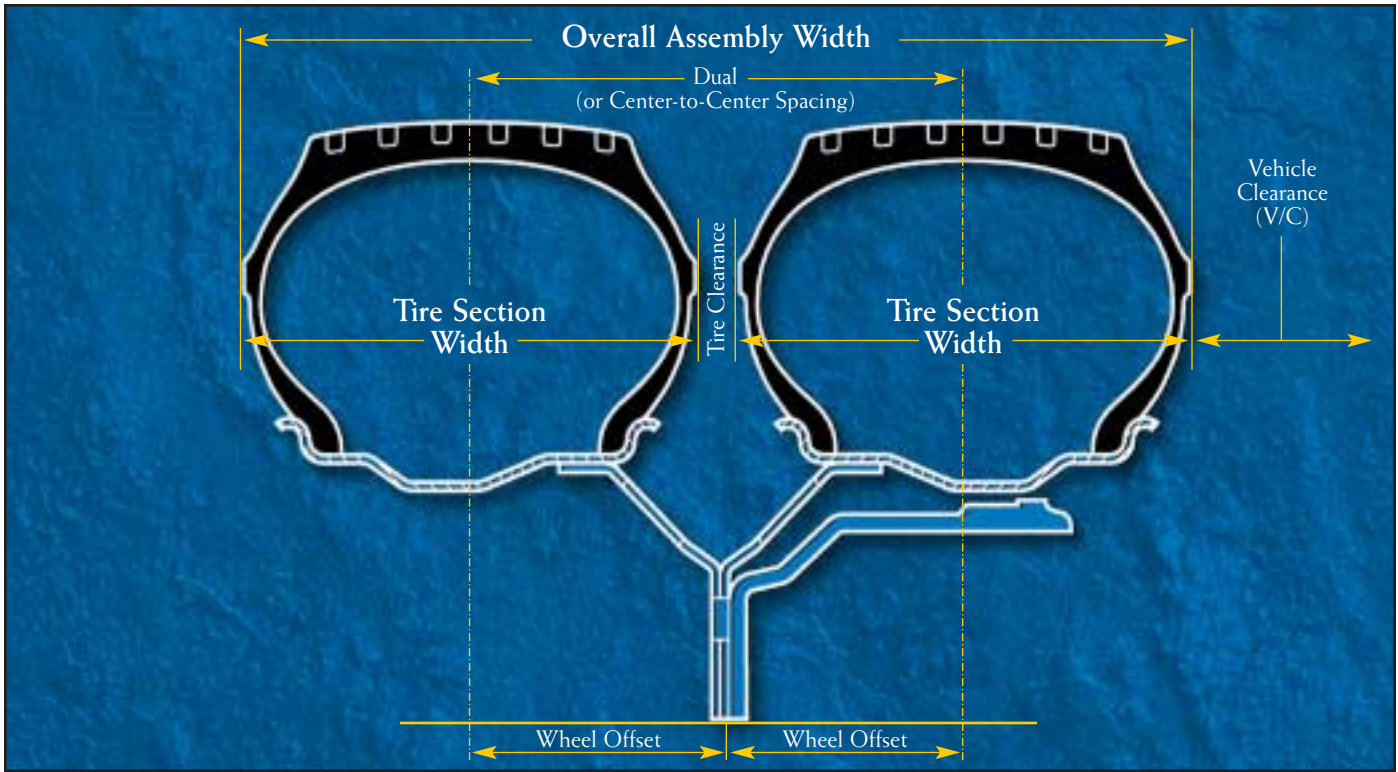

Figure 2.3: Overall Width, Dual Tires

Common aspect ratio categories of medium truck tires are as follows:

- 98 Tube-type conventional sizes (10.00R20)
- 88 Drop center tubeless (11R22.5)
- 70-75-80 Low profile (295/75R22.5, 255/70R22.5)
- 65 Wide-base singles (18R22.5, 445/65R22.5)

$$\frac{\text{Section Height}}{\text{Section Width}} = .75 \text{ Aspect Ratio}$$

### New Tire Dimensions

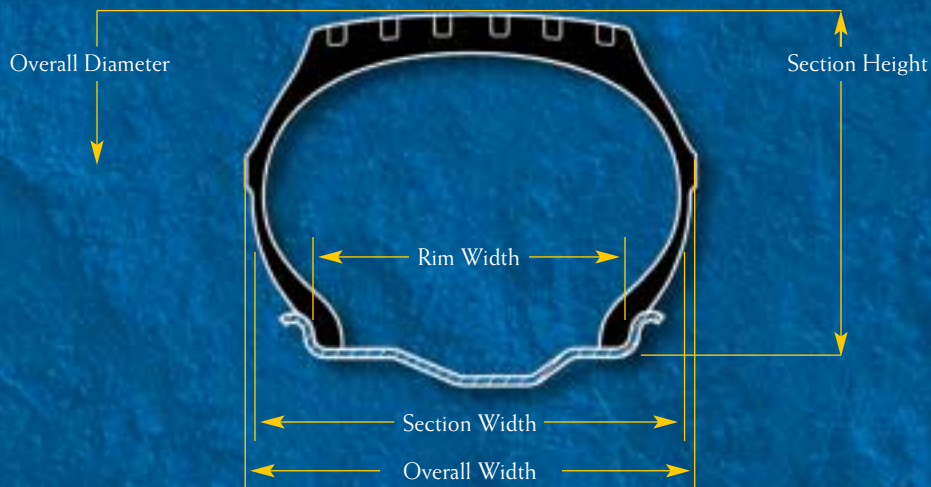

"Aspect Ratio" is defined as the percent of the section height to the section width of the tire.

Figure 2.4: Aspect Ratio



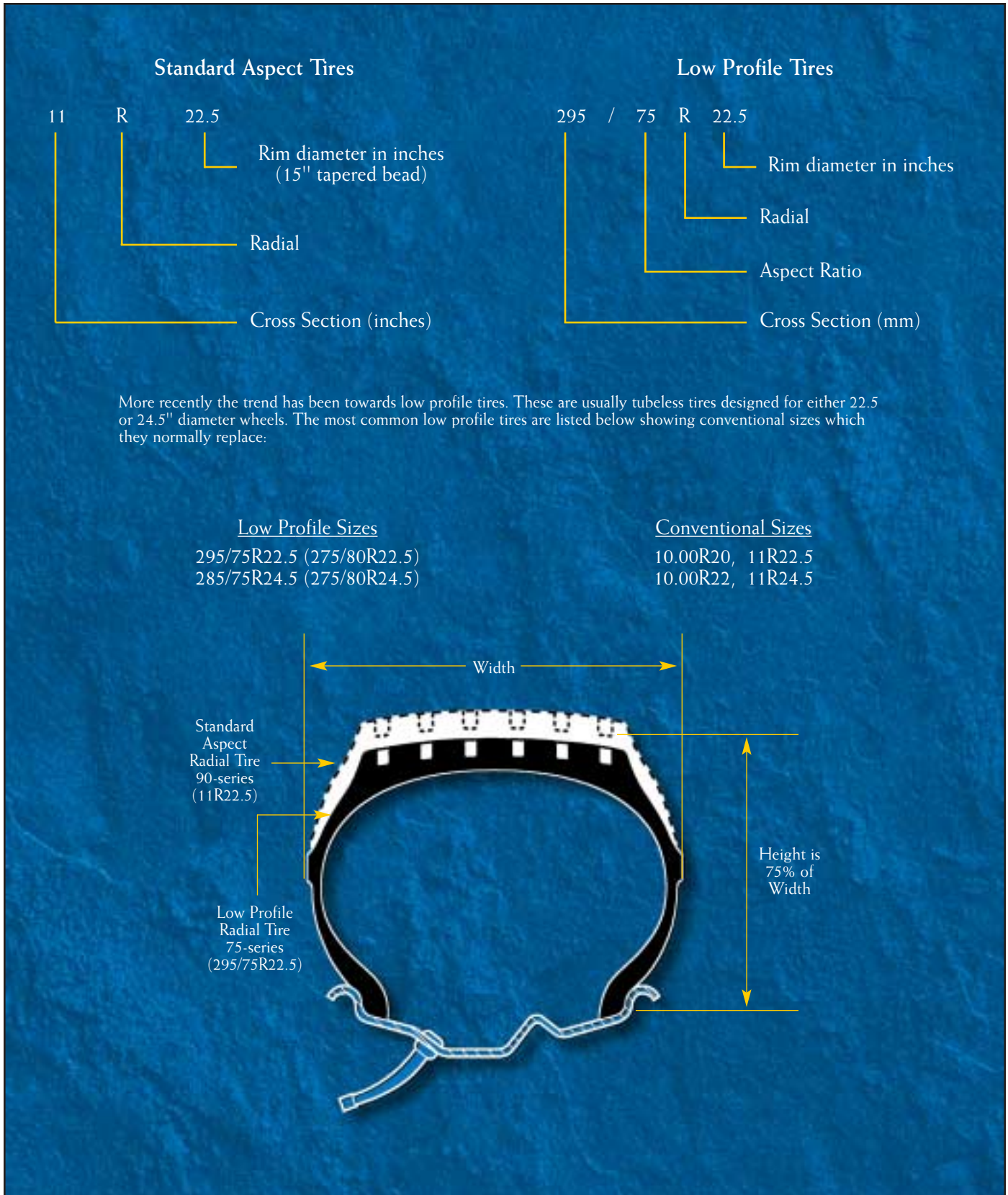

Figure 2.5: Sizing Definition

\*Information courtesy of The Maintenance Council (TMC) — Recommended Practices Book



# TIRE SELECTION PROCESS WORK SHEET

## STEP 1

Record maximum axle weights expected during vehicle operation.

Axle Weights	_____	_____	_____	_____	_____
	Steer	Drive	Drive/Trail	Trail	Trail

## STEP 2

Check types of service

- \_\_\_\_\_ Line Haul — Travel on interstate and normal highway roads at maximum speeds with runs over 250 miles.
- \_\_\_\_\_ Local — Most travel between and around city areas, with runs generally less than 250 miles.
- \_\_\_\_\_ On-Off-Road — Travel on some highway and secondary roads with possible travel on gravel/dirt roads.
- \_\_\_\_\_ Off-Road — Travel on mostly secondary and gravel/dirt roads with a potential for tread cutting due to rocks, debris, etc.

## STEP 3

Determine size restrictions

1. If spec'ing for new equipment, provide for adequate tire clearance and brake compatibility.
  - a. Minimum tire diameter due to brake restrictions \_\_\_\_\_
  - b. Maximum tire diameter desired \_\_\_\_\_
2. If retrofitting tires on existing equipment, will rim size change?
  - a.  No (State Rim Size) \_\_\_\_\_
  - b.  Yes (Select new rim size in Step 10)

If wheel size becomes larger (change from dual tires to wide-base tires or to larger dual tires), determine present tire clearances:

- (1) Vertical Tire Clearance \_\_\_\_\_
- (2) Front Wheel Clearance \_\_\_\_\_
- (3) Overall Width of Present Tire \_\_\_\_\_
- (4) Overall Diameter of Present Tire \_\_\_\_\_
- (5) Current Wheel Offset \_\_\_\_\_
- (6) Overall Width Across the Tires \_\_\_\_\_

## STEP 4

Write in type of tires to be used — Duals or Wide-Base \_\_\_\_\_

## STEP 5

Write in type of construction to be used — Radial or Bias \_\_\_\_\_

## STEP 6

Write in type of air retention construction — Tube-type or Tubeless (This will be determined by the type of rims to be used.)

\_\_\_\_\_

## STEP 7

Write in aspect ratio to be used  
(This step may be incorporated into Step 8.)

\_\_\_\_\_

## STEP 8

Select tire size from Tire and Rim Association tables or tire manufacturers' data books using the tire described in Steps 4 through 7. Do this by cross checking the axle weights and speed restrictions to be sure the tires can carry the maximum axle load recorded in Step 1 at operational speeds.

Tire Size \_\_\_\_\_ Dual Load \_\_\_\_\_ Single Load \_\_\_\_\_ at \_\_\_\_\_ psi

If maximum loads cannot be attained with the initial tire desired, a change in either Steps 3(1), 4, or 5 must be made. Repeat Step 8 until a tire size with the necessary carrying capacity is selected.

## STEP 9

Write in selected tire's dimensions from Tire and Rim Association tables or tire manufacturers' data books.

Overall Diameter \_\_\_\_\_

Overall Width \_\_\_\_\_

Revolutions per Mile \_\_\_\_\_

1. If specifying new equipment, redesign space restrictions if adequate clearance and brake compatibility are not afforded, or return to Step 8 and select another size tire.
2. If retrofitting tires on existing equipment and larger size tires than presently used are selected, determine clearances:

a. Vertical Clearances:

Vertical Tire Clearance of Present Tire \_\_\_\_\_

Overall Diameter of Present Tire + \_\_\_\_\_

= \_\_\_\_\_ (Subtotal)

Overall Diameter of Selected Tire - \_\_\_\_\_

Vertical Tire Clearance = \_\_\_\_\_

(Consult the vehicle or suspension manufacturer for minimum clearance required.)

Overall Vehicle Height \_\_\_\_\_

b. Front Tire Clearance:

Clearance of Present Tire	_____	
Overall Diameter of Present Tire	+ _____	
	= _____	(Subtotal)
Overall Diameter of Selected Tire	- _____	
Front Tire Clearance (Must be a positive number.)	= _____	

c. Overall Width:

Overall Width Across the Present Tire	_____	
Overall Width of one current outside tire	- _____	
	= _____	(Subtotal)
Overall Width of one selected outside tire	+ _____	
	= _____	(Subtotal)
Offset of both current outside wheels	- _____	
	= _____	(Subtotal)
Offset of both selected outside wheels	+ _____	
Overall Width (Must be 102" or less.)	_____	

If all clearances are not suitable, return to Step 8 and select a smaller size tire.

**STEP 10**

Select wheel/rim from Tire and Rim Association tables or wheel/rim manufacturers' catalogs. Check to see that load and inflation pressure ratings are adequate (compare with Single Load and Pressure in Step 8).

Wheel Size \_\_\_\_\_ Load Rating \_\_\_\_\_ at \_\_\_\_\_ psi

**STEP 11**

Select tread designs for steer, drive, and trailer positions using Technology & Maintenance Council Recommended Practice 220, *Tire Tread Design Selection*. Call 800-ATA-Line to order.

**STEP 12**

Incorporate fleet operation considerations at this point. Compute gear ratio changes if appropriate.



# Mounting Procedure

It is essential that good mounting procedures be followed in order to obtain optimum tire performance and operating efficiency. Also, tire and rim servicing can be dangerous.

To prevent serious injury, be sure you know, understand and follow all procedures and safety instructions.

## SAFETY INSTRUCTIONS

Do not mount or demount tires without proper training. Wall charts containing mounting and demounting instructions for all on-highway rims should be available through your normal rim supplier. "Safety Precautions for Mounting and Demounting Tube Type Truck/Bus Tires" are also available through the United States Department of Transportation, National Highway Traffic Safety Administration, Washington, DC 20590. [www.nhtsa.dot.gov](http://www.nhtsa.dot.gov)

## WHEEL INSPECTION GUIDELINES

Remove any and all cracked wheels from service.

Cracked wheels not removed from service will fail.



Inspect wheels for sometimes small cracks emanating from stud holes.



These cracks will continue to grow outward, through the "dish" or between stud holes.



Inspect wheel mating surfaces for chaffing, corrosion or pitting.



Mating surfaces should be clean, smooth, and flush so as to permit uniform distribution of clamping and torquing forces.



Remove wheels from service with excessively worn mating surfaces and/or worn or "wallowed" stud holes.

## LUBRICATION

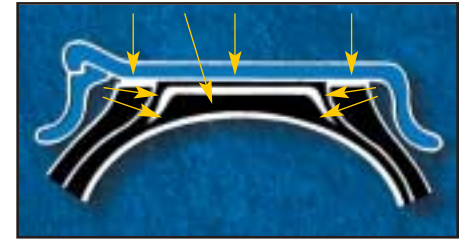

Figure 3.1 Lubricate areas shown by arrows

A non-water base commercial bead lubricant should be used since water in the tire can cause excessive rim corrosion problems. However, thin vegetable oil soap solutions with a water base are approved. Lubricants which contain a rust inhibitor can be an advantage. Avoid the use of excessive lubricant Figure 3.1.

Never use anti-freeze, silicones, or petroleum based lubricants.



Figure 3.2 Area of tube stretched thin due to improper lubrication and mounting.

When a tube and flap are not properly lubricated before mounting, they will be stretched thin in the tire bead and rim region Figure 3.2. This will cause premature failure.



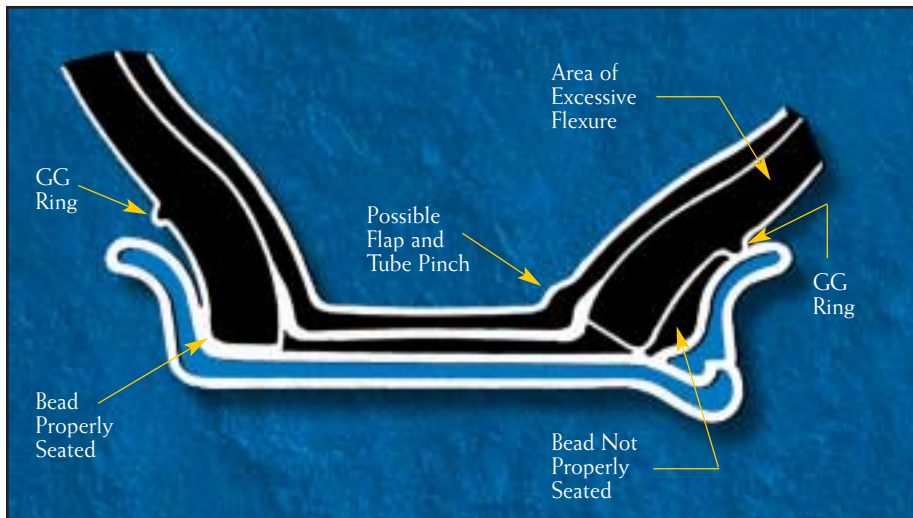

Figure 3.3 Improper bead seating

Always use lubricant when mounting radial truck tires to ensure proper bead seating and to prevent eccentric mounting. The more flexible sidewall of the radial tire makes the use of lubricant in the bead area more critical than for bias ply tires which have stiffer sidewalls. If the bead is not properly seated on either a 2-piece or 3-piece rim and becomes "hung-up," usually on the removable flange side of tube type tires, the lower sidewall area flexes excessively under load, and irregular treadwear and cracking in the lower sidewall bead area often result. Improperly seated beads can also produce severe truck vibration and cause chafing through the lower sidewall down to the wire.

When the bead is not properly seated, the bead toe is lifted, and the flap may be forced under the toe **Figure 3.3**. Continued up and down flexing of the toe can cut through the flap. As this process continues, the tube becomes pinched and may fail suddenly.

## TIRE & RIM CLEANING

To prepare the tire, first clean and dry the inside with an air hose. Inspect for loose material inside. A small piece of paper left inside a tube type tire can chafe a hole in the tube and cause a flat. Dust the inside of the tire sparingly with dry soapstone to prevent the tube from sticking to the tire. Do not let soapstone accumulate in the tire.

Also inspect and clean the tire beads to remove any accumulation of corrosion material or rubber that may be stuck to it. Wipe the beads with a dry cloth until clean.

Clean rims to remove dirt, surface rust, scale and rubber build up. Repaint to stop the detrimental effects of corrosion and facilitate checking and tire mounting. Be sure to clean the tire seat areas thoroughly to insure proper fitment of the tire and to eliminate the potential for air leaks in tubeless assemblies. Also file or use emery cloth

to remove any burrs or nicks on the tire side of the rim. These may damage the tire during mounting or in service. Be very careful to clean all dirt and rust from the lock ring and gutter. This is important to secure the lock ring in its proper position. A filter on the air inflation equipment to remove moisture from the air line helps to prevent corrosion. Drain the air tank frequently. The filter should be checked periodically to see that it is working properly.

Check rim components periodically for cracks. Replace all cracked, badly worn, damaged and severely rusted components with new parts of correct size and type. When in doubt replace. Mark or tag the unusable parts as scrap and remove them from the service area.

Do not, under any circumstances, attempt to rework, weld, heat, or braze any rim components that are cracked, broken, or damaged. Replace them with new parts or parts that are not cracked, broken, or damaged and which are of the correct size and type.

Make sure matching parts are being assembled. Check DOT chart, your distributor or the manufacturer if you have any doubts.



## TUBES & FLAPS

Always install a new radial tube and a new radial flap in a new tire. Use only tubes designated for radials and make sure the proper size tube and flap is used. Never use undersized tubes. Certain precautions must be taken when mounting used flaps, or damage to the tire and tube will result.

New truck and bus flaps can be used with any one of several different tire and rim sizes as recommended. But, once used, the flap must be remounted in the same size tire and on the same size rim from which it was removed. Always use a flap of adequate width to prevent tube pinching.

As a precaution against flap failure, mark the tire and rim size on the flap at the time of removal (if inspection shows that it is not damaged and can be used again). When the flap is again mounted, this marking protects against the danger of misusing the flap with the wrong size tire and rim.

### CAUTION

Used flaps cause tube failure unless mounted with the size tire and rim originally used.

The valve core provides a temporary air seal while air pressure checks are being made, but it will leak air slowly if the cap is loose, missing, or damaged. Use a sealing-type valve cap. A metal cap is preferred but a sealing-type nylon cap is acceptable.

In the case of used tires and tubes, recondition the valve stem every time a tire is mounted. Recondition the threads on both the inside and the outside of the stem with a valve stem rethreader tool. Install only new valve cores. Used or dirty valve cores may be defective. Don't take a chance. Valve cores must be stocked in clean closed containers at all times, since a small particle of dirt will render a core ineffective.

## ASSEMBLY OF TIRE TUBE FLAP

Insert the tube into the tire and partially inflate it to round out the tube. Apply rubber lubricant to the inside and outside surfaces of both beads and to the portion of the tube that appears between the beads. Do not allow lubricant to run down into the tire. Apply the lubricant with a cloth, swab, or brush.

For detailed, illustrated instructions on procedures and proper use of tire tools in mounting and demounting Goodyear radial truck tires on various types of rims, see the wall charts available through RMA ([www.rma.org](http://www.rma.org)).

After mounting and before inflating the tire, inspect all components of multipiece rims to make sure they are in place. See that tires are properly mounted and seated on the rims by checking the distance between the tire CG ring and the rim flange. This distance should be the same all the way around the tire; that is, the rim flange must be concentric with the CG ring (refer to the photograph **Figure 3.4** below, and **Figure 3.3** on page 19, for CG ring location on tire) and the distance must be the same for both sides.



Figure 3.4 Use of GG ring to indicate correct mounting

### ! WARNING

Always use a safety cage or approved safety device and extension hose with air gauge and clip-on air chuck for airing a tire on a multi-piece rim or single piece rim.

Tube type tires should always be aired once before the valve core is installed. This will eliminate confusion in inflating a tire twice. All tube type radial tires should be inflated twice.

To inflate twice, the tire is inflated to full inflation pressure, then all the air is let out and the tire is reinflated. The first inflation seats the bead of the tire, but over stretches the tube and flap in the area between the bead toes. Completely deflating the tire allows the tube and flap to relax. A partial deflation doesn't get the job done. The full deflation and reinflation stretches the tube and flap uniformly.

Important: During the first inflation, the airing should be stopped at about 10 psi, and the side ring or lock ring should be checked carefully to make sure it is properly seated. Also, it is recommended that the side ring or lock ring seating be checked at 10 psi during the second inflation.

### ! WARNING

Never, under any circumstances, attempt to seat rim components by tapping with mallet when tire is inflated or partially inflated. Deflate tire first.

Install a sealing-type valve cap finger tight. A valve cap has two functions to perform. The first is to keep dirt from damaging the valve core sealing surface. The second, is to provide an air seal for

## TUBELESS TIRE MOUNTING

the valve. A valve cap, therefore, must be durable.

The black plastic cap that sometimes comes on a new tube is not a valve cap and will leak air at the high inflations used in truck tires. Its purpose is to keep dust and dirt out of the stem during shipment, protect the threads of the stem, and shield the folded tube against abrasion by the threads. The plastic cap threads are easily stripped; the plastic cap will crack in cold weather and will melt if the stem comes in contact with the brake drum. A metal valve cap contains a rubber gasket which provides an air seal; a plastic cap contains none. Therefore, always use a metal cap or a self-sealing nylon cap.

Valve extensions, or "air-through" valves are not a substitute for caps, since they are still subject to core seal leaks at high pressure. Valve extensions require a sealing-type valve cap.

Bend the valve stem to its proper position. If it is left flat and touching the rim, the valve cap will be difficult to remove and accurate air pressure checks will be hindered. (If it is easy to check the pressure in a tire, it is more likely to be checked.) The stem should not be bent up enough to cause it to touch the brake drum. Heat from the drum will be conducted along the brass valve stem to the tube/flap area around the stem base and cause decomposition of the rubber. This will lead to eventual tube failure. In such a heated valve stem, the valve core seal may also be ruined.

After the tire is mounted and inflated, the tire/wheel assembly should be put into stock for 24 hours to permit a test of its air retention. Just prior to being put in service, the pressure in the tire should be checked and compared with the initial value applied. If the pressure is more than 5 psi lower, the tire should be withheld from service and checked for a leak.

For mounting tubeless tires, the procedure is about the same as for tube type tires except that it is not necessary to inflate twice. Cleaning the rim is again critical because the tire depends on the rim for its air seal. Make sure the inside of the tire is clean and dry. If tires have been stored outdoors, any water in the tire must be removed and the tire dried before mounting. Water vapor in the inflation air tends to cause rim corrosion. The valve stem must be inspected to make sure it is tight in the rim and that the rubber grommet between the rim and stem is in good condition.

To install the tubeless tire on the rim, lubricate both bead seats of the rim and both tire beads to ensure damage-free and uniform mounting. Bead lubricant must also be used during demounting to avoid damage to the bead area. Due to their greater sidewall flexibility, it may be necessary to use an inflation aid to help seat radial tubeless tire beads. For detailed mounting and demounting instructions, refer to the wall charts available through OSHA Occupational Safety and Health Administration ([www.osha.gov](http://www.osha.gov)). When using tire irons, exercise caution to prevent damage to the tire or rim.

Check that the distance between the tire GG ring and the top of the rim or wheel flange is uniform all around the tire, and that the distance is the same on both sides of the tire. If this distance is not uniform, the bead is not properly seated.

If the GG ring is not concentric with the rim flange, it is recommended that the "inflate-twice" procedure also be used in mounting tubeless tires in order to seat beads properly.

### WARNING

Always use a securely held safety cage and extension hose with clip on air chuck for airing the tire. Rapid air loss can propel the assembly.

## INSTALLATION

Installation of the tire on the vehicle is the final step. When pulling a tire from stock, check the air pressure against the desired value. When tires are to be mounted as duals, make sure that the two tires are actually the same size. (See Matching of Duals on page 25.)

Measure the outside diameter of every tire after it is mounted and inflated and before it goes into stock. The diameter should be written on the tread so that it is visible when the tire is in the spares rack. Then by simply looking at the treads of the spares in stock, a replacement tire of the correct diameter to match an already mounted dual can be selected.

There are many ways of measuring the size of a tire, but two ways appear to be more satisfactory than the others. Both involve measuring the complete circumference of the tire. The first uses a 14-foot endless steel mating tape. This is a steel band that is formed into a hoop. The hoop is slipped over the tire, pulled up tight, and a reading made. The second type is a pocket-size steel tape. With this it is necessary to hook the end in the tread and roll the tire one revolution, which brings the tape end back around and permits a reading of the circumference.

Another way of measuring tires uses calipers that measure tire diameter. The tape method is preferred because it provides an average diameter rather than any one particular diameter measurement.



Figure 3.5 Measuring with pocket size steel tape.

On demountable rims, lugs should be tightened uniformly in a triangulated or criss-cross sequence to achieve trueness of the rim on the wheel. Lug nuts should be torqued properly so they do not loosen in use. On disc wheels, stud nuts should also be drawn up and tightened in a criss-cross sequence. See rim and wheel manuals for more installation details. Lug or stud nuts should be checked for tightness after the first 100 miles of travel and once each week thereafter.

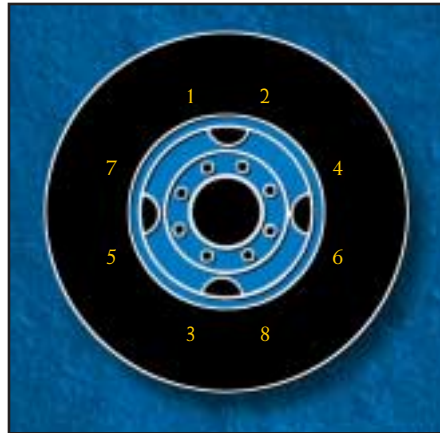

Figure 3.6 Proper sequence for tightening stud nuts on an 8 stud system.



Figure 3.8 Proper sequence for tightening stud nuts on 10 stud system.



Figure 3.7 Proper sequence for tightening stud nuts on an 5 and 6 stud systems.



## DEMOUNTING

Always deflate any tire to be removed prior to loosening rim or wheel nuts. Bead lubricant must be used when demounting tubeless tires.



## MATCHING OF DUALS

Mismatched duals have the same effect on the life of tires as low inflation or overload. An underinflated tire on a dual assembly shifts its share of the load to its mate, which then becomes overloaded and frequently fails prematurely. A difference of 15 psi inflation may result in the lesser inflated tire supporting 500 pounds less than the tire with the proper inflation. A similar action occurs when one tire's diameter is smaller than its mate. A difference of 1/4 inch in diameter may result in the larger tire carrying 600 pounds more than the smaller. The shift in load becomes more prevalent as the difference in diameters or inflation becomes greater.

Improperly matched duals are subject to rapid treadwear because the larger tire carries more load and will wear fast. Although the mismatched duals have different diameters, they must rotate at the same speed. The smaller tire then also wears unevenly because it is forced to scuff over the road. The overall result is abnormal and unequal treadwear for both tires.

Improperly matched duals may also lead to sudden air loss as a result of one tire being required to flex severely in doing more than its share of the work.

In addition to matching diameters and inflation pressures on dual installations, it is very important not to mix radials and bias ply tires on the same axle due to different load/deflection characteristics of these two types of tires. Radial tires deflect more under a given load than bias ply tires. If radial and bias ply tires are mixed in dual installations on the same axle, the bias ply tires will bear the greater part of the axle load and may operate in an overloaded condition that will lead to reduced mileage and early failure.

Radial tire overall diameter will govern the revolutions per mile obtained from a given tire. It is necessary to closely match tire revolutions per mile with tandem drive axle units coupled directly together, as when an interaxle differential does not exist or is locked out. Otherwise, the drive transmission may freeze up or fail in some way, and/or excessive slip on one of the sets of tires will lead to a loss in traction and uneven wear.

It is important that the tires of tandem driving axles be inspected and matched at regular periods, as determined by the type of service.

Matching dual tires is important to insure even wear and load sharing capabilities. Tire circumference of duals should be as close as possible with a maximum tire circumference tolerance of 3/4" for tire sizes 8.25R20 and 1-1/2" maximum circumference tolerance for tire sizes 9.00R20 and larger.

When mounting duals on a truck, there will generally be some difference in the diameter of the two tires (within the limits described above). Mount the small tire on the inside. The outside tire wears faster than the inside tire. As it wears its diameter will approach that of the inside tire. Additionally, any crown on the road will favor the placement of the smaller diameter tire on the inside.

At the time of mounting duals on a vehicle, locate the two valves diametrically opposite (180 degrees apart) for accessibility. Hand holes on disc wheels must be located so that the inside valve is accessible.

## SPACING OF DUALS

Proper spacing between dual tires is important. Too often, the service rendered by dual tires is sharply reduced because of insufficient spacing. It is a condition caused by either (a) oversized tires or (b) improper rims and wheels. Tires mounted too close together do not allow proper air circulation to dissipate tire heat. Heat increases tire tread loss rate and reduces tire durability. When a truck is heavily overloaded, insufficient spacing can cause the sidewalls of the duals to rub together, wear off rubber, and become overheated due to continuous friction.

If the space between duals is too great, there will be excessive dragging and scuffing of the outside tire each time a turn is made. Also, check overall vehicle track width to assure compliance with width laws.

Note that proper dual spacing for radial tires is the same as for bias ply.

An understanding of the geometry of a dual tire installation is important. A cross-section through a typical dual installation is shown in **Figure 3.9**. The dual spacing of the installation is the sum of the rim offsets and the spacer width.

To determine tire clearance, subtract the section width from the figure for dual spacing. Use the loaded section width (LS) at rated load for a more exact clearance figure. The loaded section width can be found in the Goodyear Truck Tire Engineering Data Book, or the width of a tire can be measured under load.

Dual spacing and tire clearance can be varied by changing spacer width. To increase spacer width, however, the mounting width on the dual wheel must be great enough to accommodate a wider spacer. The distance from the outside tire wall of one dual assembly to the outside tire wall of the assembly on the other side of the truck will be made greater when spacer width is increased. If this distance is the maximum width of the vehicle, state laws governing truck width must be considered.

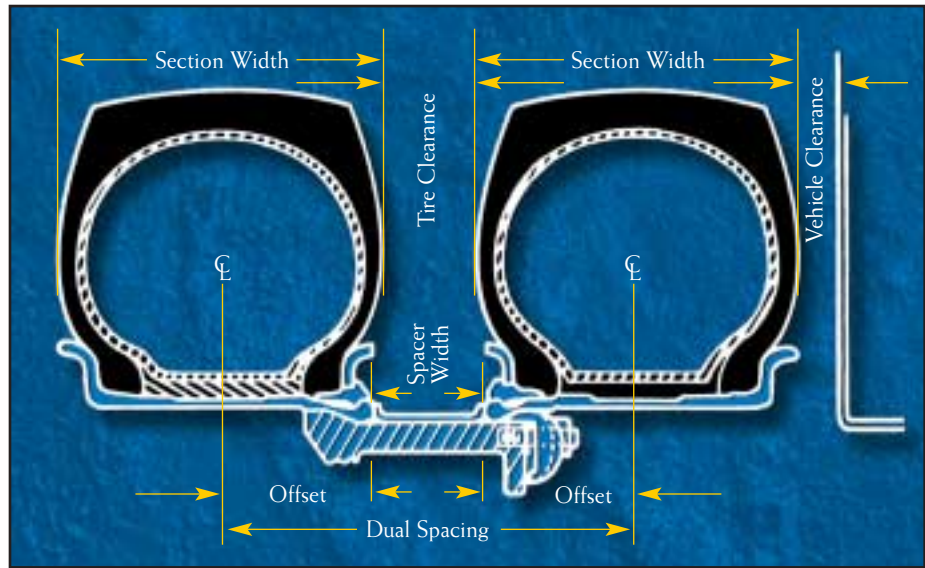

Figure 3.9 Cross-section through typical dual installation

Rim offset determines dual spacing and affects vehicle clearance and possibly overall vehicle width. Any change in offset of the inside rim will change vehicle clearance proportionally. Any offset changes of the outside rims will change the overall distance across the vehicle from outside tire wall to outside tire wall.

Both load and inflation must be considered in selecting rim size or type. Consult rim manufacturer for recommended rim style for extra ply rating tires.

## SPACERS

Spacer installation procedure is as follows:

1. Examine spacer brand to be sure it is not damaged, bent, or distorted. It should be perfectly circular.
2. Do not roll vehicle, wheels, axle, or assemblies on spacers.
3. Position inside rim over cast spoke wheel as close as possible to the mounting level.
4. Push spacer band over cast spoke wheel with consistent pressure on both sides. Avoid cocking band. Achieve snug fit against spokes and inside rim gutter edge.
5. Turn spacer band on wheel to check concentricity.
6. Position outside rim, install outer rim clamps and tighten nuts evenly. Tighten nuts gradually in a criss-cross sequence across the diameter of the wheels. Consult rim manufacturer's recommendations for proper torque range.
7. Examine clamps to be sure they have not bottomed out. Check rim edges to be sure they consistently meet the spacer band edges.
8. After road service, recheck torque.

### PROPER MATCHING OF RIM PARTS

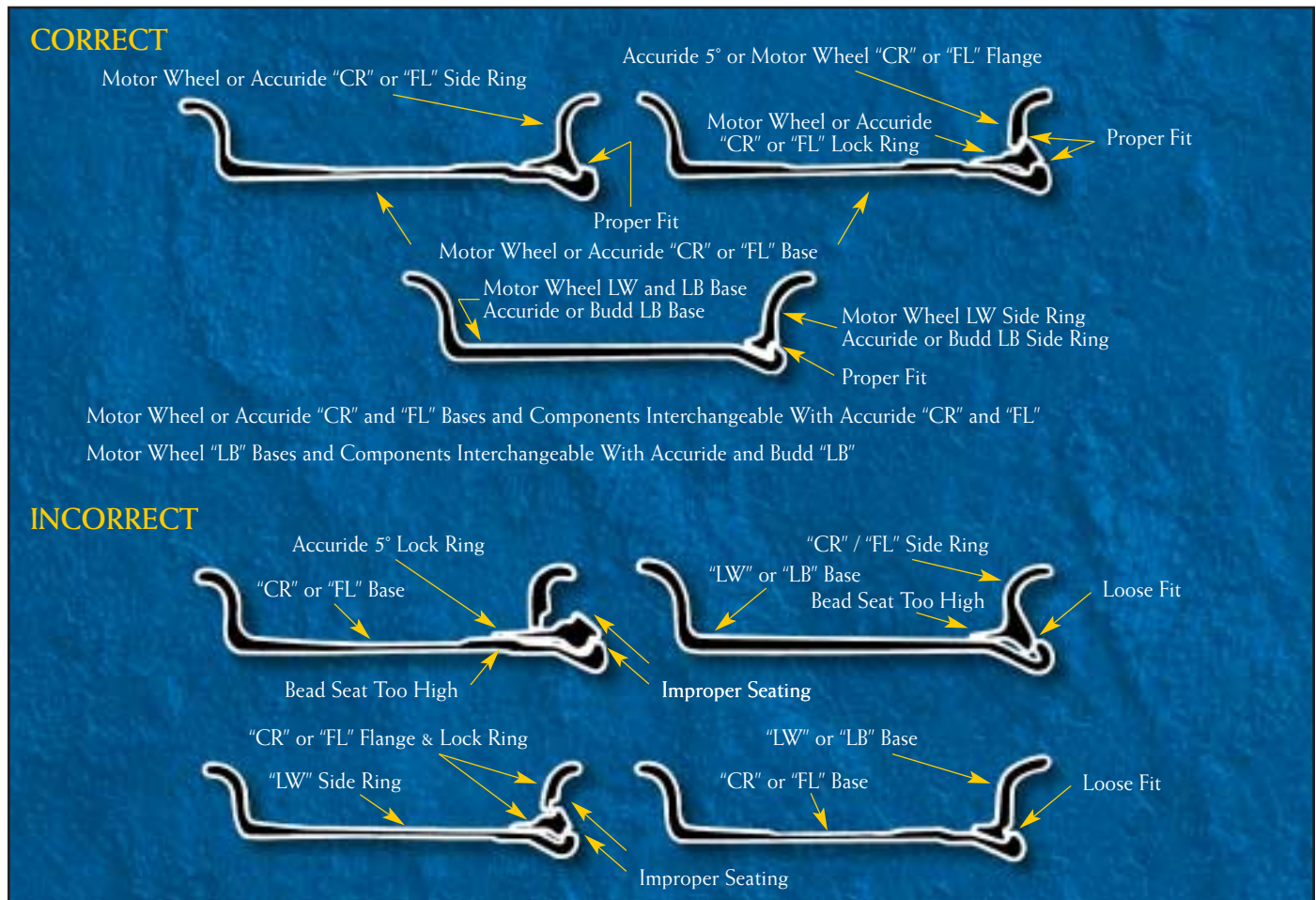

Figure 3.10 Correct and incorrect matching of rim parts

Most highway rims look alike, but all vary somewhat in certain construction features. Variances between rims of different types make part mixing hazardous. A close, proper fit between rim parts is essential to long tire life as well as operating safety. Although side rings, flanges, and lock rings of different types appear to be properly seated, difficult to detect gaps are often present.

The illustrations in Figure 3.10 show correct, safe matchings of rim parts. Mismatched rings and bases, which almost always create an unsafe operating condition are also shown. For more information, refer to Department of Transportation (DOT) Multipiece Rim/Wheel Matching Chart. ([www.dot.gov](http://www.dot.gov))

In addition to the safety problems posed by mismatched rings and bases, mismatched components can cause special problems in tire, flap, and tube wear.

Mismatched rim components that result in a high bead seat often achieve bead seating over only a portion of the rim circumference. This causes:

- Vibration
- Uneven wear
- Severe rim chafing at top of flange
- Larger gaps in two piece rim flanges which cut chafer
- Torn chafers at bead heel
- Cut bead heels, which generally identify this condition
- Bead base irregular chafing
- Lower sidewall separation due to stress concentration at flange top
- Broken beads

Mismatched assemblies that result in a low bead seat can sometimes be recognized by rust on the bead face. Such assemblies allow:

- Irregular bead base wear
- Off-center mounting, higher imbalance, more vibration
- Rotational slippage of tire on rim
- Valve stem tear-outs

Rim component mismatch — with either high or low bead seat diameter — permits bead rocking which can cause the tire bead toe to cut through the flap and tube. This additional bead movement can also cause the flap edge to cut through the tube. In either case, a flat tire is the eventual result.



## SAFETY PRECAUTIONS

### Inspection: Precautions And Reasons For Precautions

- Clean rims and repaint to stop detrimental effects of corrosion and facilitate checking and tire mounting. Be very careful to clean all dirt and rust from the lock ring and gutter. This is important to insure that the lock ring seats in its proper position. A filter on the air inflation equipment to remove the moisture from the air line helps prevent corrosion. The filter should be checked periodically to see that it is working properly.  
Parts must be clean for a proper fit — particularly the gutter section which holds the lock ring in proper position.
- Components that are cracked, badly worn, damaged, bent, repaired, or pitted from corrosion must not be used and must be discarded. When component condition is in doubt, replace.  
Parts that are cracked, damaged or excessively corroded are weakened.
- Do not, under any circumstances, attempt to rework, weld, heat, or braze any rim components that are cracked, broken, or damaged. Replace with new parts or parts that are not cracked, broken, or damaged and which are of the same size and type and are compatible with the other parts.  
Heating may weaken a part to the extent it is unable to withstand forces of inflation or operation.
- Make sure correct parts are being assembled. Check your distributor or the manufacturer if you have any doubts.  
Mismatched parts may appear to fit, but when the tire is inflated may fly apart with explosive force sufficient to cause serious injury or death.
- Don't be careless or take chances. If you are not sure about the proper mating of rim and wheel parts, consult a rim and wheel expert. This may be the tire man who is servicing your fleet, the rim and wheel distributor in your area, or the manufacturer's sales engineer.  
Failure to exercise proper care can result in serious physical injury or death.
- Don't reinflate a tire that has been run flat or has been run at 80 percent or less of its recommended operating pressure, or when there is obvious or suspected damage to the tire or wheel components.  
Components may have been damaged or dislocated during the time the tire was run flat or seriously underinflated.



## MOUNTING AND INFLATION: Precautions For Potential Steel Cord Fatigue Damage

Underinflated truck tires can be subject to cord fatigue in the upper sidewall area caused by over-flexing of the tire. This cord fatigue leads to a loss of strength of the ply cords. When a tire loses air and is continued in service without remedial action, it may sustain internal damage that could lead to failure upon reinflation or subsequent service. When such a tire is reinflated, or removed from the rim (for example, for tire repair or maintenance) and then remounted, inflation used to bring the tire to its operating pressure may cause one or more of the weakened cords to break. This cord failure causes an increase in tension on cords adjacent to the broken cord, with the result that more of the weakened cords may fail. This breakage may continue until a rupture occurs in this area of the tire with accompanying air loss, which is commonly referred to as a Zipper Rupture.

Permanent tire damage due to underinflated operation cannot always be detected. Any tire known or suspected to have run at 80% or less of normal operating inflation pressure could possibly have permanent structural damage and should be treated as having been operated flat or underinflated. The tire should be demounted using proper precautions and should not be reinflated until the tire is carefully inspected by a trained technician for determination of the cause of the inflation loss, and any possible structural damage. (See pages 29 - 31)

### GOODYEAR STRONGLY RECOMMENDS THAT:

- Truck tires should be visually inspected daily for cuts, snags, penetrations or puncturing objects.
  - Proper tire inflation be maintained.
  - Highway truck tire inflations be checked at least weekly, or more frequently if operating conditions dictate, using an accurate calibrated air gauge.
  - Any tires suspected to have been operated underinflated must be clearly marked and segregated, so as to prevent their accidental use prior to being thoroughly inspected by a trained tire technician.
  - Tires that show discoloration and wrinkling of the innerliner, and/or weakness and distortion of the upper sidewall (indications of damage due to underinflation) are to be scrapped.
  - After servicing the tire, inflate it to 20 psi OVER recommended operating pressure in an APPROVED SAFETY CAGE USING A CLIP-ON CHUCK, EXTENSION HOSE AND PRESSURE REGULATOR. Allow the tire to remain overinflated for 20 minutes and then deflate to the recommended operating pressure BEFORE removing from the safety cage.
- Goodyear's long-standing policy and Occupational Safety and Health Administration ([www.osha.org](http://www.osha.org)) Standard 1910.177, require that all tubeless and tube type truck tires be inflated in an OSHA approved inflation safety cage in conjunction with the use of an extension air hose equipped with a clip-on air chuck.
  - While this OSHA standard pertains to medium truck tires, Goodyear strongly recommends these procedures be used for all LIGHT TRUCK tires also.

UNLESS THE PRECAUTIONS NOTED ABOVE ARE CAREFULLY AND COMPLETELY FOLLOWED, SUCH FAILURE MAY CAUSE SERIOUS PERSONAL INJURY OR DEATH.

## MOUNTING AND INFLATION: Precautions And Reasons For Precautions

- Always match a tire (size) diameter designation with exactly the same rim diameter designation. Don't assume that it came in with proper size.
- Rims of different diameters and tapers cannot be interchanged.
- Don't try to seat rings or other components by hammering while tire is inflated or partially inflated.
- Never introduce a flammable substance into a tire — before, during or after mounting.

Doing so is unsafe and may result in internal tire damage or fire, rim damage or a potentially dangerous vapor remaining in the tire. Any of these conditions could cause serious personal injury during the mounting and inflating procedure.

- Double check to make sure all components are properly seated prior to and after inflation.
- Always inflate in a safety cage or use another restraining device that is approved by the Occupational Safety and Health Administration ([www.osha.gov](http://www.osha.gov)).
- Don't inflate a tire before all components are properly in place. Place assembly in a safety cage or use another restraining device and inflate to approximately 10 psi. Recheck components for proper assembly. Observe that the O-ring does not roll out of its groove. If the assembly is not proper, deflate and correct. Never hammer on an inflated or partially inflated tire/rim assembly. If the assembly is proper at approximately 10 psi, continue to inflate to fully seat the tire beads.

If tube type, inflate tire to approximately 75 psi pressure (Grader, 50 psi). Then completely deflate to remove buckles and uneven stresses from the tube and flap before reinflating to correct operating pressure. This repeat inflation is necessary to prevent buckles which may lead to premature tube failures.

After completing inflation, check valve and rim components in both bead areas for leaks. Observe tire lower sidewall circumferential groove's concentricity with top of flange. If the distance between the groove and rim flange varies by 1/8" or more around the circumference or from one bead to the other, the tire beads must be unseated from the bead seat, relubricated and resealed.

- Never sit on or stand in front of, or over, a tire and rim assembly that is being inflated. During inflation, always use a clip-on chuck with sufficient length of hose to permit standing clear of the potential trajectory of the wheel components, and use an in-line valve with gauge or a pressure regulator preset to a desired value when inflating a tire. When a tire is in a restraining device, do not lean any part of your body or equipment on or against the restraining device.

If parts are improperly installed they may fly apart with explosive force sufficient to cause serious injury or death. Rapid air loss can propel an assembly.

- Follow recommended mounting, demounting, inflating and deflating procedures for tires and rims as outlined in this manual.

Misassembled parts may fly apart during inflation: check at 10 psi to determine whether parts are in proper position.

- Don't hammer on rims or components with steel hammers. Use rubber, lead, plastic or brass faced mallets if it is necessary to tap uninflated components together. Mallet faces should be in good condition to avoid chips from mallet face inside of the components. Properly matched and assembled components will seat without tapping. If a part is tapped, it or the tapping tool may fly out with explosive force.
- When moving a tire or wheel with a cable or chain sling, stand clear. The cable or chain may break, lash out and cause serious injury.
- Never attempt to weld on an inflated tire/rim assembly or on a rim assembly with a deflated tire. Heat from welding will cause a sudden, drastic increase in pressure, often resulting in a large, explosive force. Deflated tires can catch fire inside the air chamber.
- Mixing parts of one type rim with those of another is extremely dangerous. Always check manufacturer for approval if in doubt.



### OPERATION: Precautions And Reasons For Precautions

- Always use rims recommended for the tire. Consult catalogues for proper tire/rim matching.
- Don't overload or overinflate tire/rim assemblies. Check for adequate rim strength if special operating conditions are anticipated.

Excessive overload or overinflation can cause damage to the tire and rim assembly.

- Never run a vehicle on one tire of a dual assembly.

The carrying capacity of the single tire and rim is dangerously exceeded, and operating a vehicle in this manner can result in damage to the rim and tire or cause a tire fire.

- Never use a tube in a tubeless tire/rim assembly where the rim is suspected of leaking.

Loss of air pressure through fatigue cracks or other fractures in a tubeless rim warns you of a potential rim failure. This safety feature is lost when tubes are used with leaking rims. Continued use may cause the rim to burst with explosive force.

- Always inspect rims and wheels for damage during tire checks.

Early detection of potential rim failures may prevent serious injury.

- Never add or remove an attachment or otherwise modify a rim (especially by heating, welding or brazing) unless the tire has been removed and approval has been received from the rim manufacturer.

Modification or heating of a rim or one of its parts may weaken it so that it cannot withstand forces created by inflation or operation.

### SERVICING TIRE AND RIM ON VEHICLE: Precautions And Reasons For Precautions

- Block the tire and wheel on the opposite side of the vehicle before placing the jack in position.
- Regardless of how hard or firm the ground appears, put hardwood blocks

under the jack. Always provide for vehicle support with blocks just in case the jack should slip.

The vehicle may shift, slip off the jack and cause injury.

### Inspection Procedures For Identification Of Potential "Zipper Ruptures" In Steel Cord Radial Medium And Light Truck Tires

Any tire suspected of having been operated underinflated and/or overloaded must be approached with caution.

Completely deflate the tire by removing the valve core before removing the tire/rim/wheel assembly from the vehicle. After removing from the vehicle, clearly identify the tire, so it will not be reinflated **until carefully inspected by a trained technician**, to determine the cause of inflation loss, as well as any tire damage resulting from underinflation and/or overloading.

#### **WARNING**

Permanent tire damage due to underinflation and/or overloading cannot always be detected. Any tire known or suspected to have been run at 80% or less of normal operating inflation pressure and/or overloaded, could possibly have permanent structural damage (steel cord fatigue). Ply cords weakened by underinflation and/or overloading may break one after another, until a rupture occurs in the upper sidewall with accompanying instantaneous air loss and large explosive force. This can result in serious injury or death.

## Inspection Procedures For Tires Suspected Of Having Been Run Underinflated And/Or Overloaded



Inspect Deflated Suspect Tires Mounted on the Rim –

**LOOK for:**

cuts, snags, or chips exposing body cords or steel\*; distortions or undulations (ripples and/or bulges), using an indirect light source, which will produce shadows left by any sidewall irregularities.

**FEEL for:**

soft spots in the sidewall flex area; distortions or undulations (ripple and/or bulges); protruding filaments indicating broken cords; and

**LISTEN for:**

any popping sound when feeling for soft spots or when rolling the tire.

If any of these conditions are present, the tire should be made unusable and scrapped. \*If no other condition is present and a tire contains cuts, snags, or chips exposing body cords or steel, it must be referred to a full-service repair facility, to determine if it is repairable and not a source of a potential zipper.

If none of these conditions are present, place the tire/rim/wheel assembly in an approved inflation safety cage. REMAIN OUTSIDE OF THE TIRE'S TRAJECTORY. DO NOT PLACE HANDS IN SAFETY CAGE WHILE INSPECTING TIRE, OR PLACE HEAD CLOSE TO SAFETY CAGE. With the valve core removed, reinflate the tire to 20 psi, using a clip-on air chuck with a pressure regulator and an extension air hose.



Inspect Suspect Tire Inflated to 20 psi —

**LOOK for:**

distortions or undulations (ripples and/or bulges); and

**LISTEN for:**

any popping sound.

If any of these conditions are present, the tire should be made unusable and scrapped.

If none of these conditions are present, dismantle the tire to visually and manually inspect it, both inside and outside.



Inspect Suspect Tires after Dismounting —

**LOOK for:**

bead rubber torn to the fabric or steel\*; cuts, snags, or chips exposing body cords or steel\*; distortions or undulations (ripples and/or bulges), using an indirect light source, which will produce shadows left by any sidewall irregularities; creasing, wrinkling, cracking or possible discoloration of the innerliner; and any other signs of weakness in the upper sidewall.

If any of these conditions are present, the tire should be made unusable and scrapped. \*If no other condition is present and a tire contains cuts, snags, or chips exposing body cords or steel, it must be referred to a full-service repair facility, to determine if it is repairable and not a source of a potential zipper.

If none of these conditions are present, the tire may be returned to service, using the procedures on the next page.



### WARNING

STAY OUT OF TRAJECTORY AS INDICATED BY SHADED AREA.

Note: Under some circumstances, the trajectory may deviate from its expected path. Always deflate tires before handling. Inflate only in safety cage.

### Inspection Procedures For All Tires Returning to Service (Including used, retreaded, or repaired, regardless of being suspect or not suspect)



**Inspect Dismounted Tires (including used, retreaded, or repaired)–**

**LOOK for:**

bead rubber torn to the fabric or steel\*; cuts, snags or chips exposing body cords or steel\*; distortions or undulations (ripples and/or bulges), using an indirect light source, which will produce shadows left by any sidewall irregularities; creasing, wrinkling, cracking, or discoloration of the innerliner; any other signs of weakness in the upper sidewall;

**FEEL for:**

soft spots in the sidewall flex area; distortions or undulations (ripples and/or bulges); protruding filaments indicating broken cords; and

**LISTEN for:**

any popping sound when feeling for soft spots or when rolling the tire.

**If any of these conditions are present, the tire should be made unusable and scrapped. \*If no other condition is present and a tire contains tears, cuts, snags, or chips exposing body cords or steel, it must be referred to a full-service repair facility, to determine if it is repairable and not a source of a potential zipper.**

If none of these conditions are present, place the tire/rim/wheel assembly in an approved inflation safety cage. **REMAIN OUTSIDE OF THE TIRE'S TRAJECTORY. DO NOT PLACE HANDS IN SAFETY CAGE WHILE INSPECTING TIRE, OR PLACE HEAD CLOSE TO SAFETY CAGE.** After properly seating the beads, with the valve core removed, adjust the tire to 20 psi, using a clip-on air chuck with a pressure regulator and an extension air hose.



**Inspect Mounted Tires Inflated to 20 psi —**

**LOOK for:**

distortions or undulations (ripples and/or bulges); and

**LISTEN for:**

any popping sound.

**If any of these conditions are present, the tire should be made unusable and scrapped.**

If none of these conditions are present, with valve core still removed, inflate the tire to 20 psi OVER the recommended operating pressure. During this step, if *any* of the above conditions appear, **immediately stop inflation.**



**Inspect Mounted Tires Inflated 20 psi OVER Operating Pressure —**

**LOOK for:**

distortions or undulations (ripples and/or bulges); and

**LISTEN for:**

any popping sound.

Any tire suspected of having been underinflated and/or overloaded *must* remain in the safety cage at 20 psi OVER operating pressure for 20 minutes.

**If any of these conditions are present, the tire should be made unusable and scrapped.**

If none of these conditions are present, BEFORE removing the tire/rim/wheel assembly from the safety cage, reduce the inflation pressure to the recommended operating pressure. **REMAIN OUTSIDE OF THE TIRE'S TRAJECTORY.**

Occupational Safety and Health Administration Standard 1910.177 requires all tubeless and tube-type medium and large truck tires be inflated using an OSHA-approved restraining device (e.g. safety cage) or barrier, and using a clip-on air chuck with a pressure regulator and an extension air hose. While the OSHA ([www.osha.gov](http://www.osha.gov)) standard pertains to medium and large truck tires, RMA also strongly recommends these procedures be used for all LIGHT TRUCK TIRES.

### **WARNING**

Mounting Tires Is Dangerous - failure to follow the above and Rubber Manufacturer's Association (RMA) "Demounting and Mounting Procedures for Truck/Bus Tires" or "Demounting and Mounting Procedures for Automobiles and Light Truck Tires" charts and safety precautions can result in serious injury or death. For more information visit [www.rma.org](http://www.rma.org).



## Collecting & Storing Tire Information

Keeping appropriate records of your tire related data is the best source of information on tire performance, because they summarize your actual experience based on your equipment, your drivers, and your operating environment. They can help you to make cost effective tire purchase decisions and adjustments to tire and wheel maintenance schedules to better control costs.

### COLLECTING & STORING TIRE INFORMATION

Depending on the size of your fleet, tire data can be kept using a computer-aided method or simple paper files. Large fleets may need the huge information storage capacity and the networking capability of a computer. Small fleets may find the expense and complications of computer-aided information storage unnecessary. Whatever the method of storage, there are several common factors involved in tire data collection. Items recorded for tire performance records, at a minimum, should include:

- Tire Size
- Tire Brand/Type
- Initial Tire Cost
- Vehicle ID Number
- Vehicle Mileage at Installation
- Installation Date
- Tread Depth at Installation
- Recommended Inflation
- General Comments
- Actual Inflation
- Vehicle Removal Mileage
- Removal Date
- Tread Depth Removal

By building a base of information across the fleet, trends in tire performance can be established.

- How does mileage of Tire A compare to Tire B?
- Which tire brand produces the lowest cost per mile?
- Which tire has fewest adjustments?

A similar file can be used to track tire performance through retread life. Again, performance of various tread patterns, retread suppliers, and casing manufacturers can be closely followed. Decisions on future retread purchases can then be made on hard facts rather than perceptions and guesses.

Permanent identification of each tire can make the tracking from purchase to scrap easier. Tires could be branded, or a Radio Frequency Identification Chip could be added to the tire to provide a unique identity for that tire.

### BRANDING TIRES

Several branding methods exist. Before branding, you need answers to several questions. What branding method is best for the quantities of tires involved? On what part of the tire is it "safe" to brand? How deep can a tire be branded without damaging the tire? Should you buy tires branded to your specifications or brand them yourself? Many fleets brand their own tires. Others, particularly large fleets, find it more cost-effective purchasing tires branded by the manufacturer or distributor. Three common branding methods include the "cold method," "hot method" and "mold branding."

Cold branding is somewhat of a misnomer because some heat is part of the procedure. In this method, pressure, air or hydraulic, is used to produce a brand that is legible and usually less damaging to the tire than the higher temperature hot method. Another advantage to cold branding is its ability to emboss brand. Numbers and letters are raised much like the markings on a new tire. Embossed brands are less damaging to the tire than the more common recessed brands though often more difficult to read.

Both cold and hot methods provide permanent brands but the higher temperatures of a hot branding iron encourage branding too deeply into the sidewall. Also possible is overheating the rubber compound around the brand and creating a brittle surface area that could initiate sidewall crack. If care is exercised, the hot method using medium heat will yield acceptable results. Always strive for the lowest possible temperature to produce legible brands without scorching sidewall rubber.

A third method is "mold branding." This is done when the tire is being manufactured. While this method offers the best appearance, it's available only when large quantities of tires are ordered and usually for only bias-ply tires.

Use lower sidewall area. Most truck tires have a special branding panel on the sidewall. It's located on the lower portion of the sidewall where little flexing occurs under normal use, thus reducing the chances of cracking.

If your tires don't have these panels, then brand in the lower sidewall area between the top of the rim flange and the "line" around the tire at its maximum width. Never brand near the maximum section width area of a radial tire. That's the tire's critical sidewall flexing area. If you're branding tires without panels and wish to brand both sides, then apply brands on opposite sidewalls 180 degrees apart.

How deep?

In general, you should brand truck tires between 1/32 inch and 2/32 inch in depth. Brands less than this depth range are often difficult to read. Those greater can result in cracking that may propagate away from the branded area, or worse, they may go deeper into the sidewall rubber. Eventually, these deep cracks might reach the outer surface of the casing cords. This could allow moisture into the casing which then could lead to degradation of casing durability.

## RADIO FREQUENCY IDENTIFICATION TAGS

Passive radio frequency ("RF") identification devices can be molded into a tire or encapsulated in a patch and bonded to the inner liner of radial, medium and heavy duty, tubeless truck tires. Guidelines have been established by the *Technology and Maintenance Council* ([www.tmc.truckline.com](http://www.tmc.truckline.com)) to standardize the identification information provided by an RF transponder when it is installed during the tire manufacturing process, used in an aftermarket application in truck tires and provide minimum performance criteria for the use of this technology.

The transponder is a single chip, solid state, electronic device with an integral or external antenna. Each tag that passes within the radio frequency transmission range of a reader/interrogator will be energized and have its circuit turned on. In turn, the tag will respond by transmitting its encoded identification. The reader will receive the RF transmitted code and translate it into an alpha-numeric tire identification.

## RF TAG USAGE

Fleets may use RF tags for tire record keeping and maintenance as well as inventory. To ensure that RF tags are easily read and correlated with the proper tires, the following tire mounting procedures should be followed:

- A. Always mount tires with the DOT code side on the deep dish rim side of disc wheels, the fixed flange side of tube type demountable rims and the adapter side of tubeless demountable rims.
- B. The DOT code should be aligned with the valve stem so that local read RF tags can be located and found easily except in cases where match mounting takes a priority.
- C. Local read tags will then be readable on opposite sides when mounted as duals and will be readable on the inside of the steering axle except for directionally mounted tires.
- D. 360 degree read tags are not restricted by mounting.

Having well documented tire performance information allows intelligent decisions to be made on alignment intervals, recommended inflation pressures and tire brand or type choices.

Keeping appropriate records of tire information is a final step in achieving a lower cost per mile from tires. Having clear records not only helps decision making but also provides documentation of tire problems to be addressed by your tire company's representative.

After all, your goal as well as the goal of your tire representative is to provide you with the best tire for the job and to get all the mileage and service out of your tires that they can give.



## Inflation

Proper inflation of radial truck tires is the most important maintenance practice to ensure long tire life. Once proper tire inflation has been determined, it should be maintained at that level as consistently as possible. Loads carried may be increased/decreased for a given tire inflation when operating at reduced/increased speeds, but underinflation must never be allowed in over-the-road truck tires.

A tire requires proper air pressure to adequately carry the load placed on it. The "container volume," material properties and inflation pressure determine the load carrying capacity of the tire.

**Figure 5.1** Your tires provide traction for braking, accelerating and turning and must carry out these tasks for many miles. Without proper inflation pressure, tires cannot carry out these tasks as they were designed to do.

But what is the proper inflation for your tires? A simple answer would be great, but not practical.

#### Loads determine inflation

All tire manufacturers offer load/inflation tables that can be used to determine the proper inflation pressure at various loads.

Load/inflation tables for Goodyear commercial tires are published on the Web site [www.goodyear.com/truck](http://www.goodyear.com/truck) and in the Engineering Data Book for Over-the-Road Truck Tires. This book, available at your Goodyear Commercial Truck Tire Center, and is updated periodically with the latest sizes and types of commercial truck tires.

Section "L" in this data book provides the information you'll need to determine the proper inflation for your tires based

on load and service conditions. Most data contained in this book is taken from tables published by the Tire & Rim Association (T&RA). Its members, U.S.-based tire, rim and wheel manufacturers, set the technical standards for manufacturing those products in this country.

Using the tables is quite simple. First, determine the maximum load that your tire is likely to encounter. Then, for your tire size/ply rating, find the load in the table that is close to but slightly more than the maximum anticipated load. The inflation pressure at the top of this column is your minimum pressure for the load.

#### Duals vs. singles

Note that loads are shown for single and dual applications. When you run duals, the allowable load at any given inflation pressure will be less than with singles. That's to minimize overloading when one tire in a dual assembly is underinflated and to compensate for road crown.

Position is another consideration. Steer, drive and trailer tires may carry different loads, with steer tires normally handling the heaviest because they run as singles.

To optimize tire performance, you may require different inflation pressures in

each axle position. That would be ideal, but impractical for many linehaul fleets.

#### Equal inflation pressure

To compromise, determine the proper inflation pressure for each tire on the vehicle and use the highest pressure. Remember that overinflation is preferred to underinflation. That makes the compromise acceptable.

Also consider operating speeds. Vehicles operated at less than highway speeds can carry greater loads, as shown in **Table 3**.

Using load/inflation tables can help you get the most from your current tires. It can also help you choose future tire sizes based on your vehicles' needs and their service conditions.

Always check inflation pressures when tires are cold. Never bleed air from hot tires to relieve normal pressure build-up. The normal increase in pressure due to service conditions will be 10 to 15 psi, and this is allowable in a radial truck tire.

It is particularly important to keep moisture from the inside of any tires and we strongly encourage proper selection of compressor equipment, air-line routing, and the use of air dryers to avoid moisture in high pressure air used for inflation.

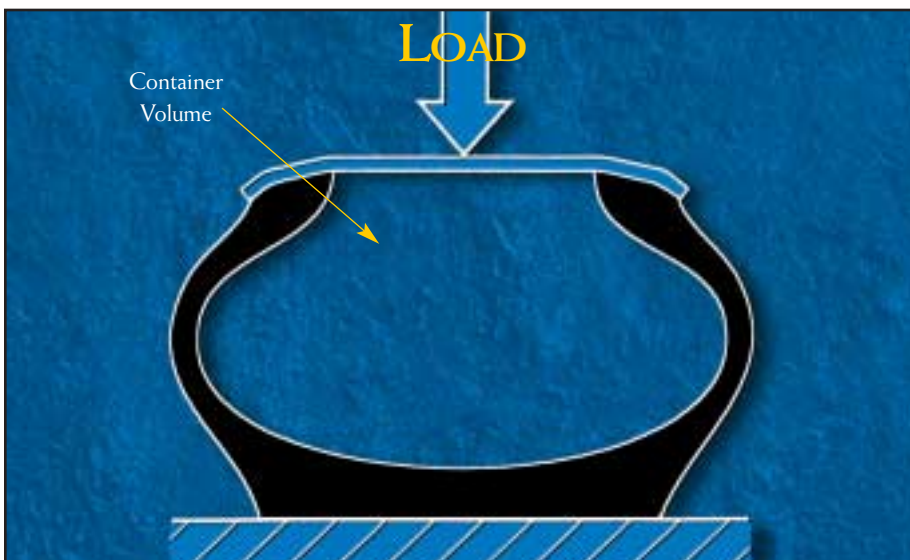

Figure 5.1

Table 3

### TABLE 3 TRUCK-BUS TIRES

The service load and minimum (cold) inflation must comply with the following limitations:

SPEED RANGE (MPH)	INFLATION PRESSURE INCREASE RADIAL PLY TIRES				LOAD CHANGES WITH SPEED RADIAL PLY TIRES			
	CONVENTIONAL (STD. PROFILE)		WIDEBASE/METRIC (LOW PROFILE)		CONVENTIONAL		WIDE BASE/METRIC	
	65 MPH	75 MPH	65 MPH	75 MPH	65 MPH	75 MPH	65 MPH	75 MPH
71 thru 75	+ 5 PSI	None	+ 5 PSI	None	- 12%	None	- 12%	None
66 thru 70	+ 5 PSI	None	+ 5 PSI	None	- 4%	None	- 4%	None
51 thru 65	None	None	None	None	None	None	None	None
41 thru 50	None	None	None	None	+ 9%	+ 9%	+ 7%	+ 7%
31 thru 40	None	None	None	None	+ 16%	+ 16%	+ 9%	+ 9%
21 thru 30	+ 10 PSI	+ 10 PSI	+ 10 PSI	+ 10 PSI	+ 24%	+ 24%	+ 12%	+ 12%
11 thru 20	+ 15 PSI	+ 15 PSI	+ 15 PSI	+ 15 PSI	+ 32%	+ 32%	+ 17%	+ 17%
6 thru 10 <sup>1)</sup>	+ 30 PSI	+ 30 PSI	+ 20 PSI	+ 20 PSI	+ 60%	+ 60%	+ 25%	+ 25%
2.6 thru 5 <sup>1)</sup>	+ 30 PSI	+ 30 PSI	+ 20 PSI	+ 20 PSI	+ 85%	+ 85%	+ 45%	+ 45%
Creep thru 2.5 <sup>1)2)</sup>	+ 30 PSI	+ 30 PSI	+ 20 PSI	+ 20 PSI	+ 115%	+ 115%	+ 55%	+ 55%
Creep	+ 40 PSI	+ 40 PSI	+ 30 PSI	+ 30 PSI	+ 140%	+ 140%	+ 75%	+ 75%
Stationary <sup>1)</sup>	+ 40 PSI	+ 40 PSI	+ 30 PSI	+ 30 PSI	+ 185%	+ 185%	+ 105%	+ 105%

1) On conventional tires apply load increase to dual loads and inflations only, even if tire is in single application. 2) Creep—motion for not over 200 feet in a 30 minute period.

Source: The Tire & Rim Association Yearbook



A tire's cold inflation pressure will change with altitude and temperature. The air pressure gauge reads the difference between the tire's contained air pressure and atmospheric pressure. Atmospheric pressure changes 0.48 psi for every 1000 feet change in altitude. Assuming constant temperature and internal tire volume, if a tire pressure gauge reads 100 psi at sea level, for every 1000 feet increase in altitude, the gauge will read 0.5 psi higher inflation pressure, see Figure 5.2.

Since this difference is small, the effect of altitude change on tire inflation, in general, is not considered to be significant.

Ambient temperature effects on a tire's cold inflation pressure, on the other hand, is significant. Using as an example a tire with an initial inflation pressure of 100 psi at 60 degree F ambient temperature, for each 10 degree F change in temperature, there is about a 2 psi change in the tire's inflation pressure, see Figure 5.3.

The inflation pressure reading at 0 degree F might happen when the truck is parked on a cold winter night. It will increase rapidly, though, once the truck begins to run and the tires warm up. At the other extreme of ambient temperatures, for example during the summer, it is common to find tire inflation pressures in the 115 to 120 psi range. We always caution operators not to bleed air pressure down on cold tires when they are at these higher ambient temperature conditions. Always inflate tires cold to the required pressure no matter what the ambient temperature is.

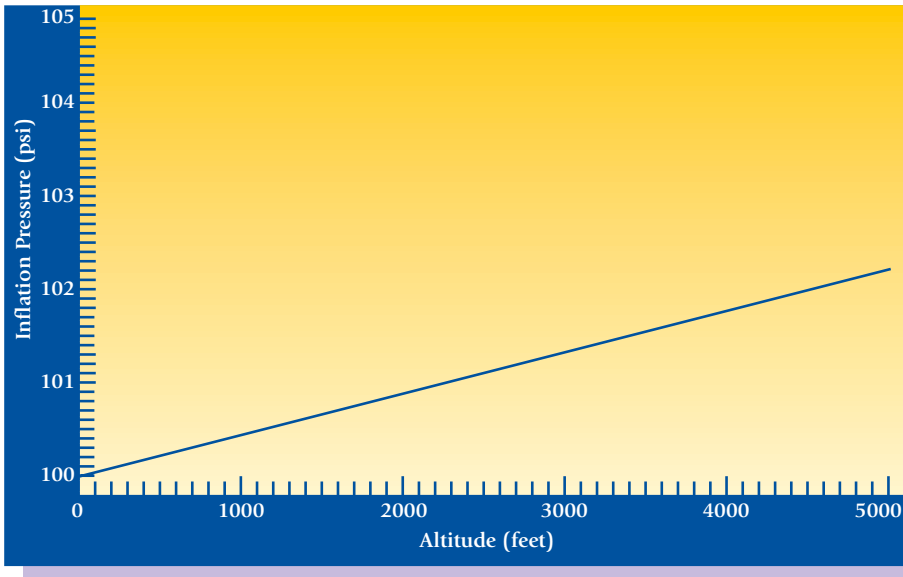

Figure 5.2

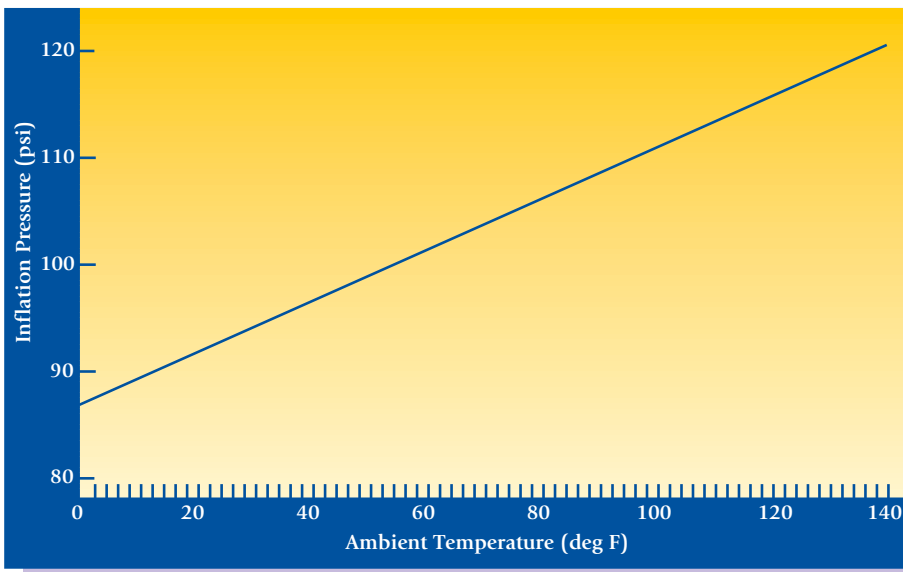

Figure 5.3

## UNDERINFLATION

Underinflation can have detrimental effects on the performance of your tires and vehicles. Increased tire wear rate, irregular treadwear, reduced casing durability and lower fuel economy are some of the unnecessary costs incurred from tires not properly inflated.

Running on underinflated tires costs you in lost tread life and higher fuel consumption. Tests conducted by Goodyear have shown that just 15 percent underinflation of steer, drive and trailer tires results in about an 8 percent drop in expected tread mileage and a 2.5 percent decrease in miles per gallon, Figure 5.4.

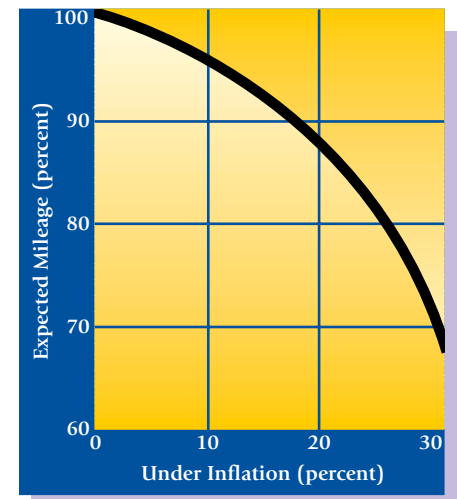

Figure 5.4

The damage doesn't end there. With the capabilities of today's truck tires, underinflation is also detrimental to your tires' potential for multiple retreads as well as sustained operation in today's service conditions.

Underinflation can cause casing damage and thus diminish the tire's ability as an "air container." This is of special concern since today's radial tires are capable of running much longer than the life of their original treads.

#### No spare aboard

Add to this fact that many fleets don't carry spare tires anymore. Although fleet inflation pressure maintenance has improved over the years, sometime over their working life, today's truck tires are still likely to run underinflated or flat. Continued running this way can °seriously damage the casings.

Sidewall flexing increases noticeably when a tire's inflation drops 15 to 20 percent below recommended. Excessive flexing can result in cord fatigue and broken cords, and cords adjacent to these are subjected to greater tension when the tire is reinflated. The potential for a sidewall rupture then becomes very great.

Excessive heat does often cause the liner to wrinkle and discolor, and the upper sidewall to visibly distort and discolor.

#### UNDERINFLATION CAN CAUSE:

- Separations
- Circumferential Breaks
- Higher Risk of Road Hazard
- Loss of Fuel Economy
- Uneven/Irregular Wear
- Higher Risk of Road Hazard
- Higher Downtime Expense
- Loss of Casing Durability

#### Check psi weekly

Paying close attention to inflation pressures and to tires that have run underinflated has never been more important, considering the potential for sidewall ruptures, the value of retreadable casings, and the cost of tire related downtime.

The tire industry recommends checking inflation pressures once each week on all tires. This check should be made with a calibrated tire gauge or a gauge that is checked periodically with a gauge known to be accurate.

Another valuable tip is to use a sealing metal or nylon valve cap or a quality "air-through" type cap. Plastic caps do not provide a secondary seal to the outdoor environment, and no cap at all allows dirt, water and other foreign materials into the valve. Their presence invites air leakage.

Carefully inspect any tires that have been repaired or now have cuts, snags or other penetrations. Scrap any that show definite signs of underinflation. Mark a tire that looks suspicious in any way and set it aside for a thorough inspection by a trained tire technician.

When inflating or reinflating tires, always use a tire safety cage. This holds true for both tube-type and tubeless tires. The past few years have seen a decline in the use of tire cages, because of the growing popularity of tubeless tires. Some consider the cage necessary only when inflating the complex assemblies of a tube-type tire and rim. We strongly recommend using a tire cage regardless of the wheel or rim type.

The evolution of the radial tire has made it a long wearing, durable component of today's trucks. We should keep in mind that "radial" is not synonymous with "indestructible", and that proper inflation is the primary key to preserving radial tires' outstanding qualities.

## DO'S AND DON'TS FOR MAINTAINING PROPER INFLATION PRESSURE

### DO

- Do maintain proper minimum inflation for load carried per the Goodyear recommended table
- Do maintain mated dual tires at equal inflation
- Do use sealing-type valve caps
- Do check inflation at frequent intervals
- Do keep inflation air dry

### DON'T

- Don't permit tires to operate underinflated
- Don't "bleed" air from warm tires to relieve pressure buildup
- Don't reduce tire pressure to obtain a softer ride
- Don't run with one tire of a dual assembly at low pressure or flat
- Don't inflate to cold pressures beyond rated rim capacity

## NITROGEN INFLATION

Over the years, nitrogen inflation has been proposed for various types of tires, including large earthmover tires down through small passenger tires. At the present time, Goodyear endorses nitrogen inflation for certain sizes of earthmover tires used in particular applications, and has issued detailed instructions for these tires. Anyone concerned with applying or maintaining earthmover tires should be aware of the Goodyear Service Department Bulletins and Off-the-Road Tire Training Manuals that contain details of nitrogen inflation recommendations for these large off-the-road tires.

The issue of nitrogen inflation for over-the-road truck tires is not quite so clear. Various performance improvements have been claimed, including better treadwear, casing durability, and reduced susceptibility to tire fires.

Although little actual controlled test data exists, a summary of Goodyear's experience with nitrogen inflation for truck tires is the basis for the following comments. Treadwear appears to be affected negligibly by the tire inflation medium. Specifically, there is little, if any, tread life change to be expected by using nitrogen inflation compared to normal air. So far as casing durability and retreadability are concerned, the primary criteria is to avoid moisture in whatever inflation medium is used. To this end, we strongly encourage proper selection of compressor equipment, air-line routing, the use of air dryers, and other good shop practices to avoid the introduction of moisture into high pressure air used for both initial tire inflation and make-up air. Again, we know of no significantly improved casing durability or retread durability performance to be expected from nitrogen inflation in over-the-road truck tires.

Reduced rim or wheel corrosion has also been cited as an advantage of nitrogen inflation. However, corrosion is primarily the result of excessive moisture introduced by air that has not been properly dried, rather than a direct result of air versus nitrogen inflation.

An additional concern is that past studies have shown that a very small percentage of non-nitrogen make-up inflation significantly contaminates the contained nitrogen atmosphere within a tire. In other words, if any benefits are to accrue from nitrogen inflation, it is essential that virtually all make-up inflation throughout the life of the tire/wheel assembly be diligently controlled to assure a near 100 percent nitrogen environment.

A final issue is that of insuring against tire fires and/or self-ignition of tires resulting from excessive heat. For truck tires, this concern has been greatly reduced in recent years, primarily because of the changes from bias to radial tires and from tube-type to tubeless tires. The tubeless radial tire is simply much less susceptible to a tire fire than a bias tube-type design. This is partly because of the simplicity of the tubeless design (i.e. no separate tube and flap to create heat from rubbing or internal friction when the assembly deflates or runs severely underinflated or overloaded), and partly because steel radial truck tires require higher temperatures for a fire to start than their fabric-reinforced bias-ply counterparts.

In summary, nitrogen inflation appears to have significant advantages for certain sizes and applications of large off-road tires, especially those operating in extremely high load or speed environments. However, nitrogen inflation appears to have quite small, perhaps insignificant, advantages for over-the-road truck tires.



# Total Vehicle Alignment

Vehicle alignment settings serve several purposes in vehicle operation. They affect handling, steerability, stability and have a significant impact on tire performance.

Camber settings are not considered adjustable in the field.

NEVER ATTEMPT TO ADJUST  
THESE SETTINGS BY BENDING  
OR MODIFYING AXLE/STEERING  
MECHANISM COMPONENTS.

The long treadwear potential offered by modern radial linehaul truck tires can be reduced by the misalignment of tractor and/or trailer wheels and axles. Extensive research has demonstrated that total vehicle alignment programs can pay dividends in extended tire wear and improved fuel economy.

There has been increased attention to proper truck alignment procedures during the past few years, and for good reason. Current radial steer axle tires provide a much slower rate of wear than earlier generation radial or bias ply tires. This also means that they may reflect the adverse effects of improper alignment that was unseen on faster wearing tires.

Opinions on proper alignment for radial tires often seem as varied as the number of authorities giving them. For this reason, Goodyear has been actively involved in working toward industry wide agreement to define the effects of improper alignment on tire wear, durability and vehicle handling, and to establish recommended alignment settings.

Much of this work is being directed through industry associations including The Maintenance Council of American Trucking Association, The Society of Automotive Engineers and with individual OEM truck, axle and suspension manufacturers.

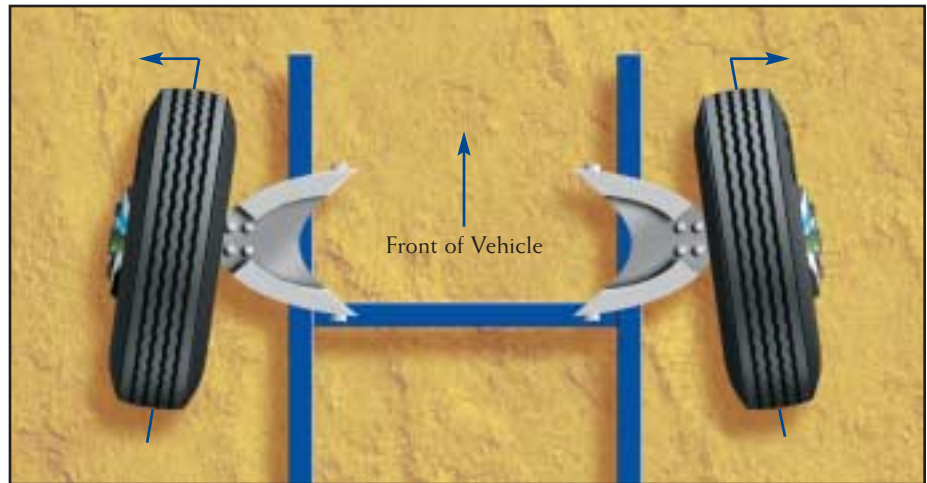

Figure 6.1 Toe-in

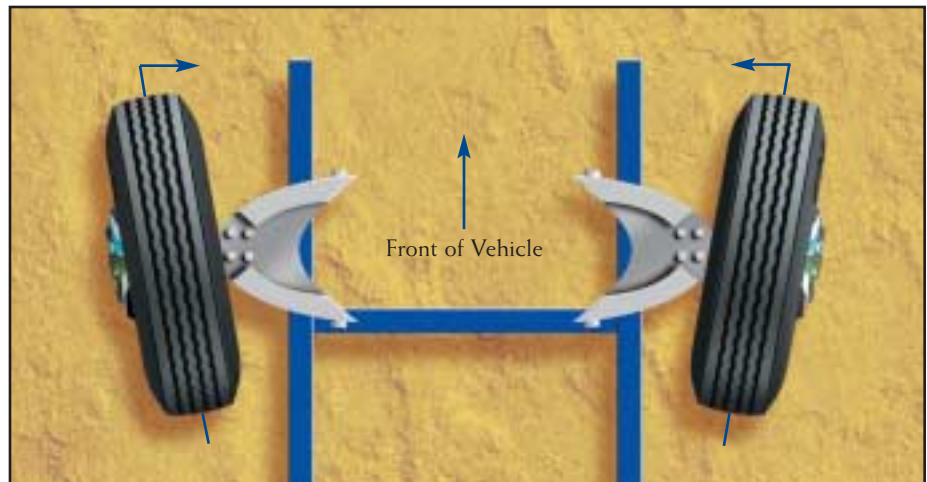

Figure 6.2 Toe-out



Figure 6.3 Positive camber



Figure 6.4 Negative camber



In particular, certain truck and axle manufacturers have responded to the requirements for more precise alignment settings. These OEM's do not recommend delivery realignment of their vehicles at the dealer level.

Specific irregular wear patterns and their causes are discussed in detail in the "Irregular Wear" section of this service manual.

Years ago, alignment meant simply a "front-end job". But the steer axle is only the beginning of the total alignment story in the radial age.

We now know that proper attention to drive axles, trailer axles and dolly axles completes the picture. Not only does alignment affect tire wear, but the amount of fuel used by a truck/trailer combination as well. (See Section 9 for additional details).

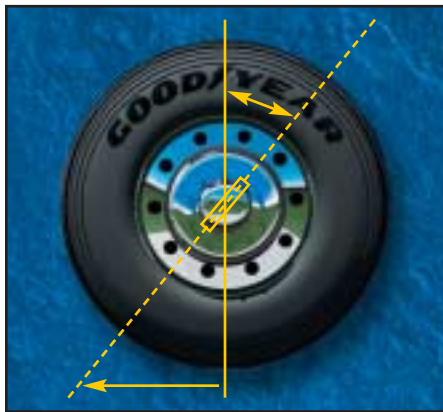

Figure 6.5 Caster

## STEER AXLE ALIGNMENT

The major front-end alignment settings involve:

### Toe:

Toe is defined as the difference in distance apart, at the front and at the rear, of the steering-axle tires as seen in a top view of the truck. Toe-in exists when the tires are closer together in the front than in the rear **Figure 6.1** and excessive toe-in results in feather wear in the direction shown by the arrows. Toe-out exists when the tires are closer together in the rear than in the front **Figure 6.2** and excessive toe out results in the feather wear in the direction shown by the arrows.

### Camber:

Camber is the tilt of the tires as seen in a front view of the truck. Positive camber exists when the tires are closer together at the bottom (point of road contact) **Figure 6.3**. Negative camber exists when the tires are closer together at the top **Figure 6.4**.

### Caster:

Positive caster is provided by a backward (rotational) tilt of the top of the axle or backward inclination of the kingpin at the top as seen in a side view of the truck **Figure 6.5**. Negative caster would be a corresponding tilt forward at the top.

Before any alignment adjustment is performed, always check the vehicle for loose kingpins, worn wheel bearings, tie rod ends, or any looseness in the steering system. Adjust wheel bearing end play in accordance with the recommendations of the OE manufacturer. Attempts to correct alignment on a vehicle with worn or loose components are pointless.

## LOADED VS UNLOADED ALIGNMENT SETTINGS

Alignment changes as load changes, especially steer axle camber, caster and toe. Since springs, axles and suspension mountings vary by truck and components with different weight ratings are often chosen, different unloaded truck alignment settings may be required to obtain optimum loaded truck alignments.

On steer axles, toe and camber settings are related and should be considered together for optimum tire life, especially in line-haul service where treadwear rates are slow. Positive camber (refer to illustration) creates a slightly shorter rolling radius on the outside shoulder of a radial tire than on the inside shoulder. This creates a tendency for the tire to roll toward the outside—a toe-out condition. Since all the working tolerances in the tie-rod ends and kingpins must be taken up before the tendency to toe-out is restrained, an initial static toe-in setting is essential.

### NOTE

Alignment recommendations may need to be "customized" for certain vehicle/tire/service conditions.



## TOE

Toe settings generally have the greatest effect on truck tire treadwear. Toe is also the easiest front-end alignment variable to adjust in the shop.

Road tests were made using three trucks with different amounts of loaded truck toe-in (1/32-inch, 1/8-inch and 1/4-inch) with radial tires on the steering axles.

The test results showed:

- Tire tread mileage decreases with increased toe-in. The 1/32-inch toe-in showed the best treadwear rate (miles per 32nd of tread depth).
- Assigning a value of 100 to the treadwear rate with 1/32-inch toe-in, the treadwear rate values compared as follows:

Loaded Toe-in Value (Inches)	Comparative Treadwear Rates
1/32	100
1/8	82
1/4	76

In addition to wear, drivers' reactions to the toe-in settings, without power steering indicated that the 1/4-inch toe-in caused the truck to "roadwalk" badly. The 1/32-inch value was considered to have the best handling.

Tire wear due to excessive toe-in on radial tires shows up initially as irregular wear — more so on the outside than the inside grooves of the tires and more so on the right-front than on the left-front tire. Excessive toe-out will show a reversed effect: more wear on the inside than the outside grooves and more so on the left-front than the right-front tire.

At high values of toe-in or toe-out and at relatively early mileage, the tread of the outside or inside ribs can be completely worn away. For 5/16-inch toe-in condition this can occur after only 19,000 miles of highway travel.

Gauges for measuring toe-in setting are relatively simple and inexpensive. Every maintenance shop should use them frequently. It is not necessary to send a truck to an alignment shop to check toe-in settings.

Setting toe alone is usually not sufficient. A total vehicle alignment (toe and axle) is recommended per TMC RP642.

## CAMBER

After years of recommending camber settings of +1/4 degree for left front and 0 degrees for right front, major axle manufacturers have changed to 0 degree settings for both left and right steer axle positions on axles designed for line haul service.

The objective of this change is to optimize steer tire wear and minimize or eliminate irregular wear. Theoretically, these new settings will result in steer tires running straight down the road in a 0 toe/0 camber mode. Goodyear Proving Ground tests and independent field tests support this theory.

Tires with excessive camber will wear as shown in **Figure 6.6**. It can be seen that improper camber causes wear on one side of the tire, this can be on the inside or outside of the tire depending on camber setting and tire position (LF or RF).

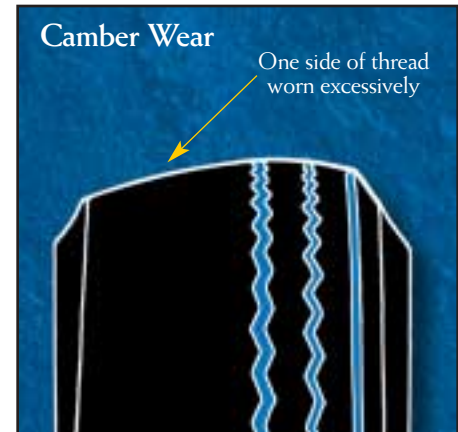

Figure 6.6

## CASTER

Generally, caster is not considered to affect tire wear, but is important in the handling and driveability of the vehicle.

Overall effects of caster can be summarized as follows:

—Too little caster causes:

- Unstable steering
- Constant corrections required
- Wander and weave
- Oversteer
- Failure to return to straight ahead out of a turn
- Roadwalk

—Too much caster causes:

- Hard steering
- Shimmy
- Road shock

Vehicle manufacturers normally recommend caster settings for their vehicles. Proper caster is that which gives best handling in combination with the camber and king pin inclination designed into the axle.

### ACKERMANN STEERING EFFECT ON TIRE WEAR

There are many variables to check when determining the source of irregular tire wear patterns. One potential cause for irregular wear on steer tires may be a truck's "Ackermann" characteristic.

The Ackermann Principle states that for any given corner, the outside wheel should have less turn angle than the inside one, because it is following a larger radius than the inside wheel **Figure 6.7**.

This difference in wheel turning angles is determined by the length and angle of the steering arms that are attached to the hubs of the steer axle.

The theoretical Ackermann angle for a particular vehicle is determined by drawing a line through the pivoting axis

(which is the rear axle of a two-axle vehicle) to establish a pivot point for a turn, then drawing lines to the pivot points of the two steer tires. The Ackermann, then, is the angle the tires/wheels needed to be turned to form a right angle with each of the lines extending from the turning pivot point to the tire/wheel pivots. This results in the steer tires "toeing out" when turning. A vehicle's wheelbase is the most critical variable affecting the "theoretical Ackermann" for a vehicle.

Keep in mind that Ackermann is a purely geometric concept. The argument that the Ackermann Principle was developed in the early 1900's for very slow-moving vehicles and does not

consider the dynamic effect of many outside influences on the path a vehicle takes through a turn is somewhat correct.

To further complicate the Ackermann Principle as it applies to trucks, remember that the turning axis must be drawn to determine a pivoting point about which the vehicle turns. It's more difficult to define this axis for vehicles with more than one drive axle. Fifth wheels, depending on their location, can also alter where this line would fall.

The trend is for vehicle manufacturers to provide different Ackermann arms for different wheel bases and different fleet vocations.

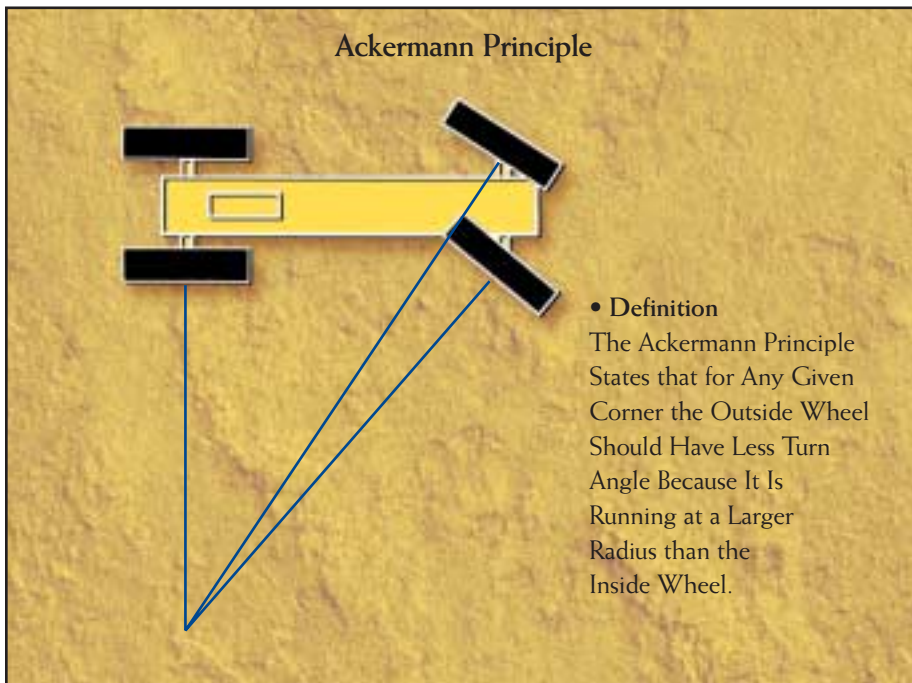

Figure 6.7

## DRIVE AXLE ALIGNMENT

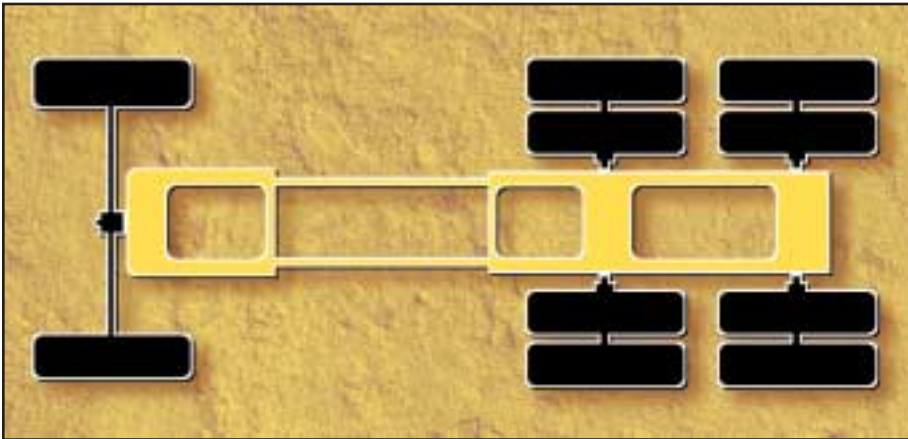

Figure 6.8

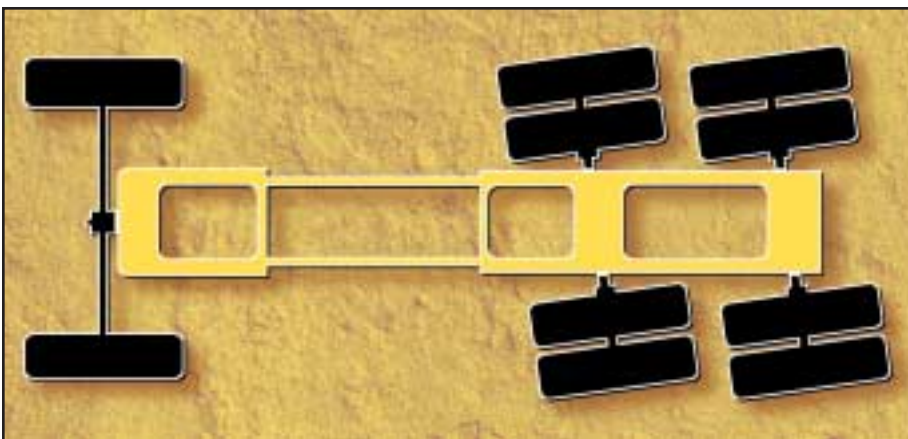

Figure 6.9

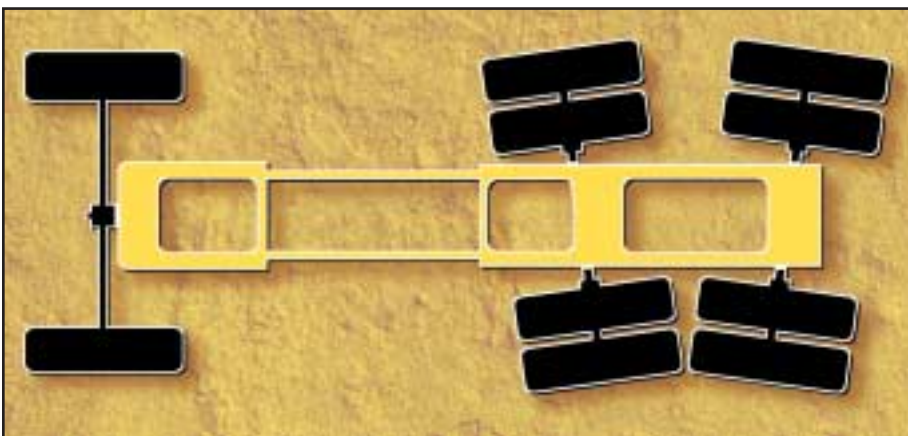

Figure 6.10

Drive axle alignment is very important. Tandem drive axles that are not parallel to each other have a definite effect on steer-tire wear.

Figure 6.8 shows a model of a tandem-drive-axle tractor with both drive axles in proper alignment. In this case, the driver simply steers the truck straight ahead and neither fast wear nor irregular wear would be expected as a result of the driving axles.

However, Figure 6.9 is an exaggerated view of a truck with drive axles parallel, but not perpendicular, to the chassis centerline. The eight driving tires create a "thrust angle" to the left at the rear of the truck. Turning the steering wheel slightly to the left aligns the steer and drive tires to run parallel, but the vehicle however will "dog track." Even though lateral forces on the steer tires are minimal, the steering geometry is affected, which may result in asymmetrical steer tire wear.

A more severe case is shown in Figure 6.10. Here the drive axles are neither parallel to each other nor perpendicular to the chassis centerline. The drive-axle tires are trying to force the vehicle to turn left and the driver must compensate by turning to the right. This will result in fast and irregular wear and, as recent tests have shown, in a much more severe way than the previous case. These tests also indicated that the steer tire on the same side of the truck on which the drive tires are closest together will wear into an out-of-round condition as well.

Recommendations for drive-axle alignment are as follows:

- Tandem axles should be parallel within 1/8-inch difference between the axles centers measured on the left and the right side of the vehicle. **Figure 6.11**
- Axles should be perpendicular to the chassis centerline within 1/8-inch measured between axle end and vehicle centerline. **Figure 6.12**



### TRAILER AXLE ALIGNMENT

With more long-wearing radial tires being applied to trailer axles, their alignment has become an important issue. Trailer-axle tires have the potential for longer life (more miles per thirty-second inch of treadwear) than any of the tires on the tractor. They are, therefore, more susceptible to irregular wear due to misalignment than any other tires on the vehicle.

Goodyear's recommendations for trailer alignment are as follows:

- Preferred toe setting:  
1/32-inch toe-in to 1/32-inch toe-out, or  $\pm 2.7$  minutes per spindle.
- Acceptable toe setting:  
1/16-inch toe-in to 1/16-inch toe-out, or  $\pm 5.4$  minutes per spindle.

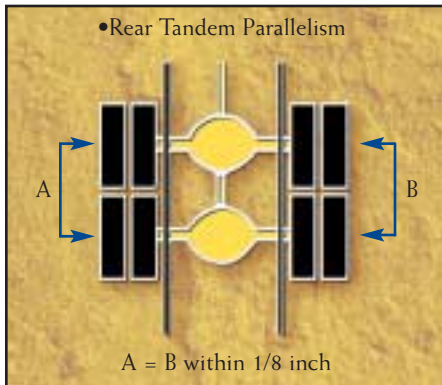

Figure 6.11

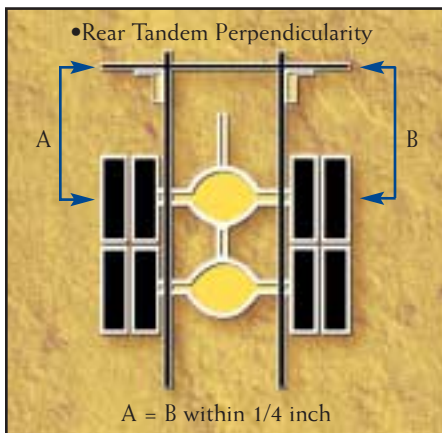

Figure 6.12

The loaded axle camber can be up to negative  $1^\circ$  without affecting tire wear.

Axes should be parallel to each other within 1/8-inch measured between axes on both sides of the trailer at a 71.5-inch axle track. This provides a scrub angle of  $\pm 0.1^\circ$ .

Axes should be perpendicular to the centerline of the trailer frame within 1/8-inch per side or 1/4-inch from side to side at a 71.5-inch axle track. This provides a thrust angle of  $\pm 0.2^\circ$ .

### IN-SERVICE ALIGNMENT RECOMMENDATIONS

Toe-in is recognized throughout the industry as the most important contributor to optimizing steer tire treadwear. In order of priority, gains in tread life can be expected by focusing on the following vehicle alignment parameters:

- TOE
- REAR TANDEM PARALLELISM
- CAMBER (NON-ADJUSTABLE)
- REAR TANDEM PERPENDICULARITY
- CASTER

Most vehicle manufacturers, in recent years, have developed new factory equipment and procedures to control alignment to much narrower tolerances than was previously possible. Today there is less need to adjust alignment on new vehicles than in the past.

Alignment accuracy and repeatability can best be achieved by proper training, adherence to strict procedures and by properly maintaining and frequently calibrating alignment equipment.

**THE VEHICLE MANUFACTURER'S ALIGNMENT SPECIFICATIONS SHOULD BE ADHERED TO.**

The following guidelines have proved to be beneficial for improving overall tire treadwear:

#### STEER AXLES

TOE IN (unloaded):

Check Limits\*  $1/16'' \pm 1/16''$   
(Range 0-1/8'')

Reset Limits  $1/16'' \pm 1/32''$

\*When alignments are found within these limits, adjustment is not necessary. If outside of check limits, set to the reset limits.

#### DRIVE AXLES

Tandem axles to be parallel within 1/8" measured at axle end.

Axes to be perpendicular to chassis centerline within 1/8" when measured from axle end to chassis centerline, or within 1/4" when measured from left to right axle end.

#### TRAILER AXLES

Tandem axles to be parallel within 1/8" measured at axle end.

Axes to be perpendicular to chassis centerline within 1/8" when measured from axle end to chassis centerline, or within 1/4" when measured from left to right axle end.

Nominal toe setting:

$0'' \pm 1/32''$

Reference TMC Recommended Practice RP642 regarding total vehicle alignment for more detailed information.

# Factors Affecting Treadwear

Alignment problems are often blamed for all irregular treadwear. However, many other factors can be responsible for, or contribute to, irregular wear. While the wear pattern can often suggest the cause of the problem, it sometimes takes real detective work to track down and correct the real source of trouble.





The issue of irregular tire wear has always been a concern even in the days when most trucks ran bias ply tires. With today's longer wearing radial tires, irregular wear has surfaced as the primary concern of most truck maintenance managers. In fact, it is the ability of today's advanced radial tires to deliver long original tread life which requires even more attention to good maintenance practices and vehicle alignment.

Radial tires have a different footprint shape than bias tires. See Figure 7.1. This results in less scrubbing and longer tread life. However, this same attribute of the radial design can also result in the tire exhibiting more irregular wear when vehicle and tire maintenance are below par. These wear patterns are not as evident

in bias ply tires. Since the tread wears away usually much faster on bias tires, unusual wear patterns are literally scrubbed off as they develop.

The Technology & Maintenance Council (TMC) of the American Trucking Association has publicly said that the positive attributes of the radial tire, particularly longer tread life, can result in the tire exhibiting more irregular wear patterns when vehicle and tire maintenance or tire construction is inadequate.

The TMC has also published an excellent reference guide titled *Radial Tire Conditions Analysis Guide*. This booklet clearly defines the types of irregular wear common to steer, drive, and trailer axles and offers possible reasons that such wear occurs. Figure 7.2.

Contact The Technology & Maintenance Council at <http://tmc.truckline.com> or order publications through The ATA Marketplace: 1-800-282-5463.

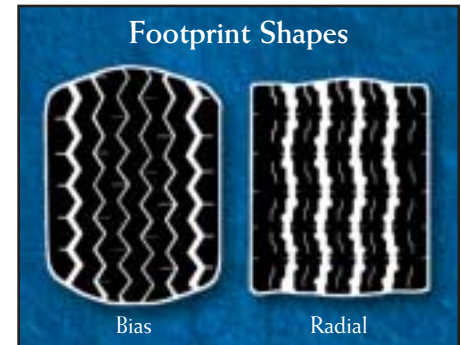

Figure 7.1 A bias tire footprint is oval shaped... the radial footprint is rectangular.



Figure 7.2 *Radial Tire Conditions Analysis Guide* — an excellent reference book.



## STEER TIRE WEAR

Uneven or irregular tire wear is a widespread problem in today's trucking industry. All brands of rib tires have experienced this undesirable situation.

Extensive testing has proven that vehicles with lightly loaded front axles are more prone to irregular steer tire wear than those with heavily loaded front ends **Figure 7.3**. By lightly loaded, we're talking about a front axle configuration of 10,000 to 10,500 pounds or less for the typical linehaul-sized tires. We also know that tractors with wheelbases more than 200 to 210 inches long are also candidates for irregular steer tire wear.

Several factors help determine steer tire load. These include vehicle configuration, wheelbase, axle set-back and fifth wheel position. How this load contacts the road surface is then influenced by alignment settings. Vehicle toe, camber, caster, drive axle parallelism and perpendicularity are important factors in steer tire wear patterns.

All things considered, how a tire tread wears depends on the forces that act upon the contact patch of that tire as it meets the road.

If a tire is highly loaded, it tends to have a square footprint shape. The shoulder rib contact area is very long, about the same length as the center ribs. As the tire rotates, contact with the road is good.

By contrast, a lightly loaded tire tends to have very short shoulder ribs, much shorter than the center rib. As this tire rotates, the footprint center maintains very good contact but the shoulder area does not. This causes much more scrubbing action and wearing away of the shoulder rib.

Vehicle misalignment, non-parallel or non-perpendicular drive axles and suspension system problems naturally affect steer tire wear.

While many fleet owners and maintenance personnel believe they have heavily loaded steer axle applications, they're running with loads in the 10,000 to 10,500 pound range and below. Heavy GVW doesn't equate with heavy front axle load.

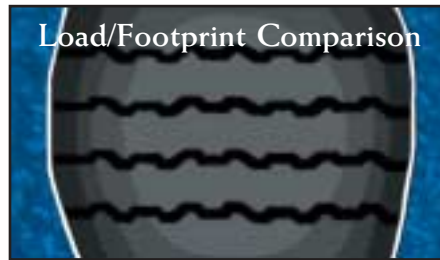

Figure 7.3

Tire inflation also plays a role in tire wear. Once loading is determined, you must run your tires at the proper inflation to match loading. Your tire company representative should help you determine optimum inflation for that configuration.

A good rule of thumb — inflate to the T & RA recommended pressure required for the load plus 10 psi. This will compensate for tire-to-tire variations and normal leakage.

Periodic inspections of your vehicle and tires are a must. Look for signs of irregular wear or vehicle component problems. Then take immediate action to correct these problems.

And finally, work very closely with your tire company representative to determine the right tire for the application. A tire designed for highway use, for example, may not be the best choice for running off-road. Tires, like trucks, are built to do specific jobs. Defining that mission is a good first step.

### KEY IRREGULAR WEAR CONDITIONS DEFINED

**Chamfer wear** — A nibbling or erosion that occurs on the outside edge of the shoulder ribs of a tire. This condition typically results from slow rate of wear line-haul service and does not indicate a tire or vehicle problem.

**Erosion or river wear** — A nibbling effect at the edge of the interior ribs of a tread design. It's most often seen on very slow wearing tires in line-haul steer applications.

**Fast rib wear** — One or more of the interior ribs of a tire wear away much more rapidly than the adjacent ribs. Tire construction, itself, may be the cause.

**Diagonal wear** — Rapid wearing away of a diagonal patch of the tread design. Causes are generally non-tire related. Probable suspects include mismounting a tire on the wheel, brake or bearing problems. Diagonal tire wear is not caused by a heavy splice or component ending in a tire.

**Fast shoulder wear** — Rapid wearing away of one or both tire shoulders on steer axle position. The problem shows up as smooth rapid wear or a scalloped "island wear" configuration as the tire runs.

## SETBACK STEER AXLES

Though increasingly popular today, "setback" steer axles are not new to the trucking industry. For many years, "setback" front axles have been used in on/off road applications in construction, oil field, waste hauling and specialized services.

The primary benefits of "setback" steer axles are improved maneuverability, more desirable load distribution and, in many cases, improved ride. The application of "setbacks" to over-the-road linehaul type trucks, however, is fairly recent.

The term "setback" is relative, and some designs are more setback than others. Generally, the axle of a modern "setback" linehaul tractor is positioned about 13 to 15 inches behind its traditional position. This design is typically found on long conventional and medium conventional cab models.

More pronounced "super setbacks" are usually found on COE models where the axle is positioned about 25 inches behind its normal position. Collectively, all trucks with "setback" axles can be expected to present distinct characteristics which can affect tire selection and usage patterns. These include shorter wheelbases, higher steer tire loads, higher wheel cut angles.

While these characteristics are "setback" steer axle benefits, there are others that can adversely affect tire wear.

### Steer tire inflation pressures

As a general rule, irregular wear tendencies are more of a problem on trucks with lightly loaded steer axles. This is especially true of trucks pulling heavy loads where high drawbar force on the kingpin tends to unload the steer axle when the truck is rolling. Rearward positioned fifth wheels offer further opportunities to reduce steer axle loads.

"Setback" axle trucks tend to have heavier steer tire loading both statically and dynamically. This is because most of them also employ extensive aerodynamic packages that restrict fifth wheel placement flexibility. In fact, some "super setback" designs can have nearly identical steer tire loadings from bobtail to fully loaded condition.

Tires on the "super setbacks" must work harder, and in some cases, require higher inflation pressures to support the increased loads. Load/inflation pressure tables are available from [www.goodyear.com/truck](http://www.goodyear.com/truck), Engineering Data Book or Over-the-Road Truck Tires, or a qualified tire company representative.

If higher steer tire pressures are required, this may mean you'll be using different inflation pressures for drive and trail tires.

### Increased lateral tire scrub

As the wheelbase dimension shortens, steer tires must generate an increasing amount of side force to turn the truck chassis when cornering. This is especially true for tandem drive axle units. As an example, compare a tractor with a 140-inch wheelbase with one whose wheelbase is 230 inches **Figure 7.4**. Steer tires on the shorter vehicle must generate 65 percent more cornering force to slide the tandems around a

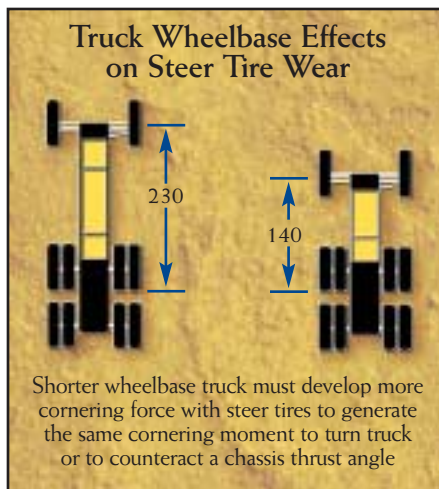

Figure 7.4

corner. The normal result will be faster overall steer tire wear rates than experienced by the longer wheelbase unit. Another result will be less irregular wear because the extra scrubbing tends to clean up uneven wear patterns as they develop. You'll also find tires with wider treads or more massive tread rib designs will usually perform better on the shorter wheelbase vehicles.

### Loaded vs. unloaded alignment angles

Differences in payload can also affect steer tire loading differently, depending on fifth wheel location, suspension type and degree of axle setback. Therefore, you can't continue to assume traditional changes in toe, camber and caster from bobtail condition (typical when checking alignment) to fully loaded. In fact, certain "setback" axle designs have shown no camber change.

Toe change, on the other hand, can range from no change to a decrease, or, in some cases, to an increase with additional load. Caster change may also be different from model to model, since most "setback" axle designs also employ springs that are longer or have different deflection characteristics.

### Ackermann steering geometry

While Ackermann geometry has not typically been a major problem on linehaul type vehicles, it should now be considered because most "setback" axle designs also incorporate increased wheel cut angles. The industry standard for many years has been in the 32- to 34-degree range. Now typically in new designs are wheel cuts of 42 to 44 degrees, meaning steer tires are likely to be scrubbed more severely when turning. As a result, the effects of improper or compromised Ackermann geometry will be more pronounced.

### Suspension damping control

Damping control has also become more important, since many "setback" axle designs employ softer riding suspensions. The older stacked spring designs had considerable leaf-to-leaf friction, which tended to act as a built-in shock absorber. This damping also varied with loading.

Now, depending on the specific suspension, damping control can become critical. Shock absorbers should be properly sized, maintained and replaced when necessary to control suspension movement, which, in turn, leads to tire wear irregularities.

## DRIVE TIRES

Let's review some of the key elements that impact drive tire wear:

### Engine Torque (More usable torque means less tread life)

Engine torque is measured in foot-pounds of twisting force without regard to time. Peak torque on many of today's engines occurs at lower engine rpms and remains at a relatively high level over a wide rpm range. A typical engine might develop 1,200 to 1,250 foot-pounds of peak torque at only 1,300 rpms.

High engine torque over a wide rpm range adversely affects drive tires, which transmit this higher torque to the highway. Increased stress, deflection, deformation and reduced tread life result.

### Highway Speeds (Faster speeds mean less tread life)

Linehaul tractor trailers are now permitted to travel at 65 mph in rural areas in place of 55 mph in 71 percent of the states. At 65 mph, that means a 16-percent tread life penalty, according to one study. Experts cite as causes increased tire footprint deformation and higher tire running temperatures.

### Inexperienced Drivers (Tread life can suffer)

High turnover means truckload and irregular route drivers are less experienced than in the past. Driver turnover surpasses 100 percent annually in some fleets. Inexperienced drivers can abuse their vehicles with rough gear shifting, spinning wheels on wet surfaces and fast accelerating and braking.

### Setback Steer Axles (Affect drive tire wear)

Setback steer axles were engineered to improve vehicle comfort, load distribution and vehicle maneuverability. A tractor's wheelbase is shorter when its steer axle is placed 13 to 15 inches behind the usual position (or up to 25 inches in the case of super setback axles). Shorter wheelbases mean greater wheel cut angles, from the normal 30 degrees up to 42 inches in some cases. Smaller turning radii are the result of higher cut angles.



But tighter turns equate to higher cornering forces in the drive tire footprint and reduced tread life. Depending on the percentage of straight-ahead highway driving, these forces can also cause rear tandems to wear much faster than forward tandems.

### Rear Suspensions (Service/maintenance sensitive)

Good suspension and shock maintenance is critical to obtain long tread life and uniform wear. Inadequate care can cause uncontrolled jounce and rebound, and over long time periods, irregular drive tire wear as well.

Empty backhauls can aggravate the problem. Lightly loaded trucks with leaf spring suspensions and deep tread tires can develop a cyclic bouncing process, particularly on rutted or deteriorating highways and highly crowned roads. Significant tread life losses and various degrees of irregular wear can result.

Extreme variations in air pressures of dual wheel assemblies is another major cause of reduced tread life and also of irregular drive tire treadwear. Fleets that don't control air pressures of duals in effect allow the tire with lower air pressure to overdeflect, deform, scrub excessively and non-uniformly and eventually develop irregular drive tire wear.

Here are some tips to obtaining desirable drive tire tread life with minimum irregular wear:

- Recognize the effect of vehicles, service and operating conditions on drive tire tread life.
- Train drivers in proper operating techniques.
- Exercise speed control.
- Maintain rear axle/tandem alignment.
- Balance air pressure between duals.



Suspension systems are changing. Early trucks were stiffly sprung with suspensions similar to horse-drawn buggies. Today, the demand is for a softer ride. Better driver and passenger comfort is one reason. Another is a need to protect delicate cargo such as electronic equipment and computers. For these and other reasons, air suspensions are becoming more popular.

There are two basic suspension systems. A taper leaf is used primarily on steer axles and trailer axles. Air suspensions are used mainly on drive axles and trailer axles, but are now being introduced on steer axles. Besides a softer ride, air suspensions provide full suspension movement regardless of load condition and the ability to equalize the load between axles. Radial tires work best when in firm contact with the road surface.

Suspension systems are a combination of springs and dampers (shock absorbers). Older, multiple-leaf spring suspensions had so much leaf-to-leaf friction that they were virtually self-damping **Figure 7.5**. Today's taper-leaf systems, with fewer leaves and space between leaves, produce little self-damping. In fact, a low friction material often is placed between the leaves to reduce damping. Air bags also lack self-damping.

Placement of shocks in the suspension system can help or hinder their effectiveness. Consider, for example, shocks mounted near the center of the frame. Bump inputs to both the right and left sides of the axle – such as road expansion joints – are properly damped. But a bump input to one side or the other results in the axle rotating about its center. There is little shock compression or extension and little damping of axle movement.

Fluid leaks around the shock's piston rod are a sign that shocks should be replaced. Replace a shock absorber if one end is disconnected or if the shock can be easily compressed and extended.



Figure 7.5 Taper-Leaf springs produce little self-damping.

Temperature is another way to check shock effectiveness. After a truck returns from a highway run, a mechanic should touch the shock absorber. A warm shock is working, a cold shock is not.

With air suspensions, shock absorbers are also considered the "stops" at the extended end of the suspension travel.

Present and future trucks will have softer, more compliant suspensions that provide many advantages over older systems. Proper maintenance of these suspensions will assure the benefits of these systems are realized without a negative impact on tire life.

Vehicles should be spec'd considering ride and tirewear. Frequent suspension system maintenance assures maximum treadwear and tire life.

### SHOCK ABSORBERS — 3 CONSIDERATIONS

- **Selection.** For maximum effectiveness, select the right shock absorber for the job. Consult with a manufacturer's representative to make the proper choice.
- **Placement.** Proper placement of shock absorbers in a suspension system ensures optimum shock compression or extension and axle movement damping.
- **Maintenance.** Regularly check shock absorbers to make sure they are performing adequately. Replace shocks when they are worn.

## BEARING ADJUSTMENT

Ask five different fleet maintenance managers about how wheel bearing adjustments affect alignment settings and you're likely to get five different answers. They'll likely agree that axle end play is a tire wear concern but the reasons why may not be fully understood.

Axle end play is an indicator of wheel bearing adjustment. End play is the movement, in and out, of the tire/wheel/hub assembly at the end of the axle. Most vehicle and axle manufacturers say .001-inch to .005-inch end play is acceptable. Trailer manufacturers may allow up to .020 inch. You need a dial indicator to measure this movement accurately, but experienced mechanics and technicians can grab the tire at two points 180 degrees apart and detect in-and-out movement by giving the assembly a wiggle. Not a precise measurement by any means, but experienced hands can usually tell if there is too much play, flagging the need for maintenance.

**Axle end play changes camber and toe setting.** For example, pushing in the top of the assembly and pulling out at the bottom will change camber angle. Similarly, pushing on the front side of the tire while pulling on the rear alters toe setting, which raises the obvious question: "How much change in camber and toe does wheel bearing end play cause?"

The amount of change can be predicted with mathematical calculations. The graph in Figure 7.6 shows camber change for a given amount of end play.

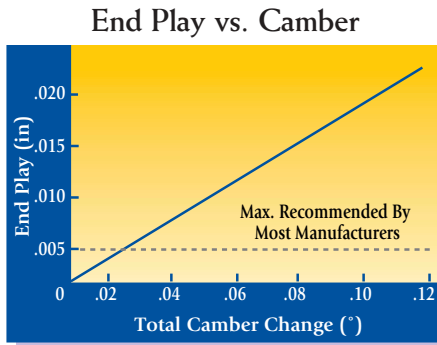
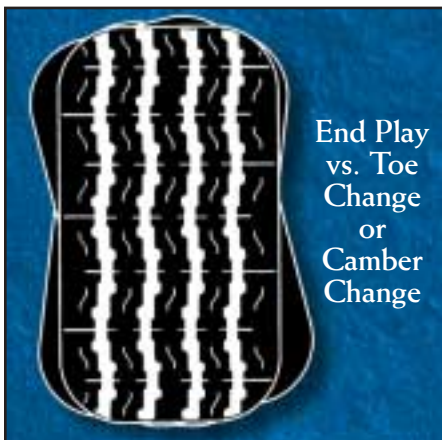

Figure 7.6

If end play and bearing taper angle are known, calculations may be used to determine the diametral clearance (DC) of both inner and outer bearings. Then, knowing the distance between the bearings, the angle change is found using the following formula:

$$\frac{1/2 \text{ DC (Inner Bearings)} \times 1/2 \text{ DC (Outer Bearing)}}{\text{Distance between bearings}}$$



A .020-inch end play will only change the camber about 1/8 of a degree. Camber tolerance is commonly plus or minus 1/4 of a degree, so if end play is kept within spec, the camber change caused by this amount of play is insignificant.

But tolerances are closer for toe. Toe setting is commonly expressed as the difference in distance from the tractor center line to the front and rear edge of each tire as measured at hub center height. Recommended settings for over-the-road trucks are:

**Steer axles:**

Toe in 1/16" ± 1/32" (unloaded)

**For trailer axles:**

0 ± 1/32"

We also calculated possible toe-in change at various end play settings. Remember, toe in is the relationship between front and rear sides of one tire, so we can look at toe change due to end play on one side or both sides of the vehicle. The graph in Figure 7.7 illustrates our findings.

End Play vs. Toe Change or Camber Change



Figure 7.7

If both sides of the steer axle are at maximum allowable end play, toe change of .080 (more than 1/16) inch could result. That's a very significant difference because maximum allowable toe tolerance is only 1/32-inch. So you should keep end play on steer axles well below accepted maximums to get longest tire life.

**Maintain within specs for longer tire wear.** Obviously, any tire/wheel/ hub assemblies that are outside the current spec for axle end play have potential for tire wear problems. And they won't go away. Excessive end play prevents setting

toe properly so irregular tire wear will be chronic if end play is not within spec.

Some experienced mechanics claim improved tire and bearing life with "preloaded" bearings. In addition, some long-life, low maintenance wheel systems are being offered that require a preloaded bearing arrangement as part of their standard installation requirements. To avoid overtorquing these systems, a great deal of care must be used to achieve a proper bearing preload. As a result, the manufacturer's recommendations should be closely followed.

Bearing manufacturers strongly discourage overtorquing a bearing just to eliminate servicing after a break-in period. Although you get more bearing and tire wear, a too-loose bearing is safer on an over-the-road truck than a too-tight one: the overtightened bearing can heat up, may crack and could cause a dangerous axle failure on the road.

We urge you to limit axle end play to the low end of the specified tolerance range and follow the manufacturer's recommendations when preload is required. Make periodic end play checks when permitted by the manufacturer to maintain tight settings. The payoff will be more accurate toe adjustment, safer operation and longer tire life, particularly for high mileage radials.

## ENVIRONMENTAL EFFECTS

Road surfaces and environmental factors play a big factor in tire performance and tread life. An understanding of the effect pavement conditions have on treadwear can help fleet managers analyze variables in overall tire costs. Engineering studies have drawn conclusions about the following variables:

### Road surface textures on treadwear

Tire engineers agree that rough, sharp surfaces and those with embedded shells are more abrasive and tend to generate faster wear rates than polished concrete and smooth asphalt. Rough surfaces create a higher scrub force, which accelerates

treadwear. (Tests show coarse chip and seal pavement increased rolling resistance by 33 percent over concrete.)

To illustrate, engineers have designed indoor laboratory tests and imposed extreme conditions on sets of similar tires. In one specific example, they found abrasive surfaces can create a 100 percent worn situation in as little as 1,000 miles. Meanwhile, the same tires evaluated on polished/ worn surfaces typically were only 25 percent worn after 2,000 miles.

While far from real road conditions, the tests showed a wear rating improvement for the smooth surfaces of 800 percent. Under actual conditions, the tires would have run much farther in both cases.

Fresh concrete is tough on tires. In outdoor tests, engineers found treadwear rates were 70 percent faster on month-old pavement than on 24-month-old concrete. Reason: Over time, traffic wears down the abrasive edges of the fresh surface.

If we were to assign wear ratings to several different road surface materials, the differences would be significant. Dirt, for example, would rate approximately 50 while hot mix asphalt would score 100. Higher numbers indicate treadwear mileage.

Road Surface	Wear Rating
Hot mix asphalt	100
Concrete	90
Crushed rock asphalt	65
Dirt	50

### Grades and tire wear

Today's high torque/low rpm diesel engines have changed typical driving techniques for truckers from "slow uphill/ fast downhill" to more constant speeds. But this added torque to the drive wheels has also created greater driveline and tire stress over extended time periods. Steep grades themselves add to this stress. The two factors subject tires to higher longitudinal forces in the tire footprint area. This condition leads to tire slip, abrasion and wear.

Those carriers operating in the mountains, for instance, can experience 50 percent faster treadwear than carriers operating on relatively flat terrain.

### Curves and tread life

More curves, lower tread life. That's because curve-imposed side forces cause lateral tire deflection and deformation. Tests show frictional forces during specific cornering can be 5.8 times as great as when driving straight. During braking, frictional forces can be 2.4 times as great.

### Climate and tire wear

Water acts as a lubricant. Tires that often travel over wet pavements can show up to 30 percent longer treadwear than tires that run only on dry pavements. Temperature is also a factor. When the temperature increases, so do treadwear rates. For example, when roads are wet, fleets typically obtain better treadwear in the fall and winter verses spring and summer.

Driving technique plays a major role in maximizing tire life, but so does where the vehicle is driven.

## HOW SPEED AFFECTS TIRE WEAR

In 1995, Congress repealed the national 55 mph maximum speed limit. By early summer 1996, 10 states had raised the truck limit to 75 mph, seven others to 70 mph and 22 states to 65.

If you're running where 75 mph signs are found, you might shave two hours from a 500-mile trip. That assumes no extra rest stops, no construction slowdowns or any slowdowns at all. But surveys show that faster drivers take more breaks due to stress, refuel more often, suffer more breakdowns and expose themselves to more potential accidents.

Conclusion: a faster 20 mph speed does not often translate into a 20 mph faster average over the long haul.

And what does rolling in the fast lane do to your rig?

First, there is the fuel penalty. The rule of thumb says for every 1 mph over 55, your semi's fuel economy goes down by 0.1 mpg. So, running 75 instead of 55 may cost you 2 mpg, or 33 percent if your truck averages 6 mpg.

Even running 65 mph vs. 55 costs you 1 mpg or an extra 2.5 cents per mile.

Also affected directly is tire performance. The faster you roll, the more heat your tire casing creates. This degrades casing durability, promotes irregular treadwear, shortens tread life and reduces impact resistance.

Casing durability: The extra heat associated with running faster will affect your tire casings over time. If you're currently averaging two retreads per casing, you may only average 1.5 to 1.75 retreads per casing by running at higher speed limits.

Running hotter can take its toll on rubber. A good example is in the tire's shoulder area, where the belt edge of the top steel belt can obtain temperatures up to 180 degrees F running continuously at 75 mph. At 55 mph, belt edge temperatures average 160 degrees F. The increased temperature degrades casing durability, especially in the second and third retread stages.

**Accelerated Treadwear:** Tests show that every 1 mph increase over 55 mph results in 1 percent reduction in tread mileage. So, running at 75 mph instead of 55 may cost your fleet 20 percent in removal miles.

**Irregular wear:** As your truck speed increases, your tires flex more, resulting in a different footprint. Going from 55 to 75 mph causes the tread centerline to lengthen, which can cause tire shoulders to develop cupping and overall fast shoulder wear.

**Impact resistance:** Your tire's resistance to sidewall snags and tread area punctures is reduced at higher running speeds because of higher rubber temperatures. Expect more incidents of road damage at higher speeds.

How can truckers minimize these negative factors? Be sure to maintain proper air inflation pressure. Running underinflated will accelerate all the problems associated with higher speeds.



## Ride Disturbance

Vibration in modern over-the-road trucks can affect driver comfort (and, therefore, productivity), cargo safety, and equipment wear. As with most other problems, vibration can have a number of different sources and an effective solution requires that the cause (or causes) be accurately determined.



Concern for truck vibration problems has increased in recent years as trucks have evolved to fill today's more demanding trucking industry needs. Several current design trends (e.g. longer wheel bases) have resulted in trucks that are more susceptible to vibration problems.

For increased driver comfort and reduced cargo damage, many over-the-road suspension systems are now designed to be "softer" than in the past. This is accomplished in part by having springs or other devices that have more vertical travel (referred to as jounce and rebound) when a bump is encountered.

Some frequently encountered sources of ride vibration disturbances are:

- Road surface roughness
- Tire/Wheel/Hub non-uniformity
- Driveline component balance or propshaft angularity/phasing
- Improper fifth wheel position
- Trailer influence

Additionally, longer wheelbase trucks are more likely to have a frame flexing or resonance problem. This simply means that as the frame flexes (as all frames do to some degree), the amplitude of flexing and the locations of the high and low points along the frame are more likely to be objectionable on a long wheelbase chassis. See **Figure 8.2**.

Whenever a vibration complaint is voiced on a particular vehicle, the first step is to eliminate the non-tire sources and concentrate on the remaining possible offenders.

Since little can be done about road roughness, we must concentrate on the

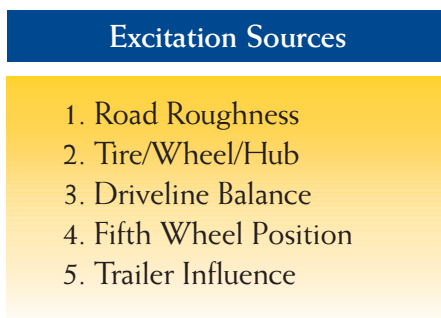

Figure 8.1 Frame Flexing/Resonance

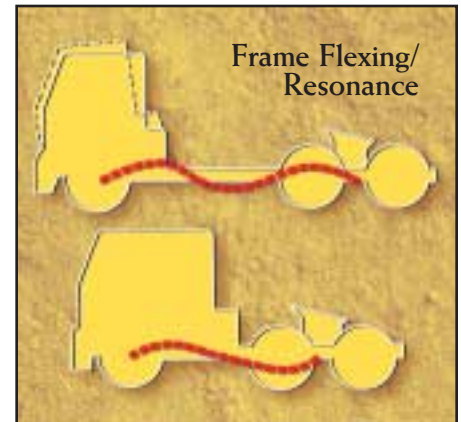
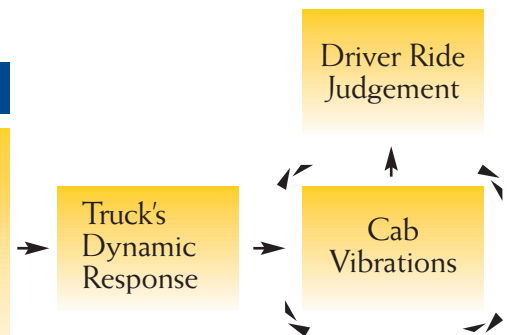

Figure 8.2 Frame flexing may occur at a point that causes great discomfort for the driver.

four remaining ones. The driveline, of course, must be balanced, but may also cause a problem if the angle that the driveshaft forms between the back of the transmission and the front of the differential is too great. See **Figure 8.3**. This is encountered most frequently with a short wheelbase vehicle, such as a single drive axle tractor, designed to pull multiple trailers, or with a truck chassis that has been shortened. Specific procedures and specifications for checking driveline angularity can be found in truck service manuals for the particular make/model of the vehicle being diagnosed or from driveline equipment manufacturers. Any ride disturbance that can be eliminated by taking the truck out of gear at road speed is probably engine or driveline related.





Fifth wheel position and trailer influences can often be altered to determine their effects on a ride vibration concern. If the problem seems to be related to the tires, wheels, or rims or hubs, you should consult your tire company representative.

If ride testing determines that the vibration is likely due to rotating axle components, guidelines for pinpointing tire/wheel/hub related vibration problems are as follows:

### RIDE TEST TIPS

- Drive 15-20 miles to warm up tires and eliminate flat spotting which occurs when a truck has been sitting idle.
- LOCATION – STEERING WHEEL, SEAT
  - Steering wheel and/or floor under the driver's feet – indicates steer tires
  - Backslap in seat – indicates rear assemblies

- TYPE OF DISTURBANCE
  - Up and down indicates run-out, balance
  - Side to side indicates run-out, balance and possibly irregular wear
  - Steering wheel shimmy indicates steer tire dynamic imbalance

### RIDE DIAGNOSTICS: TIRES/WHEELS

- Identify critical conditions/speed of the vibration
- A vibration that gets worse as speed increases may be balance related
- A vibration that occurs at only one speed is probably run-out related
- A vibration that phases in and out indicates a problem at more than one wheel position
- Low speed wobble is run-out related – not a balance problem
- A vibration while braking only is probably a brake system issue

### BALANCE RELATED VIBRATION

Balance is most critical on free-rolling wheels (steer and trailer). In general, spin-balancing of drive tires is not needed. It can also be dangerous due to the differential action, which can result in very high rotational speeds at one axle end, and damage to the truck is possible. On-vehicle balancing with a properly calibrated spin balancer may aid in correcting the vibration problem by balancing that particular tire/ wheel or rim/hub assembly. However, when placing that tire and wheel (or rim) on another wheel position or vehicle, it is likely to be out-of-balance. If the problem is an out-of-balance hub, the ultimate solution is to have the hub balanced.

### RUN-OUT RELATED VIBRATION

For run-out problems, the match-mounting procedure is a complex but effective method to eliminate, or at least isolate, the source of the concern. Match-mounting isolates the tire, wheel, and bolt circle of the wheel to determine where the problem may be. It can also determine if a combination of variables is responsible because the tolerances "stack" to create an unacceptable condition.

Since all tires and wheels are likely to have some run-out and all bolt circles are not perfectly centered, it is important that these factors do not "add up" to create a ride vibration even when individual components are within spec. The accepted guidelines for run-out of tires, wheels, and wheel bolt circles are shown in Figure 8.4. Vehicles with assemblies and components within these guidelines should not have vibration problems due to tire/wheel factors.

If run-out appears to be a problem, use the following match-mounting procedure to attempt a correction:

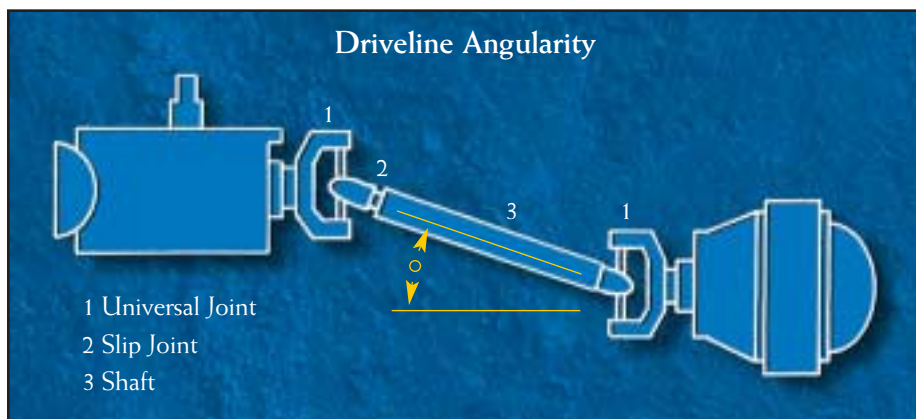

Figure 8.3 Driveline angularity can cause vibration problems.

Runout Guidelines		
	Radial	Lateral
Assembly (on vehicle)	.060"	.150"
Sensitive Vehicle	<.060"	
Wheel	.040"	
Bolt Circle	.020"	
Tire	.060"	.080"

Figure 8.4



## MEASURING RADIAL RUN-OUT

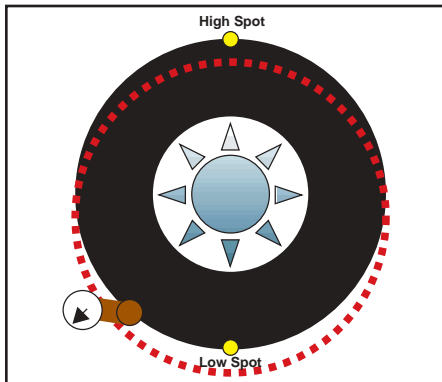

Run-out is a measure of deviation from a perfect circle

- Warm up tires
- Lift vehicle
- Place the dial indicator against the center of the tread pattern
- Turn the wheel slowly and watch the needle
- Find the low spot and zero the gauge
- Spin the wheel to check run-out
- Mark the high spot
- A reading of less than 0.060" (RRO) is usually good. Sensitive vehicles may require 0.060" or less

## REQUIRED TOOLS

- Goodyear infoLink, Ph: 800-755-2772
  - Gauge (0.100" per rev) & slider shoe, part no. 220-011-300
  - Stand, part no. 220-011-200



- 1** • Measure radial run-out on the vehicle at the tire centerline



- 3** • Mount the tire/wheel assembly on a balancer. Check tire "CG" grooves for concentricity with rim flanges on both sides (visual). If not concentric, deflate, break sidewalls away from rim flanges, lubricate and re-inflate
- Recheck the run-out on the balancer. Compare peak locations and magnitudes to results from on-vehicle measurement. Mark the high spot of the assembly and index the tire to wheel as shown
  - If RRO on balancer is greater than on vehicle, hub-to-wheel index is OK. If RRO is less than on vehicle, hub index should be rotated 180° when the assembly is reinstalled on the truck

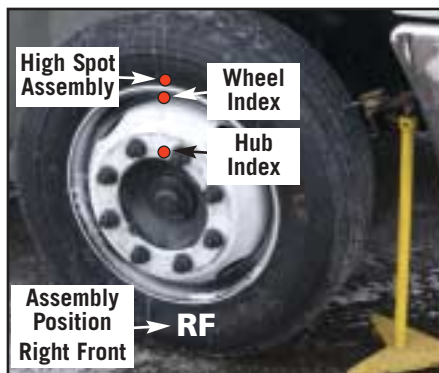

- 2** • Mark the high spot of the tire/wheel assembly and the amount of run-out if over .060"
- Index tires to wheels and wheels to hubs and record assembly position (LF, RF, etc.) on each tire before removal from vehicle



- 4 • If the assembly RRO is over 0.060", rotate tire 180° on wheel and remeasure on balancer. If OK, stop. If still excessive, rotate 90° and remeasure. If OK, stop and balance.

- 6 • If above step is OK and the run-out is still unacceptable, and the new high spot is within 6" of the wheel index, replace the wheel. (i.e., If the high spot moves with the wheel, the wheel's run-out contribution is higher than the tire's contribution)

- 8 • Remount tire on the vehicle and measure radial run-out. Run-out should be the same as measured on the balancer. If out of limits, check the stud circle run-out
- When re-installing **steer** assemblies on vehicle and before tightening lug nuts, locate the high RRO spot at 12:00 on the hubs
  - When re-installing **drive dual** assemblies on vehicle, install highest RRO spot of one assembly at 12:00 on the hub. The high spot of RRO on the other assembly should be opposite (180° from) the first assembly
  - Torque all lug nuts to manufacturer's specification and re-ride the truck



- 7 • Mark final assembly high spot (red) from inside to outside of tire, so it is visible for mounting on the truck. Erase original marks on the tire (yellow)
- Balance all assemblies before replacing on vehicle
  - Repeat steps 1-6 for each assembly on vehicle to optimize overall vehicle ride

- 5 • If the run-out is still unacceptable and the new high spot is within 6" of the first high spot on the tire, replace the tire. (i.e., If the high spot moves with the tire, the tire's run-out contribution is higher than the wheel's contribution)

For further information, see TMC Recommended Practice RP648 regarding ride troubleshooting.



Factors  
Affecting Truck  
Fuel Economy



## VEHICLE AND ENGINE DESIGN

### A. Performance Factors

Fuel consumption is a function of power required at the wheels and overall engine-accessories-driveline efficiency.

Factors that affect fuel consumption at steady speeds over level terrain are:

#### Power Output-Engine-Accessory-Driveline System

1. Basic engine characteristics; fuel consumption vs. RPM and BHP.
2. Overall transmission and drive axle gear ratios.
3. Power train loss; frictional losses in overall gear reduction system.
4. Power losses due to fan, alternator, air-conditioning, power steering, and any other engine-driven accessories.

#### Power Required - Vehicle and Tires

The horsepower required for a vehicle to sustain a given speed is a function of the vehicle's total drag. The greater the drag, the more horsepower is required. The total vehicle drag can be broken into two main components; aerodynamic drag and tire drag. Factors affecting these components are:

#### Factors Influencing Drag

- |             |                           |
|-------------|---------------------------|
| Aerodynamic | - Vehicle speed           |
|             | - Vehicle Frontal area    |
|             | - Vehicle Shape           |
| Tire        | - Vehicle Gross Weight    |
|             | - Tire Rolling Resistance |

Both aerodynamic drag and tire drag are influenced by vehicle speed. It is important, though, to note that speed has a much greater affect on aerodynamic drag than on tire drag, **Figure 1**.

Gains in fuel economy can be made by either optimizing or reducing some of the factors affecting drag.

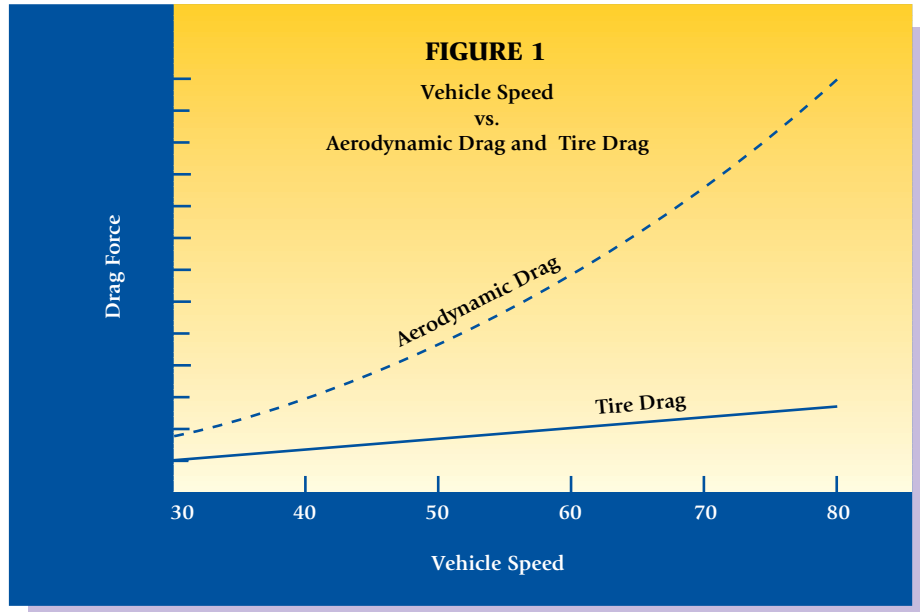

### B. Type of Vehicle

The type of vehicle affects aerodynamic drag through its size (frontal area) and shape. The following illustration shows two tractor-trailer combinations which, as a result of their shorter height (h2 and h3), have smaller frontal areas than the standard van-type trailer.

Trailer shape has a large impact on the aerodynamic drag of the tractor-trailer combination. Some examples of trailers that have lower aerodynamic drag shapes are:



Where:  $b_1 > b_2 < b_3$  Frontal Area =  $FA = (b) \times (w)$  Where:  $b$  = Height,  $w$  = Width

# SECTION NINE



Drop frame trailers – Less “Open Air” space under the trailer. This also creates less airflow disturbance in crosswind conditions and thereby reduces the amount of drag.



Rounded Vertical Edge – Maintains “Attached” airflow along the trailer sides, which reduces drag.



Sharp Vertical Edge



### C. Use of Aerodynamic Drag Reduction Devices

With van-type trailers, certain add-on devices are capable of reducing a vehicle's aerodynamic drag. These devices help maintain an "attached" airflow along the trailer sides. Again, an increase in drag occurs when the airflow becomes "detached."

The favorable impact of roof fairings is maximized when the vehicle is operating in a "head-on" wind condition as shown above. The effectiveness of a roof fairing is reduced when the vehicle encounters a "crosswind" (yaw wind) condition. Also, if the trailer height is lower than the top of the fairing, as in the case of a flat-bed trailer, the fairing increases drag because it increases the vehicle's frontal area. Use of a "roof shield" is less effective than a "roof fairing" because it doesn't channel the wind at the sides. Therefore, a "roof fairing" is preferred.

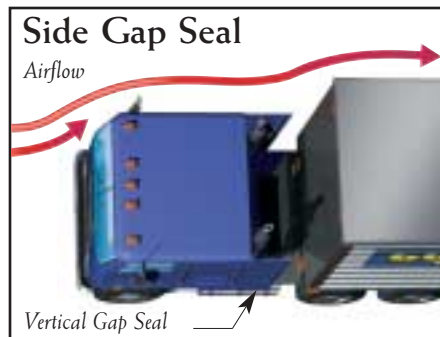

Vertical gap seal devices reduce drag by preventing the airflow from entering the "open air" space between the tractor and trailer. Unlike the roof fairing, the impact of this device is maximized when the vehicle is operating in a yaw wind condition.

### D. Engine and Driveline Characteristics

The use of wide torque band low RPM engines and wide-step top gear transmissions, combined with proper rear axle ratios, leads to fuel economy improvement when operated in the speed and RPM ranges recommended by engine and vehicle manufacturers.

Note that a change in the overall diameter of the drive axle tires can effectively alter the rear axle ratio and could adversely affect fuel economy. The determination whether a drive tire change produces an increase or decrease in fuel economy depends on how much and in which direction engine RPMs are changed.



Also of importance is the amount of gap between the back of the tractor cab and the front of the trailer. The larger the gap, the greater the disruption to the airflow and the resulting drag. This becomes even more important when encountering crosswind conditions (yaw wind). A rule of thumb is for every 10" over a 30" gap there is about a 1/10 drop in MPG.



Long Wheelbase Tractor



Yaw Wind Condition



The effect of tire overall diameter on fuel consumption can be illustrated using an engine fuel map, **Figure 2**. This is an example of a typical part load brake specific fuel consumption (BSFC) engine map. It shows lines of constant BSFC as a function of engine BHP output (vertical axis) and engine RPM (horizontal axis).

A smaller diameter drive axle tire results in an increase in engine cruise RPMs, from point A to B. At point B the engine is consuming more fuel for the same BHP output.

Proper drive train component matching can provide the most fuel efficient RPM/ground speed combination to maximize fuel economy. Engine RPMs can be determined using the following formula:

$$\text{Engine RPM} = \frac{V \times \text{TR} \times \text{AR} \times (\text{Tire RPM})}{60}$$

Where:

V = Vehicle Speed (mph)

TR = Transmission Ratio @ Top Gear (e.g. 1.0 for Direct Drive)

AR = Rear Axle Ratio (e.g. 3.70)

Tire RPM = Tire Revs Per Mile (obtained from Goodyear's Engineering Data Book or [www.goodyear.com/truck](http://www.goodyear.com/truck))

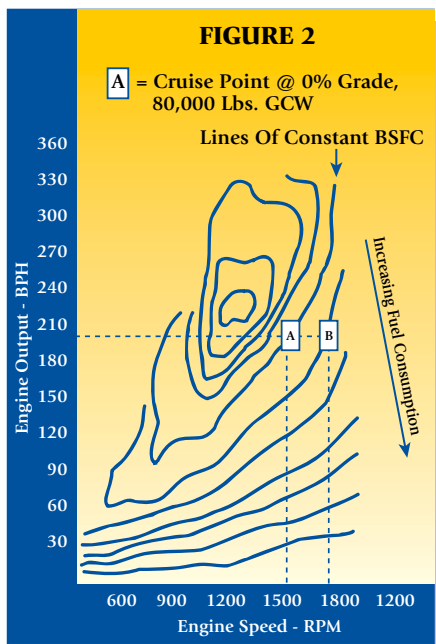

Source: Mack Truck Engineering, Allentown, PA, Oct. 1992

## VEHICLE OPERATION

### A. General

Consider a typical tractor and van combination operating at 80,000 lb. gross combination weight and at 55 MPH on a level highway. No aerodynamic drag reduction devices are used on either the tractor or the trailer. Using bias ply tires in all wheel positions, the approximate distribution of horsepower requirements is as follows:

Item	HP Requirement	Percent
Aerodynamic Drag	104	40
Tire Roll Resistance	97	38
Driveline Losses	36	14
Engine Accessories	20	8
	257	100

In this example, the horsepower required to overcome bias ply tire rolling resistance is essentially the same as that required to counteract aerodynamic drag. The total horsepower requirement can be lowered with the use of radial ply tires.

Because radial ply tires have lower rolling resistance than bias ply tires, tire horsepower requirements are lower. As a result, fuel economy is improved. And as the proportion of tire horsepower requirement on a vehicle increases, the gain in fuel economy due to using radial truck tires increases. Some examples of tire horsepower requirements as a percentage of total vehicle horsepower requirements are given in **Figure 3**.

At lower Gross Combination Weights (at the same speed), the horsepower required to overcome the tire rolling resistance is a smaller portion of the total brake horsepower required (BHP). This is also true as speed is increased (at the same GCW). As the vehicle's aerodynamics are improved, as in the case of a tractor pulling a tanker trailer rather than a van trailer, the BHP required to overcome aerodynamic drag is reduced. This has the effect of increasing the percent contribution of tire rolling

resistance to the total BHP required. In this case, reducing tire rolling resistance by switching to radials has a greater impact on reducing the total BHP required.

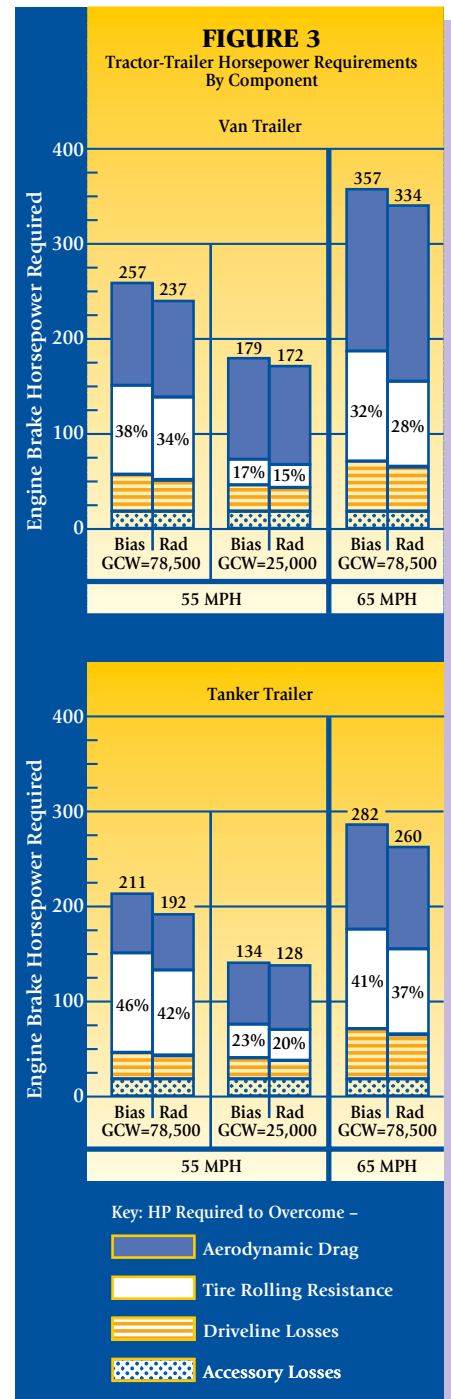

Source: Goodyear Maintenance Calculations

### B. Type of Haul

The ideal type of haul for maximum fuel economy consists of long distance runs at steady moderate speed with a minimum of stop-and-go driving and with a minimum of turning. Shorter runs involve more braking, acceleration and turning. The engine and tires operate at less than optimum conditions. Fuel economy tends to be reduced. In some cases of stop-and-go driving, tires may be operating "cold" part of the time without sufficient continuous driving time for adequate warm-up. A curve of tire rolling resistance vs. warm-up time as obtained from a laboratory test is given in Figure 4.

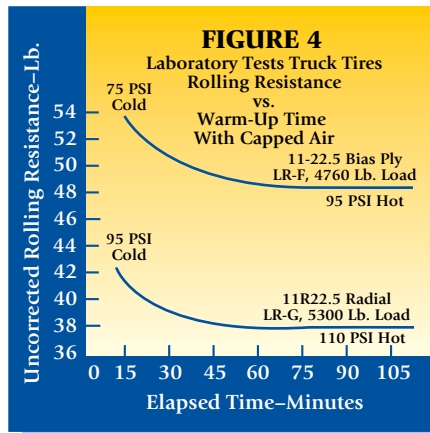

A 1975 study by the U.S. Department of Transportation and the U.S. Environmental Protection Agency<sup>a</sup> concluded that the type of haul (local, short-haul, or long-haul trips) has a strong effect on fuel economy improvement attributable to radial tires.

The increased stop-and-go driving of the shorter haul reduces the fuel economy gain due to radials. The results of the study are given below:

Fuel Economy Improvement Due To Radial Tires Versus Driving Mode	
Driving Mode	Fuel Economy Improvement
Local	3 to 5%
Short-Haul	4 to 8%
Long-Haul	5 to 9%

<sup>a</sup>Interagency Study of Post-1980 Goals for Commercial Motor Vehicles, Revised Executive Summary, November 1976. U.S. Department of Transportation and U.S. Environmental Protection Agency.

### C. Vehicle Speed

As vehicle speed is increased, horsepower requirements to overcome the aerodynamic drag increase rapidly. There is also an increase in the horsepower required to overcome increasing tire rolling resistance, though this occurs at a lower rate. The sum total horsepower requirement for a tractor-trailer vehicle increases along a curve which has a continually steeper slope as speed is increased. For example, Figure 5 shows that the total horsepower requirement at 65 MPH is 40 percent greater than at 55 MPH for the typical tractor and van-type trailer. As a result, fuel economy will fundamentally decrease as operating speed is increased from 55 to 65 MPH.

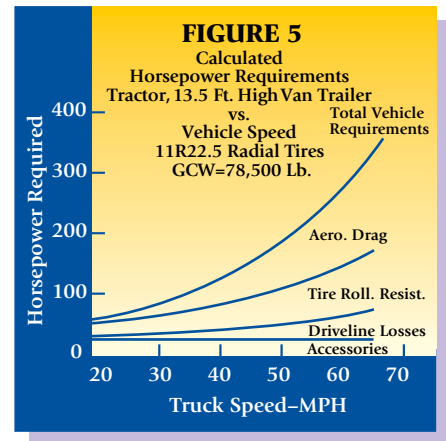

Source: Goodyear Maintenance Calculations

A rule of thumb. Increase of 10 mph = decrease of 1 mpg.

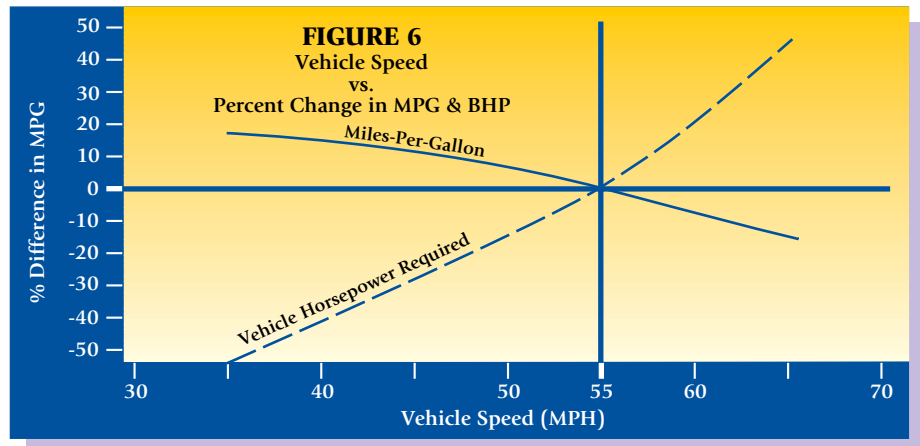

Source: Goodyear Fuel Economy Model Prediction

A calculated curve of the percent difference in MPG versus speed is shown in Figure 6. A reduction in MPG of about eight percent was found for every 5 MPH increase in vehicle speed over 55 MPH. For 65 MPH, this would equal close to a mile-per-gallon loss in fuel economy.

### D. Vehicle Gross Combination Weight

As gross combination weight is increased, tire rolling resistance increases, and vehicle miles per gallon decreases, assuming speed is maintained constant.

To verify this point, fuel economy tests were conducted at the Goodyear San Angelo Proving Grounds on Goodyear over-the-road tractor-trailers. Unisteel radial tires were compared to

Super Hi-Miler and Custom Cross Rib bias ply tires on the same vehicles to determine relative miles per gallon.<sup>a</sup> Figure 7 shows the results of the tests along with calculated curves passing through the test points. The effect of vehicle gross combination weight on miles per gallon is shown. Note that as truck gross weight was increased, miles per gallon decreased with both the Unisteel radial tire and the bias ply tire; however, the Unisteel tire gave proportionately greater improvement in fuel economy as truck gross weight was increased.

Tests were run at the San Angelo Proving Grounds<sup>a</sup> to determine the effect of Gross Combination Weight on vehicle miles per gallon, comparing 11R22.5 Unisteel radial to 11-22.5 bias ply tires at 60 MPH. Figure 8 shows that at a GCW of

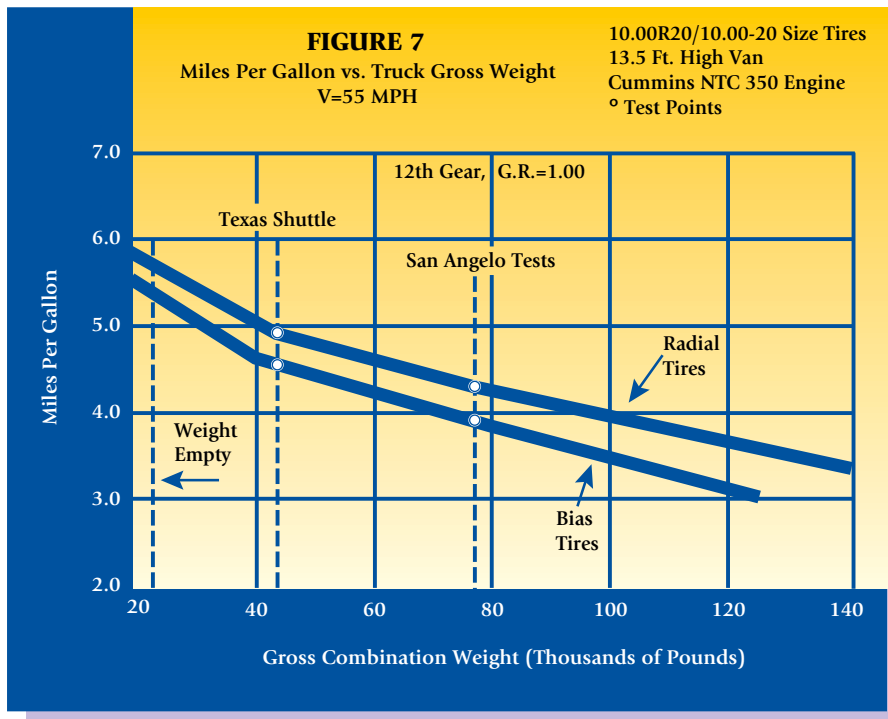

Source: Goodyear Testing Data

78,700 lb., the measured MPG advantage of the radial tire was 6.7 percent, while at a GCW of 46,000 lb., the corresponding value dropped to 1.6 percent. This measured reduction in the miles per gallon advantage of radial tires at the lighter load was more severe than theory would indicate. Calculations show that the 6.7 percent advantage should drop to about 3.5 percent at the lighter load.

<sup>a</sup>The Effects of Goodyear Unisteel Radial Ply Tires on Fuel Economy. Goodyear Tire & Rubber Company Booklet dated 2/77.

**FIGURE 8**  
Effect of Gross Combination Weight (GCW) on MPG Advantage of Radial Tires

GCW	Percent Increase in MPG Radial/Bias	
	Test Data	Calculated
78,700	6.7	6.7*
46,000	1.6	3.5

\*Assumed Same Value As Test Data

Source: Goodyear CFG Tests and Mathematical Calculations

The test data above confirms that the fuel economy advantage of radial truck tires over bias ply tires increases with heavier vehicle Gross Combination Weights.

<sup>a</sup>Tire Parameter Effects of Truck Fuel Economy. R.E. Knight, The Goodyear Tire & Rubber Company. SAE Technical Paper 791043, November 1979.

<sup>b</sup>"17 Tricks to Save Fuel and Save \$\$\$\$", Pamphlet DOTHS 804 547, June 1979.

### E. Driver

Driver operating procedures are important factors in achieving maximum vehicle fuel economy. The potential benefits of lower vehicle aerodynamic drag, lower tire rolling resistance, and more efficient engines can be offset or even negated by a driver running at a higher speed.

General rules for the driver to follow are:<sup>b</sup>

- Keep accurate records of fuel used, routes taken and loads carried so

you know if you are making any improvements.

- Try progressive shifting, don't run against the governor on every shift and stay 200-300 RPM below the governor at cruise (See Figure 9).
- Stay in as high a gear as possible. You can't lug today's engines if you can maintain speed in any gear. Keep RPM low: below the governor but above the minimum RPM recommended by the engine manufacturer.
- Eliminate unnecessary idling. Shorten warm-up and cool-down times to the minimum recommended by the engine manufacturer. Don't leave the engine idling while you eat lunch or have coffee.
- Drive defensively.
- Cut down top speed. Each MPH over 55 costs you 2.2% in fuel costs!
- Watch the fueling operation. If you top the tank that valuable liquid could spill or overflow later when you're parked in the sun.
- Carry as big a load as you can. Run as few empty miles as you can.
- Anticipate traffic conditions. Accelerate and decelerate smoothly.

Tire care can also affect fuel economy. The most important thing a driver can do is to check inflation pressure often with a calibrated tire gauge and make sure that tire pressure is maintained at a recommended high value. (See Figure 14 for effects of inflation pressure on fuel economy.)

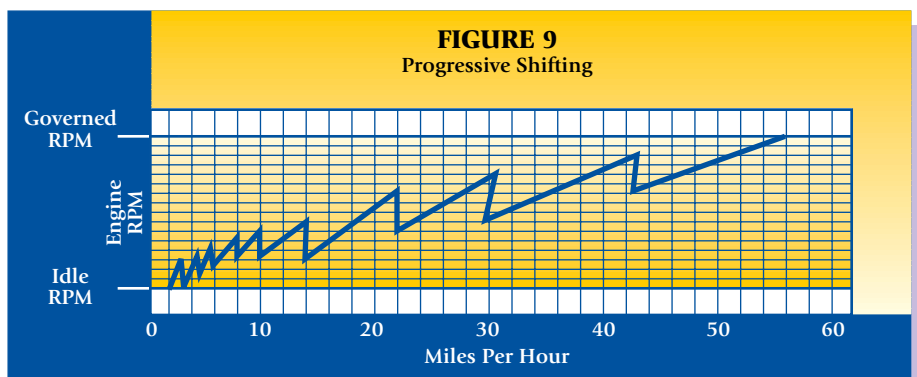

Source: Tricks to Save Fuel and Save \$\$\$\$ DOT Pamphlet HS 804547, June, 1978



## TIRE SELECTION AND MAINTENANCE

### A. Tire Rolling Resistance

The primary cause of tire rolling resistance is the hysteresis of the tire materials/structure, its internal friction, which occurs as the tire flexes when the vehicle moves. Tire rolling resistance acts in a direction opposite the direction of travel and is a function of both the applied load and the tire's inflation pressure (See Figure 10).

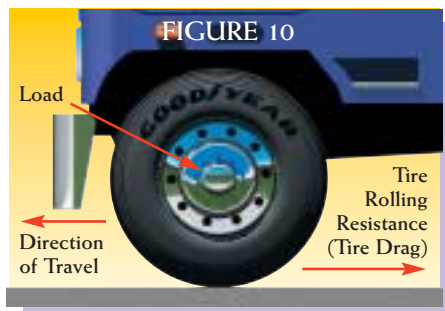

To accurately determine a tire's rolling resistance, a controlled laboratory test is conducted. One method employed, is to run the tire against an electrically driven 67" diameter flywheel. A torque cell is used to measure the amount of torque required to maintain a set test speed at a prescribed test load condition. With this torque value, additional adjustments are performed to arrive at the tire's rolling resistance. The laboratory test provides a procedure where environmental influences (such as ambient temperature, wind, and road surface texture) can be either controlled or eliminated. Also, strict limits are placed on allowable variations in test speed, slip angle, applied load, and specified test inflation. These controls insure test repeatability and allow the accurate assessment of a tire's true rolling resistance.

Tire rolling resistance is commonly defined in two ways:

- Pounds resistance per 1000 pounds of load
- Pounds resistance per pound load (rolling resistance coefficient)

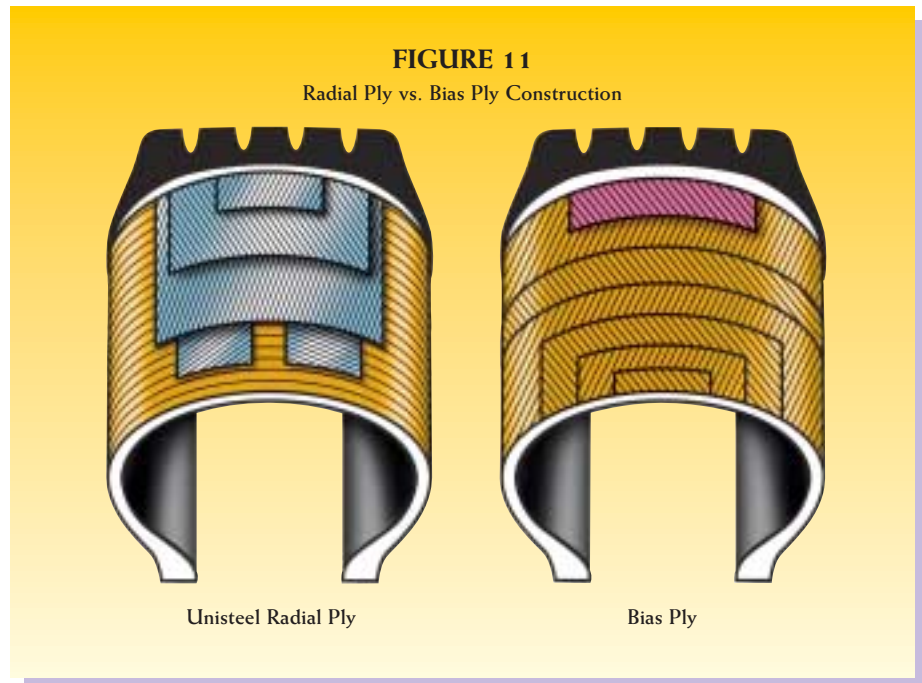

### B. Types of Tires

#### Radial Ply vs. Bias Ply

The significant differences between these two tires are the angle of body plies and the presence of belts. Figure 11 shows the basic structural differences. Note that the Unisteel radial tire incorporates a single radial ply and a multiple belt system. The bias ply tire has six to eight diagonally oriented plies and no belt system (although the bias ply tire usually has two fabric "breakers" under the tread with same angle as the plies). One significant advantage of the Unisteel tire is the relatively low internal friction compared to that in a tire using bias ply construction.

The lower internal friction of the Unisteel tire helps minimize operating temperatures and rolling resistance, major causes of tire wear and excess fuel consumption.

Unisteel radial ply tires can provide fuel savings of six percent and more compared to bias ply tires in over-the-road tractor-trailer applications.

#### Tubeless vs. Tube Type

Laboratory rolling resistance tests indicate that by changing from a 10.00R20 tube type tire to an equivalent 11R22.5 tubeless tire in all wheel positions, a gain of about 2% in miles per gallon can be achieved at 80,000 lb. GCW.

#### Larger Diameter Tires

Laboratory tests indicate that, under the same load and inflation condition, larger diameter tires produce slightly lower rolling resistance, as in the case of an 11R22.5 versus an 11R24.5. This can produce an improvement in fuel economy coupled with the reduction in engine RPMs due to the larger overall tire diameter on drive axles. (See Section 1-D for the effect of engine RPMs on MPG.)

### Wide Base Super Single Tires

Goodyear Proving Grounds tests show that a fully-loaded tractor-van trailer using Goodyear Super Single Unisteel 15R22.5 tires instead of dual steel radial 11R22.5 tires on tractor drives and on trailer, obtains an average increase of seven to eight percent in MPG.

Commercial fleet testing using loaded tractor-tanker trailers showed a nine percent gain in measured MPG through the use of wide base single 15R22.5 steel

radial tires instead of 11R22.5 steel radial tires in the dual positions. A comparison of the super single versus duals configuration is shown in Figure 12.

### Retreaded Radial Tires

Goodyear laboratory tests show that the rolling resistance of newly retreaded radial tires is, on the average, the same as radial tires with the full original tread. There are some differences due to type of retread, but all newly retreaded radial tires tested exhibited considerably lower rolling resistance than new bias ply tires.

### Radial Tires on Trailer Axles

The type of tire used on an axle has a direct impact on the vehicle's fuel economy. Testing has shown that using radial tires on trailer axles produces over half of the total improvement obtained when converting a vehicle from all bias to all radial. Figure 13 details the total percent gain in MPG by switching from bias to radial tires and, of this total gain,

the percentage due to steer, drive, and trailer tires. For maximum fuel economy as well as for best handling, radial tires should be used in all positions of a tractor-trailer unit. Using radial tires especially designed for trailer application will also provide an additional improvement in fuel economy. For example, the radial low profile G114 offers approximately a 10 percent lower rolling resistance than the G159 low profile.

For a vehicle already equipped with radial tires and being switched to another type of radial, the percent contribution by axle to fuel economy will differ from that shown in Figure 13. A rule of thumb for this case is that the front tires contribute about 14 percent of the total, the drive tires about 39 percent, and the trailer tires about 47 percent. It should be noted that the actual percent contribution may differ from the above due to the effects of vehicle loading, tire inflation, and tire type.

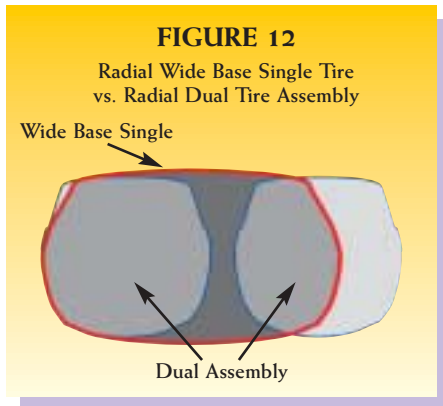

Source: Goodyear CPG Test

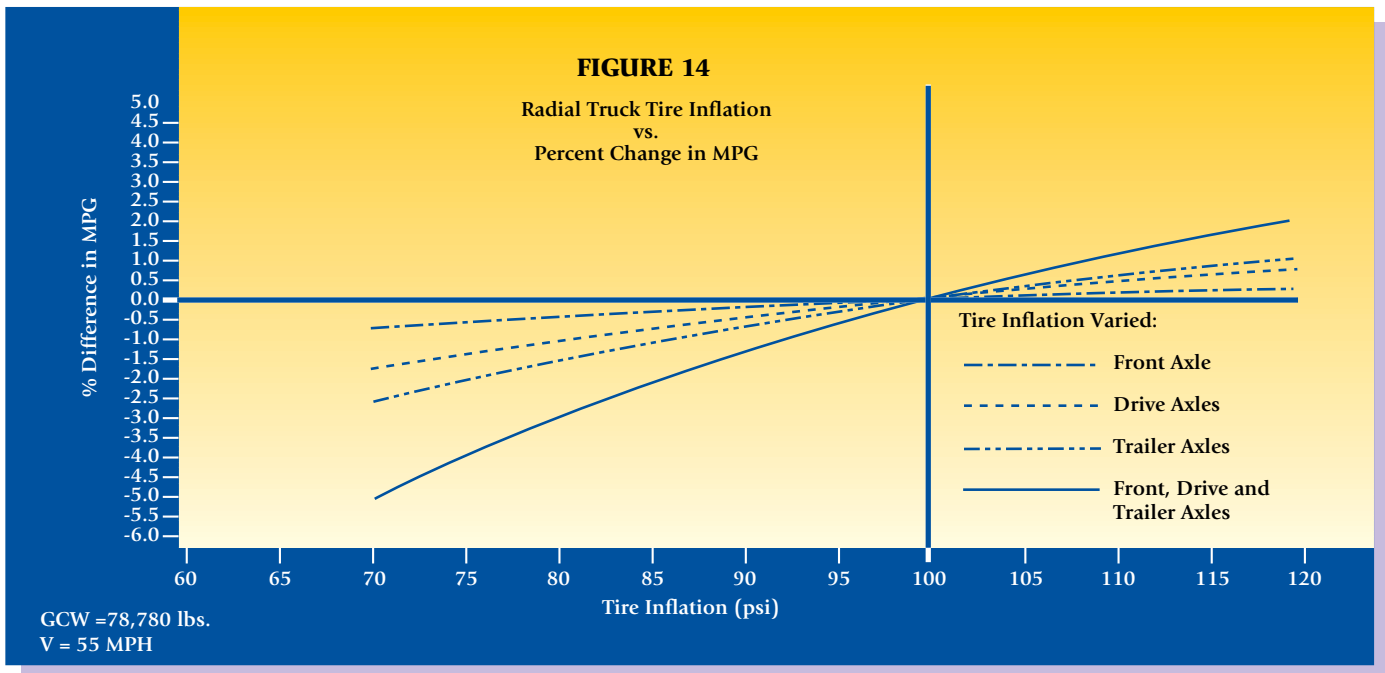

Source: Goodyear Fuel Economy Model Predictions

### C. Tire Maintenance Inflation Pressure

Laboratory tests were conducted to determine the effect of inflation pressure on the rolling resistance of the 295/75R22.5 G159, G167, and G114 radial truck tires. This laboratory data was used to calculate the corresponding effect of inflation pressure on the fuel consumption of a typical tractor-trailer at 55 MPH on a level highway. The effect of inflation pressure on fuel consumption by axle position was also studied. The results are shown on Figure 14.

A dual tire load of 4250 lbs./tire and a steer tire load of 5390 lbs./tire were selected along with a specified inflation pressure of 100 PSI for all tires. Figure 14 shows the percent loss in fuel economy due to the lower inflation pressures.

Operating a loaded tractor-trailer with inflation pressures of all tires as low as 70 PSI results in a calculated reduction in MPG of about five percent. The largest contributor to this loss in MPG is the reduction in inflation pressure of the trailer tires — it alone accounts for half the loss. Varying only the steer tire

inflation pressures results in the smallest percent change in MPG.

It must be noted that the tractor-trailer load affects the percent reduction in MPG due to underinflation. The lighter the GCW, the smaller the percent loss in MPG (for the same reduction in tire inflation).

A good rule of thumb is that every 10 PSI reduction in overall tire inflation results in about a one percent reduction in MPG.



**FIGURE 15**

**Tractor-Trailer Alignment Effects On Fuel Economy**

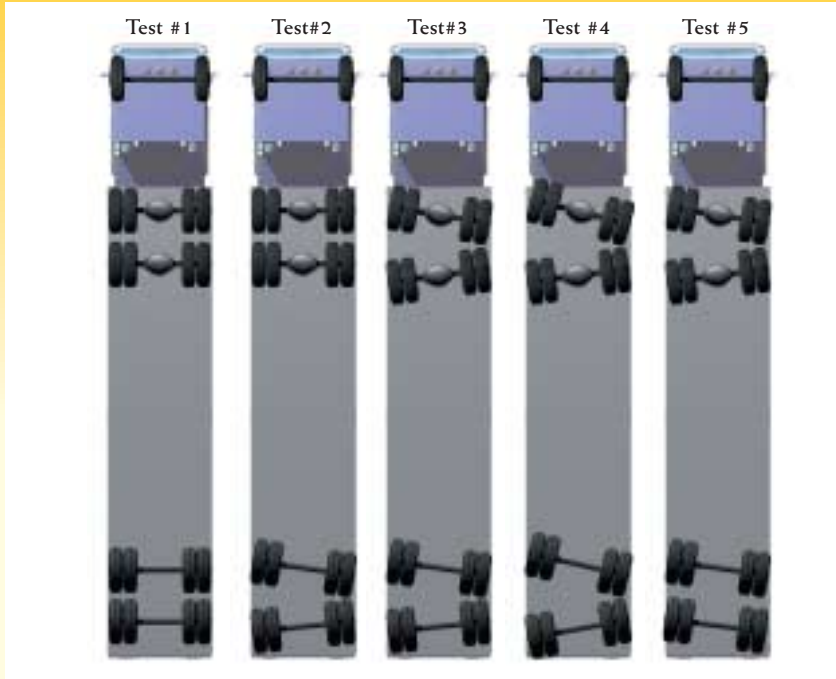

	Test #1	Test#2	Test#3	Test #4	Test #5
<b>ALIGNMENT</b>					
Steer Tire. Toe-In:	0"	1/4"	1/4"	3/8"	3/8"
Drive Axle. Non-Parallel:	0"	0"	1/2"	1"	1"
Trailer Axle. Non-Parallel:	0"	1/2"	1/2"	1"	0"
*Non-Perpendicular to Frame, 1-1/2"					
% Improvement in Fuel Economy:		-0.6	-0.8	-1.7	-2.2

### Alignment

For optimum fuel economy on a tractor-trailer, and also for optimum tire wear, tandem drive axles and tandem trailer axles should be maintained in proper alignment. Alignment of the vehicle's tandem axles should be considered as important as the alignment of the steer axle tires. The importance of this is not only reflected in the loss of MPG due to the increase in tire rolling resistance, but also in the increase in tire wear as a result of the greater amount of side-scuffing. The effects of drive axle and trailer axle alignment is even greater due to the number of tires involved: eight vs. two.

Figure 15 illustrates the results of a

Goodyear fuel economy test program run at TRC of Ohio in 1986. These evaluations were Type II tests conducted to SAE J1376 standards. Tests #2 and #3 with steer axle toe-in of 1/4- inch, along with misaligned tandem axles of 1/2-inch total (difference in fore and aft distance between axle center lines, from one side of the vehicle to the other), did not result in a significant loss in MPG versus the specification aligned tractor-trailer. The percent increase in tire rolling resistance due to the slip angles (under .2°) generated by these misalignment conditions is small. What is of greater significance is the loss in tire treadwear life.

Increasing the steer tire toe-in to 3/8-inch and the tandem axle misalignment

to 1-inch in test #4 does produce a loss in MPG which is significant.

The greatest loss in MPG was produced in test #5 where a "dog-tracking" condition was simulated. The trailer tandem axles were misaligned by 1.5-inch though the axles were parallel to one another. The loss in fuel economy was about two percent in addition to increased tread loss.

### Treadwear

As the tread is worn down, tire rolling resistance decreases and vehicle fuel economy increases for both radial and bias ply tires. Proving Grounds tests showed about a one percent increase in miles per gallon for radial tires with tread approximately 30 percent worn.<sup>a</sup> Laboratory tests show about a 10 percent decrease in rolling resistance for both radial and bias ply tires with tread half worn, and a 20 percent decrease for a fully worn tire. (See Figure 16.)

<sup>a</sup>Tire Parameter Effects on Truck Fuel Economy by R. E. Knight, The Goodyear Tire and Rubber Co. SAE Technical Paper No. 791043, November 1979.

**FIGURE 16**  
Effect of Treadwear on Truck Tire Rolling Resistance Laboratory Data

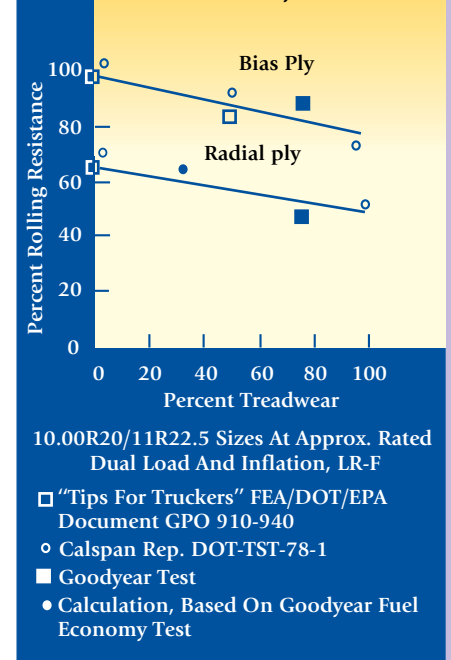

Source: Goodyear Fuel Tests at TRC of Ohio, 1986

## ENVIRONMENTAL CONDITIONS

### A. General

Conditions external to the vehicle can have a strong influence on the fuel economy achieved by a given driver and tractor-trailer/tire combination. Some of the greater influences are exerted by:

Winds

Road Surface

Ambient Temperature

Terrain

### B. Winds

Headwinds and crosswinds reduce truck fuel economy by increasing truck airspeed and/or yaw angle, thus increasing aerodynamic drag. To avoid excessive fuel consumption in sustained strong headwinds, a decrease in truck highway speed is indicated.

Crosswinds also tend to diminish the effectiveness of aerodynamic drag-reducing devices such as cabmounted flow deflectors. Tailwinds are generally beneficial in increasing fuel economy because of the reduced airspeed for a given highway speed. However, if the driver takes advantage of the tailwind and increases his highway speed, the fuel economy gains will be reduced or lost completely.

### C. Road Surface

The type of road surface can affect tire rolling resistance. Smooth-textured highway surfaces provide the lowest rolling resistance, while coarse-textured surfaces give the highest tire rolling resistance and the lowest fuel economy.

In a test,<sup>b</sup> it was found that a coarse chip-and-seal pavement surface gave an increase in passenger tire rolling resistance of 33 percent over that obtained on a typical new concrete highway surface. Relative rankings of the test surfaces were:

Surface	Relative Rolling Resistance %
Polished Concrete	88
New Concrete	100
Rolled Asphalt (rounded aggregate)	101
Rolled Asphalt (medium coarse aggregate)	104
Rolled Asphalt (coarse aggregate)	108
Sealed Coated Asphalt (very coarse)	133

Another study on passenger tires<sup>c</sup> investigated the effect of road roughness (not surface texture) on rolling losses and concluded:

1. Road roughness increases both rolling and aerodynamic losses (the latter due to vehicle pitching action).
2. Road roughness significantly increases vehicle rolling losses due to energy dissipation in the tires and suspension.
3. Tests on rough roads led to increases in rolling losses as large as 20 percent, in addition to introducing increases in aerodynamic drag.

Truck fuel economy may be expected to be influenced in a manner similar to that of passenger cars; by the surface condition of the roadways traveled and by the type of materials used in the pavement—especially in asphalt/ crushed stone mixes. Tire treadwear as well as vehicle fuel economy may be influenced by the particular area of the country being traversed, depending upon the sharpness and hardness of the local crushed stone used in asphaltic concrete road pavement mixes.

<sup>b</sup>L. W. DeRAAD "THE INFLUENCE OF ROAD SURFACE TEXTURE ON TIRE ROLLING RESISTANCE", SAE TECHNICAL PAPER 780257 PRESENTED AT THE CONGRESS AND EXPOSITION, COBO HALL, DETROIT, FEBRUARY 27 - MARCH 3, 1978.

<sup>c</sup>Steven A. Velinsky and Robert A. White, "Increased Vehicle Energy Dissipation Due to Changes in Road Roughness with Emphasis on Rolling Losses." SAE Technical Paper 790653 Presented at Passenger Car Meeting, Dearborn, Michigan, June 11-15, 1979.

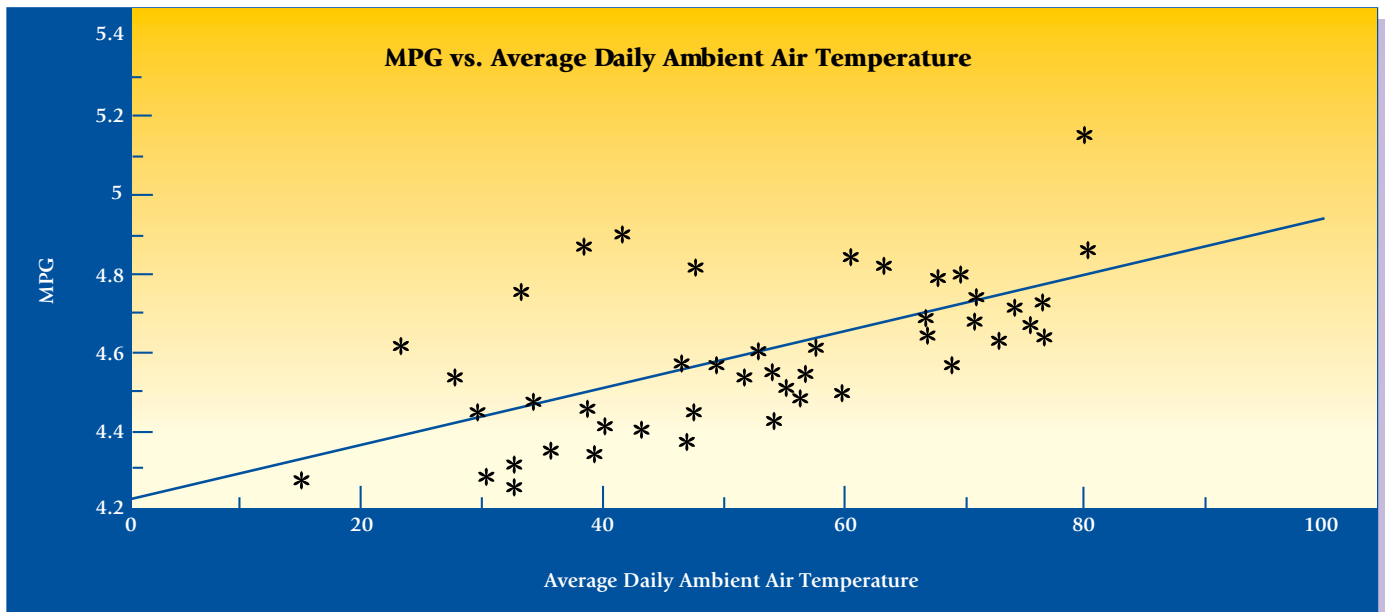

### D. Ambient Temperature

High ambient temperatures reduce tire rolling resistance. High temperatures also reduce atmospheric density, resulting in lower aerodynamic drag. However, fuel economy performance of non-turbocharged diesel engines may be adversely affected by high ambient temperatures, and this would tend to negate some of the gains resulting from lower tire drag and lower aerodynamic drag.

Cold weather operation has an opposite effect: tire drag and aerodynamic drag increase at the lower ambient temperatures. The greater thermal efficiency of internal combustion engines at low ambient temperature is usually cancelled by longer warm-up times and longer idling times to maintain cab temperatures during stopover periods. Thus, wintertime fuel economy is generally lower than that obtained in the summer.

### E. Terrain

#### 1. Grades

Most proving grounds fuel economy testing is done on level terrain, and most simplified calculations relating various truck and tire parameters to truck fuel economy also assume level terrain.

The effect of traveling up a grade is very significant in terms of reducing truck fuel economy. Assuming a one percent grade and an 80,000 pound tractor-trailer, there will be a rearward force exerted by gravity of  $80,000 \text{ pounds} \times .01 = 800 \text{ pounds}$ .

Proving grounds tests over a measured mile on a road with a 0.1 percent grade consistently showed eight to ten percent lower miles per gallon, comparing going uphill to the west with going downhill to the east. This difference was obtained using a typical tractor-trailer at 55 MPH and at a gross combination weight of 78,500 pounds.

Traveling on a downhill grade improves fuel economy and in hilly country helps to counteract the losses in fuel economy sustained by traveling upgrade.

#### 2. Altitude

As altitude increases, air density and atmospheric pressure decrease. At 5,000 ft. altitude, for example, air density in a standard atmosphere is 14 percent less than at sea level. This percent reduction in air density also applies to reduction in aerodynamic drag, all else being equal.

Tire rolling resistance is not affected by altitude, per se, unless cold inflation pressure is set at lower altitudes and not changed as altitude of operation increases during the course of the trip. For example, a tire with a gauge cold inflation pressure of 100 PSI at sea level, if taken to 5,000 ft. altitude at the same ambient temperature, would have a gauge cold inflation pressure of about 103 PSI. This added inflation would tend to reduce tire rolling resistance.

Altitude effect on engine fuel economy performance depends on the particular engine design and whether or not it is supercharged or tuned for high-altitude operation.



## TIRE DESCRIPTION AND SPECIFICATIONS

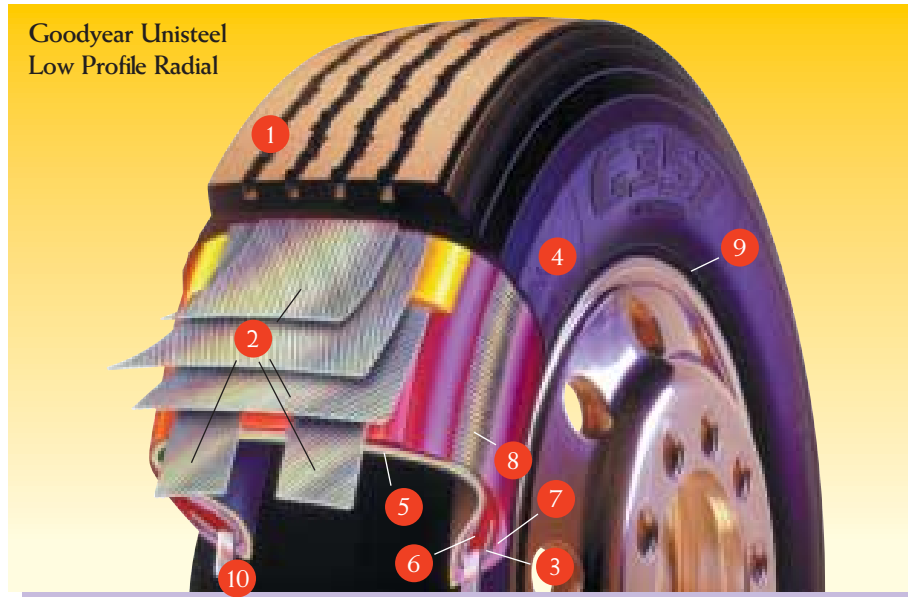

Cross-Sectional View of Typical Tire

1. **Tread**—This rubber provides the interface between the tire structure and the road. Primary purpose is to provide traction and wear.
2. **Belts**—Steel cord belt plies provide strength to the tire, stabilize the tread, and protect the air chamber from punctures.
3. **Stabilizer Ply**—A ply laid over the radial ply turnup outside of the bead and under the rubber chafer that reinforces and stabilizes the bead-to-sidewall transition zone.
4. **Sidewall**—The sidewall rubber must withstand flexure and weathering while providing protection for the ply.
5. **Liner**—Layers of rubber in tubeless tires especially compounded for resistance to air diffusion. The liner in the tubeless tire replaces the innertube of the tube-type tire.
6. **Apexes**—Rubber pieces with selected characteristics are used to fill in the bead and lower sidewall area and provide a smooth transition from the stiff bead area to the flexible sidewall.
7. **Chafer**—A layer of hard rubber that resists rim chafing.
8. **Radial Ply**—The radial ply, together with the belt plies, withstands the burst loads of the tire under operating pressure. The ply must transmit all load, braking, and steering forces between the wheel and the tire tread.
9. **GG Ring**—Used as reference for proper seating of bead area on rim.
10. **Bead Core**—Made of a continuous high-tensile wire wound to form a high-strength unit. The bead core is the major structural element in the plane of tire rotation and maintains the required tire diameter on the rim.

### Terms Used To Describe Tire/Rim Combination

- **Outside Diameter (OD)**—The unloaded diameter of the tire/rim combination
- **Section Width (SW)**—The maximum width of the tire section, excluding any lettering or decoration
- **Section Height (SH)**—The distance from the rim to the maximum height of the tire at the centerline

- **Static Loaded Radius (SLR)**—The distance from the road surface to the horizontal centerline of the wheel, under dual load
- **Minimum Dual Spacing**—The minimum dimension recommended from rim centerline to rim centerline for optimum performance of a dual wheel installation
- **Loaded Section (LS)**—The width of the loaded cross-section

Tire profile or cross-sectional shape is described by aspect ratio (AR): the ratio of section height (SH) to section width (SW) for a specified rim width. For a given tire size, the aspect ratio for a Goodyear radial truck tire is the same as for a bias ply truck tire.

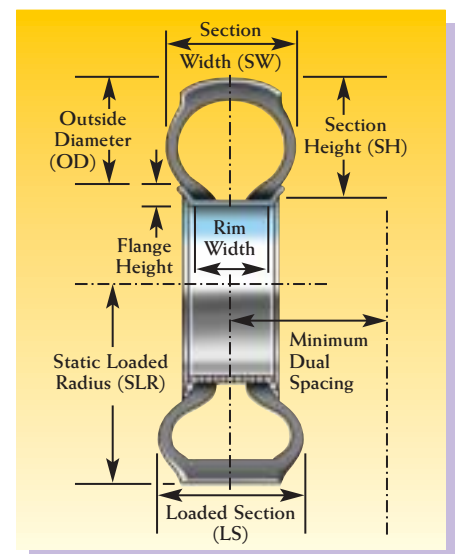

### Safety Warning

Serious Injury May Result From:

- Tire failure due to underinflation/overloading/misapplication—follow tire placard instructions in vehicle. Check inflation pressure frequently with accurate gauge.
- Explosion of tire/rim assembly due to improper mounting—only specially trained persons should mount tires. When mounting tire, use safety cage and clip-on extension air hose to inflate.

## SUMMARY

The average fuel costs of a given trucking fleet are related to two factors:

- Average fleet miles per gallon
- Average fuel cost per gallon

While it seems little can be done at the present time to reduce fuel cost per gallon, there are steps that can be taken to increase average fleet miles per gallon.

The miles per gallon achieved by a given truck depends on many factors, the major ones being:

- Vehicle, Engine and Accessory Design and Maintenance
- Vehicle Operation
- Tire Selection and Maintenance
- Environmental Conditions

Major fuel-saving steps to apply to trucking operations are:

1. Use fuel-efficient high torque rise, lower RPM engines.
2. Use engine accessories with reduced horsepower requirements, such as clutch fans, synthetic lubricants, etc.
3. Use aerodynamic drag reduction devices such as flow deflectors and rounded trailer fronts and corners on tractors pulling van-type trailers. Cover open-topped trailers with a tightly-stretched tarpaulin.
4. Use radial tires in all wheel positions, trailer as well as tractor.
5. For best fuel economy, do not allow radial tires to operate below 95 PSI cold inflation pressure.
6. Do not exceed the tire's rated speed; operate truck fully loaded as much of the time as possible to increase ton-miles per gallon.



## APPENDIX Fuel Economy Test Procedures

There are three fuel economy test procedures which have been developed by the Society of Automotive Engineers (SAE) and which are currently being used by vehicle manufacturers, tire manufacturers, and by some fleet owners. These offer a standardized method to evaluate either a complete vehicle or a component. Consideration has been given to the effects of environmental conditions (such as those described in Section 4), and their effect on fuel economy results. This is accomplished by requiring the use of a control vehicle which is run simultaneously with the test vehicle. Environmental conditions should affect both vehicles in a similar manner so that for a set of tests, the ratio of either the fuel used or the MPG of the test and control vehicles should be relatively constant even though the actual values of either the fuel used or the MPG may vary from test to test.

A brief description of each procedure is listed along with some of their important requirements.

### A. SAE Type I

The SAE Type I procedure is best used to evaluate a component which can be easily switched from one vehicle to another.

The procedure requires two vehicles of the same specification; these are run simultaneously and are identified as vehicles "A" and "B."

The minimum mileage required for one complete test cycle is 200 miles. This is composed of a 100 mile round trip with the test component on vehicle "B" and then another 100 mile round trip with the test component on vehicle "A." Since a round trip must start and finish at the same location, the minimum length of the outbound and inbound test leg is 50 miles.

On the outbound test leg vehicle "A" leads vehicle "B" (approximately 200 - 250 yard separation). At a point halfway through this test leg (approx. 25 miles) vehicle "A" slows down to allow vehicle "B" to take the lead. At the completion of the outbound leg, fuel tanks are weighed or fuel meter readings are recorded. On the inbound test leg, vehicle "B" leads "A" (same separation distance as outbound leg). Also at a point halfway through the test leg "B" slows down to allow "A" to take the lead. Upon completion, fuel is weighed or meters recorded. The test component is then switched between vehicles and another round trip is made.

The amount of fuel used by vehicles "A" and "B" when they are operating with the test component is compared to that used by both vehicles without the test component.

Test speed — as required  
Vehicle loads — within five percent of each other

Vehicle warm-up — representative of fleet operation or not less than 45 minutes at test speed

### B. SAE Type II

The SAE Type II procedure is best used to evaluate a component which requires a substantial amount of time for removal and replacement.

This procedure also requires two vehicles, though they do not have to be of the same specification. The vehicles are identified as "C" and "T." Vehicle "C" is the control vehicle and as such is not modified during the course of the test; vehicle "T" is the test vehicle which is used to evaluate the test component.

The minimum mileage for a complete test is 240 miles. This is composed of three valid test runs of 40 miles (minimum) each with vehicle "T" running a baseline component (control component) and then three valid test runs of 40 miles (minimum) each with vehicle "T" running the test component. Vehicle "T" starts off first; after approximately 5 minutes vehicle "C" begins its run. The test run starts and finishes at the same location.

For each test run the amount of fuel used by vehicle "T" is compared to that used by vehicle "C" in the form of a T/C ratio—the quantity of fuel used by vehicle "T" divided by the quantity of fuel used by vehicle "C." To be considered valid test runs, three T/C ratios within a two percent band must be obtained. This may require one or more additional test runs.

Test speed — as required  
Vehicle loads — not required to be the same

Vehicle warm-up — minimum of one hour at test speed  
Test run time — elapsed time of the test runs must be within .5%



## C. SAE Engineering Type

The SAE Engineering Type test provides standardized procedures to evaluate fuel economy for different modes of operation, such as Long Haul Cycle, Short Haul Cycle, Local Cycle, and Transit Cycle.

This procedure is more controlled than either the Type I or II tests both in terms of test site conditions and test procedures. The effect of this is reflected in greater repeatability. This procedure is best run on a test track.

The procedure requires two vehicles preferably of the same specification. The vehicles are identified as "C" and "T." Vehicle "C" is the control vehicle and is not modified during the course of the test. Vehicle "T" is the test vehicle which is used to evaluate the test component.

### Long Haul Cycle:

The minimum mileage for a complete test is 180 miles. This is composed of three valid 30 mile test runs with vehicle "T" running the baseline component (control component) and three valid test runs with "T" running the test component. The start time of the vehicles should be staggered such that they don't aerodynamically interfere with each other. Halfway through each test run (15 miles) the vehicles are to come to a complete stop, idle for one minute and then accelerate back to the test speed. A test run starts and finishes at the same location. If this procedure is not run on a track it can be handled by running 15 miles outbound and 15 miles inbound.

For each test run a T/C ratio is obtained. This is the MPG of vehicle "T" divided by the MPG of vehicle "C." A test is considered valid if for the three runs (or more) the spread of T/C ratios doesn't exceed three percent of the mean value.

Test speed	— 55 MPH
Vehicle loads	— as required
Ambient temperature	— 60 to 80°
Wind velocity	— average wind speed not to exceed 15 MPH
Vehicle warm-up	— minimum of 1 hour at 55 MPH

## Tire Repairs

High loads, speeds and tire operating pressures place critical importance on tire maintenance practices. Tire repair is an integral part of maintaining radial tires to achieve the maximum in performance and value. Because of this, personnel should be adequately trained in repair procedures and techniques, and only the highest quality repair materials should be used.



Tire repairs normally made by fleet operators and tire service centers are limited to simple punctures such as nail holes. Anything more extensive, such as spot, reinforcement, or section repairs should be referred to an authorized full service Goodyear retreading and repair facility.

Significant cuts and cracks in the sidewall area should be spot repaired as soon as possible to prevent the need for a major section repair. Frequent tire inspection in service is recommended.

This section gives information concerning tire damage, extent, and location, to help determine whether or not section repairs are feasible.

The cutaway view of the Unisteel tire in **Figure 10.1** shows the construction typical of Goodyear radial truck tires. The single radial ply of steel cord as well as the four steel cord belt plies are evident.



*Figure 10.1* Cutaway View of Unisteel Tire



## NAIL HOLE REPAIR PROCEDURES

Radial tire nail hole repairs up to 3/8-inch diameter (9.5 mm) may be made in the tread face as long as the nail hole is at least one-inch inside the shoulder. All injuries outside this point should be treated as a section repair.

### RADIAL ONLY



Figure 10.2 Any number of repairs in the approved crown area only tread minus outer 1" area (use outer grooves as a guide). Refer larger injuries to a full service repair shop. Do not overlap patches.



Figure 10.4 Beads in relaxed position. Using a carbide cutter, drill the injury from the inside to clean and prepare the injury for the plug.



Figure 10.6 Brush chemical cure cement on nozzle and insert into the hole while turning clockwise.



Figure 10.3 Dismount tire. Remove puncturing object. Using a probing awl, determine the size and extent of injury, and angle of penetration. Thoroughly inspect the inside of the tire for additional damage. Clean area to be repaired inside of tire with scraper and pre-buff cleaner.



Figure 10.5 Apply a coating of chemical cure cement to the leading 1/3 of the cured plug. Remove the end of the plug insertion tool and insert the plug into the nose piece. Do not contaminate the plug or cross thread the nose piece.



Figure 10.7 Apply air pressure (80 psi) to top of gun. This presses the plug through the nozzle into and through the injury. Remove the gun while turning in a clockwise direction.

If a pull-through plug is used, insert the plug into the wire puller, apply chemical vulcanizing cement to the leading 1/3 of the cured plug and pull through the injury from the inside of the tire.



Figure 10.8 Cut excess plug 1/16" above the liner surface on the inside. Do not stretch plug.



Figure 10.10 If using a chemical cure repair patch, cement the back of the patch and the buffed liner with chemical vulcanizing cement. If using a "Versacure" type repair patch, cement the buffed liner only. Thoroughly cover the cemented areas with a light, even coat. Allow proper drying time before applying the repair patch.



Figure 10.9 If necessary, repeat the liner cleaning procedure with pre-buff cleaner. Using a low-speed grinder, buff the liner to an RMA1 texture finish. Then vacuum to remove dust and debris.



Figure 10.11 Place beads in a relaxed position. Center the patch over the plug and stitch the patch from the center out. Directional arrows on the patch must be properly aligned, after stitching is complete. Apply a coat of butyl liner repair sealer to the patch edges and the over buffed liner. Trim the excess plug no more than 1/8" above the outside tread surface.

\*When using chemical cure MCX series patches, use chemical vulcanizing solution on the buffed liner and back of repair patch for heat and non-heat applications.



## RADIAL SECTION REPAIR LIMITS IN SIDEWALL AND SHOULDER AREA

Most sidewall injuries will be the split-type, caused by snags and punctures. Maximum injury sizes for sidewall and shoulder repairs are shown below.

The number of these section repairs should be limited to 2 per tire for line haul service and 3 for city service with a maximum of 2 repairs per any 90 degree quadrant of the tire as long as repair patches do not overlap and the same ply wires are not affected by more than one injury.

Spot repairs may be made without limit providing that the body plies are not exposed or damaged. Existing repairs must be reworked if loose or questionable.

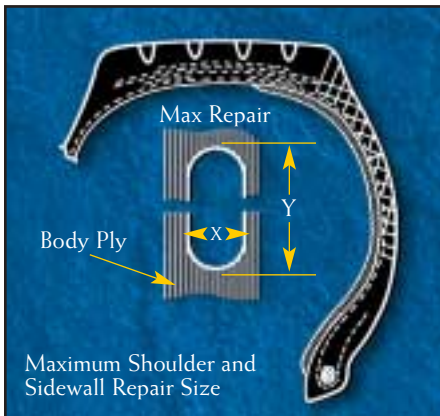

Figure 10.12

Casing Size (b)	Maximum Injury Size	
	(X) Width	(Y) Length
10.00R20/22	Cable	1-1/2
11.00R20/22	1/8	3-3/4
11R22.5/24.5		
12R22.5	3/8	5
285/75R24.5		
295/75R22.5	1/2	5
15R22.5	3/4	5
16.5R22.5		
18R22.5	1	4

Figure 10.13

### NOTE

Wire must be sound and free of rust. Maximum shoulder and sidewall injury for typical line haul medium truck tire is 1" wide (circumferentially) x 4" long (radially). See authorized Goodyear full service repair facility for other appropriate limits.



Figure 10.14



Figure 10.15



Figure 10.16



### APPLICATION OF CENTER-OVER-INJURY SECTION REPAIRS

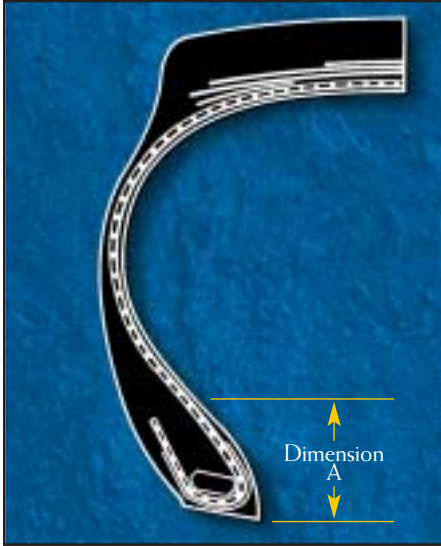

Figure 10.17

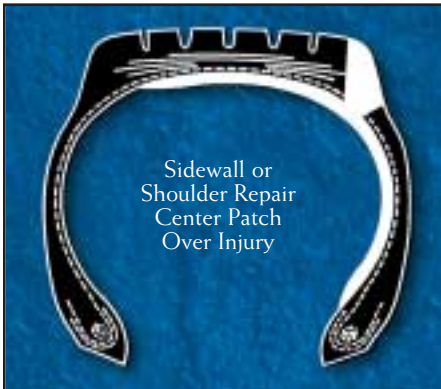

Figure 10.18



Figure 10.19

### RADIAL PLY TIRES

#### Non-Repairable Areas

Tire Size	Dimension A
All "LT" Tires	2-1/2"
8.25R, 9.00R, 10.00R	3"
9R, 10R, 11R	3"
16.5, 18R22.5	3"
285, 295, 305,	
315/75R, 80R, 85R	3"
11.00R, 12.00R	3-1/2"
12R, 13R/FR20	3-1/2"
12/80R, 13/80R, 14/80R	3-1/2"

Figure 10.20



Figure 10.21

### CROWN REPAIR LIMITS

Injuries up to 1-1/2" diameter may be repaired in line haul and city service radials depending on tire size.

Radial mileage tires used in city bus service only may be repaired up to 1" diameter. See authorized Goodyear full service repair facility for other appropriate limits.

# Retreading

The purpose of this Recommended Practice is to provide guidelines for the evaluation and selection of a retread supplier for truck tires.



## INTRODUCTION

Tire retreading is a manufacturing process. Therefore, any retreaded tire is only as good as the workmanship and the quality control in the plant that manufactured it. To thoroughly evaluate a retread supplier, one must look at both the product and service. For these reasons, a plant visit is important in the selection of a retreader.

## PLANNING A RETREAD PLANT VISIT

Prior to a plant visit, a few items should be considered. These may affect whether the retreader in question qualifies as a prospective supplier. These considerations include:

1. Does the retreader use quality products and procedures from a quality tread rubber manufacturer providing assistance to the retreader, ie:
  - a. Production associate training
  - b. Q.A. & technical assistance
  - c. Plant certification
2. Does the retreader offer any of the following services you may need?
  - a. Pick-up and delivery of tires
  - b. Flat repair
  - c. National account program
  - d. Tire mounting and demounting
  - e. 24-hour road service
3. Is the retreader making repairs:
  - a. To both bias and radial casings?
  - b. To all types and levels of tire injuries: spot repairs, bead repairs, reinforcements, and section repairs?
4. What is the retreader's turn-around time? Seven day turn-around is typical.
5. Does the retreader define warranty

policy on both retreading and repairs?  
Is there any casing warranty?

When the retreader has satisfied that it can meet the needs in these areas, a visit to the plant for an evaluation of work methods and quality procedures is invaluable.

A plant inspection is divided into eight areas of concern. They are in an order that should be convenient for a tour of the plant. Many of the questions raised will not have absolute or totally objective answers. Judgment, and the retreader's response to questions, will provide the answers needed to rate any individual retread plant.

It is suggested to reproduce the sections listed under "Plant Inspection" in this Recommended Practice for use in discussion with the retreader and its employees, and also reproduce the "Retread Plant Inspection Checklist" appearing at the end of this Recommended Practice to use during a retread plant visit. The checklist provides space to rate each item checked.

## PLANT INSPECTION

### Plant Image

1. Overall plant appearance should be clean and orderly.
2. The plant must have adequate layout and space for effective handling of tires.
3. The facility should be well lighted and adequately ventilated.
4. The retread plant must have production capacity to handle your service needs.
5. The retread plant should be inspected and certified by an industry association or supplier.

### Casing Inspection

The inspector's job is to determine whether the used tire is retreadable as presented. If not, the inspector will usually make recommendations as to the disposition of the used tire: scrap; repair and then retread; return to the customer for adjustment consideration, etc. The ability to analyze worn and damaged tires is a skill usually acquired through experience and also requires a working knowledge of all the various steps of the retread process. Look for an experienced person in this position.

1. Inspection area must be well lighted.
2. Tires must be dry before being inspected.
3. Check to see whether the retreader is using any electronic, ultrasonic, or other "high-tech" inspection equipment.
4. Check the retreader's system of tracking casings in process to ensure that all of your casings get back to you and that they are returned on schedule.



**Casing Repairing**

The repair person's job is to make structural repairs to damaged areas of the casing so the casing will be sound enough to last through a new tread life.

1. A separate, clean, well lighted area should be used for the repair area.
2. Wall charts should be posted showing procedures, patch usage, cure times, etc. Retreaders' recommendations and procedures must be followed.
3. Repair materials must have current manufacture date codes or expiration date codes. Most repair materials have a shelf life and, ideally, should be stored in a cool, dry place.
4. All repair materials, cements, and supplies should be from the same manufacturer. It is a questionable practice to mix brands since not all products are compatible.
5. The retreader should identify repairs. (Retread plant name, date of repair, etc.)
6. Check to see that the repair shop is using the proper RPM hand buffing tools.
  - a. A high RPM grinder is used for grinding steel.
  - b. A low speed grinder is used on rubber. Use of a higher RPM tool will scorch the rubber, reducing adhesion. (Gummy rubber build-up on buffing rasp and smoke generated at the buffed surface are indications of scorching.)

**Buffing**

The buffing operation is used to size, shape, and texturize the crown of the casing in preparation for the application of a new tread.

1. All casings must be buffed to a predetermined:
  - a. Crown width
  - b. Crown radius
  - c. Specified remaining undertread
  - d. Symmetrical profile
  - e. Diameter and bead to bead dimensions in mold cure systems
2. Buffers should be computer or template controlled. Buffer operators should not override computer programs or templates.
3. Wall charts, or other ready references, should be in use to determine the correct specification for each tire as referred to above.
4. All exposed cords (fabric or steel) must be "finished" to remove all fuzz and frayed ends.
5. All exposed cords (fabric or steel) should be coated with cement or other similar treatment promptly after completion of the buffing process. Steel cords must be coated within 15 minutes.
6. All untexturized areas such as tread grooves and irregular wear spots must be hand-treated to remove oxidation and surface dirt.
7. Buffing rasps should not be smoking excessively. This would be an indication of scorching and will result in poor adhesion.
8. Buff texture must be consistent with Rubber Manufacturers Association [www.rma.com](http://www.rma.com) guidelines. See the RMA buffed texture chart.
9. Buffed tires must be handled in such a way as to ensure the buffed surface is not contaminated.

**After Buff Preparation**

Items listed in this category include a number of interim steps between the major operations of buffing and tread application. Depending upon individual retread plant procedures, these steps might be performed individually, or as part of the repairing, buffing, or tread application steps.

1. An after-buff inspection should be performed to ensure the buffing process has not uncovered any previously unnoticed defects.
2. All holes, cuts, and penetrations must be probed to determine the severity of the injury and to ensure that all foreign material has been removed.
3. Buzz-out/skive-out. Note that this is the single most neglected or mishandled detail and one of the major causes of retread failures. All dirt, rust, and foreign material must be removed; all separated and/or laminated rubber must be removed – leaving a clean, solid surface for the filler material to adhere to. Any buzz-out that exceeds the specified limits must be treated as a section repair.
4. Tires must be measured for proper mold fit or tread length in the case of some pre-cure methods.
5. Cement is used to enhance the adhesion between the new tread and the prepared casing.
  - a. The tire should be clean before cementing.
  - b. Adequate drying time must be allowed prior to tread application.
  - c. Cement container must be protected from air supply line moisture and oil contamination.
  - d. Check manufacturer's date code or expiration date on cement container. Cements have a shelf life and must be kept fresh.
  - e. The "in use" cement container must be kept mixed while being used to eliminate the possibility of solid settling out from the mixture.

**Tread Application**

Tread application is the fitting of new tread rubber (which will become the new tread) onto the prepared casing. This rubber must be the correct width and thickness. It must be centered and it must be circumferentially consistent.

1. All buzz-outs should be filled flush with the buffed surface.
2. All exposed cord (fabric or steel) should be covered with cushion gum before the tread rubber is applied.
3. Check to see what brand, product line, and grade of tread rubber is being used. It is the retreader's responsibility to notify his customers if this specification is changed.
4. Raw materials (tread rubber, cushion, etc.) must be fresh. Check the manufacturer's date code or expiration date code on the container, and ideally, it should be stored in a cool, dry area.
5. With pre-cure treads there should be no more than two splices per tire. Observe the procedures and materials used for making tread splices for quality.
6. Short tread pieces (18" or less) should not be used to make splices.
7. With pre-cure tread application, "stitching" must be performed in such a way as to eliminate trapped air pockets.
8. Adhesive surfaces of tread rubber and cushion, and the buffed surface of the tire, must be kept free of contamination from hands and other sources.

**Curing**

There are two popular cure systems:

1. *Mold Cure.* Tread rubber is applied to the tire uncured. The prepared tire is placed in a mold (matrix) which imprints the tread pattern as the rubber is cured directly on the casing.
2. *Pre-Cure.* The previously cured tread rubber, with the tread design already formed, is applied to the tire with a thin layer of uncured cushion gum on its base to serve as an adhesive. The assembly is then placed in a heated, pressurized chamber where the cushion gum is cured to both the tread rubber and the casing, forming the bond between the two.
3. Time, temperature, and pressure are the three requirements of any retread cure system. Increasing or decreasing any of these factors from an optimum level will affect such things as tread adhesion, mileage, and casing life. The optimum time/temperature specification is determined by completing a thermocouple test in that particular curing equipment.
  - a. Check to see if the retreader has had thermocouple tests made in his equipment.
  - b. Ask to see what control systems or procedures are used to ensure that all tires are cured at the correct temperature, pressure, and time period.
4. All envelopes, diaphragms, and curing tubes must be leak free.
5. Check for steam and air leaks which may contribute to improper cure.
6. Tires must be stored in such a manner as to avoid distortion of the tread and/or casing before curing and immediately after.
7. Wicking material used with pre-cure systems must not be stapled into the tire sidewall or bead. Sidewalls and beads are not designed to accept

staples. Staples may penetrate the tubeless liner, creating air leaks. Holes from staples can allow moisture to enter and create rusting of the steel body in steel cord tires.

**Final Inspection & Finish**

After curing, a final inspection should be made of the finished retread. At this time, the finished tire may be trimmed of rubber flashing or overflow, painted, and tagged for delivery.

1. The inspection area must be well lighted.
2. The tire must be inspected on a spreader.
3. It is recommended that tires be inspected immediately after completion of the cure cycle, while still hot. Separations and other flaws that are visible while hot may disappear as the tire cools.
4. The inside of the tire must be inspected to ensure that all patches are properly bonded and that no bubbles, dimples, or buckles are evident in the patch or tire liner.
5. The outside of the tire should be inspected for appearance.
6. All staples must be removed from precure tread splices and wicking material.
7. Check to see that the DOT identification number has been applied to the tire. Ideally, the DOT number should be located away from the bulge width of the tire so it will not be scuffed off in service.
8. All rejected returned-as-received (RAR) casings should have the rejection cause marked on the tire with the area of injury clearly identified.
9. Finished retreads should be painted and all crayon marks should be painted over to give the final product an appealing appearance.

## DEFINITIONS

**Base Width** – A measurement of that portion of the tread rubber that joins to the buffed surface of the worn tire.

**Beads** – The anchoring part of the tire that is shaped to fit the rim. Made of high tensile steel wires wrapped and reinforced by the plies.

**Bead Sealing Area** – The flat area and heel area of the bead that contacts the rim. With tubeless tires, the bead area seals to the rim and rim flange to retain air.

**Belted Bias Tires** – Tires constructed so the ply cords extend from bead to bead and are laid at alternate angles substantially less than 90° to the centerline of the tread. On top of the body plies are two or more belt plies extending approximately from shoulder to shoulder running circumferentially around the tire at alternate angles.

**Bias Ply Tires** – Tires constructed so the ply cords extend from bead to bead and are laid at alternate angles substantially less than 90° to the centerline of the tread.

**Body Plies** – Layers of rubber-coated parallel cords extending from bead to bead.

**Breaks (Cracks)** – A surface opening extending into or through the plies.

**Flex Breaks** – A break into or through one or more plies, usually parallel to the beads.

**Impact Breaks** – A star- or X-shaped or diagonal break into or through plies, usually visible from the inside of the tire.

**Radial Crack** – A crack in the outer surface of the tire, usually in the sidewall area proceeding perpendicular towards the bead.

**Tread Cracks (Channel or Groove)** – Cracks in the base of the tread grooves or voids.

**Buckled** – Any gross distortion of the tire body or tread area evidenced by wrinkling on the inside of the casing.

**Buffed Contour** – The shape of the buffed tire that usually includes a specified radius and width.

**Buffed Radius** – A measure of the buffed surface curvature from shoulder to shoulder.

**Buffed Texture** – That surface produced by buffing, rasping, or cutting as defined by The Rubber Manufacturers Association, "Buffed Textures" (*RMA Shop Bulletin No. 29, www.rma.org*).

**Casing** – The complete tire structure.

**Cement** – An adhesive compound used to provide building tack. May be brushed or sprayed on the buffed surface.

**Check Template** – A precut pattern used to determine the contour of a buffed tire to check compatibility to a matrix.

**Cords** – The individual strands forming the plies in a tire.

**Cross Section** – The section width of a tire casing.

**Cure** – The process of vulcanization of rubber by applying heat and pressure for a specified time.

**Curing Tubes** – Special tubes placed within the tire while curing.

**Diaphragm** – A flexible sheet used to encompass part or all of a tire during

retreading in some processes.

**Gauge** – Thickness, usually expressed in thirty-seconds of an inch, by the decimal system, or in millimeters in the metric system.

**Injuries** – A break or cut of any shape caused by a penetrating object or severe scuff or impact.

**Injury Size** – Widest opening in the cord body after skiving and buffing.

**Inner Liner** – The tubeless tire inner surface used to retain the inflation media.

**Kinked (Beads)** – A sharp permanent bend in the bead wires at one or more points around the circumference of the bead.

**Load Range** – Specified as a letter (A, B, C, etc.) to identify a given size tire with its load and inflation limits when used in a specific type of service as defined in Tire and Rim Association, Inc. (or equivalent) yearbooks.

**Matrix** – Aluminum, rubber, or steel rings or segments that form the cavity in which a tire retread is cured and with which the tread design is formed.

**Nail Hole** – A penetration caused by a small, sharp object, 3/8 inch maximum diameter.

**Outside Steam Bag** – A flexible bag, usually reinforced, used to encompass the tread and tire shoulders of a tire being retreaded or repaired.

**Ply** – Layers of rubber-coated parallel cords.



**Protector Ply** – A ply added primarily for casing protection which in some cases may be removed during retreading.

**Radial Tire** – A tire that has ply cords from bead to bead extending at about 90° to the centerline of the tread. On top of the body plies are two or more belt plies of rubber-coated cords extending approximately from shoulder to shoulder and running circumferentially around the tire at alternate angles at substantially less than the ply cord angle.

**Reinforcement (Repair)** – Any material, usually rubber and fabric, vulcanized to a tire to add strength to the tire cord body at an injury. Repairs to over 25% of plies usually require reinforcement. Repairs of more than 75% of plies are usually called section repairs.

**Repair Material** – Any rubber compound or patch material used to make repairs.

**Repairing** – Reconditioning of portions of tires injured by punctures, cuts, breaks, cracks, etc. These repairs restore strength for additional safe service (See *Reinforcement, Spot, Sections, Nail Holes*).

#### **Retreading (Recapping)**

**Full Treading** – Replacement of the worn tread with rubber extending over the shoulders.

**Top Treading** – Replacement of the worn tread area only.

**Bead-To-Bead Retreading** – Replacement of the worn tread area and sidewall rubber extending to the bead.

**Precured Tread Retreading** – Replacement of the worn tread areas with pre-vulcanized treads containing the tread design already cured in.

**Sections** – Reinforced repairs made to a casing where an injury larger than a nail hole extends through more than 75% of the plies or through the casing in the tread or sidewall areas.

**Separation** – Lack of adhesion or cohesion between any adjacent materials in a tire.

**Tread Separation** – Pulling away of the tread from the tire body.

**Retread Separation** – A separation between the tread rubber and the buffed tire casing.

**Ply Separation** – A separation between adjacent layers of cords (plies).

**Bead Separation** – A breakdown of the bond between components in the bead area.

**Belt Edge Separation** – A breakdown of the bond between components near the edge of the belt plies.

**Shoulder** – The upper sidewall areas of the tire casing immediately adjacent to the tread area.

**Sidewall** – That portion of the tire casing between the tread and bead.

**Skive** – Removal of damaged material prior to making a repair.

**Splices** – A junction of the ends of any tire components.

**Spot (Repair)** – The replacement of rubber only in an injury that penetrated to no more than 25% of the body plies in a radial tire. Rubber replacement only.

**Stitching** – A method used to both remove trapped air and improve rubber contact for better adhesion.

**Synthetic Rubber** – Man-made rubber.

**Texture** – (See *Buffed Texture*)

**Tread** – That portion of a tire that comes in contact with the road.

**Tread Design** – The non-skid pattern or design on the tread of a tire.

**Tread Grooves** – The space between two adjacent tread ribs, lugs, or bars.

**Undertread (Replacement)** – The rubber between the base of the tread groove and the buffed surface.

**Vulcanization** – A chemical reaction which takes place under appropriate time, temperature and pressure and develops desirable characteristics and properties. (See *Cure*)

**Weather Checking** – Tire sidewall surface crazing or cracking attributable to aging and atmospheric conditions rather than to flexing.

**Wicking** – A capillary action caused by fabrics or cords that allows air to escape from the tire casing or from under an envelope.

## RETREAD PLANT INSPECTION CHECKLIST

PLANT: \_\_\_\_\_ DATE: \_\_\_\_\_

INSPECTOR(S): \_\_\_\_\_

	<u>ACCEPTABLE</u>	<u>NOT ACCEPTABLE</u>	<u>COMMENTS</u>
<b>Plant Image</b>			
A. Appearance	_____	_____	_____
B. Space and layout	_____	_____	_____
C. Lighting	_____	_____	_____
D. Ventilation	_____	_____	_____
E. Production capacity	_____	_____	_____
F. Outside certification	_____	_____	_____
G. Material storage	_____	_____	_____
H. Evidence of training	_____	_____	_____
<b>Casing Inspection</b>			
A. Lighting	_____	_____	_____
B. Dry casings	_____	_____	_____
C. Repairs removed	_____	_____	_____
D. Casing I.D./tracking	_____	_____	_____
<b>Casing Repairing</b>			
A. Location and lighting	_____	_____	_____
B. Repair information/procedures	_____	_____	_____
C. Material shelf life dates	_____	_____	_____
D. Material storage	_____	_____	_____
E. Single brand materials	_____	_____	_____
F. Repair I.D.	_____	_____	_____
G. Tool RPMs	_____	_____	_____
<b>Buffing</b>			
A. Buffed dimensions, profile	_____	_____	_____
B. Specification information	_____	_____	_____
C. Exposed cords finished	_____	_____	_____
D. Exposed cords cementing	_____	_____	_____
E. Texturize unbuffed areas	_____	_____	_____
F. Mold fit measurement	_____	_____	_____
G. Rasp condition/smoking	_____	_____	_____
H. Buff texture	_____	_____	_____
I. Handling, cleanliness	_____	_____	_____

	<u>ACCEPTABLE</u>	<u>NOT ACCEPTABLE</u>	<u>COMMENTS</u>
<b>After-Buff Preparation</b>			
A. Holes/cuts probed	_____	_____	_____
B. Buzz-out limits	_____	_____	_____
– Bias	_____	_____	_____
– Radial	_____	_____	_____
C. Cement application	_____	_____	_____
D. Cement dry time	_____	_____	_____
E. Cement shelf life	_____	_____	_____
<b>Tread Application</b>			
A. Buzz-outs filled	_____	_____	_____
B. Tread rubber manufacturer brand/grade	_____	_____	_____
C. Spliced tread rubber	_____	_____	_____
– 2 splices maximum	_____	_____	_____
– minimum 120° spacing	_____	_____	_____
D. Handling/cleanliness	_____	_____	_____
<b>Curing</b>			
A. Thermocouple tests	_____	_____	_____
B. Controls: pressure, temperature, and time	_____	_____	_____
C. Air/steam leaks	_____	_____	_____
D. Tire storage–distortion free	_____	_____	_____
E. Staples in tread of tire only	_____	_____	_____
<b>Final Inspection</b>			
A. Lighting	_____	_____	_____
B. Inspect on spreader	_____	_____	_____
C. Inspect hot	_____	_____	_____
D. Staples removed	_____	_____	_____
E. DOT serial number	_____	_____	_____
F. RAR identification	_____	_____	_____



## Miscellaneous

The following section explains the use of chains on radial truck tires. Chain use is designed to offer additional traction, providing the chains and tires are matched appropriately for size and fit. General precautions to tire siping, dynamometer testing and mixing radial and bias ply tires are also addressed. Finally, this section explains the variances in sound levels produced by radial truck tires, and the conditions under which truck noise occurs.

## USE OF CHAINS ON RADIAL TRUCK TIRES

The use of tire chains can be helpful in providing additional traction in severe weather conditions (such as ice and heavy snow) especially when traveling in hilly or mountainous terrain. Tire chains can be used safely and successfully with Goodyear radial truck tires provided several simple and important points are followed.

Always select chains that are specifically designed for radial tires. These chains normally have shorter cross chains than older designs and allow the position of the side chains to be higher on the tire sidewall. This is out of the high-flex sidewall area of a radial tire and results in less susceptibility to sidewall damage.

Be sure to use the proper chain size for the tire on which it is being attached. Tighten chains when they are first applied, then after a short run-in period, readjust to ensure a continued snug fit on radial tires. Serious sidewall damage may result from loose chains.

Check for adequate dual spacing, especially if using single tire chains on each tire of a dual assembly. The greater deflection of the radial tire may require more dual spacing in marginally-spaced dual assemblies.

Finally, always remove chains as soon as they are no longer needed.

## TIRE SIPING

Tire siping is a process of making small knife-like slits in the tread rubber surface. Normally this is accomplished by a machine that uses sharp, highspeed rotating discs to make cuts that are at an angle of 90° to the circumference of the tread. Siping cuts are normally controlled so they are spaced a specific distance apart from one another. They also will vary in depth across the tread face.

Proponents of tread siping have claimed various performance improvements for truck tires. These claims include improved treadwear and reduced irregular wear.

Also, it is often claimed that siping improves traction for winter and wet driving conditions on certain road types.

At present, the majority of truck tire siping is done in the westernmost Midwest states and the Northwest corridor. It is popular in certain areas, and especially during the winter months, to sipe both steer and drive, and sometimes trailer tires.

Goodyear's position on siping is that it may, under certain operating conditions, improve tire performance. However, under the vast majority of truck operating conditions, new tires are designed and produced with tread patterns and tread compounds that do not require tread siping to give satisfactory performance.

Actual testing indicates that siping may improve the tire's resistance to irregular wear on free-rolling wheel positions that are susceptible to irregular wear due to the combination of operating service and tire application. Specifically, siping may help reduce irregular wear on trailer axles where light, one-way loads are encountered, such as grain trailers or belly dumps that operate under extreme load variations from unloaded to loaded conditions.

On the other hand, siping is generally believed to detract from treadwear on lug type tires used on drive-wheel position. This is because siping tends to break up the tread pattern and cause increased bending of the tread elements. This results in faster wear due to increased scuffing as the tire goes through its footprint under torque.

The effect tread siping has on tire performance can vary considerably with the particular tire pattern being siped. For example, in a heavily bladed tread pattern it is believed that siping in the original tread state could hurt treadwear. Other tread patterns, such as those having a much higher net-to-gross footprint area, might be more adaptable for siping under the service conditions discussed earlier.

If a customer chooses to sipe his Goodyear tires, we strongly recommend that he pay close attention to the type of siping used. Specifically, our experience is that siping should be performed laterally across the tread, although angles that vary somewhat from this might also be acceptable. However, to the best of our knowledge, siping that is more or less circumferential has not been demonstrated to be successful. Also, our experience shows that siping with varying depth across the face of the tread usually yields better results than constant depth siping. This also appears to provide the minimum risk for increasing the tire's susceptibility to tread rubber chunking.

It is important to note that the Goodyear warranty provides protection for the user against failures from workmanship or material conditions. If a tire failure occurs because of a condition beyond Goodyear's control, such as siping, the warranty is null and void.

## DYNAMOMETER TESTS

In recent years, a number of retread rubber manufacturers have produced precure tread rubber that is siped when molded. Various claims of improved treadwear, fuel economy, etc, have been made. Our experience indicates that while these claims may be true in specific instances, it is largely a matter of siping the tread in such a way that is compatible with the particular tread rubber compound and tread pattern design being used. In other words, if tread siping is considered an integral part of the manufacture of new tread rubber at the outset, the siping can be more or less customized to the type of rubber and type of pattern so that performance can be optimized.

In summary, tire siping may have certain performance advantages in improved treadwear and/or traction; however, these can be expected to vary considerably, depending on the particular type of tread rubber, the tread pattern, and the service conditions in which the tire is used. A customer considering siping tires should consult the new tire or retread rubber manufacturer to discuss appropriate siping machinery and techniques for the individual situation.

Dynamometers are used by truck manufacturers, and frequently by truck distributors or large fleet operators, to test the engines and other parts of the driveline.

Dynamometer rolls vary in size from 8-5/8-inch to 50-inches. The smaller rolls have a greater potential for damaging the tires.

During a dynamometer check, there is little weight on the tires and only a small area of the tread face (usually the center rib or center portion of the tread) is in contact with the roll. Excessive heat builds up in this small area. If the test runs too long, the excessive heat can damage the tire to the point where it could fail later on the highway.

The maximum safe time for running tires on a dynamometer roll varies with the roll diameter, speed, the power or torque transmitted from the tire to the roll, and, to some extent, the load and inflation. **Figure 12.1** shows general rules for limiting the time for maximum power testing.

50 – 60 MPH –	Time Limit at Max Power Roll Dia
8 5/8"	3 Min
18" - 20"	5 Min
30" - 36"	10 Min
48" - 50"	15 Min

Figure 12.1

For 50 percent power, the time can be doubled. For 25 percent power, the time can be quadrupled.

## MIXING RADIAL AND BIAS PLY TIRES

Due to differences in cornering force characteristics and spring rates, the best tire and vehicle performance will be obtained by applying tires of the same size and construction (radial ply/bias ply) to all vehicle wheel positions. However, different tire constructions are permitted on the steer, drive, and trailer axles of two-axle, tandem, and multiple-axle combinations when the following rules are observed.

- Never mix different tire sizes or tire constructions on the same axle.
- If radial tires are mixed with bias tires, the best handling will be obtained with the bias tires on the steer axle.
- Bias or radial tires may be used on either axle of two-axle vehicles, providing the vehicle has dual rear wheels or is equipped with Super Single wide-base tires.
- Either bias or radial tires may be used on the steering axle of vehicles with three or more axles. Either all bias or all radial tires should be used on the nonsteering axles.
- Never mix bias and radial tires in a tandem or multiple axle combination.

Always check with the vehicle manufacturer before changing tire size or construction on any vehicle. Carefully evaluate performance changes caused by tire size or construction changes before putting the vehicle back into service.



## NOISE

Tires are one source of noise emitted by a truck operating at speeds above 35 MPH on a highway. In addition to the tires, other major sources of noise are:

- Engine
- Radiator fan
- Engine exhaust
- Engine air intake
- Driveline
- Aerodynamics (wind noise)

Noise is defined as a disagreeable sound. Pressure waves in the air produce sound. The human ear is designed to sense these pressure waves and transmit signals to the brain indicating the magnitude and characteristics of the sound.

The ear mechanism can detect very faint sounds with very low air pressure energy levels and yet can detect and withstand relatively loud sounds with high energy levels without becoming damaged. To accomplish this wide range of hearing, the ear mechanism/brain response is not directly proportional to the sound pressure, but is less sensitive at the louder end of the range.

The total noise output of a truck is usually measured with an instrument called a sound level meter. The input to the sound level meter is through a microphone that is placed nominally 50 feet from the center of the highway lane that is being monitored.

The sound level meter has electronic circuitry designed to approximate the human auditory system. Thus, the input is varying air pressure caused by the sound — through a microphone — and the output is a value indicated on a scale that gives the sound level of the noise. The sound level or more precisely, the sound pressure level, indicates the degree of loudness to the human ear of a given sound.

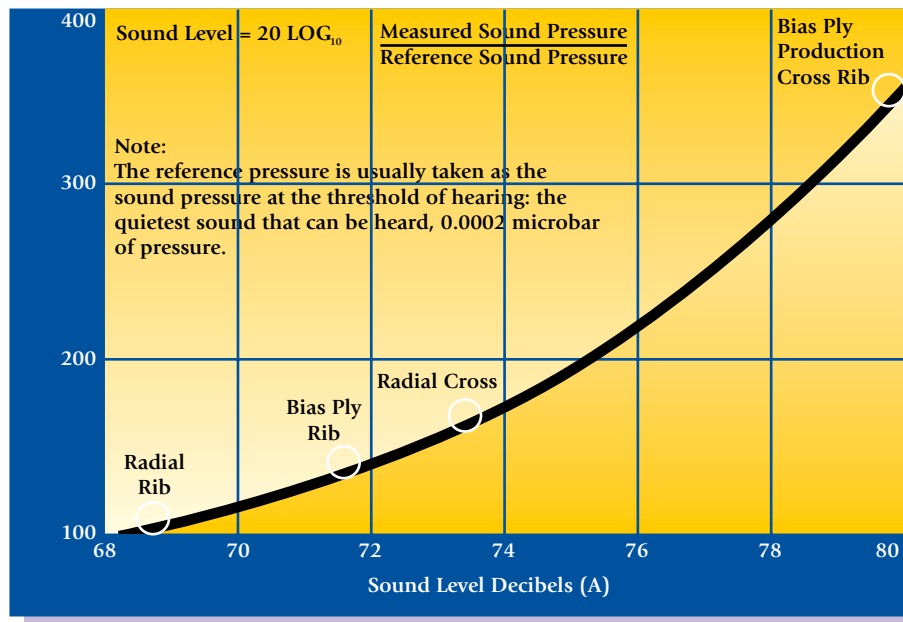

Figure 12.2 Relative sound pressure vs. sound level in dB(A) from SAE J57 tests.

Sound level units are measured in decibels, abbreviated dB. Since the human ear does not respond the same for all frequencies of sound, the sound level meter has been modified to agree closely with the frequency response of the human auditory system. When the frequency adjustments are included, the suffix (A) is added to the dB unit: dB(A).

The relationship of sound pressure to sound level in the region caused by the tires of a truck is shown in a relative fashion by the curve in Figure 12.2.

Note the relative increase in noise, going from the relatively non-aggressive radial rib tire to the bias ply rib tire; to the radial cross rib; to the bias ply cross rib tire.

Also note the nature of the curve wherein greater changes in sound pressure are required to cause a given change in sound level at the higher sound pressures than at the lower sound pressures.

The data for the curve were obtained from standard SAE J57 tests using a truck with four test tires on drive axle and two rib tires on steer axle. The test consisted of a 50-mph coast-by with microphone at 50 feet from the line of travel.

When several sources cause sound waves to impinge on the ear simultaneously, the ear perceives the sum total of sound air pressure on the ear drum; the pressures are additive. However, the sound level perceived by the overall auditory system is increased only according to the logarithmic rule demonstrated by the curve.

Therefore, when sounds are emitted by various sources in a truck, the combined effect can be obtained by adding sound pressures and then converting the total sound pressure to dB(A). If individual sources of sound have already been computed or measured in dB(A), the combinations of these sounds in terms of dB(A) cannot be obtained by addition of the individual dB(A) values.

Typical sound levels of various over-the-road truck components and the effect on total sound level of combining these noise sources are shown in Figure 12.3. The tire noise value listed assumes the use of eight bias ply cross-rib drive tires on the truck.

### Speeds Above 35 MPH – Six Predominant Noise Sources

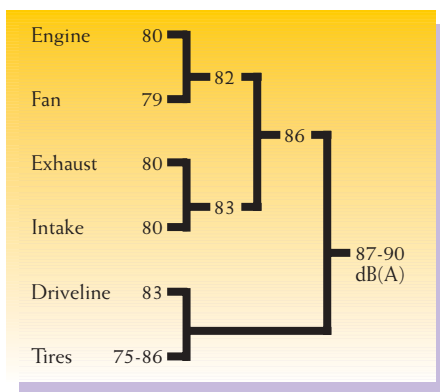

Figure 12.3 Combining noise sources.

Typical methods used to reduce truck noise to meet limits prescribed by law are as follows:

- Reduce speed
- Retrofit equipment
- Improve maintenance
- Remove irregularly worn tires
- Restrict lug tires to drive axles
- Use radial tires on all axles
- Use rib tires on all axles
- 87-90 dB(A)

Laws on noise are established by the Federal government, and are administered by the Environmental Protection Agency (EPA). Active enforcement, however, generally is the responsibility of state highway authorities.

Since the enactment of the Noise Control Act of 1972, the EPA has been empowered to issue regulations controlling the operational noise levels of interstate rail and common carriers, and the noise emissions of newly manufactured products. To do this, the EPA must identify a certain area of commercial endeavor or a certain product as a "major noise source." It then has the authority to pursue regulatory activity to control and monitor that area or product. Early on, the railroads, airports, certain manufacturing operations, and a host of other activities were identified as major noise sources in need of regulatory attention. The Agency specifically labeled medium and heavy trucks as significant sources of environmental noise and has set up standards for the testing and control of the "total vehicle noise emission package." These standards, known as the Interstate Motor Carrier Noise Emission Standards, are contained in Volume 40, Parts 202 and 205, of the Code of Federal Regulations. They have been in force since 1975, and apply to all vehicles in over-the-highway service as well as to newly manufactured vehicles. They set definite limits for total noise levels at various speeds and under stationary conditions.

The legislation for in-service interstate motor carriers requires that overall external noise levels for trucks manufactured previous to the 1986 model year not exceed the following values, measured at a distance of 50 feet from the vehicle centerline:

- 90 dB(A) on highways at speeds greater than 35 mph
- 86 dB(A) on highways at speeds of 35 mph or less
- 88 dB(A) during stationary runup at governed engine rpm

For trucks of 1986 model year manufacture and later, the standard requires that the external noise level values must not exceed:

- 87 dB(A) on highways at speeds greater than 35 mph
- 83 dB(A) on highways at speeds of 35 mph or less
- 85 dB(A) during stationary runup at governed engine rpm

New medium and heavy duty trucks (vehicles with GVWR of 10,000 lbs. or greater) must meet noise emission standards based on a vehicle acceleration and pass-by test at speeds of up to but not exceeding 35 mph. The noise measurement is taken at a distance of 50 feet from the centerline of vehicle travel, and the test is performed by the vehicle manufacturer himself and certified to the EPA. For medium and heavy duty trucks produced prior to January 1, 1988, manufacturers had to test their vehicles to a maximum external noise level of 83 dB(A). For trucks manufactured after January 1, 1988, the maximum external noise level permitted is 80 dB(A).

## TIRE STORAGE RECOMMENDATIONS

### For Tires Not Installed on Vehicles

#### 1. Oil, Solvents and Grease

Mounted or unmounted tires should never be stored on oily floors or otherwise in contact with solvents, oil or grease. Nor should tires be stored in the same or adjoining rooms with volatile solvents. These solids, liquids or vapors are readily absorbed in rubber and will damage and weaken it.

#### 2. Ozone

Mounted and unmounted tires should be stored away from electrical devices such as motors, generators, arc welders and switches because they are active sources of ozone. Ozone attacks rubber causing it to crack perpendicular to any applied stress. Such cracking exposes the new rubber surface at the base of the crack to greater stress and consequently to more severe ozone attack until eventually the cracks can penetrate to the carcass where continued rubber degradation could cause carcass failure. Minor, ozone induced, surface cracks will seldom cause tire failure, but can form an access route for foreign material to penetrate the carcass once the tire is placed in service.

#### 3. Heat and Light

Tires should be stored in a cool place, away from direct sunlight or strong artificial light. Both heat and light are sources of oxidation of the tire surfaces. The oxidation is characterized by a "crazed" or "alligatored" surface which does not penetrate the rubber deeply. The severity of the oxidation is, of course, a time- and temperature-dependent variable. Long term storage at ambient temperatures have been equated to short term storage at elevated temperatures. For instance, three days storage at 158° F causes approximately the same loss in tensile strength as three years storage at 75° F. Oxidation may cause sufficient damage to the inside of an unmounted tire as to cause early tube failure or a slow leak.

#### 4. Undue Stress in Storage

If possible, tires should be stored vertically on treads. Severely stressed and distorted tires are subject to much greater damage from solvent, ozone or oxidative attack than those which are not stressed or are stressed minimally and uniformly. Unmounted tires stacked horizontally (on sidewall) should be piled symmetrically and never so high as to cause severe distortion to the bottom tire. Tires that are mounted on rims but not on vehicles should follow the same recommendations as for unmounted tires.

#### 5. Foreign Material - Dirt, Water

Unmounted tires should be stored under a waterproof covering. Dirt is not harmful to a tire. However, dirt on the inside of a tire placed in service can cause early tube failure or a slow leak. Water on the inside of a tire in service can be turned into steam which can quickly destroy the strength of both the rubber and the textile members of the tire. Additionally, water and dirt inside a tubeless tire can cause corrosion to tubeless rims and plug tubeless valves, both a source of potential tire failure. Foreign material on the tire bead seat could affect air seal and cause air loss.

#### 6. Inflation

If tires are mounted on rims and inflated, pressure should be maintained at 10 PSI. If tires are inflated and put in storage during warm weather, the initial inflation should be about 15 PSI to offset the drop in pressure which will occur during the cold weather months.

#### 7. Protective Cover

If tires are stacked, first lay a foundation of clean wood to protect them from dirt, oil, grease, etc. Tires should be covered with an opaque or black polyethylene film. PVC or any other clear film is not satisfactory. The polyethylene film will protect against ozone generated by

electrical sources and cut down on air circulation which will minimize both the available oxygen and ozone which degrade rubber.

#### 8. Do Not Use Paint to Preserve Tires

### For Tires Installed on Vehicles

1. The storage area surface under each vehicle should be firm, reasonably level, well drained and free of all oil, fuel or grease. Clean 1/4" - 3/4" gravel under each tire is desirable if the area is not paved. Storage should not be permitted on blacktop or oil stabilized surfaces.
2. When storage longer than 6 months is anticipated, the vehicle should be blocked up so weight does not rest on the tires and inflation pressure reduced to 15 PSI. Storage of such vehicles should be under cover if possible. Otherwise, tires should be protected from elements by an opaque waterproof covering.
3. If it is not possible to block up the vehicle, inflation pressure in the tires should be increased to 25% above the inflation required for the actual load on the tire in the storage condition.
4. Vehicles should not be moved during extremely cold weather. Under moderate temperature conditions, vehicles may be moved if necessary.
5. Inflation in the tires must be adjusted to the recommended service pressure before shipping or putting a stored vehicle into service.
6. Both tires and vehicles should be used on a first-in, first-out basis to avoid excessive aging due to storage.
7. Based on varying weather conditions, if tires are stored uncovered on vehicles under load, some weathering may occur at approximately one year storage period.



## WHEN DOES THE WARRANTY END

A tire has delivered its full original tread life and this warranty ends when the tread wear indicators become visible, or five (5) years from the date of original tire manufacture or original new tire purchase date (whichever comes first).

### How Do I Know When My Tires Were Manufactured?

Tires with a Department of Transportation (DOT) number ending with 0100 or later were manufactured after 1/1/2000.

0100 is the 4-digit production date in week-week-year-year format. 0100 means the tire was produced in the 1st week of 2000. Prior to January 2000, a 3-digit date code was used following a week-week-year format. thus, 019 means the tire was produced in the 1st week of 1999.

## TIRE SEALANTS AND BALANCE MATERIALS

There are many vendors that sell aftermarket tire sealants and balance materials that can be added or pumped into a tire. Goodyear does not endorse any product, but if you wish to use such a product as either a sealant or tire balancer, the Goodyear warranty is voided if the material adversely affects the tire inner liner.

## Standards & Regulations

Both truck tire manufacturers and truck tire users are covered by a number of federal and state regulations designed to assure the safety of the motoring public. Some of the more important requirements of these regulations are discussed in the following section, including Federal Motor Carrier Safety Regulations, Commercial Vehicle Safety Alliance and regrooving/tire siping regulations.

## FEDERAL MOTOR VEHICLE SAFETY STANDARDS TESTING AND CERTIFICATION

The federal regulations which pertain to the performance and safety of truck tires fall generally into two categories. Those regulations which affect the testing, certification, and marking of newly manufactured tires are contained in Volume 49 of the Code of Federal Regulations (CFR), Part 571, and are referred to as "Federal Motor Vehicle Safety Standards." Those which cover over-the-highway usage and application are contained in Volume 49 of the same Code, but in Parts 350 through 399, and are called "Federal Motor Carrier Safety Regulations."

The differentiation between newly manufactured items and over-the-highway usage is quite clear. Thus, a tire manufacturer is concerned with complying with the Motor Vehicle Safety Standards regarding testing, certification and markings, while the owner or operator of a vehicle who is using the tires in service must be in compliance with the Motor Carrier Safety Standards in regard to the application, usage and condition of those tires.

Standard 119 makes demands beyond simply testing. For one thing, the tire must carry a serial code of up to eleven digits or characters on one sidewall indicating the name of the manufacturer, the producing plant, the tire size, the tire type (brand name, load range, sidewall description, etc.), and the week and year of production. This information becomes especially important for record keeping and recall work. For another, the tire must carry information clearly molded into the sidewall to give the consumer a variety of facts about the product, such as size, type, load range, generic names of materials, construction type, whether for single or dual usage, maximum load and inflation data, and of course the DOT symbol and serial code. The manufacturer must also include treadwear indicators evenly spaced around the circumference of the tire to indicate visually when the tire has worn to a tread depth of 2/32".

The regulations encompassed by the Federal Motor Vehicle Safety Standards for newly manufactured products are administered by the National Highway Traffic Safety Administration (NHTSA), a branch of the U. S. Department of Transportation (DOT). Those laws contained within the Federal Motor Carrier Safety Regulations are administered by the Federal Highway Administration (FHWA), also a branch of the DOT, and enforced by the Bureau of Motor Carrier Safety (BMCS), a sub-agency of the FHWA and one of the few true enforcement arms within the DOT.

Part 571.119 of Volume 49 of the Code of Federal Regulations, known as Federal Motor Vehicle Safety Standard 119 (FMVSS 119), requires that a variety of tests be performed by a tire manufacturer to certify that a specific size of a tire line meets Federal safety requirements. The main purpose of this law is to ensure tire testing and certification to specific performance parameters in the areas of endurance and strength. By randomly sampling and laboratory testing tires in this manner during production periods, a tire manufacturer certifies that his product meets the minimum safety requirements established by law. He also properly qualifies his tires to carry the "DOT" stamping on the sidewall. Since this DOT marking must appear on any tire legally sold for over-the-highway use in the U.S., it becomes essential for a manufacturer to test and certify his tires to Motor Vehicle Safety Standard 119.

The other Federal Motor Vehicle Safety Standard which effects truck tires is FMVSS 120, which spells out tire and rim selection and matching requirements for vehicle manufacturers. This standard is intended to ensure that when a consumer purchases a new vehicle, the total maximum load capacities on any axle are at least as great as the gross weight rating of that axle, so that the load carrying capacity of the tires is not exceeded so long as the vehicle is properly loaded.

### Federal Motor Carrier **SAFETY REGULATIONS**

TITLE 49 CODE OF FEDERAL REGULATIONS  
PARTS 40, 325, 383, 385, 386, 387, 390-397, 399

U.S. DEPARTMENT OF TRANSPORTATION  
FEDERAL HIGHWAY ADMINISTRATION

SEPTEMBER, 1993



American Trucking Associations

### SUBPART G — MISCELLANEOUS PARTS AND ACCESSORIES

#### §393.75 Tires.

(a) No motor vehicle shall be operated on any tire that (1) has body ply or belt material exposed through the tread or sidewall, (2) has any tread or sidewall separation, (3) is flat or has an audible leak, or (4) has a cut to the extent that the ply or belt material is exposed.

(b) Any tire on the front wheels of a bus, truck, or truck tractor shall have a tread groove pattern depth of at least 4/32 of an inch when measured at any point on a major tread groove. The measurements shall not be made where tie bars, humps, or fillets are located.

(c) Except as provided in paragraph (b) of this section, tires shall have a tread groove pattern depth of at least 2/32 of an inch when measured in a major tread groove. The measurement shall not be made where tie bars, humps or fillets are located.

(d) No bus shall be operated with regrooved, recapped or retreaded tires on the front wheels.

(e) No truck or truck tractor shall be operated with regrooved tires on the



### INSPECTION

front wheels which have a load carrying capacity equal to or greater than that of 8.25-20 8 ply-rating tires.

(f) Tire loading restrictions (except on manufactured homes). No motor vehicle (except manufactured homes, which are governed by paragraph (g) of this section) shall be operated with tires that carry a weight greater than that marked on the sidewall of the tire or, in the absence of such a marking, a weight greater than that specified for the tires in any of the publications of any of the organizations listed in Federal Motor Vehicle Safety Standard No. 119 (49 CFR 571.119, S5.1(b)) unless:

(1) The vehicle is being operated under the terms of a special permit issued by the State; and

(2) The vehicle is being operated at a reduced speed to compensate for the tire loading in excess of the manufacturer's rated capacity for the tire. In no case shall the speed exceed 80 km/hr (50 mph).

(g)(1) Tire loading restrictions for manufactured homes built before January 1, 2002. Manufactured homes that are labeled pursuant to 24 CFR 3282.362(c)(2)(i) before January 1, 2002, must not be transported on tires that are loaded more than 18 percent over the load rating marked on the sidewall of the tire or, in the absence of such a marking, more than 18 percent over the load rating specified in any of the publications of any of the organizations listed in FMVSS No. 119 (49 CFR 571.119, S5.1(b)). Manufactured homes labeled before January 1, 2002, transported on tires overloaded by 9 percent or more must not be operated at speeds exceeding 80 km/hr (50 mph).

(2) Tire loading restrictions for manufactured homes built on or after January 1, 2002. Manufactured homes that are labeled pursuant to 24 CFR 3282.362 (c)(2)(i) on or after January 1, 2002, must not be transported on tires loaded beyond the load rating marked on the



sidewall of the tire or, in the absence of such a marking, the load rating specified in any of the publications of any of the organizations listed in FMVSS No. 119 (49 CFR 571.119, S5.1(b)).

(h) Tire inflation pressure. (1) No motor vehicle shall be operated on a tire which has a cold inflation pressure less than that specified for the load being carried.

(2) If the inflation pressure of the tire has been increased by heat because of the recent operation of the vehicle, the cold inflation pressure shall be estimated by subtracting the inflation buildup factor shown in Table 1 from the measured inflation pressure.

Table 1 — Inflation pressure measurement correction for heat

Average speed of tire in previous hour	Minimum inflation pressure buildup	
	Tires with 4,000 lbs. (1,814 kg) maximum load rating or less	Tires with over 4,000 lb. (1,814 kg) load rating
41 to 55 mph (66 to 88.5 km/hr)	5 psi (34.5 kPa)	15 psi (103.4 kPa)

A regular program of tire inspection is essential for the prevention of rapid air loss failures. At a minimum, tires should be inspected at the time of the regular preventive maintenance checks.

The Bureau of Motor Carrier Safety recommends an inspection by the driver prior to every trip in its "Truck Driver's Pre-trip Check List."

In any tire inspection routine, tires should be inspected for the following conditions. If any are found, the tire should be removed and repaired, retreaded or scrapped as the condition indicates.

- Any blister, bump or raised portion anywhere on the surface of the tire tread or sidewall (other than a bump made by a repair). These indicate the start of internal separation.
- Any cut that reaches to the belt or ply cords, or any cut that is large enough to grow in size and depth.
- Any nail or puncturing object.
- If any stone or object is held by a tread groove and is starting to drill into the tread base, remove the object.
- Look for skid spots and irregular wear conditions and refer to the chapter on alignment, irregular wear, and rotation.

The owner or operator should also be aware that the use of recapped, retreaded, or regrooved tires is restricted by the BMCS, Federal Motor Carrier Safety Regulations, and some state regulations, and that the Rubber Manufacturers Association recommends against their use in certain applications.

In addition to the routine type of common-sense, owner-performed tire inspection just described, there are mandatory inspections which involve agents and agencies of the federal government. For example, the inspection of tires for defects is required by NHTSA Vehicle In Use Inspection Standards, and by BMCS, Federal Motor Carrier Safety Regulations.

Part 396 of the Federal Motor Carrier Safety Regulations authorizes special agent personnel of the Federal Highway

## MINIMUM TREAD DEPTHS

Administration, including Bureau of Motor Safety inspectors, to perform inspections of a motor carrier's vehicles which are currently in operation. These inspections may be performed at a facility of the motor carrier (such as a terminal) or at some other location (such as on-highway) at the discretion of the inspector. The results of these inspections are recorded in a Driver-Equipment Compliance Check report. If the check is done at a location other than one of the motor carrier's facilities, the driver is required to deliver this report to the motor carrier upon his arrival at the carrier's next terminal, or to mail it to the carrier if he is not scheduled to be in a terminal within 24 hours after the time of the inspection. The motor carrier then has 15 days from the inspection date to correct any violations or defects, certify any action taken using Form MCS-63, and return the form to the BMCS office address indicated on the report.

Part 397 of the same regulation requires that for the transport of hazardous materials, vehicles equipped with duals on any axle must have the tires inspected every two hours or 100 miles, whichever occurs first, for the duration of the trip.



Minimum tread groove depths are specified for tire manufacturers under Federal Motor Vehicle Safety Standard 119, and for in-use applications by Federal Motor Carrier Safety Regulations, part 393.75. Under FMVSS 119, manufacturers must include tread depth indicators, commonly called "wear bars", in six locations evenly spaced around the circumference of a highway truck tire, so that they become visible when 2/32" of tread groove depth is remaining.

## COMMERCIAL VEHICLE SAFETY ALLIANCE (CVSA)

Under FMCSR Part 393.75, operators are required to maintain at least 4/32" of tread groove depth on the front tires of any bus, truck, or truck tractor covered by that law, and the standard 2/32" remaining tread depth on the other wheel positions.

In conjunction with the federally required tire inspections previously mentioned, much work has been done to promote commonly performed and recognized tire inspection criteria within the scope of the total vehicle inspection program in use by the Commercial Vehicle Safety Alliance (CVSA).

The CVSA is a voluntary organization made up of states and provinces which have responsibility for commercial vehicle safety operations and which perform vehicle inspections and conduct other safety related programs. The aims of the organization are to maximize the utilization of commercial vehicle, driver and cargo inspection resources, to avoid duplication of effort, to expand the number of inspections performed on a regional basis, to advance uniformity of inspection, and to minimize delays in industry schedules which could result from this type of enforcement activity.

The CVSA does not supersede or countermand any legally required inspection process or any state laws. It is simply a working agreement among member jurisdictions to use standardized procedures. It has gained widespread acceptance and has made great progress toward providing a common inspection program.

CVSA members inspect vehicles on-highway and in terminals. Areas covered by a CVSA vehicle inspection are the driver (license, hours-of-service records, medical certificate), steering mechanism, brakes, brake lights/turn signals, drawbars, suspension, fifth wheels, air loss and warning, wheels and tires. Vehicles which pass the inspection are issued a CVSA decal, colored differently for each quarter of the year, and honored for the month of issuance plus the

following two months by all participating states and provinces.

Criteria for the tire inspection portion of the CVSA inspection program recommends replacement of a tire with any of the following conditions:

### Steering Axle of Power Unit

- Less than 2/32-inch tread depth at two, adjacent, major tread grooves anywhere on the tire.
- Portion of breaker strip or casing ply visible in tread.
- Sidewall is cut, worn, or damaged thereby exposing ply cord.
- Labeled "Not for Highway Use" or other marking excluding current application (Excluding farm/off-road vehicles briefly on the road).
- Bulge suggesting tread/sidewall separation. *Exception: Bulge from section repair (sometimes identified by adjacent blue, triangular label) is not a defect unless higher than 3/8 inch.*
- Tire flat or has leak that's felt or heard.
- Mounted/inflated so tire contacts part of vehicle.
- Tire overloaded, including overload resulting from under-inflation. *Exception: Does not apply to special permit vehicle operated at a speed low enough to compensate for underinflation.*

### Drive/Trail Tires Out of Service

- 75 percent or more tread width loose or missing, in excess of 12 inches of tire's circumference.
- Less than 1/32 inch tread depth at two adjacent, major tread grooves at three separate locations on tire. With duals, both tires must have listed defect to warrant out-of-service judgement.
- Tire flat or has leak that can be felt or heard.
- Bias-ply tire with more than one ply exposed in tread area or sidewall, or when exposed area of top ply exceeds 2 square inches. With duals, both tires must have listed defect to warrant out-of-service judgement.
- Radial tire with two or more plies exposed in tread area, or damaged cords evident in sidewall or exposed area on sidewall exceeding 2 square inches. With dual, both tires must have listed defect to warrant out-of-service judgement
- Bulge suggesting tread/sidewall separation. *Exception: Bulge from section repair (sometimes identified by adjacent blue, triangular label) is not a defect unless higher than 3/8 inch.*
- Mounted or inflated so tire contacts part of vehicle or in the case of a dual assembly, its mate.
- Tire overloaded, including overload resulting from under-inflation. *Exception: Does not apply to special permit vehicle operated at a speed low enough to compensate for underinflation.*

## REGROOVING/ TIRE SIPING

Regrooving is used in certain types of service to extend the mileage obtainable from the original tire tread. Tires designed with sufficient undertread depth to permit regrooving are labeled on the sidewalls as regroovable. Undertread depth refers to the thickness of tread compound between the bottom of the original tread grooves and the top of the uppermost breaker or belt. The use of regrooving is more common in intra-state bus service than in trucking fleets.

Goodyear recommends retreading radial tires for truck use rather than regrooving. If retreading is not practical, front tires can be regrooved and moved to trailers. Drive tires should be taken off when about 80 percent worn, the non-skid depth increased by regrooving, and then reapplied to the drive axle.

Regrooving requires probing the depth of the undertread so that a minimum undertread depth of 3/32 inch remain below the newly cut groove. It is recommended that the local Goodyear representative be contacted for information if regrooving is being considered.

### Tire Siping For Traction

Adding tire siping to new or partially worn rib tires for additional traction (as differentiated from regrooving worn tread for additional mileage) is an accepted practice for trucking fleets operating on and off the road.

Partially worn radial lug tires can also benefit from regrooving the tread pattern down to 80% of the deepest portion of the original non-skid depth for added traction.



**DOT Regulations On  
Regrooved Tire****Purpose and Scope**

This part sets forth the conditions under which regrooved and regroovable tires manufactured or regrooved after the effective date of the regulation may be sold, offered for sale, introduced for sale or delivered for introduction into interstate commerce.

**Definitions**

(A) Regroovable tire means a tire, either original tread or retread, designed and constructed with sufficient tread material to permit renewal of the tread pattern or the generation of a new tread pattern in a manner which conforms to this part.

(B) Regrooved tire means a tire, either original tread or retread, on which the tread pattern has been renewed or a new tread has been produced by cutting into the tread of a worn tire to a depth equal to or deeper than the molded original groove depth.

**Applicability**

(A) General. Except as provided in paragraph (B) of this section, this part applies to all motor vehicle regrooved or regroovable tires manufactured or regrooved after the effective date of the regulation.

(B) Export. This part does not apply to regrooved or regroovable tires intended solely for export and so labeled or tagged.

**Requirements**

(A) *Regrooved tires.* (1) Except as permitted by paragraph (A)(2) of this section, no person shall sell, offer for sale, or introduce or deliver for introduction into interstate commerce regrooved tires produced by removing rubber from the surface of a worn tire tread to generate a new tread pattern. Any person who

regrooves tires and leases them to owners or operators of motor vehicles and any person who regrooves his own tires for use on motor vehicles is considered to be a person delivering for introduction into interstate commerce within the meaning of this part.

(2) A regrooved tire may be sold, offered for sale, or introduced for sale or delivered for introduction into interstate commerce only if it conforms to each of the following requirements:

- (a) The tire being regrooved shall be a regroovable tire;
- (b) After regrooving, cord material below the grooves shall have a protective covering of tread material at least 3/32 inch thick;
- (c) After regrooving, the new grooves generated into the tread material and any residual original molded tread groove which is at or below the new regrooved depth shall have a minimum of 90 linear inches of tread edges per linear foot of the circumference;
- (d) After regrooving, the new groove width generated into the tread material shall be a minimum of 3/16 inch and a maximum of 5/16 inch;
- (e) After regrooving, all new grooves cut into the tread shall provide unobstructed fluid escape passages; and
- (f) After regrooving, the tire shall not contain any of the following defects, as determined by a visual examination of the tire either mounted on the rim, or dismounted, whichever is applicable:
  - (i) Cracking which extends to the fabric.
  - (ii) Groove cracks or wear extending to the fabric, or
  - (iii) Evidence of ply, tread or sidewall separation.

(g) If the tire is siped by cutting the tread surface without removing rubber, the tire cord material shall not be damaged as a result of the siping process, and no sipe shall be deeper than the original or retread groove depth.

(B) *Siped regroovable tires.* No person shall sell, offer for sale, or introduce for sale or deliver for introduction into interstate commerce a regroovable tire that has been siped by cutting the tread surface without removing rubber if the tire cord material is damaged as a result of the siping process, or if the tire is siped deeper than the original or retread groove depth.

**Labeling of  
Regroovable Tires**

Each tire designed and constructed for regrooving shall be labeled on both sidewalls with the word "Regroovable" molded on or into the tire in raised or recessed letters 0.025 to 0.040 inch. The word "Regroovable" shall be in letters 0.38 to 0.50 inch in height and not less than 4 inches and not more than 6 inches in length. The lettering shall be located in the sidewall of the tire between the maximum section width and the bead in an area which will not be obstructed by the rim flange.

See Page 102 (Subpart G - Miscellaneous Parts and Accessories) for the Federal Motor Carriers Safety Regulations regarding regrooved tires.

# LOAD RATINGS AND INFLATION DATA FOR RADIAL TRUCK TIRES

Tubeless	Tube Type	Load Range	Load Range	Load Range	Load Range	Load Range	Load Range	Load Range
Dual Tire Load Rating		D	E	F	G	H	J	L
7.50R16LT		2140@65	2440@80					
LT225/75R16		2150@65	2470@80					
LT245/75R16		2381@65	2778@80					
LT215/85R16		2150@65	2470@80					
LT235/85R16		2381@65	2778@80		3415@110			
8.75R16.5LT		2070@65	2360@80					
9.50R16.5LT		2445@65	2790@80					
8R17.5			2755@85					
8.5R17.5				3085@90				
9R17.5HC	8.25R15				3660@105	3970@110	5675@125*	
10R17.5						4410@110		
11R17.5HC	10.00R15TR				4430@95	4850@110	6395@125	
8R19.5		2700@80		3375@110				
9R22.5	8.25R20			3950@95				
10R22.5	9.00R20			4875@100	5250@115			
11R22.5	10.00R20				5750@105	5800@110		
12R22.5	11.00R20				5780@95	6750@120		
13R22.5							7160@125	
	12.00R20						7200@110	
	14.00R20							9610@105*
11R24.5	10.00R22				6000@105	6170@110		
12R24.5	11.00R22					6720@110		
	11.00R24					7130@110		
	12.00R24						8100@110	
215/75R17.5						4540@125*		
225/70R19.5				3415@95				
245/70R19.5				3875@85	4375@100			
265/70R19.5					4750@105			
255/70R22.5						5070@115		
245/75R22.5					4410@110			
265/75R22.5					4805@100			
295/75R22.5					5675@100	6005@110		
295/80R22.5						6610@115		
315/80R22.5							7610@120	7750@120*
	13/80R20						7160@110	
285/75R24.5					5675@100			
Single Tire Load Rating								
7.50R16LT		2440@65	2780@80					
LT225/75R16		2335@65	2680@80					
LT245/75R16		2623@65	3042@80					
LT215/85R16		2335@65	2680@80					
LT235/85R16		2623@65	3042@80		3750@110			
8.75R16.5LT		2350@65	2680@80					
9.50R16.5LT		2780@65	3170@80					
8R17.5			2835@85					
8.5R17.5				3195@90				
9R17.5HC	8.25R15				4070@105	4410@110	6005@125*	
10R17.5						4675@110		
11R17.5HC	10.00R15TR				5050@105	5530@120	6945@125	
8R19.5		2800@80		3500@110				
9R22.5	8.25R20			4500@105				
10R22.5	9.00R20			5150@100	5680@115			
11R22.5	10.00R20				6175@105	6610@120		
12R22.5	11.00R20				6590@105	7390@120		
13R22.5							8270@125	
	12.00R20						8210@120	
	14.00R20							10960@115*
11R24.5	10.00R22				6430@105	7030@120		
12R24.5	11.00R22					7660@120		
	11.00R24					8130@120		
	12.00R24						9230@120	
215/75R17.5						4805@125*		
225/70R19.5				3640@95				
245/70R19.5				4080@85	4545@100			
265/70R19.5					5000@105			
255/70R22.5						5510@115		
245/75R22.5					4675@110			
265/75R22.5					5205@110			
295/75R22.5					6175@110	6610@120		
295/80R22.5						7390@115		
315/80R22.5							8270@120	9000@120*
	13/80R20						8050@110	
	14/80R20						9090@120	
	365/80R20						10000@130	
285/75R24.5					6175@110			
385/65R22.5							9370@120	
425/65R22.5							10500@110	
445/65R22.5								12300@120

**Notes:** 1. With above loads and inflations, the maximum speed is 65 MPH. \*55 MPH max.  
 2. For ML tires, see Tire and Rim Year Book for separate ML table.

# TRUCK TYPE AND WEIGHT CLASS

The vehicle icons on the following page depict examples of vehicles in each DOT classification 1-8 with corresponding load ranges. These classifications are guidelines in understanding the type of vehicle used for different applications by vehicle class.

**CLASS ONE**  
6,000 lbs. or less



**CLASS TWO**  
6,001 to 10,000 lbs.



**CLASS THREE**  
10,001 to 14,000 lbs.



**CLASS FOUR**  
14,001 to 16,000 lbs.

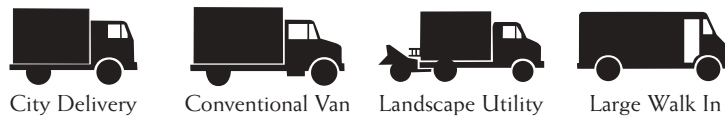

**CLASS FIVE**  
16,001 to 19,500 lbs.



**CLASS SIX**  
19,501 to 26,000 lbs.



**CLASS SEVEN**  
26,001 to 33,000 lbs.



**CLASS EIGHT**  
33,001 lbs. & over

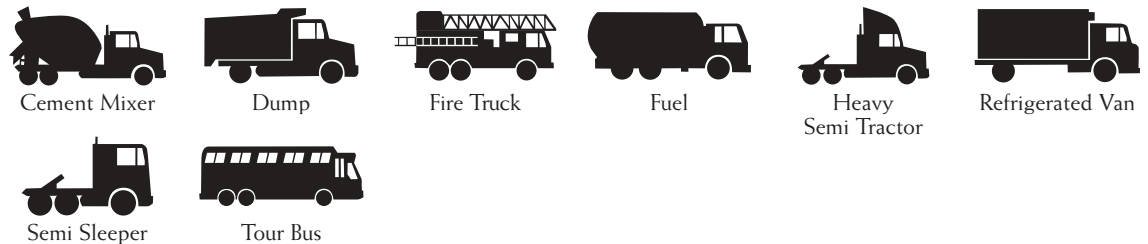

**TRAILERS**

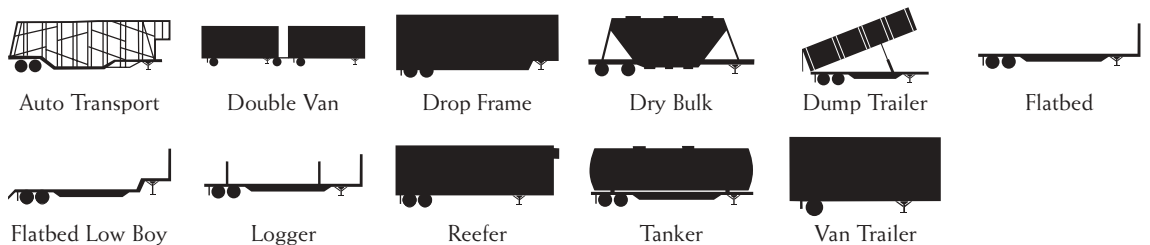



# INDEX

Ackerman Steering Effect on Tire Wear.....	47	In-Service Alignment Recommendations..	49	Retreading .....	86
Alignment.....	43	Inflation .....	37	Definitions .....	90
Ackerman Steering Effect on Tire Wear .....	47	Do's and Don'ts for Maintaining Proper Inflation Pressure.....	42	Introduction.....	87
Camber .....	46	Nitrogen Inflation .....	42	Planning A Retread Plant Visit .....	87
Caster.....	46	Underinflation .....	40	Plant Inspection .....	87
Drive Axle Alignment.....	48	Inspection.....	103	Retread Plant Inspection Checklist .....	92
In-Service Alignment Recommendations .....	49	Inspection Procedures.....	31	Safety Instructions.....	20
Loaded vs. Unloaded Alignment Settings.....	45	Installation.....	23	Safety Precautions.....	28
Steer Axle Alignment .....	45	Loaded vs. Unloaded Alignment Settings.....	45	Section Repair Limits in Sidewall and Shoulder Area.....	84
Toe.....	46	Lubrication .....	20	Servicing Tire and Rim .....	31
Trailer Axle Alignment.....	49	Matching of Duals .....	25	Setback Steer Axles.....	53
Bearing Adjustment.....	55	Minimum Tread Depths.....	104	Siping.....	95
Branding Tires .....	35	Mixing Radial and Bias Ply Tires.....	96	Spacers.....	26
Camber.....	46	Mounting and Inflation .....	29	Spacing of Duals.....	26
Caster.....	46	Mounting Procedure.....	19	Speed and Tire Wear .....	57
Center-Over-Injury Section Repairs .....	85	Assembly of Tire Tube Flap.....	22	Standards and Regulations .....	101
Chains on Radial Truck Tires .....	95	Demounting.....	24	Commercial Vehicle Safety Alliance (CVSA).....	104
Collecting and Storing Tire Information .....	35	Inspection Procedures .....	31	Federal Motor Carrier Safety Regulations .....	102
Branding Tires .....	35	Installation.....	23	Federal Motor Vehicle Safety Standards Testing and Certification.....	102
Radio Frequency Identification Tags .....	36	Lubrication.....	20	Inspection.....	103
Radio Frequency Tag Usage.....	36	Matching of Duals.....	25	Minimum Tread Depths .....	104
Commercial Vehicle Safety Alliance (CVSA).....	104	Mounting and Inflation .....	29	Steer Axle Alignment.....	45
Cross-Sectional View of Typical Tire.....	6	Operation .....	31	Steer Tire Wear .....	52
Crown Repair Limits.....	85	Proper Matching of Rim Parts.....	27	Tire and Rim Cleaning.....	21
Demounting.....	24	Safety Instructions.....	20	Tire Description & Specifications.....	76
Drive Axle Alignment.....	48	Safety Precautions.....	28	Tire Industry Definitions .....	90
Drive Tires.....	54	Servicing Tire and Rim .....	31	Tire Repairs.....	80
Dynamometer Tests.....	96	Spacers.....	26	Application of Center-Over-Injury Section Repairs .....	85
Factors Affecting Treadwear .....	50	Spacing of Duals .....	26	Crown Repair Limits .....	85
Bearing Adjustment.....	55	Tire and Rim Cleaning.....	21	Nail Hole Repair Procedures.....	82
Drive Tires .....	54	Tubeless Tire Mounting .....	23	Radial Ply Tires .....	85
Environmental Effects .....	56	Tubes and Flaps .....	22	Radial Tire Section Repairs .....	84
How Speed Affects Tire Wear.....	57	Wheel Inspection Guidelines .....	20	Radial Tires .....	84
Setback Steer Axles.....	53	Nail Hole Repair Procedures.....	82	Radial Section Repair Limits.....	84
Steer Tire Wear .....	52	Nitrogen Inflation.....	42	Section Repair Limits in Sidewall and Shoulder Area .....	84
Factors Affecting Truck Fuel Economy..	63	Noise.....	97	Tire Sealants And Balance Materials ....	100
Appendix .....	78	Operation.....	31	Tire Selection & Maintenance .....	70
Environmental Conditions .....	74	Planning A Retread Plant Visit.....	87	Tire Selection Process .....	9
Summary.....	77	Plant Inspection .....	87	Tire Selection Process Work Sheet .....	16
Tire Description and Specifications.....	76	Proper Matching of Rim Parts.....	27	Tire Siping/Regrooving.....	105
Tire Selection and Maintenance .....	70	Radial Ply Tires.....	85	Tire Siping for Traction.....	105
Vehicle and Engine Design.....	64	Radial Tire Section Repairs.....	84	DOT Regulations on regrooved Tire .....	106
Vehicle Operation .....	67	Radial Tires .....	84	Labeling of regroovable Tires.....	106
Federal Motor Carrier Safety Regulations.....	102	Radial Section Repair Limits .....	84	Toe .....	46
Federal Motor Vehicle Safety Standards Testing and Certification.....	102	Radial Truck Tire Terms.....	5	Trailer Axle Alignment.....	49
		Cross-Sectional View of Typical Tire .....	6	Tube Flap Assembly .....	22
		Radio Frequency Identification Tags.....	36	Tubeless Tire Mounting .....	23
		Radio Frequency Tag Usage.....	36	Tubes and Flaps .....	22
		Regrooving/Tire Siping.....	105	Underinflation.....	40
		Tire Siping for Traction.....	105	Vehicle and Engine Design .....	64
		DOT Regulations on Regrooved Tire .....	106	Vehicle Operation.....	67
		Labeling of Regroovable Tires.....	106	Wheel Inspection Guidelines .....	20
		Retread Plant Inspection Checklist.....	92		

ON THE WINGS OF  
**GOODYEAR**

The logo features a stylized yellow winged foot with a blue outline, positioned between the words "GOODYEAR". The foot is angled upwards and to the right, with its wings spread.

[www.goodyear.com/truck](http://www.goodyear.com/truck)

©2002, 2003. The Goodyear Tire & Rubber Company. All rights reserved.

700-862-932-505

Printed in U.S.A.

000000-10/04  
(006366)