

# Radiation Detection and Measurement

June 2008

Tom Lewellen

Tkldog@u.washington.edu

# Types of radiation relevant to Nuclear Medicine

Particle	Symbol	Mass (MeV/c <sup>2</sup> )	Charge
Electron	e <sup>-</sup> , β <sup>-</sup>	0.511	-1
Positron	e <sup>+</sup> , β <sup>+</sup>	0.511	+1
Alpha	α	3700	+2
<b>Photon</b>	γ	no rest mass	none

# $\alpha$ Particle Range in Matter

mono-energetic

- Loses energy in a more or less continuous slowing down process as it travels through matter.
- The distance it travels (range) depend only upon its initial energy and its average energy loss rate in the medium.
- The range for an  $\alpha$  particle emitted in tissue is on the order of  $\mu\text{m}'\text{s}$ .

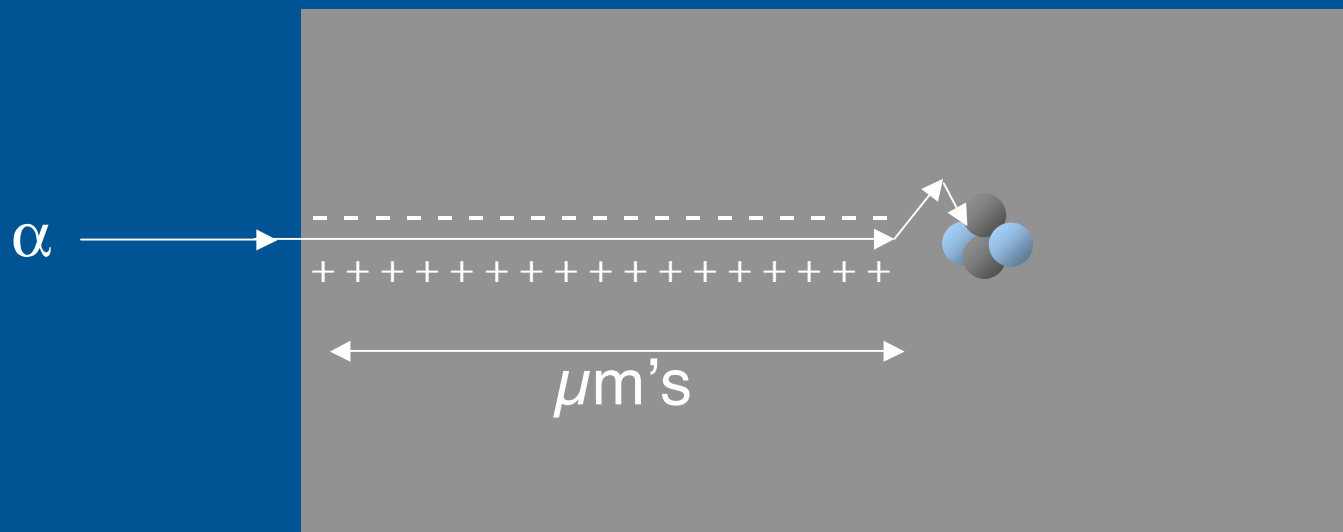

# $\beta$ Particle Range in Matter

## continuous energy spectrum

- $\beta$  particle ranges vary from one electron to the next, even for  $\beta$ s of the same energy in the same material.
- This is due to different types of scattering events the  $\beta$  encounters (i.e., scattering events, bremsstrahlung-producing collisions, etc.).
- The  $\beta$  range is often given as the maximum distance the most energetic  $\beta$  can travel in the medium.
- The range for  $\beta$  particles emitted in tissue is on the order of mm's.

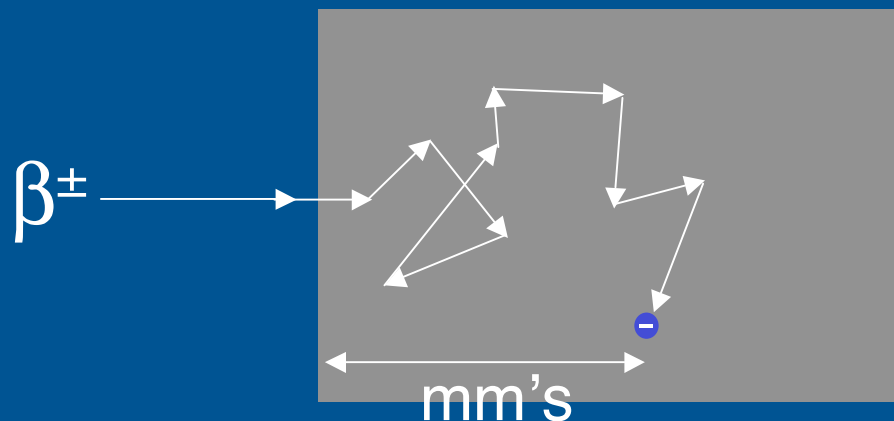

# Interactions of Photons with Matter

$$\text{Exponential Penetration: } N=N_0e^{-\lambda x}$$

**Photoelectric effect**  
photon is absorbed

**Compton scattering**  
part of the energy of the photon is absorbed  
scattered photon continues on with lower energy

**Pair production**  
positron-electron pair is created  
requires photons above 1.022 MeV

**Coherent (Rayleigh) scattering**  
photon deflected with very little energy loss  
only significant at low photon energies (<50 keV)

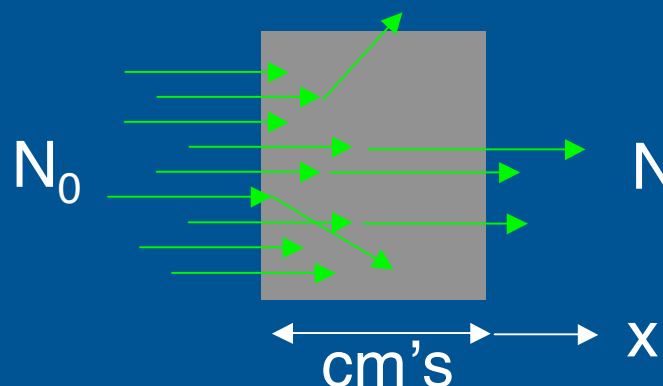

# Basic Radiation Detector System

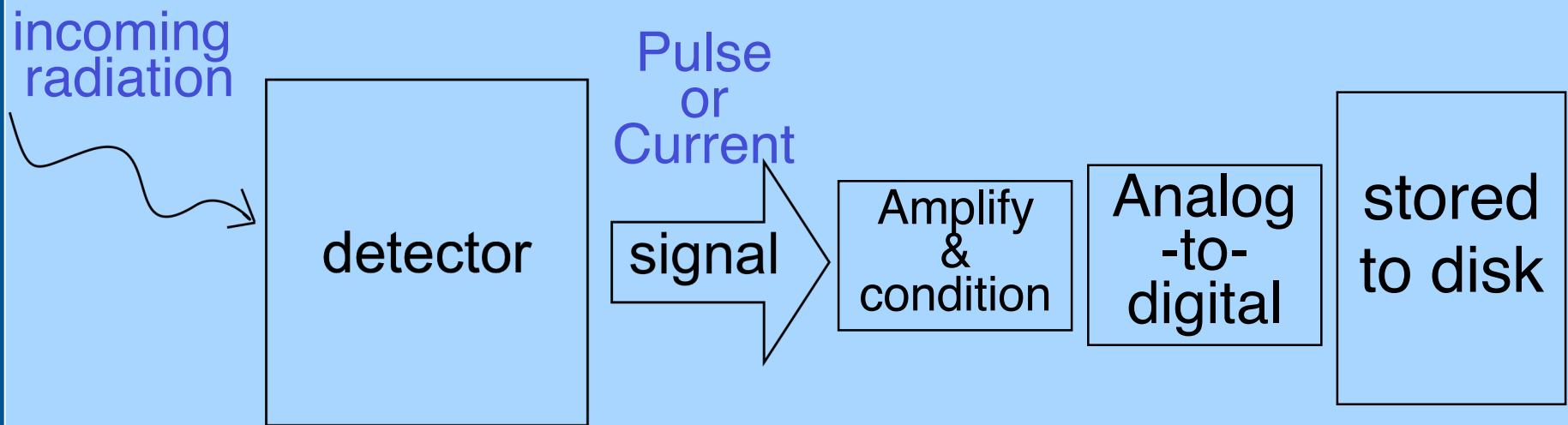

# Basic Radiation Detector Systems

What do you want to know about the radiation?

Energy?

Position (where did it come from)?

How many / how much?

Important properties of radiation detectors

(depends on application)

Energy resolution

Spatial resolution

Sensitivity

Counting Speed

# Pulse Mode versus Current Mode

- Pulse mode
  - Detect individual photons
  - Required for NM imaging applications
- Current mode
  - Measures average rates of photon flux
  - Avoids dead-time losses



# Interaction Rate and Dead-time

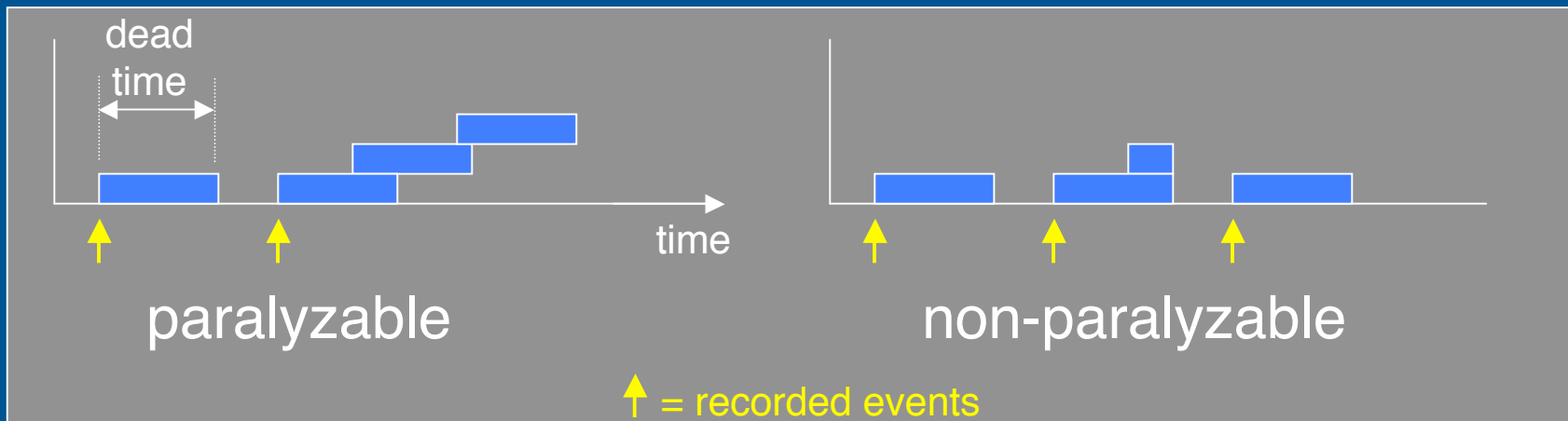
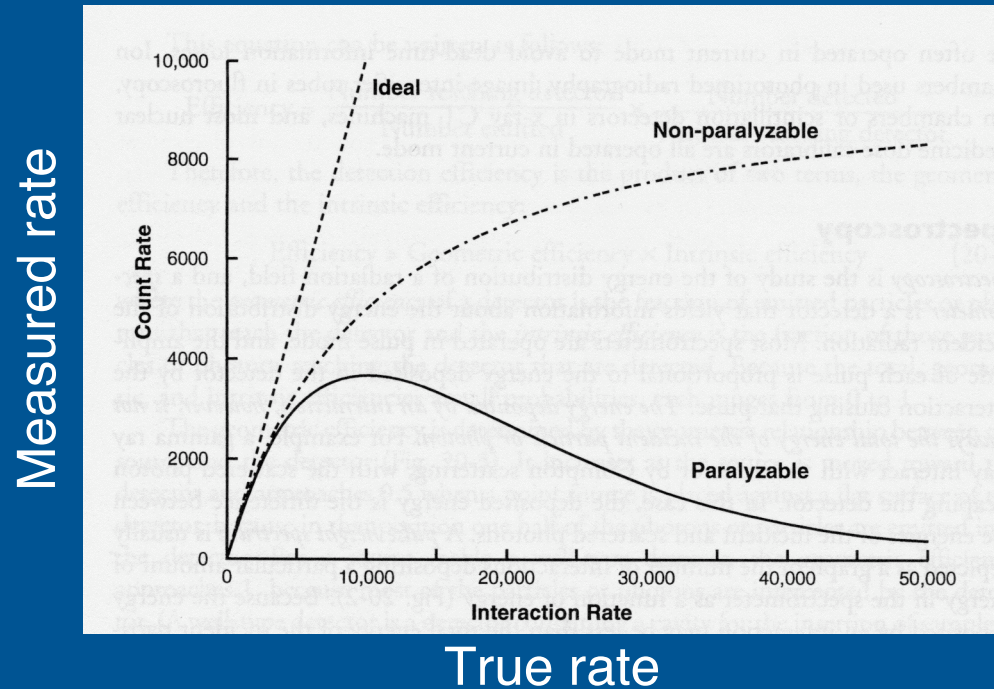

# Types of Radiation Detectors

detection modes / functionality

- Counters
  - Number of interactions
  - Pulse mode
- Spectrometers
  - Number and energy of interactions
  - Pulse mode
- Dosimeters
  - Net amount of energy deposited
  - Current mode
- Imaging Systems
  - CT = current mode
  - NM = pulse mode

# Types of Radiation Detectors

physical composition

- Gas-filled detectors
- Solid-state (semiconductor) detectors
- Organic scintillators (liquid & plastic)
- Inorganic scintillators

scintillators operate with a  
**photo-sensor**  
(i.e. another detector)

# Gas-filled Detectors

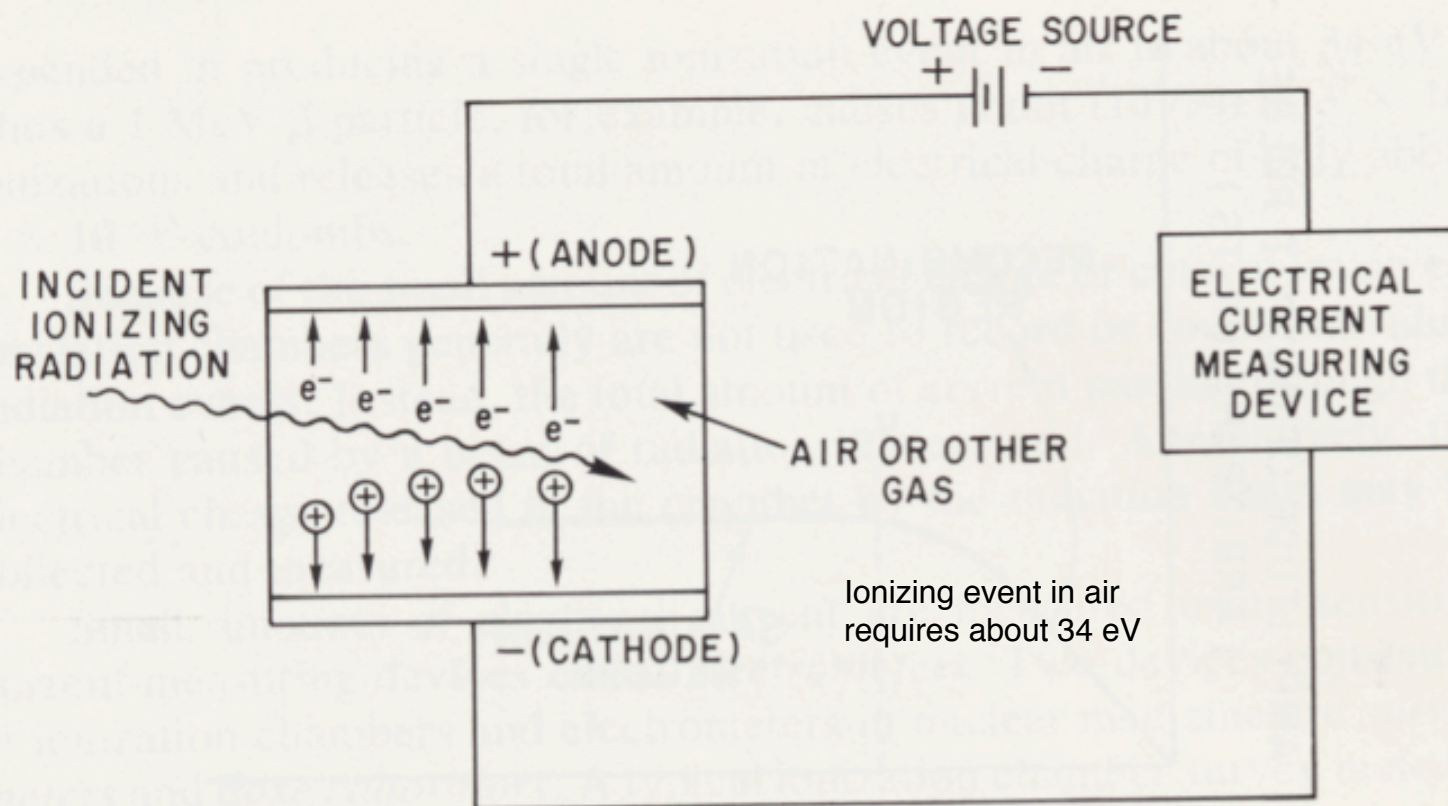
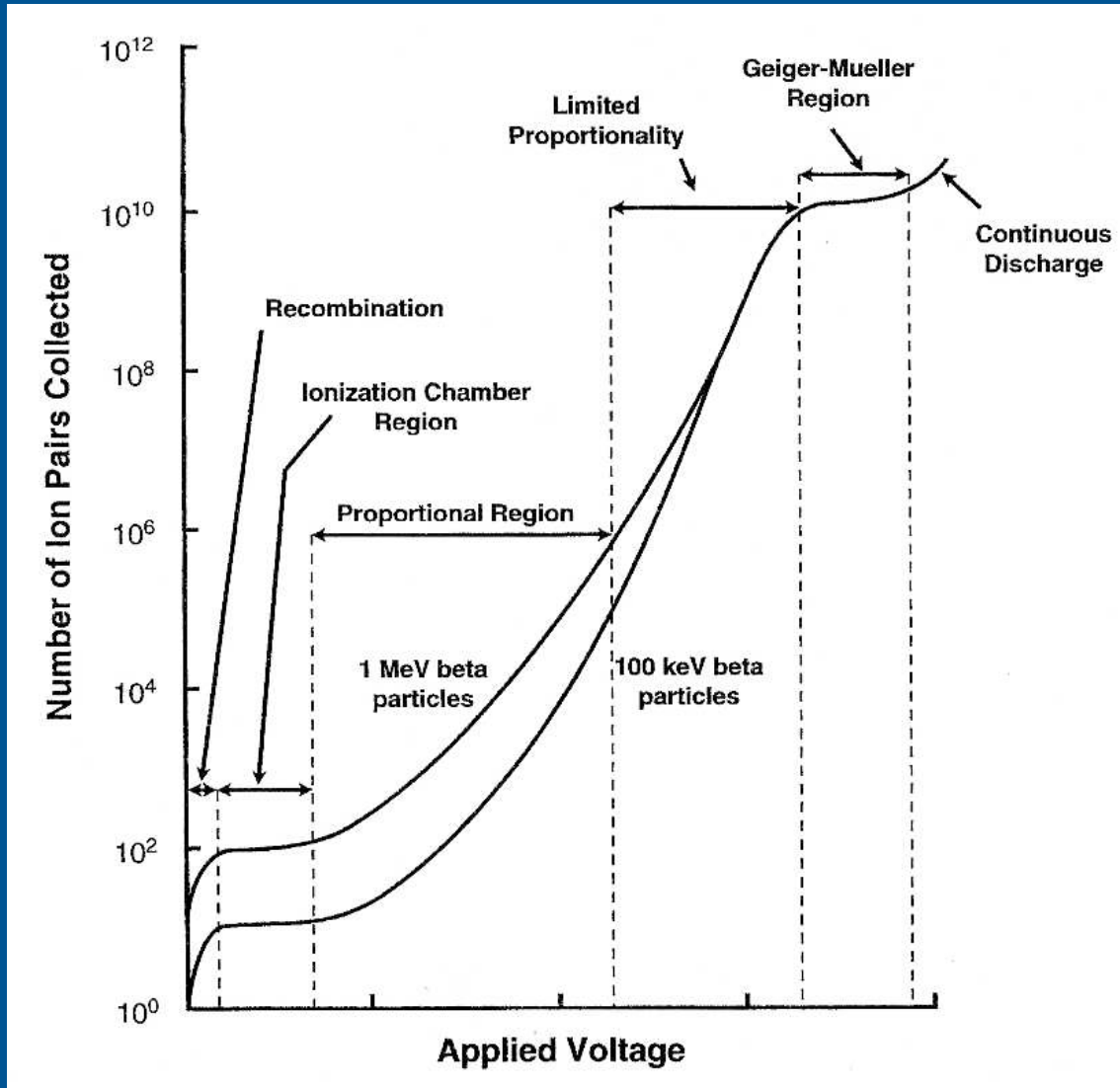

Fig. 4-1. Basic principles of a gas-filled detector. Electrical charge liberated by ionizing radiation is collected by positive and negative electrodes.

# Gas-filled detectors

(operates in three ranges)



Geiger-Muller counters

Proportional counters

Ionization chambers

- Radiation survey meters
- Dosimeters (dose calibrator)

# Ionization Chambers

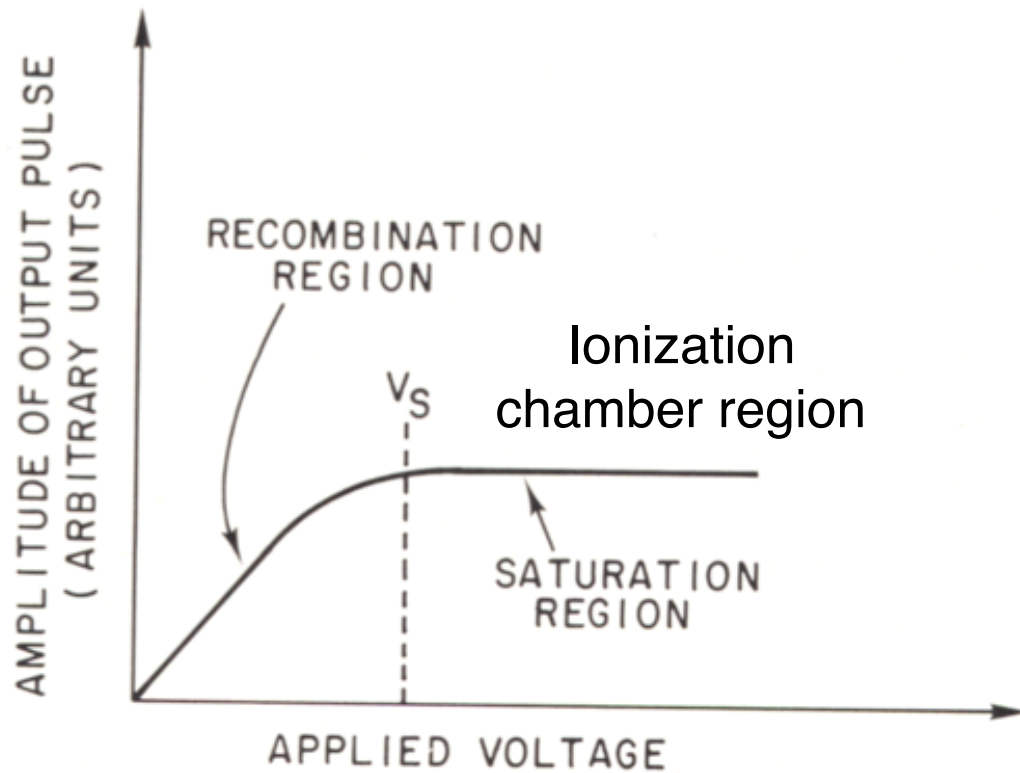

Fig. 4-2. Voltage response curve (charge collected versus voltage applied to the electrodes) for a typical ionization chamber. In usual operation, applied voltage exceeds saturation voltage  $V_s$  to ensure complete collection of liberated charge.



**ATOMLAB 200  
Dose Calibrator**

- No amplification
- No dead-time
- Signal = liberated charge
- Settings for different isotopes
- Calibrations

# Geiger-Muller counters

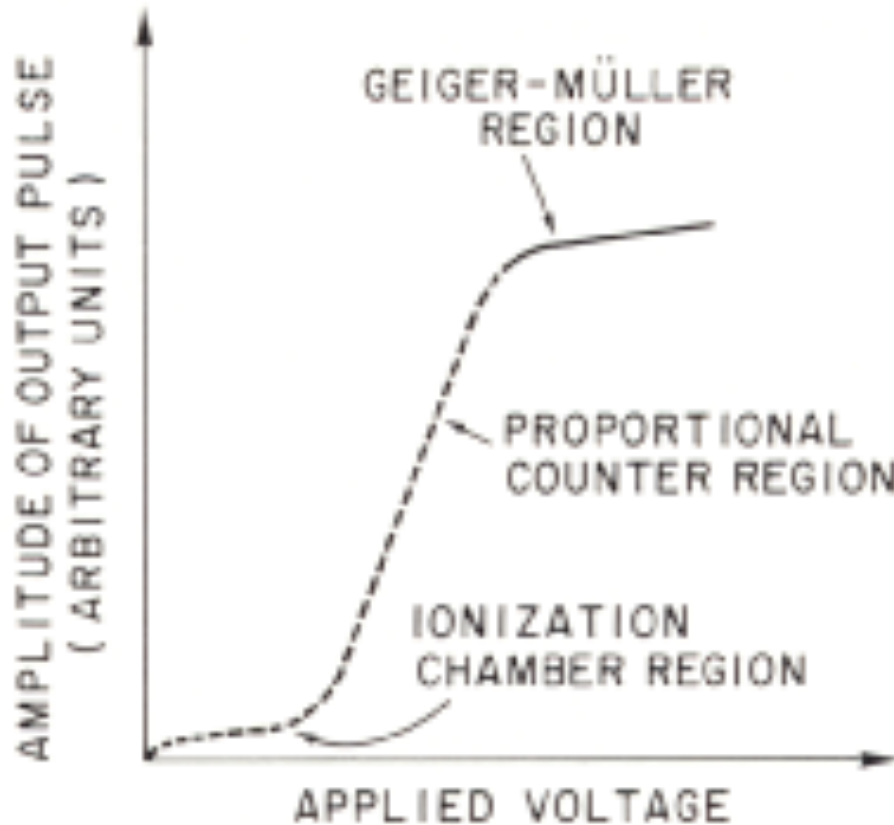

Fig. 4-10. Voltage response curve (pulse amplitude versus applied voltage) for a GM counter.



No energy info  
Long dead-time  
Thin window probe

# Semiconductor Detectors

- Works on same principle as gas-filled detectors (i.e., production of electron-hole pairs in semiconductor material)
- Only  $\sim 3$  eV required for ionization ( $\sim 34$  eV, air)
- Usually needs to be cooled (thermal noise)
- Usually requires very high purity materials or introduction of “compensating” impurities that donate electrons to fill electron traps caused by other impurities



# Semiconductor Detectors

- CdZnTe detectors - can operate at room temperature

## Position Sensitive CZT Detectors

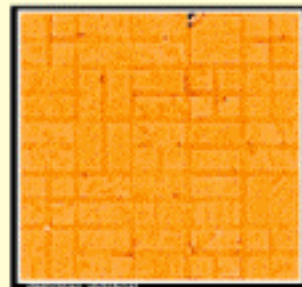
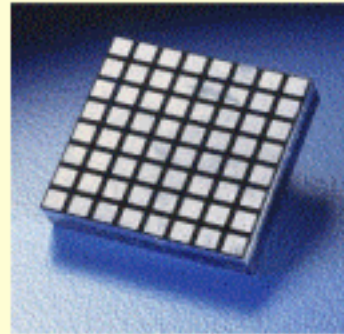
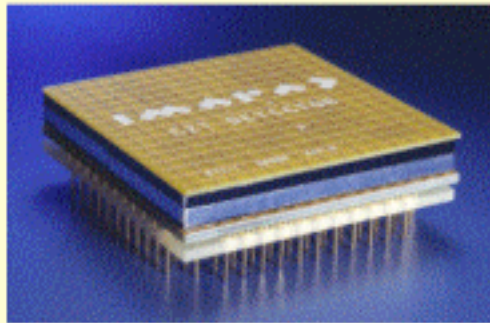

SIEMENS  
Advanced Research  
Siemens Medical Systems, Inc.  
Nuclear Medicine Group  
2501 North Barrington Road  
Hoffman Estates, Illinois 60195

# Organic Liquid Scintillators

(liquid scintillator cocktail)

- Organic solvent - must dissolve scintillator material and radioactive sample
- Primary scintillator (p-terphenyl and PPO)
- Secondary solute (wave-shifter)
- Additives (e.g., solubilizers)
- **Effective for measuring beta particles** (e.g., H-3, C-14).

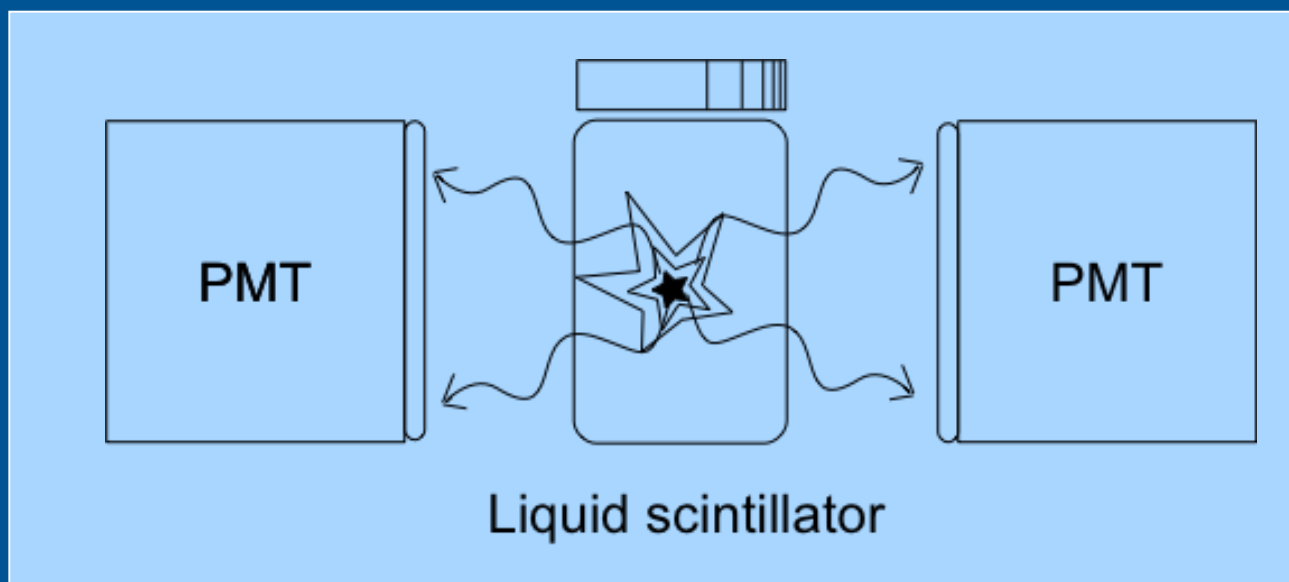

# Inorganic Scintillators

(physical characteristics)

Absorption of radiation lifts electrons from valence to conduction band

Impurities (activators) create energy levels within the band gap permitting visible light scintillations

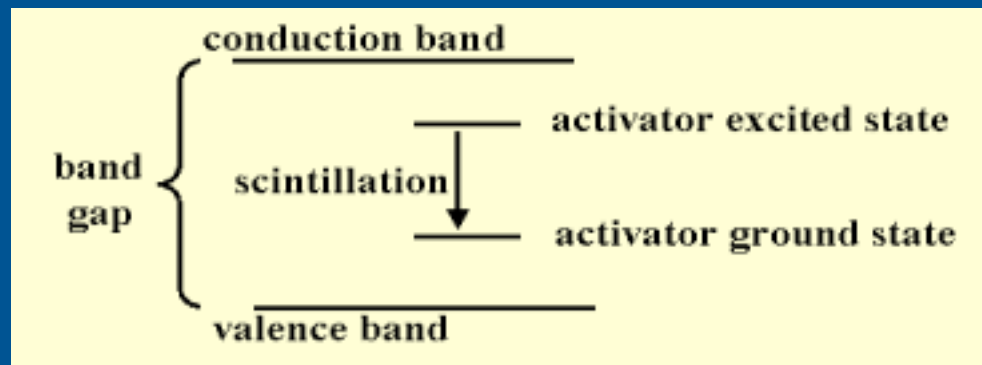

# Inorganic Scintillators

(physical characteristics)

relevant detector  
property

	<b>NaI(Tl)</b>	<b>BGO</b>	<b>LSO(Ce)</b>	<b>GSO(Ce)</b>
<b>Density (gm/cm<sup>3</sup>)</b>	<b>3.67</b>	<b>7.13</b>	<b>7.4</b>	<b>6.71</b>
<b>Effective Atomic Number</b>	<b>51</b>	<b>75</b>	<b>66</b>	<b>59</b>
<b>Attenuation Coefficient (@ 511 keV, cm<sup>-1</sup>)</b>	<b>0.34</b>	<b>0.955</b>	<b>0.833</b>	<b>0.674</b>
<b>Light Output (photons/Mev)</b>	<b>40K</b>	<b>~8K</b>	<b>~30K</b>	<b>~20K</b>
<b>Decay Time</b>	<b>230 ns</b>	<b>300 ns</b>	<b>12 ns 40 ns</b>	<b>60 ns</b>
<b>Wavelength</b>	<b>410 nm</b>	<b>480 nm</b>	<b>420 nm</b>	<b>430 nm</b>
<b>Index of Refraction</b>	<b>1.85</b>	<b>2.15</b>	<b>1.82</b>	<b>1.85</b>
<b>Hygroscopy</b>	<b>yes</b>	<b>no</b>	<b>no</b>	<b>no</b>
<b>Rugged</b>	<b>no</b>	<b>yes</b>	<b>yes</b>	<b>no</b>



sensitivity

energy & spatial resol.  
counting speed



photo-sensor matching  
manufacturing / cost

photo-sensor needed with scintillators

# Photomultiplier Tube (PMT)

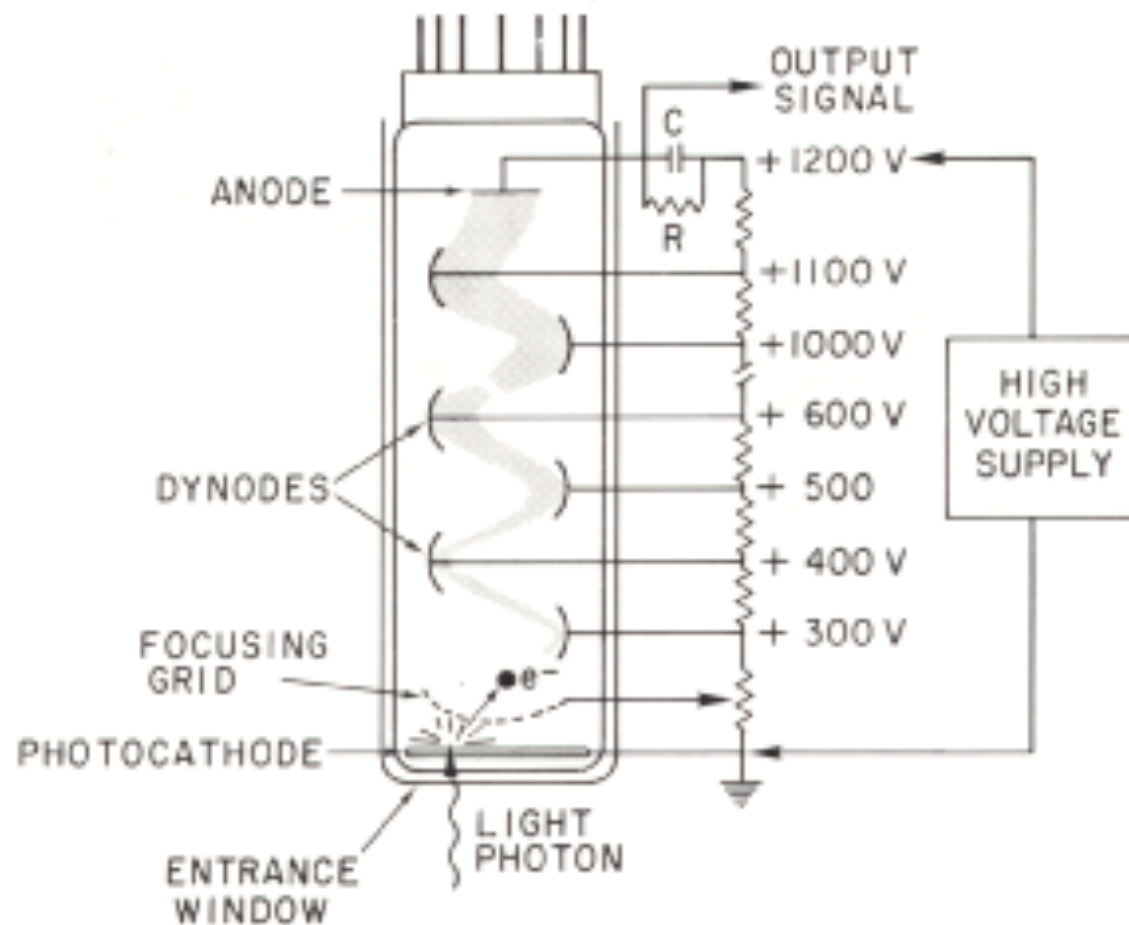
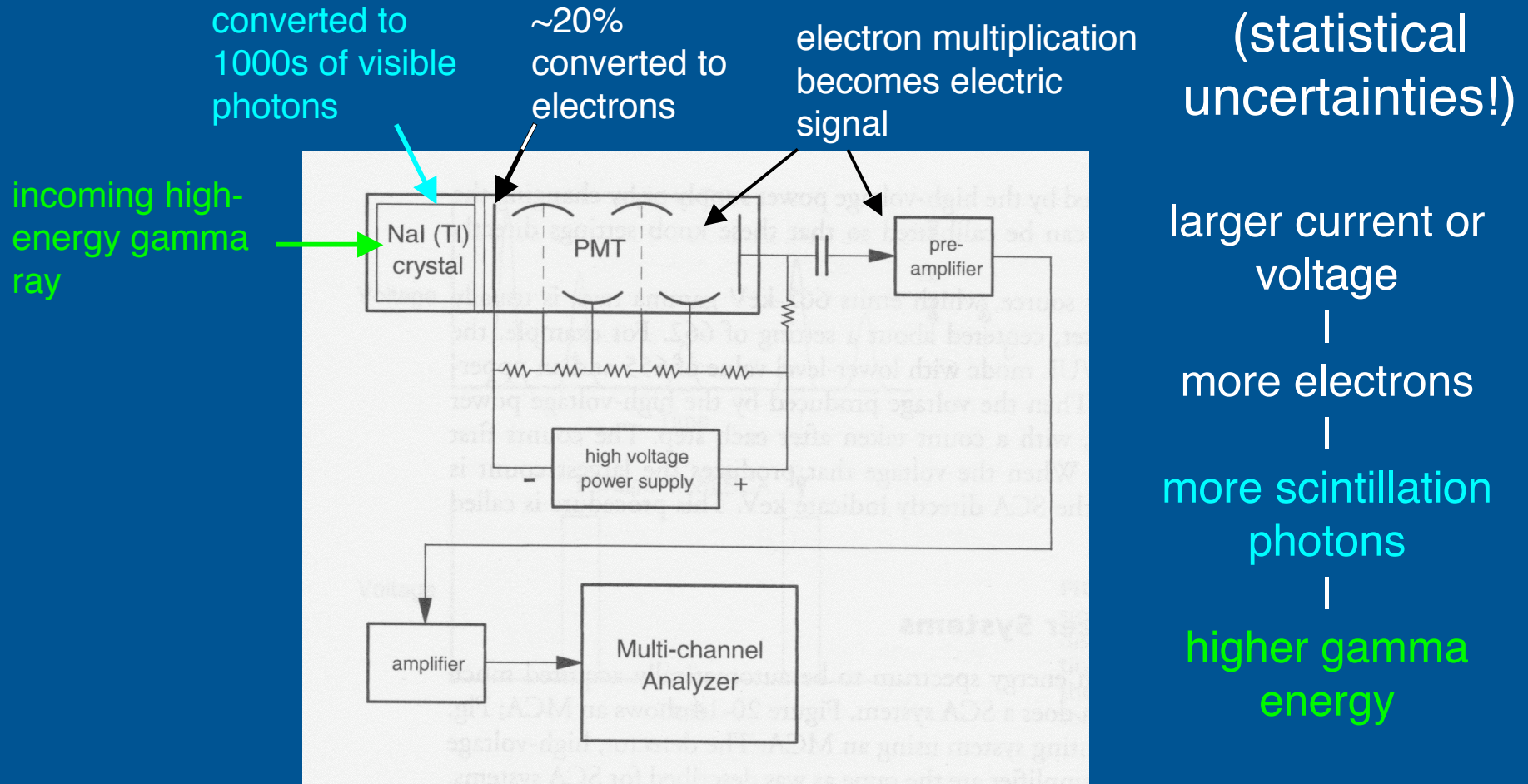
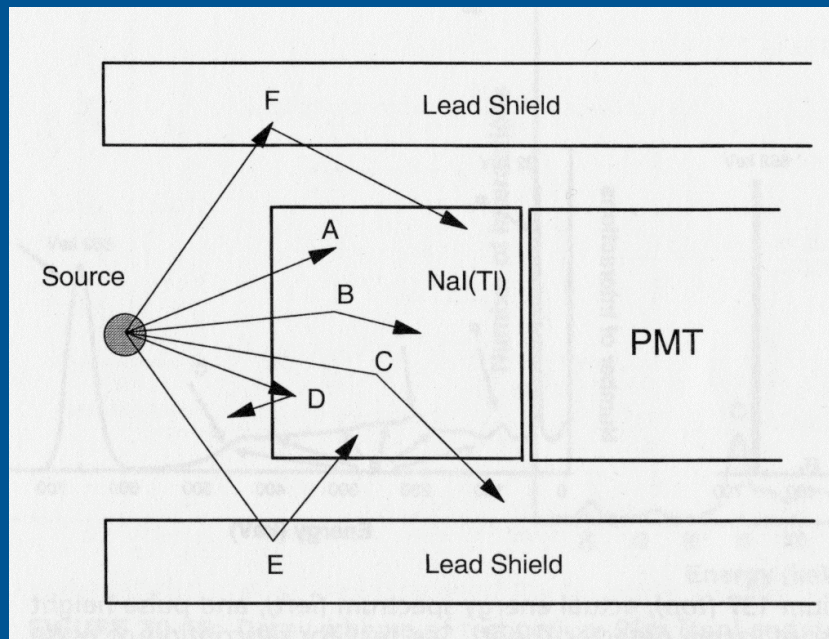

Fig. 4-14. Basic principles of a photomultiplier (PM) tube. (Note: Three dynode stages omitted.)

# Sample Spectroscopy System Hardware



# Interactions of Photons with a Spectrometer



- A. Photoelectric
- B. Compton + Photoelectric
- C. Compton
- D. Photoelectric with characteristic x-ray escape
- E. Compton scattered photon from lead shield
- F. Characteristic x-ray from lead shield

# Sample Spectroscopy System Output

## Ideal Energy Spectrum

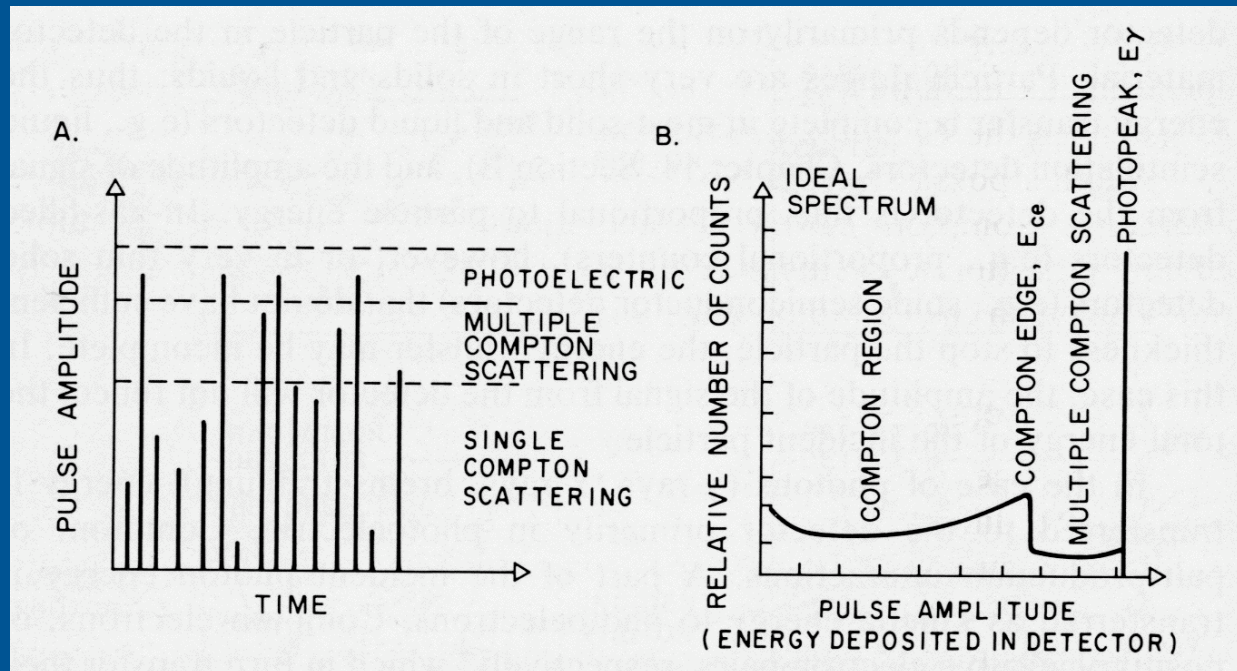

counting mode

From: The Essential Physics of Medical Imaging (Bushberg, et al)

From: Physics in Nuclear Medicine (Sorenson and Phelps)

Rad. Detect & Measure, 2008 (TKL)



# Energy Resolution

## Realistic Energy Spectrum

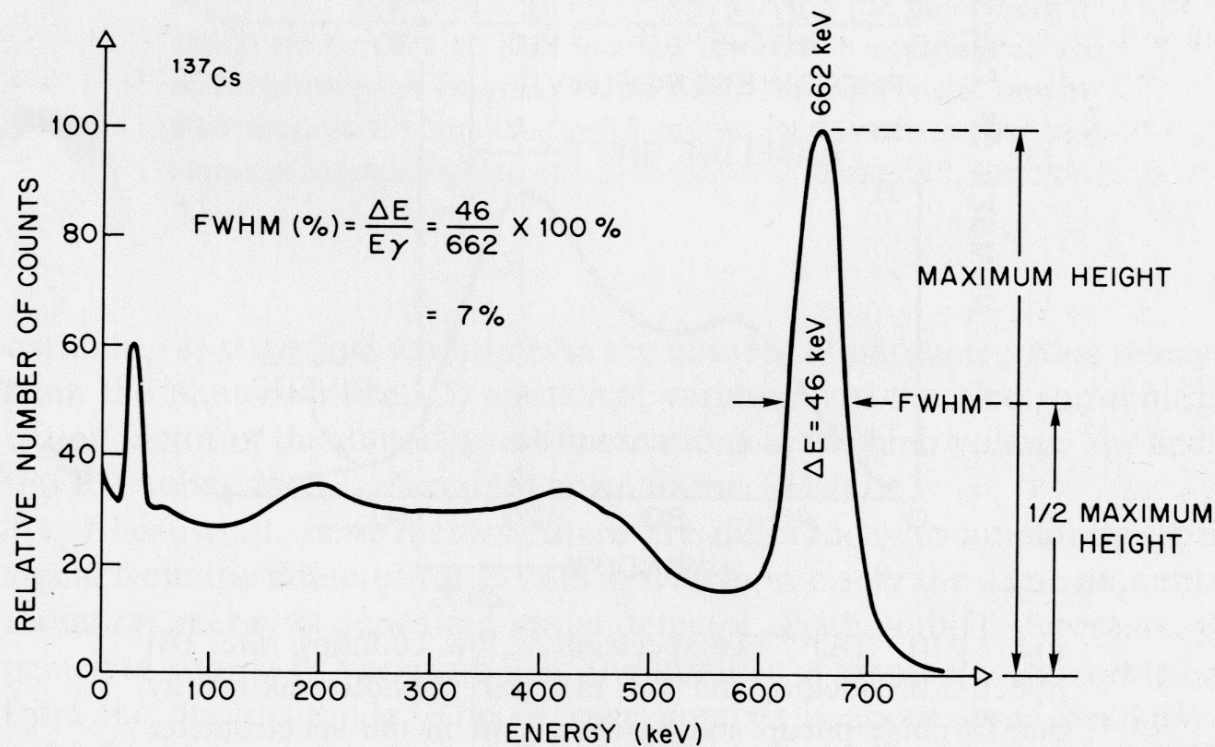
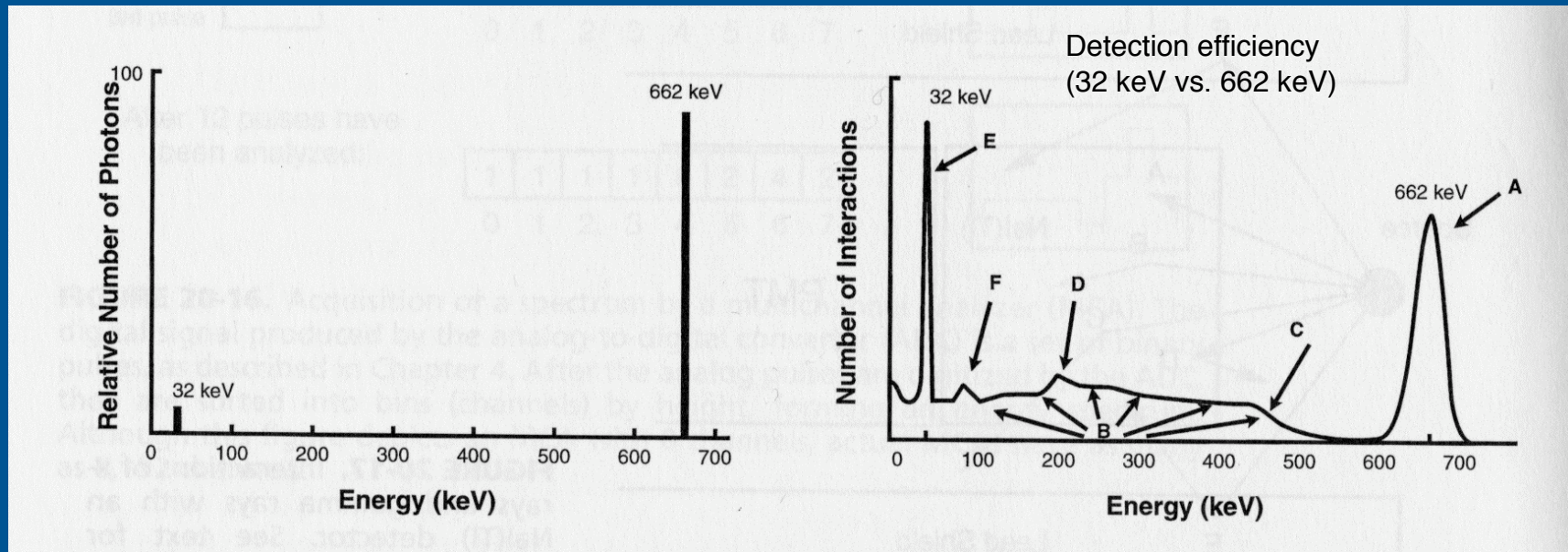

Fig. 11-11. Calculation of FWHM energy resolution of a NaI(Tl) detector for  $^{137}\text{Cs}$  662 keV  $\gamma$  rays.

# Sample Spectrum (Cs-137)



- A. Photopeak
- B. Compton continuum
- C. Compton edge
- D. Backscatter peak
- E. Barium x-ray photopeak
- F. Lead x-rays

# Sample Spectrum (Tc-99m)

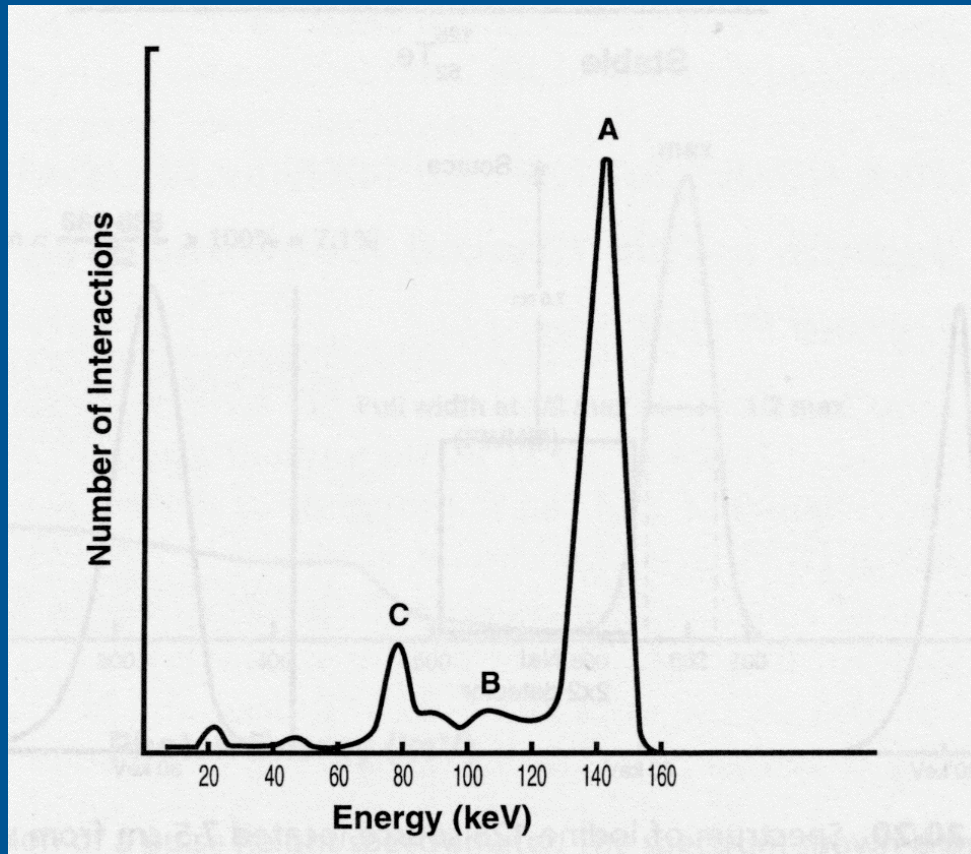

- A. Photopeak
- B. Photoelectric with iodine K-shell x-ray escape
- C. Absorption of lead x-rays from shield

# Sample Spectrum (In-111)

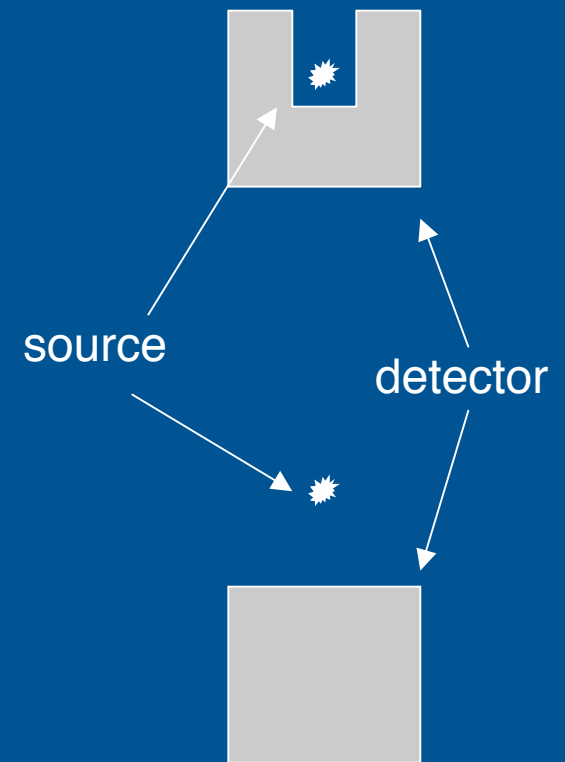
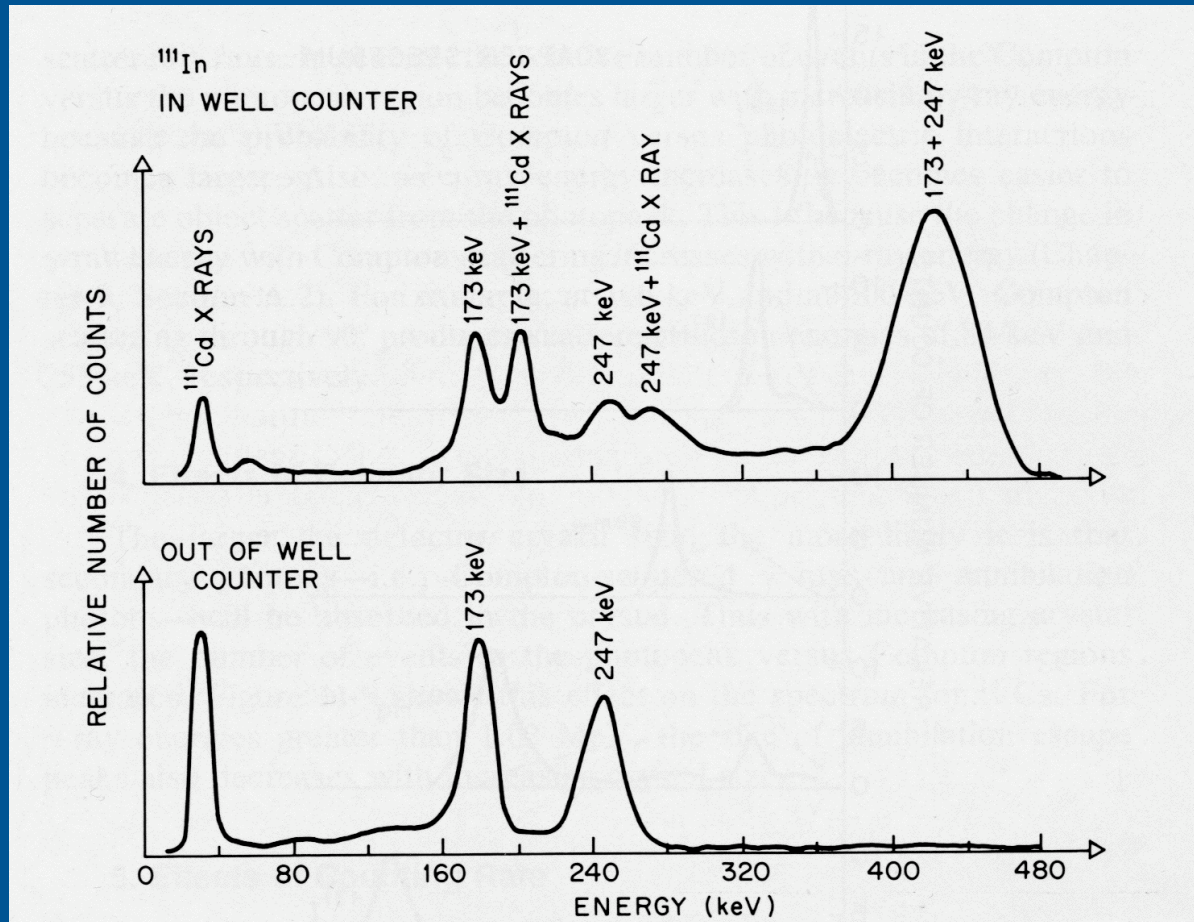

# Effects of Pulse Pileup

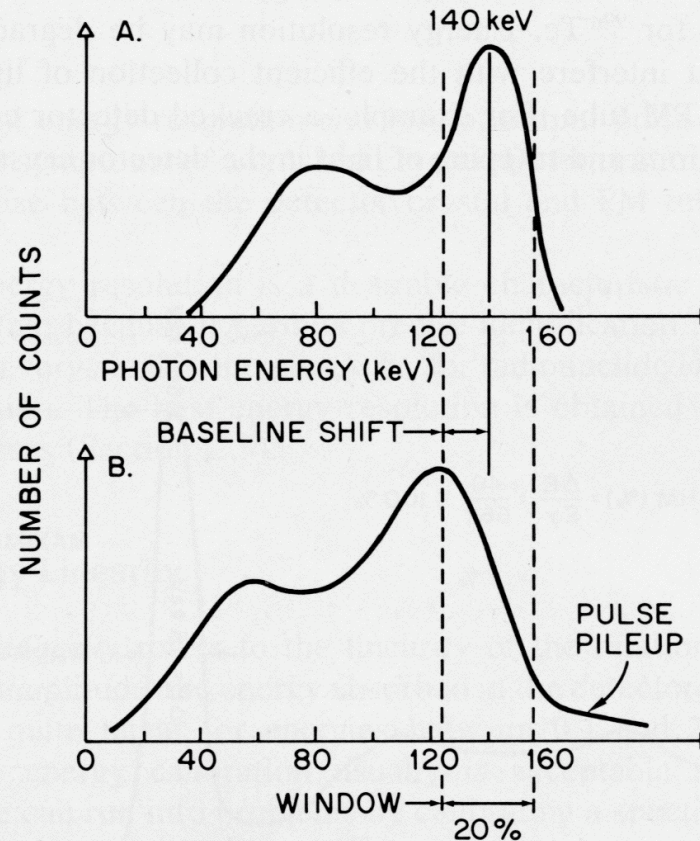

Fig. 11-10. (A)  $^{99m}\text{Tc}$  spectrum at low counting rate. (B) Spectral broadening and shift in apparent photopeak energy due to pulse pileup and baseline shift in the spectrometer amplifier at high counting rate.

# Calibrations

- Energy calibration (imaging systems/spectroscopy)
  - Adjust energy windows around a known photopeak
  - Often done with long-lives isotopes for convenience
    - Cs-137:  $E_{\gamma} = 662 \text{ keV}$  (close to PET 511 keV),  $T_{1/2} = 30 \text{ yr}$
    - Co-57:  $E_{\gamma} = 122 \text{ keV}$  (close to Tc99m 140 keV ),  $T_{1/2} = 272 \text{ d}$
- Dose calibration (dose calibrator)
  - Measure activity of know reference samples (e.g., Cs-137 and Co-57)
  - Linearity measured by repeated measurements of a decaying source (e.g., Tc-99m)

# Raphex Question

**D58.** The window setting used for Tc-99m is set with the center at 140 keV with a width of  $\pm 14$  keV i.e., 20%. The reason for this is:

- A. The energy spread is a consequence of the statistical broadening when amplifying the initial energy deposition event in the NaI(Tl) crystal.
- B. The 140 keV gamma ray emission of Tc-99m is not truly monoenergetic but the center of a spectrum of emissions.
- C. The higher and lower Gaussian tails are a consequence of Compton scattering within the patient.
- D. The result of additional scattered photons generated in the collimator.
- E. A consequence of patient motion during scanning.

# Raphex Answer

**D58.** The window setting used for Tc-99m is set with the center at 140 keV with a width of +/-14 keV i.e., 20%. The reason for this is:

**A.** Photons, which impinge upon the crystal, lose energy by Compton scattering and the photoelectric effect. Both processes convert the gamma ray energy into electron energy. On average approximately one electron hole pair is produced per 30 eV of gamma ray energy deposited in the crystal. These electrons result in the release of visible light when trapped in the crystal. These light quanta are collected and amplified by photomultiplier tubes. The statistical fluctuation in the number of light quanta collected and their amplification is what causes the spread in the detected energy peak, even when most of the Tc-99m photons deposit exactly 140 keV in the NaI(Tl) crystal.



# Counting Statistics

# Sources of Error

- Systematic errors
  - Consistently get the same error
- Random errors
  - Radiation emission and detection are random processes
- Blunder
  - operator error

# Measures of Central Tendency

- Mean
  - Average value
- Median
  - Middlemost measurement (or value)
  - Less affected by outliers

Example: 8, 14, 5, 9, 12

Mean = 9.6

Median = 9

# Measures of Variability

- Variance
  - Measure of variability:

$$\sigma^2 = \frac{(x_1 - \bar{x})^2 + (x_2 - \bar{x})^2 + \dots + (x_N - \bar{x})^2}{N - 1}$$

- Standard deviation
  - Square root of variance

$$\sigma = \sqrt{\sigma^2}$$

# Statistical Models for Random Trials

- Binomial Distribution
- Poisson Distribution
  - Simplification of binomial distribution with certain constraints
- Gaussian or Normal Distribution
  - Further simplification if average number of successes is large (e.g.,  $>20$ )

# Binomial process

- Trial can have only two outcomes

Trial	Definition of a success	Probability of a success
Toss of a coin	"Heads"	1/2
Toss of a die	"A four"	1/6
Observation of a radioactive nucleus for a time " $t$ "	It decays	$1 - e^{-\lambda t}$
Observation of a detector of efficiency $E$ placed near a radioactive nucleus for a time " $t$ "	A count	$E(1 - e^{-\lambda t})$

Source: Adapted from Knoll, GF. *Radiation detection and measurement*, 3rd ed. New York: John Wiley, 2000.

# Binomial probability density function (PDF)

$$P(x) = \frac{N!}{x!(N-x)!} p^x (1-p)^{N-x}$$

- $N$  is total number of trials
- $p$  is probability of success
- $x$  is number of successes

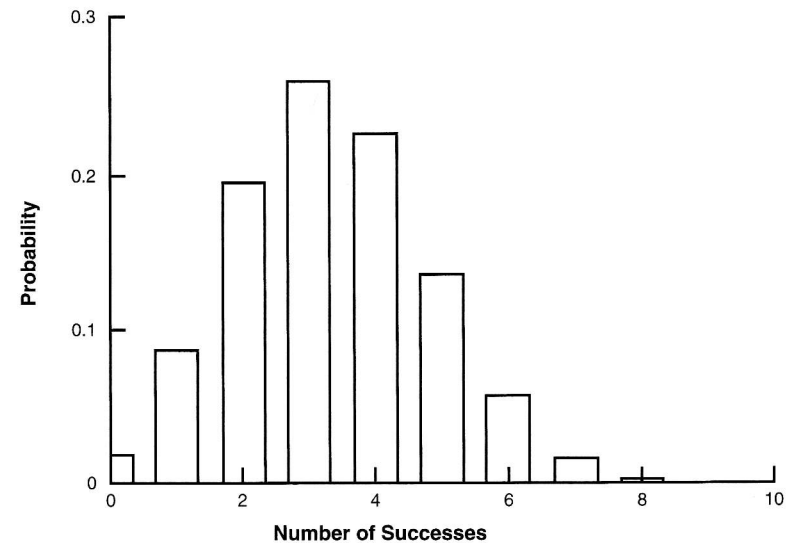

**FIGURE 20-28.** Binomial probability distribution function when the probability of a success in a single trial ( $p$ ) is  $1/3$  and the number of trials ( $N$ ) is 10.

# Binomial probability density function mean and variance

$$\bar{x} = pN \quad \text{and} \quad \sigma = \sqrt{pN(1-p)}$$

- $N$  is total number of trials
- $p$  is probability of success
- $\bar{x}$  is mean,  $\sigma$  is standard deviation

If  $p$  is very small and a constant then:

$$\sigma = \sqrt{pN(1-p)} \approx \sqrt{pN} = \sqrt{\bar{x}}$$

Same as Poisson random process.



# Poisson PDF

- Radioactive decay and detection are Poisson random processes
  - Observation time is short compared to the half-life of the source
    - probability of radioactive decays (i.e.,  $p$ ) remains constant
    - probability of a given nucleus undergoing decay is small
- Variance
  - Variance = mean =  $pN = \bar{x}$
- Standard deviation
  - Standard deviation =  $\sqrt{\text{variance}} = \sqrt{pN} = \sqrt{\bar{x}}$
- Can estimate standard deviation from a single measurement

# Confidence Intervals

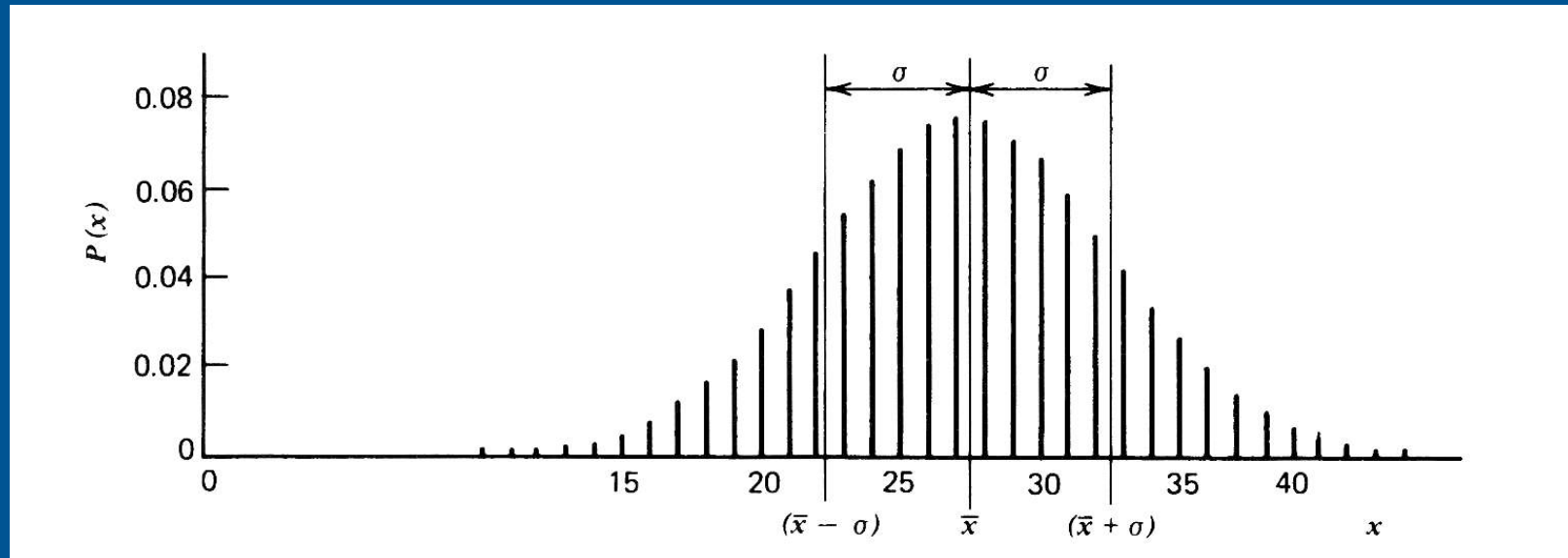

Interval about measurement	Probability that mean is within interval (%)
$\pm 0.674\sigma$	50.0
$\pm 1.0\sigma$	68.3
$\pm 1.64\sigma$	90.0
$\pm 1.96\sigma$	95.0
$\pm 2.58\sigma$	99.0
$\pm 3.0\sigma$	99.7

# Raphex Question

**D70.** How many counts must be collected in an instrument with zero background to obtain an error limit of 1% with a confidence interval of 95%?

- A. 1000
- B. 3162
- C. 10,000
- D. 40,000
- E. 100,000

# Raphex Answer

**D70.** How many counts must be collected in an instrument with zero background to obtain an error limit of 1% with a confidence interval of 95%?

**D.** A 95% confidence interval means the counts must fall within two standard deviations (SD) of the mean (N). Error limit = 1% = 2 SD/N, but SD =  $N^{1/2}$ . Thus  $0.01 = 2(N^{1/2})/N = 2/ N^{1/2}$ . Where  $[0.01]^2 = 4/N$  and  $N = 40,000$ .

# Propagation of Error

Description	Operation	Standard Deviation
Multiplication of a number with random error ( $x$ ) by a number without random error (const., $c$ )	$cx$	$c\sigma$
Division of a number with random error ( $x$ ) by a number without random error ( $c$ )	$x/c$	$\sigma/c$
Addition of two numbers containing random errors	$x_1 + x_2$	$\sqrt{\sigma_1^2 + \sigma_2^2}$
Subtraction of two numbers containing random errors	$x_1 - x_2$	$\sqrt{\sigma_1^2 + \sigma_2^2}$



Note the PLUS sign: combination of two measurements with error leads to result with greater overall error - errors add “in quadrature”. Errors compound, they can’t ‘cancel’ each other.

# Raphex question

**G74.** A radioactive sample is counted for 1 minute and produces 900 counts. The background is counted for 10 minutes and produces 100 counts. The net count rate and net standard deviation are about \_\_\_\_ and \_\_\_\_ counts.

- A. 800, 28
- B. 800, 30
- C. 890, 28
- D. 890, 30
- E. 899, 30

# Raphex answer

**G74.** A radioactive sample is counted for 1 minute and produces 900 counts. The background is counted for 10 minutes and produces 100 counts. The net count rate and net standard deviation are about \_\_\_\_\_ and \_\_\_\_\_ counts/min.

**D.** The net count rate is:

$$[(N_s/t_s) - (N_b/t_b)] = [(900/1) - (100/10)] = 890.$$

The net standard deviation,  $\sigma$  is:

$$[(N_s/t_s^2) + (N_b/t_b^2)]^{1/2} = [(900) + (1)] = 30.$$

# What piece of equipment would you use to measure the activity of a pure beta emitter?

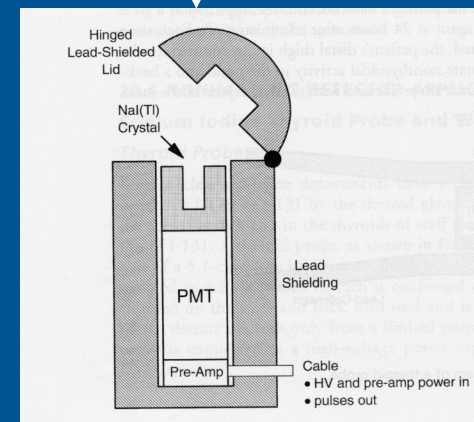
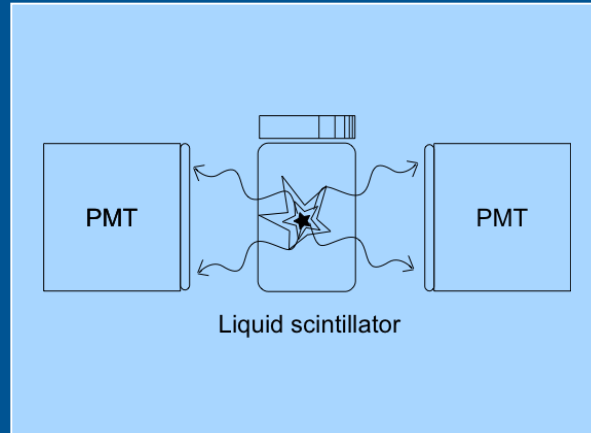



# Radiation detectors used in Nuclear Medicine

