

RADIO WAVE PROPAGATION

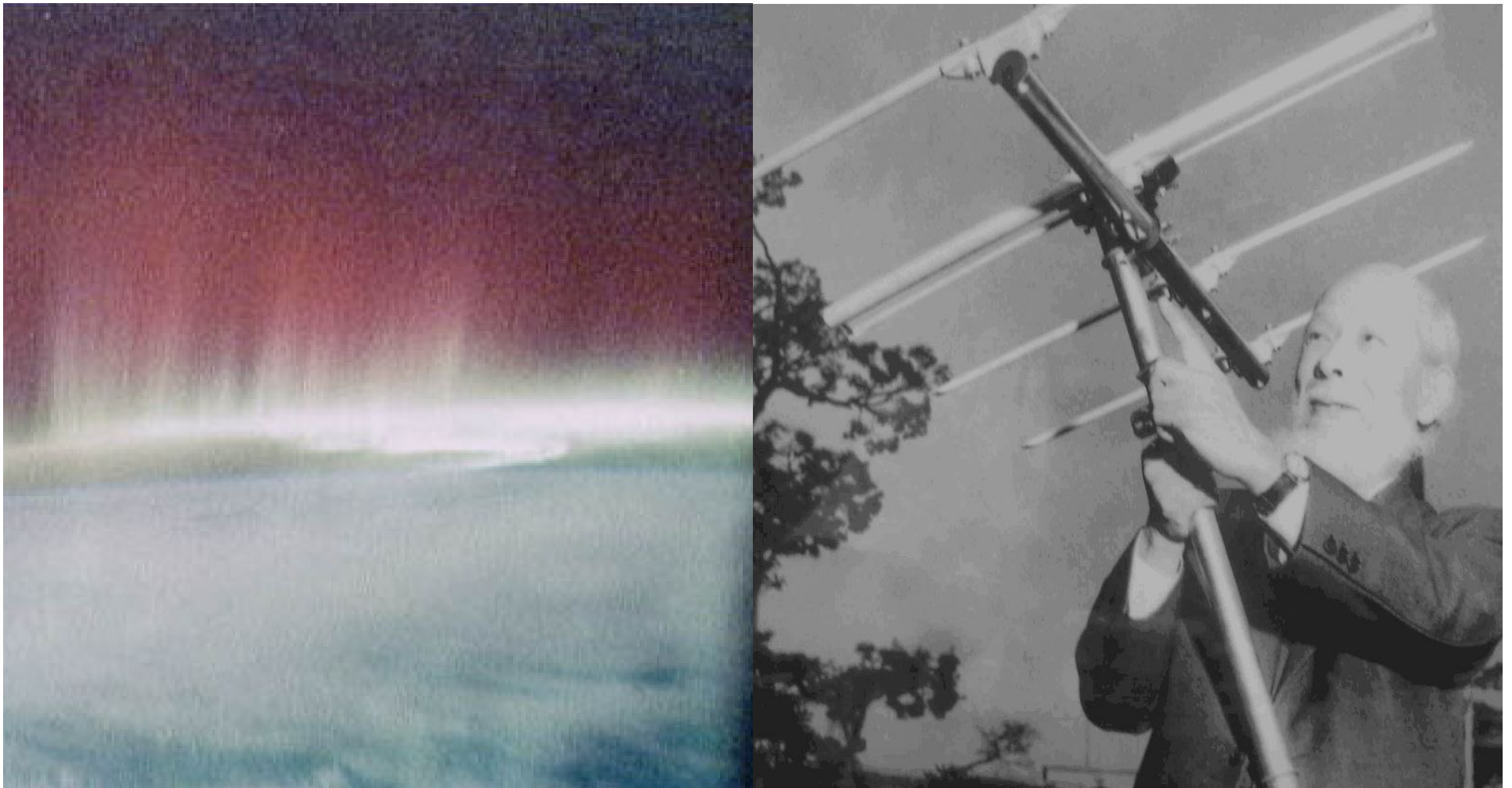

REFERENCES

“Almost Everything You Need to Know...”:

Chapter 7: 53-68

“RAC Basic Study Guide 6th Ed:”

6.2, 6.3, 6.4, 6.5, 6.6, 6.8, 6.9, 6.10

“RAC Operating Manual 2nd Ed:”

“The ARRL Handbook For Radio Amateurs 2001,78thEd:”

Chapter 21: 1-37

“Radio Propagation.”

Wikipedia, The Free Encyclopedia. 6 Nov 2007

<http://en.wikipedia.org/>

“Chelmsford Amateur Radio Society”

Intermediate Course (5) Antennas and Feeders

OBJECTIVES

Lesson 7

From: Emergency Management Ontario

- PROPAGATION – INTRO
- RADIO WAVES
- POLARIZATION
- LINE OF SIGHT, GROUND WAVE, SKY WAVE
- IONOSPHERE REGIONS
- PROPAGATION, HOPS, SKIPS ZONES
- THE IONOSPHERIC LAYERS
- ABSORPTION AND FADING
- SOLAR ACTIVITY AND SUN SPOTS
- MF, HF CRITICAL FREQUENCIES
- BEACONS
- UHF, VHF, SPORADIC E, AURORAS, DUCTING
- SCATTER, HF, VHF, UHF
- SAMPLE QUESTIONS

Major General Urquhart:

*“My communications are completely broken down.
Do you really believe any of that can be helped by a cup of
tea?”*

Corporal Hancock:

“Couldn't hurt, sir”

-Arnhem 1944



A Typical Modern HAM Shack With Radios, Power Supplies, And the Ubiquitous Computer/s



Another Example of a HAM Shack

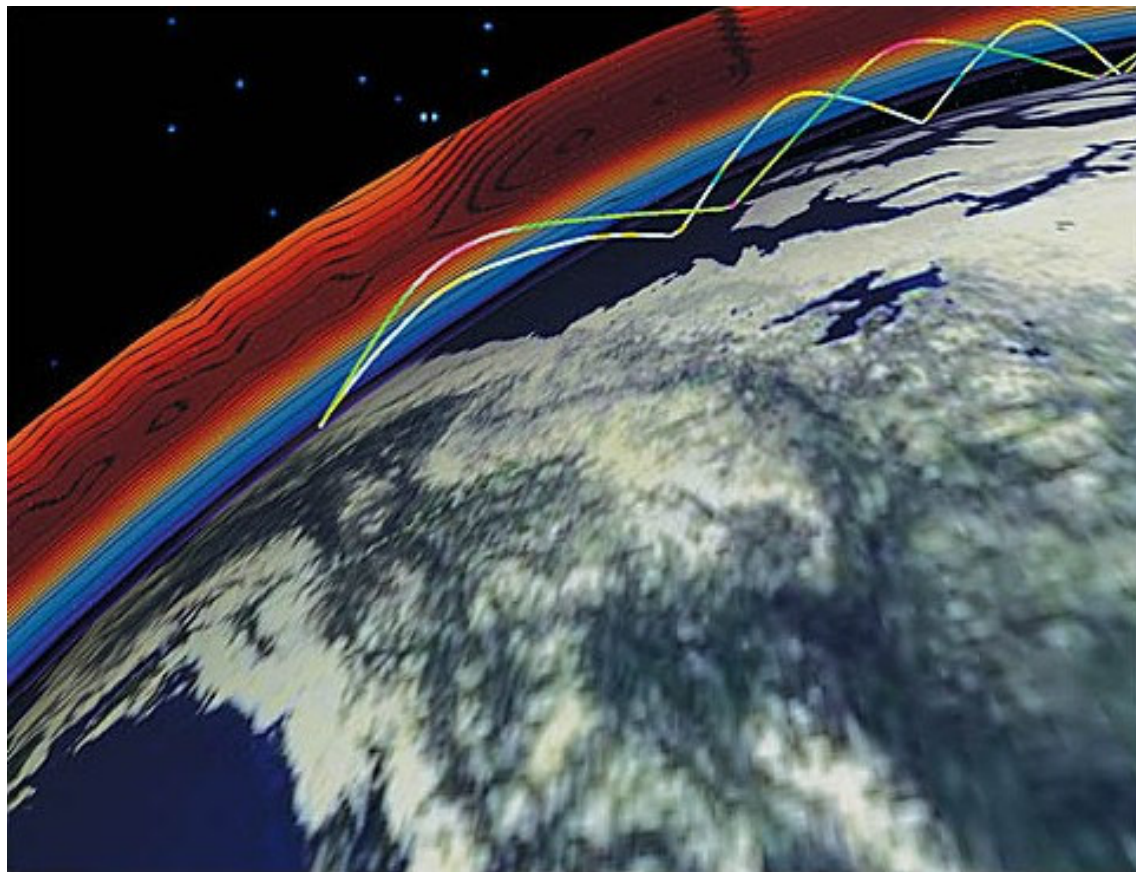

Good Antennas Make DX (Long Distance) Radio Communications Much Easier

PROPAGATION - INTRO

Lesson 7

From: Emergency Management Ontario

Propagation: how radio waves get from point A to point B. The events occurring in the transmission path between two stations that affect the communications between the stations.

When the electrons in a conductor, (antenna wire) are made to oscillate back and forth, Electromagnetic Waves (EM waves) are produced.

These waves radiate outwards from the source at the speed of light, 300 million meters per second.

Light waves and radio waves are both EM waves, differing only in frequency and wavelength.

PROPAGATION – INTRO CONT'D

Lesson 7

From: Emergency Management Ontario

EM waves travel in straight lines, unless acted upon by some outside force. They travel faster through a vacuum than through any other medium.

As EM waves spread out from a point they decrease in strength in what is described as an "inverse square relationship".

A signal 2 km from the source will be only 1/4 as strong as that 1 km from the source. A signal 3 km from the source will be only 1/9 that at the 1 km point.

HOWEVER.....

Modern receivers are very sensitive and extremely small powers provide usable signals.

Waves can be received many thousands of kilometers from the transmitting station. Voyager 2 transmitted signals over many billions of kilometers from outer space with only 25 W of power.

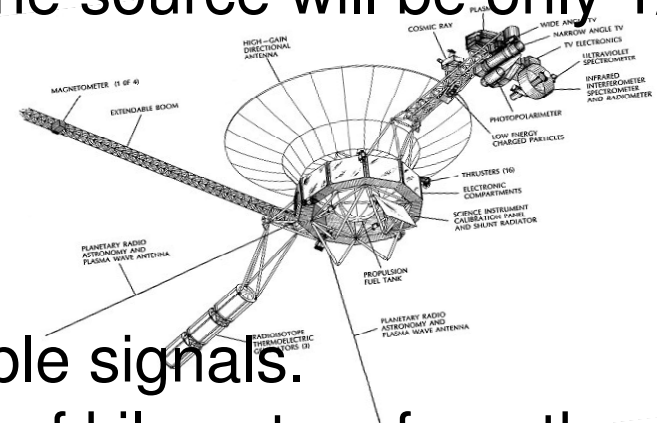

RADIO WAVES

Lesson 7

From: Emergency Management Ontario

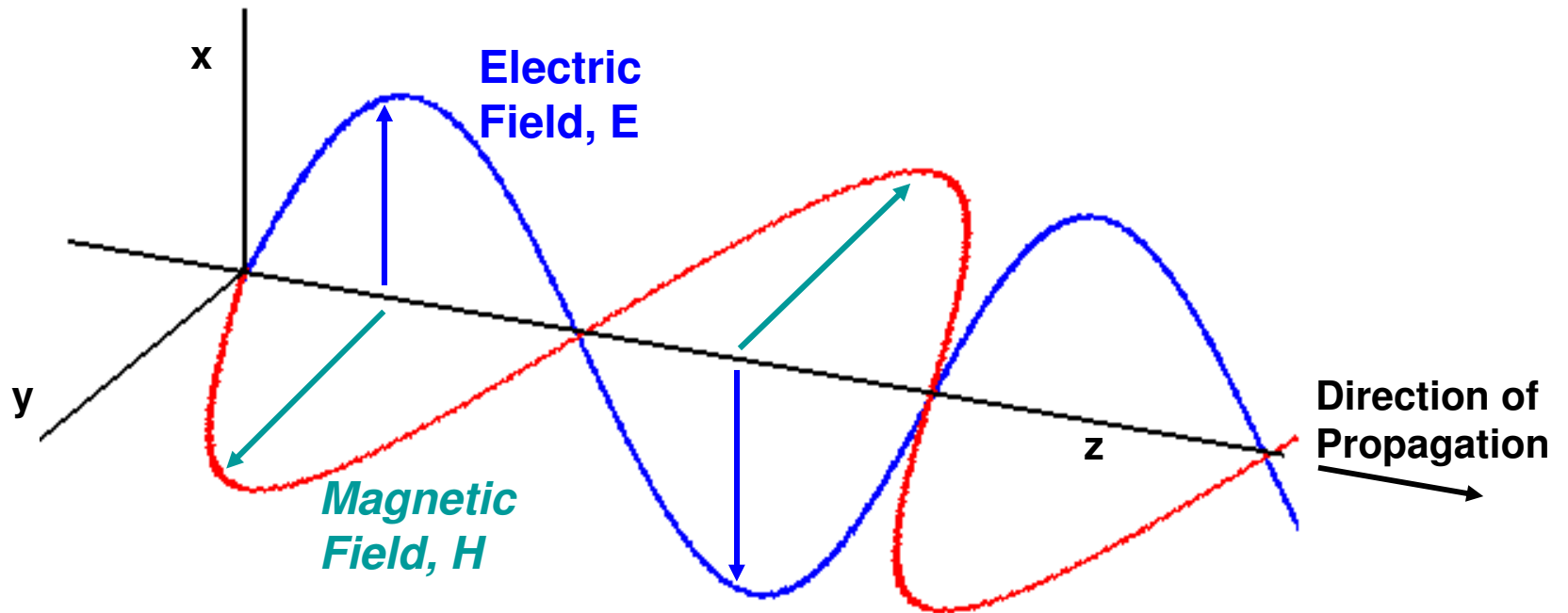

- Electromagnetic radiation comprises both an Electric and a Magnetic Field.
- The two fields are at right-angles to each other and the direction of propagation is at right-angles to both fields.
- The Plane of the Electric Field defines the Polarisation of the wave.

RADIO WAVES CONT'D

Lesson 7

From: Emergency Management Ontario

Two types of waves:

Transverse waves and Longitudinal

Transverse waves:

vibration is from side to side; that is, at right angles to the direction in which they travel

Guitar string vibrates with transverse motion.

EM waves are always transverse.

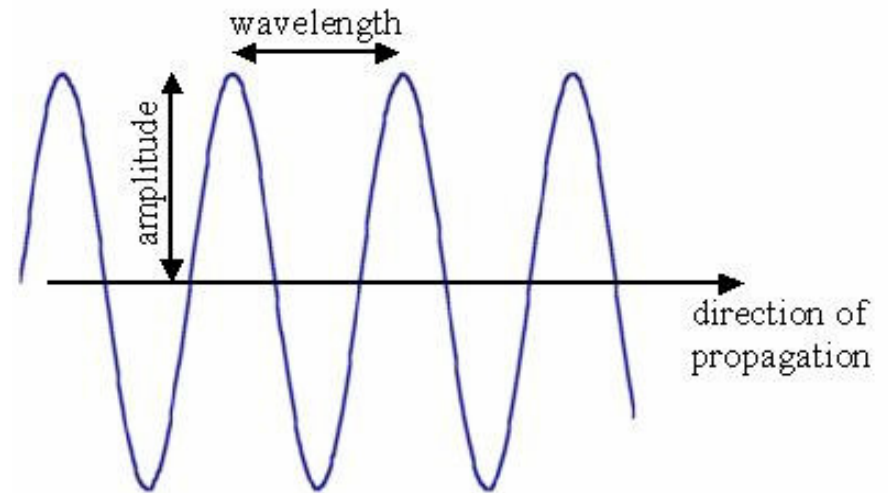

RADIO WAVES CONT'D

Lesson 7

From: Emergency Management Ontario

- **Longitudinal waves:**
- Vibration is parallel to the direction of propagation. Sound waves, Pressure waves are longitudinal. Oscillate back and forth, vibrations along or parallel to their direction of travel

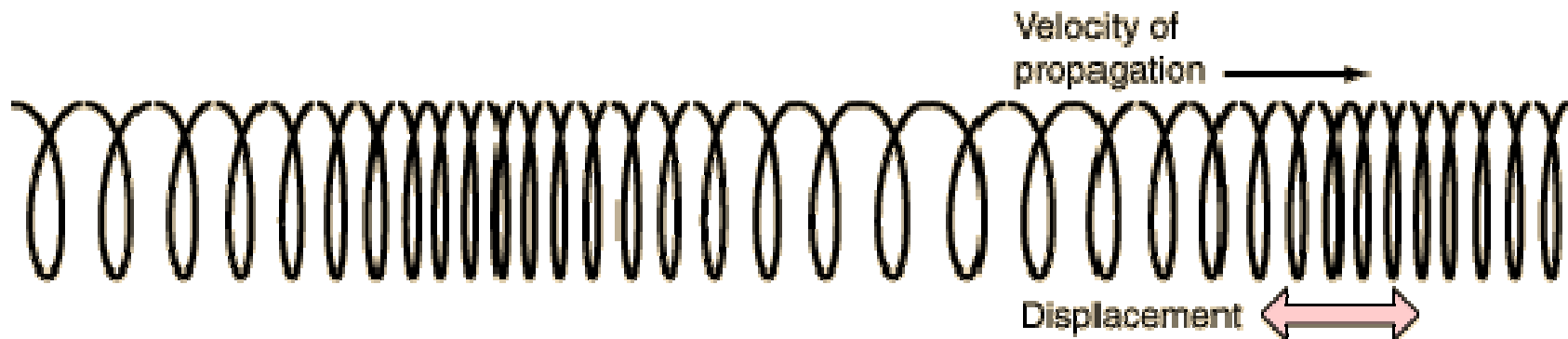

A wave in a "slinky" is a good visualization.

POLARIZATION

Lesson 7

From: Emergency Management Ontario

- The polarization of an antenna is the orientation of the electric field with respect to the Earth's surface and is determined by the physical structure of the antenna and by its orientation
- Radio waves from a vertical antenna will usually be vertically polarized.
- Radio waves from a horizontal antenna are usually horizontally polarized.

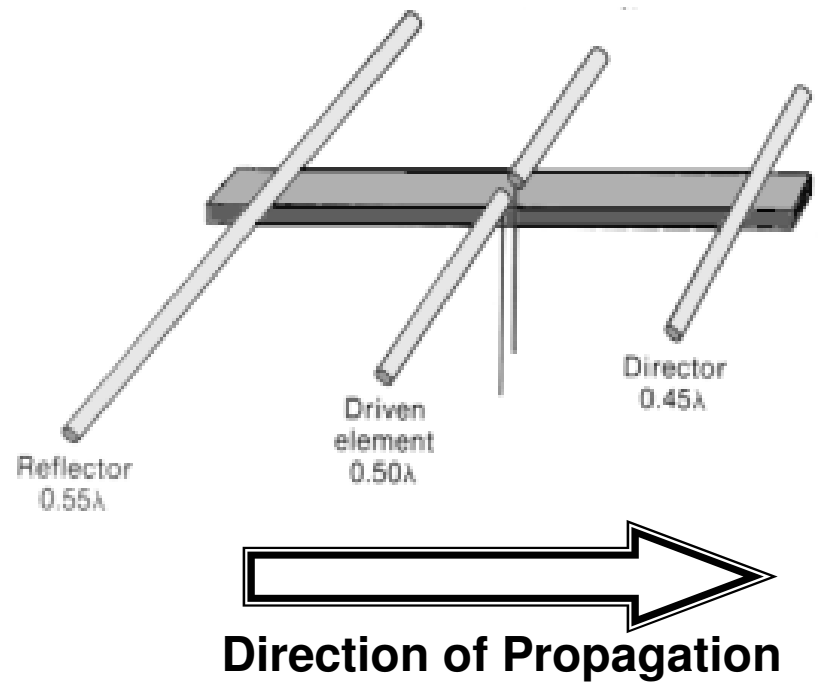
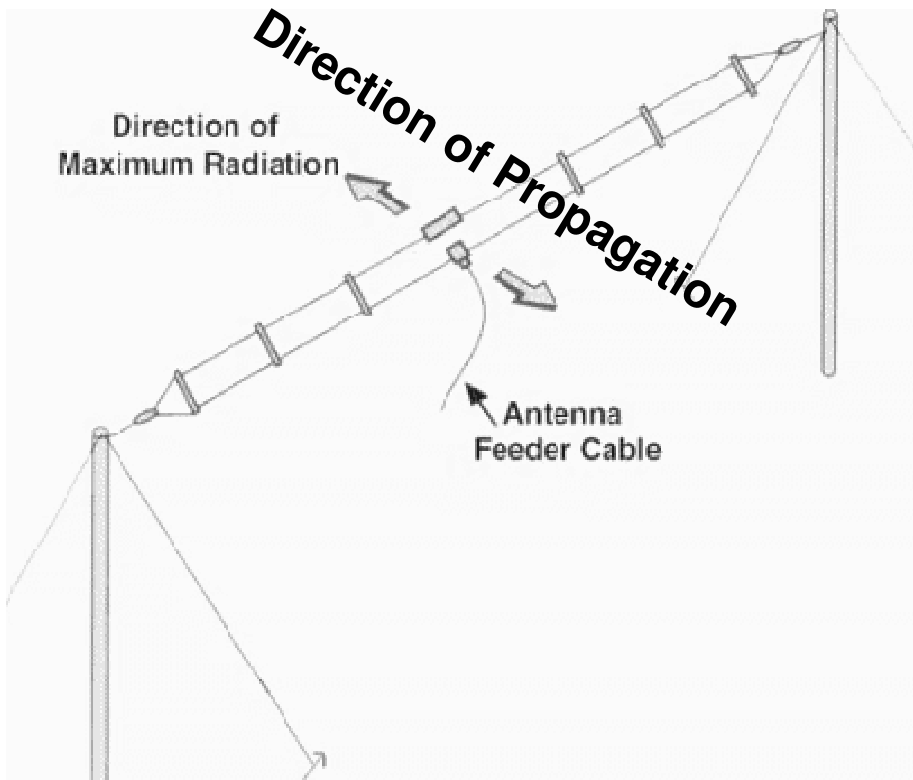
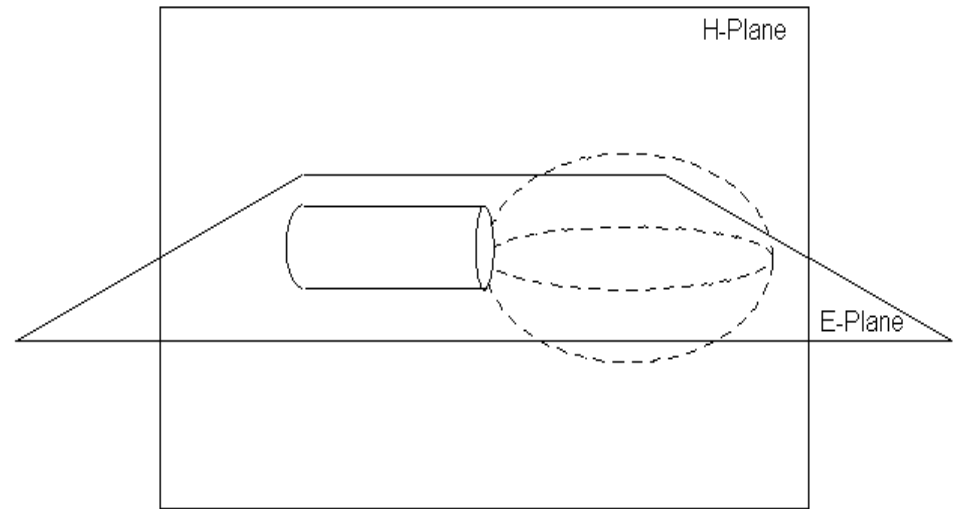
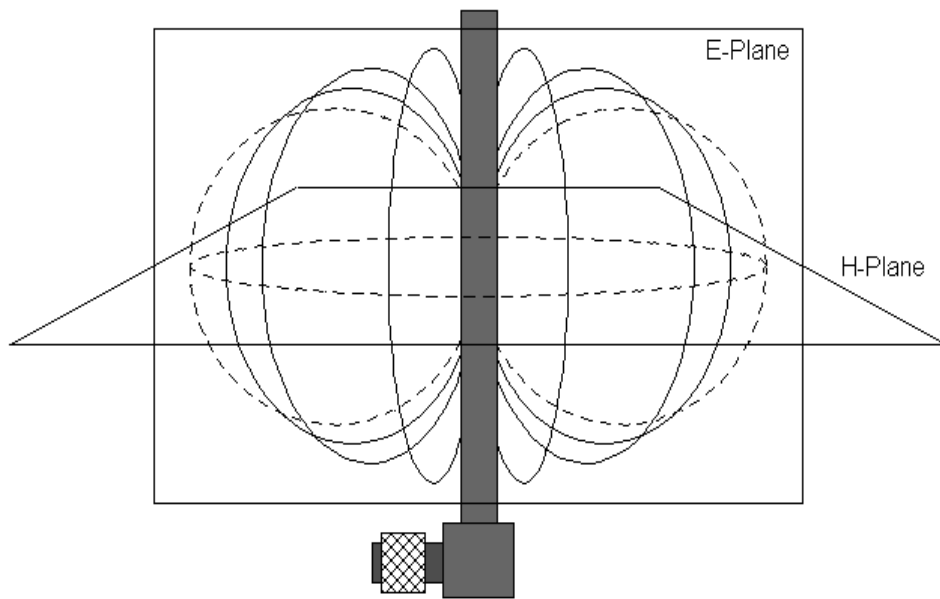

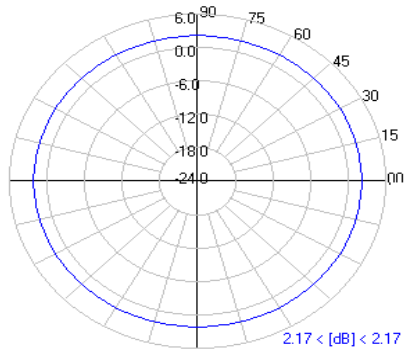
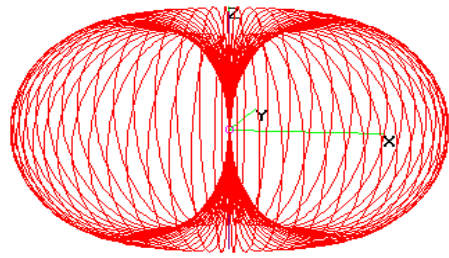

AZIMUTH

$2.17 < [dB] < 2.17$

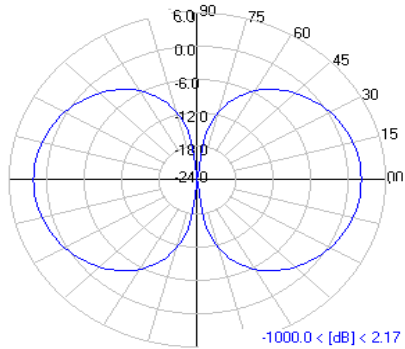

ELEVATION

$-1000.0 < [dB] < 2.17$

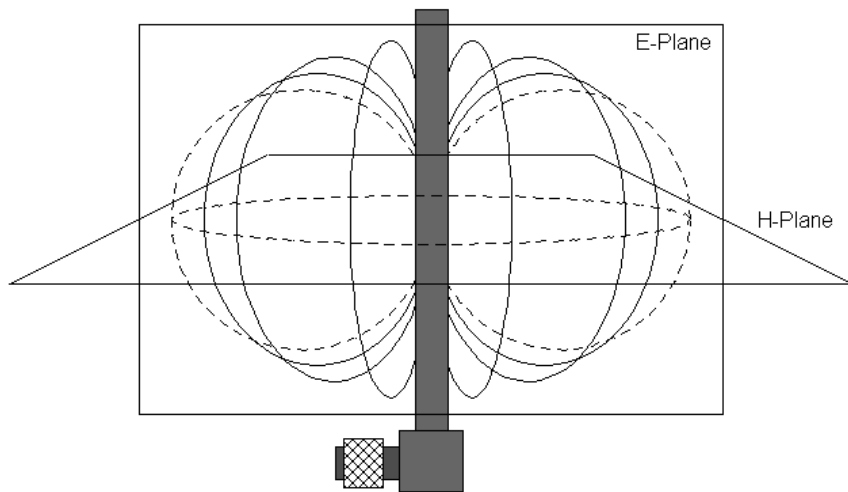
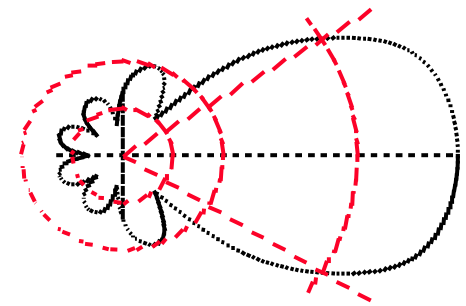
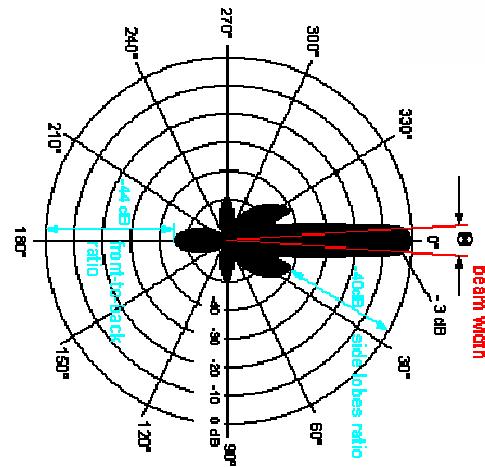
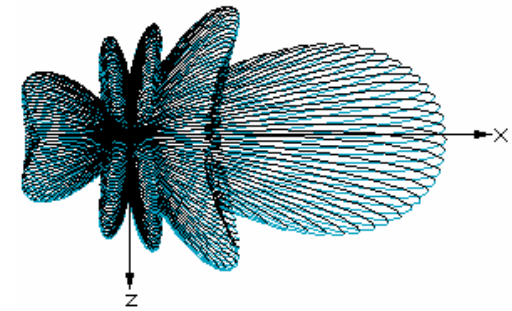

Vertically polarized omnidirectional dipole antenna

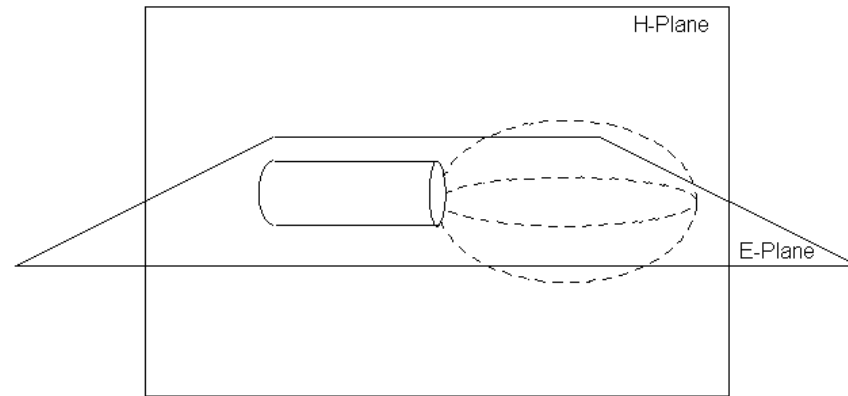

Horizontally polarized directional yagi antenna

RADIO WAVES CONT'D

Lesson 7

From: Emergency Management Ontario

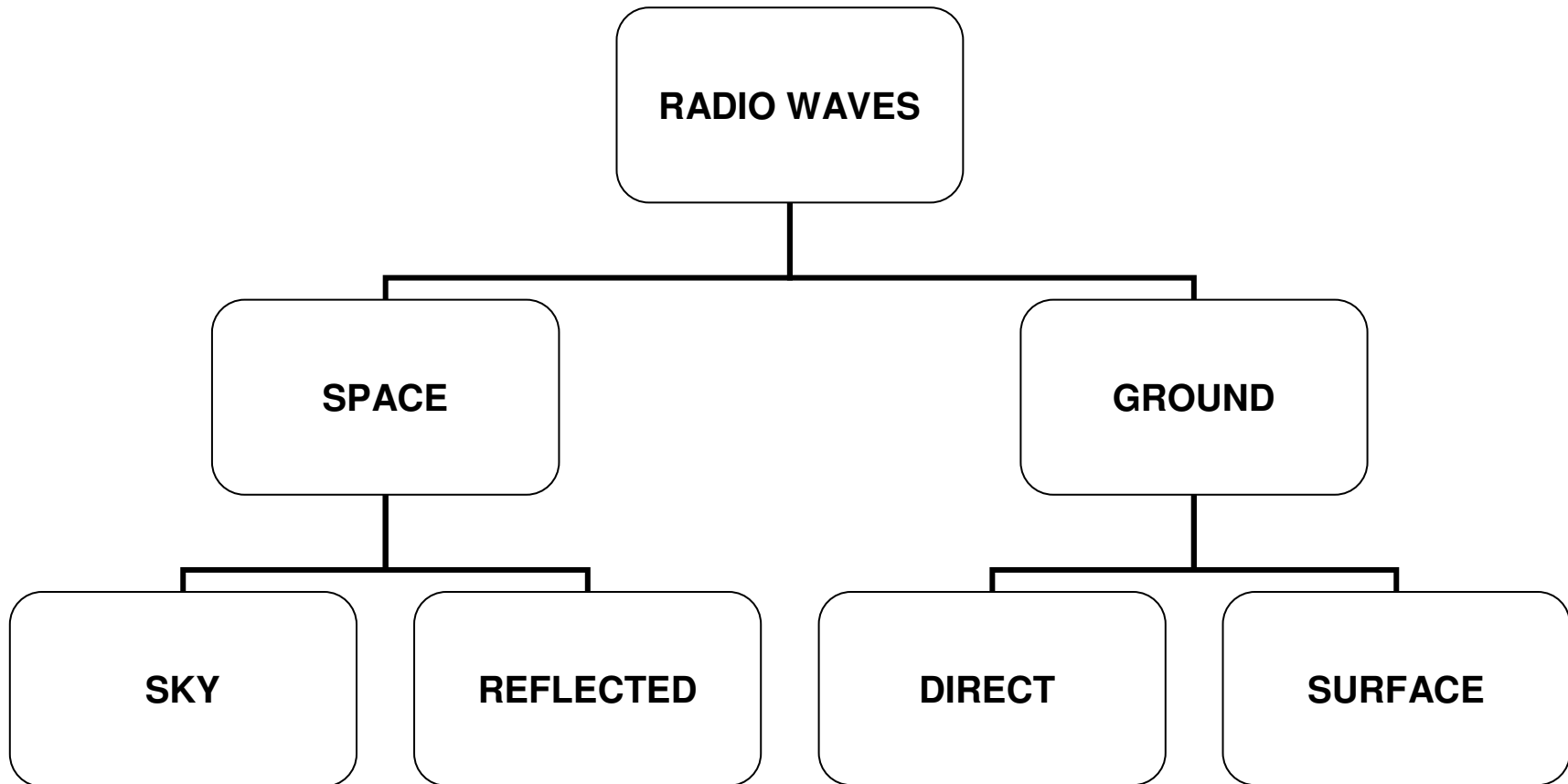

LINE OF SIGHT, GROUND WAVE, SKY WAVE

Lesson 7

From: Emergency Management Ontario

- **Ground Wave** is a surface wave that propagates close to the surface of the Earth.
- **Line of Sight** (Ground wave or Direct Wave) is propagation of waves travelling in a straight line. The rays or waves are deviated or reflected by obstructions and cannot travel over the horizon or behind obstacles. Most common of the radio propagation modes at VHF and higher frequencies. At higher frequencies and in lower levels of the atmosphere, any obstruction between the transmitting antenna and the receiving antenna will block the signal, just like the light that the eye senses
- **Space Waves**: travel directly from an antenna to another without reflection on the ground. Occurs when both antennas are within line of sight of each other, distance is longer than line of sight because most space waves bend near the ground and follow practically a curved path. Antennas must display a very low angle of emission in order that all the power is radiated in direction of the horizon instead of escaping in the sky. A high gain and horizontally polarized antenna is thus highly recommended.
- **Sky Wave** (Skip/ Hop/ Ionospheric Wave) is the propagation of radio waves bent (refracted) back to the Earth's surface by the ionosphere. HF radio communication (between 3 and 30 MHz) is a result of skywave propagation.

LINE OF SIGHT, GROUND WAVE, SKY WAVE

Lesson 7

From: Emergency Management Ontario

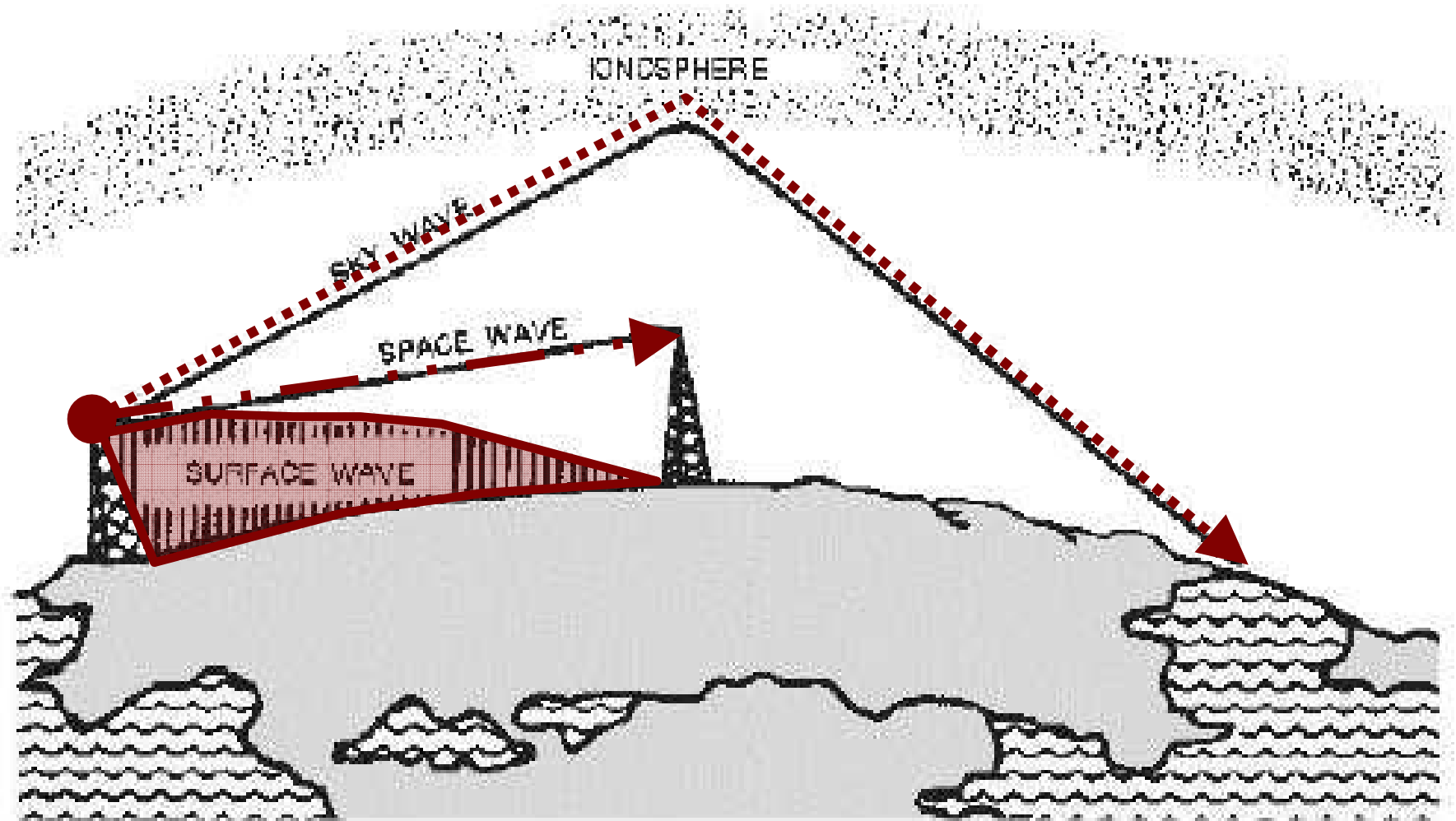

LINE OF SIGHT, GROUND WAVE, SKY WAVE CONT'D

Lesson 7

From: Emergency Management Ontario

The range of sky-wave propagation **is much longer** than ground-wave propagation. RAC: 6.2
When a signal is returned to earth by the ionosphere, this is called **sky-wave propagation**.

RAC: 6.2

VHF signals are propagated within the range of the visible horizon **by direct wave**. RAC: 6.2
Line-of-sight propagation usually occurs from one hand-held VHF transceiver to another nearby. RAC: 6.2

That portion of the radiation which is directly affected by the surface of the earth is called **ground wave**. RAC: 6.2

A line of sight transmission between two stations uses mainly the **ground wave**. RAC: 6.2

The distance travelled by ground wave is **less at higher frequencies**. RAC: 6.3

The radio wave which follows a path from the transmitter to the ionosphere and back to earth is known correctly as the **ionospheric wave**. RAC: 6.3

Reception of high frequency (HF) radio waves beyond 4000 km is generally possible by **ionospheric wave**. RAC: 6.3

Skywave is another name for **ionospheric wave**. RAC: 6.2

IONOSPHERE REGIONS

Lesson 7

From: Emergency Management Ontario

- The ionosphere is the uppermost part of the atmosphere, it is ionized by solar radiation.
- Ionization is converting an atom or molecule into an ion by light (heating up or charging) from the sun on the upper atmosphere.
- Creates an horizontally stratified medium where each layer has a peak density and a definable width, or profile.

Thus, it influences radio propagation

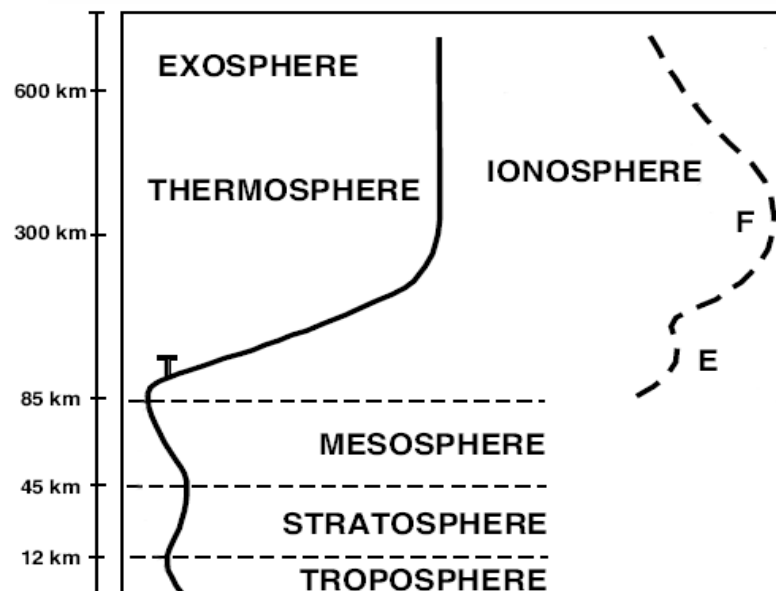
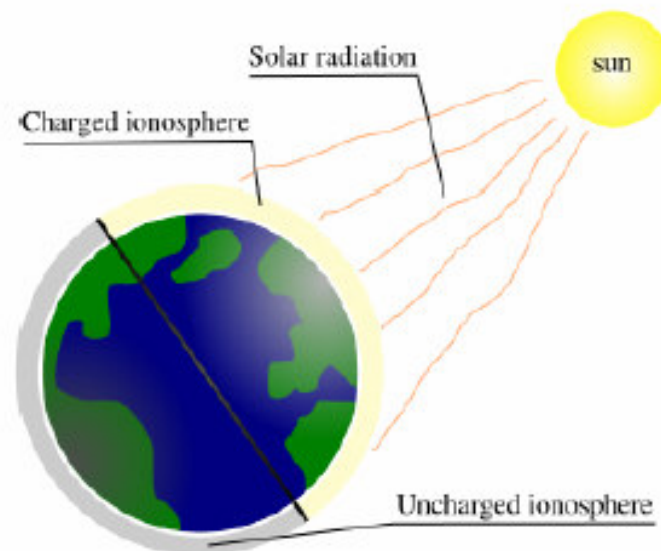

IONOSPHERE REGIONS

Lesson 7

From: Emergency Management Ontario

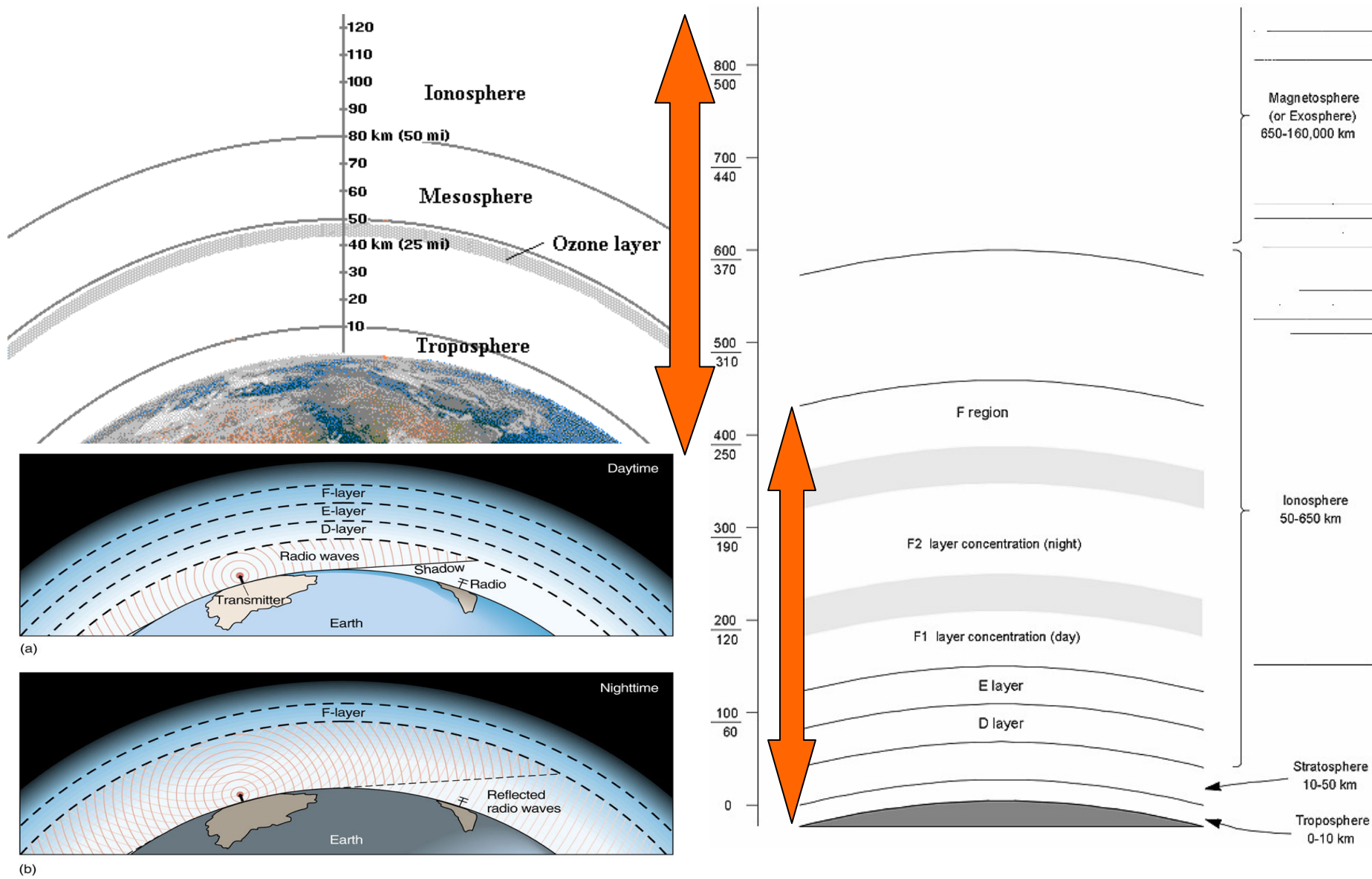

IONOSPHERE REGIONS CONT'D

Lesson 7

From: Emergency Management Ontario

Solar radiation ionizing the outer atmosphere causes the ionosphere to form. RAC: 6.3

Ultraviolet solar radiation is most responsible for ionization in the outer atmosphere. RAC: 6.3

The ionosphere is most ionized at **midday**. RAC: 6.3

The ionosphere is least ionized **shortly before dawn**.

The **D** ionospheric region is closest to the earth. RAC: 6.3

The **D** region of the ionosphere is the least useful for long-distance radio-wave propagation.

RAC: 6.3

The main reason the 160, 80 and 40 metre amateur bands tend to be useful only for short-distance communications during daylight hours is because of **D-region absorption**.

RAC: 6.9

The position of the E layer in the ionosphere is **below the F layer**. RAC: 6.3

During the day, one of the ionospheric layers splits into two parts called **F1 & F2**. RAC: 6.3

The **F1 and F2** sub-regions of the ionosphere exist only in the daytime. RAC: 6.3

The F2 region is mainly responsible for the longest-distance radio-wave propagation **because it is the highest ionospheric region**. RAC: 6.3

PROPAGATION, HOPS, SKIPS ZONES

Lesson 7

From: Emergency Management Ontario

- **Multihop:** via the F2-layer can reach DX stations in doing several hops communicating on the other side of the Earth.
- It's subject to fading and attenuation each time the radio wave is reflected or partially refracted at either the ground or ionosphere results in loss of energy signals, can also be stable with few attenuation if the ionospheric absorption is very weak.

• 20 and 15m are the best for this type of traffic. In these bands you can work stations located over 10000 km away, and, from Europe.

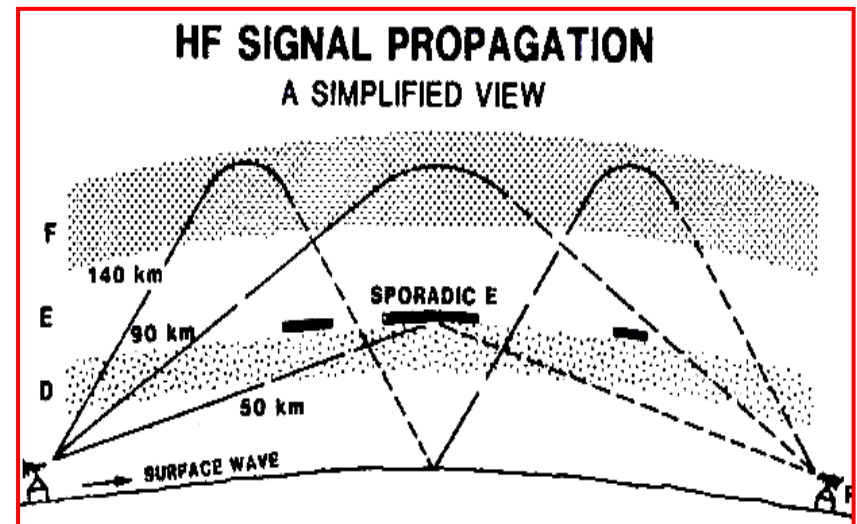

PROPAGATION, HOPS, SKIPS ZONES

Lesson 7

From: Emergency Management Ontario

- **Attenuation**: when the distance doubles, the signal becomes half less strong. obstacles placed between emitter, receiver, and travelling around the earth; radio waves lose their energy as they forced to bend to follow the earth curvature.
- **Reflection**: similar to its optical counterpart as wave enters in contact with a surface. Long wavelengths, from 80 meters long and above don't practically "see" small obstacles like cars, trees or buildings. These objects are proportionally too small can't reflect its energy. The long waves pass thus across these materials without be reflected. Due to its large surface, long waves are however reflected by the ground and can penetrate it up to some meters depth. V/UHF waves (2m and 70 cm long) are on the contrary very sensitive to small obstacles. Depending of their thickness metal objects can be used as reflectors.
- **Refraction**: the bending of waves that occurs when they pass through a medium (air or ionosphere) produce variation in the velocity of waves that tend to go further or dropping sooner that expected. For example, the wave refracts and bend gradually given the appearance that the path is curved.

PROPAGATION, HOPS, SKIPS ZONES

Lesson 7

From: Emergency Management Ontario

- **Diffraction**: due to its high frequency bends around the edge of the object and tends to make the borders of it lighter. That means that some light reaches well some places that we considered as plunged into darkness. The same effect applies to radio waves. A spot located out of sight from a transmitter, say behind a hill, can receive weakly its emissions because its signals are bending gradually by diffraction and can reach the remote receiver. This effect has practically no influence in HF because waves arrive usually to the receiver by many other means such as refraction or reflection in the upper atmosphere, including sometimes ground waves if the transmitter is not too far (say 150-200 km away).
- **Skip Zone**: the region between the furthest transmission points and the nearest point refracted waves can be received. Within this region, no signal can be received as there are no radio waves to receive.
- **Skip Distance**: the least distance between point of transmission and the point of reception



Refraction is the change in direction of a wave due to a change in its speed

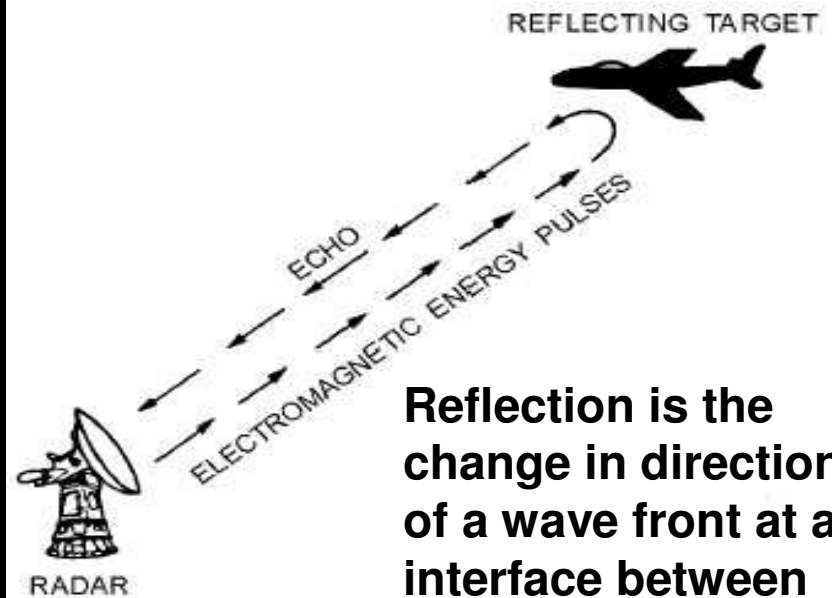
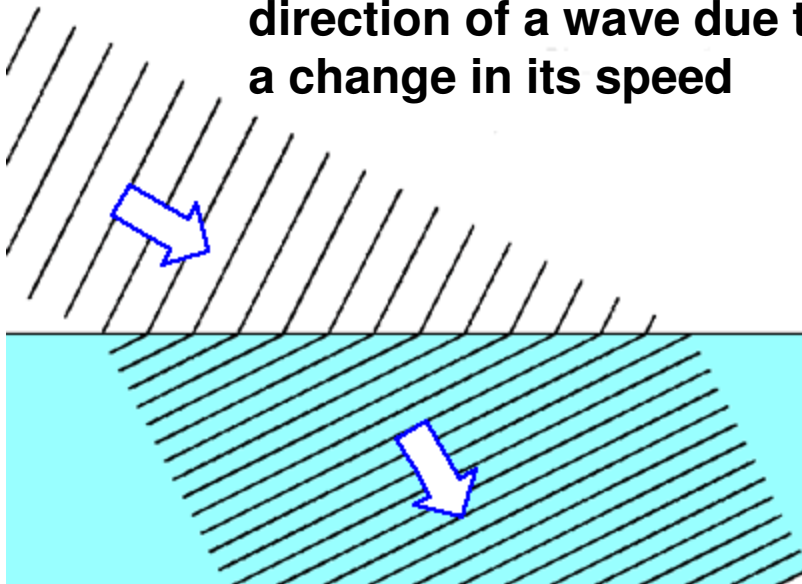

Reflection is the change in direction of a wave front at an interface between two different media

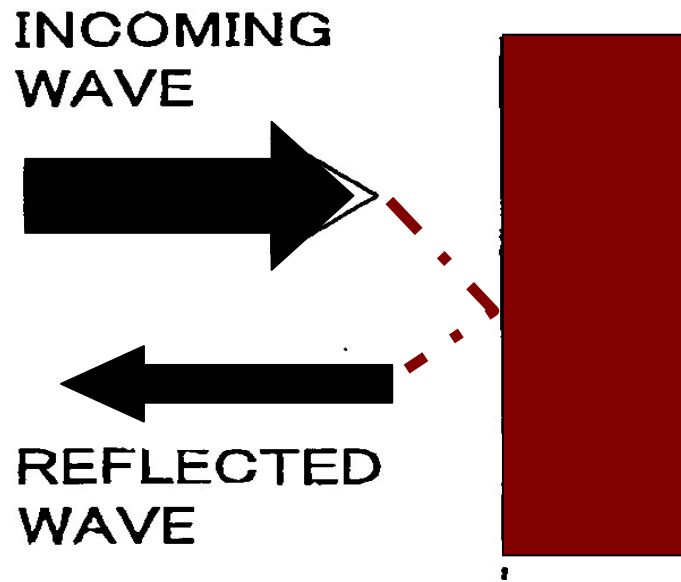

Attenuation is the reduction in amplitude and intensity of a signal. Can also be understood to be the opposite of amplification. Attenuation is important in determining signal strength as a function of distance

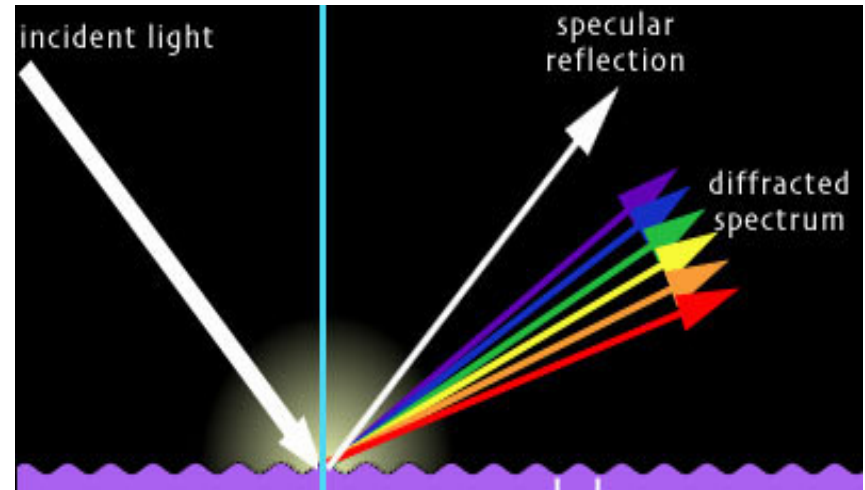
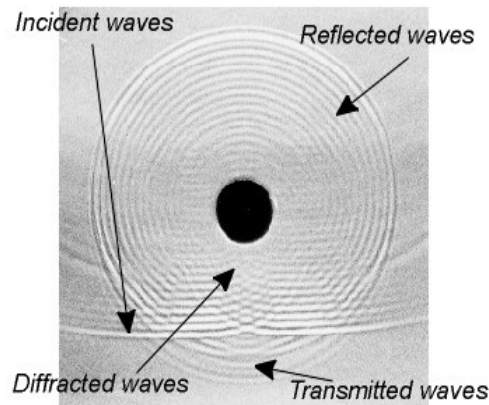

Diffraction refers to various phenomena associated with wave propagation, such as the bending, spreading and interference of waves passing by an object or aperture that disrupts the wave



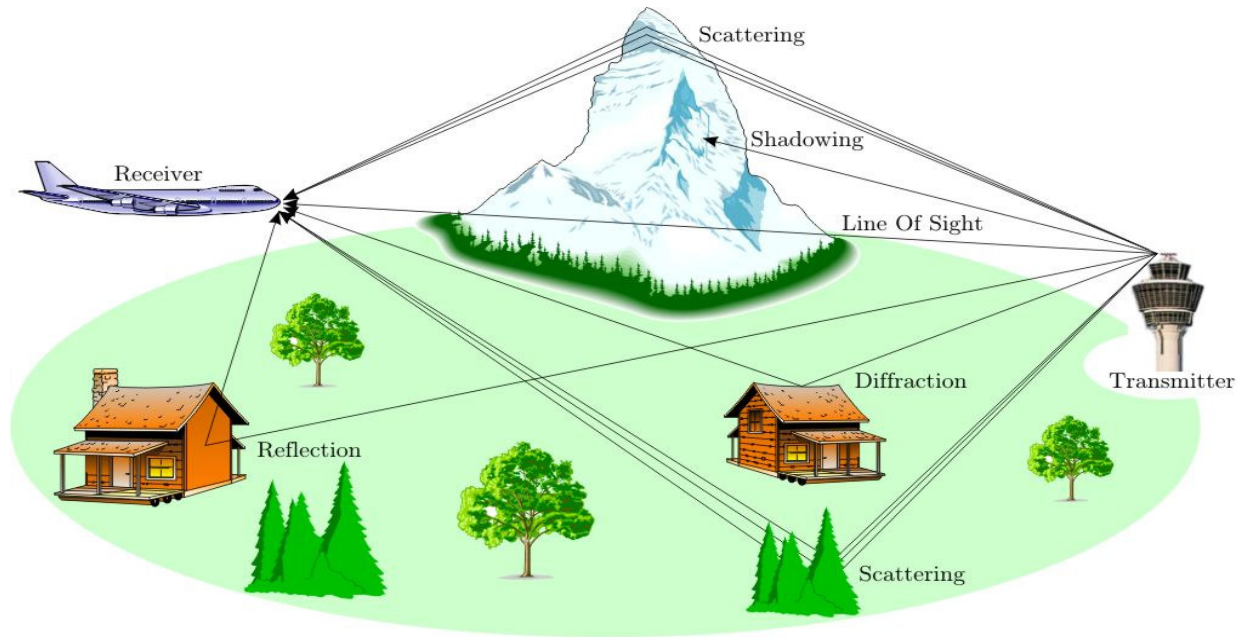
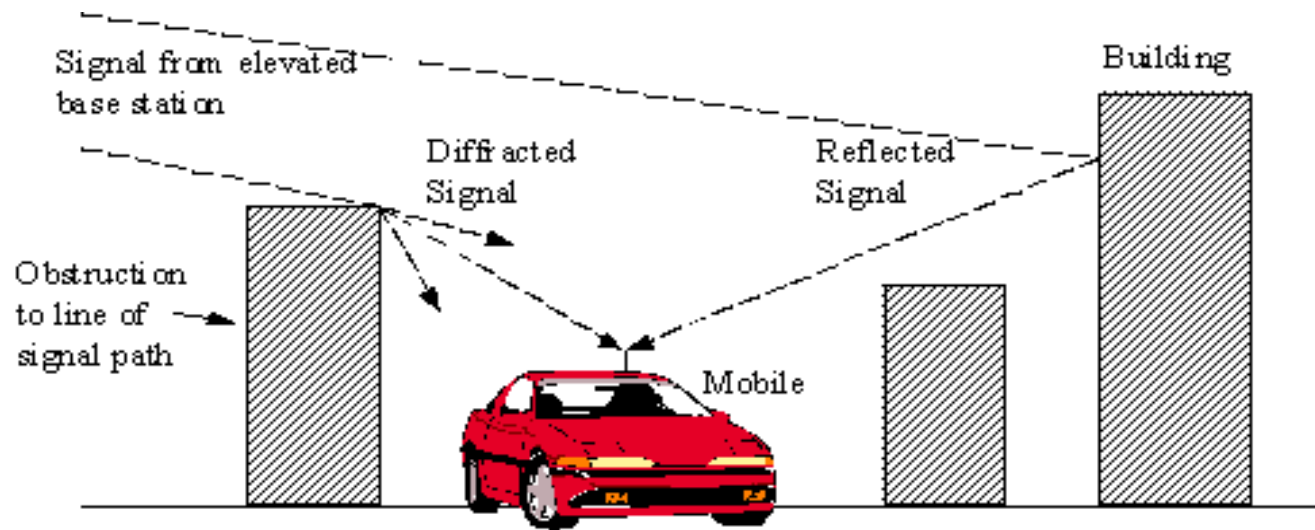

Forms of Propagation Found When Using VHF and UHF Communications

PROPAGATION, HOPS SKIPS ZONES

Lesson 7

From: Emergency Management Ontario

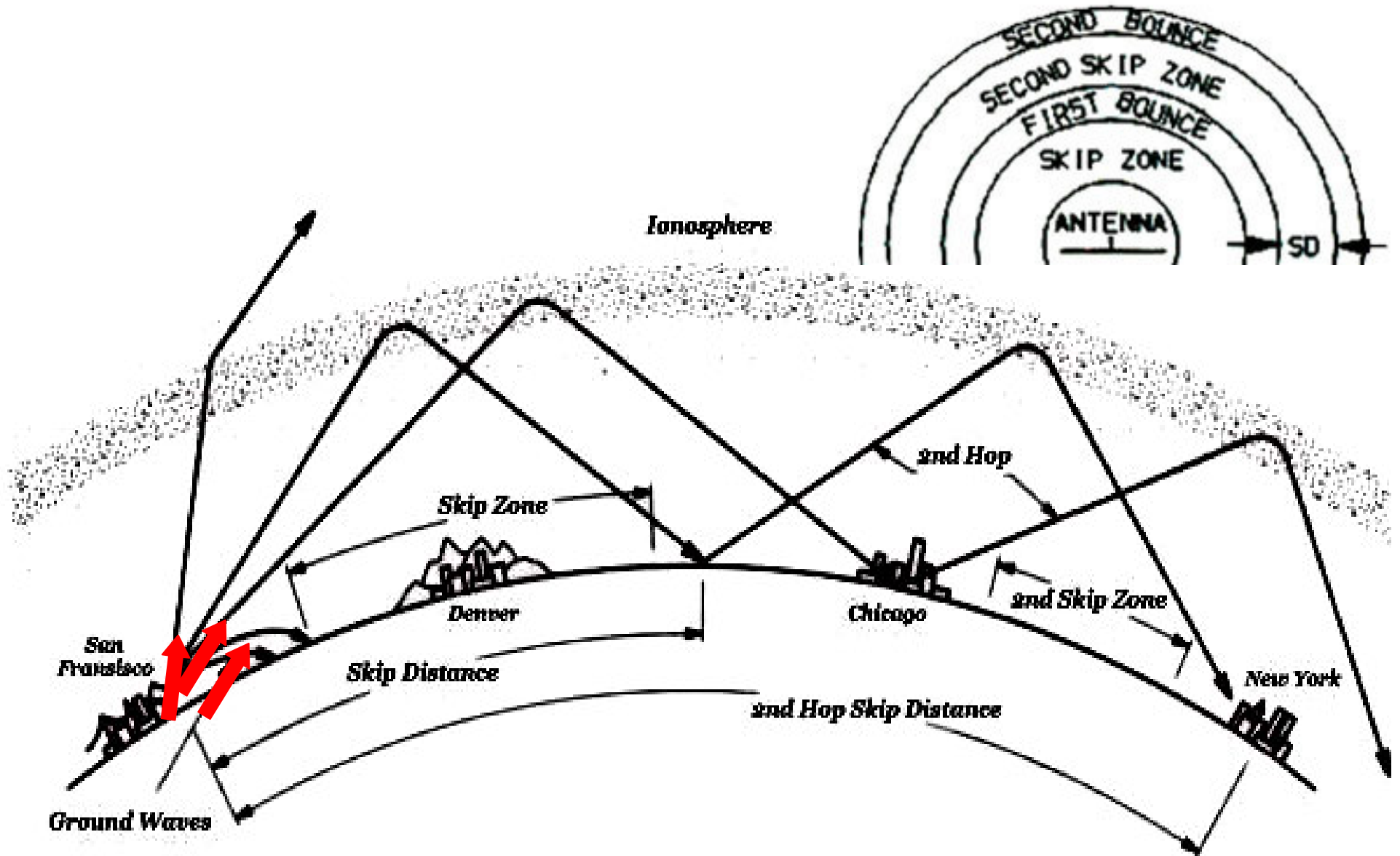

PROPAGATION, HOPS SKIPS ZONES CONT'D

Lesson 7

From: Emergency Management Ontario

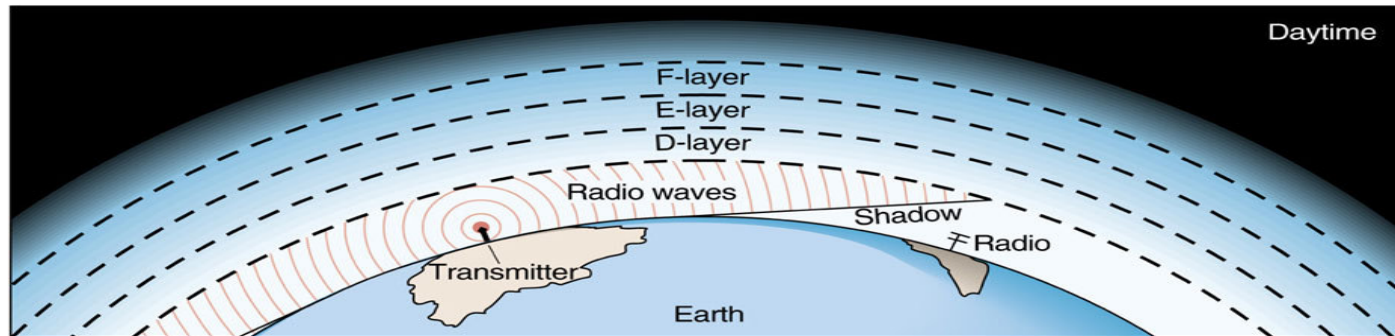

(a)

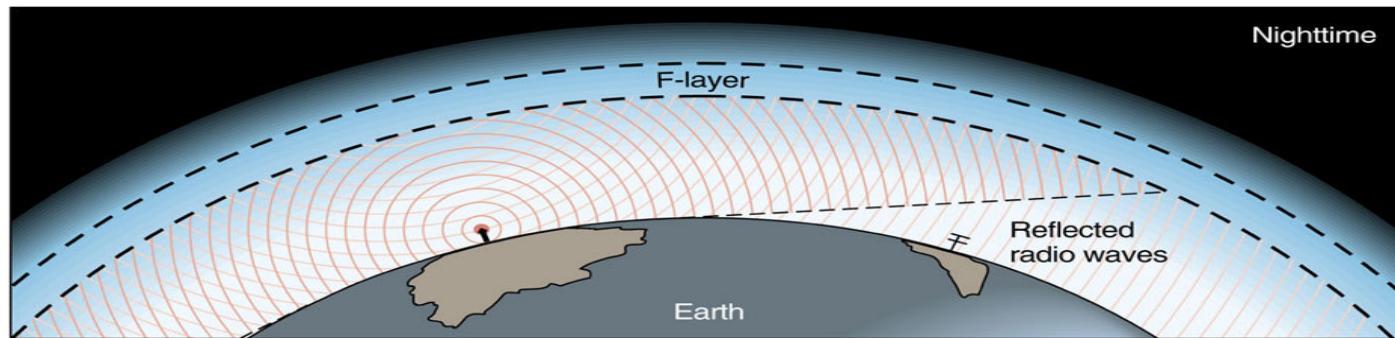

(b)

The maximum distance along the earth's surface that is normally covered in one hop using the F2 region is 4000 Km (2500 miles).

The maximum distance along the earth's surface that is normally covered in one hop using the E region is 2000 Km (1200 miles)

The distance to Europe from your location is approximately 5000 Km. Multihop propagation is most likely to be involved.

THE IONOSPHERIC LAYERS

Lesson 7

From: Emergency Management Ontario

The D layer: is the innermost layer, 50 km to 90 km above the surface of the Earth. when the sun is active with 50 or more sunspots, During the night cosmic rays produce a residual amount of ionization as a result high-frequency (HF) radio waves aren't reflected by the D layer. **The D layer is mainly responsible for absorption of HF radio waves**, particularly at 10 MHz and below, with progressively smaller absorption as the frequency gets higher. The **absorption is small at night and greatest about midday**. The layer reduces greatly after sunset. A common example of the D layer in action is the disappearance of distant AM broadcast band stations in the daytime.

The E layer: is the middle layer, 90 km to 120 km above the surface of the Earth. This layer can only reflect radio waves having frequencies less than about 10 MHz. It has a negative effect on frequencies above 10 MHz due to its partial absorption of these waves. At night the E layer begins to disappear because the primary source of ionization is no longer present. The increase in the height of the E layer maximum increases the range to which radio waves can travel by reflection from the layer.

The F layer: or region, is 120 km to 400 km above the surface of the Earth. It is the top most layer of the ionosphere. Here extreme ultraviolet (UV) (10-100 nm) solar radiation ionizes atomic oxygen (O). The F region is the most important part of the ionosphere in terms of HF communications. The F layer combines into one layer at night, and in the presence of sunlight (during daytime), it divides into two layers, the **F1 and F2**. The F layers are responsible for most skywave propagation of radio waves, and are thickest and most reflective of radio on the side of the Earth facing the sun.

PROPAGATION, HOPS SKIPS ZONES CONT'D

Lesson 7
From: Emergency Management Ontario

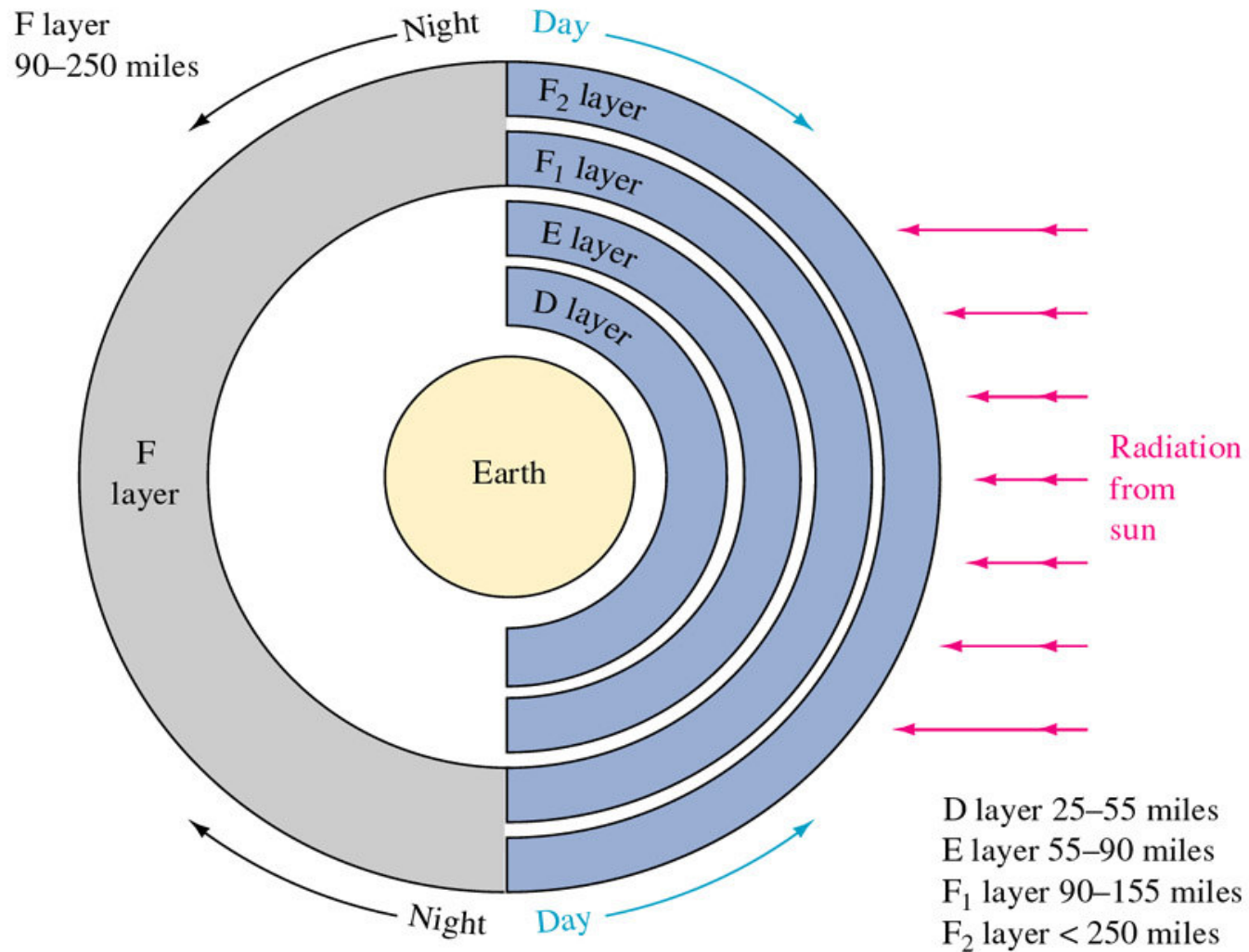

THE IONOSPHERIC LAYERS CONT'D

Lesson 7

From: Emergency Management Ontario

Ionospheric Storms: Solar activity such as flares and coronal mass ejections produce large electromagnetic radiation incident upon the earth. It leads to disturbances of the ionosphere and changes the density distribution, electron content, and the ionospheric current system. Can disrupt satellite communications and cause a loss of radio frequencies previously reflecting off the ionosphere. Ionospheric storms can last typically for a day or so.

When the ionosphere is strongly charged (daytime, summer, much solar activity) longer waves will be absorbed and never return to earth. You don't hear distant AM broadcast stations during the day. Shorter waves will be reflected and travel further. **Absorption occurs in the D layer** which is the lowest layer in the ionosphere. The intensity of this layer is increased as the sun climbs above the horizon and is greatest at noon. Radio waves below 3 or 4 MHz are absorbed by the D layer when it is present.

When the ionosphere is weakly charged (night time, winter, low solar activity) longer waves will travel a considerable distance but shorter waves may pass through the ionosphere and escape into space. VHF waves pull this trick all the time, hence their short range and usefulness for communicating with satellites.

Faraday Rotation: EM waves passing through the ionosphere may have their polarizations changed to random directions. Waves decomposed into two circularly polarized rays which propagate at different speeds. The rays can re-combine upon emergence from the ionosphere, however owing to the difference in propagation speed they do so with a net phase offset, resulting in a rotation of the angle of linear polarization.

THE IONOSPHERIC LAYERS CONT'D

Lesson 7

From: Emergency Management Ontario

- Solar radiation, acting on the different compositions of the atmosphere generates layers of ionization
- Studies of the ionosphere have determined that there are at least four distinct layers of D, E, F1, and F2 layers.
- The F layer is a single layer during the night and other periods of low ionization, during the day and periods of higher ionization it splits into two distinct layers, the F1 and F2.
- There are no clearly defined boundaries between layers. These layers vary in density depending on the time of day, time of year, and the amount of solar (sun) activity.
- The top-most layer (F and F1/F2) is always the most densely ionized because it is least protected from the Sun.

ABSORPTION AND FADING

Lesson 7

From: Emergency Management Ontario

- Fading of signals is the effect at a receiver due to a disturbed propagation path. A local station will come in clearly, a distant station may rise and fall in strength or appear garbled. Fading may be caused by a variety of factors:
- **A reduction of the ionospheric ionization level near sunset.**
- **Multi-path propagation:** some of the signal is being reflected by one layer of the ionosphere and some by another layer. The signal gets to the receiver by two different routes. The received signal may be enhanced or reduced by the wave interactions. In essence, radio signals' reaching the receiving antenna by two or more paths. Causes include atmospheric ducting, ionospheric reflection and refraction, and reflection from terrestrial objects, such as mountains and buildings.
- **Increased absorption as the D layer builds up during the morning hours.**
- Difference in path lengths caused by **changing levels of ionization** in the reflecting layer.
- **E layer starts to disappear** radio waves will pass through and be reflected by the F layer, thus causing the skip zone to fall beyond the receiving station.
- **Selective fading:** creates a hollow tone common on international shortwave AM reception. The signal arrives at the receiver by two different paths, and at least one of the paths is changing (lengthening or shortening). This typically happens in the early evening or early morning as the various layers in the ionosphere move, separate, and combine. The two paths can both be skywave or one be groundwave.

ABSORPTION AND FADING

Lesson 7

From: Emergency Management Ontario

The **ionization of the D region** causes the ionosphere to absorb radio waves. RAC: 6.3

The D region of the ionosphere **absorbs** lower-frequency HF signals in the daytime. RAC: 6.3

Two or more parts of the radio wave follow different paths during propagation and this may result in phase differences at the receiver. This “change” at the receiver is called **fading**. RAC: 6.4

A change or variation in signal strength at the antenna, caused by differences in path lengths, is called **fading**. RAC: 6.4

When a transmitted radio signal reaches a station by a one-hop and two-hop skip path, small changes in the ionosphere can cause **variations in signal strength**. RAC: 6.4

The usual effect of ionospheric storms is to **cause a fade-out of sky-wave signals**. RAC: 6.6

On the VHF and UHF bands, polarization of the receiving antenna is very important in relation to the transmitting antenna, yet on HF bands it is relatively unimportant. This is because **the ionosphere can change the polarization** of the signal from moment to moment.

Polarization change often takes place on radio waves that are propagated over long distances. **Reflections, passage through magnetic fields (Faraday rotation) and refractions all cause polarization change.**

ABSORPTION AND FADING

Lesson 7

From: Emergency Management Ontario

Phase differences between radio wave components of the same transmission, as experienced at the receiving station cause selective fading.

Selective fading is **more pronounced at wide bandwidths**.

Reflection of a SSB transmission from the ionosphere causes **little or no phase-shift distortion**.

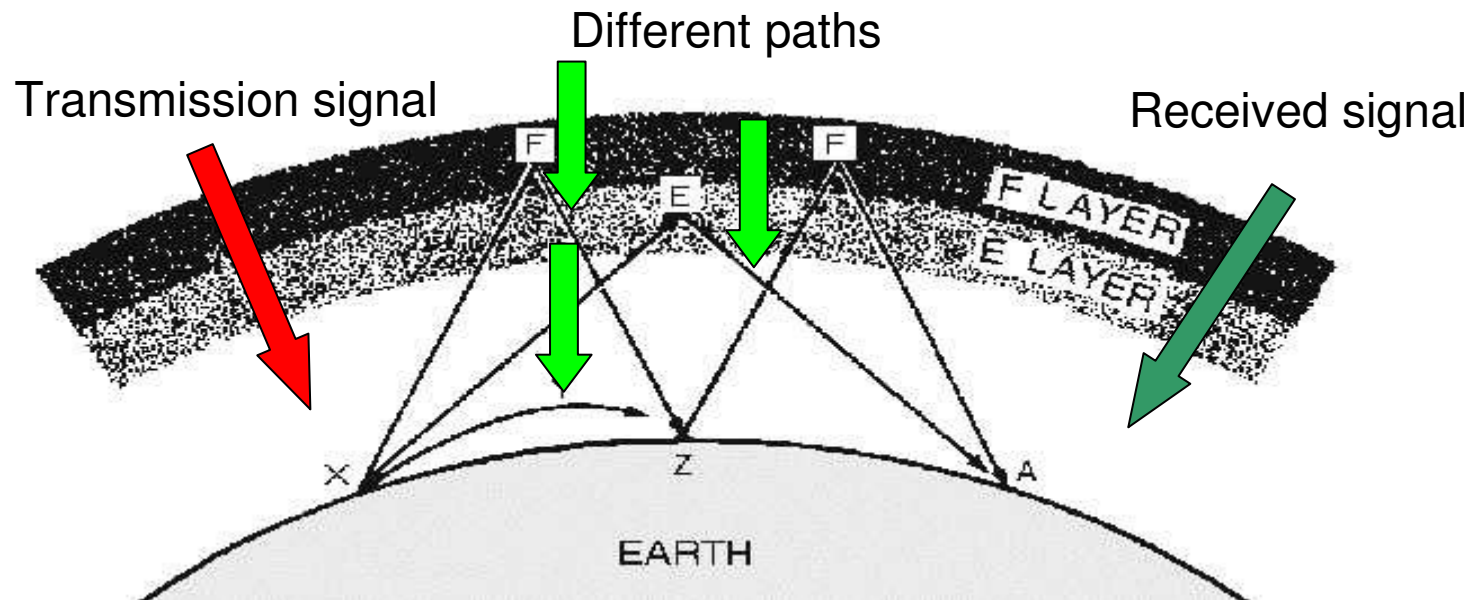

SOLAR ACTIVITY AND SUN SPOTS

Lesson 7

From: Emergency Management Ontario

- The most critical factor affecting radio propagation is solar activity and the sunspot cycle. Sunspots are cooler regions where the temperature may drop to a frigid 4000K. Magnetic studies of the sun show that these are also regions of very high magnetic fields, up to 1000 times stronger than the regular magnetic field.
- Our Sun has sunspot cycle of about 22 years which reach both a minima and maxima (**we refer to a 11 year low and high point or cycle**). When the sunspots are at their maximum propagation is at its best.
- Ultraviolet radiation from the sun is the chief (though not the only) source of ionization in the upper atmosphere. During periods of low ultraviolet emission the ionization level of the ionosphere is low and radio signals with short wavelengths will pass through and be lost to space. During periods of high ultraviolet emission higher levels of ionization reflect higher frequencies and shorter wavelengths will propagate much longer distances.

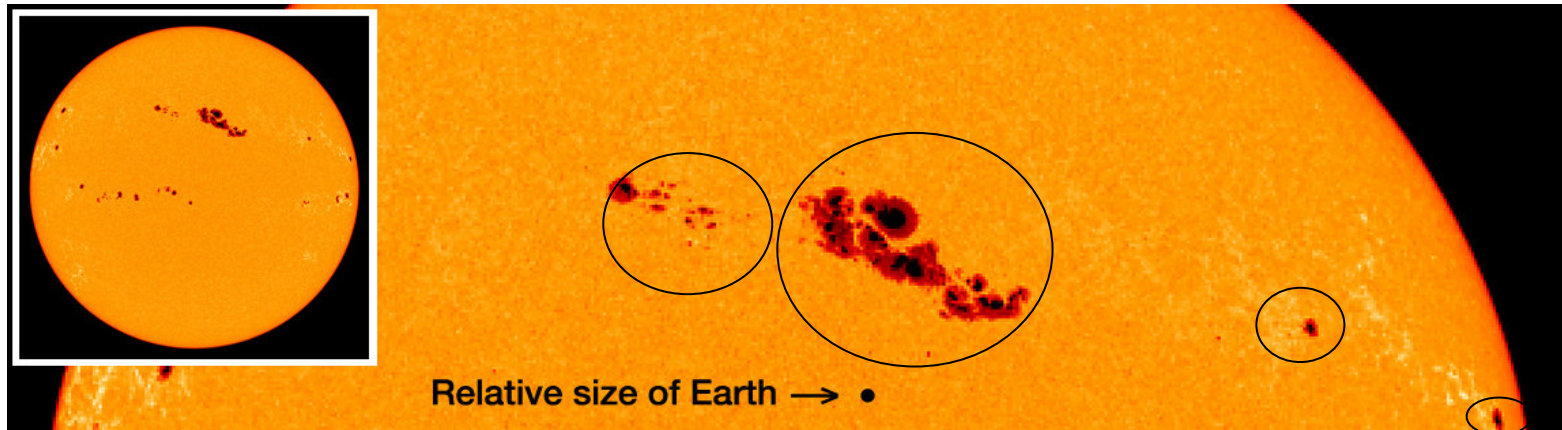

SOLAR ACTIVITY AND SUN SPOTS CONT'D

Lesson 7

From: Emergency Management Ontario

Emission of larger amounts of ultraviolet radiation corresponds to increased surface activity on the sun.

Length of a solar cycle can vary by one or two years in either direction from the 22 and 11 year average but it has remained near this value throughout geologic time.

Solar maxima can also lead to highly variable propagation conditions due to periods of disturbance during solar magnetic disturbances (*solar storms*) which occur at this period.

Solar Flux (Index): is a measure of the radio energy emitted from the sun. The solar flux value is considered to be one of the best ways of relating solar activity to propagation. When sun spot cycles hit their peaks the solar flux may have a value over 200. When the sun spot cycle is at its lowest point the solar flux values can be as low as 50 or 60. The higher the solar flux value the better propagation will be.

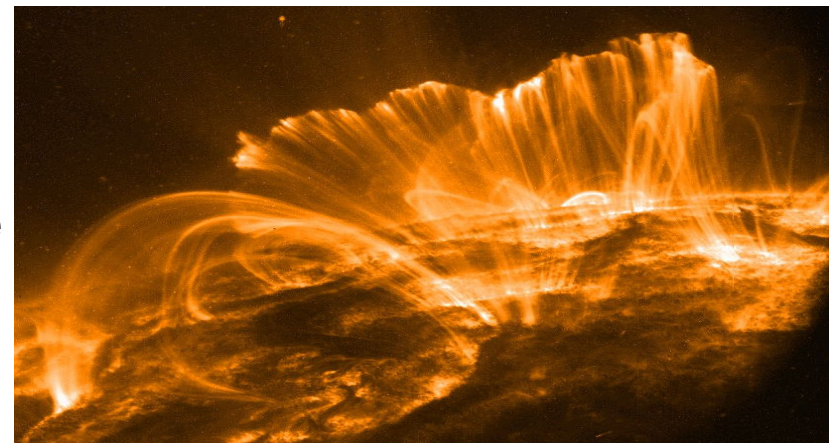
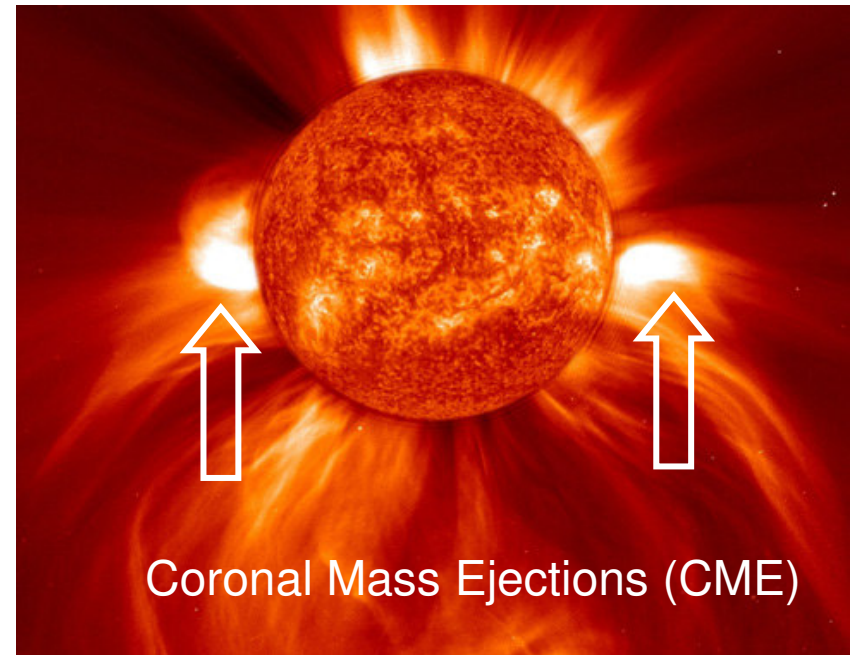

SOLAR ACTIVITY AND SUN SPOTS CONT'D

Lesson 7

From: Emergency Management Ontario

- Electromagnetic emissions and particle emissions hit the Earth's ionosphere at various speeds with different energy levels. Effects of their impact varies accordingly but mainly with sky waves. The particles emitted are accompanied by a tiny pulse of electromagnetic radiation. Electromagnetic and particle radiations can potentially modify the ionosphere and affect its properties.
- Electromagnetic emissions hit first the F-layer of the ionosphere increasing its ionization; atoms and molecules warm up and free one or more electrons. The higher the solar activity, the stronger the ionization of the F-layer. A strong ionization of the F-layer increases its reflecting power. Stronger the ionization, the higher the **maximum usable frequency (MUF)**, exceeding regularly 40 or 50 MHz in such occasions.
- Particle emissions are constituted of high-energy protons electrons forming solar cosmic rays when the sun releases huge amount of energy in Coronal Mass Ejections (CME). These particles of protons and heavy nuclei propagate into space, creating a shockwave. The pressure created by the particles clouds is huge and has a large effect on the ionosphere communications are interrupted.

SOLAR ACTIVITY AND SUN SPOTS

Lesson 7

From: Emergency Management Ontario

All communication frequencies throughout the spectrum are affected in varying degrees by the **sun**. RAC: 6.6

Solar activity influences all radio communication beyond ground-wave or line-of-sight ranges. RAC: 6.6

Solar flux is the **radio energy emitted by the sun**.

The solar-flux index is a **measure of solar activity** that is taken at a specific frequency. RAC: 6.6

Two types of radiation from the sun that influence propagation are **electromagnetic and particle emissions**. RAC: 6.6

The ability of the ionosphere to reflect high frequency radio signals depends on the **amount of solar radiation**. RAC: 6.6

The greater the ionization of the atmosphere the **more sunspots** there are.

An average sunspot (propagation) cycle is **11 years** long. RAC: 6.6

When sunspot numbers are high, **frequencies up to 40 MHz or higher are normally usable for long-distance communication**. RAC: 6.6

MF, HF CRITICAL FREQUENCIES

Lesson 7

From: Emergency Management Ontario

- **Critical Frequency:** the penetrating frequency and the highest frequency at which a radio wave, if **directed vertically upward**, will be refracted back to earth by an ionized layer. Radio waves at a frequency above the Critical Frequency will not be refracted/reflected. This will create a zone around the transmitter that will not receive signals known as the Skip Zone. The size of this zone will vary with the layer in use and the frequency in use.
 - **Maximum Usable Frequency (MUF):** the highest frequency that will be reflected back to earth by the ionized layers. Above this frequency there is no reflection and thus no skip. MUF depends on the layer that is responsible for refraction/reflection and so contact between two stations relying on skip will depend on the amount of sunspot activity, the time of day, and the time of year, latitude of the two stations and **antenna transmission angle**. The MUF is not significantly affected by transmitter power and receiver sensitivity
 - **Frequency of optimum transmission:** is the highest effective (i.e. working) frequency that is predicted to be usable for a specified path and time for 90% of the days of the month. It is often abbreviated as FOT and normally just below the value of the maximum usable frequency (MUF). The FOT is usually the most effective frequency for ionospheric reflection of radio waves between two specified points on Earth
 - **The lowest usable high frequency (LUF):** the frequency in the HF band at which the received field intensity is sufficient to provide the required signal-to-noise ratio. The amount of energy absorbed by the lower regions of the ionosphere (D region, primarily) directly impacts the LUF
- Angle of incidence:** is a measure of deviation of something from "straight on", for example in the approach of a ray to a surface.

MF, HF CRITICAL FREQUENCIES

Lesson 7

From: Emergency Management Ontario

Above Critical Frequency

Maximum Useful Frequency (MUF)

Frequency of optimum transmission (FOT) / Optimal Working Frequency (OWF)

Lower Absorption Frequency (ALF) / The lowest Usable frequency (LUF):

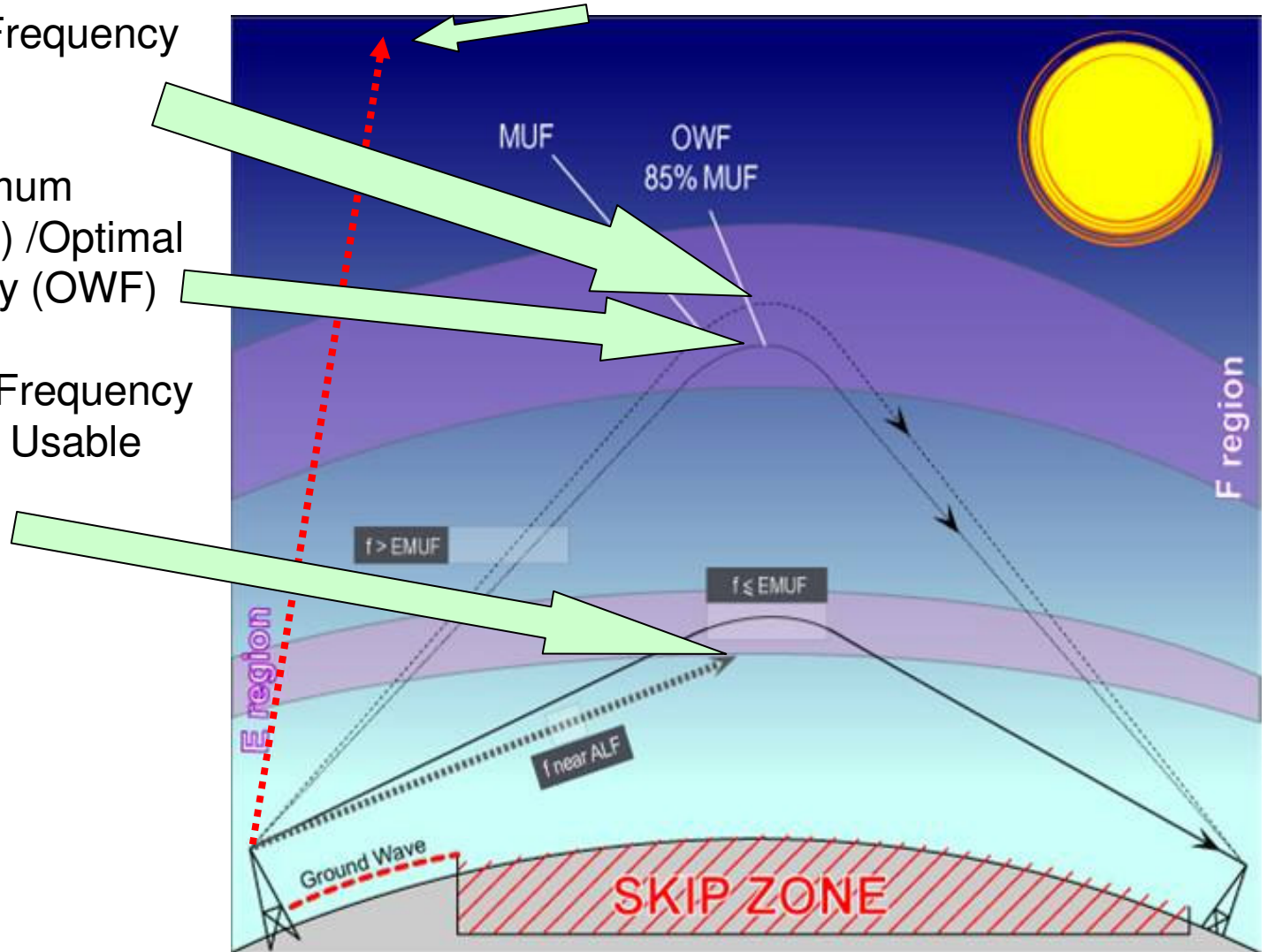

MF, HF CRITICAL FREQUENCIES

Lesson 7

From: Emergency Management Ontario

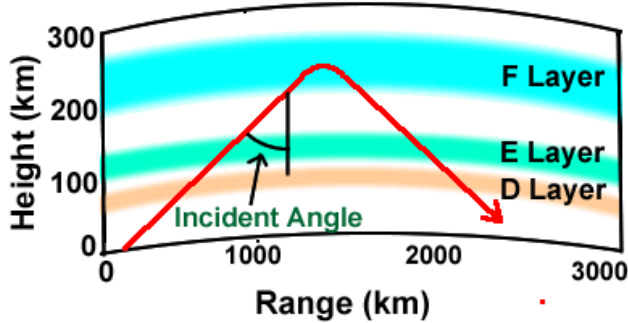

incident angle and refraction

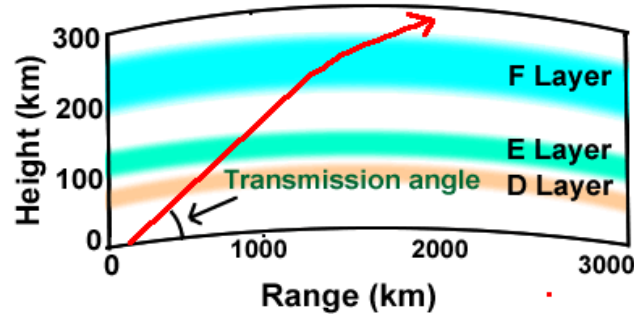

transmission angle is higher frequency than the MUF.

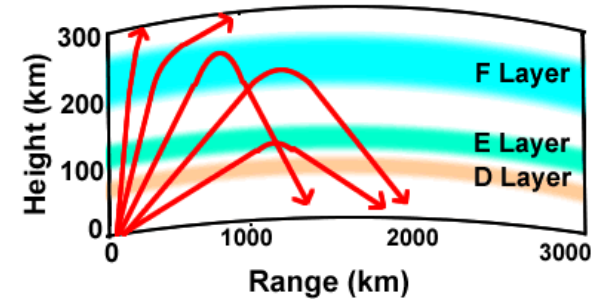

waves of the same frequency at several different transmission (and incident) angles

- **Earth's Geomagnetic Fields:** Activity in this field caused by interaction with charged particles from the sun can affect propagation.

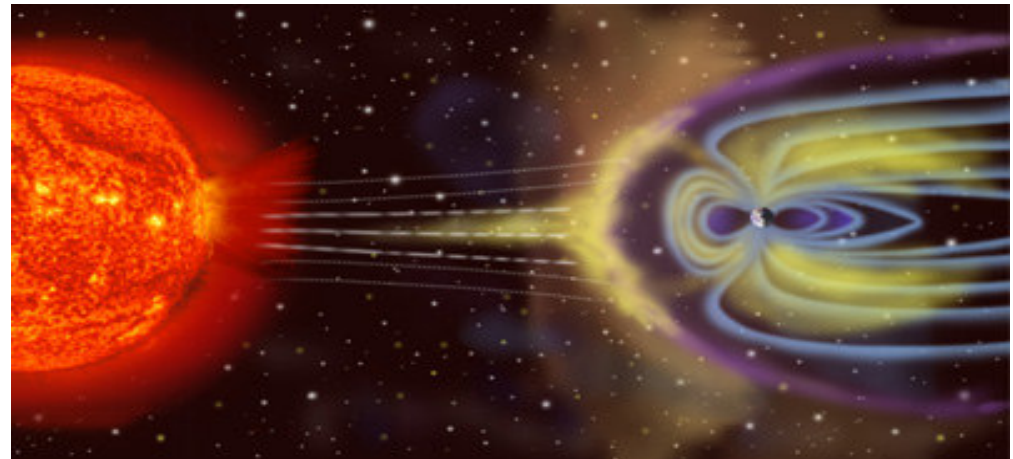
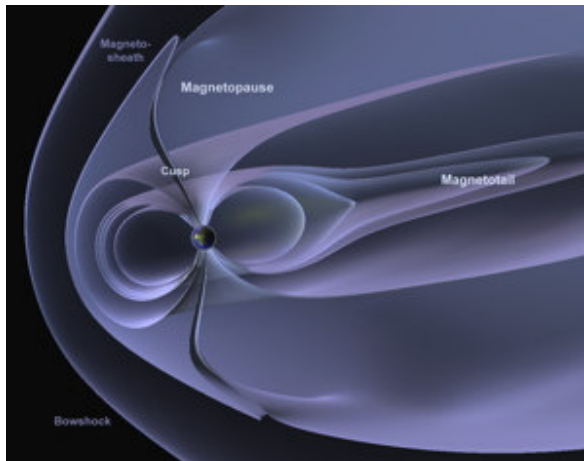

BEACONS - 10 METERS

Lesson 7

From: Emergency Management Ontario

Operated by Amateur operators to determine propagation conditions. Ten meter beacons can be found between 28.175 and 28.300 MHz. Beacons usually identify their location and power output by CW. Amateur operators can use this information to determine if favorable conditions exist between their location and the beacon's

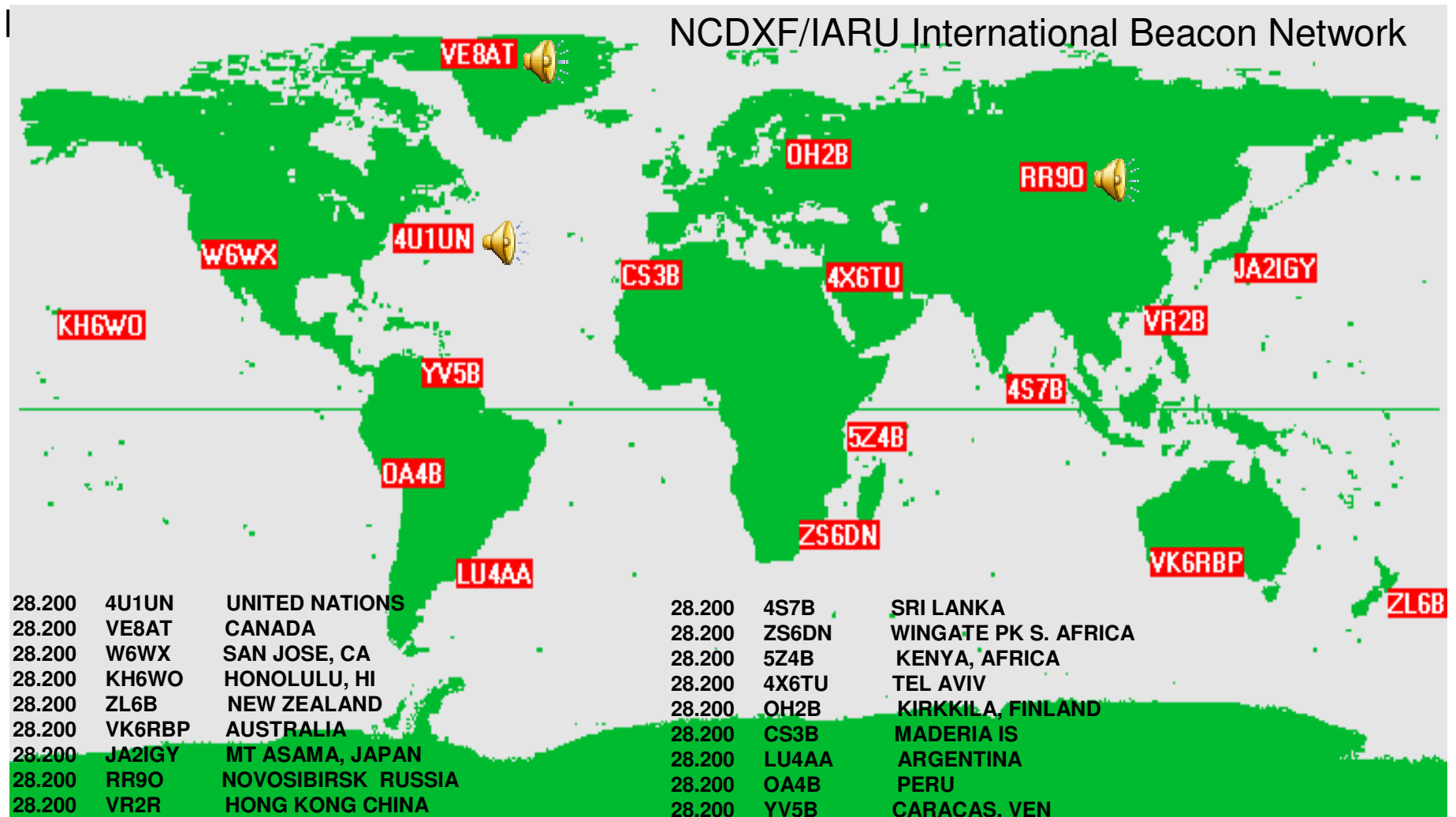

BEACONS (HF)1.8170 - 24.9860 MHZ (THERE ARE MANY MORE!!!!)

<u>CALLSIGN</u>	<u>FREQUENCY</u>	<u>GRID</u>	<u>LOCATION</u>	<u>POWER</u>	<u>ANTENNA</u>
ZS1J/B	1.8170	KF16PF	Plettenberg Bay	N/A	N/A
OK0EV	1.8450	N/A	N/A	N/A	N/A
DK0WCY	3.5790	JO44VQ	Scheggerott	30	dipole
ZS1J/B	3.5865	KF16PF	Plettenberg Bay	N/A	N/A
OK0EN	3.6000	JO70AC	Kam.Zehrovice	150m	dipole
ZS1AGI	7.0250	KF16EA	George Airport	1	dipole
ZS1J/B	10.1235	KF16PF	Plettenberg Bay	N/A	N/A
OK0EF	10.1340	JO70BC	Kladno	500m	dipole
HP1RCP/B	10.1390	FJ09HD	testing,intermittant	2	vertical
PY3PSI	10.1400	GF49KX	Porto Alegre, 85m asl	2	dipole N-S
HB9TC	10.1400	N/A	off (ausser Betrieb)	N/A	N/A
DK0WCY	10.1440	JO44VQ	Scheggerott	30	Horiz.loop
LU0ARC	14.0460	N/A	South Atlantic	N/A	N/A
HP1AVS/B	18.0990	FJ09HD	Cerro Jefe	1	1/2 vertical
KH6AP	21.1420	N/A	off (Kihei/Maui, HI)	50	vertic.AV640
VE9BEA/B	21.1455	FN66	Crabbe Mtn, NB	220m	N/A
PY3PSI	21.3935v	GF49KX	Porto Alegre, 85m asl	4	slope dipole
IK6BAK	24.9150	JN63KR	N/A	12	2 dipoles
IY4M	24.9200	JN54OK	Bologna(Marconi Memorial)	2	GP
DK0HHH	24.9310	JO53AM	Hamburg-Rothenburgsort	10	dipole N-S
JE7YNQ	24.9860	QM07	Fukushima	N/A	N/A

MF, HF CRITICAL FREQUENCIES

The maximum usable frequency is **the highest frequency signal that will reach its intended destination.** RAC: 6.8

The **amount of radiation received from the sun, mainly ultraviolet**, causes the maximum usable frequency to vary. RAC: 6.8

One way to determine if the Maximum Usable Frequency (MUF) is high enough to support 28-MHz propagation between your station and western Europe is to **listen for signals on the 10-metre beacon frequency.** RAC: 6.6

If we transmit a signal, the frequency of which is so high we no longer receive a reflection from the ionosphere, the signal frequency is above the **maximum usable frequency (MUF).** RAC: 6.8

Radio waves with frequencies below the Maximum Usable Frequency (MUF) when they are sent into the ionosphere are **bent back to the earth.** RAC: 6.8

The Optimum Working Frequency provides the best long-range HF communication. Compared with the Maximum Useable Frequency (MUF), it is usually **slightly lower.** RAC: 6.8

Signals higher in frequency than the critical frequency **pass through the ionosphere.**

MF, HF CRITICAL FREQUENCIES CONT'D

Lesson 7

From: Emergency Management Ontario

During a sudden ionospheric disturbance an amateur station may be able to continue HF communications if it tries a **higher frequency**. RAC: 6.6

During summer daytime the **160 and 80 metre** bands are the most difficult for communications beyond ground wave. RAC: 6.9

Communication on the 80 metre band is generally most difficult during **daytime in summer**.
RAC: 6.9

At any point in the solar cycle, the 20-metre band usually supports worldwide propagation during daylight hours. RAC: 6.9

UHF, VHF, SPORADIC E, AURORAS, DUCTING

Lesson 7

From: Emergency Management Ontario

Propagation above 30 MHz is normally not affected by conditions of the ionosphere. These radio waves pass through the ionosphere without refraction and escape to space. These frequencies are useful for **Direct Wave communication** and for working **Amateur satellites (ARISS / OSCAR) and moon-bounce (EME)**. The **6 metre band** is an exception as under conditions of high sunspot activity it acquires some of the characteristics of the 10 metre band.

The VHF band and above use direct waves and line of sight communications. The range of propagation can be slightly greater at times by a factor of 4/3 due to refraction effects in the Troposphere. This means under the right conditions, you can make contact with stations beyond the horizon. The effects diminish as the frequency increases. In certain favorable locations, enhanced tropospheric propagation may enable reception signals up to 800 miles or more. Other conditions which affect the propagation of VHF signals (and above) are:

Sporadic-E: strongly ionized clouds can occur in the "E" layer of the ionosphere and VHF signals will be refracted back to earth extending the range to a few thousand kilometers. Conditions occur primarily in the spring and late fall. Until recently 50 MHz (6 metre band) was considered to be the highest frequency useable for Sporadic-E operation. Increased 2 metre activity in the last decades show several DX records have been set using suspected Sporadic-E propagation and the highest frequency at which this propagation mode can be used must be considered to be as yet unknown.

UHF, VHF, SPORADIC E, AURORAS, DUCTING

Lesson 7

From: Emergency Management Ontario

Temperature Inversion / Troposphere Ducting: Certain weather conditions produce a layer of air in the Troposphere that will be at a higher temperature than the layers of air above and below it. Such a layer will provide a "duct" creating a path through the warmer layer of air which has less signal loss than cooler layers above and below. These ducts occur over relatively long distances and at varying heights from almost ground level to several hundred meters above the earth's surface. This propagation takes place when hot days are followed by rapid cooling at night and affects propagation in the 50 MHz - 450 MHz range (6 meter, 2 meter, 1 1/4 meter and 70 centimeter bands). Signals can propagate hundreds of kilometers up to about 2,000 kilometers (1,300 mi).

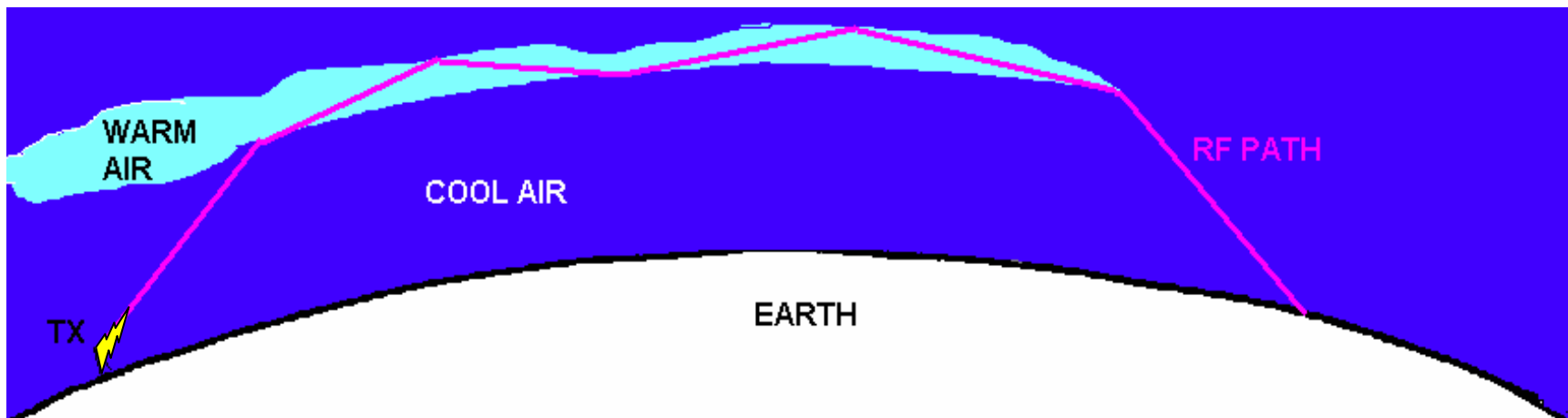

UHF, VHF, SPORADIC E, AURORAS, DUCTING

Lesson 7

From: Emergency Management Ontario

Auroral Effects: Borealis or Northern Lights is evidence of strong ionization in the upper atmosphere and can be utilized to reflect signals. Requires a relatively high power transmitter and both stations point their antennas north toward the aurora. The preferred mode when working VHF aurora is CW although SSB can be used at 50 MHz. The received tone quality when using CW is very different than what you may be used to. Characteristic buzz, echo, very raspy and garbled tones can be expected.

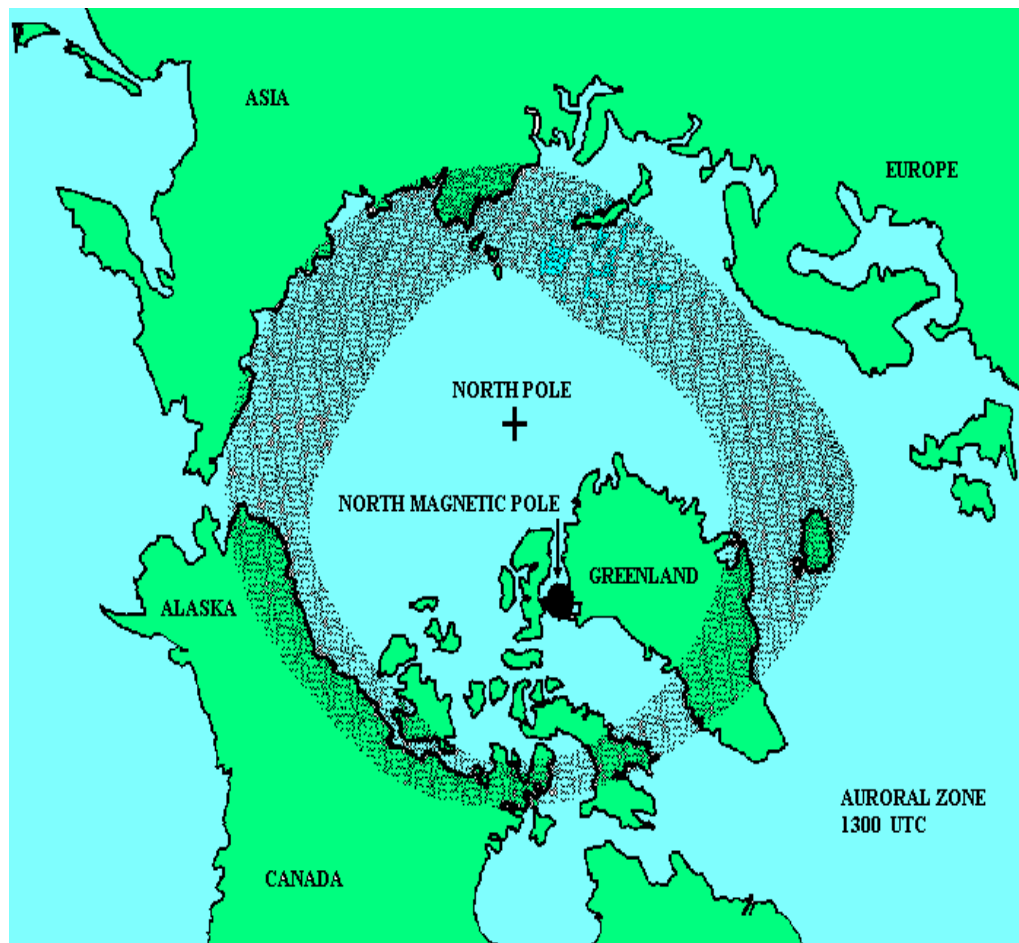

The reason auroral signals sound different is they are being reflected by changing and rapidly-moving reflector (the ionised gases in the aurora). This results in multi-path reflections and the introduction of doppler shift into the signals.

UHF, VHF, SPORADIC E, AURORAS, DUCTING

Lesson 7

From: Emergency Management Ontario

Hilly Terrain: mountainous area signals tend to be much shorter than those in open country. Signals are reflected off mountains and are also absorbed by them. If a signal passes over the top of a hill it may bend or refract back down the other side.

The Concrete Jungle: Propagation in the city is similar to the effects found in mountainous terrain. A city will often be plagued by "mobile flutter", caused by multiple reflections of the signal off buildings. A move of 20 cm or so can make all the difference in the world. Working through a repeater can be complicated by the fact that you are using two different frequencies (some times called fence picketing).

Equatorial E-skip: a regular daytime occurrence over the equatorial regions and is common in the temperate latitudes in late spring, early summer and, to a lesser degree, in early winter. For receiving stations located within +/- 10 degrees of the geomagnetic equator, equatorial E-skip can be expected on most days throughout the year, peaking around midday local time.

Earth – Moon – Earth (EME) propagation (Moon bounce): Radio amateurs have been experimenting with lunar communications by reflecting VHF and UHF signals off the moon between any two points that can observe the moon at a common time. Distance from earth means path losses are very high. The resulting signal level is often just above the noise.

UHF, VHF, SPORADIC E, AURORAS, DUCTING

Lesson 7

From: Emergency Management Ontario

The **E** ionospheric region most affects sky-wave propagation on the 6 metre band.

That portion of the radiation kept close to the earth's surface due to bending in the atmosphere is called the **tropospheric wave**.

Tropospheric ducting of radio waves is caused by a **temperature inversion**. RAC: 6.10

Tropospheric ducting is responsible for propagating a VHF signal over 800 kM (500 miles).

RAC: 6.10

Tropospheric bending affects 2-metre radio waves by **letting you contact stations farther away**. RAC: 6.10

Excluding enhanced propagation modes, the approximate range of normal VHF tropospheric propagation is **800 kM (500 miles)**.

A **sporadic-E condition** occurs when there are patches of dense ionization at E-region height. RAC: 6.10

The extended-distance propagation effect of sporadic-E is most often observed on the **6 metre band**. RAC: 6.10

In the northern hemisphere, a directional antenna should be pointed **North** to take maximum advantage of auroral propagation. RAC: 6.10

In the ionosphere, auroral activity occurs at **E-region height**. RAC: 6.10

CW and SSB emission modes are best for auroral propagation. RAC: 6.10

SCATTER, HF, VHF,UHF

Lesson 7

From: Emergency Management Ontario

Scatter : A propagation type which occurs on a frequency very close to the maximum usable frequency. It produces a weak, and distorted signal when heard with in a skip zone since only parts of the signal is being recovered. Ionospheric scatter takes place as a result of anomalies in the propagating layer of the ionosphere that is being used for a particular path. Patches of intense ionisation, or local variations in height, can cause abnormal refraction to take place. Differences in the angles of incidence and refraction occur allowing over-the-horizon communication between stations as far as 500 miles (800 km) apart.

Tropospheric scatter (or troposcatter) : Signals via the troposphere travel farther than the line of sight. This is because of the height at which scattering takes place. The magnitude of the received signal depends on the number of turbulences causing scatter in the desired direction and the gain of the receiving antenna. The signal take-off angle (transmitting antenna's angle of radiation) determines the height of the scatter volume and the size of the scatter angle. The tropospheric region that contributes most strongly to tropospheric scatter propagation lies near the midpoint between the transmitting and receiving antennas and just above the radio horizon of the antennas. This effect sometimes allows reception of stations up to a hundred miles away.

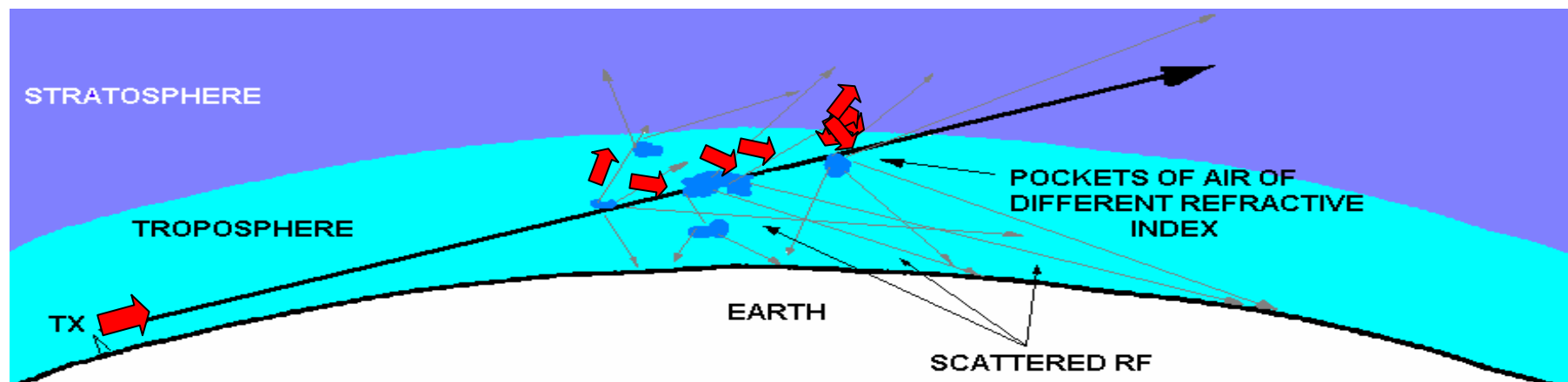

SCATTER, HF, VHF, UHF

Lesson 7

From: Emergency Management Ontario

Rain Scatter: A band of very heavy rain (or rain and hail) can scatter or even reflect signals. Distances are typically around 160 km. though up to 650 km (400 mi) is theoretically possible. (Note that heavy snow is not a useful reflector). **Ice Pellet Scatter** (called Sleet Scatter in the US). is similar to Rain Scatter but is caused by bands of Ice Pellets in the wintertime.

Trans-Equatorial Scatter: it possible for DX reception of television and radio stations between 3000–5000 miles or 4827–8045Km across the equator on frequencies as high as 432MHz., DX reception of lower frequencies in the 30–70MHz range is far more common. For this mode to work both transmitting and receiving stations should be almost the same distance from the equator.

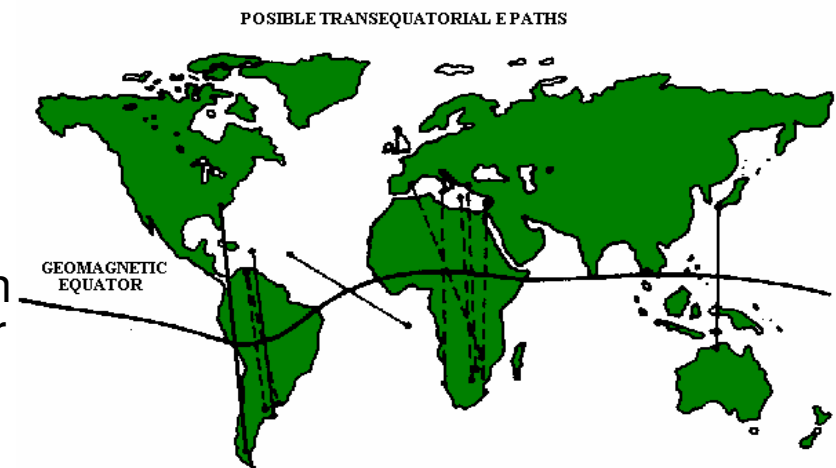

Aircraft Scatter (Tropospheric Reflection):

reflection off aircraft, (reflections off of flocks of birds are also possible). A rare form of reflection is "Chaf Scatter" (strips of metal foil sent out by the military during training exercises). Chaf helps to confuse enemy radars. but also helps to produce DX. Maximum distances for all reflection modes are again up to 800 km (500 mi).

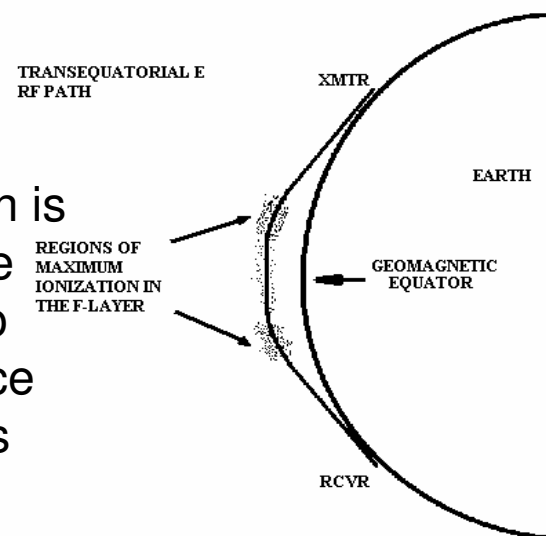

SCATTER, HF, VHF, UHF

Lesson 7

From: Emergency Management Ontario

Meteor Scatter: as Meteors burn up entering the atmosphere it creates a quantity of ionized particles which reflect VHF radio waves. CW or SSB can make several rapid contacts during the brief openings that do occur. These openings may last from a few seconds to a minute or so.

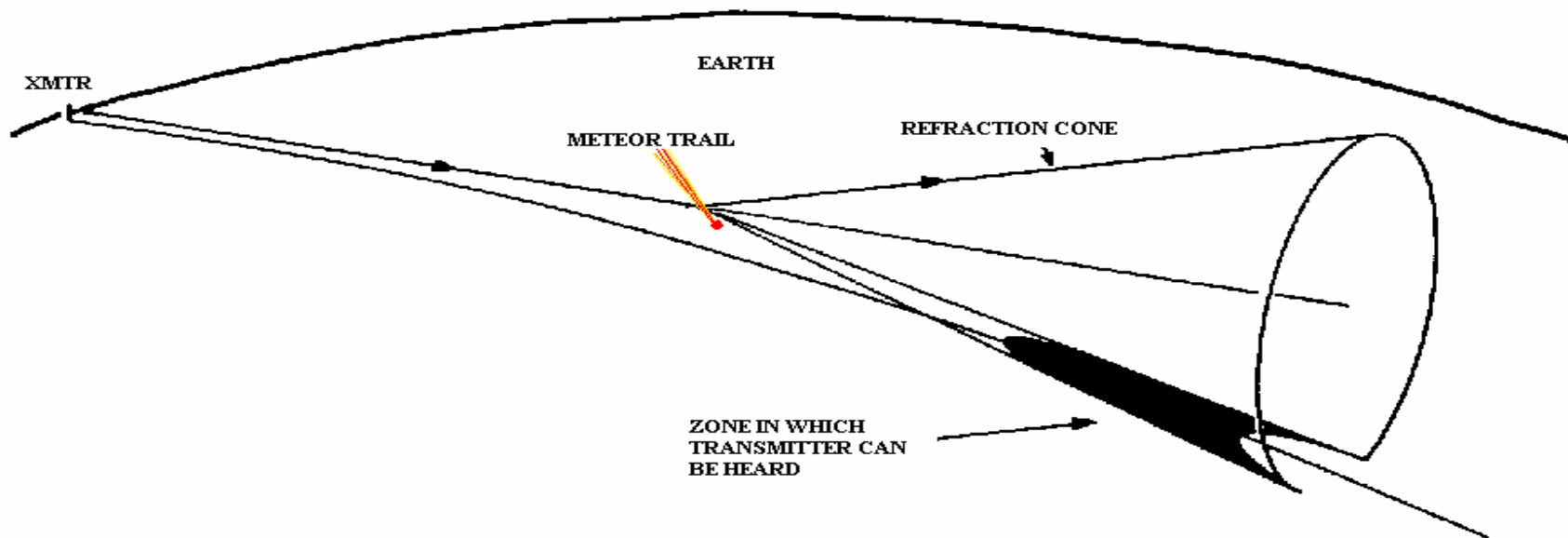

Lightning Scatter: there is little documentation on it but the theory is that lightning strikes produce ionized trails a mode that is very hard to distinguish and rarely reported.

SCATTER, HF, VHF,UHF

Lesson 7

From: Emergency Management Ontario

Scatter propagation would best be used by two stations within each other's skip zone on a certain frequency.

If you receive a weak, distorted signal from a distance, and close to maximum usable frequency, **scatter propagation** is probably occurring.

A **wavering sound** is characteristic of HF scatter signals

Energy scattered into the skip zone through several radio-wave paths makes HF scatter Signals often sound distorted.

HF scatter signals are usually weak because **only a small part of the signal energy is scattered into the skip zone.**

Scatter propagation allows a signal to be detected at a distance to far for ground-wave propagation but to near for normal sky-wave propagation.

Scatter propagation on the HF bands most often occurs **when communicating on frequencies above the maximum usable frequency (MUF)**

Side, Back, and Forward, Meteor, Ionospheric, and Tropospheric are all scatter modes.

Inverted and Absorption are **NOT scatter modes.**

In the **30 – 100 MHz** frequency range, meteor scatter is the most effective for extended-range communications.

Meteor scatter is the most effective on the **6 metre band.**

Sample Questions From The IC Question Bank

Lesson 7

From: Emergency Management Ontario

A. The medium which reflects HF radio waves back to the earth's surface is called:

- 1) biosphere
- 2) stratosphere
- 3) ionosphere
- 4) troposphere

B. All communications frequency throughout the spectrum are affected in varying degrees by:

- 1) atmospheric conditions
- 2) ionosphere
- 3) aurora borealis
- 4) sun

C. Solar cycles have an average length of:

- 1) 1 year
- 2) 3 years
- 3) 6 years
- 4) 11 years

D. Wave energy produced on frequencies below 4 MHz during daylight hours is almost always absorbed by the - layer:

- 1) C
- 2) D
- 3) E
- 4) F

E. If the distance to Europe from your location is approximately 5000 km what sort of propagation is the most likely to be involved?

- 1) sporadic-E
- 2) tropospheric scatter
- 3) back scatter
- 4) Multihop

-END-