

CE



KFM TURBO BLOWER

High Efficiency / Low Noise / Oil Free / 60,000rpm High Speed Motor(PMSM)



Thinking of man and nature together

(株)韓国流体機械
KOREA FLUID MACHINERY CO., LTD.



KFM Turbo blower has been developed based on experience and technology on Roots Blower to perform the function needed for industrial settings. Turbo blower's manufacturing cost has been lowered for a high performance to cost ratio.

Characteristics

- Usage is calculated exactly as used rather than depending on the operator's ability. It leads to reduction in energy and personnel.
- Removal of blow-off valve allows for operation in larger territory as there is no limit in pressure and air volume.

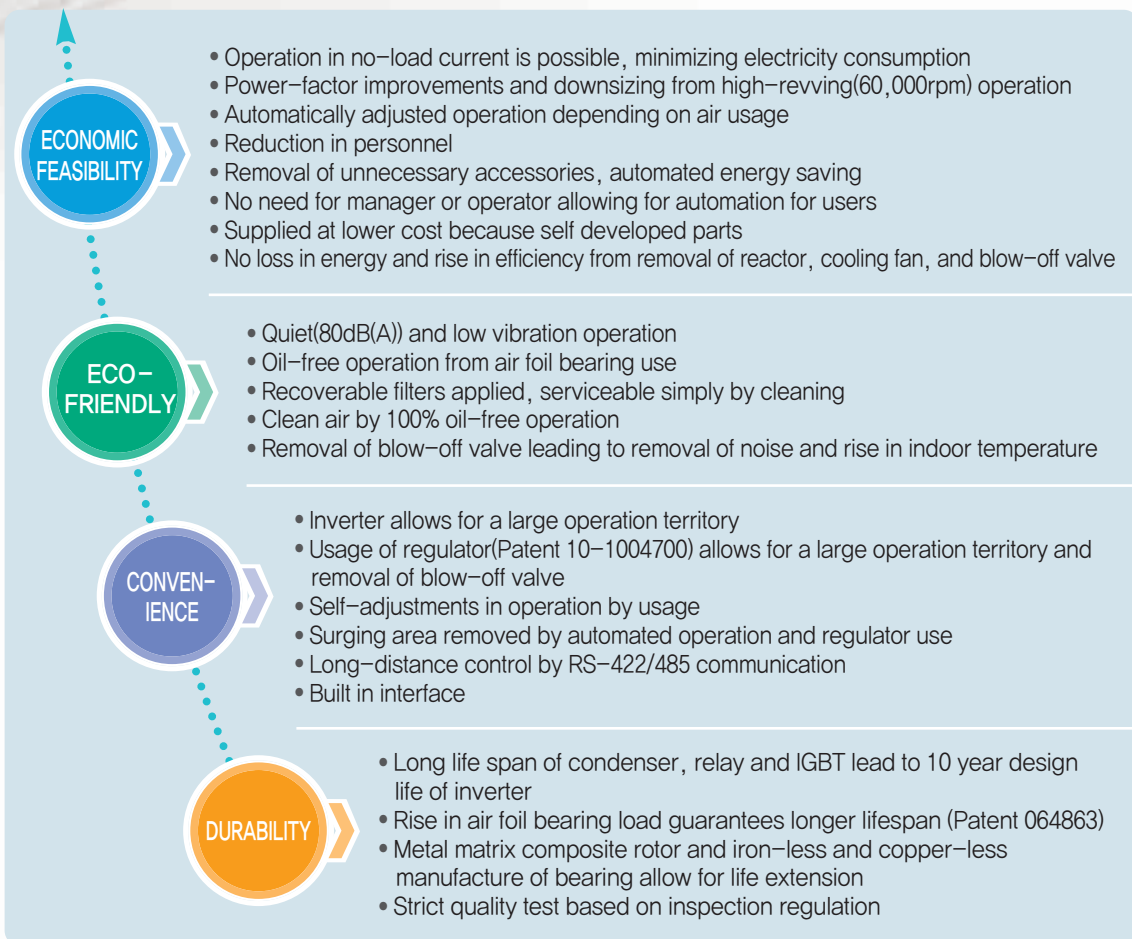

Applications

- Sewage waste water treatment aeration, Fish farm aeration, Pipe cleaning, Drying, spray for painting, Powdered material, and conveying



Structures & Advantage

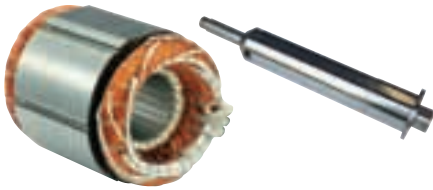

1. Permanent Magnet Synchronous Motor (Patent 0636002)

- Technical cooperation with Korea electro technology research institute allows for improved power factor and efficiency.
- Rotor is made with self developed, non-magnetic, corrosion-resisting, lubricative composite material that can resist high revolutions and high temperature.
- Stator uses an air suction cooling method, which maintains a higher withstand voltage than standard. Electric current deviation is low.
- Motor temperature stays below 40°C, with no reduction in efficiency and lifetime.
- Rotor and impeller's weight balance can resist 80,000 rpm.

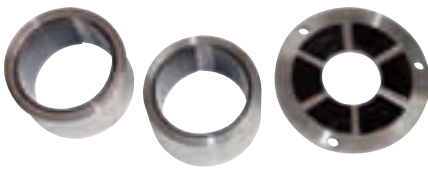

2. Air Foil Bearing (Patent 0648637)

- Semi permanent, replaceable bearing developed by KFM's technology.
- Dry type, non-contacting, oil-free, quiet, high-inertia dynamic load.
- Efficient cooling structure; does not raise rotor temperature.
- 50% greater load with self-cooling and longer lifetime by removal of bump foil.



3. Impeller & Volute

- High-speed, high efficiency, best durability and low noise developed by KFM's technology.
- Elegant blades with strong durability made by Lost-Wax detailed cast.
- Large operation territory with application of vaneless diffuser.
- Greater choice of materials for various purposes.
- Thrust regulator method applied to maintain same air pressure between the impeller and the shroud side. High efficiency and low assembly tolerance lead to minimization of air blower.
- Various impellers and volutes are applied for suitable specifications.
- Production of high efficiency closed type is possible.



4. Controller & Inverter

- Energy-saving, vector-controlled, sensor free, auto-tuning inverter is applied.
- Removal of reactor, cooling fan, noise filter, and various kinds of sensors allow for minimum energy loss and breakdown.
- Rev count, voltage, current, operation status can be easily checked with a LCD monitor.
- Pressure and flow control function is supported.
- Self-diagnosis and safe shutdown features.
- Complex parameter input is unnecessary due to removal of blow-off valve.

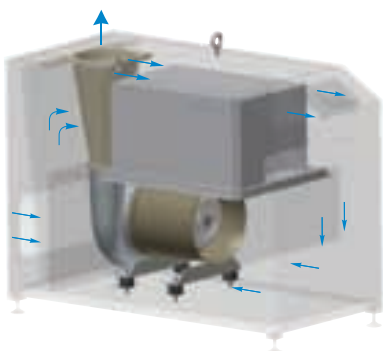

5. Cooling and Soundproof system

- Air suction cooling system cools inverter, motor, bearing and other sensor equipment, increasing efficiency.
- Airflow path is improved to block sound source that diffracts, reflects and amplifies. Thus soundproof effect is maximized.
- Reusable, semi-permanent filter is applied to supply clean air.
- Manufactured to be safe, soundproof, protection against heat and elegant.
- Eco-friendly and contributes to safety.
- Ground system removes short circuit danger.

6. Economic feasibility (Patent 0892268)

- Self control system, air suction cooling system and axial thrust regulator system allow for a high efficiency operation.
- Efficiency and power factor is improved with high-speed revolution.
- Low power consumption from no admission to surging area with the regulator.
- Unmanned automated operation reduces personnel.
- No blow-off valve operation energy due to removal of blow-off valve.



Performance Curve

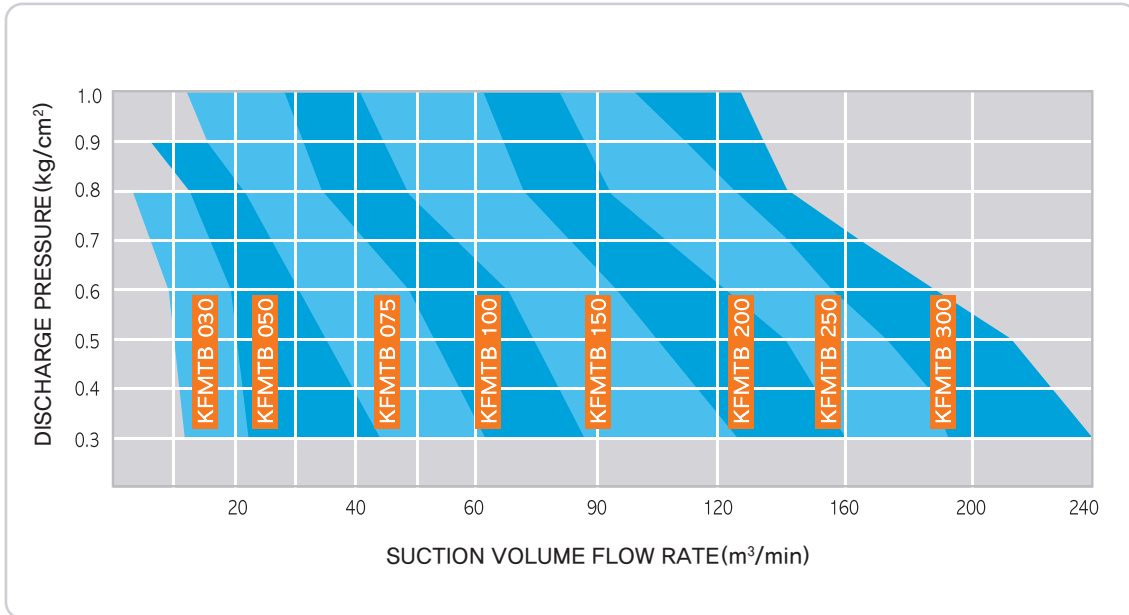

Performance Table

DISCAHRGE PRESSURE (kg/cm ²)	KFMTB 030	KFMTB 050	KFMTB 075	KFMTB 100	KFMTB 150	KFMTB 200	KFMTB 250	KFMTB 300
	SUCTION VOLUME FLOW RATE (m ³ /min)							
0.3	23	44	62	88	124	160	193	240
0.4	22	41	60	82	119	154	186	230
0.5	21	36	55	74	106	142	172	212
0.6	18	32	48	63	95	128	155	192
0.7	16	26	40	56	84	110	140	166
0.8	13	22	36	48	72	94	125	144
0.9	-	16	33	45	67	87	112	132
1.0	-	-	28	41	63	82	98	128

- Table shows maximum flow rate at suction state of temperature 20°C, 1atm, and 60% humidity.
- Power input should have 20% allowance to cover varying operation conditions.



Specification

FLOW CONTROL METHOD	Proportion Mode, Fixed Pressure Mode
FLOW RANGE	50~100%
POWER	380V~ 440V, 3 Phase, 50/60Hz
COOLING METHOD	Air Cooling
SUPPLY PART	Pressure Sensor, Check Valve, Suction Filter

Dimension

TYPE	MODEL	KFMTB 030	KFMTB 050	KFMTB 075	KFMTB 100	KFMTB 150	KFMTB 200	KFMTB 250	KFMTB 300
A		1150	1150	1300	1600	1600	2000	2300	2500
B		270	270	300	320	320	450	500	600
C		650	650	750	800	800	1100	1400	1600
D		325	325	375	400	400	550	700	800
E		750	750	850	1000	1000	1200	1400	1600
F		100	100	120	150	150	150	170	200
G		920	920	1050	1240	1240	1450	1670	1900
H		150A	150A	200A	250A	250A	300A	350A	400A
Approx. Weight(kg)		320	360	490	560	580	820	1080	1300

- The dimension of this catalog may be changed without prior notice in order to improve the performance of the product.
- Please contact the main office for change in sizes for installation space.

Drawing

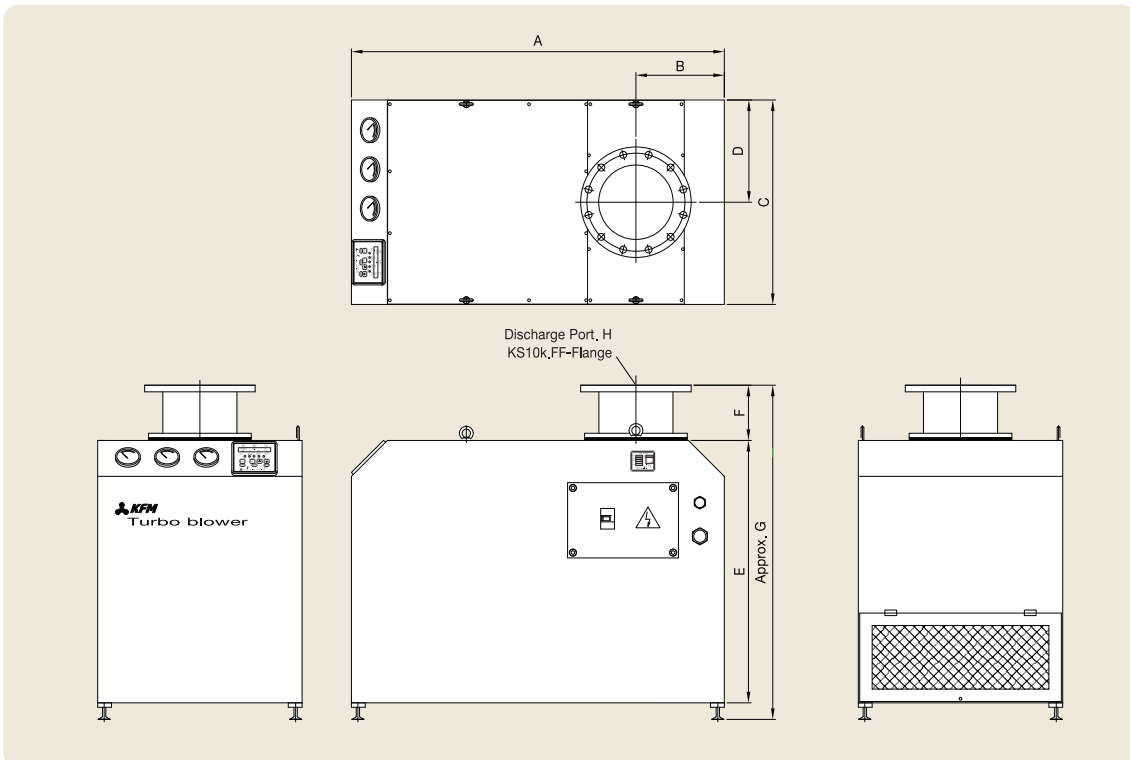



Installation Guide

- Simply install and connect discharge pipes and electric wires. No need for anchor operation for machine to be stay fixed.
- Keep a distance of 1m from the wall for air flow and easy filter cleaning process.
- Install the Turbo Blower at a clean environment.
- Install the Turbo Blower at a well-ventilated place with the minimum temperature and humidity changes.
- In case of installing several Turbo Blowers, have a distance of 1m between them.
- Make sure the weight of the pipe does not affect the Turbo Blower.
- Turbo Blower should be moved with a crane.
- If Turbo Blower's piping does not fit, use adjustment bolts.
- Connect the adjustment bolts. to ground wire for safety.

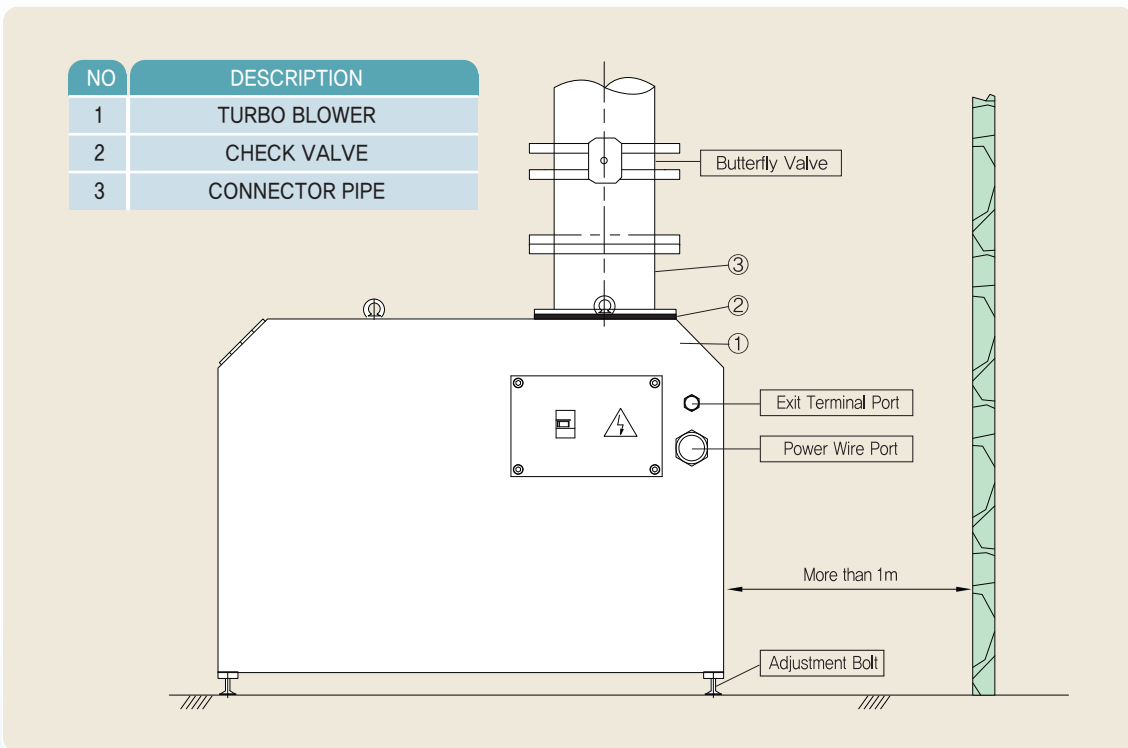

Instructions

- An operator may cause unnecessary surplus air energy loss, but a user can automatically operate without energy loss by valve manipulation only.
- Operation Adjustments can be made by change in rev-count while operation in constant pressure.
- Low pressure operation is possible as long as power is permitted during constant pressure operation.
- High voltage error can be removed by closing discharge valve.
- Low voltage error can be removed by closing discharge valve.

Man, Nature, and Culture –
 “Thinking of man and nature together”



HISTORY

1976	Jul	Established KFM in Busan
1976	Oct	Produced 2-Lobed Roots Blower
1978	Mar	Produced 3-Lobed Roots Blower
1979	Jul	Obtained Patent for 3-Lobed Roots Blower(Pat. No. 6654)
1982	Sep	Expanded and moved Head Office and Yangsan Plant to Yangsan, Korea
1983	Nov	Developed 3-Lobed Helical Roots Blower, second in the world
1986	Jan	Incorporated to KFM Co., Ltd. (Registration No. 184511-0001583)
1986	Jul	Started export business to South East Asia
1990	Mar	Manufactured the largest blower for cement plant(ST500)
1993	Sep	Launched mass production of 3-Lobed Helical Roots Blower, first in the world
1998	Apr	Patent application of Orbit Compressor & Vacuum Pump
1999	Jul	Obtained Quality Assurance System Certification ISO9001/KSA9001 from DNV/RVA
1999	Aug	Selected for IR52 Jang Young Shil award for Orbit Compressor and Vacuum Pump
2000	Mar	Started to develop L type as a main product for domestic and overseas business
2000	Oct	Started export to Japan
2000	Dec	Realization of clean management without loan
2002	May	Obtained international patent covering 5 countries(U.S.A., Britain, Germany, Japan, China) for Orbit Compressor & Vacuum Pumps
2002	Nov	Obtained CE
2004	Mar	Opened China Agency
2004	Mar	Introduced Enterprise Resource Planning System
2005	Oct	Developed Turbo Blower KFMTB Series
2006	Apr	Started to sell KFMTB075
2006	Oct	Developed Turbo Blower KFMTB200
2006	Oct	Patent registration of super high speed motor for turbo blower (Patent 10-0636002)
2006	Nov	Patent registration of air foil bearing for turbo blower (Patent 10-0648637)
2007	Jan	ST600 blower development and supply (Iran A1 project/Hyundai Construction)
2007	Feb	Patent registration of safety valve for turbo blower (Patent 10-0684119)
2007	June	Development due to limitation of 3-lobed rotary air blower
2008	Mar	Patent registration of turbo centrifugal compressor (Patent 10-0813145)
2009	Apr	Patent registration of turbo blower multifunction valve (Patent 10-0892268)
2010	Dec	Patent registration of centrifugal compressor (pressure controlled) (Patent 10-1004700)
2010	Dec	Patent registration of centrifugal compressor (cooling structure) (Patent 10-1004701)
2011	June	Development of centrifugal compressor auto control for pressure and capacity variation
2011	Dec	ST700(1300HP) blower development and supply



OVERSEAS BUSINESS & SERVICE NETWORKS

● OVERSEAS SALES CONTACT

KFM TRADING(韓流)

RN 1201, Victoria B/D 705-1, Yeoksam-dong, Gangnam-gu, Seoul, Korea. (Zip Code:135-709)

TEL : + 82-2-501-4860-61, + 82-2-565-9019 FAX : + 82-2-501-4862

● PARTNER IN JAPAN

TSURUMI MANUFACTURING CO., LTD.

16-40, 4-Chome, Tsurumi, Tsurumi-ku, Osaka 538-8585 Japan.

TEL : +81-6-6911-2351 FAX : +81-6-6911-1800

● PARTNER IN CHINA(SHANGHAI)

SHANGHAI LEOPARD TRADE DEVELOPMENT CO., LTD.

Room 405 No.7 Pujiang Building, Anshun Road, Shanghai 200052, P.R. China.

TEL : (021) 62947638 FAX : (021) 62947636



SINCE 1976

Thinking of man and nature together

(株)韓國流体機械

KOREA FLUID MACHINERY CO., LTD.

● HEAD OFFICE & PLANT

KOREA FLUID MACHINERY CO., LTD.

48, Eosil-ro, Yangsan-si, Gyeongsangnam-do, Korea.

(ZIP CODE 626-230)

TEL : + 82-55-372-0911~4, +82-51-463-0911

+ 82-2-752-7550

FAX : + 82-55-372-0915, +82-2-752-7550

www.kfmblower.com e-mail:kfmc@kfmblower.com

● MAIN PRODUCTS

- Turbo Blower
- Rotary Blower
- Three Lobes Helical Blower
- Vacuum Pump
- Vane Type Blower & Vacuum Pump
- Pneumatic Bulk Handling Systems

DISTRIBUTOR