



VERSAILLES SLEIGH CRIB

ASSEMBLY INSTRUCTIONS

Thank you for choosing our new Convertible Crib.

This practical Crib design can be used as a baby's crib, a toddler bed and then will convert to a full sized bed.

Before assembling your Versailles Sleigh Crib, please read through these instructions carefully.

Familiarise yourself with the different parts before starting assembly.

Assembly is to be performed by qualified individuals who have experience with tools and metal fasteners.

Please save these instructions in the envelope attached to the mattress support for future reference.



Assembling by Adult



Allen Key Provided
In Hardware Kit

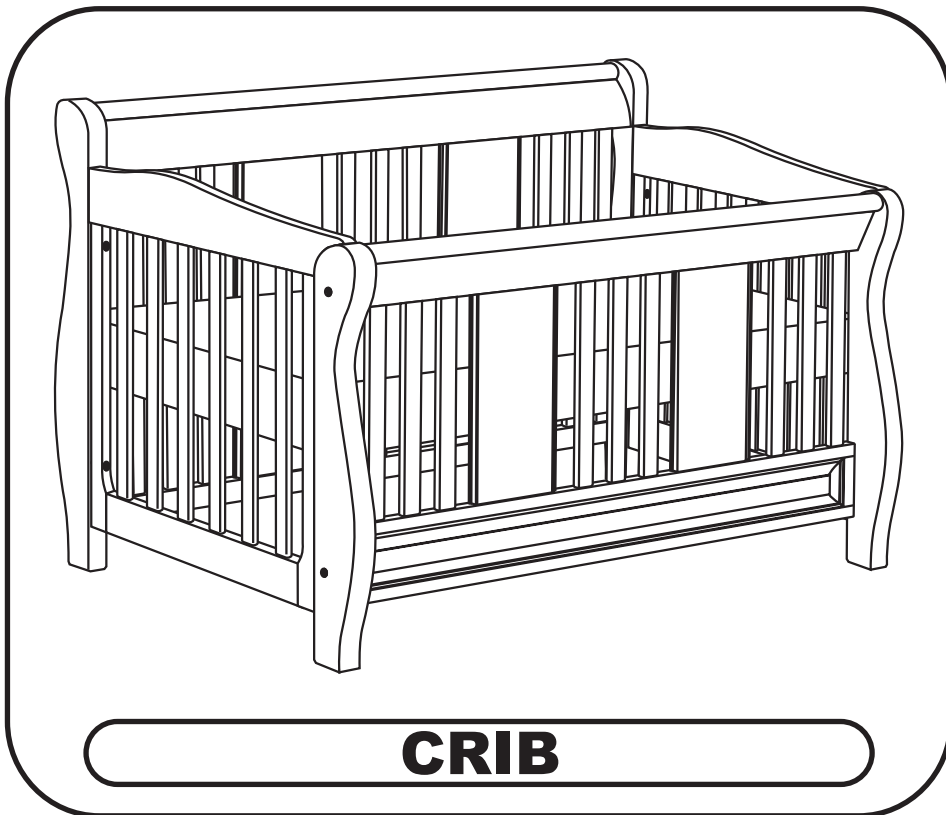

CRIB

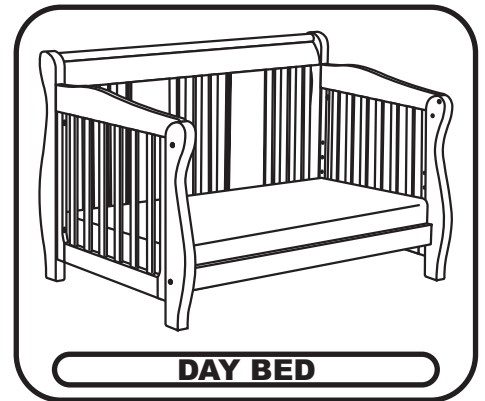

DAY BED



TODDLER BED

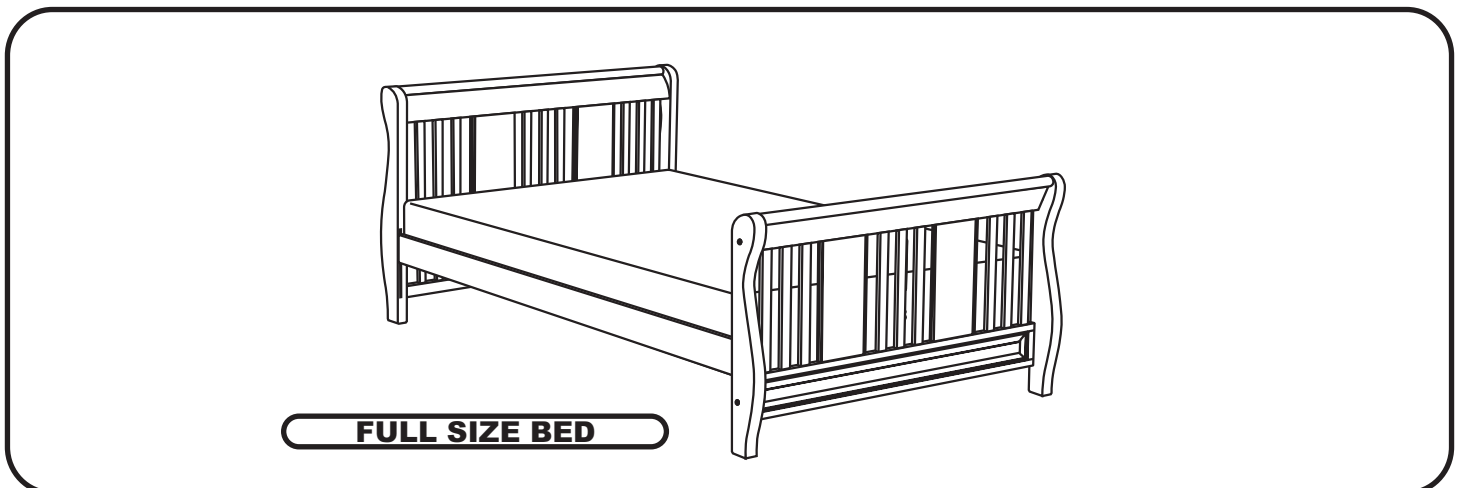

FULL SIZE BED

BEFORE STARTING ASSEMBLY, READ AND UNDERSTAND ALL DIRECTIONS.
ALL NECESSARY HARDWARE AND TOOLS ARE INCLUDED IN THE HARDWARE KIT.

VERSAILLES SLEIGH CRIB PARTS LIST

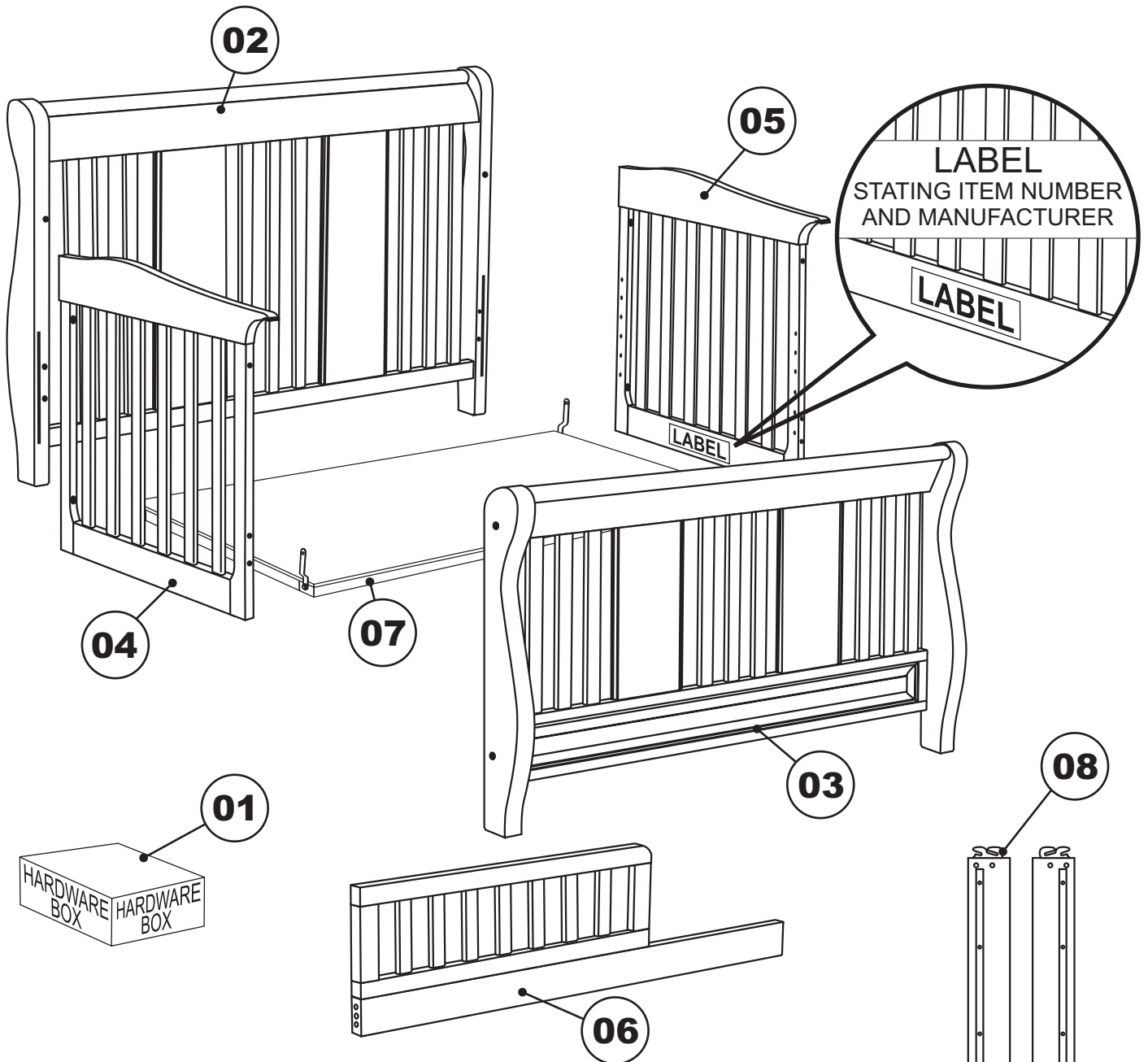

- 01** HARDWARE
- 02** HEADBOARD
- 03** FOOTBOARD
- 04** LEFT SIDE PANEL
- 05** RIGHT SIDE PANEL
- 06** GUARD RAIL / STRETCHER
- 07** MATTRESS SUPPORT
- 08** BED RAILS (Purchased Separately)

HARDWARE

(NOTED WHEN SHOWN ACTUAL SIZE)



A JCB M6 X 50mm(2 ") - 8 pcs
Fix Side Panel to Headboard, Footboard

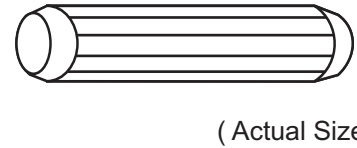

D 10 x 40mm Wooden Dowel - 8 pcs

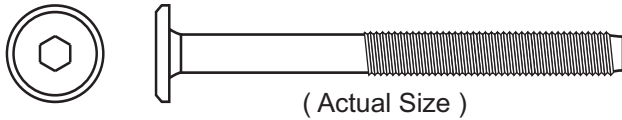

B JCB M6 X 60mm(2 1/4 ") - 2 pcs
Fix Guard Rail / Stretcher to Footboard Leg



E Allen Key - 1 pc

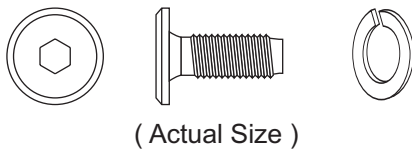

C JCB M6 X 15mm (5/8")+ Split Washer - 4 set
Fix Spring to Side Panel

BEFORE ASSEMBLY

- ① UNPACK HARDWARE AND PARTS AND COMPARE WITH LIST TO BE SURE YOU HAVE EVERYTHING YOU NEED. PLACE EACH SCREW OR BOLT ON THE DIAGRAM OF THE ITEM THAT IS SKETCHED ACTUAL SIZE. BE SURE TO USE THE PROPER SIZE, AS INSTRUCTED IN THE ASSEMBLY INSTRUCTIONS.
- ② IF YOU ARE MISSING ANY PARTS, PLEASE CONTACT YOUR ATLANTIC FURNITURE DEALER OR ATLANTIC FURNITURE 655 PAGE BOULEVARD SPRINGFIELD MA USA 01104, 800-955-3726 OR CONTACT US BY EMAIL info@atlanticframe.com BE SURE TO INCLUDE YOUR ITEM IDENTIFICATION NUMBER IN YOUR EMAIL.
- ③ THE ID NUMBER CAN BE FOUND LOCATED ON THE INSIDE OF THE SIDE PANEL. BE SURE TO NEVER USE SUBSTITUTE PARTS.

STEP 1

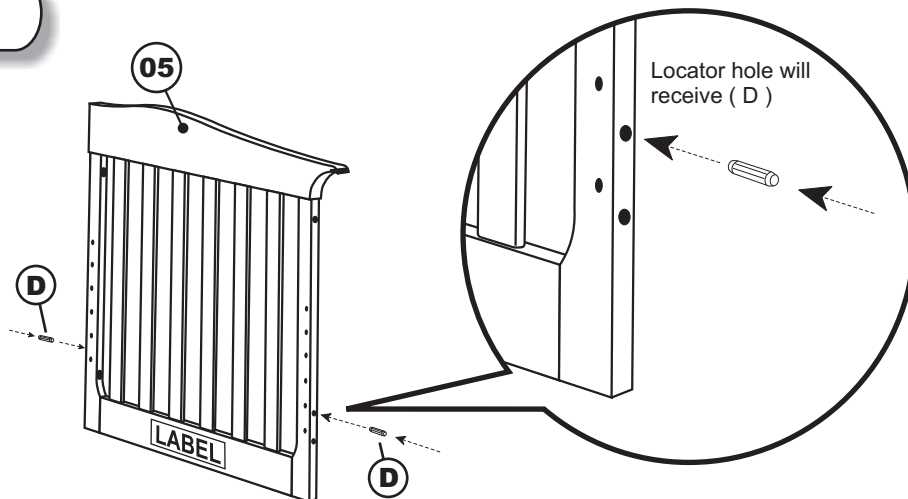

Insert Wooden Dowel (D),
into the receiving hole in each end of Side Panels (04)(05) as shown.

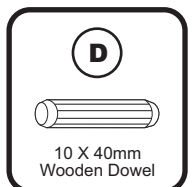

STEP 2

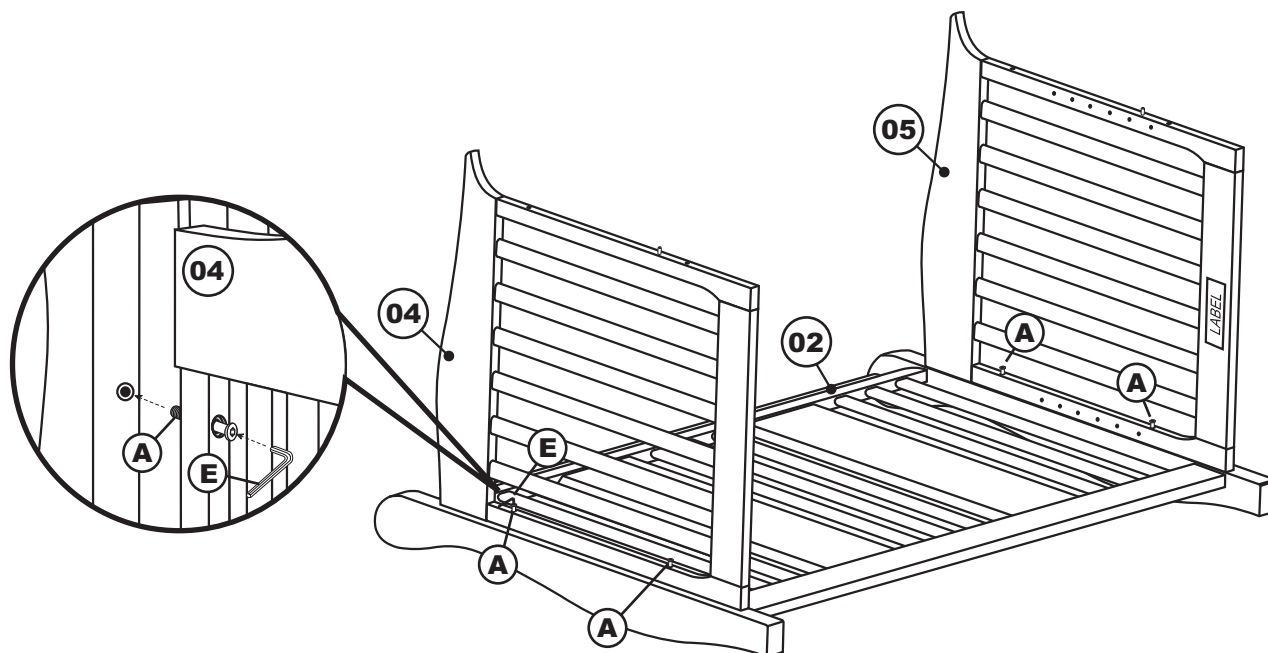
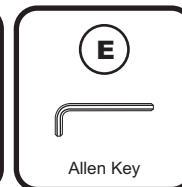
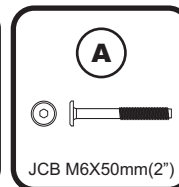

Lay the Headboard (02) on the floor, taking care to lay it on some cardboard to prevent scratching. Install the Side Panels(04,05) to the Headboard. Using JCB (A). Tighten with the Allen Key (E)

IMPORTANT : TIGHTEN ALL BOLTS SECURELY DO NOT OVER TIGHTEN

STEP 3

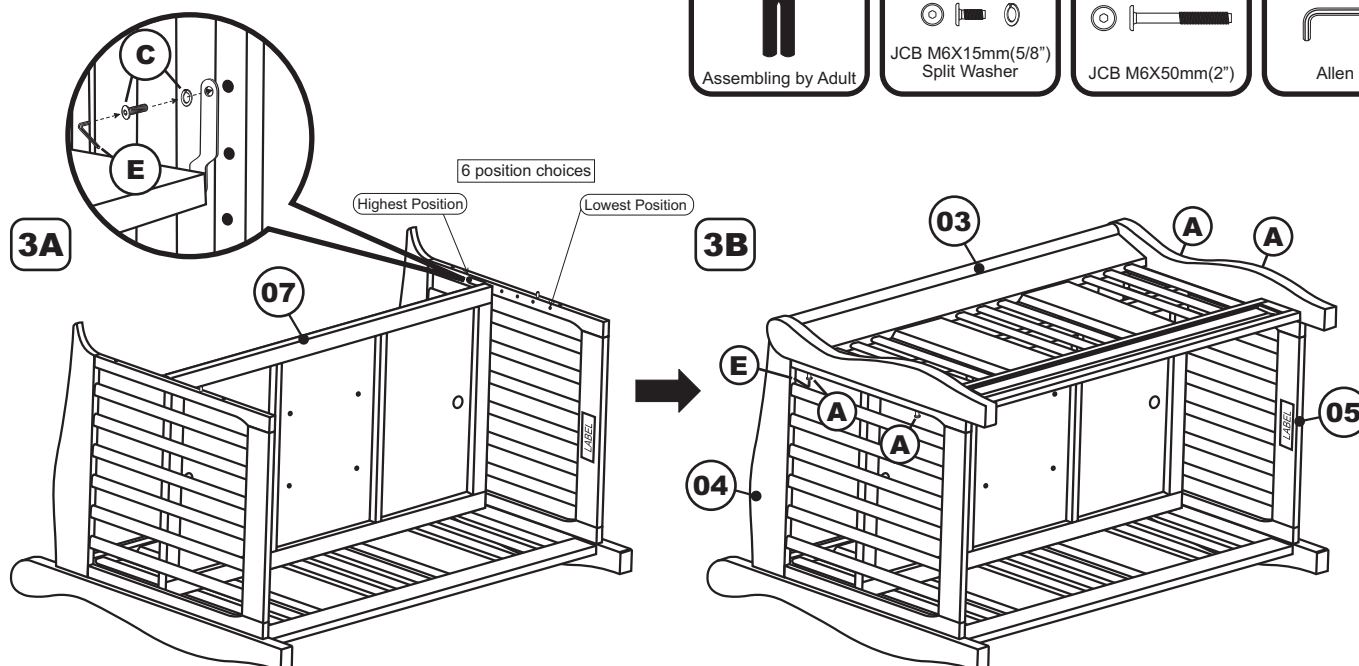
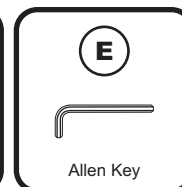
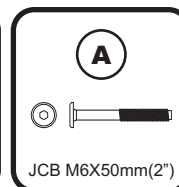
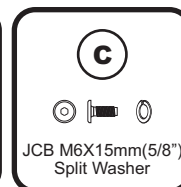

Install the Mattress Support (07) to Versailles Crib as shown, using JCB M6X15mm and Split Washer (C). Tighten with the Allen Key (E).

Attach the Footboard (03) to the Side panels (04/05), using JCB M6 X 50mm (A). Tighten with the Allen Key (E).

IMPORTANT : TIGHTEN ALL BOLTS SECURELY DO NOT OVER TIGHTEN

STEP 4

⚠ WARNING

ANY MATTRESS USED IN THIS CRIB MUST BE AT LEAST 27 1/4 in (690 mm) IN WIDTH, BY 51 5/8 in (1310mm) IN LENGTH, AND AT LEAST 4 in (100mm) IN THICKNESS, BUT NOT EXCEEDING 6 in (150mm).

ASSEMBLED CRIB

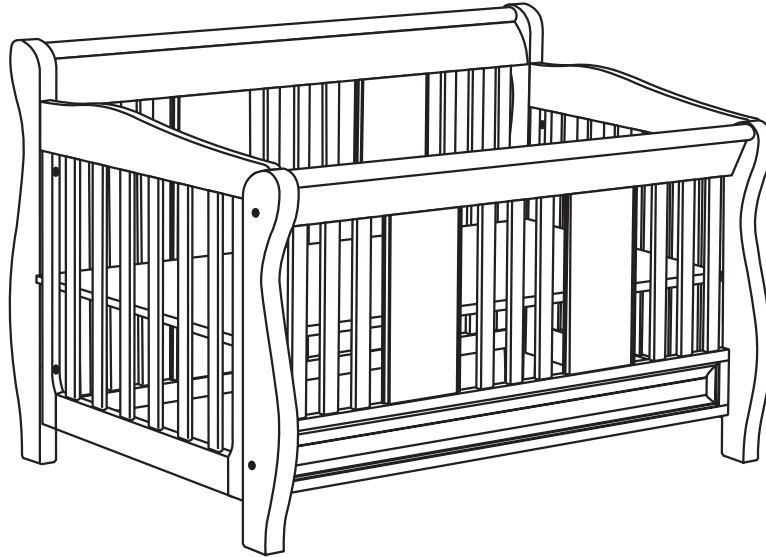

Your Versailles Sleigh Crib is now ready for use.

⚠ WARNING

It is important that you recheck all bolts making sure they are tight and that all parts are secure before use and periodically to ensure safety.

Conversion to a Toddler Bed / Day Bed

When use as a Crib has been completed, you have the option to convert the Crib to a Toddler Bed. Remove Footboard (03) that is attached to front posts (left + right). Install Toddler Guard Rail (06), use Wood Dowel (D), JCB M6 X 60mm (B) as shown. Tighten with the Allen Key (E).

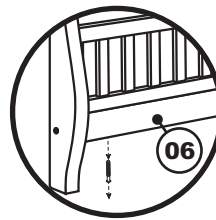
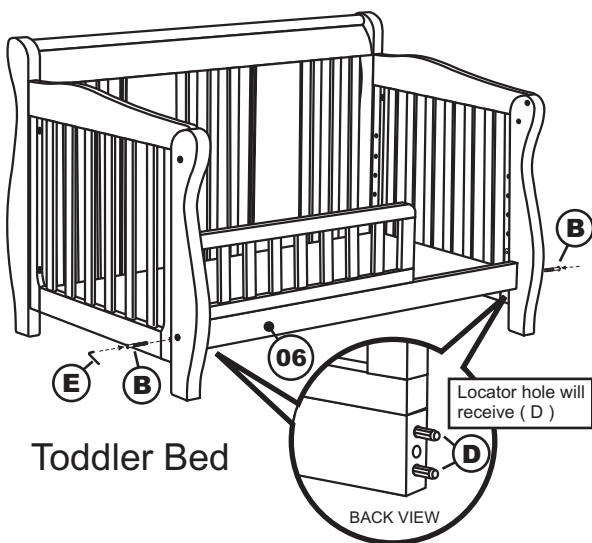

Remove Guardrail (06) that is attached to Stretcher as shown to use as Day Bed.

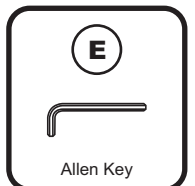
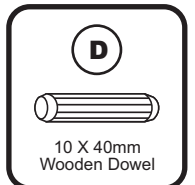
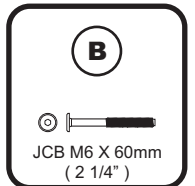
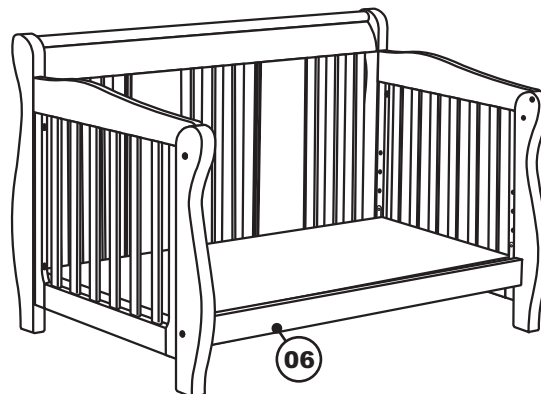

⚠ WARNING
Mattress Support (07) must be installed in lowest position as shown.

Conversion to a Full Size Bed

Disassemble crib by removing Mattress Support (07), Also remove Side Rails (04)(05) from Headboard/ Footboard.
Install The Headboard and Footboard to Bed Rail with Bed Hook (08) as shown.

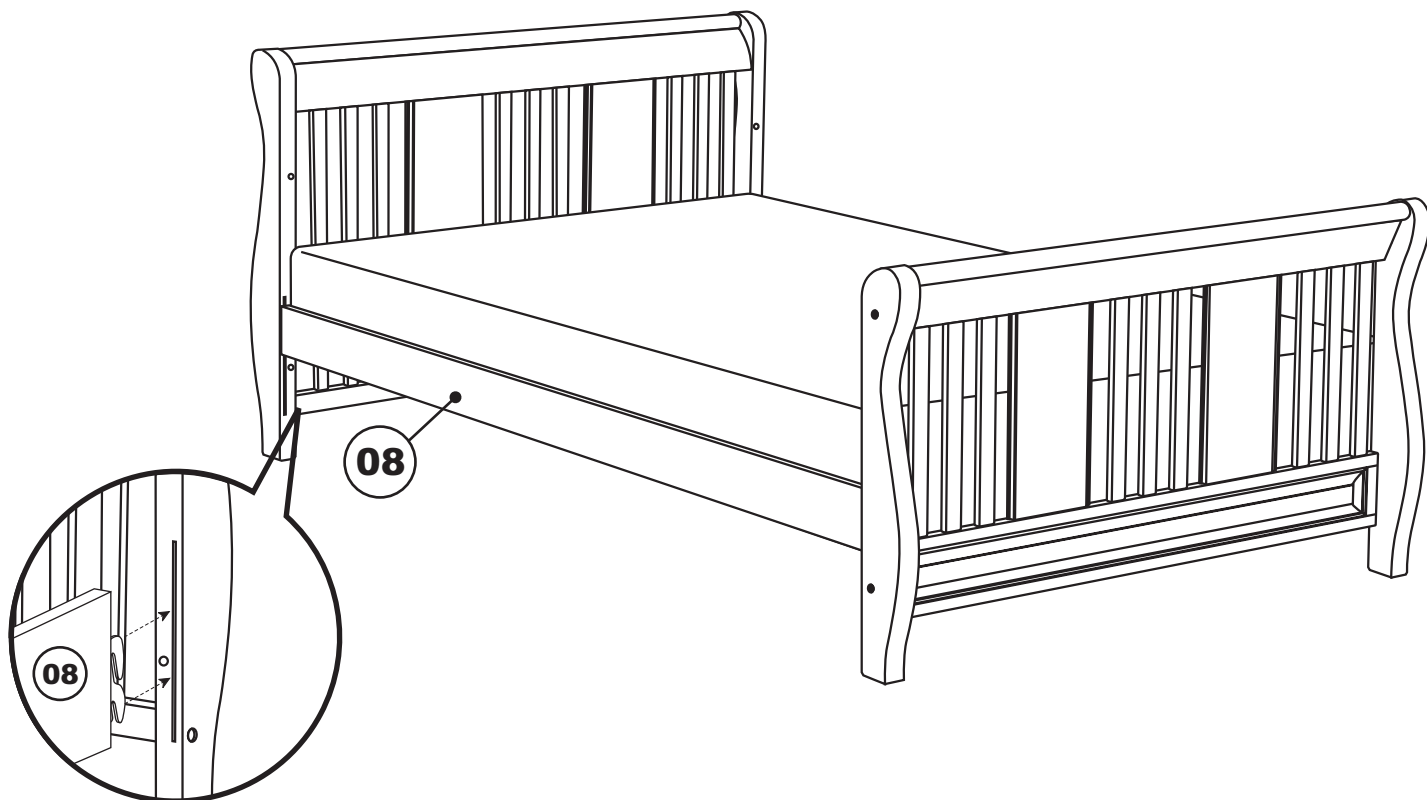

FOR SLAT KIT ASSEMBLY follow assembly instructions included with slat kit.

MAINTENANCE OF YOUR ATLANTIC CONVERTIBLE CRIB :

After you finish assembling your crib, be sure all allen bolts have been tightened securely. You must check all bolts periodically and re-tighten as necessary. Periodically inspect crib for damaged hardware, loose joints or splintered edges. **DO NOT** use crib if parts are damaged or broken! Contact your Atlantic Crib dealer or Atlantic Furniture at (413) 747-2900, or email info@atlanticframe.com If you are having problems contacting us, you may also visit our website at www.atlanticframe.com Please be sure to have your model identification number written down before you make contact. The model number can be found on a white label located on the inside of your Crib on the side panel. **NEVER SUBSTITUTE PARTS OR MAKE ALTERATIONS TO YOUR CRIB.**

ASSEMBLING THE YOUTH TODDLER BED :

When a child reaches 35 inches in height, they should be placed in a youth or toddler bed. The minimum age for a child using a toddler bed shall be not less than 15 months and the maximum weight shall be no greater than 50lb. If you choose to convert this crib to a toddler bed you must use Stretcher / Guard Rail (06).