



**REAR CAMBER ARM  
INSTALLATION INSTRUCTIONS:**

**03-08 NISSAN 350Z/FAIRLADY Z Z33**

**09-15 NISSAN 370Z/FAIRLADY Z Z34**

**03-07 INFINITI/NISSAN G35/SKYLINE COUPE V35**

**07-08 INFINITI G35 SEDAN**

**08-13 INFINITI G37**

**PART NUMBER:  
RCNS-0301 & RCNS-0401**

We recommend that installation of all Voodoo13 parts be completed by a professional who is experienced in suspension tuning. With proper installation and maintenance, Voodoo13 suspension products will provide exceptional performance and durability. For any questions, please contact Voodoo13 immediately. We thank you for choosing Voodoo13 for your suspension tuning needs!

### NEED HELP?

Our representatives are here to help you with any questions concerning the operation of this product.

**CALL 480-889-0812**

Monday thru Friday 8:30am to 5:30pm MST

### RECOMMENDED TOOLS AND SUPPLIES

- General Mechanics Tool Set
- Torque Wrench

### PART BREAKDOWN

NOTE: For any OE hardware please refer to OEM service manual for torque specifications. For all included hardware please torque to specifications shown below.

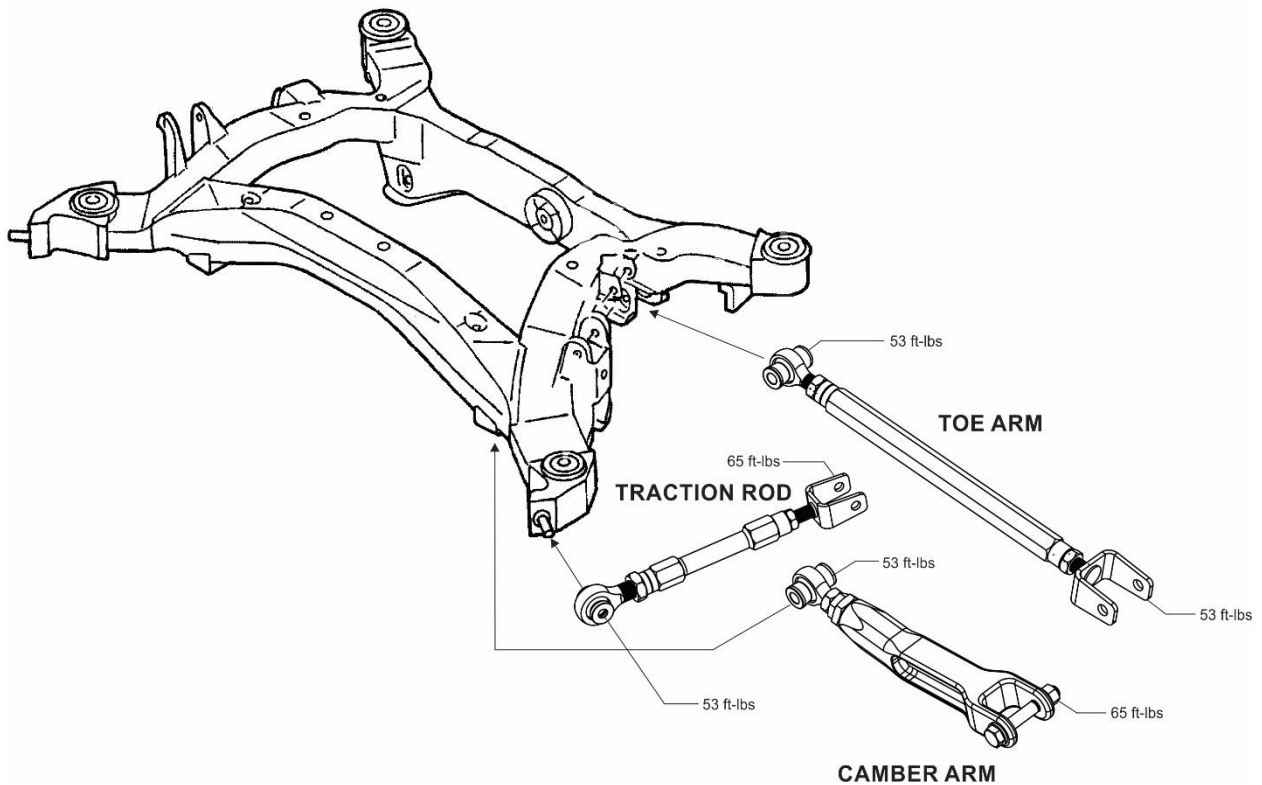

## INSTALLATION PROCEDURE

**Step 1:** Lift the vehicle to a safe height using the recommended factory lift points to work underneath the rear suspension. Ensure to place safety jack stands where recommended by Nissan before anyone goes underneath the car (unless using a vehicle lift with safety locks).

**Step 2:** Proceed to the rear of the vehicle and remove the rear wheels.

**Step 3:** Locate the factory lower control arm on the car. This lower control arm uses a bucket style to hold the rear coil springs. To begin the removal process either use a spring compressor or a floor jack. If the installation is done on the lift, the spring compressor is highly recommended. If done with jack stands, a floor jack maybe used. Begin by loosening the 12mm bolt on the subframe side and then proceed to remove the bolt. The jack or spring compressor should take care the spring.

**Step 4:** Next remove the 12mm bolt on the knuckle side. From here the factory lower control arm should come off with the coil spring.

**Step 5:** The new arms replace the old factory bucket style lower control arms. These new arms adjust camber and track width simultaneously. The bracket end of the arm needs to be installed on the knuckle end and torque to **53 ft-lbs**. The spherical end with the spacers needs to be installed on the subframe side and torque to **53 ft-lbs**.

**Step 6:** Repeat steps 3-5 for the opposite side.

**Step 7:** Reinstall the rear wheels and torque the lug nuts to the accordance via factory service manual.

**Step 8:** Lower vehicle safely back to the ground and perform a vehicle alignment. You are finished!

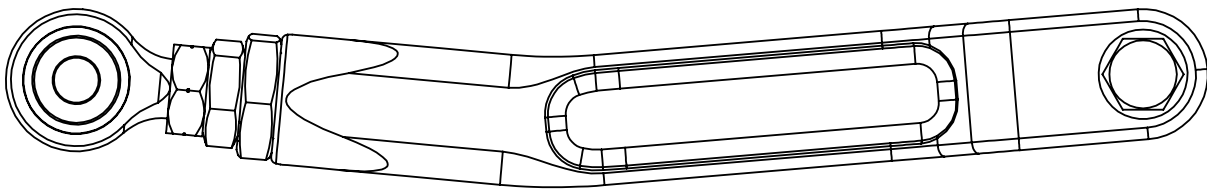

**CORRECT ORIENTATION**

## ROD END ADJUSTMENT GUIDELINES

When adjusting rod end to desired position, adjust so that the rod end and adjuster have approximately the same amount of thread showing. Always use the jam nuts to secure the rod end and adjuster. Never tighten the rod end into the adjuster or the adjuster in the lower control arm as a jamming mechanism.

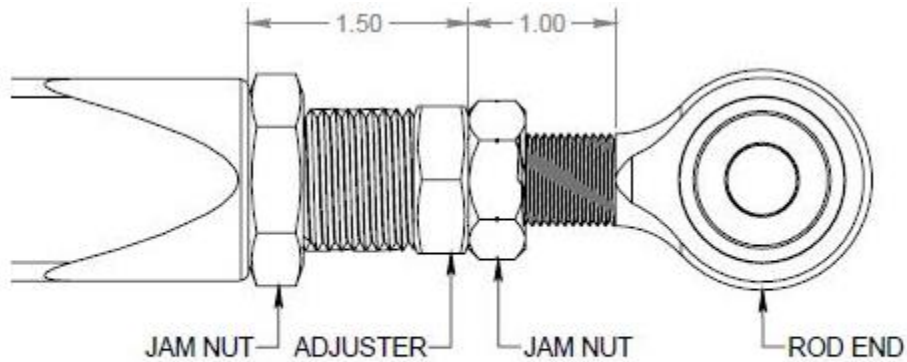

CORRECTLY ADJUSTED  
(MAX ADJUSTMENT SHOWN)

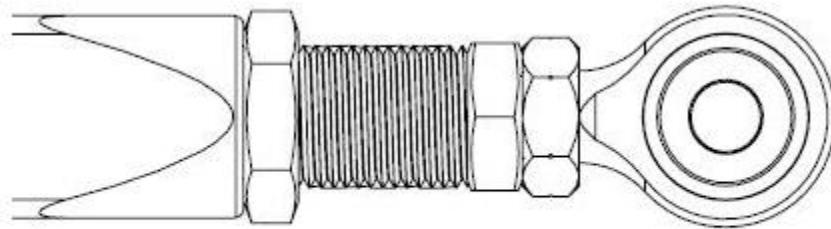

INCORRECTLY ADJUSTED  
INSUFFICIENT THREAD ENGAGEMENT ON ADJUSTER

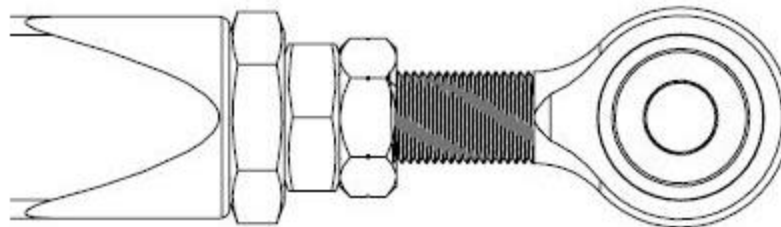

INCORRECTLY ADJUSTED  
INSUFFICIENT THREAD ENGAGEMENT ON ROD END

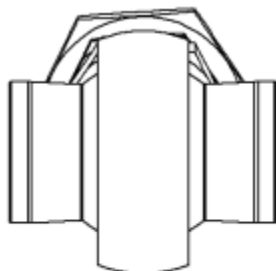

CORRECTLY POSITIONED

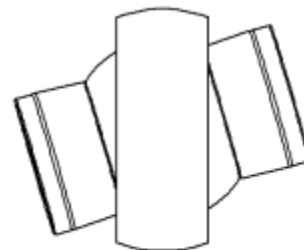

INCORRECTLY POSITIONED  
TOO MUCH STATIC ROD END MISALIGNMENT

## WARRANTY

All products sold are subject to the following warranty:

Voodoo13 offers a Limited Lifetime Warranty for our products to the original retail consumer against defects and workmanship when used on light truck and car applications under normal operating conditions. This warranty does not apply to parts that have been improperly installed or wearable items such as, but not limited to, worn bushings or bearings unless proven to be defective from the manufacturer.

Exterior finish on all Voodoo13 products is not considered a valid warranty; consumers are responsible for the maintenance of paint, anodize or raw metal finish.

The consumer will be responsible for the removal and freight costs both to and from the Distributor from which the product was originally purchased. Proof of purchase and product registration through the Voodoo13 website is mandatory in order to receive warrantee replacement; original invoice from the Distributor from which the product was purchased must accompany the product in question for warrantee.

Voodoo13 has the right to refuse a warrantee claim if procedures are not met by the original consumer. All returns must have an R.M.A. approval from Voodoo13 prior to shipping direct to the Voodoo13 facility. Exclusions from this warranty are sales outside of the United States, the finish, dents, rust, or any condition caused by abnormal use or neglect.

### WARNING

High performance parts. For off-road use only. Installation should be carried out by a qualified facility. Improper use or installation may result in injury or death.



**VOODOO13**  
115 N Sunway Drive  
Gilbert, AZ 85233  
Ph: 480.889.0812  
Fax: 480.829.8103  
[www.VOODOO13USA.com](http://www.VOODOO13USA.com)