



FITA
Coach's
Manual

**RECURVE BOW
EQUIPMENT TUNING**
Module

Intermediate
Level



Module

RECURVE BOW EQUIPMENT TUNING

Introduction, to tuning competitive recurve bows

There is no doubt that the bow you choose is an important consideration, but even more important than the bow are the arrows you choose. In the early days of competitive archery, it was not uncommon for an archer to pay a weeks salary for a dozen top quality footed cedar arrows. Remember, it is not the bow scoring the points in the target; it is your arrow shafts. Successful bow tuning and accurate shooting can only be achieved by using arrow shafts that are properly spined to your bow and ones that are consistent in their spine, weight and straightness. Follow the many available spine charts or computer programs on the market to select the arrow size recommended for your draw length and bow poundage. Remember to read all of the information provided on the proper use for the chart too. The true verification that you have selected the correct spine will be determined during the tuning process. Problems caused by improperly spined arrow shafts will become evident during tuning. Before tuning, be sure that all arrows are straight, properly fletched, and have perfectly aligned nocks.

Shooting Technique

Your shooting technique can have a large influence over the dynamic spine value of your arrow. Two archers shooting the exact same bow, same poundage and the same arrow length may not necessarily shoot the same arrow size. Usually, the archer who has better “line”, (see shooting form chapter for details on body alignment) will shoot a lighter (weaker) spined arrow than an archer who has poor skeletal alignment. This is because the archer with good alignment creates less side movement of the string on release resulting in less column loading of the arrow shaft.

Install All Accessories

Before starting the bow tuning process, be sure to install every piece of equipment on your bow that you intend to use during shooting. This includes the correct bow-string and all attachments to the bow string, bow sight, stabilizers, arrow rest, cushion plunger, counter weights etc. Choose all personal items as well, like your tab, chest protector and any thing else you use when shooting. For example, simply changing a stabilizer can have an enormous effect on the tune of your bow. Any adjustments made to the bow or changes in bow components can and usually will affect the tune.

Once the equipment is fully assembled, the next phase in the process of achieving well tuned equipment is good preliminary setup. If the initial setup is done properly, the tuning process can be accomplished with little effort. By following the bow setup guidelines in the initial preparation of your equipment, you can eliminate most or all of the possible tuning problems that can make the process time consuming and unsuccessful.

Adjustments made to the bow, changes in bow components, or alterations in shooting form can affect the tune or your equipment. Remember, you and your equipment share a unique relationship and are totally integrated. Any change to either will produce varying results. During the tuning process, it is vitally important that you change only one variable at a time. Otherwise, it is very difficult to determine what adjustment caused any grouping changes. If, after trying all of the tuning adjustments outlined in this chapter, your arrows still do not fly true, it may be necessary to change your arrow size to a stiffer or weaker shaft and retune.

Arrows in flight spin, vibrate and oscillate in the horizontal plane, and can oscillate in the vertical plane with a misplaced nocking point. Proper bow-set up and tuning will help minimize the forces on the arrow and help the archer to achieve optimum performance. Unfortunately, there are many theories on arrow flight and vigorous mathematical treatment of these is a bit hard for most non-engineers to understand. The bottom line though, is that all archers can recognize the arrow flight problems and make appropriate corrections. Figures showing the rotation of arrows in the horizontal and vertical panes are shown below.



Figure 1.

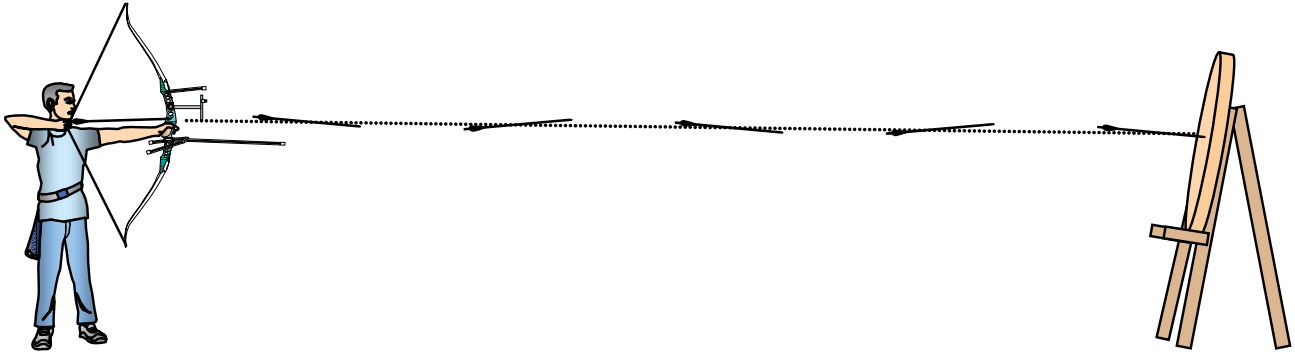

Figure 2.

In this section on recurve bow tuning it will be necessary to discuss a number of different types of risers since the available adjustment features differ in each case.

The types of risers are:

- Simple wooden self or take down bows.
- Metal risers with cushion plungers but no weight adjustment capability.
- Metal risers with cushion plungers & weight adjustment but no limb pocket adjustment capability.
- Olympic Recurve risers (weight adjustable, cushion plunger and limb alignment capability).

Forces acting on the arrow

For the purpose of simplicity, all discussions from this point on will be made in reference to a right handed archer shooting a right handed bow. If the archer is shooting a left handed bow the same comments apply but in reverse.

As the archer releases the arrow, the string moves horizontally to the left (facing the target) moving the nock to the left. As the string starts to move forward moving the nock end of the arrow, the point end resists this move and this results in the arrow bending toward the bow. When the arrow completes this initial bend, the string and nock move back toward centre and then to the right of centre. At this moment the front section of the arrow pushes against the sight window face or a cushion plunger if fitted. All of this action occurs in a fraction of a second in the first several inches of forward travel of the arrow. In the next horizontal bending sequence as the arrow leaves the bow face and arrow rest the arrow is in a nearly free

mode, only being held by the bowstring during this second half cycle. At the end of this complete cycle (bending in toward then bending away from the bow), the arrow nock disengages from the bowstring sending the arrow on its way to the target. These actions of the arrow are termed “Archer’s Paradox” and are the cause of arrow vibration and arrow horizontal oscillation.

The drawing shows the position of the fingers at full draw and at the time of the release, the path of the string and the initial bending of the arrow as the string propels it toward the target.

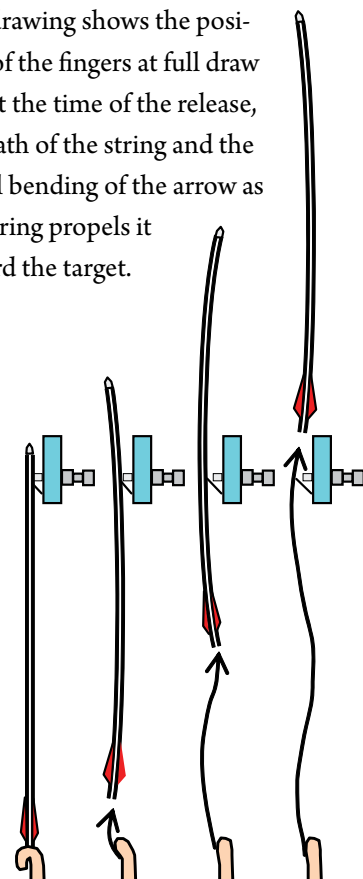

Figure 3.

Front of Centre Balance (FOC)

Arrows fly more accurately and with more stability if they are front heavy. This is particularly true of shooting in the wind. The term used to describe the location of the arrow's balance point is FOC. It is defined as how far the balance point is forward of the arrow's mid point and is expressed as a percentage of total arrow length.

$$\text{FOC} = \frac{L/2 - B}{L} \times 100$$

Where: L is arrow length
B is length from balance point to front of arrow

For outdoor shooting, many archers assemble their arrows with quite a high Front of Centre balance point, though this depends on the type of arrows being assembled, the length of arrow and the poundage/speed of the bow. Consideration must be given to acquiring a good sight mark at the longest distance being shot. For indoor shooting a high Front of Centre balance point may be used but be aware that going too high may be detrimental to the performance required.

Tuning and Bow Set-up

Tuning and bow set-up are the processes by which the archer can adjust the bow and arrow so that the flight problems caused by the Archer's Paradox can be minimized and good arrow grouping can be achieved. The tuning process is a whole system process wherein the bow, all of its attachments, the arrow and the archer can be brought into harmony. Any change, simple as it may seem, can affect bow tune. Something as simple as a new set of finger tabs can have a dramatic affect on a finely tuned bow. The tuning process is a discipline wherein the shooting characteristics of the arrow are modified to optimize performance. Bow set-up is a series of equipment based tasks whereas tuning is required to accommodate the shot variations caused by the archer. Properly made, matched arrows will group tightly when shot out of a shooting machine however an archer shooting the same equipment will experience shot variation.

Bow Set-up

Install All Accessories

Before starting the bow tuning process, be sure to install every piece of equipment on your bow that you intend to use during shooting. This includes the correct bowstring and all attachments to the bow string, bow sight,

stabilizers, arrow rest, cushion plunger, counter weights etc. Choose all personal items as well as, your tab, chest protector and anything else you use when shooting. For example, simply changing a stabilizer can have an enormous effect on the tune of your bow.

Once the equipment is fully assembled, the next phase in the process of achieving well tuned equipment is a good preliminary setup. If the initial/preliminary setup is done properly, the tuning process can be accomplished with little effort. By following these bow setup guidelines in the initial preparation of your equipment, you can eliminate many of the possible tuning problems that can make the process time consuming and unsuccessful. Adjustments made to the bow, changes in bow components, or alterations in shooting form can affect the tune of your equipment. Remember, you and your equipment share a unique relationship and are totally integrated. Any change to either will produce varying results. During the tuning process, it is vitally important that you change only one variable at a time. Otherwise, it is very difficult to determine what adjustment caused any grouping change.

Nock-to-Bowstring Fit

The force necessary to separate the nock from the bowstring serving is very critical, especially on light draw weight bows (35 lbs. and under). Nock tension should be tight enough so the arrow can easily support its own weight when the arrow is hung from the bowstring in a horizontal position but weak enough so that the arrow will fall if the string is tapped sharply with your finger (see figure 4 below). In order to get the proper nock fit you can use either a large or small groove nock or adjust the serving diameter by choosing different serving thread diameters. If the string tension is too loose, there is a danger of the nock slipping off the string at full draw causing a dry fire. This could not only damage the bow, but can also cause a serious bruise to the archers bow arm.

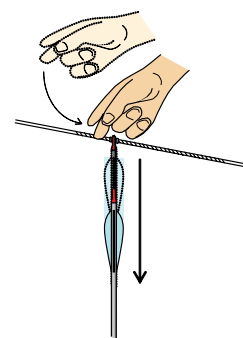

Figure 4.

Install the Arrow Rest

A wide variety of arrow rests is available to the archer. They all have one thing in common – they must be fitted so that the angle of the arm assists the arrow to stay on the rest and does not allow the arrow to slide off the rest before the shot is made (figure 5). Rests range from the simple stick on plastic variety to adjustable metal arms which move away from the arrow as it is shot. The high speed films described earlier show that the main function of the rest is to support the arrow during draw and during the initial movement of the arrow forward. As archer’s paradox takes place the arrow lifts off the rest. The rest needs to be adjusted so that the centre of the arrow is contacting the centre of the cushion plunger (Figure 5), and the support arm must be adjusted so that it is not visible past the outside of the arrow shaft when observed from an overhead view (figure 6).

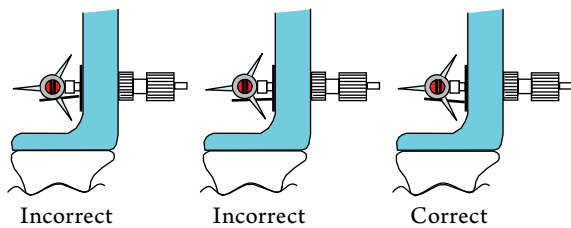

Figure 5

Angle of arrow rest arm & Plunger alignment with the arrow.

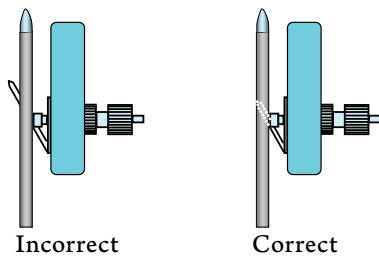

Figure 6
Arrow Rest Arm.

Install the Nocking Point

This is a common step with all recurve bows. Install a moveable nocking point on the bowstring. Clamp-on types are satisfactory and easy to install but affect arrow flight. We suggest that you use a tie on nocking point.

Initial Nocking Point Position.

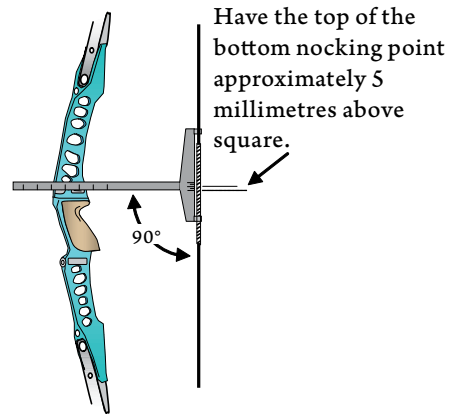

Figure 7.

Initially, position the nocking point on the bowstring about 5mm (1/4 inch) above square (Figure 7).

The nock of the arrow will be placed above this nocking point. After this nocking point is in place tie a 2nd nocking above the first one with sufficient room between the two points so that a nock will easily fit between. This will prevent an arrow from sliding down the string during shooting.

Tying on a Nocking Point

The tied on nocking point is made with a short piece, 30-50cm (12-20”) of the same serving material used to serve the string. Begin by tying an overhand knot around the bowstring serving. Next take the free ends, turn them under the bowstring and tighten the knot. Alternate knots above and below the string until you have tied 8-10 knots. End the nocking point by tying the final knot in a square knot. Cut off the loose ends to about 5mm (1/4”) length and heat them with a match or lighter. They will burn back to the main knot and fuse the fibres of the string you used for the nocking point. This nocking point can be moved up or down the serving by twisting it since it acts like a nut and the served string as the screw. This is the reason you should use the same material as you used for the serving since you get a perfect thread match.

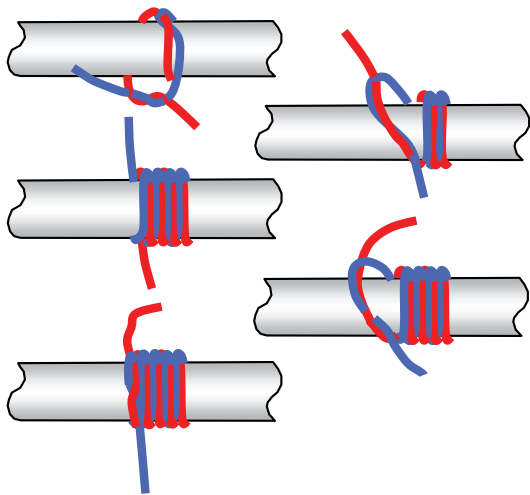
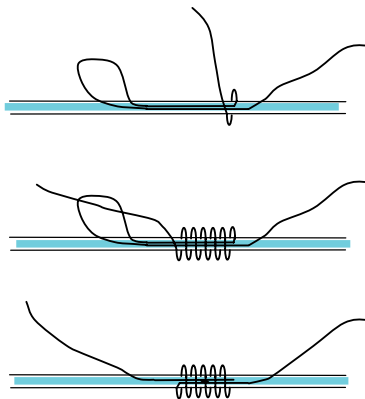

Figure 8.

Tying on a simple Nocking Point

Or you can tie a temporary and more simple one, as shown in Figure 9 below.

Serving material or dental floss can be used for making a nocking point. The drawing below shows a way to eliminate knots or loose ends



When the nock is completed cut the ends off and add a little glue

Figure 9.

Finding the Limb Centres

In order to have a reference point from which to adjust the arrow's left/right position on the bow, it is necessary to find and mark the exact centre of the limbs on your recurve bow. During the whole set-up process the bow should be mounted on a bow vice so that the limbs do not touch anything since this could distort the fragile limbs. An elaborate vice is commercially available but a simple tool can be made of wood to accomplish this (see Figure 10).

Figure 10

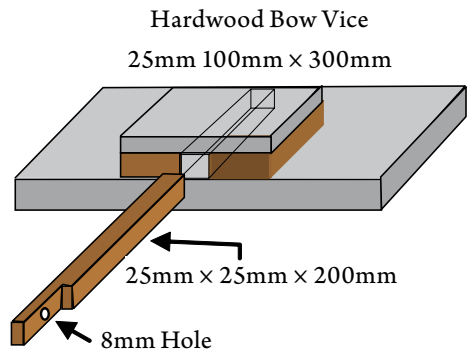

The wooden vice can be set to hold the bow either vertically for limb/arrow alignment or horizontally for serving the string (see Figure 11).

Figure 11.

Bow Orientation in Vice





To find the limb centre for a recurve bows, place a piece of masking tape across the inside of each limb near the limb pockets). Measure the width of each limb and make a small vertical mark on the tape in the exact centre of each limb about 15cm (6 in.) from the limb pockets of the riser. Be very accurate when doing this and measure several times to know you have located the exact centre of each limb. This mark will be used for arrow centering. It may be easier to see if the string is centralised if two lines are marked on the limb, instead of one, which are 3 millimetres apart. With one line this line would be hidden behind the string when alignment is being checked. More conveniently use commercially available “Limb Line Gauges” available from most good archery shops.

After you mark the limb centres on the tape or install the Limb Line Gauges, stand back and attempt to sight align the string with the 2 marks. If you cannot do this you will need to either average the alignment or if your bow has the capability of adjusting limb alignment, do so. This is most easily accomplished by placing one marked tape where the limb comes out of the riser and one tape at 15cm (6in.) from the bow tip on both limbs (or use specific gauges). You can then check the alignment of the 4 marks to assess if the limbs are properly aligned (Figure 12). Stand back and sight through the string to see if it covers all 4 marks. If not, make limb alignment adjustments as required.

Some bows may have a slightly bent riser or crooked limbs. In this case, since the string will not perfectly bisect the centre of both limbs at the same time, you will need to compensate or average the string position for the slight imbalance. This does not mean the bow will not shoot accurately, it simply means you need to compensate for this situation.

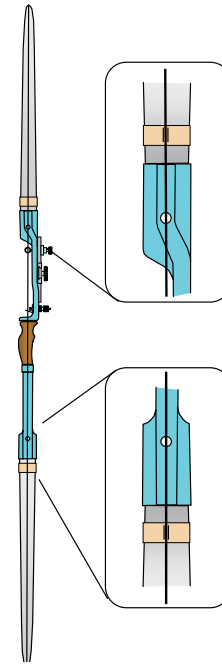

Figure 12.

“Centering” the Arrow: Adjusting the Arrow’s Left/Right Position

The objective of arrow centering is to have the arrow leave the bow in the same vertical plane as the average string force moves. To accomplish this, the archer should stand behind the bow which is held in a vertical position and sight forward through the string which is aligned with the bow centreline. See Figure 13 for proper arrow centering. The arrow should be moved in or out from the bow so that the point appears just to the left of the string. For bows equipped with a cushion plunger this can be accomplished by turning it in or out. Bows without a cushion plunger can be built out from the bow face if the arrow must be moved left however if the point is already outside of the string it is impossible to move the point further right because of the riser.

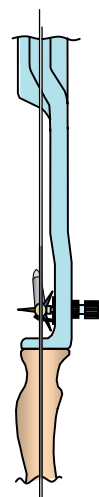

Figure 13.

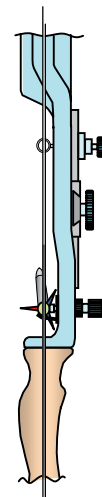

Figure 14.

Align the Bow Sight Pin or Aperture:

Set the sight pin or aperture on your bow sight directly over the string when it is aligned down the centre of the bow, see figure 14. The one object of the tuning process which follows is to select the correct arrow and bow adjustment so that the arrow is aimed and moves forward in the force plane of the moving bowstring as the arrow is shot. You will notice a number of archers whose sight is either outside or inside the string. This is because they have tuned their bows to an improper initial arrow alignment or are using arrows either too stiff or too weak for their set-up.

Notes on Clickers

There are several things to be aware of when using a clicker. Be sure that the arrow is well supported on the rest and not held in place only by the tension of the clicker. Draw the bow a few times without the clicker to make sure the arrow can be drawn and let down without the arrow falling off the arrow rest. The clicker tension and angle are important too. The clicker should not be so stiff that it actually moves the cushion plunger in or places a downward pressure on the arrow. To test this, stand in front of a target (just in case you have an unexpected loose of the string) and draw the arrow through the clicker as if you were going to shoot, but do not shoot the arrow. Rather, watch only the arrow on the rest to detect any movement of the arrow at the moment the arrow is pulled through the clicker and the clicker makes contact with the riser. If there is any movement of the arrow, either a bounce on the arrow rest or the arrow moves out due to cushion plunger activation, you need to correct this. There must not be any observable movement of the arrow when the clicker is activated.

Set the Cushion Plunger Pressure

If the bow is equipped with a cushion plunger, set the plunger tension to 40% of the tension of the lightest spring. The setting will change later on in the tuning process. If you don't use a cushion plunger, your tuning adjustments are going to be far more limited in the tuning process.

Setting Initial Brace Height

Start with the brace height at the lower end of the manufacturer's recommendation range or use the following chart.

64" 8 1/8"–8 3/8" (21.0 cm–21.6 cm)

66" 8 1/4"–8 1/2" (21.3 cm–21.9 cm)

68" 8 3/8"–8 5/8" (21.6 cm–22.2 cm)

70" 8 1/2"–8 3/4" (21.7 cm–22.5 cm)

The manufacturer recommended brace height setting is only a guideline. Changing the brace height to a slightly higher or lower position can affect arrow flight and grouping. The proper setting for best arrow grouping performance will be determined later in the tuning section.

Tiller

Tiller is the term used to describe the relative bending of both bow limbs. It is assessed by measuring the perpendicular distance between the bow string and limb at the end of the limb pockets. By convention, the readings are made in reference to the upper limb reading. Hence, a positive tiller is one where the distance from the string to the upper limb at the limb pocket (a) is greater than the distance for the lower limb (b), see figure 15.

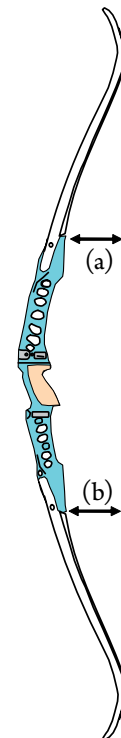

Figure 15.

A negative tiller is where the lower reading is greater. For many years it was accepted that a positive tiller was required since the archer was grasping the string above the bow centre and held the string with one finger above and two below the arrow nock and was a result of the pressure point of the hand on the riser. Recently most archers adjust the tiller to zero or leave it where the manufacturer

made the limbs. The latter is probably a bad idea since some limb pairs as purchased can have an initial tiller as high as 20mm (3/4 inch).

Some archers and coaches feel that it is necessary to adjust the tiller to keep the sight steady on the target. To do this, make very small adjustments to tiller (less than 2mm at a time) and see how your sight pattern is affected. Another indication that the tiller is correct is the bow hand will feel like one concentrated point rather than a slight rocking feeling in the hand. On the other hand, many archers and coaches set the tiller at zero and leave it there.

One note of caution. Changing tiller moves the location of the nocking point and its position must be readjusted after each change in tiller. Increasing tiller moves the nocking point down and reducing tiller moves the nocking point up in relation to the arrow rest. The nocking point must be relocated after each tiller change. Do not use tiller adjustments as a means of moving the nocking point since changes in tiller affect how the bow performs.

Setting the Final Brace Height

All bows are different, even bows of the same make and model can have small variations in limb length. Therefore, it is important to locate a brace height that fits your particular bow and shooting style. Shoot a few arrows at the suggested beginning brace height, then unstring the bow, add 3-4 twists to the bowstring and shoot again. Continue this process until the bow feels smoothest and quietest when shooting.

If the bowstring is too short to allow a brace height at the lower setting, use a slightly longer string. If the string is too long to allow a higher brace height (and starts to knot-up from too many twists), try a slightly shorter bowstring. There are many custom bowstring makers who produce strings to your exact specifications including length, type of material, number of strands in the string and type and colour of serving. If there are a lot of twists in the string, it will take fewer twists to increase brace height than if there are few twists in the string. Also, it is not recommended to have too many twists in the string or it will act more like a spring than a string. But, there should be enough twists to make it look like a nice round cable.

Tuning

General

After the bow is set-up as outlined above, the archer may begin the tuning process.

As described earlier, the finger release causes the arrow to vibrate and to oscillate in the horizontal plane. Arrow flight appears to follow a snake like movement pattern. These movements of the arrow are caused by archer's paradox where the string moves around the fingers on release. The goal of tuning is to select and adjust an arrow's flight characteristics to minimize these effects and to get the arrow to leave the bow with zero deg. angular rotation. It will still be vibrating but these vibrations are dampened out in the first 20-25m of flight by drag forces on the arrow shaft. Tuning will also minimize the archer's shooting form variability and help him get smaller groups.

Your shooting technique can have a large influence over the dynamic properties of your arrow. Two archers shooting the exact same bow, same poundage and the same arrow length may not necessarily require the same arrow size. Usually, the archer who has better "line", (see shooting form chapter for details on body alignment) will shoot a lighter (weaker) spined arrow than an archer who has poor skeletal alignment. This is because the archer with good alignment creates less side movement of the string on release resulting in less initial bending of the arrow shaft.

As will be shown shortly, there are a number of interacting tuning variables which can be employed to best tune your system. There is not one unique set-up of these variables to achieve the desired minimum group size you are seeking. In fact, it is normal to be able to achieve a good bow tune with more than one stiffness grade of arrow. With this in mind, many people prefer to tune their bow with a stiffer arrow because it is believed to be more forgiving. Forgiving in this sense is that the arrow will readily accommodate variations in the archers shooting technique.

Tuning is best carried out as a statistical process. Each arrow should be numbered to see if there is any flight bias, good or bad, associated with that arrow. The archer should shoot more than the minimum of shots to characterize their arrow flight. For example, if the method calls for shooting 1 or 3 arrows from a given distance it is suggested that the archer shoots at least 6 shots. The archer can then eliminate or discount any obvious poor shots from consideration.

Tuning Methods

There are a number of tuning methods used today but most are either lengthy or inaccurate. Many depend on the use of bare shafts as a primary reference for fletched arrow flight. Bare shafts do not have good flight characteristics unless the bow is fairly well tuned. Some of the tuning methods used and comments on them are:

Paper Tuning: Primarily a compound bow with release aid tuning method. Because of archer's paradox and the resultant arrow flight this method has little validity for people using their fingers to release the arrow.

Walk Back Tuning: Involves shooting arrows at distances of 20-40 metres without moving the sight and aiming at the same point and then analyzing the hit pattern. This method is not sufficiently sensitive in tuning carbon/aluminium shafts but is said to work satisfactorily with aluminium arrows.

Short Distance Tuning: This method involves shooting fletched arrows at a vertical and a horizontal line. It is used mainly to verify nocking point and cushion plunger in/out setting.

Bare Shaft Planing Test: This method compares the grouping pattern of bare and fletched shafts. It produces good results but shooting bare shafts before a good tune is achieved may be frustrating for the archer.

Fletched Arrow Group Tuning: This method has been used for many years and does not have a name. It is probably the simplest method that yields the best results of other tuning methods and is highly recommended. It can also involve shooting bare shafts but not before a basic tune is established.

Tuning Tools

In all of the tuning methods a number of variables can be used to adjust the shooting characteristics of an arrow. All of the following deal with the arrow's *dynamic spine* which is the amount of initial bend the arrow undergoes as the string is released. It is how weak or stiff the arrow is as it is shot. Most frequently this characteristic is referred to as the arrow's *spine*. Unfortunately, arrow manufacturers also use the same term, *spine*, to describe the *stiffness* of their shafts. These two "*spines*" are really "*static spine*" or the stiffness of the arrow at rest as measured by

a spine or deflection tester and "*dynamic spine*" which is the bending characteristics of an arrow as it is shot from the bow.

Factors Affecting Dynamic Spine

Dynamic spine is affected by a number of factors, most of which can be adjusted to improve arrow flight.

Adjustments to increase dynamic spine, "making the arrow shoot stiffer"

- decrease point weight
- add weight to the nock end of the arrow
- shorten the shaft
- decrease bow weight
- decrease brace height. Be careful here as this gives a longer power stroke thus makes the arrow seem weaker.
- increase string weight
- change arrows to a stiffer shaft size, i.e., lower static spine value.

Adjustments to decrease dynamic spine, "making the arrow shoot weaker or bend more"

- increase point weight
- lengthen the shaft
- increase bow weight
- increase brace height be careful here as this gives a shorter power stroke thus makes the arrow seem stiffer.
- decrease string weight
- change arrows to a weaker shaft size, i.e., increase static spine value.

There are some limitations in applying these changes. The point weights are determined by what the archer can purchase. If the archer is using aluminium arrows he can add lead to the inside of the point to increase its weight. It is obvious that you can cut off some of the arrows shaft to shorten it but you can't lengthen the shaft without purchasing new shafts. If you increase bow weight you may get to the point the bow is too heavy for you to control.

Bowstring

Serving weight (centre serving) can affect dynamic spine. For example, monofilament centre serving will cause the arrow to react stiffer than lighter weight nylon centre serving. Simply changing from a metal nocking point to a "tie-on" nocking point can have a noticeable affect on

arrow spine due to the weight difference between the two styles of nocking points.

Objective of Bow Tuning

The goal of tuning your bow is to set it up so that you can get the smallest group possible within your shooting ability.

Many people look for the best arrow flight or being able to shoot bare shafts into the fletched shaft group. There are many incidences where elite archers get excellent groups without perfect arrow flight. It is also normal for the bare shafts to hit just outside the fletched shaft group. Since bare shafts are lighter than fletched shafts and have a no rear weight (the fletchings), depending on the distance being shot, it might be expected that the unfletched shafts would hit higher and to the left (right hand archer) of the fletched shafts.

Starting the Tuning Process

Follow the many available manufacturers' spine charts to select the arrow size recommended for your draw length and bow poundage to use as a starting point in developing the proper arrows for you. Read all of the information provided on the proper use of the chart. Many people have found that the arrow sizes recommended by the manufacturer is at least one stiffness grade too stiff so it may be wise to try the arrows or pick one grade less stiff shaft as a starting point.

Verification that you have selected the correct spine will be determined during the tuning process. Problems caused by improperly spined arrow shafts will become evident during this process. Before tuning, be sure that all arrows are straight, properly fletched, and have perfectly aligned nocks. Now that you have completed the preliminary adjustments and properly set up your bow, you are ready to start the tuning process.

Establishing a Basic Tune

It is suggested that you begin with the Bare Shaft test. Shoot bare shafts at a target at 5m. In this way you will see how the shaft leaves the bow and you can adjust your nocking point and cushion plunger as needed. Adjust the nocking point as shown in Figure 16.

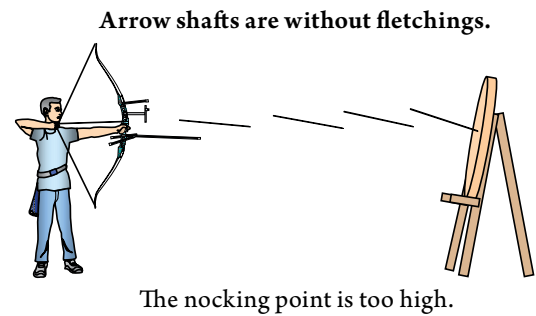

Figure 16.

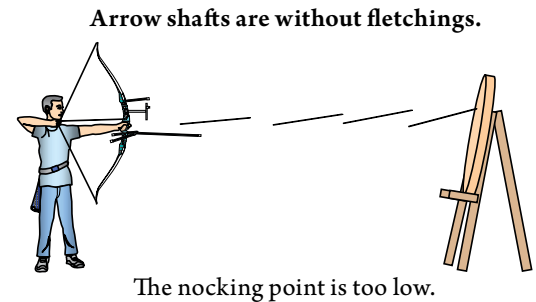

Figure 17.

Fishtailing: (caused buy mismatched arrow spine).

If the arrow leaves the bow with the nock end leaning to one side or the other, fishtailing occurs. The nock end of the arrow will appear to move from side to side as the arrow follows its flight path. See Figure 18.



Figure 18.

Using the **Bare Shaft Planing** Test to correct fishtailing, continue to shoot three fletched shafts and two or three identically aimed unfletched shafts. Again, make sure the bare shafts will hit the target before moving back further than 20 yards. If the unfletched shafts impact left of the fletched shafts, the arrow is too stiff (for a right-handed archer, opposite (weak) for a left hand archer). If the bare shafts impact more than 2" to 3" inches (5 to 8 cm) at 20 yards, this will mean that the bare shafts will be well away from the fletched shafts at a longer distance like 30 meters and may not even hit the target. In this case, is not likely that any decrease the spring tension on the cushion plunger will be much help. It is better to use a more effective **gross adjustment**, or a combination of adjustments before working with the cushion plunger (making sure that the cushion plunger is still set at a medium spring ten-

sion). If your bow weight is adjustable, increase the bow weight by approximately 1 pound. An adjustment more than one pound is not recommended unless the archer is in very good physical condition and even then an archer should never increase more than 2 pounds at a time as it could have detrimental affects on shooting technique and possibly induce an injury. Other gross adjustments that will improve the spine compatibility of an arrow that is too stiff are an increase in arrow point weight and a reduction in the number of strands in the string (reducing the physical weight of the bowstring). In the same relation, a decrease in the weight of the centre serving material or a decrease in the length of the centre serving will have a similar effect as well as a reduction in the weight of the nocking point (example: changing from a metal nocking point to a tie-on type).

If the unfletched shafts impact right of the identically aimed fletched shafts (weak), (for a right-handed archer, opposite (stiff) for a left hand archer), decrease bow weight slightly (if your bow weight is adjustable) and or decrease arrow point weight. Here, the bow weight would be your best adjustment to move the bare shafts into or near the same group as the fletched shafts. Going down in bow weight is not a problem other than losing a little arrow speed. Your equipment is basically tuned when the bare shafts and fletched shafts impact at the same or very near the same location. Once you have completed the Fine Tuning process do not be surprised if the bare shaft impact changes. It is common on a well-tuned bow to have the bare shafts impact a different location than the fletched shafts. Usually, a good tune will have the bare shafts impacting close to the fletched shafts in the horizontal plane, but if the nocking point height is not correct the bare shaft impact position may be slightly higher or lower than the fletched shafts impact position.

Cushion Plunger Setting

When correcting fishtailing using the Bare Shaft Planing Test, use the cushion plunger for fine adjustments only and not for large horizontal adjustments. It is important to first have good spine compatibility for the bow before using the cushion plunger to correct gross errors in spine. In the fine tuning process, the cushion plunger's ability for improving grouping will become evident. Also, it is important to note that when adjusting the cushion plunger tension, it will almost always affect nocking point height as well as dynamic spine. Don't be surprised if the bare shaft impacts change in height as well as horizontal impact.

If during the tuning process you are unable to get the unfletched shafts to impact near the fletched shafts in the horizontal plane, it will most likely be necessary to change arrow sizes. Your arrows might be too weak (the unfletched shaft impacts to the right of the fletched shaft for right-handed archers) or too stiff (the unfletched shaft impacts to the left of the fletched shaft for right-handed archers). If, after completing this test, the bare shaft impact is more than 3 inches (8 cm) to the right (weak) or left (stiff) of the fletched shafts at 20 yards (18 m), you will most likely need to change shaft size. However, before going to this more costly investment, make sure you are not having a false tuning indicator caused by a clearance problem. Usually, incompatible arrow spine is the biggest cause of a clearance problem, but not always.

Clearance

To check for clearance, use dry powder foot spray, dry deodorant spray or similar product applied to the last quarter of the arrow shaft, fletching, arrow rest assembly and sight window near the arrow rest. Do not disturb the powder sprayed on the arrow and bow while preparing to shoot. The arrow should be shot into a firm target so that it will not penetrate to the powder area. Then check the powder on the arrow to see if there are any marks indicating an impact between the arrow and bow.

Correcting Clearance Problems

If you are not achieving good arrow clearance, and the arrow fletching and bow make contact, optimum grouping cannot be achieved. By examining the areas where the dry powder spray is scraped off, the nature of any interference can be determined, and the position of the fletching as the arrow leaves the bow can be identified. If there is a clearance problem, this can usually be seen in the arrows flight to the target. A term used to explain the visual flight disturbance is called Minnowing. Like fishtailing or Porpoising, Minnowing describes a specific arrow flight disturbance. Minnowing will appear to look much like fishtailing except that the tail of the arrow appears to move from side to side more quickly, and the amount of side swing is usually much less than in fishtailing. See Figure 19.

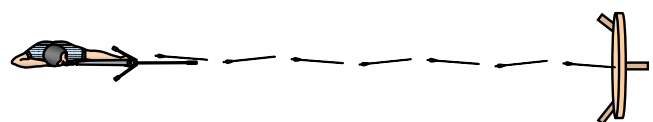

Figure 19.

Minnowing indicates inadequate clearance and is caused by the rear portion of the arrow (usually fletching) contacting the arrow rest or cushion plunger. The following procedures can help you correct clearance problems that cause minnowing:

- If the arrow fletching is hitting the arrow rest, try rotating your arrow nock $\frac{1}{32}$ of a turn. Continue rotating the nock in $\frac{1}{32}$ -turn increments until clearance is achieved.
- Make sure your arrow rest support arm does not protrude past the outside of the arrow shaft when the arrow is resting on the support arm and is lying against the cushion plunger or side loading device. See Figures 5 & 6.
- Choose a lower profile fletching.
- Follow the procedures for Tuning Adjustments for nock indexing and arrow rest set up.
- Make sure the bow hand is well relaxed to eliminate bow hand torque.
- Move the cushion plunger slightly out from the bow to help increase clearance if the other tuning modifications have no effect.

Trouble-Shooting Arrow Groups

You may have heard someone say, “If your arrows group well at 20 yards, they will group at any distance,” or, “If your arrows group at long distances, they will group at short distances.” In some cases, neither statement is true. There may be a minute disturbance in the equipment that affects the equipment’s potential for superior accuracy causing poor arrow grouping. What follows here is information that will help you perform the fine tuning adjustments necessary to eliminate most or all of the minute tuning problems.

Many archers have experienced one or all of the following arrow grouping/arrow flight combinations: poor arrow flight and good grouping. This is commonly the result of a stiff arrow. The arrow yaws slightly as it leaves the bow, but usually recovers quickly and often produces very acceptable grouping.

Good arrow flight and poor grouping. Although this seems contradictory, the phenomenon is somewhat common and relates to the tuning method used, or a lack of fine tuning. Having perfect arrow flight, or having the bare shafts impact exactly with the fletched shafts using the Bare Shaft Planing Test, does not always mean your arrows will group well; it only means the arrows fly well.

The section on Fine Tuning will assist you in obtaining optimal grouping from your equipment as well as good arrow flight. It is best to work toward good arrow flight and good grouping as this will produce the most consistent results in any weather and especially windy conditions.

Arrow grouping patterns often reveal probable arrow flight problems. Two of the most common grouping indicators for determining arrow flight problems are described below.

Excessive Drag

If the arrow has too much drag, that is the fletchings are too large or the fletch are off-set too much, it can cause excessive drag and grouping will often suffer at long distance. For example, if shooting FITA distances of 90, 70, 50 and 30 meters for men and 70, 60, 50 and 30 meters for women, you may experience good grouping on all distances except for the longest distance. If this is the case, the arrow most likely has too much drag. Excessive drag will cause the arrow to become unstable due to the rapid decay of its forward velocity. When forward velocity drops too quickly, instability occurs. This unstable flight causes poor grouping at long distances and extreme vulnerability to wind drift. On lightweight arrows, it is very important to reduce drag to a minimum to maintain maximum downrange velocity. This can be done by reducing the size (height and/or length) of the fletching or by reducing the angle of the fletching, or both.

Insufficient Clearance

A clearance problem will usually have the opposite effect of excessive drag. Most often arrow grouping is acceptable at longer distances, however, the shorter distance groups are not reduced in size proportionately to those at the longer distances. This situation commonly results in short distance scores that are significantly less than what the longer distance scores would indicate. If this is a familiar scenario, look for a clearance problem or micro disturbance within the bow and arrow system. To correct, see the section on Clearance.

Adjusting the Bow and Arrow System

If you are having problems tuning your bow, you will need to make some modifications to your equipment to achieve a better tune. Here are some suggestions:

Bow Weight Adjustment

Virtually all target quality recurve bows have an adjustable draw weight system. Bow weight adjustment should be the first tuning consideration if your arrow reaction is significantly stiff or weak. It is important not to increase bow weight more than one to two pounds as it could have detrimental effect on shooting technique. Here is a good guideline to follow to know if you can physically handle any increase in bow weight. Simply draw and hold your bow at full draw for 60 seconds. If it you can hold the weight for an entire minute, you can handle the one to two pound increase. If the arrow reaction is too stiff when applying the bare shaft tuning test, increase the draw weight. If your arrow reaction is too weak, decrease the draw weight.

Bowstring

Bowstring “weight” can have a significant effect on arrow spine. Increasing or decreasing the number of strands in the bowstring can influence the arrow’s dynamic spine enough to require a shaft size change of up to one full size weaker or stiffer. If your arrow reaction is too stiff, decrease the number of strands in your bowstring. If your arrow reaction is too weak, increase the number of strands. Serving weight (centre serving) can also produce the same effect. For example, monofilament centre serving will cause the arrow to react stiffer than lighter weight nylon centre serving. Simply changing from a metal nocking point to a “tie-on” nocking point can have a noticeable effect on arrow spine as well due to the weight difference between the two styles of nocking points.

Point and Insert Weight

The arrows dynamic spine can be tuned by using various point and/or insert/outsert weight combinations. If your arrow is too weak, go to a lighter insert or point. If your arrow is too stiff, try a heavier insert or point. Continue to change insert and/or point weights within an acceptable balance point range (10–18% F.O.C.).

Documenting Equipment

Once you have completed the Bare shaft Planing Test and before starting the fine tuning process, it is important to write down the exact measurements of your bow. Having all of the equipment information documented will allow you to return to the initial settings if something strange happens during the fine tuning process. When your bow and arrow are fully compatible and optimum arrow flight

and grouping have been achieved, then you will want to re-document the equipment for future reference.

Following is most of the information that should be included in the documentation.

- a. Nocking point height.
- b. Brace height.
- c. Tiller.
- d. Number of strands in the bowstring and type of material.
- e. Type of centre serving and end serving.
- f. Bow string weight (use a grain scale).
- g. Weight of bow at full draw weight.
- h. Type of stabilizers used, length, amount of weight on each rod etc.

In other words, everything you can think of to document your equipment.

Next, number all of your arrows. This enables you to plot groups and to plot each individual arrow. This process is very important in discovering which arrows group consistently and those that don’t. Another good trick is to place a small “dot” on one fletch each time that arrow hits the “10” ring (best to do this only for the longer distances). Pretty soon, it is clear what arrows you will want to use in competition the ones with the most dots!

When you are ready to start the fine tuning process, use a new 40 cm target face and use it as the “plotting” target. This will allow you to record each arrow impact and the number of that arrow to determine common impact points for each arrow in the bunch.

- Prepare to shoot from a distance you are most comfortable with from 40 to 70 yards or meters, on a face size you are comfortable with, and depending on your skill level.
- Shoot an end or two to warm up before starting the plotting process.
- After warming up, shoot a group of 6 to 10 fletched arrows.
- Write down the number of each arrow and the impact point on the sample “plotting” target.
- Shoot at least two groups before making any adjustments. Remember to make only one adjustment at a time. When making a tuning adjustment, use a different coloured pen for each time an adjustment is made or use another plotting target so the results are not confused.

- Examine the groups for patterns to see if the group is more vertical than horizontal, more horizontal than vertical or if there is not discernable pattern.

Reading the Plotted Arrow Groups

Carefully examine the arrow grouping patterns you plotted. Note the different shapes of the groups and how the adjustments altered the arrow impact and size of the groups. Examine each arrow by its number. Take careful note of any arrows that did not group consistently with the other shafts. Monitor these shafts to see if they are consistently out of the group as you will probably want to mark these shafts so you will know not to use them in competition.

Vertical grouping patterns

If the groups are more vertical than horizontal, adjust the nocking point $\frac{1}{32}$ " (.8 mm) either up or down. Shoot another two groups and plot the arrows in the same manner as described above. For future reference, be sure to write down your bow adjustment on each arrow group you plot. Measure the distance between the high and low arrow to determine an average between the groups. This will help to identify if the high and low arrow impact has improved or not in the next grouping sequence. If it has improved, make another adjustment of $\frac{1}{32}$ " (.8 mm) in the same direction and shoot another two ends. If the high and low arrow impact is better, continue in that direction until you achieve the most consistent group elevation. Obviously if the vertical impacts are worse, go back to the original setting and make the same adjustment in the opposite direction.

Horizontal grouping patterns

While tuning, remember to continue the documenting process on each plotted arrow group for the one tuning variable that was changed. For horizontal adjustments it is best to adjust only the cushion plunger spring tension, not the in/out position of the cushion plunger. Make adjustments to the cushion plunger spring tension in $\frac{1}{8}$ turn increments only. Shoot two groups and measure the farthest left and right arrows (eliminating arrows where known mistakes were made in the technique). Make the first spring tension adjustment either stiffer or weaker and shoot two more ends. Again, if the group becomes wider, go back to the original setting and make an adjustment of $\frac{1}{8}$ turn in the opposite direction. Compare the groups you just shot and determine if they are getting

better or worse. If the groups improved, make another adjustment of $\frac{1}{8}$ turn in the same direction and shoot another two ends. Continue this process until you have achieved the tightest possible grouping in the horizontal plane at that distance. If the groups do not change, continue following this procedure until the groups improve or become wider. At the point where the groups just start to get wider, go back $\frac{1}{8}$ turn to the previous setting and make a small nocking point adjustment. Remember, adjustments to the cushion plunger will often have some effect on the nocking point and it may be necessary to make small adjustments to the nocking point during the cushion plunger adjustments. Here is where you should see some significant group changes (hopefully much better). Remember to make only one adjustment at a time. If the groups become worse, go back to the original nocking point setting and make the same adjustment in the opposite direction to compare. Continue this process until the best possible groups have been achieved with this single adjustment. Then, start making $\frac{1}{8}$ turn spring tension adjustments to see what happens to the grouping patterns. Obviously if the groups are consistently GREAT, stop and re-document all the settings.

The fine tuning process is a dynamic relationship between the nocking point height and the cushion plunger spring tension. Any change to one affects the other and it is important to understand this relationship. When making only one adjustment at a time, you will find the ability to continually "compress" the up/down and left/right grouping patterns into the best possible grouping your skill level is capable of. After completing this procedure, you should find a combination of adjustments that will either slightly or significantly improve arrow grouping.

Once you have completed the long distance tuning, move to 20 yards (18 m) and see if the bow continues to group well here too. It should, but if not look for a clearance problem. By shooting all your competition distances at the end of the fine tuning, you will have confidence in knowing that your equipment can perform well at any distance when shooting competition.

Fine tuning the brace height

Finding the correct brace height for your bow can, in many cases, greatly improve consistency and grouping and should be considered as a fine-tuning adjustment.

The chart below shows the maximum range of brace height for most modern recurve bows. However, these are extreme at the high and low end of the range and

somewhere in between is most likely where your final brace height will end up. Changes within the brace height ranges shown can affect arrow spine as much as changing the arrow point and/or insert weight approximately 20 grains. Remember, it is best to shoot your bow at its smoothest and quietest setting. The chart below shows a range wide enough to create a “between” size arrow spine.

Maximum Recommended Brace Height Range for Most Competition Recurve Bows (by bow length)

64” - 7 ¾” to 9” (19.7 cm to 22.9 cm)

66” - 8” to 9 ¼” (20.3 cm to 23.5 cm)

68” - 8 ¼” to 9 ½” (21.0 cm to 24.1 cm)

70” - 8 ½” to 9 ¾” (21.6 cm to 24.8 cm)

Brace height is a fine tuning adjustment and should be done in small increments. When working through the fine tuning process, try making a small brace height adjustment to see how it affects grouping. If the string has very few twists, it will take more turns to achieve a specific change than if the string has numerous twists. Make adjustments in very small increments of 1/16” at a time and see how the groups are affected and note any changes in the sound and feel of the bow. If the string has many twists, it will take only one or two turns to achieve the 1/16” brace height change. If the string has very few twists, it may take 3 or more twists to achieve the same result.

Identifying Specific Arrow Problems

You may find an arrow that does not group well with the other arrows in the set. Examine it before you discard that arrow or retire it from competition. Sometimes a problem is easily identified and other problems are not so evident. If a shaft is cracked or dented it should be discarded. Some arrows may seem fine, but they may have problems that are not obvious and can cause the arrows to group poorly. The following list identifies common arrow problems, which may cause inconsistent or a stray impact.

Arrow Straightness

Arrows must be straight for tight grouping. Straightness should be within 0.004” or better for best grouping. This also depends where the bend is located. A slight bend near the nock end of the shaft may cause a greater impact variation than a larger bent that is over the full length of the shaft.

Crooked Nocks

There are several ways to check nock straightness, including commercially available nock gauges and special arrow spinning wheels. Make sure the nocks are absolutely straight. Crooked nocks can cause severe accuracy problems.

Nock Indexing

It is possible that one nock in the set may be turned more than the others. A clearance problem results if the nock is rotated too far, forcing the fletching into the arrow rest or cushion plunger when shot. Make sure all nocks are indexed the same and that the spacing between the two “clearance fletches” (the two vanes that clear past the arrow rest and cushion plunger) is the same. When fletching, it is common for some fletch to be spaced closer together than others on the shaft. Always choose the two vanes that are furthest apart to use as the clearance fletch.

Loose or Damaged Fletching

Fletching that is slightly damaged will not usually affect arrow grouping, but if the fletching becomes even slightly detached from the shaft, the arrow will not group with the others. The arrow may not even hit the target past 30 yards (meters). In the case of hard plastic vanes, if the rear of any vane is bent, it will also cause a change in impact.

Loose Points/Inserts

Many archers are not aware of this potential problem. Points must be properly installed with good hot melt adhesive or epoxy, depending on the shaft material. Carefully follow the instructions on point/insert installation from the arrow manufacturer. Some brands of hot melt are often brittle and may fracture when the arrow impacts hard target butt materials. If the cement fractures or the point is improperly installed, it can result in a separation between the point/insert and the shaft. When separation occurs and the arrow is shot, the separation of the bond between the shaft and point can cause the point to vibrate against the shaft wall affecting the arrow’s natural frequency of vibration and arrow accuracy. To test for point vibration, hold the arrow a few inches below the fletching and lightly tap the point on carpet or grass. If you hear a buzzing sound, the point/insert is probably loose. Heat and pull out the point/insert and properly reinstall. You

may also get the same buzzing sound if you tap the arrow against the string before loading.

Arrow Weight

Arrow weight is an important consideration for tournament archers and should be checked. If you have arrows that consistently impact a little high or low of your group it may be due to a slight weight variation. A matched set of arrows should have no more than a three grain spread

between the heaviest and lightest arrows in the set. Top tournament archers frequently match their arrows to one grain or less.

In conclusion, don't be afraid to make tuning adjustments as it is the best way to learn how you and your equipment interact. You will learn a lot in the process and as long as the equipment is well documented, you can always go back to the original settings.