

PC1616 / PC1832 / PC1864

This manual contains information on limitations regarding product use and function and information on the limitations as to liability of the manufacturer. The entire manual should be carefully read.

Reference Manual



DSC[®]



PowerSeries[™]

PC1616/PC1832/PC1864 v4.1
DLS2002 and higher

SECURITY SYSTEM

Table of Contents

Section 1: Introduction	1		
1.1 About the PC1616/PC1832/PC1864 System	1	2.5 Current Ratings - Modules & Accessories	6
1.2 About the PC1616/PC1832/PC1864 Manual Set	1	PC1616/PC1832/PC1864 Device Ratings	7
Reference Manual	1	System Output Ratings	7
Installation Guide	1	2.6 Assigning Zones to Zone Expanders	7
Programming Worksheets	1	2.7 Keypad Assignment	7
User Guide	1	How to Assign Keypads	7
1.3 Control and Indicating Equipment Specifications	1	Function Key Programming	8
Zone Configuration	1	2.8 Confirming Module Supervision	8
Access Codes	1	2.9 Removing Modules	8
Warning Device output	2	2.10 Zone Wiring	8
Memory	2	Burglary Zone Wiring Chart	8
Programmable Outputs (PGMs)	2	Normally Closed (NC) Loops	8
Power Supply	2	Single End Of Line (EOL) Resistors	9
Operating Environmental Conditions	2	Double End of Line (DEOL) Resistors	9
Keypad Specifications	2	Fire Zone Wiring - 4-wire Smoke Detectors	9
Alarm Transmitter Equipment (ATE) Specification	2	Compatible 4-Wire Smoke Detectors	9
System Supervision Features	2	Fire Zone Wiring - 2-wire Smoke Detectors	9
False Alarm Prevention Features	2	Compatible 2-Wire Smoke Detectors	10
Additional Features	2	2-Wire Smoke Detector Initiating Circuit	10
1.4 Additional Devices	3	Keyswitch Zone Wiring	10
Keypads	3	2.11 Keypad Zone/PGM	10
PC5100 2-Wire Addressable Interface Module	3	Assigning Keypad Zones	10
PC5108 Eight Zone Expander Module	3	2.12 Zone Activity Log	10
PC5132 Wireless Receiver Module	3		
PC5200 Power Supply Output Module	3	Section 3: How to Program	11
PC5204 Power Supply Output Module	3	3.1 How to Enter Installer Programming	11
PC5208 Eight Low Current Output Module	3	LED Keypad	11
Escort5580(TC) Module	3	LCD Keypad	11
PC5900 Audio Verification Module	3	3.2 Programming Decimal Data	11
PC5400 Printer Module	3	3.3 Programming Hexadecimal Data	11
PC5401 Serial Interface Module	3	3.4 Programming Toggle Options	11
T-Link Local Area Network Communicator	3	3.5 Viewing Programming	11
TL250/TL300 Intranet/Internet Communicators	3	LED and ICON Keypads	11
Alternate Communicators	3	LCD Keypad	11
PC5700/PC5720 Fire Module	4		
Enclosures/Cabinets	4	Section 4: Keypad Commands	12
1.5 Battery Standby Times versus AUX Load	4	4.1 Arming and Disarming	12
		Arming	12
Section 2: Installation and Wiring	5	Stay and Away Arming	12
2.1 Installation Steps	5	Stay Arming	12
2.2 Terminal Descriptions	5	Away Arming	12
AC Power Terminals	5	Disarming	13
Battery Connection	5	Event Buffer (Event Log)	13
Auxiliary Power Terminals - AUX+ and GND	5	Viewing the Event Buffer	13
Bell Output Terminals - BELL+ and BELL-	5	4.2 [*] Commands	13
Keybus Terminals - RED, BLK, YEL, GRN	6	[*][1] Zone Bypassing	13
Programmable Outputs - PGM1 to PGM4	6	[*][2] Trouble Display	13
Zone Input Terminals - Z1 to Z8	6	[*][3] Alarm Memory	14
Telephone Connection Terminals - TIP,RING,T-1,R-1	6	[*][4] Door Chime On/Off	14
2.3 Wire Routing for Power & Non-Power Limited	6	[*][5] Programming Access Codes	14
2.4 Keybus Operation and Wiring	6		

Installer's Programming - Codes and Options	15	Partitions and Zone Assignment	35
[*][6] User Functions	16	5.5 Communicator Programming	35
LCD Keypad User Functions	16	Communicator - Telephone Numbers	35
[*][7] Command Output Functions	16	[301] - First Telephone Number	35
[*][8] Installer Programming	16	[302] - Second Telephone Number	35
[*][9] Arming Without Entry Delay	16	[303] - Third Telephone Number	35
[*][0] Quick Arm	17	[304] - Call Waiting Cancel Dialing String	35
[*][0] Quick Exit	17	Communicator - Account Codes	36
4.3 Function Keys	17	[310] - System Account Code	36
4.4 Global and Partition Keypad Operation	18	[311]-[318] - Partition 1-8 Account Codes	36
4.5 Keypad Features	18	Reporting Codes	36
Automatic Scrolling of Open Zones	18	Communicator - Reporting Codes	36
Automatic Scrolling of Alarms in Memory	18	[320]-[323] - Alarm Reporting Codes, Zones 1 to 64	36
24 Hour Time Display Option	18	[324]-[327] - Alarm Restoral Reporting Codes, Zones 1 to 64	36
Keypad Zones	18	[328] - Miscellaneous Alarm Reporting Codes	36
Viewing Troubles While Armed	18	[329] - Priority Alarm/Restoral Reporting Codes	36
Backlighting Boost	18	[330]-[333] - Tamper Reporting Codes, Zones 1 to 64	36
Section 5: Programming Sections	19	[334]-[337] - Tamper Reporting Codes, Zones 1 to 64	37
5.1 Keypad Programming	19	[338] - Miscellaneous Tamper Reporting Codes	37
5.2 Basic Programming	19	[339]-[340] - Closing (Arming) Reporting Codes, Zones 1-32	37
[001]-[004] - Zone Definitions	19	[341] - Miscellaneous Closing (Arming) Reporting Codes	37
[005] - System Times	21	[342]-[343] - Opening (Disarming) Reporting Codes Access Codes 1 to 32	37
[006] - Installer's Code	21	[344] - Miscellaneous Opening (Disarming) Reporting Codes	37
I[007] - Master Code	21	[345] - Maintenance Alarm Reporting Codes	37
[008] - Maintenance Code/Guard Code	21	[346] - Maintenance Alarm Reporting Codes	37
[009]-[011] - Programmable Output Options	21	[347] - Miscellaneous Maintenance Reporting Codes	38
[012] - Keypad Lockout Options	24	[348] - Test Transmission Reporting Codes	38
[013] - First System Option Codes	24	[349] - PC5700 Maintenance Reporting Codes	38
[014] - Second System Option Codes	25	[350] - Communicator Format Options	38
[015] - Third System Option Codes	26	Reporting Codes	38
[016] - Fourth System Option Codes	27	Contact ID	38
[017] - Fifth System Option Codes	27	SIA (Level 2)	39
[018] - Sixth System Option Codes	28	Residential Dial	39
[019] - Seventh System Option Codes	29	Private Line Format	39
[020] - Keypad Zone Assignment	30	Pager Format	39
[021] - Eighth System Option Codes	30	Pulse Formats	40
[023] - Tenth System Option Codes	32	Scantronics Format	40
[030] - Fast Loop Response	33	Robofon Format	40
5.3 Advanced Programming	33	200 Baud FSK (CESA)	40
[101]-[164] - Zone Attributes	33	Telephone Line Monitoring (TLM)	41
[165] - Maximum Dialing Attempts	33	[351]-[376] - Communicator Call Directions	41
[166] - Post Dial Wait For Handshake	33	[377] - Communication Variables	41
[167] - T-Link Communications Wait for Acknowledge Delay	33	[378] - Test Transmission Time of Day	42
[168]-[169] - Daylight Saving Time	33	[379] - Periodic DLS Time of Day	42
[170] - PGM Output Timer	34	[380] - First Communicator Option Codes	42
[171] - Tamper PGM Output Timer	34	[381] - Second Communicator Option Codes	43
[172] - Settle Delay Timer	34	[382] - Third Communicator Option Codes	44
[173] - Bell Delay Timer	34	5.6 Downloading Options	45
[175] - Auto-arm Postpone Timer	34	Downloading	45
[176] - Cross Zone/Police Code Timer	34	[401] - First Downloading Option Codes	45
[178] - For Future Use	34	[402] - Downloading Computer's Phone Number	46
[181]-[188] - Auto-arm Schedules	34	[403] - Downloading Access Code	46
[190] - No Activity Arming Pre-Alert Duration	34	[404] - Panel Identification Code	46
[191]-[198] - No-Activity Timer (Partition 1-8)	35	[405] - Double-Call Timer	46
[199] - Auto-arming Pre-Alert Time	35	[406] - Number of Rings to Answer On	46
5.4 Partition & Zone Programming	35	[499] - Initiate PC-Link Communications	46
[201] - Partition Selection Mask	35		
[202]-[265] - Partition Zone Assignments	35		

5.7	Programmable Output Programming	46	6.1	Partitions and Fire System Configuration	51
	[501]-[514] - Programmable Output Attributes	46		Fire Configuration 1	51
	Assigning Partitions to Programmable Outputs	46		Fire Configuration 2	51
	[551]-[564] - PGM Partition Assignment	47	6.2	Fire Zones	51
5.8	International Programming	47		Standard Fire Operation	51
	[700] - Automatic Clock Adjust	47		Auto Verify Fire	51
	[701] - First International Option Codes	48		Four-Wire Smoke Detector Zones	51
	[702] - Second International Option Codes	48		Two-Wire Smoke Detector Zones	52
	[703] - Delay Between Dialing Attempts	49		Fire Supervisory Zone	52
5.9	Module Programming	49	6.3	Fire System Operation	52
5.10	Special Installer Instructions	49		Manual Signal Silence	52
	[900] - Panel Version	49		Automatic Signal Silence (Bell Time-out)	52
	[901] - Installer Walk Test Mode Enable / Disable	49		Manual Sensor Reset ([*][7][2])	52
	[902] - Reset Module Supervision	49		Subsequent Alarm Operation	52
	[903] - Module Supervision Field	49		Auto-Scroll LCD Keypad Display	52
	[904] - Module Placement Test	50		Fire Trouble Conditions	52
	[906] - For Future Use	50		AC Delays	53
	[989][Installer Code] - Default Master Code	50		Fire Reporting Codes	53
	[990][Installer Code] - Installer Lockout Enable	50	Section 7: Listing Requirements		54
	[991][Installer Code] - Installer Lockout Disable	50	7.1	UL Listed Commercial and Residential Installations	54
	[993]-[999] - Factory Defaults	50	Appendix A: Reporting Codes		56
	[993][Installer Code] - Restore Alternate Comm. Factory Default Programming	50		Contact ID	56
	[995][Installer Code] - Restore ESCORT5580(TC) Factory Default Programming	50		SIA Format - Level 2 (Hardcoded)	56
	[996][Installer Code] - Restore PC5132 Wireless Factory Default Programming	50		Contact ID Zone Alarm/Restoral Event Codes	57
	[997][Installer Code] - Restore PC5400 Factory Default Programming	50		SIA Format Automatic Zone Alarm/Restoral Codes	57
	[998][Installer Code] - Restore PC5900 Factory Default Programming	50	Appendix B: Wiring Diagrams		58
	[999][Installer Code] - Restore Factory Default Programming	50	B.1	PC1616/PC1832/PC1864 UL/ULC Wiring Diagram	58
Section 6: Fire Monitoring		51	B.2	PC1616/PC1832/PC1864 Standard Wiring Diagram	59
			B.3	PC1616/PC1832/PC1864 European Wiring Diagram	60
			B.4	PC1616/PC1832/PC1864 and PC5700 Fire Module Communications Connections	61
			B.5	Sensor Reset for 2-Wire Smoke Detectors	61
			B.6	Sensor Reset for 4-wire Smoke Detectors	61
			B.7	Other PGM Connections	61

The below symbols are used to indicate features that are only available in a particular market. No symbol indicates the feature is available for all markets.

				
Europe	Italy	United States	United Kingdom	Scandinavia

Section 1: Introduction

1.1 About the PC1616/PC1832/PC1864 System

This product is in conformity with EMC Directive 89/336/EEC based on results using harmonized standards in accordance with article 10(5), R&TTE Directive 1999/5/EC based on following Annex III of the directive and LVD Directive 73/23/EEC as amended by 93/68/EEC based on results using harmonized standards.

This product meets the requirements of Class II, Grade 2 equipment as per EN 50131-1:2004 Standard. This product is suitable for use in systems with the following notification options:

- A (use of two warning devices and internal dialer required),
- B (self powered warning device and internal dialer required),
- D (use of DSC model T-Link TL250 encrypted Ethernet communicator required).

The PC1616/PC1832/PC1864 are high end security systems. Below are the list of features for each panel:

	PC1616	PC1832	PC1864
On-board Zones	6	8	8
Hardwired Zones	16 (1xPC5108)	32(3xPC5108)	64 (7xPC5108)
Wireless Zones	16	32	32
Keypad Zone Support	8	8	8
On-board PGM Outputs	PGM 1 - 50mA PGM 2 - 300mA	PGM 1 - 50mA PGM 2 - 300mA	PGM 1/3/4 - 50mA PGM 2 - 300mA
Additional PGM Outputs	PC5208 - 8x50mA PC5204 - 4x500mA	PC5208 - 8x50mA PC5204 - 4x500mA	PC5208 - 8x50mA PC5204 - 4x500mA
Keypads	8	8	8
Partitions	2	4	8
User Codes	32 + Master Codes	32 + Master Codes	32 + Master Codes
Event Buffer	500 Events	500 Events	500 Events
Transformer Required	16.5VAC 40VA	16.5VAC 40VA	16.5VAC 40VA
Battery Required	4Ah / 7Ah / 14Ah	4Ah / 7Ah / 14Ah	4Ah / 7Ah / 14Ah
Bell Output	12V 700 mA (continuous)	12V 700 mA (continuous)	12V 700 mA (continuous)

The LCD keypad guides users through their available options with easy-to-understand prompts.

The status of the PC1616/PC1832/PC1864 system can be monitored over telephone lines, or using an alternative communicating device, including Skyroute™, T-LINK, GS-3050 and DVACS.

You can program the PC1616/PC1832/PC1864 using any system keypad, or using DLS downloading software and a computer (see section 3, 'How to Program').

Review the complete manual set before installing the PC1616/PC1832/PC1864 security system.

1.2 About the PC1616/PC1832/PC1864 Manual Set

Reference Manual

This manual provides:

- An overview of the system (Section 1: "Introduction")
- How to install and wire the system and its modules (Section 2: "Installation and Wiring")

- How to program the system (Section 3: "How to Program")
- An introduction to the user interface and keypad operation (Section 4: "Keypad Commands")
- An overview of the main system programming sections (Section 5: "Programming Sections").

Installation Guide

The Installation Guide provides the basic installation, wiring and programming information required to program the PowerSeries PC1616, PC1832 and PC1864 control panels.

Programming Worksheets

The Programming Worksheets provide a detailed list of all programming sections available in the panel and a place to record your programming. Be sure to record all your system programming in the **Programming Worksheets**. If adding modules to your PowerSeries Control Panel, refer to the **Installation Instructions** that come with each module.

User Guide

One user guide comes with the PC1616/PC1832/PC1864 system. The **User's Guide** provides easy to follow instructions for end users. Installers should also review this manual, in order to properly instruct the end-users once the installation is complete.

1.3 Control and Indicating Equipment Specifications

Zone Configuration

- 6 Fully programmable zones (PC1616)
- 8 Fully programmable zones (PC1832/PC1864)
- 34 zone types, 9 programmable zone attributes
- Zone configurations available: Normally closed, Single EOL and Double EOL zone supervision
- Hardwired zone expansion (fully supervised) available using the Model PC5108 (eight Zone Expander Module) and the Model PC5700 (Fire Module)
 - Expandable to 16 zones (PC1616)
 - Expandable to 32 zones (PC1832)
 - Expandable to 64 zones (PC1864)
- One zone input available on the keypads
- Wireless zone expansion (fully supervised) available using the Model PC5132 (RF Receiver, operating at 433MHz)

NOTE: PC1616 expandable to 16 zones only.

- Up to 2 partitions (PC1616)
- Up to 4 partitions (PC1832)
- Up to 8 partitions (PC1864)

Access Codes

- 39 access codes:
 - 32 User Codes (Level 2)
 - 1 System Master Code (Level 3)
 - 2 Supervisor Codes
 - 2 Duress Codes
 - 1 Maintenance/Guard Code
 - 1 Installer Code (Level 3)
- Programmable attributes for each user code (see **section 4.2** for details)
- 1,000,000 access code variations (using 6-digit codes)
- Duress codes derived from user codes plus 1 digit are not allowed

Warning Device output

- Rated 12VDC, 700mA, (current limit 2.0A) supervised (EOL resistor shall be used)
- Programmable as steady, pulsed or temporal three (as per ISO 8201) output
- Fire alarm notification has priority over burglary alarm notification

Memory

- CMOS EEPROM memory
- Retains programming and system status on AC and battery failure
- Data Retention: 200 years min.

Programmable Outputs (PGMs)

- Up to 14 programmable outputs (PGM) with 21 options
- PGM outputs are open collector type and switched to ground
- Three low current (50mA) PGM outputs on main panel (PGM1, PGM3, PGM4)

NOTE: PGM3 and PGM4 available on PC1864 only.

- One high current (300mA) output with 2-wire smoke detector capability on the main control board (PGM2)
- Eight additional low current outputs (50mA) available using the Model PC5208
- Four high current outputs (1A) available using the Model PC5204 (one configurable as a supervised bell output)

Power Supply

- 1.5A regulated (1.7A for UL/ULC), supervised and integral to the control unit
- Type A as per EN50131-6 Standard
- Input ratings: 120V, 60Hz Class II (220V-240Vac, 50/60Hz, 200mA for European installations)
- Transformer required, mounted in the same enclosure, permanently connected for European installations
- Transformer secondary ratings: 16.5Vac, 40VA min
- AUX Output Voltage: 12V_{DC}, -15%/+10% when AC Input Voltage is 85% to +110% of rated value and output current is 500mA (700mA for UL/ULC) (550mA for IMQ)
- Output ripple voltage: 270mVp-p max.
- Storage device: Rechargeable battery, rated 12VDC
- Battery capacity: 4Ah, 7Ah, 14Ah (2 x 7Ah) or 24 Ah (2 x 12Ah)
- Battery = One 12V 4Ah battery (For burglary applications)
- Battery = Two 12V 7Ah (min.) rechargeable sealed lead acid for 24-hr backup (For fire monitoring applications)
- Maximum standby time 24Ah (when using 14Ah battery capacity and AUX current limited to 480mA max.).
- Recharging time 48h
- Programmable recharging current: Low 400mA, High 700mA
- Low battery trouble indication threshold 11.5VDC
- Battery deep discharge protection (cut-off at 9.5VDC)
- Main board current draw: 85mA (set and unset state)
- Resettable fuses (PTC) used on circuit board instead of replaceable fuses
- Supervision for loss of primary power source (AC Fail), battery fail or battery low voltage (Battery Trouble) with indication provided on the keypad
- Internal clock locked to AC power frequency

Operating Environmental Conditions

- Temperature range: -10°C to +55°C (14°F to 131°F)
- Relative humidity: 93% non condensing

Keypad Specifications

- Each keypad has 5 fully programmable function keys (see Section [000] in the programming section.

- "T" version keypads have tamper protection
- Connect up to 8 keypads
- Four wire (Quad) connection to Keypad
- Built in piezoelectric buzzer

Alarm Transmitter Equipment (ATE) Specification

- Digital dialer integral to the main control board
- Complies with TS103 021-1, -2, -3 Telecom equipment requirements
- Supports the following communications formats:
 - 10 BPS/20 BPS
 - DTMF Contact ID
 - SIA FSK
 - Pager
 - Residential Dial
 - Private Line
 - Scantronics 4-8-1
 - Robofon
 - CESA 200
- Split reporting of selected transmissions to each telephone number
- 3 programmable telephone numbers
- 1 system account number
- Upto 8 partition account numbers
- Supports Skyroute™ Cellemetry Communication Transceiver
- GS3050 GSM Universal Wireless Alarm Communicator
- DTMF and pulse dialing
- DPDT line seizure
- Anti-jam detection
- Event-initiated personal paging
- T-Link/T-Link TL250/T-Link TL300 Ethernet Communications (using PC-Link) for Intranet/Internet connectivity.

System Supervision Features

The PC1616/PC1832/PC1864 continuously monitors a number of possible trouble conditions and provides audible and visual indication at the keypad. Multiple signals are indicated using scroll buttons on the LCD keypads (no priority assigned) or by different lights on the LED's keypads. Trouble Conditions include:

- AC Power Failure
- Low Battery Condition
- AUX Power Supply Fault
- Bell Output Trouble
- Telephone Line Trouble
- Failure to Communicate
- Loss of Internal Clock
- Module Fault (Supervisory or Tamper)
- Trouble by Zone
- Fire Trouble
- Tamper by Zone

False Alarm Prevention Features

- Audible Exit Delay
- Audible Exit Fault
- Urgency on Entry Delay
- Quick Exit
- Swinger Shutdown
- Recent Closing Reporting Code
- Cross Zone/Police Code Alarm
- Burglary-Verified Timer
- Communication Delay
- Rotating Keypress Buffer

Additional Features

- Automatic inhibit (swinger shutdown) for Alarm, Tamper, Trouble signals after 3 occurrences in a given set period

(see section [377]), Opt [1] alarms, [2] tampers, [3] troubles.

- Programmable keypad lockout option (see section [012])
- Automatic arming by partition at a specified time, each day of the week
- No activity arming
- Keypad activated alarm output and communicator test
- Keypad lockout
- Audio capability using the PC5900 Audio Verification Module and central station 2-way listen-in
- All modules connect to the system via a 4-wire Keybus, up to 1000'/305m from the main panel
- Event buffer can be printed using PC5400/PC5401 RS-232 Serial Interface module
- Supports the Escort5580(TC) Voice Prompt Module, with automation and lighting control
- 500 event buffer, time and date stamped
- Uploading/downloading capability
- Daylight savings time option

1.4 Additional Devices

If a Fault or Tamper condition occurs on a zone while the system is disarmed, a trouble condition will be indicated. If a Fault or Tamper condition occurs on a zone while the system is armed, the bell will be sounded. This applies to zones and zone expander modules, and cannot be changed. This feature will be active for the following modules:

- PC5108
- PC5700
- PC5132
- PK55XX with a zone programmed
- RFK55XX with a zone programmed

Keypads

A maximum of 8 keypads can be connected to the control panel. You can connect any combination of the following listed.

- PK5500/RFK5500 LCD keypad
- PK5501/RFK5501 ICON keypad
- PK5508/RFK5508 8 Zone LED keypad
- PK5516/RFK5516 16 Zone LED keypad
- LCD5511 Fixed Message LCD keypad
- LED5511Z 8 Zone LED keypad
- PC5508Z 8 Zone LED keypad
- PC5532Z 32 Zone LED keypad
- PC5516Z 16 Zone LED keypad
- LCD5500Z Liquid Crystal Display (LCD) keypad
- LCD5501Z LCD-style keypad

PC5100 2-Wire Addressable Interface Module

The PC5100 module is used to connect 2-wire addressable devices to the system. Up to 32 2-wire addressable devices can be added to the system.

NOTE: PC5100 v1.0 and lower modules can only support the first 32 zones on the PC1616/PC1832/PC1864 system.

NOTE: PC1616 expandable to 16 zones only.

PC5108 Eight Zone Expander Module

Eight zone expander module can be used to increase the number of zones on the system. Up to 7 modules can be connected to increase the system zones to a maximum of 64 (see the PC5108 Installation Instruction Sheet.)

NOTE: PC5108 v1.0 and lower modules can only support the first 32 zones on the PC1616/PC1832/PC1864 system. PC5108 v1.0 and lower modules enroll as two modules and use up two supervisory slots.

NOTE: Do not mix PC5108 v1.x and lower modules with PC5108 v2.0 and higher modules on the same system.

NOTE: PC1616 expandable to 16 zones only. The PC1832 expandable to 32 zones only.

PC5132 Wireless Receiver Module

The PC5132 Wireless Receiver module can be used to connect up to 32 fully supervised wireless devices (see the PC5132 Installation Manual for details).

NOTE: Only the first 32 zones on the PC1616/PC1832/PC1864 system can be used as wireless zones.

NOTE: PC1616 expandable to 16 zones only.

PC5200 Power Supply Output Module

The PC5200 can provide up to 1 Amp of additional power for modules or devices connected to the control panel. Up to 4 modules can be connected to the system. Each module requires a 16.5VAC 40VA transformer and 4 AH battery (see PC5200 Installation Instructions for details).

PC5204 Power Supply Output Module

The PC5204 can provide up to 1 Amp of additional power for modules or devices connected to the control panel. The module requires a 16.5VAC 40VA transformer and 4Ah(min.) battery. In addition, the module provides 4 programmable high current outputs (see PC5204 Installation Instructions for details).

PC5208 Eight Low Current Output Module

Adds 8 programmable low current outputs (50mA) to the control (see the PC5208 Installation Instructions for details).

NOTE: If you use the main panel and the PC5208 outputs, PGM 3 will work the same as the first PC5208 output, and PGM 4 will work the same as the second PC5208 output.

Escort5580(TC) Module

This Escort5580(TC) module will turn any touch-tone telephone into a fully functional keypad. The module also includes a built-in interface to control up to 32 powerline carrier type devices for lighting and temperature control (see the Escort5580(TC) Installation Manual for details).

NOTE: An Escort5580(TC) version 3.x or higher is needed to support more than 32 zones and/or 2 partitions.

PC5900 Audio Verification Module

The PC5900 series Audio Verification Modules provide "Talk/Listen-In" capability for audio verification of alarms. The module permits the central station to monitor up to four microphones and to communicate to the occupants through 2 separate speakers.

PC5400 Printer Module

This PC5400 Printer Module allows the panel to print all events on the system to any serial printer. All events will be printed with the partition, time, date and the event that occurred (see PC5400 Installation Manual for details).

NOTE: The PC5400 v2.x and lower only supports events on partitions 1 and 2, and zones 1-32.

PC5401 Serial Interface Module

The PC5401 Serial Interface Module can be used to communicate with 3rd party devices (automation) through a standard RS-232 serial connection (see the PC5401 Developer's Guide for more information on communicating with the PC5401 module).

T-Link Local Area Network Communicator

The T-Link Local Area Network Communicator provides an efficient method of communicating via a Local Area Network (LAN). See the T-Link Installation Manual for more details.

TL250/TL300 Intranet/Internet Communicators

The T-Link Ethernet Communicator provides an efficient method of communicating via Internet/Intranet. See the T-Link TL250/TL300- Installation Manual for more details.

Alternate Communicators

Refer to the associated Skyroute™ Installation Manual, or GS3050 Installation Manual for programming details.

PC5700/PC5720 Fire Module

This is a zone expansion fire module that can be used for ULC Listed non-residential fire applications. The PC5720 can be used as an interface between the control panel and either a serial printer or a DVACs communication network.

NOTE: The PC5700/PC5720 enroll as two expander modules and use two supervisory slots each.

NOTE: Do not mix PC5700 v1.x and lower modules with PC5108 v2.0 and higher modules on the same system.

Enclosures/Cabinets

The PC1616/PC1832/PC1864 main board can be installed in the following metal enclosures/cabinets:

Enclosure	Description/Dimensions
PC500C	Description: Alternate Main Control Cabinet (Household Burglary). Approximate Dimensions: 213mm x 235mm x 76mm / 8.4" x 9.25" x 3.0"
PC5002C	Description: Cabinet to house the PC5204 Power Supply Output Module. Approximate Dimensions: 213mm x 235mm x 76mm / 8.4" x 9.25" x 3.0"
PC5003C (Removable Door)	Description: Main Control Cabinet for the PC1616/PC1832/PC1864 main panel with removable door. (UL/ULC Household Fire & ULC Commercial Burglary) Made with 22Ga steel. Approximate Dimensions: 287mm x 297mm x 76mm / 11.3" x 11.7" x 3.0"
PC5003C (Hinged Door)	Description: Main Control Cabinet for the PC1616/PC1832/PC1864 main panel with removable door. Made with 1.2mm thick steel. Approximate Dimensions: 287mm x 297mm x 76mm / 11.3" x 11.7" x 3.0"
PC5004C	Description: Cabinet to house the Escort5580(TC) Module and PC5400 Printer Module. Approximate Dimensions: 229mm x 178mm x 66mm / 9.0" x 7.0" x 2.6"
PC5001C	Description: Cabinet to house the PC5108 Zone Expander Module and the PC5208 Eight Low Current Output Module. Approximate Dimensions: 152mm x 122mm x 38mm / 6.0" x 4.8" x 1.5"
PC5001CP	Description: Plastic Cabinet to house the PC5108 Zone Expander Module and the PC5208 Eight Low Current Output Module. Approximate Dimensions: 146mm x 107mm x 25mm / 5.75" x 4.2" x 1.0"
PUC-1	Description: Main control cabinet for the PowerSeries panel. Made with 18Ga steel. Approximate Dimensions: 318mm x 318mm x 102mm / 12.5" x 12.5" x 4.0"
CMC-1	Description: Alternate Main Control Cabinet (Commercial Burglary) Approximate Dimensions: 287mm x 297mm x 76mm / 11.3" x 11.7" x 3.0"
Multi-3	Description: Cabinet to house the PC5937. Approximate Dimensions: 287mm x 297mm x 76mm / 11.3" x 11.7" x 3.0"
HS-CAB1000B	Description: Structured wiring cabinet for PC1616/PC1832/PC1864 main panel, with a wire raceway in the center of the cabinet. Approximate Dimensions: 362mm x 362mm x 102mm / 14.25" x 14.25" x 4.0" Approximate Dimensions of Cover: 389mm x 389mm / 15.3" x 15.3"
HS-CAB3000LDR	Description: Structured wiring cabinet for PC1616/PC1832/PC1864 main panel, with a wire raceway in the center of the cabinet. Approximate Dimensions: 724mm x 362mm x 102mm / 28.5" x 14.25" x 4.0" Approximate Dimensions of Cover: 752mm x 389mm / 29.6" x 15.3"
HS-CAB4000LDR	Description: Structured wiring cabinet for PC1616/PC1832/PC1864 main panel, with a wire raceway in the center of the cabinet. Approximate Dimensions: 1086mm x 362mm x 102mm / 42.75" x 14.25" x 4.0"
PC4050C	Description: Alternate Main Control Cabinet (UL/ULC Household Fire & ULC Commercial Burglary) for the PC1616/PC1832/PC1864 main panel. Approximate Dimensions: 305mm x 376mm x 124mm / 12.0" x 14.8" x 4.9"
PC4050CR	Description: Alternate Main Control Cabinet (UL Commercial Fire) for the PC1616/PC1832/PC1864 main panel. Approximate Dimensions: 305mm x 376mm x 124mm / 12.0" x 14.8" x 4.9"

PC4050CAR	Description: Alternate Main Control Cabinet (ULC Commercial Burglary) for the PC1616/PC1832/PC1864 main panel. Approximate Dimensions: 305mm x 376mm x 124mm / 12.0" x 14.8" x 4.9"
-----------	--

Accessories can be installed in separate metal enclosures as follows:

Enclosure	Description/Dimensions
PC4003C	Description: Single expander cabinet made of 18Ga steel, painted, hinged door, weight: 1050g. Approximate Dimensions: 229mm x 178mm x 64mm / 9.0" x 7.0" x 2.5"
PC4051C	Description: Cabinet made of 18Ga steel, painted, hinged door, weight: 3600g. Approximate Dimensions: 427mm x 264mm x 106mm / 16.8" x 10.4" x 4.18"

All cabinets are provided with means for installing tamper protection switch (door opening detection and/or removal from the mounting position).

1.5 Battery Standby Times versus AUX Load

In accordance with EN50131-1 Standard, for a Power Supply Type A rated for Grade 2 systems, the battery standby time required in case of failure of the prime power source shall be a minimum of 12 hours.

The table below indicates the maximum load values applicable to the AUX+/-, Keybus (Red, Black) and PGM 1-4 outputs that the panel (PC1616/PC1832/PC1864) will be able to support when using a certain battery size for a certain period of time as applicable for each installation.

The AUX +/-, Keybus (Red, Blk) and PGM 1-4 outputs are all sharing the same load (max. 500mA), (max. 700mA for UL/ULC), (max. 550mA for IMQ). Please refer to the other Power Series accessories current ratings when calculating the maximum load applicable for each installation.

Battery Capacity	Standby Times			
	4hrs	12hrs	24hrs	36hrs
4Ah	500mA	220mA	-	-
7Ah	500mA	480mA	150mA	-
14Ah	-	500mA	480mA	280mA
24Ah	-	-	500mA	500mA

Standard Battery Charging Current: 400mA (280mA for IMQ). To be used with 4Ah or 7Ah batteries.

High Battery Charging Current: 700mA. To be used with 14Ah or 24Ah batteries.

NOTE: Program Section [701] option 7 to ON to enable high battery charging current, if 14Ah or 24Ah battery is used.

Refer to the following table for UL/ULC Applications:

Battery Capacity	Standby Times (UL/ULC)	
	4hrs	24hrs
4Ah	700mA	-
7Ah	700mA	180mA
14Ah (2x7Ah in parallel)	700mA	470mA

NOTE: When two batteries are required in order to meet the minimum standby times, the DSC Enclosure Model Power UC1 shall be used.

NOTE: A sealed, rechargeable, lead acid battery or gel type battery is required to meet UL requirements for power standby times.

NOTE: UL Residential/Commercial Burglary installations require 4Hrs Power Standby time.

NOTE: UL/ULC Residential Fire & Home Care installations require 24 Hr power standby. ULC Commercial Burglary and Fire monitoring installations require 24 Hr power standby.

NOTE: Replace batteries every 3-5 years.

NOTE: Battery capacity will deteriorate with age and number of charge/discharge cycles.

Section 2: Installation and Wiring

The following section provides a description of how to wire and configure devices and zones.

2.1 Installation Steps

The following steps are provided to assist with the installation of the panel. It is suggested that you read over this section briefly to get an overall understanding of the order of installation. Once this is done carefully work through each step. Working from this plan will help reduce problems and reduce the overall installation time required.

Step 1 Create a Layout

Draw a rough sketch of the building and include all alarm detection devices, zone expanders, keypads and all other modules that are required.

Step 2 Mounting the Panel

Locate the panel in a dry area, preferably located near an unswitched AC power source and the incoming telephone line. Before attaching the cabinet to the wall be sure to press the five circuit board mounting studs into the cabinet from the back.

NOTE: Complete all wiring before applying AC or connecting the battery.

Step 3 Wiring the Keybus

Wire the Keybus to each of the modules following the guidelines provided in Section 2.4.

Step 4 Assigning Zones to Zone Expanders

If zone expander modules are being used the modules must be configured so the panel knows which zones are assigned to each expander. Follow the guideline provided in Section 2.6 to assign zones to expanders.

Step 5 Zone Wiring

Power down the control panel and complete all zone wiring. Follow the guidelines provided in section 2.10 to connect zones using normally closed loops, single EOL resistor, double EOL resistors, Fire zones and Keyswitch Arming zones.

Step 6 Completing Wiring

Complete all other wiring including bells or sirens, telephone line connections, ground connections or any other wiring necessary. Follow the guidelines provided in section 2.2 "Terminal Descriptions".

Step 7 Power up the Control Panel

Once all zone and Keybus wiring is complete, power up the control panel.

NOTE: The panel will not power up if only the battery is connected.

Step 8 Keypad Assignment

Keypads must be assigned to different slots to be properly supervised. Follow the guideline provided in section 2.7 to assign keypads.

Step 9 Confirming Module Supervision

By default, all modules are supervised upon installation. Supervision is enabled at all times so that the panel can indicate a trouble if a module is removed from the system. To confirm that each module is properly supervised, follow the guidelines provided in section 2.8.

Step 10 Programming the System

Section 4.0 provides a complete description of how to program the panel. Section 5.0 contains complete descriptions of the various programmable features, what options are available and how the options function. The Programming

Worksheets should be filled out completely before attempting to program the system.

Step 11 Testing the System

Test the panel completely to ensure that all features and functions are operating as programmed.

2.2 Terminal Descriptions

AC Power Terminals

The panel requires a 16.5V, 40VA transformer. Connect the transformer to these terminals.

The panel can be programmed to accept a power line frequency of either 50Hz AC or 60Hz AC in programming section [701], option [1].

NOTE: Do not connect the transformer until all other wiring is complete.

Battery Connection

The battery is used to provide back up power in the event of an AC power failure and to provide additional current when the panel demands exceed the power output of the transformer, such as when the panel is in alarm.

NOTE: Do not connect the battery until all other wiring is complete.

Connect the RED battery lead to the positive of the battery, the BLACK battery lead to the negative.

The **High Current Charge/Standard Battery Charge** option (section [701], option [7]) allows you to choose between a high current battery charge and the standard battery charge rate.

.....
High Current/Standard Battery ChargeSection [701]: [7]
.....

Auxiliary Power Terminals - AUX+ and GND

These terminals provide up to 500mA of current at 12 Vdc (700mA of current at 12Vdc for UL/ULC) (550mA of current at 12Vdc for IMQ) for devices requiring power (**rated 11.6-12.6 Vdc for UL residential applications**). Connect the positive side of any device requiring power to the AUX+ terminal, the negative side to GND. The AUX output is protected; if too much current is drawn from these terminals (wiring short) the panel will temporarily shut off the output, until the problem is corrected.

NOTE: When using a 12V 14Ah battery, the maximum AUX capacity for 24-hour standby is 470mA.

Bell Output Terminals - BELL+ and BELL-

These terminals provide up to 2A of current at 12Vdc (with standby battery; 700 mA continuous) for powering bells, sirens, strobes or other warning type equipment. Connect the positive side of any alarm warning device to BELL+, the negative side to BELL-. The BELL output is protected; if too much current is drawn from these terminals (wiring short) the BELL PTC will open.

The Bell output is supervised. If no alarm warning device is being used connect a 1KΩ resistor across BELL+ and BELL- to prevent the panel from displaying a Bell Trouble condition.

NOTE: The Bell output is current limited with a 2A PTC.

NOTE: Steady, Pulsed and Temporal Three Pattern alarms are supported.

Keybus Terminals - RED, BLK, YEL, GRN

The Keybus is used by the panel to communicate with modules and by modules to communicate with the panel. Each module has four Keybus terminals that must be connected to the four Keybus terminals on the panel.

Programmable Outputs - PGM1 to PGM4

Each PGM output is designed so that when activated by the panel, the terminal will switch to ground. PGM1, PGM3, and PGM4 can each sink up to 50 mA of current. These PGMs can be used to activate LEDs or a small buzzer. Connect the positive side of the LED or buzzer to AUX+, the negative side to the PGM. PGM2 is a high current output (300mA) and operates similarly to PGM1. If more than 300 mA of current is required, a relay must be used. Refer to the diagram. PGM2 can also be configured as an input.

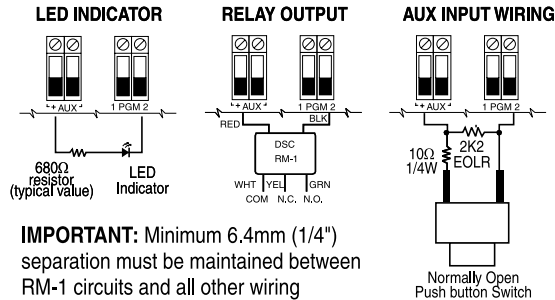

IMPORTANT: Minimum 6.4mm (1/4") separation must be maintained between RM-1 circuits and all other wiring

Zone Input Terminals - Z1 to Z8

Each detection device must be connected to a zone terminal on the system. It is suggested that each zone have one detection device however it is possible to wire multiple detection devices to the same zone. For zone wiring details, see section 2.10 'Zone Wiring'.

Telephone Connection Terminals - TIP,RING,T-1,R-1

If a telephone line is required for central station communication or downloading, connect an RJ-31X jack in the following manner:

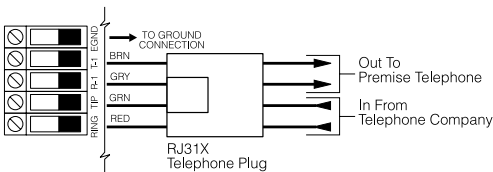

Connect the PC1616/PC1832/PC1864 and modules that use the telephone line(s) in the following order:

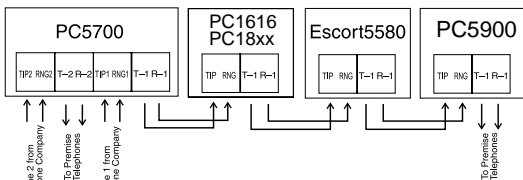

NOTE: Ensure that all plugs and jacks meet the dimension, tolerance and metallic plating requirements of 47 C.F.R. Part 68, SubPart F. For proper operation there must be no other telephone equipment connected between the control panel and the telephone company facilities.

NOTE: Do not connect the alarm panel communicator to telephone lines intended for use with a FAX machine. These lines may incorporate a voice filter which disconnects the line if anything other than FAX signals are detected, resulting in incomplete transmissions.

2.3 Wire Routing for Power & Non-Power Limited

All wiring entry points are designated by the arrows. All circuits are classified UL installation power limited except for the battery leads which are not power limited.

A minimum 1/4" (6.4mm) separation must be maintained at all points between power limited and non-power limited wiring and connections.

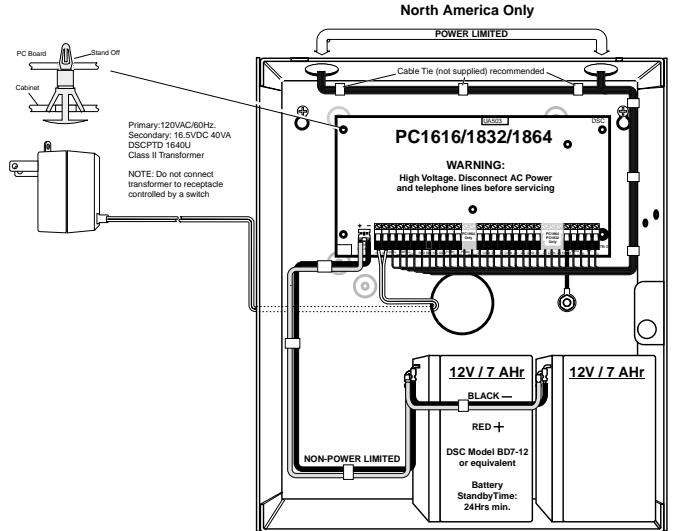

NOTE: Wire entry for power limited wiring must be separated by a different entry access from non-power limited wiring.

2.4 Keybus Operation and Wiring

The Keybus is used by the panel to communicate with all modules connected and by the modules to talk to the panel. The RED and BLK terminals are used to provide power while YEL and GRN are clock and data. The 4 Keybus terminals of the panel must be connected to the 4 Keybus terminals or wires of all modules. The following conditions apply:

- Keybus should be run with minimum 22 gauge quad (0.5mm), two pair twisted preferred
- The modules can be home run to the panel, connected in series or can be T-tapped
- Any module can be connected anywhere along the Keybus, you do not need a separate Keybus wire run for keypads, zone expanders etc.
- No module can be more than 1,000'/305m (in wire length) from the panel

NOTE: Shielded wire should not be used for Keybus wiring.

Example of Keybus Wiring

Module (A) is wired correctly as it is within 1,000'/305m of the panel, in wire distance. Module (B) is wired correctly as it is within 1,000'/305m of the panel, in wire distance. Module (C) is NOT wired correctly as it is further than 1,000'/305m from the panel, in wire distance.

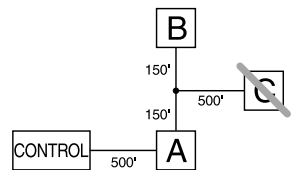

2.5 Current Ratings - Modules & Accessories

In order for the PC1616/PC1832/PC1864 system to operate properly, the power output capabilities of the main control and expansion devices must not be exceeded. Use the data presented below to ensure that no part of the system is overloaded and cannot function properly.

PC1616/PC1832/PC1864 Device Ratings

Device	Description	Max Rating @ 12Vdc
PK5500	LCD Keypad	125mA
PK5501	ICON Keypad	125mA
PK5508	8 Zone LED Keypad	125mA
PK5516	16 Zone LED Keypad	125mA
RFK5500	LCD Keypad with Wireless Module	135mA
RFK5501	ICON Keypad with Wireless Module	135mA
RFK5508	8 Zone LED Keypad With Wireless Module	135mA
RFK5516	16 Zone LED Keypad With Wireless Module	135mA
LCD5500Z	LCD Keypad	85mA
LCD5501Z	ICON Keypad	45mA
LCD5501Z32-433	ICON Keypad with Wireless Module	260mA
LCD5511	ICON Keypad	100mA
LED5511Z	8 Zone LED Keypad	100mA
PC5532Z	32 Zone LED Keypad	85mA
PC5516Z	16 Zone LED Keypad	85mA
PC5508Z	8 Zone LED Keypad	85mA
PC5108	Zone Module	35mA
PC5132	Wireless Module	125mA
PC5200	Output Module	20mA
PC5204	Output Module	20mA
PC5208	Output Module	50mA
PC5320	Multiple Receiver Interface Module	55mA
Escort5580(TC)	Voice Prompting Module	150mA
PC5400	Printer Module	65mA
PC5401	Data Interface Module	35mA
PC5700	Fire Module	150mA
PC5900	Audio Verification Module	50mA
PC5904	Central Station Talk/Listen Module	175mA
PC5921	Intercom Audio Station	20mA
PC5921 EXT	Door Box Audio Station	20mA
PC5921 EXT/R	Door Box Audio Station	35mA

System Output Ratings

Device	Output	Rating (12Vdc)
PC1616 PC1832 PC1864	AUX:	500mA (700 mA for UL/ULC). Subtract the listed rating for each keypad, expansion module and accessory connected to AUX or Keybus.
	BELL:	700 mA. Continuous Rating. 2.0 A. Short Term. Available only with stand-by battery connected.
PC5200	AUX:	1.0 A. Continuous Rating. Subtract for each device connected. 3.0 A. Short Term. Available only with stand-by battery connected.
PC5204	AUX:	1.0 A. Continuous Rating. Subtract for each device connected. 3.0 A. Short Term. Available only with stand-by battery connected.
PC5208	AUX:	250 mA. Subtract for each device connected. Subtract the total load on this terminal from the PC1616/PC1832/PC1864 AUX/Keybus output.
PC5108	VAUX:	100 mA. Subtract for each device connected. Subtract the total load on this terminal from the PC1616/PC1832/PC1864 AUX/Keybus output.

Other Devices

Read the manufacturer's literature carefully to determine the maximum current requirement (during activation or alarm) and use this value for loading calculations. Do not allow connected devices to exceed the system capabilities during any possible operational mode.

2.6 Assigning Zones to Zone Expanders

The main panel contains zones 1 to 8. Additional zone expanders may be added to increase the number of zones on the system. Each zone expander consists of one group of 8 zones. Each module must be set to assign the specific zones to the expander. To do this, set the jumpers located on the expander to the proper settings (see chart below).

NOTE: PC5108 v1.0 and lower modules can only support the first 32 zones on the PC1616/PC1832/PC1864 system. PC5108 v1.0 and lower, PC5700 enrolls as two expander modules.

NOTE: Do not use PC5108 v1.0 and v2.0 simultaneously on the same PC1616/PC1832/PC1864 panel.

NOTE: Before a zone expander will work properly, you must set the jumpers so the panel can determine the correct zone assignment.

The following are jumper settings for different zone assignments for PC5108 v2.0 modules. If you need to enroll PC5108 v1.0 or PC5700 modules, refer to the appropriate module *Installation Sheet* for the correct jumper settings.

Module Jumpers			System Zones Assigned
J1	J2	J3	
ON	ON	ON	Zones disabled
OFF	ON	ON	Zones 09 - 16
ON	OFF	ON	Zones 17 - 24
OFF	OFF	ON	Zones 25 - 32
ON	ON	OFF	Zones 33 - 40
OFF	ON	OFF	Zones 41 - 48
ON	OFF	OFF	Zones 49 - 56
OFF	OFF	OFF	Zones 57 - 64

The following is a diagram of the PC5108 zone expander module and where the jumper switches are located. Refer to the PC5108 Installation Instruction sheet for the module for more information.

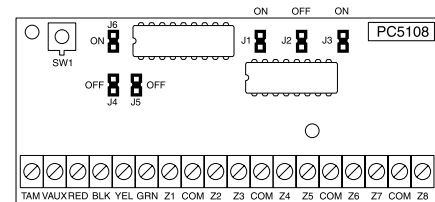

NOTE: Only jumpers J1, J2, and J3 determine the zone assignment for the module.

2.7 Keypad Assignment

There are 8 available slots for keypads. LED and ICON keypads by default are assigned to slot 1. LCD keypads are assigned by default to slot 8. Keypads can each be assigned to a different slot (1 to 8) which offers two advantages. The panel can supervise the keypad connection to indicate a trouble condition if it is removed. Also keypads can be assigned to operate on a specific partition, or to operate as a global keypad.

How to Assign Keypads

1. Enter Installer Programming
2. Press [000] for Keypad Programming
3. Press [0] for Partition and Slot Assignment
4. Enter a two digit number to specify the partition and slot assignment.
 - 1st digit - enter 0 for Global operation, or enter 1-8 for Partitions 1-8
 - 2nd digit - enter 1 to 8 for Slot Assignment
5. Press the [#] key twice to exit programming.
6. Continue this procedure at each keypad until all have been assigned to the correct slot and partition (see section [902]).

NOTE: All keypad assignments must be done at each keypad on the system. When using LCD keypads, one keypad must remain in slot 8 to upload/download LCD information. Do not assign more than one keypad to the same slot.

NOTE: The following keypad versions can only be used on the Partition 1 & Partition 2, and the first 8, 16, or 32 zones: PC5508(Z), PC5516(Z), PC5532(Z) versions v2.0 & lower, LCD5500(Z) versions 3.x and lower. To assign a keypad to a slot and select the partition it will operate in, enter the following:

Function Key Programming

Each of the 5 function keys on each keypad may be programmed for different operations.

1. Enter Installer Programming.
2. Press [000] for Keypad Programming.
3. Enter [1] to [5] to select function key to program.
4. Enter a 2-digit number for function key option - [00] - [32].
5. Continue from step 3 until all function keys are programmed.
6. Press [#] key twice to exit Installer Programming.

Keypad Function Keys		
[00] - Null	[10] - Alarm Memory	[24] - Bypass Group Recall
[01] - Partition 1 Select	[11] - User Programming	[26] - Time & Date Program
[02] - Partition 2 Select	[12] - User Functions	[27] - Partition 3 Select
[03] - Stay Arm	[13] - Command Output 1	[28] - Partition 4 Select
[04] - Away Arm	[14] - Command Output 2	[29] - Partition 5 Select
[05] - No Entry Arm	[16] - Quick Exit	[30] - Partition 6 Select
[06] - Chime On/Off	[17] - Activate Stay/Away	[31] - Partition 7 Select
[07] - System Test	[19] - Command Output 3	[32] - Partition 8 Select
[08] - Bypass Mode	[21] - Command Output 4	
[09] - Trouble Display	[23] - Bypass Recall	

For details on the operation of Function Keys, see section 4.3 'Function Keys'.

2.8 Confirming Module Supervision

By default, all modules are supervised upon installation. Supervision is enabled at all times so that the panel can indicate a trouble if a module is removed from the system. To check which modules are currently connected and supervised:

1. Press [*][8][Installer Code] to enter Installer Programming.
2. Press [903] to display Module Supervision Field.
3. On an LCD keypad, use the arrow keys to scroll through the modules the panel has found on the system.

On LED/ICON keypads, zone lights will be turned on according to what modules the panel has found on the system. Refer to the following chart:

Light	Module/Device	Light	Module/Device
[1]	Keypad 1	[16]	Zones 57 to 64
[2]	Keypad 2	[17]	Wireless Receiver
[3]	Keypad 3	[18]	PC5208
[4]	Keypad 4	[19]	PC5204
[5]	Keypad 5	[20]	PC5400
[6]	Keypad 6	[21]	PC5900
[7]	Keypad 7	[22]	Alternate Communicator
[8]	Keypad 8	[23]	Future Use
[9]	Zones 9 to 16	[24]	Escort5580(TC)
[10]	Zones 17 to 24	[25]	Future Use
[11]	Zones 25 to 32	[26]	PC520X-1
[12]	Zones 33 to 40	[27]	PC520X-2
[13]	Zones 41 to 48	[28]	PC520X-3
[14]	Zones 49 to 56	[29]	PC520X-4
[15]	PC5100		

If a module is connected but does not show as being present, it may be due to any of the following reasons:

- it is not connected to the Keybus
- there is a Keybus wiring problem
- the module is more than 1,000'/305m from the panel
- the module does not have enough power
- the wireless receiver does not have any devices added

NOTE: Module supervision will not display correctly at an LCD5500Z v2.x and lower keypad.

2.9 Removing Modules

If a module is no longer required on the system, the panel must be told to stop supervising the module. To do this:

1. Power down the panel by removing the backup battery and AC.
2. Remove the module from the Keybus.
3. Power up the panel by connecting the backup battery and AC.
4. Press [*][8][Installer Code] to enter Installer Programming.
5. Press [902] to enable supervision. The panel will automatically search for all modules connected to the system for the next 60 seconds. Do not perform any other operations during this 60 second period.
6. Once the search is complete enter section [903] to confirm that the correct modules are supervised on the system.

2.10 Zone Wiring

For a complete description of the operation of all zone types, see section 5.2 'Basic Programming' section [001]-[004].

The panel can be programmed to supervise normally closed, End of Line, or Double End of Line loops. Refer to the following sections to study each type of individually supervised zone wiring.

NOTE: Any zone programmed for Fire or 24 Hour Supervisory must be wired with a single End of Line (EOL) resistor regardless of the type of zone wiring supervision selected for the panel (section [013], options [1] and [2]). See Zone Definitions [001]-[004]. If you change the zone supervision options from DEOL to EOL or from NC to DEOL (section [013], options [1] or [2]), power the system down completely, and then power it back up for correct operation.

NOTE: For UL Listed Installations use SEOL or DEOL only.

NOTE: Use minimum 22 AWG wire, maximum 18 AWG wire.

NOTE: Do not use shielded wire.

NOTE: Wire run resistance shall not exceed 100Ω

Burglary Zone Wiring Chart

Wire Gauge	Maximum Wire length to End of Line Resistor
24	1900 feet / 579 meters
22	3000 feet / 914 meters
20	4900 feet / 1493 meters
19	6200 feet / 1889 meters
18	7800 feet / 2377 meters

Normally Closed (NC) Loops

To enable normally closed loops, program section [013], option [1] to ON.

NOTE: Do not use Normally Closed Loops for UL Listed systems.

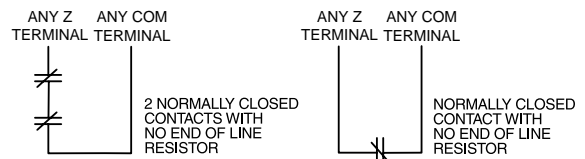

The following chart shows zone status under certain conditions for NC Loops:

Loop Resistance	Loop Status
0Ω (shorted wire, loop shorted)	Secure
Infinite (broken wire, loop open)	Violated

Normally Closed Loops Section [013], Option [1]

Single End Of Line (EOL) Resistors

To enable panel detection of single end-of-line resistors, program section [013], options [1] and [2] to OFF.

NOTE: This option should be selected if either Normally Closed (NC) or Normally Open (NO) detection devices or contacts are being used.

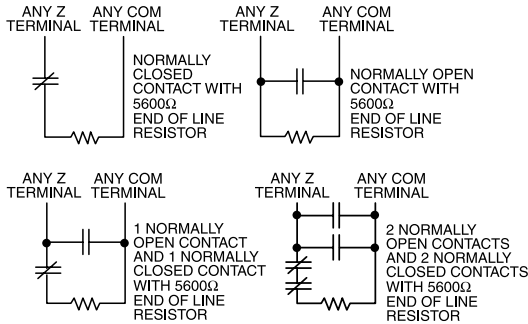

The following chart shows zone status under certain conditions for SEOL:

Loop Resistance	Loop Status
0Ω (shorted wire, loop shorted)	Violated
5600Ω (contact closed)	Secure
Infinite (broken wire, loop open)	Violated

End of Line Resistors Section [013], Option [1]
Single End of Line Resistors Section [013], Option [2]

Double End of Line (DEOL) Resistors

Double End of Line resistors allow the panel to determine if the zone is in alarm, tampered or faulted.

To enable panel detection of double end of line resistors, program section [013], option [1] to OFF and option [2] to ON.

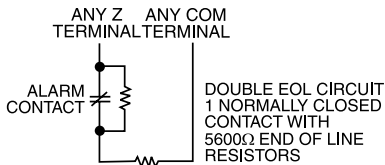

NOTE: If the Double EOL supervision option is enabled, all hardwired zones must be wired for Double EOL resistors, except for Fire and 24 Hour Supervisory zones. Do not use DEOL resistors for Fire zones or 24 Hour Supervisory zones.

NOTE: Do not wire Fire zones to keypad zone terminals if the DEOL supervision option is selected.

NOTE: This option can only be selected if Normally Closed (NC) detection devices or contacts are being used. Only one NC contact can be connected to each zone.

The following chart shows zone status under certain conditions for DEOL:

Loop Resistance	Loop Status
0Ω (shorted wire, loop shorted)	Fault
5600Ω (contact closed)	Secure
Infinite (broken wire, loop open)	Tamper
11200Ω (contact open)	Violated

End-of-Line Resistors Section [013], Option [1]
Double End-of-Line Resistors Section [013], Option [2]

Fire Zone Wiring - 4-wire Smoke Detectors

All zones defined as Fire (see section 5.2 'Basic Programming') must be wired according to the following diagram:

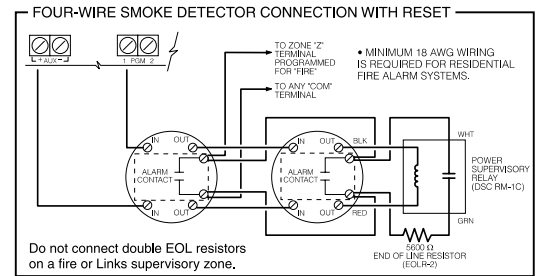

For a complete description of how fire zones operate, see section 5.2 'Basic Programming' sections [001]-[004] option 07 and 08.

NOTE: Smoke detectors must be latching type. To reset smoke detector, enter [*][7][2].

Compatible 4-Wire Smoke Detectors

Model	Model	Model
FAS-410x	FSA-410xLST	FSA-410xRST
FSA-410xT	FSA-410xR	FSA-410xLRST
FSA-410xS	FSA-410xRT	
FSA-410xST	FSA-410xRS	

For model numbers above: x=A (ULC) x=B (UL) x=C (CE)

Fire Zone Wiring - 2-wire Smoke Detectors

If PGM 2 has been programmed for 2-Wire Smoke Detector connection (see section 5.2 'Basic Programming') , the detectors must be wired according to the following diagram:

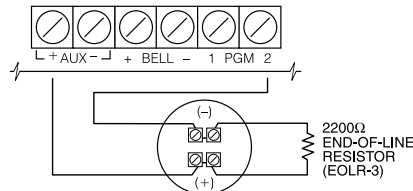

For a complete description of how fire zones operate, see section 5.2 'Basic Programming' section [009] option 04.

NOTE: Do not combine models from different manufacturers on the same circuit. Operation may be impaired.

NOTE: Refer to smoke detector installation sheet when positioning detectors.

Compatible 2-Wire Smoke Detectors

Model	Model	Model
FAS-210B	FSA-210BLST	FSA-210BRST
FSA-210BT	FSA-210BR	FSA-210BLRST
FSA-210BS	FSA-210BRT	
FSA-210BST	FSA-210BRS	

For model numbers above: x=A (ULC) x=B (UL) x=C (CE)

2-Wire Smoke Detector Initiating Circuit

Item	Specification
Style/Class, Supervised, Power Limited	Style B (Class B)
Compatibility Identifier	PC18-1
DC Output Voltage	9.8-13.8 VDC
Detector Load	2mA (MAX)
Single End of Line Resistor (SEOL)	2200Ω
Loop Resistance	24Ω (MAX)
Standby Impedance	1020Ω (NOM)
Alarm Impedance	570Ω (MAX)
Alarm Current	89mA (MAX)

Keyswitch Zone Wiring

Zones may be programmed to be used as keyswitch arming zones and must be wired according to the following diagram:

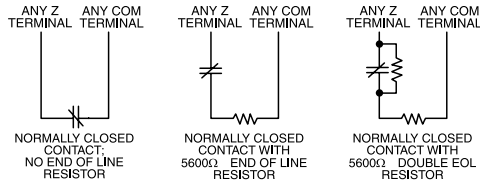

For a complete description of how keyswitch zones operate, see section 5.2 'Basic Programming' sections [001]-[004] option 22 and 23.

2.11 Keypad Zone/PGM

Keypads with zone inputs can be connected to devices such as door contacts. This saves you from running wires back to the control panel for every device.

To install the keypad, open the keypad plastic. Refer to the Installation Sheet that came with the keypad for instructions on how to open the keypad. Locate the terminals on the keypad circuit board. Connect the four Keybus wires from the control panel: the red wire to R, the black to B, the yellow to Y and the green to G.

LCD55XXZ

To connect the zone input on an LCD55XXZ keypad, run one wire to the Z terminal and the other to B. For powered devices, use red and black to supply power to the device. Run the red wire to the R (positive) terminal and the black wire to the B (negative) terminal.

When using end of line supervision, connect the zone according to one of the configurations outlined in section 2.10 'Zone Wiring' on page 8.

NOTE: LCD55XXZ zones do not support DEOL resistors.

LCD55XXZ

Keypad circuit board



Keypads without zone support do not have this "Z" terminal

"Z" version keypads are also indicated by a label located on the back of the keypad plastic. The label reads: "Z" version.

PK55XX/RFK55XX

PK55XX/RFK55XX keypad comes with a Z/P terminal. This terminal can be configured as an input (zone) or output (PGM).

To connect the zone input on a PK55XX/RFK55XX keypad, run one wire to the Z/P terminal and the other to B. For powered devices, use red and black to supply power to the device. Run the red wire to the R (positive) terminal and the black wire to the B (negative) terminal. The PK55XX/RFK55XX keypad zone supports Normally Closed Loops, Single End of Line and Double End of Line.

To connect the PGM output on a PK55XX/RFK55XX keypad, run one wire to the Z/P terminal and the other to R.

PK55XX/RFK55XX

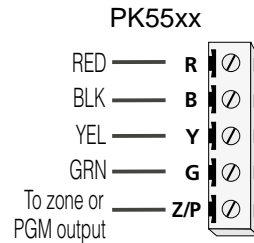

NOTE: End of line resistors must be placed on the device end of the loop, not at the keypad.

Assigning Keypad Zones

When using keypad zone inputs, each input used must be assigned a zone number in Installer's Programming.

First, ensure that you have enrolled all installed keypads into the desired slots (see section 2.7 'Keypad Assignment') to assign the keypad to a slot.

Next, enter programming section [020] to assign the zones. There are eight programming locations in this section, one for each keypad slot. Enter a 2-digit zone number for each of the keypad zones. This number must be entered in the location corresponding to the keypad to which each zone is connected.

NOTE: If a keypad zone input is assigned to zone number 1 to 8, the corresponding zone cannot be used on the main control panel.

Once the keypad zones are assigned, you must also program zone definitions and zone attributes (see Section 5.2 Basic Programming PWS Sect 3 [001]-[004] and Section 5.3 Advanced System Programming PWS Sect 4 [101]-[164]).

2.12 Zone Activity Log

This feature stores the date stamp of each zone activation event. It stores the last day, month and year a zone was violated. This data can be retrieved during the installer's DLS access.

NOTE: If the panel is powered down, this data will be lost.

Section 3: How to Program

The following section of the manual describes how to enter Installer Programming and how to program the various sections.

NOTE: It is extremely important that you read the following section of the manual to completely understand how to program the panel.

3.1 How to Enter Installer Programming

Installer Programming is used to program all communicator and panel options. The **Installer Code** is [5555] at default, but should be changed to prevent unauthorized access to programming.

NOTE: Once the Installer's Mode is exited, the system will reset. This will take 15 seconds. Do not attempt to perform any system function during this reset period. In addition, all outputs will return to their normal, deactivated state (or activated if inverted).

NOTE:  EN installations will restrict access to the Master code section [007] in installers programming. The Installer may view the Master Code via DLS.

LED Keypad

Step 1: From any keypad enter [*][8][Installer Code].

- The 'Program' light will flash to indicate you are in programming
- The 'Armed' light will turn on to indicate the panel is waiting for the 3 digit Section number to program

Step 2: Enter the 3 digit Section number you want to program.

- The Armed light will turn off
- The Ready light will turn on to indicate the panel is ready for the information for the selected Section

NOTE: If the 3 digit section number entered is not valid or the module that pertains to the Section is not present, the keypad will sound a 2 second error tone.

LCD Keypad

Step 1: From any keypad enter [*][8][Installer Code]. The Keypad will display 'Enter Section' followed by three dashes.

Step 2: Enter the 3 digit Section number you want to program. The keypad will now display information for the section entered.

.....
 Installer Code Section [006]

3.2 Programming Decimal Data

When the Ready light is ON the panel is waiting for the information to be programmed for the selected Section. Enter the information written in the boxes for the Section found in the Programming Worksheets.

If a digit is entered for each program box in a Section the panel will automatically exit from the Section. It will turn OFF the Ready light and turn the Armed light back ON.

You can also press the [#] key to exit a Section before entering data for every box. This is handy if you only need to change the first few program boxes. All other locations in the Section will remain unchanged. If the [#] key is pressed the panel will turn OFF the Ready light, turn ON the Armed light and exit you from the Section.

3.3 Programming Hexadecimal Data

On occasion, hexadecimal (HEX) digits may be required. To program a HEX digit press the [*] key. The panel will enter HEX programming and Ready light will begin to flash.

The following table indicates which number should be pressed to enter the corresponding HEX digit:

1 = A 2 = B 3 = C 4 = D 5 = E 6 = F

After the correct HEX digit is entered the Ready light will continue to flash. If another HEX digit is required press the corresponding number. If a decimal digit is required press the [*] key again. The Ready light will turn on solid and the panel will return to regular decimal programming.

NOTE: It is important to watch the Ready light. If the light is flashing any number you enter will be programmed as the HEX equivalent.

Example: To enter 'C1' for a closing by user 1, you would enter [*] [3] [*], [1]

[*] to enter Hexadecimal mode (Ready light flashes)

[3] to enter C

[*] to return to decimal mode (Ready light is solid)

[1] to enter digit 1

If you enter information into a section and make a mistake, press the [#] key to exit the section. Select that section again and re-enter the information correctly.

If you are using a pulse communications format, a decimal zero [0] does not transmit. Programming a zero [0] tells the panel not to send any pulses for that digit. Decimal zero [0] is a filler digit. To make a zero [0] transmit, it must be programmed as a Hexadecimal 'A'.

Example: for the three digit account number '403', you would enter [4], [*] [1] [*] [3], [0].

[4] to enter the digit 4

[*] to enter Hexadecimal mode (Ready light flashes)

[1] to enter A

[*] to return to decimal mode (Ready light is solid)

[3] to enter the digit 3

[0] to enter the digit 0 as a filler digit.

3.4 Programming Toggle Options

Some Sections contain several toggle options. The panel will use zone lights 1 through 8 to indicate if the different options are enabled or disabled. Refer to the Programming Worksheets to determine what each option represents and whether the light should be ON or OFF for your application. Press the number corresponding to the option to toggle the light ON or OFF.

Once all the toggle options have been selected correctly press the [#] key to exit the Section and save the changes. The panel will turn off the Ready light and turn on the Armed light.

3.5 Viewing Programming

LED and ICON Keypads

Any programming section can be viewed from an LED or ICON keypad. When a programming section is entered, the keypad will immediately display the first digit of information programmed in that section.

The keypad displays the information using a binary format, according to the following chart:

See Hex data entry instructions

Value	0	1	2	3	4	5	6	7	8	9	A	B	C	D	E	F
Zone 1	<input type="checkbox"/>	<input checked="" type="checkbox"/>	<input type="checkbox"/>	<input checked="" type="checkbox"/>	<input type="checkbox"/>	<input checked="" type="checkbox"/>	<input type="checkbox"/>	<input checked="" type="checkbox"/>	<input type="checkbox"/>	<input checked="" type="checkbox"/>	<input type="checkbox"/>	<input checked="" type="checkbox"/>	<input type="checkbox"/>	<input checked="" type="checkbox"/>	<input type="checkbox"/>	<input checked="" type="checkbox"/>
Zone 2	<input type="checkbox"/>	<input type="checkbox"/>	<input checked="" type="checkbox"/>	<input type="checkbox"/>	<input type="checkbox"/>	<input type="checkbox"/>	<input type="checkbox"/>	<input type="checkbox"/>	<input type="checkbox"/>	<input type="checkbox"/>	<input type="checkbox"/>	<input type="checkbox"/>	<input type="checkbox"/>	<input type="checkbox"/>	<input type="checkbox"/>	<input type="checkbox"/>
Zone 3	<input type="checkbox"/>	<input type="checkbox"/>	<input type="checkbox"/>	<input checked="" type="checkbox"/>	<input checked="" type="checkbox"/>	<input checked="" type="checkbox"/>	<input checked="" type="checkbox"/>	<input type="checkbox"/>	<input type="checkbox"/>	<input type="checkbox"/>	<input type="checkbox"/>	<input type="checkbox"/>	<input type="checkbox"/>	<input type="checkbox"/>	<input type="checkbox"/>	<input type="checkbox"/>
Zone 4	<input type="checkbox"/>	<input type="checkbox"/>	<input type="checkbox"/>	<input type="checkbox"/>	<input type="checkbox"/>	<input type="checkbox"/>	<input type="checkbox"/>	<input type="checkbox"/>	<input checked="" type="checkbox"/>	<input checked="" type="checkbox"/>	<input checked="" type="checkbox"/>	<input checked="" type="checkbox"/>	<input checked="" type="checkbox"/>	<input checked="" type="checkbox"/>	<input checked="" type="checkbox"/>	<input checked="" type="checkbox"/>

Zone Light OFF
 Zone Light ON

Press any of the Emergency Keys (Fire, Auxiliary or Panic) to advance to the next digit.

When all the digits in a section have been viewed, the panel will exit the section: the Ready Light will turn OFF, and the Armed light will turn ON, waiting for the next three-digit programming section number to be entered.

Press the [#] key to exit the section.

LCD Keypad

When a programming section is entered, the keypad will immediately display all the information programmed in that section. Use the arrow keys (< >) to scroll through the data being displayed. To exit the section, scroll past the end of the data displayed, or press the [#] key.

Section 4: Keypad Commands

Use any system keypad to enter commands, or to program the PC1616/PC1832/PC1864 security system. The LED keypad uses function and zone indicator lights to represent alarm functions and status. The LCD keypad provides a written description on the liquid crystal display and uses function indicator lights to communicate alarm status to the user. The *PC1616/PC1832/PC1864 User's Guide* provides basic directions for arming and disarming the system, bypassing zones and performing user functions from the keypads. The following sections provide additional details on these functions.

4.1 Arming and Disarming

Arming

The system cannot be armed unless the 'Ready' light is on. If the 'Ready' light is not on, ensure all protected doors and windows are secure and stop movement in areas covered by motion detectors.

When the 'Ready' light is on, enter a valid access code. As each digit is pressed the keypad will beep. If an incorrect code is entered, the keypad will emit a steady 2 second beep to indicate that the code was not correct. If the code is correct but the 'Ready' light was not on, the panel will beep six times rapidly followed by a long two second beep to indicate the system was not ready.

When the correct code is entered and the system is ready, the panel beeps six times rapidly, and the 'Armed' light turns on. The panel begins counting down the exit delay. If the **Audible Exit Delay** option is enabled, the keypad will beep every second until the exit delay expires. The keypad will beep rapidly for the last 10 seconds of exit delay to warn the user the system is about to arm. Exit the premises through the designated entry/exit door before the exit delay expires.

Users can restart the exit delay while it is counting down by pressing the Away key. The system will not log the user who re-started the exit delay, unless the **Quick Arming Disabled/Function Keys Require Code** option is turned on (section [015], option [4]).

NOTE: *If the system has been Stay armed, or armed with no entry delay ([*][9]), pressing the Away key will not restart an exit delay.*

NOTE: *If the system is armed while an alarm is in memory, the mode cannot be changed.*

Other methods of arming are available (See section "[*][0] Quick Arm", "[*][9] Arming without Entry Delay", and section 4.4 "Function Keys").

NOTE: *The PC1616/PC1832/PC1864 has a built-in feature called Audible Exit Fault (see Section [013], option 6 for more information).*

NOTE: *For SKAFOR Installations, the keypad will sound a steady tone for 5 seconds when the system is armed while a trouble is present. Exit delay should continue normally (silent or audible) after 5 seconds.*

Stay and Away Arming

When a user arms the system with an access code, if any zones on the system have been programmed as Stay/Away, the panel will immediately turn on the 'Bypass' light. The panel will then monitor all zones programmed as Delay 1 and Delay 2. If no delay type zone is violated by the end of the exit delay (e.g. nobody leaves through the entry/exit door), the panel will bypass all Stay/Away type zones. The panel is now "Stay" armed. The 'Bypass' light will remain on to inform the home owner that the interior protection is bypassed. This is a convenience for users that want to arm the panel while at home. Using this method, users do not have to bypass the interior zones manually.

Users can add Stay/Away zones back into the system at any time by entering [*][1] (see section '[*][1] Zone Bypassing'), or by using the Away button.

If a delay zone is violated during the exit delay (e.g. somebody leaves through the designated entry/exit door), all zones will be active after the exit delay expires. The panel is now "Away" armed. The Bypass light on the keypad will be off. Other methods of Stay and Away arming are available (see section 4.3 'Function Keys').

NOTE: *The buzzer will not sound during "Stay Arming".*

Stay Arming

When a user arms the system by pressing the Stay button, if any zones on the system have been programmed as Stay/Away, the panel will immediately turn on the 'Bypass' light. After the exit delay the panel will bypass all Stay/Away type zones. The panel is now "Stay" armed. The 'Bypass' light will remain on to inform the home owner that the interior protection is bypassed. This is a convenience for users that want to arm the panel while at home. Using this method, users do not have to bypass the interior zones manually.

Users can add Stay/Away zones back into the system at any time by entering [*][1] (see section '[*][1] Zone Bypassing'), or by using the Away button.

Away Arming

When a user arms the system by pressing the Away button, the panel will begin the exit delay. All zones will be active after the exit delay expires. The panel is now "Away" armed. The Bypass light on the keypad will be off.

Using the Away Button While Stay Armed

If a partition is armed in Stay mode and a user wishes to leave the premises without having to disarm and re-arm the system, they may press the Away button. The system will begin counting the standard exit delay, allowing the user to leave without actually disarming. The panel will log "Armed in Away Mode" upon completion of the Exit Delay. This feature is useful for users with Wireless Keys with Stay/Away buttons, and who wish to have their panel armed at all times.

Using the Stay Button While Away Armed

Pressing the Stay key while a partition is Away armed will begin the Exit Delay again. The panel will log "Armed in Stay Mode". This feature is useful for users with Wireless Keys with Stay/Away buttons, and who wish to have their panel armed at all times.

NOTE: *If Function Keys require the entering of an access code, a valid access code must be entered to toggle between arming modes. The access code used to perform this function will be logged with "User Log User XX". Swinger Shutdown will be reset if the Away button is pressed while the system is armed.*

Inhibit Arming

All troubles on the panel will prevent the system from arming and it will force the Ready LED to shut off. Press [9] in the Trouble Menu to clear Troubles.

NOTE: *With this feature disabled, Bell Trouble will still inhibit arming.*

Disarming

To disarm the panel, enter the premises through the designated entry/exit door. The keypad will emit a steady beep to warn that you must disarm the system. During the last 10 seconds of entry delay the panel will pulse the keypad beeper on and off rapidly to warn the entry delay is about to expire.

Enter a valid Access Code at the keypad. If an error is made, re-enter the code correctly. When a correct code is entered the keypad will turn off the 'Armed' light and stop the keypad buzzer.

If an alarm occurred while the panel was armed the 'Memory' light and the zones which caused the alarm will be flashing. Press the [#] key to return the keypad to the Ready state.

Event Buffer (Event Log)

The panel will store the last 500 events that have occurred on the system. Each event will contain the time, date, partition and the event itself along with the zone number, access code number or any other information pertaining to the event.

If the **Event Buffer Follows Swinger Shutdown** feature is enabled (Section [013], option 7) the event buffer will not store events after the swinger shutdown level has been reached. This will prevent the panel from overwriting the entire buffer if a problem exists. The event buffer can be viewed three different ways. It can be viewed through an LCD keypad, printed on-site using the PC5400 printer module or it can be uploaded through the DLS software.

Viewing the Event Buffer

The following is the procedure for viewing the event buffer through the LCD keypad:

- Step 1 - Enter [*] [6] [Master/Access Code]
- Step 2 - Select 'View Event Buffer'

The keypad will display the Event Number, Partition, Time and Date of the event in question. Use the [*] key to toggle between this information and the event itself. Use the arrow keys (< >) to scroll through the events in the buffer. When you have finished viewing the event buffer press the [#] key to exit.

NOTE: When viewing events for partitions 3 to 8 on an LCD5500 v2.x and lower keypad, they will show as being logged in the "System Area".

4.2 [*] Commands

[*][1] Zone Bypassing

Users can bypass individual zones using the [*][1] keypad command. This command can be used if users want to have access to an area while the Partition is armed, or to bypass a defective zone (bad contact, damaged wiring) until service can be provided.

A bypassed zone will not cause an alarm.

When the partition is disarmed, all zones that were bypassed using [*][1] will be unbypassed, except for 24-hr zones.

If the **Code Required for Bypass** option is enabled, an access code will be required to enter the Bypass mode. Only access codes with the Bypass attribute enabled will be able to bypass zones (see section '[*][5] Programming Access Codes').

Bypassing Zones with an LCD keypad:

Start with disarming the system.

1. Press [*] to enter the function menu. The keypad will display "Press [*] for < > Zone Bypass".
2. Press [1] or [*], then your [access code] (if required). The keypad will display "Zone Search < > Zone Name".
3. Enter the two-digit number of the zone(s) to be bypassed (01-64). You can also use the < > keys to find the zone to be bypassed, and then press [*] to select the zone.

The keypad will display "Zone Search < > "Zone Name?". "B" will appear on the display to show that the zone is bypassed. If a zone is open (e.g., door with door contact is open), the keypad will display "Zone Search < > "Zone Name" O". If you bypass the open zone, a "B" will replace the "O".

4. To unbypass a zone, enter the two-digit number of the zone(s) to be bypassed (01-64). You can also use the < > keys to find the zone, and then press [*] to select the zone. The "B" will disappear from the display to show that the zone is no longer bypassed.

5. To exit bypassing mode and return to the Ready state, press [#].

Bypassing Zones with a LED/ICON keypad:

Start with disarming the system

1. Press [*][1], then your [access code] (if required).
2. Enter the two-digit number of the zone(s) to be bypassed (01-64). On LED keypads, the zone light will turn on to indicate that the zone is bypassed.
3. To unbypass a zone, enter the two-digit number of the zone (01-64). On LED keypads, the zone light will turn off to indicate that the zone is not bypassed.
4. To exit bypassing mode and return to the Ready state, press [#].

Other Bypass Features:

The following features are also available on the [*][1] zone bypassing menu:

- **Bypass Recall:** Press [99] while in the [*][1] menu to recall the last set of bypassed zones.
- **Clear Bypasses:** Press [00] while in the [*][1] menu to clear all bypassed zones.
- **Bypass Groups:** Users can program a group of zones to be bypassed (bypass group). Each partition can have a different bypass group. To program a bypass group, in the [*][1] menu, select the zones to be bypassed. Press [95] to save the group. To recall the group, press [*][1] followed by [91].

If the Code Required for Bypass option is enabled, the Master code or Supervisor codes must be used to access this feature.

NOTE: The zone attribute for zone bypassing must be enabled (see Section [101]-[164] Zone Attributes, Option 4).

NOTE: Hold-up zones should not be part of Bypass Groups.

NOTE: A zone that is manually bypassed via [*][1] will bypass the alarm, fault, and tamper conditions when DEOL is used.

NOTE: If a 24-hour zone is bypassed, ensure that the zone is restored or disabled before removing the bypass.

.....
Code required for bypass Section [015], Option [5]
.....

[*][2] Trouble Display

The panel constantly monitors itself for several different trouble conditions. If a trouble condition is present, the Trouble light will be ON and the keypad will beep twice every 10 seconds. The trouble beep can be silenced by pressing any key on any keypad. If **Bell Squawk on Trouble** is enabled (section [014], option[5]), the bell will squawk every 10 seconds when a trouble condition is present.

NOTE: If there is an AC trouble, the keypad will not beep for a General System Trouble.

To view trouble conditions from an LED or ICON keypad:

1. Press [*][2] to enter the trouble menu.
2. The keypad will flash the Trouble light. The zone indicator lights corresponding to the present trouble conditions will be ON.

Light	Trouble															
Light [1]	<p>Service Required: Press [1] to determine the specific trouble. Lights 1 - 8 will light up to indicate the trouble:</p> <ul style="list-style-type: none"> Light [1] Low Battery: Main panel backup battery charge is low (below 11.5 volts under load). Trouble is restored when the battery charges over 12.5 volts. Light [2] Bell Circuit Trouble: The bell circuit is open (see section 2.2 'Terminal Descriptions'). Light [3] General System Trouble: One or more of the following troubles has occurred: the PC5204 Power Supply module has an AUX failure, PC5204 Output #1 Trouble, Home Automation Trouble on the Escort5580(TC), or a printer connected to the PC5400 Printer module has a fault and is off-line, or T-Link Troubles. Users can view specific conditions in the Event Buffer. Light [4] General System Tamper: Tamper has been detected from a module. Light [5] General System Supervisory: The panel has lost communication with a module connected to the Keybus (See section 2.8 'Confirming Module Supervision' on page 8). The event buffer will log the event. Light [6] RF Jam: Please refer to the PC5132 <i>Installation Manual</i> for more information. Light [7] PC5204 Low Battery: The PC5204 module has a low backup battery. Light [8] PC5204 AC Failure: The PC5204 module has lost AC power. <p>NOTE: If you remove and then restore power to the main panel in order to service any PC5204 module, or any module being powered by a PC5204, you must also remove and then restore power to the PC5204 and any connected modules. This ensures that any troubles present on the module are correctly logged and/or announced.</p>															
Light [2]	<p>AC Failure: AC power is no longer being supplied to the control panel. The Trouble light will flash if an AC Failure is present, if the Trouble Light Flashes if AC Fails option is programmed (section [016], option [2]). This trouble will not be displayed if the AC Trouble Displayed option is disabled (section [016], option [1]).</p>															
Light [3]	<p>Telephone Line Monitoring Trouble (TLM): There is a problem with the telephone line. If the system has an Alternate Communicator, this trouble can be reported to the central station by programming reporting codes in sections [345] and [346].</p>															
Light [4]	<p>Failure to Communicate (FTC): The communicator failed to communicate with any of the programmed telephone numbers (see section 5.6 'Communicator Programming').</p>															
Light [5]	<p>Zone Fault (including Fire Zone): A zone on the system is experiencing trouble, meaning that a zone could not provide an alarm to the panel if required to do so (e.g. a fire zone is open, or there is a short on a DEOL zone, or a supervisory fault on a wireless zone). When a zone fault occurs, the keypad(s) on the system will start to beep. Press [5] while in Trouble mode to view the affected zones.</p> <p>NOTE: A Fire zone trouble will be generated and displayed in the armed state.</p>															
Light [6]	<p>Zone Tamper: A zone configured for Double End Of Line resistor supervision has a tamper condition, or the tamper switch is open on a wireless device. When a tamper condition occurs, the keypad(s) will start to beep (if the system is armed, an alarm will occur). Press [6] while in the Trouble mode to view the affected zones. If a zone is tampered or faulted, it must be fully restored to clear the trouble.</p>															
Light [7]	<p>Device Low Battery/RF Delinquency: A wireless device has a low battery condition. Press [7] one, two, or three times to view which devices are experiencing battery failure. Press the [7] key an additional time to view zones in RF Delinquency trouble. An LED keypad will indicate battery failure using zone lights. The following will occur:</p> <table border="0"> <tr> <td></td> <td>Keypad beeps:</td> <td>Keypad displays:</td> </tr> <tr> <td>Press [7]</td> <td>1</td> <td>Zones with low batteries (LED keypad - zone lights 1 to 32)</td> </tr> <tr> <td>Press [7] again</td> <td>2</td> <td>Handheld keypads with low batteries (LED keypad - zone lights 1 to 4)</td> </tr> <tr> <td>Press [7] again</td> <td>3</td> <td>Wireless keys with low batteries (LED keypad - zone lights 1 to 16)</td> </tr> <tr> <td>Press [7] again</td> <td>4</td> <td>Zones in RF Delinquency trouble (LED keypad - zone lights 1 to 32)</td> </tr> </table>		Keypad beeps:	Keypad displays:	Press [7]	1	Zones with low batteries (LED keypad - zone lights 1 to 32)	Press [7] again	2	Handheld keypads with low batteries (LED keypad - zone lights 1 to 4)	Press [7] again	3	Wireless keys with low batteries (LED keypad - zone lights 1 to 16)	Press [7] again	4	Zones in RF Delinquency trouble (LED keypad - zone lights 1 to 32)
	Keypad beeps:	Keypad displays:														
Press [7]	1	Zones with low batteries (LED keypad - zone lights 1 to 32)														
Press [7] again	2	Handheld keypads with low batteries (LED keypad - zone lights 1 to 4)														
Press [7] again	3	Wireless keys with low batteries (LED keypad - zone lights 1 to 16)														
Press [7] again	4	Zones in RF Delinquency trouble (LED keypad - zone lights 1 to 32)														
Light [8]	<p>Loss of System Time: When the panel is powered up, the internal clock needs to be set to the correct time. This trouble is cleared when an attempt is made to reset the clock. This is set in [*][6] [Master Code] Programming on page 16.</p>															

Trouble Menu Acknowledgement

Press [9] for **Trouble Menu Acknowledgement**. This will acknowledge and override existing troubles so the system can be armed. An override event will also be generated and logged, identifying the user. To override open zones, use the Zone Bypass feature [*][1].

If a zone fault/tamper occurs, press [*][2][9] to override the trouble, then [*][1] to override the open zone.

NOTE: When using the Trouble Menu Acknowledgement feature, Section [022] Option 3 has to be enabled.

When using an LCD keypad, the trouble conditions will be listed on the display. Users can scroll through the list of present trouble conditions using the arrow (< >) keys.

NOTE: Troubles can be viewed while armed using the LCD keypad, provided the keypad is version 2.0 or later. Older keypads will incorrectly display "Fire Trouble". If using older LCD keypads, program section [013], option [3] as OFF to ensure that troubles are displayed correctly.

NOTE: If a trouble is present when the system is armed, the trouble LED will remain on during Exit Delay but will turn off once the exit delay timer expires.

[*][3] Alarm Memory

The 'Memory' light will be on if any alarm occurred during the last armed period or if an alarm occurred while the panel was disarmed (24 hour zones). Press [*][3] to view zones in alarm memory. To clear the memory, arm and disarm the system.

[*][4] Door Chime On/Off

If enabled the keypad will beep 6 times rapidly when a zone is tripped and restored. The panel will only do this for zones with the Door Chime attribute enabled and if the door chime feature is enabled. The door chime attribute for each zone is programmed in sections [101] to [164].

[*][5] Programming Access Codes

Access codes are required in order to perform various functions on the system such as arm, disarm, activate command outputs etc.

Program New Access Code

To program an access code enter [*][5][Master Code] followed by a two digit number corresponding to the access code you want to program, then enter a new access code. The available access codes are as follows:

General Access Codes - Access Codes [01] to [32]

Each access code can be used to arm and disarm the assigned partitions. Additional access code attributes are also programmable to determine what abilities the code will have. You can program partition assignments and access code attributes by following the instructions in this section.

Supervisor Codes - Access Codes [41] and [42]

Supervisor Codes can program additional access codes. By default, Supervisor codes have the same partition and attribute programming as the Master code. You can change the partition and attribute programming for these codes by following the instructions in this section.

System Master Code - Access Code [40]

By default the System Master Code is enabled to operate on all partitions and can perform any keypad function. This code can be used to program all access codes, including the Supervisor Codes and Duress Codes.

If the **Master Code Not Changeable** option is enabled the System Master Code can only be changed using Installer Programming.

NOTE:  For EN installations the installer will not have access to Master Code Programming. In order to return the master code to the factory default setting enter the Special Installer Function [989][Installer's Code][989] (Master Code Factory Default Programming). This will allow the installer to default the Master Code.

Duress Codes - Access Codes [33] and [34]

Duress codes are standard user codes that will transmit the Duress Reporting Code whenever the code is entered to perform any function on the system.

NOTE: Duress codes are not valid when entering [*][5], [*][6] or [*][8] sections.

NOTE: Duress codes cannot be programmed as a duplicate of another code or as a "Code + 1".

Maintenance Code

The maintenance code can only be used to arm and disarm the system. It cannot be used to bypass zones, to access the Escort5580(TC), or to cancel or postpone automatic arming. The code can only be programmed in Installer's Programming. The Maintenance code cannot bypass zones, use [*][9] to arm the system, cancel auto-arming, or perform [*][7] command functions. There will be no arm/disarm bell squawks when the Maintenance code is used.

Guard Code

The Guard Code can arm the panel at any time. However, the Guard code can only disarm the system after an alarm, tamper, fault or trouble condition has occurred. It can also be used to bypass zones and activate Command Outputs. The Guard Code may be programmed in Section [008]. Arming and disarming using the Guard Code will log as "Closing (Opening) by Maintenance Code". If a Command Output that requires a code is activated with the Guard Code, no User Log will be made. When zones are bypassed with the Guard Code, the panel will log "[*][1] Access by User".

NOTE: The Latching Trouble feature should be used with the Guard Code feature in order to disarm with Trouble Present.

Partition Assignments and Access Code Attributes

You can enable or disable each access code to work on each partition. Additional access code attributes are also programmable. Attributes determine what abilities the code will have.

By default, each code has the attributes of the code used to program it. For example, if you use the Master code to program other access codes, the new codes will have the same attributes as the Master code. You can change the partition and attribute programming by following the instructions described below.

You cannot change Master code partition or attribute programming. The Master code has all partitions and all attributes turned on, except for the Bell Squawk on Arming/Disarming and One Time Use Code Attributes.

Access Code Partition Assignment

To program which partition(s) each code will work on:

1. Enter [*][5][Master Code][8] for partition programming.
2. Enter the 2-digit number of the access code you want to edit.

3. Enter the partition number (1-8) to toggle it on or off.

NOTE: Partition programming is NOT supported by the following keypads: PC5508(Z), PC5516(Z), PC5532(Z) versions v2.00 and lower; LCD5500(Z) version 2.x and lower; LCD5501Z version 1.x and lower.

Access Code Attributes

To program each attribute:

1. Enter [*][5][Master Code][9] for attribute programming.
2. Enter the 2-digit number of the access code you want to edit.
3. Enter the attribute number to toggle it on or off.

Programmable Attributes

Attribute	Description
[1]	For Future Use
[2]	For Future Use
[3]	Zone Bypass enabled. This attribute allows the user to bypass zones.
[4]	Escort5580(TC) Remote Access This attribute allows the user to access the security system via the Escort, if installed.
[5]	For Future Use
[6]	For Future Use
[7]	Bell Squawk on Arming/Disarming. When this attribute is ON, the bell will squawk when the access code is entered to arm or disarm the system. For example, you can use the arm/disarm bell squawk attribute to have wireless key access codes squawk the bell, while other codes are silent. To do this, enable attribute [7] on all access codes associated with wireless keys.
[8]	One Time Use Code. This attribute will only affect Access Codes 01-16. If the panel is disarmed with this code, the code will be erased at the end of the Exit Delay the next time that the panel is armed, regardless of which code is used to arm the system. The code will also be erased at the end of the Exit Delay when used to arm the panel. If the panel is disarmed during the Exit Delay when armed with a One Time Use Code, it will still be valid after the next time the panel is armed (unless the same One Time Code is used to arm the second time).

NOTE: If you enable the Bell Squawk on Arming/Disarming option (section [014], option [1]), the bell will sound arm/disarm bell squawks for all access codes, regardless of the programming for attribute [7] (see Section 5.3 Basic Programming PWS Sect 3 [001]-[004] (see Section 5.4 'Advanced Programming')).

Installer's Programming - Codes and Options

There are three codes which can be programmed by the installer in Installer's Programming: the **Installer's code**, **Master Code** and a **Maintenance Code/Guard Code**. All other access codes can be programmed through the [*][5] command, as described previously in this section.

The master code can also be programmed by the user as access code (40). However, if the **Master Code Not Changeable** option is enabled, the master code can only be accessed in Installer's Programming.

General access codes can arm and disarm the system. When the **Code Required for Bypassing** option is enabled, users will need to enter a valid access code in order to bypass zones. Individual access codes can have the Zone Bypassing attribute disabled under Access Code Attribute programming, as described previously in this section.

If the **6-Digit User Access Codes** option is enabled, all the access codes are programmed with six digits instead of four. The Installer's Code will become [555555]. If 4-digit codes are already programmed and this option is selected, the first four digits of the programmed codes will remain as programmed and the last two digits will be [00].

If the **4-Digit User Access Codes** is selected, all codes will be 4-Digits in length, with the exception of the Panel ID code and the Downloading Access Code. If 6-digit codes were

previously programmed and this option is enabled, the first four digits of each code will be used.

Installer's Code	Section [006]
Maintenance Code	Section [008]
Master Code Not Changeable	Section [015]: [6]
Code Required for Bypassing	Section [015]: [5]
6-digit User Access Codes	Section [701]: [5]

NOTE: Only one keypad at a time can use [*][5] programming.

[*][6] User Functions

NOTE: Only one keypad at a time can use [*][6] programming.

To program user functions, perform the following:

1. Press [*][6][Master Code]. The keypad will flash the 'Program' light.
2. Press the number [1] to [8] for the item to be programmed.

[1] - Time and Date

Enter 4 digits for 24 Hour System Time (HH-MM). Valid entries are 00-23 for the hour and 00-59 for minutes. Enter 6 digits for the Month, Day and Year (MM-DD-YY)

[2] - Auto-arm Enable/Disable

Pressing [2] while in the User Function menu will enable auto-arm (3 beeps) or disable auto-arm (one long beep). The auto-arm feature needs to be enabled on each partition individually. With this feature enabled, the panel will automatically arm in the Away mode (Stay Away zones active) at the scheduled time. The auto-arm time is programmed with the [*][6][Master Code][3] command.

[3] - Auto-arm Schedule

Enter [3] to change the Auto-arm time for each day of the week. Scroll to the day of the week you want to change, or enter the number of the day (1-7 for Sunday to Saturday). On an LED keypad, zone lights 1-7 will represent Sunday to Saturday.

When you have selected a day, enter the Auto-arm time in 24-hour format (i.e. enter a 4-digit number in [hhmm] format).

The system will return you to the day selection menu. Scroll to the next day you want to program, or to exit auto-arm programming, press [#].

NOTE: To change the auto-arm schedule at another partition, users with access to that partition will have to select the partition on the keypad before entering the auto-arm schedule menu.

NOTE: Only LCD5500 v2.0 or greater keypads support the [*][6][3] menu option.

[4] - System Test

When System test is initiated the panel will perform the following.

- Sound the alarm output for two seconds
- Light all lights and display pixels on the keypad
- Sound the keypad buzzer for two seconds
- Test the main panel/PC5200/PC5204 battery
- Send a System Test Reporting code, if programmed.

[5] - Enable DLS / Allow System Service

If enabled, the installer will be able to access Installer Programming by DLS. In case of DLS access this provides a window where rings will be detected by the panel. The DLS window will remain open for 6hrs, during which time the installer will be able to enter DLS an unlimited number of times. After the 6-hr window has expired, Installer's Programming will be unavailable again until the window is re-opened.

[6] - User Initiated Call-Up

When [6] is pressed, the panel will initiate a call to the

downloading computer. The panel will make 1 attempt to call the downloading computer.

NOTE: The downloading computer must be waiting for the panel to call before downloading can be performed.

[7] - For Future Use

[8] - User Walk Test

[*][6] User Functions allows the user to enable/disable the User Walk Test mode. The User Walk Test functionality and operation are based on the Installer Walk Test however there are some relevant differences between them regarding fire zone violation handling or communication during the test. Fire zones, [F] Key and 2-wire Smoke Detectors are excluded from User Walk Test. If any of these zones is violated or activated during User Walk Test, the system will exit from Walk Test mode and generate an alarm condition for the violated fire zone. To provide support for event communication new Programming Sections are added for the Walk Test Begin/End reporting codes.

The User Walk Test mode operates with a 15 minute time out. If there is no zone violation for 15 minutes, the system restores from User Walk Test mode.

The Bell will sound a squawk instead of a 2-second pulse.

LCD Keypad User Functions

Additional features are available using on the LCD keypad. These features do not have numbers assigned. Use the arrow keys (< >) to scroll through the [*][6] menu and press the [*] key to select the following commands.

- **View Event Buffer:** The 500 Event Buffer can be viewed through any LCD keypad.
- **Brightness Control:** When this option is selected the keypad will allow you to scroll through 10 different backlight level options. Use the arrow keys (<>) to scroll to the desired backlight level and press the [#] key to exit.
- **Contrast Control:** When this option is selected the keypad will allow you to scroll through 10 different contrast level options. Use the arrow keys (< >) to scroll to the desired contrast level and press the [#] key to exit.
- **Keypad Buzzer Control:** When this option is selected the keypad will allow you to scroll through 21 different keypad sounder tone options. Use the arrow keys (< >) to scroll to the desired keypad beeper level and press the [#] key to exit. This function can be achieved on LED keypads by holding the [*] key.

[*][7] Command Output Functions

There are four output functions available to the user. Entering [*][7] [1-4] [Access Code, if required] will activate any output programmed as [19]-[22] (respectively). Each function can be performed when the system is either armed or disarmed.

[*][8] Installer Programming

Enter [*][8] followed by the Installer Code to enter Installer Programming.

[*][9] Arming Without Entry Delay

When a partition is armed with the [*][9] command the panel will remove the entry delay from the partition. After the exit delay, Delay 1 and Delay 2 type zones will behave as instant and Stay/Away zones will remain bypassed. The entry delay can be activated or deactivated at any time while the system is armed by pressing [*][9].

NOTE: If the panel is armed using [*][9], disarming will only be possible from the keypad inside the premises.

NOTE: Global Delay zones will always have an entry delay, even if the system is armed using [*][9].

[*][0] Quick Arm

If the Quick Arm Enable option is enabled the panel can be armed by entering [*][0]. This is a useful method of arming a Partition when someone without a access code will be required to arm a Partition.

NOTE: *The Quick Arm feature must be enabled in order for the Stay/Away function keys to operate as intended. If the feature is not enabled, the user will be required to enter their access code after pressing the Stay or Away function key in order to arm the system in the stay or away mode.*

[*][0] Quick Exit

Quick Exit will allow someone to leave an armed premise through a Delay type zone without having to disarm and rearm the system.

When [*][0] is entered, if the Quick Exit Enabled option is enabled, the panel will provide a two minute window to exit. During this time the panel will ignore the first activation of a Delay type zone. When the Delay zone is secured the panel will end the two minute time period.

If a second Delay zone is tripped, or if the zone is not restored after two minutes, the panel will start entry delay.

NOTE: *If Quick Exit is used on a partitioned system, Keypad Blanking and Access Code Required to Remove Blanking should be enabled.*

Quick Arm Enable	Section [015], Option [4]
Quick Exit Enable	Section [015], Option [3]

4.3 Function Keys

There are 5 function keys on the PC1616/PC1832/PC1864 keypads. The function is activated by pressing and holding the key for 2 seconds. The programming of any function key on any keypad may be changed to one of the options listed below. (See section 2.7 'Keypad Assignment' on page 7 for instructions on changing function key programming.)

[00] - Null Key

The key is not used and will perform no function when pressed.

[01] - Select Partition 1

Provides an easy way to select Partition 1. This is the same as pressing and holding the [#] key then pressing and holding the [1] key to select Partition 1 (see section 4.4 'Global and Partition Keypad Operation').

[02] - Select Partition 2

Provides an easy way to select Partition 2. This is the same as pressing and holding the [#] key then pressing and holding the [2] key to select Partition 2 (see section 4.4 'Global and Partition Keypad Operation').

[03] - Stay Arm

Arms the partition to which the keypad is assigned. All Stay/Away type zones will be automatically bypassed. Delay type zones will provide entry and exit delay. The Quick Arm feature must be enabled for this key to function (Section [015], Option [4]). If Quick Arming is not enabled, the user must enter their access code after pressing the function key in order to arm the system in the Stay mode.

[04] - Away Arm

Arms the partition to which the keypad is assigned. All Stay/Away type zones will be active at the end of the exit delay. Delay type zones will provide entry and exit delay. The Quick Arm feature must be enabled for this key to function (Section [015], Option [4]). If Quick Arming is not enabled, the user must enter their access code after pressing the function key in order to arm the system in the Away mode.

[05] - [*][9] No-Entry Delay Arm

After this function key is pressed the user must enter a valid access code. The Partition will arm and remove entry delay

from the partition when the exit delay expires (see section '[*][9] Arming Without Entry Delay').

[06] - [*][4] Door Chime On/Off

Pressing the key will toggle the Door Chime feature ON or OFF. One solid beep means the feature has been disabled, three short beeps means it has been enabled.

[07] - [*][6]...[4] System Test

This function key provides the user with a simple method for testing the system (see section '[*][6] User Functions'). A valid Master Code is required to perform this command.

[08] - [*][1] Bypass Mode

This function key provides the user with a simple method for entering the Bypass Mode. If a access code is required it must be entered before bypassing can be performed (see section '[*][1] Zone Bypassing').

[09] - [*][2] Trouble Display

This function key provides the user with a simple method for entering the Trouble Display Mode (see section '[*][2] Trouble Display').

[10] - [*][3] Alarm Memory

This function key provides the user with a simple method for entering the Alarm Memory Display Mode (see section '[*][3] Alarm Memory').

[11] - [*][5] Programming Access Codes

This function key provides the user with a simple method for programming access codes. After this key is pressed a valid System Master or Supervisor Code will have to be entered before the panel will allow programming to be performed (see section '[*][5] Programming Access Codes').

[12] - [*][6] User Functions

This function key provides the user with an easy method for programming user functions. After keys are pressed a valid System Master or Partition Master must be entered before the panel will allow user functions to be performed (see section '[*][6] User Functions').

[13] - [*][7]+[1] Command Output Option 1

This function key provides the user with a simple method for activating a PGM Output programmed as Command Output Option 1 (See Section 5.8 Programmable Output Programming PWS Sect 8). By default, after this key is pressed a valid access code must be entered (see section '[*][7] Command Output Functions').

[14] - [*][7]+[2] Smoke Detector Reset

Pressing this key will cause the panel to activate for 5 seconds any output programmed as Sensor Reset. (see section '[*][7] Command Output Functions').

[15] - For Future Use

[16] - [*][0] Quick Exit

Pressing this key will cause the panel to activate the Quick Exit feature (see section '[*][0] Quick Exit').

[17] - [*][1] Reactivate Stay/Away Zones

This function key provides the user with a simple method for adding Stay/Away zones back into the system (see section '[*][1] Zone Bypassing').

[18] - For Future Use

[19] - [*][7]+[3] Command Output 3

This function key provides the user with a simple method for activating a PGM Output programmed as Command Output Option 3

[21] - [*][7][4] Command Output 4

This function key provides the user with a simple method for activating a PGM Output programmed as Command Output Option 4

[22] - For Future Use

[23] - Bypass Recall

Pressing this function key will recall the last group of bypassed zones. The function key will follow the Code Required for Bypass option. If the option is enabled, a valid access code with the Bypass attribute enabled must be entered after the function key is pressed. For instructions on zone bypassing, see the *PC1616/PC1832/PC1864 User's Guide*.

[24] - Recall Bypass Group

This function key will recall zones in the Bypass Group for the partition. This group is programmed by the user in the [*][1] Bypass menu. The function key will follow the Code Required for Bypass option. If the option is enabled, a valid access code with the Bypass attribute enabled must be entered after the function key is pressed.

[25] - For Future Use

[26] - Time and Date Programming Function Key

When this function key is programmed the panel time and date can be programmed. There are two different ways to use this function key.

1. With the PK5500/RFK5500 series keypads press [*][2], when Trouble 8 appears on the screen, press the [*] key. This will take you into Time Programming.
2. Or press the function key, once programmed by the installer, and you enter the Time and Date programming menu.

NOTE: If you enter into the Time and Date Programming using the function key, pressing [#] to exit will return to the base users menu.

[27] - Select Partition 3

[28] - Select Partition 4

[29] - Select Partition 5

[30] - Select Partition 6

[31] - Select Partition 7

[32] - Select Partition 8

These keys provide users with an easy way to select one of the above partitions. For example, this is the same as pressing and holding the [#] key, then pressing and holding the [3] key to select Partition 3 (see section 4.4 'Global and Partition Keypad Operation').

4.4 Global and Partition Keypad Operation

A global keypad will display limited information until a partition is selected: the Trouble light will turn on if a trouble condition is present, and the Armed light will turn on if all the partitions are armed. To select a partition the user must press and hold one of keys [1] - [8] for two seconds, depending on which partition they want to access. (e.g. press and hold [2] for Partition 2). The keypad will then display the status of the selected partition and allow normal operation.

A Partition keypad will display the status of the Partition it is assigned to. A user with access to more than one partition may temporarily assign the keypad to another partition to gain access. To do this the user must first press and hold the [#] key for two seconds. The keypad will go blank. The user must then press and hold one of keys [1] - [8] for two seconds, depending on which partition they want to access (e.g. press and hold [2] for Partition 2). The keypad will then dis-

play the status of the selected partition and allow normal access.

4.5 Keypad Features

Not all features are available on all keypad types, refer to the installation sheet that came with your keypad for a list of supported features.

Automatic Scrolling of Open Zones

The LCD keypad automatically scrolls through open zones while the keypad is idle. This feature, if enabled, will override the clock display. This option can be programmed in LCD programming section [076], Option [8].

Automatic Scrolling of Alarms in Memory

The LCD keypad allows automatic scrolling through alarms in memory while the keypad is idle. This feature, if enabled, will override the clock display. This option can be programmed in LCD programming section [076], Option [4].

24 Hour Time Display Option

LCD keypads can be programmed to display time using a 24- hour clock, instead of a 12-hour, a.m./p.m. clock. This option can be programmed in LCD programming section [076], Option [3].

Keypad Zones

See section 2.11 'Keypad Zone/PGM' on page 10.

Viewing Troubles While Armed

See section '[*][2] Trouble Display' on page 13 for information on how to view troubles.

Backlighting Boost

Keypads will provide extra number pad lighting when any key is pressed. The backlighting boost will last for an additional 30 seconds after the last keypress.

Section 5: Programming Sections

The structure of this section corresponds with the structure of the Programming Worksheets (PWS) and is intended to be used with them.

5.1 Keypad Programming

Refer to Section 2.7 'Keypad Assignment'



5.2 Basic Programming

[001]-[004] - Zone Definitions

These sections require 16 two digit entries. Each two digit number entered determines how a zone will operate.

NOTE: In addition to selecting how each zone will operate, attributes may be programmed by zone (see section 5.3 'Advanced Programming' [101]-[164]).

Option	Zone Type	Description
00	Null Zone	For zones that are not used and do not require a closed loop or EOL resistor
01	Delay 1	Follows the Entry Delay 1 and Exit Delay programmed in Section [005] and is normally used for Entry/Exit doors. The exit delay starts as soon as the panel is armed. The zone may be opened and closed during the delay time without causing an alarm. After the exit delay time has expired, opening the zone will start the Entry Delay timer. During the Entry Delay time, the keypad buzzer will sound steadily to advise the user that the system should be disarmed. If the panel is disarmed before the Entry Delay expires, no alarm will be generated.
02	Delay 2	Operates the same as Type [01] zone except the Entry Delay time can be independently set in Section [005]. The Exit Delay time is common to both zone types.
03	Instant	Normally used for door and window contacts and has the standard Exit Delay, but is instant when opened after the Exit Delay expires.
04	Interior	Used with interior motion detectors. Interior zones feature an Exit Delay and an Entry Delay provided that any Delay type zone has been tripped first. If the protected area is entered without coming through the a delayed entrance and an Interior zone is tripped, an immediate alarm will be generated.
05	Interior Stay/Away	If the system is armed and a Delay zone is NOT tripped during the exit delay time, this zone type will be bypassed. If the [*][1] command is used to activate all Stay/Away type zones, this zone will have the standard exit delay. Once armed, this zone will act like an Interior type zone [04].
06	Delay Stay/Away	If the system is armed and a Delay zone is NOT tripped during the exit delay time, this zone type will be bypassed. If the [*][1] command is used to activate all Stay/Away type zones, this zone will have the standard exit delay. Once armed, this zone will follow the Entry Delay time for Entry Delay 1 when tripped. NOTE: The automatic bypass on Stay/Away type zones will not be removed by any event other than a valid exit through a non-Global Delay type 1 zone during the exit delay or by pressing [*][1] while armed.
07	Delayed 24-hr Fire (Hardwired)	Operates the same as the standard Fire zone, except the alarm memory and transmission by the communicator is delayed by 30 seconds. If the alarm is acknowledged by pressing any key within 30 seconds, the bells will silence and the transmission will be aborted. If the alarm has been acknowledged, and the smoke detector has not been restored to normal, the bell output will activate after 90 seconds, the user then has another 30 second delay before the bell output latches and communications is activated. A code is then required to silence the bell output. NOTE: The Fire Delay will be terminated if a 2nd Fire zone is tripped or if the [F] key is pressed during a delay.
08	Standard 24-hr Fire (Hardwired)	This Fire Zone is used for pull station type circuits. On alarm, the bell output will sound to indicate that the fire loop has been activated. If enabled, the communicator will immediately transmit the alarm to the monitoring station. NOTE: DO NOT change the Zone Attributes of Fire type zones from the default settings.
09	Future Use	
10	24-hr Supervisory Buzzer	This zone is active at all times and will report an alarm at all times. Once tripped, the keypad buzzer will sound until a valid access code is entered. NOTE: This zone type should not be used on a Keyswitch ONLY system
11	24-hr Burglary	This zone is active at all times and will report an alarm if the panel is armed or disarmed. This zone will sound the bell for the length of 'Bell cutoff' if the audible attribute is enabled.
12	24-hr Holdup	Similar to 24 Hour Burglary except for System Event output type and SIA identifier.
13	24-hr Gas	Similar to 24 Hour Burglary except for System Event output type and SIA identifier
14	24-hr Heat	Similar to 24 Hour Burglary except for System Event output type and SIA identifier.
15	24-hr Medical	Similar to 24 Hour Burglary except for System Event output type and SIA identifier
16	24-hr Panic	Similar to 24 Hour Burglary except for System Event output type and SIA identifier.
17	24-hr Emergency	Similar to 24 Hour Burglary except for System Event output type and SIA identifier
18	24-hr Sprinkler	Similar to 24 Hour Burglary except for System Event output type and SIA identifier
19	24-hr Water	Similar to 24 Hour Burglary except for System Event output type and SIA identifier
20	24-hr Freeze	Similar to 24 Hour Burglary except for System Event output type and SIA identifier.
21	24-hr Latching Tamper	This zone type, when violated, will cause arming of the system to be inhibited until the valid Installer code is entered. If this zone type is violated, the Installers code must be entered ([*][8] Installers Code) before the system can be armed.
22	Momentary Keyswitch Arm	A keyswitch module may be connected to the zone programmed as Momentary Keyswitch arm. Momentary activation of this zone to the alarm state will alternatively arm and disarm the system and silence alarms. Tamper and Faults will only initiate their respective trouble sequence. NOTE: The panel arms in Away mode (for SKAFOR Installations only).

Option	Zone Type	Description																																													
23	Maintained Keyswitch Arm	A keyswitch module may be connected to the zone programmed as Maintained Keyswitch arm. In the restored state, the panel is disarmed. Only the violation of this zone type to the alarm state will make the panel arm. Tamper and Faults will only initiate their respective trouble sequence. NOTE: The panel arms in Away mode (for SKAFOR Installations only).																																													
24	Future Use																																														
25	Interior Delay Zone	The Interior Delay Zone is normally used with motion detectors and has a standard exit delay time. If the panel is armed, and a Delay zone is violated during the Exit Delay (or the Away function key is used), the Interior Delay Zone will be active at the end of the Exit Delay. This zone will cause an instant alarm when violated. This zone type will follow the Entry Delay time provided that a Delay zone is violated first. If the panel is armed, and a Delay zone is NOT violated during the Exit Delay (or the Stay function key is used, or [*][9] armed), a violation of this zone type will initiate Entry Delay1.																																													
26	24-hr Non-Alarm	These zones are active at all times but do not cause an alarm, and do not show up in alarm memory. Zone Attributes such as Zone Bypassing and Door Chime affect the functionality of this zone. A 24 Hour Non-alarm zone may be used for Zone Follow automation applications. NOTE: This zone type will be active in Walk Test. Tamper and Faults. Zones programmed as 24 Hour Non-alarm type will not cause alarms. NOTE: Alarms on this zone will not initiate Downlook.																																													
27	Future Use																																														
28	Future Use																																														
29	Auto Verified Fire Zone	This zone ensures that an alarm condition persists by resetting a tripped sensor in a fire zone and confirming that the sensor has remained tripped or is waiting for the sensor to re-trip within a set period of time. (e.g. Cycling power to a smoke detector to ensure the condition persists when power is restored.) The alarm sequence for the zone is indicated below: <table border="0"> <tr> <td>Step #1</td> <td>Duration 20 Seconds</td> <td>Sensor Reset</td> </tr> <tr> <td>Step #2</td> <td>Duration 10 Seconds</td> <td>Settle Time (Power Up)</td> </tr> <tr> <td>Step #3</td> <td>Duration 60 Seconds</td> <td>Check for Verified Alarm</td> </tr> </table> NOTE: If another fire device detects fire during the Auto Verify or Delay sequence, the sequence is terminated and alarms are immediately generated for all pending zones. This applies to all other Fire zones on the system regardless of the partition assignments (i.e. two fire alarms anywhere on the system will cancel all pending fire delays and create immediate alarms).	Step #1	Duration 20 Seconds	Sensor Reset	Step #2	Duration 10 Seconds	Settle Time (Power Up)	Step #3	Duration 60 Seconds	Check for Verified Alarm																																				
Step #1	Duration 20 Seconds	Sensor Reset																																													
Step #2	Duration 10 Seconds	Settle Time (Power Up)																																													
Step #3	Duration 60 Seconds	Check for Verified Alarm																																													
30	Fire Supervisory Zone	When this zone is violated, the system turns on the keypad buzzer, and communicates the supervisory alarm condition to the monitoring station. The buzzer will not follow the Bell-Time-Out timer. To silence the buzzer, a valid access code must be entered.																																													
31	Day Zone	A zone programmed with this type has different characteristics in the armed and disarmed state. In the disarmed state, violating this zone will sound the keypad buzzer but will not log or report the event. In the armed state, violating this zone will sound the bell and communicate the event.																																													
32	Instant, Stay/Away Zone	The Instant Stay/Away Zone will be bypassed when armed in the Stay Mode, but will act like an Instant Zone when armed in the Away Mode. This zone type is useful for motion detectors in an installation that must not follow the Entry Delay after a Delay zone is violated, but must still retain the Stay/Away functionality.																																													
33	Push to Set Zone 	When the panel is armed with this zone type programmed an infinite exit delay will begin (see chart below). To complete the arming sequence after infinite exit delay has begun, the Push to Set zone must be violated and restored, the system then counts down a five second exit delay. The infinite exit delay is audible. All arming methods that start infinite exit delay are audible except and [*][9] arming. This zone definition uses SIA data code "BA-XX / BH-XX" when violated during walk test, Exit Delay Termination should not be used with this zone type because it does not go into alarm while armed or disarmed (where XX is the zone that went into alarm). Away arming with a bypassed Push to Set or Final Door Set zone prevents the panel from arming because the exit delay never terminates. <table border="1"> <thead> <tr> <th>Arming Method</th> <th>Infinite Exit Delay</th> <th>Arming Mode</th> <th>Arming Method</th> <th>Infinite Exit Delay</th> <th>Arming Mode</th> <th>Arming Method</th> <th>Infinite Exit Delay</th> <th>Arming Mode</th> </tr> </thead> <tbody> <tr> <td>User Code</td> <td>Y</td> <td>Away</td> <td>[*][0] Arm</td> <td>Y</td> <td>Away</td> <td>Wireless Key Stay</td> <td>N</td> <td>Stay</td> </tr> <tr> <td>Key Switch</td> <td>Y</td> <td>Away</td> <td>Escort Local</td> <td>Y</td> <td>Away</td> <td>Escort Remote</td> <td>N</td> <td>Away</td> </tr> <tr> <td>Away Arm</td> <td>Y</td> <td>Away</td> <td>[*][9] Arm</td> <td>N</td> <td>Stay</td> <td>DLS Arm</td> <td>N</td> <td>Away</td> </tr> <tr> <td>Wireless Key Away</td> <td>Y</td> <td>Away</td> <td>Stay Key</td> <td>N</td> <td>Stay</td> <td>Auto Arm</td> <td>N</td> <td>Away</td> </tr> </tbody> </table>	Arming Method	Infinite Exit Delay	Arming Mode	Arming Method	Infinite Exit Delay	Arming Mode	Arming Method	Infinite Exit Delay	Arming Mode	User Code	Y	Away	[*][0] Arm	Y	Away	Wireless Key Stay	N	Stay	Key Switch	Y	Away	Escort Local	Y	Away	Escort Remote	N	Away	Away Arm	Y	Away	[*][9] Arm	N	Stay	DLS Arm	N	Away	Wireless Key Away	Y	Away	Stay Key	N	Stay	Auto Arm	N	Away
Arming Method	Infinite Exit Delay	Arming Mode	Arming Method	Infinite Exit Delay	Arming Mode	Arming Method	Infinite Exit Delay	Arming Mode																																							
User Code	Y	Away	[*][0] Arm	Y	Away	Wireless Key Stay	N	Stay																																							
Key Switch	Y	Away	Escort Local	Y	Away	Escort Remote	N	Away																																							
Away Arm	Y	Away	[*][9] Arm	N	Stay	DLS Arm	N	Away																																							
Wireless Key Away	Y	Away	Stay Key	N	Stay	Auto Arm	N	Away																																							
34	Final Door Set Zone 	If Final Door Set zone type is programmed, infinite exit delay will commence when arming is initiated. To complete the arming sequence after infinite exit delay has begun, the Final Door Set zone must be violated and then restored. When the system is armed, this zone functions identically to a Delay 01 zone, including the entry delay programmed in Section [005]. Away arming with a bypassed Push to Set zone or Final Door Set will prevent the panel from arming because the exit delay never terminates.																																													
35	24-hr Bell/Buzzer	Similar to 24 Hour Burglary Zone when armed. Similar to 24 Hour Supervisory Buzzer zone when disarmed. When the panel is armed and this zone is violated, the Bell will sound for the duration of Bell Time Out. When the panel is disarmed and this zone is violated, the buzzers will sound until a valid access code is entered. The SIA identifier BA-XX/BH-XX will be sent for this zone type in both states.																																													
36	24-hr Non-Latching Tamper Zone 	To provide support for tamper protection this new 24-hr Non-Latching Tamper Zone type is implemented. This zone is always active and will report a tamper condition if the panel is armed or disarmed.																																													
37	Night Zone	This zone type will only be considered as armed when the panel is armed in one of the following ways: 1 The panel is armed and then a delay zone is activated during an exit delay 2 The panel is armed using the away mode function key on the keypad or wireless key. If the panel is stay armed and then the interior zones are activated through *1 the night zones will not be armed. Instead the zone will act like an interior stay away type zone. This will give the user a way of arming an area that will not be used during the night.																																													
87	Delayed 24-hr Fire (Wireless)	Used only with wireless smoke detectors. Functions same as that of Zone Type [07].																																													
88	Standard 24-hr Fire (Wireless)	Used only with wireless smoke detectors. Functions same as that of Zone Type [08].																																													

[005] - System Times

This section has 9 sub-sections, 1 for each of the 8 partitions, and 1 for the Bell timeout. This section programs the entry and exit delays for the control panel. After entering section [005] press [01] to select partition 1. Enter the 3-digit delay time for Delay 1 type zones, Delay 2 type zones followed by the exit delay time. Enter the next 2 digit sub-section number to program the next partition. Press [#] to exit the sub-menu and return to regular programming.

NOTE: Entry of 000 in these sections will result in a 255 second time.

Sub-Sections 1-8 each require three 3-digit entries.

[01] - [08] Entry Delay 1, Entry Delay 2, and Exit Delay per Partition.

- **Entry Delay 1:** (001-255) Seconds

This value determines the Entry delay time for Delay 1 type zones. The default Entry Delay 1 time is 30 seconds.

- **Entry Delay 2:** (001-255) Seconds

This value determines the Entry delay time for Delay 2 type zones. The default Entry Delay 2 time is 45 seconds.

- **Exit Delay:** (001-255) Seconds

This value determines the Exit delay time when arming the system. The default Exit Delay time is 120 seconds.

NOTE: For SIA FAR Installations, the Exit Delay must be within the range of 045-255 seconds (Default 60 seconds). If the Exit Delay is silent (Section 14, Option 6 or Stay Function Key Arming) the exit delay must be twice the programmed value but must not exceed 255 seconds (i.e., 090-255 seconds).

NOTE: For UL Installations, the Entry Delay plus the Communications Delay must not exceed 60 seconds.

NOTE: Exit Time Restart shall be disabled when the panel is used in combination with T-Link TL250/TL300.

[09] Bell Cut-off: (001-255) Minutes

The Bell Cut-off for all 8 partitions is one entry.

The siren will silence after the number of minutes programmed for the **Bell Cut-off** time have passed. The default Bell Cut-off is 4 minutes

The panel supervises the Bell output. If an open condition is detected, the panel will immediately indicate a trouble condition by beeping the keypad twice every 10 seconds to alert the owner of the problem. The panel can send a **Bell Circuit Trouble** and **Trouble Restoral** reporting codes to indicate the situation (See Section 5.6 Communicator Programming).

If the **Temporal Three Fire Signal** option is enabled, all Fire signals will follow the Temporal Three Pattern as described in NFPA 72. If turned OFF all Fire signals will sound a one second on, one second off cadence.

If **Fire Bell Continuous** is enabled, the alarm output will sound until a code is entered. If disabled, the alarm will sound until a code is entered or the bell cut-off time has expired.

NOTE: Only fire zones will follow the Temporal Three Fire Signal.

.....
Bell Cut-off	Section [005]
Bell Circuit Trouble Reporting Code	Section [349]
Bell Circuit Trouble Restoral Reporting Code	Section [350]
Temporal Three Fire Signal	
Enable/Disable	Section [013], Option [8]
Fire Bell Continuous	Section [014], Option [8]
.....

[006] - Installer's Code

The installers code is used to enter installers programming. Enter installers programming by entering [*][8][installers code]. By default the installers code is 5555 when using 4 digit access codes and 555555 when using 6 digit access codes.

[007] - Master Code

The Master code can only be changed by the Master or the Installer Code if it has been programmed to change, see section [015] (6).

NOTE:  For EN installations the installer will not have access to Master Code Programming. In order to return the master code to the factory default setting enter the Special Installer Function [989][Installer's Code][989] (Master Code Factory Default Programming). This will allow the installer to default the Master Code.

[008] - Maintenance Code/Guard Code

When used as Maintenance Code it is a Arm/Disarm code only. It can not be used to bypass, activate [*][7] outputs, program other user codes or enter the [*][6] menu. It can access and arm through the ESCORT5580. Openings or Closings using this code report as a Special Opening/Closing and will log to the event buffer as "Maintenance Code". The Guard Code can arm the panel at any time. However, the Guard code can only disarm the system after an alarm, tamper, fault or trouble condition has occurred. It can also be used to bypass zones and activate Command Outputs. Arming and Disarming by the Guard Code will log as "Closing (Opening) by Maintenance Code". If a Command Output that requires a code is activated with the Guard Code, no User Log will be made. When zones are bypassed with the Guard Code, the panel will log "[*][1] Access by User"..

[009]-[011] - Programmable Output Options

Programmable Outputs are programmed with a two digit code indicated in the table below. Programmable outputs are available on the following devices:

- PGM1 and PGM2 on the PC1616/PC1832/PC1864 main board
- PGM3 and PGM4 on the PC1864 main board
- 8 low current outputs available with the PC5208 Output Module
- 4 high current outputs available with the PC5204 Power Supply/Output Module
- Section [009] is used to program two PGM outputs on the PC1616/PC1832/PC1864.
- The first two entries of Section [010] are used to program the last two outputs on the PC1832/PC1864, and the first two on the PC5208.
- Section [010] is used to program the PGM outputs on the PC5208.
- Section [011] is used to program the PGM outputs on the PC5204 and PGM3 and PGM4 on the PC1864.

Programming any of the outputs is a three step process:

1. Select an option from the list below for the PGM output.
2. Select the output attributes for the PGM output.
3. Select the partitions on which the PGM output will operate.



The following is a list of the programmable output options and attributes.

.....
PGM Attribute Programming	Section [501]-[564]
.....

[009]-[011] - Programmable Output Options

Option	Output	Description								
01	Burglary and Fire Bell Lower	<p>This output will activate when the alarm output is active (switch to ground) and will turn off when the alarm output is silenced. If the alarm output is pulsing, the PGM output will pulse as well. This PGM output will follow:</p> <ul style="list-style-type: none"> • Fire Pre-alerts • Temporal Three Fire Signal (if enabled) • All Burglary and Fire Alarms by Partition • Bell Cut-Off time <p>This output will NOT follow Bell Squawks of any kind. The Main Bell will still activate for all alarms; the PGM output will only activate for alarms for the partition it is assigned to.</p> <p>NOTE: The Fire Bell has precedence over Burglary. If a fire alarm occurs on Partition X, and Partition Y already has a Burglary Alarm active ("Burg" PGM active on Partition Two), the Fire and Burg output on Partition Y will pulse ("Fire" PGM) with the Main Bell. Silent alarms will be audible if the either Partition is in an audible alarm condition.</p>								
02	Future Use									
03	Sensor Reset	<p>This output will normally be active (switched to ground). This option is used to reset power for latching smoke detectors. The output will deactivate for 5 seconds when the [*][7][2] command is entered (see section '[*][7] Command Output Functions'). The keypad buzzer will not sound for the five second period.</p> <p>Refer to the Control Panel Wiring Diagram in this manual for wiring instructions.</p> <p>NOTE: Only ONE of options [03] Sensor Reset and [20] [*][7][2] Command Output Option [2] may be programmed on the same system.</p> <p>When this option is selected, the PGM output is normally low. That is it is the reverse of all other options which are normally high and go low when activated. This option is normally used as the negative return for power to 4-wire smoke detectors (positive comes from the Aux + terminal). To activate this output (to reset smoke detectors), enter the [*][7][2] command. The PGM terminal will go high (open circuit), and thus remove power from the devices connected. Refer to the hookup diagram at the back of the manual for instructions on connecting 4 wire smoke detectors.</p>								
04	2-Wire Smoke Reset (PGM2 only)	<p>When this option is selected, the PGM2 functions much like option 03 in that it is normally low supplying the negative return. However, 2 Wire smoke detectors can be supported which means that a zone input does not need to be used. The PGM2 terminal also supervises the input and generates a trouble condition with the absence of a 2.2KΩ resistor between it and the Aux + terminal. The two wire smoke detector input is an instant and latching alarm.</p>								
05	System Armed Status	<p>The output will activate (switch to ground) when the Partition or System is armed and deactivate when disarmed. If this output is assigned to both partitions, all partitions must be Armed for the output to activate.</p>								
06	Ready To Arm	<p>The output will activate (switch to ground) when the Partition or System is ready to arm (all non-force armable zones on the system are restored). The output will deactivate when an access code is entered to arm the system and the exit delay begins.</p>								
07	Keypad Buzzer Follow	<p>This output will activate (switch to ground) when any of the following events occur and will remain active for as long as the keypad buzzer is active:</p> <ul style="list-style-type: none"> • Door Chime • Entry Delay • Audible Exit Delay • Auto-arm Prealert • 24 hour Supervisory Buzzer Zone 								
08	Courtesy Pulse	<p>This option provides an output which activates for the entry and exit times, plus 2 minutes. It can be used to turn on a courtesy light near the exit door for the duration of the entry / exit times. If more than one courtesy pulse output is required, they all must be programmed for global operation (PGM attributes 1 and 2 enabled).</p>								
09	System Trouble	<p>The output will activate (switch to ground) when any of the selected trouble conditions are present. It will deactivate when all the selected trouble conditions are cleared. The PGM attributes for this option, programmed in Sections [141] to [142], differ from the standard selection of attributes normally programmed in sections [501] to [514]. Program which trouble conditions will activate the output by selecting some or all of the following attributes:</p> <table border="0"> <tr> <td>Bit [1] Service Required*</td> <td>Bit [5] Fire Trouble / Zone Fault</td> </tr> <tr> <td>Bit [2] AC Failure</td> <td>Bit [6] Zone Tamper</td> </tr> <tr> <td>Bit [3] Telephone Line Trouble</td> <td>Bit [7] Zone Low Battery</td> </tr> <tr> <td>Bit [4] Failure to Communicate</td> <td>Bit [8] Loss of Clock</td> </tr> </table> <p>*Battery, bell, general trouble, general tamper, general supervisory</p>	Bit [1] Service Required*	Bit [5] Fire Trouble / Zone Fault	Bit [2] AC Failure	Bit [6] Zone Tamper	Bit [3] Telephone Line Trouble	Bit [7] Zone Low Battery	Bit [4] Failure to Communicate	Bit [8] Loss of Clock
Bit [1] Service Required*	Bit [5] Fire Trouble / Zone Fault									
Bit [2] AC Failure	Bit [6] Zone Tamper									
Bit [3] Telephone Line Trouble	Bit [7] Zone Low Battery									
Bit [4] Failure to Communicate	Bit [8] Loss of Clock									
10	Latched System Event (Strobe)	<p>This output will activate (switch to ground) when any of the selected system events (alarms) occur on the system. In the armed state, the output will deactivate only once the system is disarmed. This output will activate when the programmed events occur on any partition.</p> <p>If an alarm activates this output in the disarmed state, the output will deactivate if a user enters a valid access code while the Bell Cut-off timer is counting down. The output will also deactivate if someone arms the system after the Bell Cut-off has expired. This output can be used to indicate that an alarm has occurred before entering the premises.</p> <p>The PGM attributes for this option, programmed in sections [501] to [514], differ from the standard selection of attributes normally programmed. Program the events that will activate the output by selecting some or all of the following attributes:</p> <ul style="list-style-type: none"> Bit [1] Burglary (Delay, Instant, Interior, Stay/Away and 24 Hour Burglary Zones) Bit [2] Fire (Fire Keys, Fire Zones) Bit [3] Panic (Panic Keys and Panic Zones) Bit [4] Medical (Auxiliary Keys, Medical and Emergency Zones) Bit [5] Supervisory (Supervisory, Freezer and Water Zones) Bit [6] Priority (Gas, Heat, Sprinkler and 24-Hour Latching Zones) Bit [7] Holdup (Holdup zones) Bit [8] Output follows pulse timer (Section [170]) <p>This output will activate for silent and audible alarms or medical conditions only. It will not activate during pre-alert or delays.</p>								
11	System Tamper	<p>This output will activate (switch to ground) when any Tamper condition is present and will deactivate when all Tamper conditions are cleared. These tampers include zone tampers (DEOL), 24 hour latching tamper zone type, module and keypad tampers. This output will also activate for the following events: Bell CKT Trouble, TLM Trouble, Keybus Fault, Zone Expander Supervisory, General Supervisory, RF Jam and General Tamper.</p>								

Option	Output	Description
12	TLM and Alarm	This output will activate (switch to ground) when a telephone line fault condition is present AND an alarm occurs. The output will remain active until an access code is entered to disarm any partition. The output will activate for all audible and silent alarms (except duress) if a TLM trouble is present. If an alarm activates this output in the disarmed state, it will deactivate when the system is armed or the telephone line is restored.
13	Kissoff	The PGM Output will activate (switch to ground) for two seconds after the panel receives the kissoff from the central station.
14	Ground Start	The output will activate for two seconds before the panel attempts dialing to obtain a dial tone on Ground Start telephone equipment. Two 2-second pauses must be inserted at the beginning of the telephone number when using this option.
15	Remote Operation	This output can be activated and deactivated remotely on command from DLS software.
16	Future Use	
17	Away Armed Status	This output will activate when the system is armed with the Stay/Away zones activated.
18	Stay Armed Status	The output will activate when the system is armed with the Stay/Away zones bypassed. PGM Output Types [17] and [18] are designed to follow the status of the Stay/Away zones. If the system is armed with Stay/Away's bypassed, the Stay output should be active. If the system is armed with the Stay/Away's active, the Away output should be active. The following indicates how these arming techniques work. STAY Key - Stay [*][9] + Code - Stay AWAY Key - Away Keyswitch Arm - Depends on Delay Type Zone during the Exit Delay - Away for Skafor [*][0] Quick Arm - Depends on Delay Type Zone during the Exit Delay Access Code Arm - Depends on Delay Type Zone during the Exit Delay DLS Arm - Away Auto Arm - Away Stay Armed, then [*][1] - Away
19	Command Output #1	This output is activated by entering the [*][7][1] command. The configuration of the corresponding attributes determines how this PGM type will activate. Command Outputs 1-4 are user-initiated by entering [*] [7] [1-4] at any keypad. When any output is activated, three acknowledgment beeps are sounded. Refer to Section [501] and [551] for more information on Attributes. NOTE: If there are multiple outputs programmed with the same output type, the output options must be the same.
20	Command Output #2	This output is activated by entering the [*][7][2] command. The configuration of the corresponding attributes determines how this PGM type will activate. NOTE: Only ONE of options [03] Sensor Reset and [20] [*][7][2] Command Output Option #2 may be programmed on the same system.
21	Command Output #3	This output is activated by entering the [*][7][3] command. The configuration of the corresponding attributes determines how this PGM type will activate.
22	Command Output #4	This output is activated by entering the [*][7][4] command. The configuration of the corresponding attributes determines how this PGM type will activate.
23	Silent 24-hr Input (PGM2 Only)	With this input the Keypad will not indicate an alarm, the Bell will remain silent but the signal will be sent to the Central Station. This input does not follow Swinger Shutdown. A 2.2KΩ EOL resistor is required for this input (to Aux+). If a short or open occurs, an alarm is generated.
24	Audible 24-hr Input (PGM2 Only)	LCD keypads will show that the system is in alarm, and the Bell will sound for the Duration of Bell Time Out. The signal will also be sent to the Central Station. This input does not follow Swinger Shutdown. A 2.2KΩ EOL resistor is required for this input (to Aux+). If a short or open occurs, an alarm is generated.
25	Delay Fire and Burglary Output	This programmable output type operates the same as the Fire and Burglary Output (Type 01), except it follows the Transmission Delay Timer found in Section [377]. If a zone is violated that has the TX Delay Attribute enabled (Bit 7), the Bell and Regular Fire and Burg PGMs will activate. At the end of the Transmission Delay, this new PGM type will activate. This feature is used for outside sirens; if a false alarm occurs on a panel, the end user could silence it before any external sirens are activated. NOTE: If a zone is violated that causes an alarm that does not have Tx Delay enabled, these outputs will activate immediately. This PGM will not interfere with the operation of any other PGM Output. This Output is partitionable, and will follow transmission delay by partition. This Output will activate for Audible Exit Fault See Main Board PGM Output Options Section [009], PC5208 PGM Output Options Section [010], and PC5204 PGM Output Options Section [011]
26	Battery Test Output 	PGM output (Type [26]) has been added to comply with strict Norwegian Battery Test regulations. When the panel performs the battery check at midnight, the Battery Test PGM outputs will also activate. The application of this output is to control a relay that will switch a 20 ohm load across the battery for this 10 second period.
27	Police Code Output 	When the Police Code event occurs, this output will activate until the panel is either armed (access code, keyswitch, [*][0], etc) or disarmed.
28	Holdup Output 	When a Holdup Zone (Type [12]) goes into alarm, this output will activate until the partition is either armed (access code, keyswitch, [*][0], etc) or disarmed. A tamper or fault on this zone definition must not cause Holdup Outputs to activate. <ul style="list-style-type: none"> This feature is partition dependent and is programmed in the PGM attributes. This output does not activate In Walk Test If a global holdup alarm occurs, each partition that has the holdup zone assigned to it needs to be armed or disarmed before the holdup output will de-activate.

Option	Output	Description
29	Zone Follower Output	This output type is normally active and allows an output to deactivate for the duration that a zone is violated. The PGM Attributes are an eight-bit toggle mask that selects which zones the output will follow. Example: If PGM 1 is programmed as Type [29] with Attributes 1, 6, and 8 on, the Output will turn off when any one of Zones 1, 6, or 8 are in violation, and will activate when all three zones are restored. NOTE: The toggle mask always works as an OR function. If any zones are violated, the output turns off, and will not activate until all outputs are restored.
30	Partition Status Alarm Memory Output	This feature is intended to be used on a keyswitch plate and will function as follows: <ul style="list-style-type: none"> This feature is partition dependant and is programmed in the PGM attributes. This output will activate (steady), at the beginning of the exit delay, when the partition is armed. If an alarm occurs on the armed partition, the output will flash (1 sec ON, 1 sec OFF) for the remainder of the armed period If an alarm occurs on a disarmed partition (24 Hr zone), the output will flash (1 sec ON, 1 sec OFF) until the alarm is acknowledged (bells are silenced during Bell Time Out, or the partition is armed after Bell Time Out). This output is type 30. This output will not activate in walk test.
31	Alternate Communicator 	If any zone is still violated after the end of the Police Code Timer, it must be omitted from the system or bypassed and a transmission sent to the central station alerting them of the condition. The Police Code/Burglary Verified Timer must be ON for this feature to work. If the omitted zone is an entry/exit point, then PIR zones must provide entry delay to replace them. To delay the communication of alarms and the initiation of the confirmation time, the toggle option TX Delay-During Entry Only must be enabled. The transmission delay attribute must also be enabled for all zones and the communications delay time should be programmed with 255 in section [370] to ensure that the TX delay is longer or equal to the entry delay time. When entry delay expires, any communication delays will be cancelled. NOTE: When using for Opening/Closing, the Latched attribute must be OFF.
32	Open After Alarm 	This Programmable Output type activates for a 5 second period when the system has been disarmed after an alarm.

[012] - Keypad Lockout Options

The panel can be programmed to 'lockout' keypads if a series of incorrect access code entries are made. After the **Number of Invalid Codes Before Lockout** has been reached the panel will lock out the keypad for the **Lockout Duration** and log the event to the event buffer. For the duration of the lockout the panel will sound an error tone when any key is pressed. To program 'Number of Invalid Codes Before Lockout'.

Enter a number from 000 to 255 to determine the number of invalid master, duress, user or installer access code entries to reach keypad lockout. When keypad lockout occurs, the system is rendered inoperative via keypad for the programmed duration. When any keys are pressed, an error tone will sound.

To program 'Lockout Duration', enter a time from 000 to 255 minutes to determine the length of time before lockout resets and the keypad can once again be used.

To disable Keypad Lockout enter the **Number of Invalid Codes Before Lockout** as (000).

NOTE: If lockout is not reached within the hour roll-over, the number of invalid attempts is reset to 0.

NOTE: FAP keys are still active during Keypad Lockout.

NOTE: Keypad Lockout is a Global Feature.

NOTE: If Keypad Lockout is active, the panel cannot be armed or disarmed with a keyswitch.

[013] - First System Option Codes

Option	Definition	On/Off	Description
1	Zone Loop Type	ON	Normally Closed Loops All zones are wired as normally closed circuits with returns connected to a COM terminal. The end-of-line resistor is not required. An alarm will be generated when the circuit is opened.
		OFF	End-of-Line Resistors All zones must be wired with an end-of-line resistor configuration, determined by Option 2 in this system. NOTE: The valid EOL value is 5600 Ohms (5.6KW).
2	End-of-Line Option	ON	Double End-of-Line Resistors All zones will use Double-End-of-Line resistors, except Standard Fire, Delayed Fire, Supervisory, and LINKS Answer zone types. These zones must be connected using the EOL resistor. Double EOL resistors enables detection of zone faults and tampers. The tamper resistor (5.6KΩ) is placed across the alarm activating device, and the single EOL resistor (5.6KΩ) is placed between the alarm and tamper contacts. This configuration will allow the panel to detect zone faults (zone shorted), zone tampers (open zone), zone alarms (11.2KΩ), and restored zones (5.6KΩ). If the zone is disarmed and placed in the tamper (open) or fault (short) state, trouble beeps will generate on all system keypads until a key is pressed. A zone tamper will be sent to the monitoring station if programmed. If the zone is armed and a tamper is activated, The tamper alarm and zone alarm will be logged and transmitted. The zone will begin normal alarm sequence (Alarm, Bell, etc.).
		OFF	Single End-of-Line Resistors All zones must have a 5.6KΩ resistor across them. If the zone is shorted or open, it will be in the violated state. If the zone is open and programmed as a fire zone, it will be in the trouble state. NOTE: Zone Faults (Supervisories) on wireless zones will not cause an audible alarm while armed.
3	Trouble Display	ON	Panel Shows all Troubles While Armed The panel will illuminate the Trouble LED when any troubles are present on the System in both the armed and disarmed state.
		OFF	Panel Shows Only Fire Troubles While Armed The panel will illuminate the Trouble LED for all troubles while disarmed, but will only illuminate the LED for Fire Troubles while armed. NOTE: This option must be OFF if LCD5500 keypads older than version 2.0 are used.
4	Tampers/Faults Display	ON	Tampers and Faults Do Not Show as Open The panel will not illuminate the respective Zone LED if the zone is in the Tamper or Fault states, only the Trouble LED will be on.
		OFF	Tampers and Faults Show as Open The panel will illuminate the respective Zone LED if the zone is in the Tamper or Fault states. The Trouble LED will also light.

Option	Definition	On/Off	Description
5	Auto-arm Schedule Programming	ON	Auto-arm Schedule in [*][6] The Auto-arm Schedules (Sect [181] - [188]) are accessible via [*][6] as well as Installer's Programming.
		OFF	Auto-arm Schedule in Installer's Programming Only The Auto-arm Schedules (Sect [181] - [188]) are only accessible via Installer's Programming. NOTE: This toggle controls access for all eight partitions
6	Audible Exit Fault	ON	Audible Exit Fault is Enabled To prevent false alarms, use the built-in feature Audible Exit Fault. If a delay type zone is violated within 4 seconds after the exit delay has expired, the panel will sound the entry delay warning through the keypad and siren alerting the customer that an improper exit was made. If the panel is disarmed within the entry delay no signal is sent. If not, the panel will continue to sound the alarm and send a signal to central station.
		OFF	Audible Exit Fault is Disabled NOTE: For [*][9] arming, if Audible Exit Fault is enabled a violated zone will begin entry delay as per Audible Exit Fault functionality. If this option is disabled, a violated delay zone at the end of the exit delay will cause an instant alarm.
7	Event Buffer Follows Swinger Shutdown	ON	Event Buffer Follows Swinger Shutdown Once an event reaches its Swinger Shutdown limit programmed in Section [370], it will no longer log events to the Event Buffer until the Swinger Shutdown is reset. This avoids filling the Event Buffer with useless events and prevents the panel from overwriting the entire buffer if a problem exists. NOTE: The Event Buffer can be viewed with an LCD Keypad, printed on-site using the PC5400 printer module, or uploaded with DLS software.
		OFF	Event Buffer Logs Events past Swinger Shutdown The event buffer will continue to log events to the buffer even after the event has gone into swinger shutdown.
8	Fire Signaling	ON	Temporal Three Fire Signal To comply with NFPA 72, all Fire Bells will sound in the Temporal Three Pattern as described in the NFPA standard if this option is enabled. This cadence is as follows: (500ms ON, 500ms OFF, 500ms ON, 500ms OFF, 500ms ON, 1.5 sec. OFF).
		OFF	Standard Pulsed Fire Signal All fire bells will sound with the standard 1 second on/1 second off fire bell cadence. Only Zone Definitions [07], [27], [28], [29], [08], [87], and [88] (along with the [F] Key) will use this signaling if enabled. All other zone definitions set to pulse will use standard pulse cadence.

[014] - Second System Option Codes

Option	Definition	On/Off	Description
1	Bell Squawk	ON	Arm / Disarm Bell Squawk Enabled The Bell output will sound a single squawk when armed in any manner, including Auto-arm, and a double squawk upon disarming the system. If there are alarms in memory, the bell will emit a series of three squawk pairs to indicate the alarm memory. NOTE: If you enable the Bell Squawk on Arming/Disarming, the bell will sound arm/disarm bell squawks for all access codes, regardless of the programming for attribute [7] (see section ' [*][5] Programming Access Codes' NOTE: Enable both the Squawk on Away Arming/Disarming Only and the Arm/Disarm Bell Squawk options to have the panel squawk the bell only when the system is away armed with the Away key or disarmed with the Aux key.
		OFF	Arm / Disarm Bell Squawk Disabled The Bell output will not squawk when the system is armed or disarmed in any manner.
2	Bell During Auto-arm	ON	Bell Squawk During Auto-arm Enabled The Bell output will sound a single squawk every 10 seconds during the Auto-arm Pre-alert time. This will inform anyone on the premises that the system is being armed.
		OFF	Bell Squawk During Auto-arm Disabled The Bell output will not be activated during the Auto-arm warning time
3	Bell Squawk On Exit	ON	Bell Squawk On Exit Delay The Bell output will squawk once per second during the Exit Delay time. The bell will also sound 3 squawks per second for the final 10 seconds. NOTE: If the panel is armed using the Stay function key, or by entering [*][9][Access Code], there will be no bell squawks during entry and exit delays, except for the arm/disarm bell squawks. NOTE: If the panel is armed using the Stay function key there will be no bell squawks during the exit delay except for the arm bell squawk. If the panel is no-entry armed using [*][9][Access Code], there will be no bell squawks during the exit delay, except for the arm/disarm bell squawks. There is no entry delay (and no bell squawks) when the panel is no-entry armed.
		OFF	No Bell Squawk On Exit Delay The Bell output will not squawk during the Exit Delay time. This audible option does not apply to Stay and No Entry Arming Modes.
4	Bell Squawk On Entry	ON	Bell Squawk On Entry Delay The Bell output will pulse with the same timing as the buzzer during the Entry Delay time. The bell will also sound 3 squawks per second for the final 10 seconds if Option 6 in this section is enabled. NOTE: This feature must not be used with two or more partitions. NOTE: If the panel is armed using the Stay function key, or by entering [*][9][Access Code], there will be no bell squawks during entry and exit delays, except for the arm/disarm bell squawks.
		OFF	No Bell Squawk On Entry Delay The Bell output will not squawk during the Entry Delay time.
5	Bell Squawk on Trouble	ON	Bell Squawks on Trouble When there is a Trouble condition annunciated on the system keypads, the Bell will squawk 2 times every 10 seconds (as per the keypad buzzer). The Bell will be silenced when the keypad beeps are silenced (any key pressed on keypad).
		OFF	No Bell Squawks on Trouble The Bell output will not squawk when there is a Trouble condition annunciated on the system keypads.

Option	Definition	On/Off	Description
6	Audible Exit Beeps	ON	Audible Exit With Urgency The keypad will sound a pulsing tone (once per second) during the Exit Delay. For the last 10 seconds of the Exit Delay, the keypad and bell / siren (if enabled) will sound a different tone (3 tones per second) to warn that the Exit Delay is about to expire. NOTE: Users can restart the exit delay while it is counting down by pressing the Away key. The system will not log the user who re-started the exit delay, unless the Quick Arming Disabled/Function Keys Require Code option is turned on (section [015], option [4]). NOTE: If the system has been Stay armed, or armed with no entry delay ([*][9]), pressing the Away key will not re-start the exit delay.
		OFF	Silent Exit Delay The keypad will not sound during the Exit Delay.
7	Exit Delay Termination	ON	Exit Delay Termination Enabled The Exit Delay will be terminated once a Delay 1 Zone for the entry/exit door or area is restored. All audible options associated with the exit delay will be silenced when the Exit Delay is terminated. Force-Armable Delay 1 type zones will also terminate the exit delay. NOTE: If a Delay type zone is violated then secured during the exit delay, the exit delay will be terminated and the panel will be armed immediately.
		OFF	Exit Delay Termination Disabled The Exit Delay timer will continue to count even after the Delay Zone for the entry/exit door or area is restored. All audible options associated with the Exit Delay will function until the time programmed for the Exit Delay has elapsed.
8	Fire Bell Timeout	ON	Fire Bell is Continuous The Bell output will sound for all Fire type alarms until an access code is entered to silence the alarm or disarm the system regardless of the time programmed for Bell Timeout in Section [005].
		OFF	Fire Bell Follows Timeout The Bell output will sound for all Fire type alarms for the duration of Bell timeout or until an access code is entered.

[015] - Third System Option Codes

Option	Definition	On/Off	Description
1	[F] Key Annunciation	ON	[F] Key Enabled Pressing and holding the [F] key for 2 seconds will generate a Fire alarm. The keypad will sound a set of 3 beeps to acknowledge the valid alarm and the bell or siren will pulse one second on, one second off if option 8 of Section [013] is disabled (Standard Fire option). If Fire Bell is Continuous (Section [014], Option 8) is selected the alarm output will sound until a code is entered, otherwise it will sound until a code is entered or the alarm output times out. Communication of the signal to central station is immediate. The bell will sound for the length of Bell time-out. An alarm reporting code (if programmed) will be transmitted. NOTE: If enabled, this key will generate alarms at all times except while in a valid installer programming section on an LED keypad. The [F] key is used for scrolling through data on LED keypads in the installer programming sections. NOTE: Fire, Auxiliary, and Panic key transmissions follow the partition 1 alarm/restore call direction options (Fire, Auxiliary, and Panic key) NOTE: The Fire, Auxiliary, Panic keys will operate even if Keypad Blanking and Keypad Lockout are active (See Section 5.3 Basic Programming PWS Sect 3 [012]).
		OFF	[F] Key Disabled The [F] key will not sound or report an alarm when pressed.
2	[P] Key Annunciation	ON	[P] Key Audible When a valid [P] key alarm is generated, the Keypad buzzer will sound a series of 3 beeps to acknowledge the alarm. The bell or siren will also sound for the length of Bell timeout. NOTE: Fire, Auxiliary, and Panic key transmissions follow the partition 1 alarm/restore call direction options (Fire, Auxiliary, and Panic key) NOTE: The Fire, Auxiliary, Panic keys will operate even if Keypad Blanking and Keypad Lockout are active (See Section 5.3 Basic Programming PWS Sect 3 [012]).
		OFF	[P] Key Silent When a valid [P] key alarm is generated: the Keypad buzzer and the bell output will remain silent, the alarm transmission will still be transmitted if programmed.
3	Quick Exit	ON	Quick Exit Enabled When the system is armed, users may enter the [*][0] Command to allow a single Delay 1 or Delay 2 Zone to be activated so they may leave the premises. Only one Delay zone may be activated. Additional activity on another Delay zone will initiate its respective alarm sequence. If the Delay zone is still open two minutes after the [*][0] command is entered, the Entry Delay will be initiated. If armed in the Stay mode, the automatic bypass on Stay/Away zones will not be removed.
		OFF	Quick Exit Disabled When the system is armed, users can not perform a quick exit pr pressing [*][0].
4	Quick Arming/Function Key	ON	Quick Arming Enabled/Function Keys Do Not Require Code [*][0] arming and Stay/Away Function Keys may be used to arm the system without the entry of a valid access code. All other function Keys may also be used without the entry of an access code.
		OFF	Quick Arming Disabled/Function Keys Require Code [*][0] arming is not permitted, and all Function Keys require the entry of an access code to activate (including Stay/Away keys). NOTE: This option must be on if less than version 3.0 of the PC5132 is used.
5	Bypass Access Code	ON	Access Code Required to Bypass Zones After entering the [*][1] Bypass Zones Command, an access code must be entered before zones may be bypassed.
		OFF	Access Code Not Required to Bypass Zones Enter [*][1] Bypass Zones Command to bypass zones.
6	Master Code	ON	Master Code Not User Changeable The Master Code (Access Code 40) may not be changed by the user, and may only be programmed in the Installer's Programming Mode.
		OFF	Master Code User-Changeable The Master Code may be programmed by the user using the [*][5][Master Code] command. The Master Code may also be programmed in the Installer's Programming Mode.
7	Telephone Line Monitor	ON	Telephone Line Monitor enabled The TLM function will be active and the system will indicate a Trouble #3 condition when using the [*][2] View Trouble Conditions Command. NOTE: For IMQ-Security certified installations the TLM option shall be enabled.
		OFF	Telephone Line Monitor disabled The TLM function will be shut off and telephone line troubles will not be indicated by the system.

Option	Definition	On/Off	Description
8	Telephone Line Monitor Audible Trouble	ON	TLM Audible When Armed When the system is disarmed, a telephone line monitor trouble will generate a trouble indication as described above. If the system is armed, a telephone line monitor trouble will generate an audible alarm on the bell or siren for the duration programmed for Bell Timeout or until an access code is entered to disarm.
		OFF	TLM Trouble Only A telephone line trouble will generate a trouble indication, the Trouble LED will come ON, and the keypad sounder will beep until a key is pressed.

[016] - Fourth System Option Codes







Option	Definition	On/Off	Description
1	AC Trouble Display	ON	AC Trouble Displayed If AC power fails, the condition will be reported to the monitoring station and will be indicated as a Trouble condition on the system Keypads.
		OFF	AC Trouble Not Displayed If AC power fails, the condition will be reported, but the Trouble light will not be indicated on the system keypads. If [*][2] is entered to view the system troubles, Trouble #2 will still be displayed.
2	AC Trouble Flash	ON	Trouble Light Flashes if AC Fails When AC power is lost from the system, the "Trouble" light will flash in the base "Ready" and "Armed" mode within 30 seconds from after power is lost. When AC restores, the "Trouble" light will stop flashing within 30 seconds. If enabled, this option will override the AC display option.
		OFF	Trouble Light Does Not Flash on AC Fail When AC power is lost from the system, the "Trouble" light will not flash.
3	Keypad Blanking	ON	Blank Keypad When Not Used If no keys are pressed for 30 seconds, all keypad lights except backlighting (if enabled) will be shut OFF until the next keypress, Entry delay, Audible Alarm or keypad buzzer condition. NOTE: Keypad function keys will still operate when the keypad is blank, unless the function key is programmed to require an access code. NOTE: Keypad Blanking While Armed will override this feature.
		OFF	Keypad Always Active The keypad lights will remain ON at all times.
4	Keypad Blanking Restore	ON	Access Code Required to remove Keypad Blanking A valid access code must be entered before a blanked Keypad can be used
		OFF	Access Code Not Required Pressing any key on a blanked keypad will remove the blanking.
5	Keypad Backlighting	ON	Keypad Backlighting is Enabled All keypads on the system will have backlighting on all of the time.
		OFF	Keypad Backlighting is Disabled All keypads on the system will have their backlighting off.
6	Power Save Mode	ON	Power Save Mode Enabled If AC power fails, all keypad lights including backlighting will be shut OFF. The keypad lights will come back ON after a keypress, Entry delay, Audible Alarm or keypad buzzer condition (except Door Chime). The keypad lights will return to the off state after 30 seconds of keypad inactivity.
		OFF	Power Save Mode Disabled If AC power fails, the keypads will not go into power save mode.
7	Bypass Status Display	ON	Bypass Status Displayed While Armed The Bypass status light will be ON if there are zones bypassed when the system is armed.
		OFF	Bypass Status Not Displayed While Armed The Bypass light will be ON only while the system is disarmed to indicate that there are bypassed zones on the system. When the system is armed, the Bypass light will be OFF. NOTE: The Bypass status LED will be ON if there are Stay/Away zones auto bypassed at the time of arming regardless of whether or not this option is enabled. This option only enables and disables manual bypass display.
8	Keypad Tamper	ON	Keypad Tamper are Enabled All keypads containing Tamper switches will generate Tamper Alarms and Restores (Sect 338). NOTE: Not used in North America, ensure that it is disabled.
		OFF	Keypad Tamper are Disabled The Tamper switches on all keypads will not generate Tamper Alarms. NOTE: If this option is used, all keypads should be properly installed and secured (tamper restored) before enabling the option.

[017] - Fifth System Option Codes

Option	Definition	On/Off	Description
1	Wireless Key Disarming	ON	WLS Keys Do Not Use Access Codes The panel will accept the disarm keycode from an unidentified wireless key, allowing arming/disarming without a code. NOTE: This option must be ON when using a PC5132 older than v3.00. NOTE: When using wireless keys with access codes, if you default the PC1616/PC1832/PC1864, you should also default the PC5132 (See Section 5.12 Special Installer Functions [996]).
		OFF	WLS Keys Uses Access Codes The panel will NOT accept the disarm keycode from an unidentified Wireless Key. An Access code must be associated to a WLS key for proper operation.(Refer to the PC5132 manual for information on programming wireless keys.)
2	RF Jam Event Log	ON	RF Jam Log After 5 Minutes The RF Jam Trouble will not log to the event buffer until the 5 minute delay has elapsed.
		OFF	RF Jam Log After 30 Seconds The RF Jam Trouble will log to the event buffer after the initial 30 second delay has elapsed.
3	Audible RF Jam Trouble Beeps	ON	Audible RF Jam Trouble Beeps Keypads will sound trouble beeps when an RF Jam Trouble is detected.
		OFF	An RF Jam will not sound Trouble Beeps Keypads will not sound trouble beeps when an RF Jam Trouble is detected.

Option	Definition	On/Off	Description
6	Cross Zone/Police Code	ON	<p>Cross Zoning is Enabled The panel will use the Cross Zone Attribute for Burglary Verification. This feature requires two or more trips on a zone(s) specified as "cross zones" within a specified time before starting an alarm sequence. See Section [101], Option 9.</p> <p>When a zone with the Cross Zone Attribute Enabled is violated, nothing occurs on the local premises (except Entry Delay or System Event PGM output activation, if applicable) and the Cross Zone Timer commences. If another Zone with the Cross Zone attribute enabled is violated before the timer expires, the panel will transmit the first alarm signal, a Cross Zone event, followed by the second zone alarm, and begins the appropriate local alarm sequence. If no other zones are violated before the timer expires, no alarm sequence occurs and an Alarm Not Verified event is logged. If the Double Hit Feature is enabled (Section [017], Option 4), the panel will react on two violations of the same zone during the Cross Zone Timer (section [176]) for starting an alarm sequence.</p> <p>This option is dependent on the programming of the Burglary Verification Options (Section [018], Option 6). It is not enabled if Police Code is enabled. This option will not function on zones that do not log alarm events (e.g. While disarmed, Day Zone, Instant zone, etc.)</p> <p>NOTE: The Cross Zone/Police Code Timer is in Seconds for Cross Zoning and in Minutes for Police Code.</p> <p>NOTE: No fire zones types should use the Cross Zone Attribute.</p>
		OFF	<p>Police Code is Enabled The panel will use the Police Code feature for Burglary Verification. Each zone has the ability to individually protect the intended area.</p>
7	Exit Delay Restart	ON	<p>One Time Exit Delay Restart on Delay zone re-entry Enabled If a Delay zone is violated and restored during the Exit Delay, it is considered an exit. If a delay zone is violated again it is considered a re-entry. With this option enabled the panel will restart the exit delay. Further violations and restores of delay zones will not restart the exit delay.</p>
		OFF	<p>One Time Exit Delay Restart on Delay zone re-entry Disabled Delay zone violations and restores will not restart the exit delay.</p> <p>NOTE: The exit delay can only be restarted once. This includes restarts from Away function keys.</p>
8	AC Trouble Beeps	ON	<p>AC Trouble Beeps Enabled When an AC trouble occurs on the panel, all keypads will sound an audible trouble indication (2 beeps every 10 seconds)</p>
		OFF	<p>AC Trouble Beeps Disabled AC troubles will remain silent.</p>

[019] - Seventh System Option Codes

Option	Definition	On/Off	Description
1	Audible Wireless Zone Fault while Armed 	ON	<p>Audible Wireless Zone Fault while Armed If a wireless zone fault occurs while armed, the bell will sound for the duration of Bell Time Out. This zone type will only effect zone definitions that are considered armed. This means that Zone types 5 (Interior stay away zone), 6 (delay stay away zone), 32 (Instant stay away zone), 37 (Night Zone) do not generate an alarm when faulted while stay armed. Zone types 9 (24 Hour Supervisory), 12 (24 Hour Hold Up), 26 (24 Hour Non-Alarm) do not generate an audible alarm in any armed state (stay or away).</p>
		OFF	<p>Wireless Zone Fault Does NOT Sound Bell If a wireless zone fault occurs while armed, the bell will not sound.</p>
2	Troubles are Latching 	ON	<p>Troubles are Latching If any trouble occurs on the system, the Trouble LED will be illuminated as normal. If the trouble restores before it is viewed via [*][2], the trouble will 'latch' until it is viewed. The trouble condition restores when the user presses the [#] key viewing the [*][2] trouble menu. It clears the Trouble LED, unless other troubles are present on the system. If the system returns from the [*][2] menu after timing out the Latching Troubles will not be cleared.</p> <p>NOTE: An FTC when using the Residential Dial format should not create a latching trouble.</p>
		OFF	<p>Troubles follow Restore If any trouble occurs on the system, the Trouble LED will be illuminated. The trouble LED will deactivate when the trouble is restored.</p>
3	First Zone in Alarm Displayed 	ON	<p>First Zone in Alarm Enabled When an alarm (or multiple alarms) occur while armed, upon disarming only the first zone that went into alarm will automatically be displayed. Viewing Alarm memory [*][3] will display all zones that were in alarm during the last arm period.</p>
		OFF	<p>First Zone in Alarm Disabled Upon disarming, all zones that went into alarm during the last armed period will be automatically displayed.</p>
4	2nd Line Flash (R-Button) 	ON	<p>2nd Line Flash (R-Button) Enabled If there is no dial tone present on the initial dial tone search, the panel will 'flash' the phone line (go on hook for 90ms) and perform another dial tone search. The panel will then proceed to wait 20 seconds, and perform another five second dial tone search. The panel will then force dial if programmed. This whole sequence counts as one dialing attempt.</p>
		OFF	<p>2nd Line Flash (R-Button) Disabled If there is no dial tone present the panel will not flash the phone line.</p>
5	Keybus Fault Sounds Bell 	ON	<p>Keybus Fault Sounds Bell Keybus, Battery, Bell Circuit and AC Fault conditions will be indicated within 10 seconds after their occurrence. Fault condition of the Keybus will sound the bell. This shall allow the installer to enable/disable the operation of the bell when Keybus fault condition occurs. When this option is enabled, a supervisory trouble from any module will cause the bell to activate.</p> <p>NOTE: The PC52XX will not detect a battery trouble within 10 seconds.</p>
		OFF	<p>Keybus fault does not sound bell A supervisory trouble from any module will not cause the bell to activate.</p>
6	Keypad, Green LED 	ON	<p>Keypad Green LED Option Power Indication The green LED indicator on the keypads will indicate the status of AC on the system.</p>
		OFF	<p>Keypad Green LED Option Ready Indication The green LED indicator on the keypads will indicate the partition ready status.</p>
7	[*][6] Access 	ON	<p>[*][6] Accessible by all users All access codes can be used to enter the [*][6] User Functions menu</p>
		OFF	<p>[*][6] Accessible by Master Code only Only the master code can be used to enter the [*][6] User Functions menu</p>



Option	Definition	On/Off	Description
8	Remote Reset After Second Activation 	ON	Remote Reset After Second Activation Only A remote reset will occur only after a second confirmed alarm, which is generated by the activation of a different zone, or the same zone with double hit enabled. This second activation must tie in with the Burglary verified timer. If this timer expires, then further two activations in different zones will be required before the keypads are locked out. The system will be locked out until a 4 digit Reset code that is provided by the Installer/Central Station is entered on a keypad.
		OFF	Reset Required After One Activation If remote reset is enabled when an Alarm occurs on a burglary zone, the system will be locked out until a 4 digit Reset code that is provided by the Installer/Central Station is entered on a keypad. If the Duress code is used to disarm the partition, then the system will not be locked out. In the Disarmed state, only Audible 24Hr Burglary zones, Audible 24Hr Latching Tamper zones, and Audible 24Hr zone on PGM 2 will cause the panel to be locked out. To get the Reset code from the Installer/Central Station, the end user must provide the Installer/Central Station with the corresponding System Lock code, which will be displayed on the keypad.



[020] - Keypad Zone Assignment

Each keypad has a zone input to which a device (i.e. a door contact) can be connected (see section 2.11 'Keypad Zone/PGM' on page 10 for wiring information).





Once the keypad zones are installed. Enter section [020], there are eight 2 digit entries, representing the zone for keypads in slot 1 to 8. Enter the 2-digit zone designated for each keypad (slot) from 01-64.

[021] - Eighth System Option Codes

Option	Definition	On/Off	Description
1	Access Codes Blocked During Entry Delay 	ON	Access code entry blocked during Entry Delay During entry delay, access codes will not be accepted by the system. Only keyswitches can be used to disarm the system. NOTE: If the system is *9 armed the user will not be able to disarm with a wireless key.
		OFF	Access code entry NOT blocked during Entry Delay An access code can be used to disarm the system during entry delay.
2	EN Entry Delay 	ON	EN Entry Procedure The following zone type alarms will follow bell delay if a zone violation occurs while entry delay is active on the partition: Instant, Interior, Interior Stay/Away, Delay Stay/Away, 24 Hr Supervisory, 24 Hr Buzzer, 24 Hr Burg, 24 Hr Holdup, 24 Hr Gas, 24 Hr Heat, 24 Hr Medical, 24 Hr Panic, 24 Hr Emergency, 24 Hr Sprinkler, 24 Hr Water, 24 Hr Freeze, 24 Hr Latching Tamper, Interior Delay, Day Zone, Instant Stay/Away, 24 Hr Bell/Buzzer, 24 Hr Non-Latching Tamper, Night Zone, Audible 24 Hr PGM Input. The transmission delay attribute must be enabled for all burg type zones when this feature is ON. Transmission delay and bell delay times should be programmed to be longer than entry delay. When entry delay ends, the bell delay will be cleared and the siren will activate. Any burg type zone will follow transmission delay when the zone alarm occurred during the Entry Delay. When entry delay expires, the control panel will delay the communication of the alarm for an additional 30 seconds to allow the user time to disarm before the signal is sent. The police code or burglary verified timer will not begin until the additional 30 second transmission delay has expired without a valid disarming procedure. If a zone violation occurs but entry delay is not active the bell will sound and the alarm will be communicated immediately depending on the zone type tripped. NOTE: The transmission delay attribute must be enabled for all burg type zones when this feature is on. NOTE: Transmission delay and bell delay times should be programmed to be longer than entry delay.
		OFF	Standard Entry Delay If bell delay is activated, an alarm from a burg type zone will follow bell delay regardless of entry delay being active. If transmission delay is activated, the communication of an alarm from a zone with the tx delay attribute enabled will be delayed regardless of entry delay being active.
3	Keypad Blanking Timing Options 	ON	5-second Keypad Blanking. The panel will turn off all lights and LCDs on the keypads if no key is pressed for 5 seconds when the Keypad Blanking Option is on. See option 3 Section [016].
		OFF	30-second Keypad Blanking. The panel will turn off all lights and LCDs on the keypads if no key is pressed for 30 seconds when the Keypad Blanking Option is on - Option 3 Programming Section [016].

Option	Definition	On/Off	Description																																																																																																																														
4	Remote Reset 	ON	<p>Remote Reset Enabled. The purpose of this feature is to force the end user to contact the Installer/Central Station whenever they have an alarm condition. This is accomplished by locking out the panel after an alarm occurs, which will force the end user to call the Installer/Central Station to get a Reset code which must be entered on the keypad before they will be able to use their system.</p> <p>In the Armed state, when an Alarm occurs on a burglary zone (please refer to chart below), the system will be locked out after disarming the panel. The panel will remain locked until a 4 digit Reset code that is provided by the Installer/Central Station is entered on a keypad. If the Duress code is used to disarm the partition, then the system will not be locked out. In the Disarmed state, only Audible 24Hr Burglary zones, Audible 24Hr Latching Tamper zones, and Audible 24Hr zone on PGM 2 will cause the panel to be locked out. To get the Reset code from the Installer/Central Station, the end user must provide the Installer/Central Station with the corresponding System Lock code, displayed on the keypad.</p> <p>The System Lock code will be randomly generated and displayed on the keypad after an alarm condition when one of the following conditions occurs:</p> <ul style="list-style-type: none"> the system has been disarmed (Duress Code excluded) the bell has timed out (24Hr zones - please see chart below) an access code has been entered (24Hr zones - please see chart below) <p>On a LCD keypad, the message "REMOTE RESET RQD" will be displayed on the top line and "CODE" along with the actually code will be displayed across the bottom line.</p> <p>On an LED keypad, the reset number will be scrolled across the keypad. Each digit will be displayed one at a time for 1 second with a pause of 1 second between digits. There will be a 3 second pause after the last digit of the System Lock code before the System Lock code is repeated. This routine will continue until the Unlock code (from Installer/Central Station) is entered.</p> <p>NOTE: While the system is locked out, the only options available are [*][3], [*][6], [*][7], and [*][8]. Going into [*][8] Installers Programming while the panel is locked out will unlock the panel. The system will continue to function properly (alarms, tampers, etc) while the system is locked out. This feature will follow the Keypad Lockout. If the Duress Code is used to disarm the system, the system will not be locked out. Silent 24Hr zone on PGM 2 will not Lock out the panel. Lock out will follow both the Transmission and Bell Delays.</p> <table border="1"> <thead> <tr> <th>Zone Definition</th> <th>Armed</th> <th>Disarmed</th> <th>Zone Definition</th> <th>Armed</th> <th>Disarmed</th> </tr> </thead> <tbody> <tr> <td>00 Null Zone (Not Used)</td> <td></td> <td></td> <td>20 24 Hour Freeze</td> <td></td> <td></td> </tr> <tr> <td>01 Delay 1</td> <td>Lock</td> <td></td> <td>21 24 Hour Latching Tamper</td> <td>Lock</td> <td>Lock *</td> </tr> <tr> <td>02 Delay 2</td> <td>Lock</td> <td></td> <td>22 Momentary Keyswitch Arm</td> <td></td> <td></td> </tr> <tr> <td>03 Instant</td> <td>Lock</td> <td></td> <td>23 Maintained Keyswitch Arm</td> <td></td> <td></td> </tr> <tr> <td>04 Interior</td> <td>Lock</td> <td></td> <td>24 Not Used</td> <td></td> <td></td> </tr> <tr> <td>05 Interior Stay/Away</td> <td>Lock</td> <td></td> <td>25 Interior Delay</td> <td>Lock</td> <td></td> </tr> <tr> <td>06 Delay Stay/Away</td> <td>Lock</td> <td></td> <td>26 24-Hr Non-Alarm</td> <td></td> <td></td> </tr> <tr> <td>07 Delayed 24-Hr Fire</td> <td></td> <td></td> <td>27 Delayed 24Hr Waterflow</td> <td></td> <td></td> </tr> <tr> <td>08 Standard 24-Hr Fire</td> <td></td> <td></td> <td>28 Instant Waterflow</td> <td></td> <td></td> </tr> <tr> <td>09 24-Hr Supervisory</td> <td>Lock</td> <td></td> <td>29 Auto Verify Fire</td> <td></td> <td></td> </tr> <tr> <td>10 24-Hr Supervisory Buzzer</td> <td></td> <td></td> <td>30 Fire Supervisory</td> <td></td> <td></td> </tr> <tr> <td>11 24-Hr Burg</td> <td>Lock</td> <td>Lock *</td> <td>31 Day Zone</td> <td>Lock</td> <td></td> </tr> <tr> <td>12 24-Hr Holdup</td> <td></td> <td></td> <td>32 Instant, Stay-Away</td> <td></td> <td></td> </tr> <tr> <td>13 24-Hr Gas</td> <td></td> <td></td> <td>33 Push to Set Zone</td> <td></td> <td></td> </tr> <tr> <td>14 24-Hr Heat</td> <td></td> <td></td> <td>34 Final Door Set</td> <td>Lock</td> <td></td> </tr> <tr> <td>15 24-Hr Medical</td> <td></td> <td></td> <td>35 24Hr Bell/Buzzer</td> <td>Lock</td> <td></td> </tr> <tr> <td>16 24-Hr Panic</td> <td></td> <td></td> <td>36 24 Hour Non-Latching Tamper</td> <td></td> <td></td> </tr> <tr> <td>17 24-Hr Emergency</td> <td></td> <td></td> <td>37 Night Zone</td> <td>Lock</td> <td></td> </tr> <tr> <td>18 24-Hr Sprinkler</td> <td></td> <td></td> <td>87 Delayed 24 Hour Fire (Wireless)</td> <td></td> <td></td> </tr> <tr> <td>19 24-Hr Waterflow</td> <td></td> <td></td> <td>88 Standard 24 Hour Fire (Wireless)</td> <td></td> <td></td> </tr> </tbody> </table> <p>* These zones will lock out the system only if the zone is audible.</p>	Zone Definition	Armed	Disarmed	Zone Definition	Armed	Disarmed	00 Null Zone (Not Used)			20 24 Hour Freeze			01 Delay 1	Lock		21 24 Hour Latching Tamper	Lock	Lock *	02 Delay 2	Lock		22 Momentary Keyswitch Arm			03 Instant	Lock		23 Maintained Keyswitch Arm			04 Interior	Lock		24 Not Used			05 Interior Stay/Away	Lock		25 Interior Delay	Lock		06 Delay Stay/Away	Lock		26 24-Hr Non-Alarm			07 Delayed 24-Hr Fire			27 Delayed 24Hr Waterflow			08 Standard 24-Hr Fire			28 Instant Waterflow			09 24-Hr Supervisory	Lock		29 Auto Verify Fire			10 24-Hr Supervisory Buzzer			30 Fire Supervisory			11 24-Hr Burg	Lock	Lock *	31 Day Zone	Lock		12 24-Hr Holdup			32 Instant, Stay-Away			13 24-Hr Gas			33 Push to Set Zone			14 24-Hr Heat			34 Final Door Set	Lock		15 24-Hr Medical			35 24Hr Bell/Buzzer	Lock		16 24-Hr Panic			36 24 Hour Non-Latching Tamper			17 24-Hr Emergency			37 Night Zone	Lock		18 24-Hr Sprinkler			87 Delayed 24 Hour Fire (Wireless)			19 24-Hr Waterflow			88 Standard 24 Hour Fire (Wireless)		
		Zone Definition	Armed	Disarmed	Zone Definition	Armed	Disarmed																																																																																																																										
00 Null Zone (Not Used)			20 24 Hour Freeze																																																																																																																														
01 Delay 1	Lock		21 24 Hour Latching Tamper	Lock	Lock *																																																																																																																												
02 Delay 2	Lock		22 Momentary Keyswitch Arm																																																																																																																														
03 Instant	Lock		23 Maintained Keyswitch Arm																																																																																																																														
04 Interior	Lock		24 Not Used																																																																																																																														
05 Interior Stay/Away	Lock		25 Interior Delay	Lock																																																																																																																													
06 Delay Stay/Away	Lock		26 24-Hr Non-Alarm																																																																																																																														
07 Delayed 24-Hr Fire			27 Delayed 24Hr Waterflow																																																																																																																														
08 Standard 24-Hr Fire			28 Instant Waterflow																																																																																																																														
09 24-Hr Supervisory	Lock		29 Auto Verify Fire																																																																																																																														
10 24-Hr Supervisory Buzzer			30 Fire Supervisory																																																																																																																														
11 24-Hr Burg	Lock	Lock *	31 Day Zone	Lock																																																																																																																													
12 24-Hr Holdup			32 Instant, Stay-Away																																																																																																																														
13 24-Hr Gas			33 Push to Set Zone																																																																																																																														
14 24-Hr Heat			34 Final Door Set	Lock																																																																																																																													
15 24-Hr Medical			35 24Hr Bell/Buzzer	Lock																																																																																																																													
16 24-Hr Panic			36 24 Hour Non-Latching Tamper																																																																																																																														
17 24-Hr Emergency			37 Night Zone	Lock																																																																																																																													
18 24-Hr Sprinkler			87 Delayed 24 Hour Fire (Wireless)																																																																																																																														
19 24-Hr Waterflow			88 Standard 24 Hour Fire (Wireless)																																																																																																																														
		OFF	Remote Reset Disabled The system will not be locked out after an alarm occurs.																																																																																																																														
5	Engineer's Reset 	ON	Engineer's Reset Enabled If the panel has gone into alarm during the previous armed period, or if a 24 Hour alarm has occurred (armed or disarmed), the system will not be ready to arm (Ready Light OFF) until the Installers Programming is entered or Engineer's Reset is performed via Downloading Software. This feature applies to Tampers and Faults in both Armed and Disarmed states and does not apply to Module Tampers, System Supervisories, Zone Expander alarms or PGM2 Input Alarms.																																																																																																																														
		OFF	Engineer's Reset Disabled If the panel has gone into alarm during the previous armed period, or if a 24 Hour alarm has occurred (armed or disarmed), the system will be ready to arm.																																																																																																																														
6	Disarming (WLS Key) 	ON	Keyswitch Disarming During Entry Delay Only All key-switches and Wireless Keys on the system will only disarm the panel if an entry delay is active.																																																																																																																														
		OFF	No Entry Delay for Keyswitch Disarm All key-switches and Wireless Keys will disarm regardless if entry delay is active or not.																																																																																																																														
7	Installer Access Requires DLS window 	ON	Installer Access follows DLS window Access to Installers programming requires the DLS window to be opened up in order to access installers. Enable DLS window by entering [*][6][Access Code][5]. NOTE: For this feature to work section 401 option 2 must be enabled.																																																																																																																														
		OFF	Installers can be accessed at any time Installers programming can be accessed at any time.																																																																																																																														
8	Arming Inhibit 	ON	Arming Inhibit for All Troubles When there is a trouble present on the system arming will be inhibited, until the trouble is restored.																																																																																																																														
		OFF	Troubles do not Inhibit Arming The system can be armed even when there is a trouble present.																																																																																																																														

[022] - Ninth System Option Codes

Option	Definition	On/Off	Description
1	Access Code Required for [*][1], [*][2], [*][3] 	ON	Access code is required for [*][1], [*][2] and [*][3] menu options In order to access the [*][1] bypass menu, [*][2] trouble menu, or [*][3] alarm memory menu a valid access code is required. Events will also be generated and logged, thus identifying the user. NOTE: You must have a version LCD5500 3.40U or greater keypad, PK55XX or RFK55XX Keypad. NOTE: This feature is not supported by the PC5400.
		OFF	No access code required for [*][1], [*][2], [*][3] menu options No access code is required In order to access the [*][1] bypass menu, [*][2] trouble menu, or [*][3] alarm memory menu.
2	Keypad Blanking while Armed 	ON	Keypad Blanking while Armed Keypad will blank after the programmed time (Section [021], Option 3) when the system is armed. NOTE: This feature will only blank after exit delay has expired.
		OFF	Keypad follow regular blanking option Keypad will blank after the programmed time (Section [021], Option 3) when the system is armed or disarmed.
3	Auto-Arming/Force Arming Open Zones	ON	Auto-Arming/Force Arming Open Zones All zones will be force armed during an autoarm regardless of the force arm attribute on the zone.
		OFF	Auto Arming follows Force Arming Attribute Only zones with the force arm attribute enabled will be force armed during an autoarm.
4	Master Code Bypasses Holdup 	ON	Master code bypasses holdup zones only Attempting to bypass a hold-up zone with any other access code will generate error tone.
		OFF	Any code can bypass hold up zones Any code can bypass Hold up zones
5	Time Limit for PGM 05, 06, 17, 18 	ON	Time Limit Enabled for PGM 05, 06, 17, 18 Setting Keypad Blanking Option ON - Option 5 Programming Section [022] - may satisfy this requirement. The panel will turn off all lights and LCDs on the keypads if no key is pressed for 30 or for 5 seconds – depending on the status of toggle option 3 in Programming Section [021] irrespectively of the armed or disarmed state of the Intruder alarm system. Implementation of the option 3 in Programming Section [021] shall allow the installer to enable/disable the 5 seconds time limit for Programmable Output Options 05 (Armed Status), 06 (Ready to Arm), 17 (Away Armed Status) and 18 (Stay Armed Status).
		OFF	Time Limit Disabled for PGM 05, 06, 17, 18 Listed PGM's will not turn off (time out)
6	RF Delinquency Enable	ON	RF Delinquency Enabled If any wireless zone supervisory transmission is not received by the PC5132 during a 15-minute period, the PC5132 will place the panel into Not Ready To Arm mode. In the armed state, the Zone faults will generate tamper alarms. The panel will generate a silent trouble (NO trouble beeps but the Trouble LED is turned ON) called "RF Device Delinquency", that's only viewable in [*][2] (Trouble Memory). The user can override the condition and arm the panel by using the feature.
		OFF	RF Delinquency Disabled The system will not indicate an RF Delinquency when a zone supervisory transmission is not received during a 15 minute period.
7	Open Zones Cancel Arming 	ON	Open Zones Cancel Arming If there is an open zone at the end of exit delay, arming of the system will be canceled.
		OFF	Open Zones Cancel Arming Disabled If there is an open zone at the end of exit delay the system will arm with the zone open.
8	Audible Exit Delay for Stay Arming	ON	Audible Exit Delay for Stay Arming When the system is armed in Stay mode the exit delay will be sounded by 1 beep every 3 seconds.
		OFF	Stay Arming is Silent When the system is armed in Stay mode the exit delay will be silent.

[023] - Tenth System Option Codes

Option	Definition	On/Off	Description
1	[F] Key Beeps	ON	[F] Key Beeps Only Whenever the [F] is pressed you will only get the acknowledge beeps from the keypad. The bell will not sound.
		OFF	[F] Key Beeps and Sounds Bell [F] key will beep the keypad and trigger the bell output
2	200 Baud Open/Close Identifier Toggle ON/OFF	ON	200 Baud Open/Close Identifier Toggle ON 200 Baud Open Close Identifier is 2 for arming 1 for disarming
		OFF	200 Baud Open/Close Identifier Toggle OFF 200 Baud Open Close Identifier is 1 for arming 2 for disarming
3	Test Transmission While Armed Only	ON	Test Transmission While Armed Only The Panel will send a test transmission at the programmed interval and time if the system is armed.
		OFF	Test Transmission While Armed or Disarmed The Panel will always send a test transmission at the programmed interval and time.
4	Transmission Counter	ON	Transmission Counter in Hours The Panel will send a test transmission after the programmed number of hours in the test transmission cycle (Section [377], Option 7)
		OFF	Transmission Counter in Days The Panel will send a test transmission after the number of days programmed in the test transmission cycle (Section [377], Option 7) at the programmed time.
5	Stay/Away Toggle Option	ON	Switching from Away to Stay Disabled The system can not be switched from Away to Stay mode by pressing the [Stay] function key.
		OFF	Away to Stay Toggle Option Permitted The system can be switched from Away to Stay mode by pressing the [Stay] Function key.
6	2-way Audio Disconnect	ON	2-way Audio Will Not Disconnect For New Event The system will not disconnect the 2-way audio session if a new event occurs on the system.
		OFF	2-way Audio Will Disconnect For a New Event The system will disconnect the 2-way audio session if a new event occurs on the system.

Option	Definition	On/Off	Description
7	Trouble Beeps Silent	ON	Trouble Beeps are Silent When a trouble is detected on the system, trouble beeps will not be sounded at the keypad.
		OFF	Trouble Beeps will Sound Every 10 Seconds When a trouble is detected on the system, trouble beeps will be sounded at the keypad. NOTE: This option must be OFF for UL Residential Fire Applications
8	For Future Use		

[030] - Fast Loop Response

An eight bit toggle option controls which main board zones have Fast Loop Response (36ms) or Normal Loop Response (540ms, 400ms for IMQ certified installations. Fast loop response is typically used for vibration sensors.

5.3 Advanced Programming

[101]-[164] - Zone Attributes

The two sets of attributes (1-8 and 9-16) may be toggled by pressing '9' within any zone's attribute section. If the Ready LED is on, the keypad is indicating Zone Attributes 1-8; if the Ready and Armed LED's are on, the keypad is indicating Zone Attributes 9-16 The following options can be enabled or disabled by zone.

NOTE: DO NOT change Fire Zones attributes from the default settings.

Option	Definition	On/Off	Description
1	Bell	ON	Bell Audible An alarm on this zone will cause the bell output to activate.
		OFF	Bell Silent An alarm on this zone will not activate the bell output.
2	Bell Type	ON	Bell Steady The bell output will be steady when the zone is in alarm.
		OFF	Bell Pulsed The bell output will pulse when the zone is in alarm.
3	Chime	ON	Chime Enabled Every keypad will chime when the zone is violated and when the zone is secured. Door Chime will work in both the armed and disarmed states.
		OFF	Chime Disabled The zone will not chime the keypads.
4	Bypass	ON	Bypass Enabled The zone may be manually bypassed from the [*][1] Bypass Menu.
		OFF	Bypass Disabled The zone cannot be bypassed.
5	Force Arming	ON	Force Arm Enabled The system (partition) may be armed with the zone violated. The zone will be temporarily bypassed, and when the zone is secured it will be added back into the system.
		OFF	Force Arm Disabled The system cannot be armed if this zone is open.
6	Swinger Shutdown	ON	Swinger Shutdown Enabled The zone will shut down after a programmed number of alarms, inhibiting further transmissions to the monitoring station. The bell can follow Swinger Shutdown if programmed.
		OFF	Swinger Shutdown Disabled The zone will not go into swinger shutdown after the programmed number of alarms.
7	Transmission Delay	ON	Transmission Delay Enabled The reporting of zone alarms will be delayed for the programmed time. If a valid access code is entered within this time, no alarm signal will be communicated.
		OFF	Transmission Delay Disabled When an alarm occurs, the reporting code is transmitted immediately. NOTE: Transmission Delay cannot be used on fire zones.
8	Wireless	ON	Zone is Wireless The zone will ignore the main board zone (if applicable) and respond to the corresponding zone enrolled on the PC5132.
		OFF	Zone is Hardwired The zone uses the corresponding hardwired zone.
9	Cross Zone	ON	Zone is a Cross Zone Zone is enabled for Cross Zoning.
		OFF	Zone is not a Cross Zone Zone is not enabled for Cross Zoning.

[165] - Maximum Dialing Attempts

This value represents the number of attempts that will be made to each telephone number when communicating. The default value is 005. Valid entries are 001-005.

NOTE: The PC1616/PC1832/PC1864 will not allow more than 5 dialing attempts to a single phone number. If a value higher than 5 is programmed in Section [165], the panel will still only dial 5 attempts.

NOTE: For UL Listed Installations 5-10 Dialing attempts are required.

[166] - Post Dial Wait For Handshake

This value represents the time the communicator waits for a valid initial handshake from the receiver after dialing the programmed telephone number. The default value is 040 seconds.

[167] - T-Link Communications Wait for Acknowledge Delay

This value represents the time the communicator waits for an acknowledge after transmitting a SIA communications packet via the T-Link. The default is 20 seconds.

[168]-[169] - Daylight Saving Time

Daylight Saving Time can be programmed to adjust the time by 1 or 2 hours (back/forward) at an exact date and time (**Example 1**, March 5, 2006, 2:00am) **OR** on a specific weekday of a specific month (**Example 2**, 1st Sunday in March, 2:00am). See example date & time entries below.

- Enter Programming Section [017], set Option [6] 'Daylight Saving Enabled' to On.
- Enter Programming Section [168] when setting the clock forward
- Enter Programming Section [169] when setting the clock back.

Example 1: March 5th, 2006, 2:00am

Opt	Ex. 1	
1	003	Month valid entries 001-012 (003 for March)
2	000	Week valid entry is 000 (to program a specific date and time)
3	005	Day valid entries are 001-031 (005 for the 5th of the month)
4	002	Hour valid entries are 000-023 (time of day to set clock forward or back, 2:00am)
5	001	Interval valid entries are 001-002 (1 hour ahead or back)

Example 2 : 1st Sunday in March, 2:00am

Opt	Ex. 2	
1	003	Month valid entries 001-012
2	001	Week valid entries are 001-005 (001 for the first week)
3	000	Day valid entries are 000-006 (Sunday to Saturday, 000 for Sunday)
4	002	Hour valid entries are 000-023 (time of day to set clock forward or back, 2:00am)
5	001	Interval valid entries are 001-002 (1 hour ahead or back)

[170] - PGM Output Timer

This value represents the period of time (in seconds) that a PGM will activate if programmed to follow the PGM Timer. The default value is 005 seconds. Valid entries are 001-255.

NOTE: This option does not affect outputs programmed as Sensor Reset (Type 03).

NOTE: If a System Event PGM is programmed to follow the Command Output Timer, all attributes must be enabled.

[171] - Tamper PGM Output Timer



This value represents the time (in minutes) that a tamper condition will latch the Tamper PGM Output. If programmed as [000], it will follow the tamper condition. The default value is 004 minutes. Valid entries are 001-255 minutes.

NOTE: This timer can be cancelled by entering a valid access code on the keypad.

[172] - Settle Delay Timer



This feature provides a programmable delay and the end of infinite exit delay, to allow the devices violated along the entry/exit route to restore.

[173] - Bell Delay Timer



The Bell Delay Timer determines how long the bell will be delayed after an alarm event. Valid entries are 000-255 where 000 disables this feature.

NOTE: If a TLM Trouble begins before the Bell Delay is initiated, the Bell Delay will be cancelled. If a TLM Trouble occurs when the system is armed and an alarm condition with Bell Delay active, the Bell Delay will be cancelled and the bell will sound.

[175] - Auto-arm Postpone Timer

This feature controls the sequence of events after a valid access code is entered during the Auto-arm Pre-alert. If the Auto-arm Postpone Timer is programmed as 000, the Auto-arm will be cancelled. If a value between 001 and 255 is programmed, then the Auto-arm will be 'postponed' for the corresponding number of minutes and the panel will resume normal operation. The panel will also log the appropriate "user log" for the access code which postponed the arming.

When the postpone time expires, the panel Auto-arm Pre-alert will be re-initiated (unless the partition is armed). The Auto-arm may be postponed multiple times. If the Auto-arm is postponed, arming or disarming the panel will not affect the postpone sequence.

[176] - Cross Zone/Police Code Timer

This option affects the Cross Zone Police Code log and transmission as well as the Cross Zone Feature.

When a zone trip occurs, the Cross Zone Timer starts. This timer affects the panel in two different ways depending on the programming of the Burglary Verification Options (Section [018], Option 6):

- If the Police Code Feature is being used, the first zone alarm will immediately transmit. If a second zone alarm occurs in the time period (minutes) programmed in this section, the panel will log and transmit the Police Code event. If the second zone alarm occurs after this timer expires, the Police Code will not be logged or transmitted, and the timer will restart.
- If the new Cross Zone Attribute is used, the first zone alarm will not log or transmit. If a second zone is violated within the Cross Zone Timer's (seconds) duration, the panel will go into the appropriate alarm sequence and will communicate both zone alarms. No Police Code is sent.

NOTE: If 000 is programmed in this section, either: The Police Code will transmit for any two different zone alarms during an armed-to-armed period or the new Cross Zoning feature will not work. This is not a valid entry for Cross Zoning.

NOTE: Option[9], Section [101]-[164] must be enabled for the Cross Zoning feature to function. Each zone has the ability to individually protect the intended area. Cross Zoning is NOT recommended for line security installations or on exit/entry zones.

Automatic Bypass at End of Confirmation Window

If any zone is still violated at the end of the Police Code timer, it must be omitted from the system or bypassed, and a transmission using SIA Automatic will be sent to the central station alerting them of the condition. The police code/burglary verified timer must begin for this functionality to work.

If the omitted zone is an entry/exit point (final door set, delay 1/2) then PIR type zones (i.e. - Delay Stay/Away, Interior Stay/Away, Instant Stay/Away, Interior Delay, and Interior) must provide entry delay to replace them.

If the panel is armed in away mode and the entry/exit point is auto-bypassed during away arming, the PIR type zones must provide entry delay (delay 1 time).

[178] - For Future Use

[181]-[188] - Auto-arm Schedules

Sections [181] through [188] allow the Installer to program auto-arm times for partitions one through eight. Each section has seven independent times of the day that the selected Partition will arm when Auto-arm is enabled. The seven entries represent the seven days of the week from Sunday to Saturday.

NOTE: Valid entries are 0000-2359 hrs; 9999 to disable.

In addition to these schedules, partitions can be enabled or disabled in [*][6] programming. This is controlled by Option 2 in Section [017].

[190] - No Activity Arming Pre-Alert Duration

This is the duration for which the No Activity Arming Pre-alert will sound when the No-Activity Timer for the partition expires (see Section [191]-[198]). If programmed as 000, the Partition will arm as soon as its No-Activity timer expires. This feature enables the system (or partition) to arm if there is no zone activity for a programmed time period. If the **No Activity Arm** option for a partition is programmed with a

number other than 000, the partition will Auto-arm if no activity is detected for the programmed number of minutes.

[191]-[198] - No-Activity Timer (Partition 1-8)

The timer will begin when a delay type zone assigned to the partition is restored. The timer is stopped if any zone assigned to the partition is tripped or restored. The timer will restart when a delay type zone is again restored. When the timer expires, the panel will sound the buzzers of all keypads assigned to the Partition for the time programmed in Section [190]. If any key is pressed or zone is violated/restored on that Partition, the Auto-arm pre-alert will be aborted. For zone types 04, 05, 06, and 25, restores will not affect No Activity Arming. A partition begins its Auto-arm sequence when its No-Activity Timer expires. If 000 is programmed in a section, No-Activity Arming for that partition is disabled. Valid entries are 000 - 255 minutes, with a default of 001. The system will not arm if it is in OFF normal state.

[199] - Auto-arming Pre-Alert Time

This section allows programming of the standard Auto-arm Pre-alert Duration. If auto-arm is postponed this timer will restart after the auto-arm postpone timer expires. Valid entries are from 001 - 255 minutes, the default is 005.

NOTE: There is no differentiation between the No-Activity Pre-alert and the Standard Auto-arm Pre-alert at a keypad. No Activity Arming and Auto-arm will log and transmit as a Special Closing.

5.4 Partition & Zone Programming

[201] - Partition Selection Mask

This selection allows the programming of which partitions will be active on the system.

[202]-[265] - Partition Zone Assignments

Partitions and Zone Assignment

A partition is a limited area of the premises which will operate independently of another area of the premises. You can create up to eight partitions on the PC1616/PC1832/PC1864 system.

To set up the system for more than one partition, you must turn on each partition in section [201].

You can assign any zone to any of the partitions. **Global Zones** are zones assigned to more than one partition. A global zone will only be armed when all assigned partitions are armed. The zone will be disarmed when any assigned partition is disarmed.

By default, zones 1 through 8 are assigned to partition 1. If additional zones are being used, or if the application requires more than one partition, you must program which zones are assigned to which partitions. You can do this in programming sections [202] - [265].

NOTE: You can assign any Access Code to work on any of the partitions (see section '[*][5] Programming Access Codes').

You can assign keypads to work on either a single partition, or on all partitions (Global operation). See Section 2 Keypad Assignment.

Each partition can be programmed to report using a different Account Number.

Some of the Programmable Output options are also selectable by partition. See Section 5 Programmable Outputs

Partition 1 - 8 Enabled/Disabled Section [201]

Partition 1 Zone Assignments	Sections [202] to [209]
Partition 2 Zone Assignments	Sections [210] to [217]
Partition 3 Zone Assignments	Sections [218] to [225]
Partition 4 Zone Assignments	Sections [226] to [233]
Partition 5 Zone Assignments	Sections [234] to [241]
Partition 6 Zone Assignments	Sections [242] to [249]
Partition 7 Zone Assignments	Sections [250] to [257]
Partition 8 Zone Assignments	Sections [258] to [265]

These eight bit toggle sections determines which partitions each individual zone is assigned to. If a zone is enabled on any partition, it will be supervised via the panel's EOL supervision, and will operate according to the zone type programmed. If a zone is not assigned to any partition, it will not be supervised and all activity on the zone will be ignored by the panel.

5.5 Communicator Programming

Communicator - Telephone Numbers

The panel can call 3 different telephone numbers for communication to central station. The **1st telephone Number** is the primary number, the **2nd telephone Number** is the secondary number and the **3rd telephone Number** will back up the 1st telephone number if enabled.

NOTE: The 3rd telephone number will NOT back up the 2nd telephone Number.

If Alternate Dial is enabled the panel will alternate between the 1st and 3rd telephone numbers when attempting to call the central station. If disabled the panel will only attempt to call the 3rd telephone number after failing to communicate on the 1st telephone number.

NOTE: For Alternate Dial to work properly the 3rd telephone Number must be both enabled and programmed.

Telephone numbers can be up to 32 digits which will allow you to add special digits if required. To program the telephone number enter numbers 0 through 9 as required.

To communicate events over a LAN or WAN network using the T-Link module, program the desired phone number with DCAA. This allows the panel to send events to the T-Link module in the SIA format via the PC-Link connection. Pressing [#] in these sections from an LED keypad will exit and delete the rest of the phone number. Pressing [#] in these sections from an LCD keypad will exit and save the entire phone number up to the first Hex F.

The following is a list of HEX digits which can also be programmed and the functions they perform:

- HEX (A) - not used
- HEX (B) - simulates the [*] key on a touch tone telephone
- HEX (C) - simulates the [#] key on a touch tone telephone
- HEX (D) - forces the panel to search for dial tone
- HEX (E) - forces the panel to pause for 2 seconds
- HEX (F) - end of telephone number marker

3rd telephone Number Enable	Section [380], Option [5]
Alternate Dial	Section [380], Option [6]
Downloading Options	(Section 7: PWS)

[301] - First Telephone Number

[302] - Second Telephone Number

[303] - Third Telephone Number

NOTE: There is a static delay of 2 seconds before any additional dial tone search in a phone number.

NOTE: The panel will not attempt to communicate, if no phone number is programmed. This applies to Phone Numbers 1, 2 and 3.

[304] - Call Waiting Cancel Dialing String

This is a 6 digit Hex entry that is used to disable Call Waiting on a Call Waiting equipped phone line. This is typically [*][7][0] in most areas. Dialing this string before a phone number will disable Call Waiting for the duration of the call. If this section is programmed (not FF), and Section 382, Option 4 is ON, the panel will dial this string in place of the first digit of the phone number (Sections [301]-[303]). This only applies to the first attempt that is made to each phone number.

NOTE: If not all 6 digits are required they should be filled with Hex F.

All 6 digits of this section need to be programmed in order for any changes to be accepted.

Communicator - Account Codes

The System Account Code [310] will be used by the panel when communicating System events (e.g. Low Battery, Test Transmission). This account code can be up to six digits in length for the SIA Communications format. Only the SIA reporting format supports six-digit account codes.

NOTE: *If the communicator is programmed for the SIA reporting format, the system will use this account code for all partitions.*

There are eight **Partition Identifier Codes** [311] to [318] (or Account Codes) programmable, one for each partition. The Account Code is used by central station to determine which panel is calling.

If you have programmed the system for more than one partition, you must program an account code for each active partition. The panel will report to the central station by partition. For example, if an alarm occurs on a zone assigned to Partition 1 the panel will report using Partition 1 account code.

If using CESA format, the first digit of the partition account code will automatically be 0. This value cannot be changed.

[310] - System Account Code

This is the Account Code used by the panel when communicating System events (i.e. Low Battery, Test Transmission, etc.).

This account code can be up to six digits in length for the SIA Communications format.

Only SIA supports six digit account codes. If the last two digits of the account code are FF, the panel will only use the first four digits.

The call directions that use this Account Code are System Maintenance (Troubles, Zone Faults, etc.) and System Test Transmissions.

NOTE: *SIA will use this account code for all Partitions and System Events! System events will be identified by Nri0, with Partitions 1-8 using Nri1-8.*

[311]-[318] - Partition 1-8 Account Codes

These Account Codes are used by the panel when communicating events for Partitions 1-8 when using formats other than SIA.

NOTE: *All partition account codes are 4 digits in length. Valid entries are 0000-FFFE.*

Reporting Codes

Communicator - Reporting Codes

Unless you are using Automatic Contact ID or Automatic SIA formats, reporting codes must be programmed in order for the panel to report events to the central station.

Reporting codes are two digits and can use hexadecimal digits A through F. To disable a reporting code, program it as "FF" (default setting) or "00". For a complete description of reporting codes which can be programmed and lists of automatic Contact ID and SIA format codes, see section Appendix A: 'Reporting Codes' on page 56.

[320]-[323] - Alarm Reporting Codes, Zones 1 to 64

The panel will transmit the Zone Alarm Reporting Code for a zone when the zone goes into alarm. 24-hour type zones will go into alarm whether the panel is armed or disarmed and report to the central station. All other zone types will only go into alarm if the panel is armed.

Reporting codes can be one or two digits and can use HEX digits (A through F). The following is a description of the different reporting codes that can be programmed and when the events will be reported to central station.

[324]-[327] - Alarm Restoral Reporting Codes, Zones 1 to 64

If the Restoral on Bell Timeout option is selected the panel will send the Zone Restoral Reporting Code for the zone when the alarm output times out AND the zone is secure. If the zone is not secured when the alarm output times out the panel will send the restoral immediately after the zone is secured.

If the **Restoral on Bell Timeout** option is not selected the panel will immediately send the Zone Restoral Reporting Code when the zone is secured or when the panel is disarmed, regardless if the alarm output is active or not.

NOTE: *24-hr type zones will report the restoral immediately after the zone is secured.*

[328] - Miscellaneous Alarm Reporting Codes

Duress Alarm: this reporting code will be transmitted to the monitoring station whenever a Duress code is used to perform any function on the system.

Opening After Alarm: this reporting code will be transmitted to the monitoring station on Opening if an alarm has occurred during the previous armed period.

Recent Closing: a Recent Closing transmission shall be sent if an alarm occurs within 2 minutes of an exit time expiration.

The Recent Closing report will be sent for the first alarm only.

Zone Expander Supervisory Alarm: this reporting code is sent when the system loses communications with any zone Expander Module (PC5108, PC5132, or Keypad with on-board zone).

Zone Expander Supervisory Restoral: this reporting code is sent when the system regains communications with all zone Expander Module (PC5108, PC5132, or Keypad with on-board zone) that have been enrolled on the system.

Cross Zone/Police Code Alarm: When using Cross Zoning (Section 018, Option 6 ON), this reporting code will be sent when two 'crossed' zones go into alarm during the Cross Zone period.

When using Police Code (Section 018, Option 6 OFF), this reporting code will be sent when any two zones go into alarm.

If the **Double Hit** option has been enabled, this reporting code will be sent when two zone alarms occur on the same zone and the Burglary Verified timer has not expired.

NOTE: *Only one reporting code will be sent during each armed period when using Police Code.*

Burglary Not Verified: this reporting code will be sent after the burglary verified timer expires after a zone alarm occurs.

Alarm Canceled: this reporting code will be sent if a valid access code is entered during the Alarm Cancel window. If a valid access code is entered during this window, then the Alarm Canceled event is logged and sent. When the central station has acknowledged this reporting code/event, a keypad ring-back will occur.

[329] - Priority Alarm/Restoral Reporting Codes

[F], [A], [P] Alarm: this reporting code will be sent if the [F] [A] or [P] key is used to generate manual alarms.

Auxiliary Input Alarm: this reporting code will be sent when PGM2 is being used for two wire smoke detectors and the 2-wire smoke detector goes into alarm.

[F], [A], [P] Restoral: this reporting code will be sent after the [F] [A] [P] alarm reporting code is sent.

Auxiliary Input Restore: the panel will transmit this reporting code when the 2-wire smoke detector has restored after an alarm.

[330]-[333] - Tamper Reporting Codes, Zones 1 to 64

If the panel is programmed for Double EOL zones (See Section 2.10 "Zone Wiring") the panel will report a **Zone Tamper Alarm** Reporting Code if an open condition is present on a

zone. A different reporting code can be programmed for each zone for identification.

[334]-[337] - Tamper Reporting Codes, Zones 1 to 64

The **Zone Tamper Restoral** Reporting Code will be transmitted immediately when the tamper condition is restored.

[338] - Miscellaneous Tamper Reporting Codes

General System Tamper: a General System Tamper Reporting Code will be transmitted when the tamper zone on any module is violated.

General System Tamper Restoral: the General System Tamper Restoral Reporting Code will be transmitted when the tamper zone on the module is restored.

Keypad Lockout: the panel will transmit the Keypad Lockout Reporting Code if the lockout is activated.

[339]-[340] - Closing (Arming) Reporting Codes, Zones 1-32

The panel will transmit a Closing Reporting Code to indicate a Partition(s) is armed. A different reporting code can be transmitted for each User Code, Partition Master Code and System Master Code to identify who armed the partition(s).

[341] - Miscellaneous Closing (Arming) Reporting Codes

Closing by Duress Code 33/34: a closing by Duress Code Reporting Code will be transmitted in addition to the Duress reporting code if a Partition(s) is armed using a Duress Code

Closing by Master or Supervisory Code: the panel will transmit a Closing Reporting Code to indicate a Partition(s) is armed. A different reporting code can be transmitted for each User Code, Supervisory Code and System Master Code to identify who armed the Partition(s).

Partial Closing: a Partial Closing Reporting Code will be transmitted if a Partition is armed with zones manually bypassed. The code will also be transmitted if a Partition Auto Arms with zone(s) in violation.

Special Closing: a Special Closing Reporting Code will be transmitted if the Partition(s) is armed using any of the following methods:

- Quick Arm
- Auto Arm
- Arming via the DLS Software
- Arming via Keyswitch
- Away Function Key Arming
- Arming with the Maintenance Code
- Stay Function Key arming

Late to Close: a Late to Close Reporting Code will be transmitted if a partition isn't armed before the Auto-arm start time when the late to close option, (Section 017, option 5) is enabled.

[342]-[343] - Opening (Disarming) Reporting Codes

Access Codes 1 to 32

The panel will transmit an **Opening Reporting Code** to indicate partition(s) is disarmed. A different reporting code can be transmitted for each user code, partition master code and system master code to identify who armed the partition(s).

[344] - Miscellaneous Opening (Disarming) Reporting Codes

Opening by Duress Code 33/34: This Reporting Code will be transmitted in addition to the duress reporting code if a Partition(s) is disarmed using a Duress Code

Opening by Master or Supervisory Code: The panel will transmit this reporting code to indicate a Partition(s) is armed. A different reporting code can be transmitted for each User Code, Supervisory Code and System Master Code to identify who armed the Partition(s).

Auto Arm Cancellation: This reporting code is transmitted when the Auto Arming sequence is canceled or Postponed

Special Opening: A Special Opening Reporting Code will be transmitted if the Partition(s) is disarmed using any of the following methods:

- Disarming using the Maintenance Code
- Disarming via the DLS Software
- Disarming via keyswitch

[345] - Maintenance Alarm Reporting Codes

Battery Trouble Alarm: the panel will transmit a Battery Trouble Alarm Reporting Code when the backup battery drops below 11.5 Vdc.

AC Failure Trouble Alarm: the panel will transmit an AC Failure Trouble Alarm Reporting Code when the AC to the panel is lost and the AC Failure Communication Delay timer expires.

Bell Circuit Trouble Alarm: a Bell Circuit Trouble Alarm Reporting Code will be transmitted immediately if an open condition is measured on the Bell Output of the main panel.

Fire Trouble Alarm: a Fire Trouble Alarm Reporting Code will be transmitted immediately when an open condition is measured on any Fire type zone.

Auxiliary Power Supply Trouble Alarm: the Auxiliary Power Supply Trouble Alarm Reporting Code will be transmitted if the AUX output is shorted.

TLM Trouble: a TLM Trouble Reporting Code can only be transmitted if an alternate communicator is being used. The panel will only transmit the signal after the time programmed for the TLM Trouble Delay.

General System Trouble: a General System Trouble Reporting Code will be transmitted if the panel detects any of the following:

- AC Power Failure
- Low Battery
- AUX Output Trouble
- Output #1 on the PC5200/PC5204 Power Supply/Output Module.
- T-Link Troubles

General System Supervisory Trouble: a General System Supervisory Trouble Reporting Code will be transmitted if any module goes missing from the Keybus. If the module is a zone expander the panel will also transmit the **Zone Expander Supervisory Alarm Trouble** Reporting Code.

[346] - Maintenance Alarm Reporting Codes

Battery Trouble Restoral: the Battery Trouble Restoral Reporting Code will not be transmitted until the battery has been charged over 12.5 Vdc.

AC Failure Trouble Restoral: the AC Failure Trouble Restoral Reporting Code will be transmitted once AC power has been restored for the amount of time programmed for AC Failure Communication delays.

Bell Circuit Trouble Restoral: the Bell Circuit Trouble Restoral Reporting Code will be transmitted as soon as the open condition on the bell output is corrected.

Fire Trouble Restoral: the Fire Trouble Restoral Reporting Code will be transmitted when the correct resistance value is measured on any Fire type zone.

Auxiliary Power Supply Trouble Restoral: the panel constantly checks the AUX output, when the excessive current draw is removed the panel will reset the output and transmit an Auxiliary Power Supply Trouble Restoral Reporting Code.

TLM Restoral: the TLM Restoral Reporting Code will be transmitted immediately after the trouble is restored.

General System Trouble Restoral: a General System Trouble Restoral Reporting Code will be transmitted when the panel detects none of the following:

- AC Power Failure
- Low Battery
- AUX Output Trouble

- Output #1 on the PC5200/PC5204 Power Supply/Output Module.
- T-Link Troubles

General System Supervisory Restoral: the General System Trouble Restoral Reporting Code will be transmitted when the control panel detects all modules enrolled on the keybus

[347] - Miscellaneous Maintenance Reporting Codes

Telephone Number 1 (2) FTC Restore: if the panel fails to transmit information to the central station it will display a failure to communicate trouble condition. The panel will transmit a **Phone Number 1 Failure to Communicate** Reporting Code or a **Phone Number 2 Failure to Communicate** Reporting Code the next time it calls the central station. The panel will transmit the old events, followed by the failure to communicate, followed by the new events.

Event Buffer 75% Full: if the Event Buffer is uploaded on a regular basis an Event Buffer 75% Full Reporting Code can be transmitted to warn that the Buffer is almost full.

NOTE: For EN panels, the Event Buffer 75% Full will not be logged.

DLS Lead In: the DLS Lead In Reporting Code will only be transmitted if the DLS Call Back feature is being used (See Section 5.8 "Downloading"). Before the panel calls the computer back it will call central station and transmit the reporting code to indicate a download session is about to begin.

DLS Lead Out: after a downloading session is attempted and/or completed, the panel will transmit a DLS Lead Out Reporting Code.

Zone Fault Alarm: the Zone Fault Alarm Reporting Code will be transmitted when there is a short detected on any DEOL zone and/or a loss of supervisory on a wireless zone.

Zone Fault Restore: the Zone Fault Restore Reporting Code will be transmitted when the fault condition on the zone is corrected.

Delinquency Code: the Delinquency reporting code is sent whenever the panel is not armed within the number of days programmed for the Delinquency Transmission Delay.

General Zone Low Battery Alarm: the panel will transmit a General Zone Low Battery Alarm Reporting Code when a wireless detector indicates a low battery condition and the delay programmed in "Zone Low Battery Transmission Delay" expires.

General Zone Low Battery Restoral: the General Zone Low Battery Restoral Reporting Code will be transmitted when the low battery condition on all wireless zones is corrected. The specific zone that caused the trouble will be stored to the Event Buffer.

[348] - Test Transmission Reporting Codes

Walk Test End: the walk test end reporting code will be transmitted when a walk test is terminated

Walk Test Begin: the walk test begin reporting code will be transmitted when a walk test is initiated

Periodic Test Transmission with Trouble - the panel can be programmed to transmit a Periodic Test Transmission with Trouble Reporting Code in place of the standard Periodic Test Transmission if any of the following conditions exist.

- Fire Zone Trouble (Zones 1-64)
- Battery Trouble (PC1616/PC1832/PC1864, PC520X)
- Fire Zone Alarm (Zones 1-64, Two-Wire Smoke)
- Aux Trouble (PC1616/PC1832/PC1864)
- Fire Trouble (Two-Wire Smoke)
- Bell Trouble (PC1616/PC1832/PC1864)
- Fire Tamper/Low Sensitivity (WLS/AML Zones 1-32)
- Module Supervisory
- Fire Zones Bypassed (Zones 1-64)
- Ground Fault (PC5700)

- Fire Supervisory (Wireless/AML Zones 1-32)
- TLM Trouble (PC1616/PC1832/PC1864, PC5700 Line 1-2)
- AC Trouble (PC1616/PC1832/PC1864, PC520X)
- FTC Trouble

Periodic Test Transmission: the Periodic Test Transmission Reporting Code will be transmitted at the specified time, (programmed in Section 378) every X number of days (see Section 377).

System Test: the System Test reporting code will be transmitted when a system test is performed on the panel.

[349] - PC5700 Maintenance Reporting Codes

PC5700 Ground Fault Trouble: the panel will transmit this reporting code when a Ground Fault Trouble occurs on the PC5700.

PC5700 Ground Fault Restore: the panel will transmit this reporting code when the Ground Fault Trouble condition has restored on the PC5700.

PC5700 TLM 1(2) Trouble: the panel will transmit this reporting code when a TLM Trouble occurs on the PC5700 Line 1 and/or on line 2.

PC5700 TLM 1(2) Restore: the panel will transmit this reporting code when a TLM Restore occurs on the PC5700 Line 1 and/or Line 2.

[350] - Communicator Format Options

This section requires 2 two digit entries to set the communications format that is to be used for each phone number (1 per phone number). The 3rd telephone number uses the format programmed for the 1st telephone number.

Entry	Communication Format
01	20 BPS, 1400 HZ handshake
02	20 BPS, 2300 HZ handshake
03	DTMF CONTACT I.D.
04	SIA FSK
05	Pager
06	Residential Dial
07	10 BPS, 1400 Hz handshake
08	10 BPS, 2300 Hz handshake
09	Private Line
10	Scantronics 4-8-1 Fast Slot
11	For Future Use
12	Robofon
13	CESA 200

Reporting Codes

- SIA -0 is valid in Account or Rep Code (not 00 in a Reporting code though)
- ADEMCO Contact ID - 0 is not valid in Account or Rep Code (A must be used, 10 in checksum)
- BPS Formats - 0 is not valid in Account or Rep Code (A must be used)
- SIA - This format uses 300 Baud FSK as the communication media. The Account Code can be 4 or 6 hexadecimal digits in length, All reporting codes must be 2 digits in length. The SIA format will transmit a 4 (or 6) digit account code, a 2 digit identifier code and a 2 digit reporting code. The 2 digit identifier is pre programmed by the panel.

Contact ID

Contact ID is a specialized format that will communicate information quickly using tones rather than pulses. In addition to sending information more quickly the format also allows more information to be sent. For example, rather than reporting an alarm zone 1 the Contact ID format can also report the type of alarm, such as Entry/Exit alarm zone 1.

If **Contact ID Sends Automatic Reporting Codes** is selected, the panel will automatically generate a reporting code for each event. These identifiers are listed in Appendix A. If the Automatic Contact ID option is not selected, reporting codes must be programmed. The 2-digit entry determines the type of alarm. The panel will automatically generate all other information, including the zone number.

NOTE: If the Automatic Contact ID option is selected, the panel will automatically generate all zone and access code numbers, eliminating the need to program these items.

NOTE: The zone number for Zone Low Battery and Zone Fault events will not be identified when Programmed Contact ID is used.

If the **Contact ID uses Automatic Reporting Codes** option is enabled, the panel will operate as follows:

- If an event's reporting code is programmed as [00], the panel will not attempt to call the central station.
- If the reporting code for an event is programmed as anything from [01] to [FF], the panel will automatically generate the zone or access code number. See Appendix A for a list of the codes which will be transmitted.

If the **Contact ID uses Programmed Reporting Codes** option is enabled, the panel will operate as follows:

- If an event's reporting code is programmed as [00] or [FF], the panel will not attempt to call central station.
- If the reporting code for an event is programmed as anything from [01] to [FE], the panel will send the programmed reporting code.
- Account numbers must be four digits.
- If the digit '0' is in the account number substitute the HEX digit 'A' for the '0'.
- All reporting codes must be two digits.
- If the digit '0' is in the reporting code substitute the HEX digit 'A' for the '0'.
- To prevent the panel from reporting an event program the reporting code for the event as [00] or [FF].

NOTE: This communication format cannot be selected if Downlook is required.

.....
 Contact ID Sends Automatic Reporting Codes Section [381], Option [7]

SIA (Level 2)

SIA is a specialized format that will communicate information quickly using frequency shift keying (FSK) rather than pulses. The SIA format will automatically generate the type of signal being transmitted, such as Burglary, Fire, Panic etc. The two digit reporting code is used to identify the zone or access code number.

NOTE: SIA format must be used if Downlook is required.

If the SIA format is selected the panel can be programmed to automatically generate all zone and access code numbers eliminating the need to program these items.

If the **SIA Sends Automatic Reporting Codes** option is enabled the panel will operate as follows:

1. If the reporting code for an event is programmed as [00] the panel will not attempt to call the central station.
2. If the reporting code for an event is programmed as anything from [01] to [FF] the panel will AUTOMATICALLY generate the zone or access code number.
3. Bypassed zones will always be identified when partial closing the system.

The Communicator Call Direction Options can be used to disable reporting of events such as Openings/Closings. Also, if all the Opening/Closing reporting codes were programmed as [00] the panel would not report.

If the **SIA Sends Automatic Reporting Codes** option is disabled the panel will operate as follows:

1. If the reporting code for an event is programmed as [00] or [FF] the panel will not attempt to call the central station.
2. If the reporting code for an event is programmed as anything from [01] to [FE] the panel will send the programmed reporting code.
3. Bypassed zones will not be identified when partial closing the system.

NOTE: If using Downlook, do not program the second telephone number for the SIA reporting code format (Section [360]) if the Automatic Reporting Code option is enabled (Section [381]).

NOTE: The zone number for Zone Low Battery and Zone Fault events will not be identified when Programmed SIA is used.

.....
 SIA Sends Automatic Reporting Codes Section [381], Option [3]
 Communicator Call Direction Options Section [351] to [376]
 SIA Identifiers Appendix A

Residential Dial

If Residential Dial is programmed and an event that is programmed to communicate occurs, the panel will seize the line and dial the appropriate telephone number(s). Once the dialing is complete, the panel will emit an ID tone and wait for a handshake (press a 1, 2, 3, 4, 5, 6, 7, 8, 9, 0, * or # key from any telephone). It will wait for this handshake for the duration of **Post Dial Wait for Handshake** timer. Once the panel receives the handshake, it will emit an alarm tone over the telephone line for 20 seconds. If several alarms occur at the same time, only one call will be made to each telephone number the panel is programmed to call.

.....
 Communicator Call Direction Options Section [361] to [368]

Private Line Format

The **Private Line** format allows the communication of zone alarms directly to a user over a telephone line. When an event occurs that the panel is programmed to communicate, the panel seizes the line and dials the programmed telephone number(s). The panel then emits a double beep on the line every 3 seconds. This indicates to the user receiving the call that the control panel is calling.

The user must acknowledge the call by pressing 1, 2, 3, 4, 5, 6, 7, 8, 9, 0, * or # from any touchtone telephone. The panel will wait for this acknowledgment for the duration of **Post Dial Wait for Handshake** timer.

The panel will then indicate which zone is in alarm by sounding a corresponding number of beeps (e.g three beeps for Zone 3). The user must then press a key (1, 2, 3, 4, 5, 6, 7, 8, 9, 0, * or #) to acknowledge the alarm. If the panel has another alarm to communicate, it will sound a corresponding number of beeps for the new zone alarm. The user must then press a key to acknowledge the signal. When there are no further alarms, the panel will hang up.

NOTE: Events not received by the central station due to an FTC will not be transmitted via the Private Line format.

.....
 Post Dial Wait for Handshake Section[161]

Pager Format

The **Communicator Format** option for either telephone number can be programmed for Pager Format. If an event occurs and the **Communicator Call Direction** options direct the call to a telephone number with the Pager Format selected the panel will attempt to page.

When calling a pager extra digits will be required to make it work properly. The following is a list of Hex digits and what function they perform:

- Hex [A] - not used
- Hex [B] - simulates the [] key on a touch tone telephone

Hex [E] - two second pause
 Hex [C] - simulates the [#] key on a touch tone telephone
 Hex [F] - end of telephone number marker
 Hex [D] - forces the panel to search for dial tone
 The panel will attempt to call the pager one time. After dialing the digits in the telephone number the panel will send the account number and reporting code followed by the [#] key (Hex [C]).

There is no ringback when using Pager Format. The panel has no way of confirming if the pager was called successfully; a failure to communicate trouble will only be generated once the maximum number of attempts has been reached.

NOTE: Do not use the digit C in a reporting code when using Pager Format. In most cases, the digit C will be interpreted as a [#], which will terminate the page before it has finished.

NOTE: If the panel detects a busy signal, it will attempt to page again. It will make the maximum number of attempts programmed in section [165].

Force dialing should be disabled when using Pager format.

NOTE: When using Pager format, you must program two hex digit E's at the end of the telephone number.

Pulse Formats

Depending on the pulse format selected the panel will communicate using the following:

- 3/1, 3/2, 4/1 or 4/2
- 1400 or 2300 Hz handshake
- 10 or 20 bits per second
- non-extended

The digit '0' will send no pulses and is used as a filler. When programming account numbers enter four digits. When programming a three digit account number the fourth digit must be programmed as a plain '0' which will act as a filler digit. If an account number has a '0' in it, substitute a HEX digit 'A' for the '0'. Examples:

- 3 digit account number [123]- program [1230]
- 3 digit account number [502] - program [5A20]
- 4 digit account number [4079] - program [4A79]

When programming reporting codes two digits must be entered. If one digit reporting codes are to be used the second digit must be programmed as a '0'. If a '0' is to be transmitted substitute a HEX digit 'A' for the '0'.

Examples:

- 1 digit reporting code [3] - program [30]
- 2 digit reporting code [30] - program [3A]

To prevent the panel from reporting an event program the reporting code for the event as [00] or [FF].

NOTE: This communication format cannot be selected if Downlook is required.

Scantronics Format

This is a DTMF format that sends reporting codes as:

- One 4-digit account code
- Eight 1-digit reporting channels (event code)
- One 1-digit status channel

The software automatically generates a code for the event based on the programming of the call direction groups.

	Channels								
	1	2	3	4	5	6	7	8	i
aaaa	x	x	x	x	x	x	x	x	
Account Code	Event Code								Status Code

When you program the reporting codes for zones and events (programming sections [320]-[353]), program them in the format XY, where:

X= channels 1-8 Y= event code (0-9)

If your central station uses a Scantronics 5100 receiver, only program numbers from 1 to 6 for the event code.

Example: If you program the zone 3 alarm reporting code as [31], the panel will send event code 1 in channel 3. The

panel will send the number 5 for each of the other channels, so that the event code will look like:

5 5 1 5 5 5 5

The panel will send the status code (i) based on the status of the zone:

7 = Alarms, Tampers, Restorals, Openings & Closings

8 = Trouble or Trouble Restoral

9 = Test Transmission.

Example: If there is an alarm on Zone 3 the panel will send:

a a a a 5 5 1 5 5 5 5 7

To disable communication for specific events, program '00' or 'FF' for the reporting code.

Robofon Format

The control panel can use ROBOFON communication format to transmit alarm messages to a receiver. When the panel acts as the ROBOFON dialer, it can receive the following ASCII signals using ODD parity:

HANDSHAKE: 77 Hex, actually received as F7 Hex.

ACK: 06 Hex, actually received as 86 Hex.

NAK: 15 Hex, actually received as 15 Hex.

The data is received by the receiver as 1000Hz tones at 20 ms/bit. A "0" in the bit pattern represents tone on for 20ms, and a "1" in the bit pattern represents tone off for 20ms. The data bytes are transmitted least-significant-bit (LSB) first. The data is transmitted in the following format:

S D1 D2 D3 D4 D5 D6 D7 D8 EXT CHKSUM

Where:

Data	Description
S	55 Hex as start signal
D1	30 Hex, as the first digit of the account code.
D2	30 Hex, as the second digit of the account code
D3 to D6	3X Hex, as the following four digits of the account codes, X = 0 - 9
D7 to D8	3X Hex, as the two digits of the report codes. X= 0 - 9, A - F
EXT	03 Hex, as the end of transmission signal
CHKSUM	YY, it is the XOR of D1 through D8 and then XORed with the EXT

The panel will wait the programmed "Wait for Handshake" for the initial handshake, it will wait 20 sec for any subsequent handshake during the same phone call.

200 Baud FSK (CESA)

This format transmits with the LSB first in the data stream using 1 start bit, 8 data bits, and 2 stop bits (no parity).

The information transmitted is as follows:

- Five Digit Decimal Account Code
- One Digit Event Identifier
- Two Digit Zone Number (00-99)
- Eight Zeros (filler)

After the panel dials, this format looks for a 960 ms FSK handshake at 1850 Hz for 15 ms, 1650 Hz for 15 ms, and 1850 Hz for 15 ms again repeated 32 times. The panel will proceed to send its carrier by emitting 1180 Hz for a period of 800 ms to 1 second, followed by the event utilizing 980 Hz for a Mark (1) and 1180 for a Space (0) at 200 Baud. The panel will send the exact same transmission twice in a row with a 600-800 ms pause. If the two transmissions match exactly, the receiver will give acknowledgement by giving the panel the same FSK pattern as the handshake. The panel can then hang up, or repeat the process indefinitely until it has no further events to transmit.

In the event that the two transmissions do not match, the panel will re-transmit the transmission once if no kiss-off is received after three seconds. The panel will repeat this a total of five times before counting the round as a failed attempt.

The Event Identifier can represent one of the following events:

- 0 = Talk/Listen Audio Event (any event type)
- 1 = New Event (Alarm, Tamper, Trouble, etc.)
- 2 = Event Restore (Alarm Restore, Low Battery Restore, etc.)

An option exists in Section [381] Option 5 ON that allows the identifiers for 1 Arming (Closings) and 2 Disarming (Openings) to be reversed.

The following is a list of what hex characters are actually transmitted by this format and what numbers they represent:

Transmitted	Value	Transmitted	Value
9E	0	8A	5
8E	1	92	6
96	2	82	7
86	3	9C	8
9A	4	8C	9

NOTE: The Talk/Listen Audio Event overrides any other Event Identifier.

The first five digits of the Account Codes must be used for proper operation.

Telephone Line Monitoring (TLM)

When the **TLM Enable** option is selected, the panel will supervise the telephone line and will indicate a trouble condition if the telephone line is disconnected.

If the TLM Enable option is ON, the panel will check the telephone line every 10 seconds. If the telephone line voltage is below 3V for the number of checks programmed in the **TLM Trouble Delay** section, the panel will report a TLM trouble. The default number of checks is 10. Enter a number from (000) to (255) in the TLM Trouble Delay section to change the number of checks before the TLM trouble is reported. Programming a delay means that a momentary interruption of the telephone line will not cause a trouble condition.

If the **TLM Trouble Beeps When Armed** option is enabled, the panel will indicate a TLM trouble at the keypad while the system is armed. To activate the bell output in the case of a TLM trouble while the system is armed, the **TLM Audible (Bell) When Armed** option must be selected.

When the trouble condition is restored, the panel can send a **TLM Restoral** reporting code. Any events which occur while the telephone line is down will also be communicated. If an alternate communicator is being used, the panel can be programmed to report a **TLM Trouble Reporting Code**.

[351]-[376] - Communicator Call Directions

The control panel can call 2 different phone numbers and use the alternate communicator as backup or as a redundant communicator for events from each Call Direction group. The Third phone number can only be used as a backup or alternate of the first.

Each report falls under one of the following 5 Groups:

1. Partition X Alarms & Restores
2. Partition X Openings & Closings
3. Partition X Tamper & Restores
4. System Maintenance Alarms & Restores
5. System Test Transmissions

Each group can be assigned to the following Call Directions

Option 1 - 1st Telephone Number (and 3rd Telephone Number if enabled for Alternate or Backup)

Option 2 - 2nd Telephone Number

Option 3 - 1st Telephone Number via LINKS (and 3rd Telephone Number if enabled for Alternate or Backup)

Option 4 - 2nd Telephone Number Via LINKS

Option 5 -Alternate Communicator. This allows the panel control of what types of events the alternate communicator will transmit. This Call Direction is enabled at default.

[377] - Communication Variables

Communication Variables

Swinger Shutdown (Alarms & Restores)

This value defines the number of attempts (alarm and restore pairs) per zone that the panel will log and communicate before it shuts down for that zone ("swinger shutdown"). Valid entries are 000 to 014.

Different limits can be programmed for **Zone Alarms**, **Zone Tamper** and **Maintenance** signals. After the panel has generated the programmed number of transmissions for an event it will no longer report that event until the swinger shutdown is reset. For example, the swinger shutdown limit for Zone Alarms is set to [001]. The panel will not send more than 1 alarm signal for each zone with a swinger attribute until the swinger shutdown is reset.

The Bell output will not be activated for alarms on zones that have exceeded the limit of alarms set in the Swinger Shutdown counter. Swinger shutdown on global zones will log once to the System Area.

NOTE: Swinger Shutdown will reset on all partitions when any partition on the system is armed, or every day at midnight. Once reset, the panel will again communicate normally.

NOTE: The Bell and Event Buffer can follow Swinger Shutdown if enabled.

Swinger Shutdown (Tamper & Restores)

This value defines the number of times the same system Tamper type event will occur before stopping transmissions. Valid entries are 000 to 014.

Swinger Shutdown (Maintenance Troubles & Restores)

This value defines the number of times the same system Maintenance (Trouble) type event will occur before stopping transmissions. Fire Troubles will follow the Maintenance Swinger Shutdown Variable. Swinger Shutdown is enabled on Zone Types [01]-[06] and [25] on all panels by default, and on all definitions. Valid entries are 000 to 014.

Communication Delay

This value defines the delay before transmission. The delay is for zones which have the Transmission Delay attribute enabled. Program a time from 000 to 255 seconds. This communications transmission delay will be by partition. Each partition will share the same active timer, so if the delay is already active due to an alarm on a different partition, then any new activity on yet another partition will not restart the communications delay timer. Refer to Zone Attributes Section [101]-[164], Option [7].

NOTE: If global zones are used with communications delay, then to stop all alarms from being sent when the communications delay expires, access codes must be entered on all partitions that went in alarm from that global zone.

NOTE: If transmission delay starts on one partition, other partitions cannot cancel it. If transmission delay is active on more than one partition, and a code is entered on one of them, that partition's transmission delay will be cancelled.

NOTE: For UL installations the entry delay plus communication delay cannot exceed 60 seconds.

NOTE: The communication delay is in minutes for  Installations. (000 to 255 minutes)

AC Failure Communication Delay (Minutes/Hours)

This value determines the delay before an AC FAILURE or AC RESTORE is reported. The AC failure or restore is still displayed immediately. Valid entries are from 000 to 255 minutes/hours.

NOTE: Selection of minutes or hours for the delay is set in section [382], Option 6, Pg 48.

NOTE: If AC Failure Communications Delay is programmed as 000, the AC Failure Trouble reporting code will be sent immediately.

Communication Variables

TLM Trouble Delay

The number of valid checks (3 second interval) required before a Telephone Line trouble is generated is programmed here. Valid entries are 000-255 for trouble announcement and transmission delays of 3 to 765 Seconds.

Test Transmission Cycle (Land Line)

This value determines the period between Test Transmissions for the land line. Valid entries are [000]-[255]. Whether this interval is in minutes or days is determined on Section [702], Option 3.

NOTE: If using Test Transmission Exception, a value of 001 will disable the Test Transmission Exception feature.

Wireless Zone Low Battery Transmission Delay (Days)

When a zone reports a low battery condition, the trouble condition will be indicated immediately on the keypad, but the transmission to the monitoring station will be delayed by the number of days programmed in this section. If the user does not correct the low battery condition before the delay expires, the low battery condition will be transmitted. The Low Battery Restore transmission is not delayed.

NOTE: The panel will not send additional low battery events until the first low battery trouble is restored.

Delinquency Transmission Delay

The value in this section determines the period of time that the Delinquency Event will be postponed until it is logged to the Event Buffer and transmitted. Whether this value is in hours or days is determined if Delinquency is for Activity (hours) or Closing (days) as specified in Section [380] Option 8.

The timer start under the following conditions:

- When the system is armed in the Stay mode
- When the system is disarmed
- When a zone is violated and restored while system is disarmed/Stay armed (Interior, Interior Delay, Interior Stay/Away, or Delay Stay/Away zones only).

The activity delinquency timer will be ignored when the system is armed in the Away mode. Zones that are bypassed in the [*][1] Bypass menu will not reset the timer. If the system is programmed to monitor **Closing Delinquency**, the timer will be programmed in days. The timer will restart every time the system is disarmed (see section [380], option [8]).

Communications Cancel Window

After TX Delay expires and a zone alarm has been transmitted, the Cancel window will begin. If an access code is entered during this window, a Communications Cancel reporting code will be communicated. If the window expires without an access code entered or a code is entered after the window, no Opening After Alarm log or communication will occur. The system keypads will provide an audible confirmation that the opening after alarm log was successfully communicated (5 quick beeps).

[378] - Test Transmission Time of Day

Program the time of the test transmission in this section. Enter a 4-digit time using the 24-hr clock format (HH:MM). Valid entries are from 00 to 23 for the hours (HH) and 00 to 59 for the minutes (MM). To disable the test transmission, enter [9999] in this section.

[379] - Periodic DLS Time of Day

In order to provide a regular test of the DLS operation the panel shall auto-call the DLS at a pre-programmed time of day or at random time of day between 23:01 – 05:59, every 30 days. This feature is controlled by the Periodic DLS Time of Day (section 379). The installer can pre-program what time he would like the panel to call by programming a valid entry of 0000 to 2359 which will correspond to the time of day in military time format. If this feature is not desired programming any value between 2401 and 9998 will disable it. Programming 9999 will enable random time. The 'random' time of day is obtained by performing a mathematical operation on the DLS Panel ID Code (Section [404]). The periodic DLS will call until it gets through to the DLS computer. An FTC trouble will NOT be generated locally or communicated if the panel does not get through to the DLS computer.

The calculation of the Time of Day to call is carried out by generation of a pseudo-random time based on the Panel Identification Code programmed in Section [404]. The time generated is between 23:01 and 05:59. The first byte of the Panel ID Code is used to generate the hour (the upper 5 bits are ignored).

The lower byte is used to generate the minute to call. The programmed value is first converted to decimal (00 - 99). If the original HEX value was greater than 99 in decimal it will rollover to 00 and continue (ex. %67 = 103 = 03). if the resultant is 59 or less that value is used as the minute to call. if it is 60 or greater, 60 is subtracted from it and the result is used as the minute to call (ex. 73 - 60 = 13).

First Byte of Section [404]	Hour of Periodic DLS Call-up	First Byte of Section [404]	Hour of Periodic DLS Call-up
xxxxx000	23:xx	xxxxx100	03:xx
xxxxx001	00:xx	xxxxx101	04:xx
xxxxx010	01:xx	xxxxx110	05:xx
xxxxx011	02:xx	xxxxx111	05:xx

Example 1: Section [404] = 5010

The First Byte = Hex 50 = Binary 0101 0000 = 23:xx
 The Second Byte = Hex 10 = Decimal 16 = xx:16
 Therefore, the time of day the Periodic Download occurs is = 23:16
NOTE: The first call should occur 30 days after power up.

Example 2: Section [404] = 7234

The First Byte = Hex 72 = Binary 0111 0010 = 01:xx
 The Second Byte = Hex 34 = Decimal 52 = xx:52
 Therefore, the time of day the Periodic Download occurs is = 01:52

[380] - First Communicator Option Codes

Option	Communicator Code	On/Off	Description
1	Communications	ON	Communicator Enabled The system's communicator will be enabled and all events with reporting codes will be reported to the monitoring station. Refer to the Telephone Number, Reporting Code and Call Direction Programming Sections.
		OFF	Communicator Disabled The system's communicator will be shut off and events will not be transmitted to the monitoring station. Downloading may still be performed if enabled.

Option	Communicator Code	On/Off	Description
2	Restore Transmission	ON	Restore Transmissions on Bell-Time-out Zone restore reporting codes will not be transmitted until the zone has been restored and the Bell cut-off time has expired. If the zone is not restored when the bell cut-off time expires, the restore will be transmitted when the zone physically restores or when the system is disarmed. NOTE: 24-hour zones will not restore until the zone is physically restored.
		OFF	Restore Transmissions Follow Zones Zone restore reporting codes will be transmitted when the zone is physically restored. If the zones are still active when the system is disarmed, the restore codes will be transmitted when the system is disarmed. NOTE: 24-hour zones will not restore until the zone is physically restored.
3	Dialing Method	ON	Pulse Dialing enabled The control panel will dial telephone numbers using pulse (rotary) dialing.
		OFF	DTMF Dialing enabled The control panel will dial telephone numbers using DTMF (dual tone multi-frequency) dialing.
4	Switch to Pulse Dialing	ON	Switch to Pulse Dialing after 4 DTMF attempts If DTMF dialing is enabled, the control panel will dial telephone numbers using DTMF dialing for the first 4 attempts. If unsuccessful, the control panel will switch to pulse (rotary) dialing for the remaining attempts.
		OFF	DTMF Dial for all Attempts If DTMF dialing is enabled, the control panel will dial telephone numbers using DTMF dialing for all dialing attempts.
5	3rd Phone Number Enable	ON	3rd Phone Number Enabled The 3rd Phone number will be used for Alternate Dialing with the 1st Phone Number or as a Backup of the 1st Phone Number (see light 6).
		OFF	3rd Phone Number Disabled The 3rd Phone number will not be used.
6	3rd Phone Number	ON	Alternate Dialing Enabled (1st & 3rd) After each dialing attempt, the communicator switches between the 1st Phone Number and 3rd Phone Number.
		OFF	Call 1st Number, Backup to 3rd Number If the programmed number of attempts to communicate to the First Telephone Number fail, The same number of attempts will be made to communicate to the Third Telephone Number. If all attempts to communicate to the Third Telephone Number fail, a Failure to Communicate Trouble will be generated.
7	For Future Use		
8	Delinquency	ON	Delinquency Follows Zone Activity (Activity Delinquency) This feature assists in the monitoring of the elderly and the handicapped. If there is no zone activity on a partition, the Delinquency Transmission Delay timer in Section [377] will begin counting in hours. When the counter reaches the programmed time, the panel will communicate the Delinquency Code to the central station, if programmed. If there is zone activity present on the system at any time, the counter will be reset. If this option is used, the Closing Delinquency option is not available. NOTE: This code will not be transmitted for partitions that are "Away" armed. Activity on Bypassed zones does not affect this timer. The timer is reset on arming.
		OFF	Delinquency Follows Arming (Closing Delinquency) This reporting code is sent whenever the programmed number of days for Delinquency has expired without the partition being Armed. The timer for this feature is programmed in Section [377]. The value programmed in this section determines the number of days the partition counts when not being armed before sending the Delinquency reporting code to the central station. Once this code is sent, the timer will not be started again until the partition has been armed. Each day programmed in the counter represents one day PLUS the time it takes for the partition to reach midnight. This feature may be disabled by programming 000 in Section [377].

[381] - Second Communicator Option Codes

Option	Communicator Code	On/Off	Description												
1	Opening After Alarm Keypad Ringback	ON	Opening After Alarm Keypad Ringback Enabled When the Opening After Alarm reporting code is successfully transmitted to a programmed telephone number, the keypad will sound a series of 8 beeps to confirm to the end user that the Opening After Alarm Code was sent and received. This Ringback will occur for each Opening After Alarm code successfully reported.												
		OFF	Opening After Alarm Keypad Ringback Disabled When the Opening After Alarm reporting code is successfully transmitted to a programmed telephone number, the keypad will not sound ringback.												
2	Opening After Alarm Bell Ringback	ON	Opening After Alarm Bell Ringback Enabled. When the Opening After Alarm reporting code is successfully transmitted to a programmed telephone number, the Bell will sound a series of 8 squawks to confirm to the end user that the Opening After Alarm Code was sent and received. This Ringback will occur for each Opening After Alarm code successfully transmitted.												
		OFF	Opening After Alarm Bell Ringback Disabled When the Opening After Alarm reporting code is successfully transmitted the system will not perform a ringback.												
3	SIA Reporting Codes	ON	SIA Sends Programmed Rep. Codes This option is for use with the SIA communication format.). If 00 is programmed in the reporting code section, the event will not be communicated. When this option is ON and there is a valid reporting code programmed in the reporting code section, the programmed reporting code will be transmitted. If FF is programmed as a reporting code, the event will not be communicated. <table border="0"> <tr> <td>Reporting Code Entry</td> <td>Option ON</td> <td>Option OFF</td> </tr> <tr> <td>00</td> <td>No Transmission</td> <td>No Transmission</td> </tr> <tr> <td>FF</td> <td>No Transmission</td> <td>Auto Rep Code sent</td> </tr> <tr> <td>01-FE</td> <td>01-FE sent</td> <td>Auto Rep Code sent</td> </tr> </table> NOTE: If the automatic SIA or automatic Contact ID reporting formats are not used, reporting codes must be programmed.	Reporting Code Entry	Option ON	Option OFF	00	No Transmission	No Transmission	FF	No Transmission	Auto Rep Code sent	01-FE	01-FE sent	Auto Rep Code sent
		Reporting Code Entry	Option ON	Option OFF											
00	No Transmission	No Transmission													
FF	No Transmission	Auto Rep Code sent													
01-FE	01-FE sent	Auto Rep Code sent													
OFF	SIA Sends Automatic Rep. Codes When this option is OFF and there is a valid reporting code (01-FE) or FF programmed in the reporting code section, the panel will transmit an automatic reporting code for SIA only. This would be used when automatic reporting codes are required but there is a requirement for a different reporting code (i.e. Pager Format, etc.).														

Option	Communicator Code	On/Off	Description
4	Closing Confirmation	ON	Closing Confirmation Enabled When a Closing reporting code is successfully transmitted to a programmed telephone number, the keypad will sound a series of 8 beeps to confirm to the end user that the Closing Code was sent and received.
		OFF	Closing Confirmation Disabled There will be no keypad ringback when a Closing reporting code is successfully transmitted to a programmed telephone number.
5	Talk/Listen Options for Phone Number One/Three	ON	Talk/Listen (PC5900) on Phone #1/3 Enabled If Talk/Listen is requested for an event by the PC5900, the panel will request the session on the next communication on Phone Number 1/3 (via L-Block) to the central station.
		OFF	Talk/Listen (PC5900) on Phone #1/3 Disabled The panel will not request a Talk/Listen session for an event even if the PC5900 has requested it.
6	Talk/Listen Options for Phone Number Two	ON	Talk/Listen (PC5900) on Phone #2 Enabled If Talk/Listen is requested for an event by the PC5900, the panel will request the session on the next communication on Phone Number 2 (via L-Block) to the central station.
		OFF	Talk/Listen (PC5900) on Phone #2 Disabled The panel will not request a Talk/Listen session for an event even if the PC5900 has requested it.
7	Contact I.D. Reporting Codes	ON	Contact I.D. Uses Programmed Reporting Codes The Contact I.D. communications format will use programmed reporting codes when transmitting to central station. NOTE: If the automatic SIA or automatic Contact ID reporting formats are not used, reporting codes must be programmed.
		OFF	Contact I.D. Uses Automatic Reporting Codes The Contact I.D. communications format will use the automatic reporting codes as shown in Appendix C when transmitting to central station.
8	Local Mode	ON	Local Mode Enabled The panel will always send events to the PC5108L Module. Downlook will not be initiated if requested.
		OFF	Local Mode Disabled The panel will only send events that are being communicated to the PC5108L Module. Downlook will be initiated when requested.

[382] - Third Communicator Option Codes

Option	Communicator Code	On/Off	Description
1	Contact I.D. Partial Closing Identifier	ON	Partial Closing Identifier = 5 Contact I.D. uses '5' as the Identifier for the Partial Closing event.
		OFF	Partial Closing Identifier = 4 Contact I.D. uses '4' as the Identifier for the Partial Closing event.
2	Walk Test Communication	ON	Zone Alarms Communicate during Walk Test Enabled Zone alarms that occur during Walk Test will communicate if programmed to do so.
		OFF	Zone Alarms Communicate during Walk Test Disabled Zone alarms that occur during Walk Test will not communicate even if programmed. This option is defaulted OFF.
3	Communications Cancelled Message	ON	Communications Cancelled Message Enabled The "Communications Cancelled" (LCD) or "CC" (ICON) message will be displayed if alarms are acknowledged during the Transmission Delay time. This message will be displayed for 5 seconds on all keypads on the partition. The acknowledgment can be from an access code, disarm function key, or a keyswitch zone.
		OFF	Communications Cancelled Message Disabled The "Communications Cancelled" message will not be displayed. This option is defaulted OFF.
4	Call Waiting Cancel	ON	Call Waiting Cancel Enabled The Call Waiting dialing string programmed in Section [304] will be dialed before the first attempt of each phone number. All subsequent dialing attempts to the same phone number will not use the Call Waiting Cancel dialing string.
		OFF	Call Waiting Cancel Disabled The Call Waiting dialing string will not be dialed. This option is defaulted OFF. NOTE: A call waiting cancel on a non-call waiting line will prevent successful connection to the central station.
5	T-Link	ON	T-Link Interface Enabled The panel will communicate with a T-Link module connected to the PC-Link header. NOTE: Not investigated by UL.
		OFF	T-Link Interface Disabled The T-Link interface is disabled.
6	AC Failure Transmission Delay	ON	AC Failure Transmission Delay is in Hours The AC Fail Transmission delay is in hours (Section [377], Option 5)
		OFF	AC Failure Transmission Delay is in Minutes The AC Fail Transmission delay is in minutes (Section [377], Option 5)
7	For Future Use		
8	Limiting Tamper Alarm Communication 	ON	No Tamp Alarm Comm when Disarmed. In order to decrease the undesired event communication to the monitoring station the installer will have a toggle option with which the tamper alarm event communication can be controlled. Implementation of the options 8 in Programming Sections [382] – Third Communicator Options Code - shall allow the installer to disable or enable the tamper alarm communication in the disarmed state of the system by toggling between "No Tamp Alarm Communication when Disarmed" and "Tamper Alarms Communicated Always" options. This option is not partitionable in the PC1864 v1.0 panel.
		OFF	Tamper Alarms Communicated Always Tamper events are always communicated to the monitoring station.

5.6 Downloading Options

Downloading

Downloading allows programming of the entire control panel via a computer, modem and telephone line. All functions and features, changes and status, such as trouble conditions and open zones can be viewed or programmed by downloading.

NOTE: When power is applied to the panel, a 6 hour downloading window can be enabled. This will allow you to perform downloading without having to do any keypad programming.

NOTE: When an event occurs that the system is programmed to communicate to the central station, the panel will disconnect from the downloading computer and report the event. This will happen for all events except test transmissions.

If the **Answering Machine/Double Call** option is enabled (or during the first 6 hours after power up) the panel will answer incoming calls for downloading provided the following conditions occur:

1. The panel hears one or two rings then misses a ring.
2. At this point the panel will start a timer.
3. If the panel hears another ring before the **Answering Machine Double Call Timer** expires it will answer on the first ring of the second call.

The panel will immediately go on line and begin the download process unless the **Call Back** option is enabled. If enabled, the panel and computer will both hang up. The panel will then call the **Download Computer Telephone Number** and wait for the computer to answer. Once the computer answers downloading will begin.

If the **User Enabled DLS Window** option is ON, the user can activate the downloading feature for a set period of time by entering [*][6][Master Code][5].

If the **Full 6-hour User Enabled DLS Window** option is enabled, when the user opens the DLS window with [*][6][Master code][5], the DLS window will remain open for six hours. The DLS window will remain open after a successful hang-up from a downloading call. If the **One Time 1-hour User Enabled DLS Window** option is enabled, when the user opens the DLS window with [*][6][Master code][5], the

DLS window will stay open for one hour, and will close after a successful hang-up from a DLS call.

Six hours after power up, the panel will not answer incoming calls unless the **Answering Machine/Double Call** option is enabled, or the **Number of Rings** is programmed to be more than [0].

If the **User Initiated Call-Up** option is enabled, the user can have the panel initiate a call to the downloading computer by pressing [*][6][Master Code][6].

The **Download Access Code** and **Panel Identifier Code** are for security and proper identification. Both the panel and the computer file should have the same information programmed before attempting to download.

The time to complete a successful download can be significantly reduced with the use of the PC-Link. This adaptor makes it possible to perform on-site downloading. To **Initiate Local Downloading via the PC-Link**, enter [*][8] [Installer's Code] [499] [Installer's Code] [499]. All keypads will be busy for the duration of the PC-Link connection. The status LEDs will display the current system status on the keypad where the PC-Link was initiated. For more information on connecting the PC-Link, refer to your "PC-Link Download Kit Instruction Sheet".

NOTE: When uploading labels from LCD keypads, the DLS software will receive the labels only from the LCD keypad assigned to slot 8. In addition, version 1.0 and version 2.0 LCD keypads are not compatible on the same system. For more information refer to the Download Manual included with the computer software.

NOTE: The most recent version of LCD keypad on the system should be assigned to slot 8.

If the **Auto Event Buffer Upload** option is enabled, after the panel has communicated the "Event Buffer 75% Full" event to central station, the panel will call downloading computer. The DLS-3 software will then upload the event buffer. The telephone number of the downloading computer must be programmed for this feature to work.

Auto Event Buffer Upload	Section [401], Option [5]
Answering Machine Double Call Timer	Section [405]
Download Computer Telephone Number	Section [402]
Download Access Code	Section [403]
Panel Identifier	Section [404]

[401] - First Downloading Option Codes

Option	Downloading Code	On/Off	Description
1	Downloading Answer	ON	Downloading Answer Enabled. The system will answer calls for downloading if a successful Double call routine is detected. Have the downloading computer call the system and let the telephone line ring once or twice. After 1 or 2 rings, hang up. If called back within the programmed Double Call Time (000-255 seconds), the panel will answer on the first ring.
		OFF	Downloading Answer Disabled. The system will not answer incoming calls using the Double Call routine unless the User enables the DLS window. This option can be enabled by turning Option 2 ON.
2	DLS Window	ON	User Can Enable DLS Window. The user can use the [*][6][Master Code][5] Command to enable a 6 hour window in which the panel will answer calls for downloading if a successful Double Call routine is detected. If this option is enabled, the window is open upon power up. The window is on for the full 6 hours if enabled.
		OFF	User Can Not Enable DLS Window. The user can not enable a window for DLS calls. NOTE: Options 1 and 2 are not related. One does not need to be enabled for the other to perform its function.
3	Call-Back	ON	Call-Back Enabled. When the system answers the downloading computer's call, both the computer and the panel will hang up. The panel will then call the Downloading Telephone Number and connect with the computer at that number. If more than one downloading computer is to be used, this function should be disabled.
		OFF	Call-Back Disabled. The downloading computer will have immediate access to the panel once it is identified as a valid system.
4	User Call-Up	ON	User Call-Up Enabled. When this feature is enabled, the user may initiate a single call of the Downloading Telephone by entering [*][6][Master Code][6].
		OFF	User Call-Up Disabled. An error tone will be generated when [*][6][Master Code][6] is entered.

Option	Downloading Code	On/Off	Description
5	Auto Event Buffer Upload	ON	Auto Event Buffer Upload Enabled. After the panel has communicated the "Event Buffer 75% Full" event to central station, the panel will call the Downloading Computer's telephone number. DLS software will then perform an event buffer upload upon successful connection.
		OFF	Auto Event Buffer Upload Disabled. After the panel has communicated the "Event Buffer 75% Full" event to central station, the panel will not call the Downloading Computer's telephone number.
6	For Future Use		
7	For Future Use		
8	For Future Use		

NOTE: To perform DLS via the T-Link module, Option [1], Section 401 must be enable or the number of rings in section 406 must be programmed.

NOTE: Option [2] applies to DLS via T-Link as well.

NOTE: Option [3] and [4] cannot be performed through T-Link.

[402] - Downloading Computer's Phone Number

This telephone number is 32 digits in length.

[403] - Downloading Access Code

This 6-digit hexadecimal code allows the panel to confirm that it is communicating with a valid downloading computer.

[404] - Panel Identification Code

This 6-digit Hexadecimal code allows the downloading computer to confirm the identity of the control panel.

[405] - Double-Call Timer

This timer sets the amount of time that can be taken between calls when using Double Call to contact the panel. Valid entries are 001 to 255 (seconds).

[406] - Number of Rings to Answer On

The value in this section determines how many rings that the panel will automatically pick up on in order to establish a DLS connection. Default value is 000 rings. Valid entries are [000]-[020].

NOTE: If Section [401] Option 1 and Section [406] are enabled, either one will work depending on how the installer calls the premises.

[499] - Initiate PC-Link Communications

The installer may initiate a PC-Link DLS session between a computer and panel by entering this section in the following manner: [499] - [Installer's Code] [499].

The installer should already have the PC-Link Cable properly connected between the panel's header and the downloading computer as well as have the DLS file waiting for the panel to connect before entering this command.

NOTE: PC-Link cannot be initiated while the panel is communicating via the phone line.

5.7 Programmable Output Programming

[501]-[514] - Programmable Output Attributes

PGM output attributes and output type must be programmed for each PGM output. PGM output options [09] "System Trouble" and [10] "Latched System Event" have a unique set of attributes listed below the description of each output type.

PGM attributes return to their default settings when PGM output options are changed. See the programming worksheets for the PGM output types defaults.

CAUTION: Select the normal and active states of each PGM output to ensure that undesirable output states do not occur after a loss and restore of AC power.

If you program more than one PGM output as the same output type (e.g. If PGM 1 and PGM 2 are both programmed as [19] Command Output 1), the settings for output attributes [1], [2] and [5] must be the same. This does not apply to outputs programmed as types [09] and [10].

NOTE: Attribute [3] must be ON for PGM Option [16].

Assigning Partitions to Programmable Outputs

By default, all programmable outputs are assigned to partition 1. For programmable outputs to work on other partitions, enable or disable the appropriate partitions in the Partition Assignment programming sections.

PGM Output Partition Assignment Sections [551] - [564]

PGM Output timer Section [170]

PGM Output Types [01], [03], [04], [05]-[08], and [17]-[18]			
1	Future Use		NOTE: This option must be off to ensure proper PGM operation.
2	Future Use		NOTE: This option must be off to ensure proper PGM operation.
3	Output Level	ON	True Output The output will activate (switch to Ground) when the event occurs.
		OFF	Inverted Output The output will de-activate (switch to open) when the event occurs.
PGM Output Types [03], and [19]-[22]			
4	Output Options	ON	Output Pulsed The output will activate for the duration programmed in for the PGM Output Timer in Section [164]. This default period is 5 seconds.
		OFF	Output On/Off The output will toggle between on and off when the corresponding [*][7] command is entered.
PGM Output Types [19]-[22]			
5	Access Code Options	ON	Code Required Access Code Required for Activation.
		OFF	No Code Required No Access Code Required for Activation.

PGM Output Types [09] System Trouble			
1	Service Required		Low Battery, Bell Circuit Trouble, General System Trouble (PC5204 AUX failure, PC5204 Output #1 Trouble, Camera Trouble, Home Automation Trouble, PC5400 Off-Line), General System Tamper, General System Supervisory, RF Jam, PC5204 Low Battery, PC5204 AC Failure
2	AC Fail		AC Trouble
3	Telephone Line Fault		TLM Trouble
4	Communications (Failure)		FTC Trouble
5	Zone (Fire) Fault		Zone Fault, Fire Trouble
6	Zone Tamper		Zone Tamper
7	Zone Low Battery		Zone Low Battery Trouble
8	Loss of Clock		Loss of Time Trouble
PGM Output Types [10] System Event			
1	Burglary		Delay, Instant, Interior, Stay/Away, and 24 Hour Burg Zone Types
2	Fire		[F] Key, Fire Zone
3	Panic		[P] Key and Panic zones
4	Medical		[A] Key, Medical and Emergency zones
5	Supervisory		Supervisory, Freeze and Water zones
6	Priority		Gas, Heat, Sprinkler and 24 Hour Latching Tamper zones
7	Holdup		Holdup Zones and Duress Alarms
8	Output Options	ON	Output Follows PGM Timer The output will activate for the period of time programmed for the PGM Output Timer.
		OFF	Output is Latched The output will be active until a valid access code is entered. <i>NOTE: If a System Event PGM is programmed to follow the Command Output Timer, all attributes must be enabled.</i> <i>NOTE: These are the attributes available for the System Event PGM option. The output will activate if any of the corresponding alarm types occur on the system.</i>
PGM Output Type [31] Alternate Communicator Output			
1	Fire		[F] Key, Fire Zone
2	Panic		[P] Key and Panic zones
3	Burglary		Delay, Instant, Interior, Stay/Away, and 24 Hour Burg Zone Types
4	Openings/Closings		Opening, Closing
5	Zone Auto-Bypass		Zone Auto-Bypass
6	Medical Events Only		[A] Key, Medical and Emergency zones
7	Police Code Output		Police Code
8	Output Options	ON	Pulsed The output will pulse when the selected condition is true
		OFF	Latched The output will latch when the selected condition is true. The output will latch until a valid access code is entered.
PGM Output Type [32] Open After Alarm (Abort Code)			
1	For Future Use		
2	For Future Use		
3	For Future Use		
4	For Future Use		
5	For Future Use		
6	For Future Use		
7	For Future Use		
8	Output Options	ON	5 Second Pulse The output will activate for the duration programmed in for the PGM Output Timer in Section [164]. This default period is 5 seconds.
		OFF	Output is Latched The output will activate when an opening after alarm occurs. The output will latch until a valid access code is entered

[551]-[564] - PGM Partition Assignment

The PC1616/PC1832/PC1864 has a 8-bit toggle field per output that determines which partitions the output is assigned to (outputs PGM 1-14). Each bit corresponds to a Partition in each PGM's toggle mask. This field is supported by PGMs that have multiple partition capabilities (i.e. Command Outputs, Away Arming). It does not affect system outputs (i.e. Ground Start Pulse).

5.8 International Programming

[700] - Automatic Clock Adjust

The value entered here adds or subtracts seconds at the end of each day to compensate for Crystal/Ceramic Resonator inaccuracies. Valid entries are 00-99 with 60 seconds being the default minute. To determine the value to be programmed in this section perform the following:

- Monitor the time lost by the panel over a period of time.
- Calculate the average amount of time per day that the panel gains or loses.
- Add or Subtract this value (seconds) from 60 and enter the value.

Example #1: The clock loses an average of 9 seconds per day. *Solution:* Program the panel to adjust the clock by 51 seconds (instead of the default 60 seconds) for the last minute of each day in section [700]. This will speed up the panel's clock by 9 seconds, correcting the problem.

Example #2: The clock gains an average of 11 seconds per day. **Solution:** Program the panel to adjust the clock by 71 seconds (instead of the default 60 seconds) for the last minute of each day in section [700]. This will slow down the panel's clock by 11 seconds, correcting the problem.

NOTE: If the Auto-arm time is set for 23:59, any change to the Clock Adjust option will directly affect the Auto-arm pre-alert time.

[701] - First International Option Codes

Option	International Code	ON/OFF	Description
1	AC	ON	50 Hz AC The incoming AC power cycles at 50 Hz.
		OFF	60 Hz AC This is the North American standard where the incoming AC power cycles at 60 Hz.
2	Time Base	ON	The timebase is the internal crystal oscillator. In cases of unstable AC power input, the internal crystal can be used to keep the most accurate timebase.
		OFF	The timebase is the AC power input. The 50 or 60 Hz AC power input is normally very stable and can be used as the timebase
3	Arming Inhibit	ON	AC/DC Arming Inhibit with Battery Check Enabled. When an AC or DC trouble is present, the system will not arm. This includes Keypad, Keyswitch, Automatic, and Downloading Arming. If enabled and arming is attempted, the system will perform a System Battery check as well as a Battery Check on all peripheral modules supported by a backup battery.
		OFF	Arming not Inhibited. The system can be armed, regardless of the presence of an AC or DC trouble and will not check all system batteries upon arming. NOTE: If this option is enabled, it is strongly recommended that AC Troubles be displayed (Section [017], Option 1 ON).
4	Latching System Tamper	ON	System Tamper Require Installer Reset and Inhibit Arming. If any system tamper condition occurs, the Installer's code must be entered. [*][8] [Installer Code] and the tamper condition must be restored before the system can be armed. This also includes auto-arming and keyswitch. If auto-arming is attempted with a latched tamper, the panel will not arm. The Auto- arm Cancellation code is not transmitted however because a user did not cancel the auto-arming sequence.
		OFF	System Tamper Do Not Require Installer Reset. If any system tamper condition occurs, an Installer Reset is not required. NOTE: If enabled, the manual bypassing of a zone will not bypass the tamper or fault states (DEOL). This feature also applies to Zone Faults.
5	Access Code Length	ON	6-digit Access Codes. All access codes on the system will be 6 digits in length except the Panel I.D. Code and the Downloading Access Code. <ul style="list-style-type: none"> System Master Code = XXXX56 XXXX = previous code, (1234) Installer Code = YYYY55 YYYY = previous code, (5555)
		OFF	4-digit Access Codes. All access codes on the system will be 4 digits in length. For any existing codes, the last 2 digits are removed.
6	Busy Tone	ON	Busy Tone Detection Enabled. If these tones are detected, the communicator will disengage the phone line and try to place the call again following the "Delay Between Dialing Attempts"
		OFF	Busy Tone Detection Disabled. The communicator will use the standard dialing procedure for every attempt.
7	Battery Current Charge	ON	High Current Battery Charge. The battery connected the control panel will be charged with a charge current of approximately 700 mA.
		OFF	Standard Current Battery Charge. The battery connected to the control panel will be charged with a charge current of approximately 400 mA (280mA for IMQ).
8	Communication Priority	ON	Alarm type Events are Priority Alarm Type Events (Zone Alarms, [F] Key Alarm, [A] Key Alarm, [P] Key Alarm, Duress Alarm, Zone Expander Supervisory Alarm, Two Wire Smoke Alarm) will terminate a DLS, Remote Escort, Listen-in or a Downlook Session.
		OFF	All Except Test type Events are Priority All events except Periodic Test Transmission, Periodic Test with Trouble, and System Test are considered priority events. Priority events will terminate a DLS, Remote Escort, Listen-in or a Downlook Session.

[702] - Second International Option Codes

Option	International Code	On/Off	Description
1	Pulse Dial	ON	33/67 Pulse Dialing Make/Break Ratio is 33/67
		OFF	40/60 Pulse Dialing Make/Break Ratio is 40/60
2	Force Dial	ON	Force Dialing Enabled If the first attempt by the panel to call the monitoring station fails to detect a dialtone, on every subsequent attempt the panel will dial regardless of the presence of dialtone. See [703] Delay Between Dialing Attempts.
		OFF	Force Dialing Disabled The panel will not dial the programmed telephone number if dial tone is not present.
3	Land Line Test Transmission	ON	Land Line Test Transmission Interval is in Minutes The value programmed in Section [370] Seventh entry is in Minutes.
		OFF	Land Line Test Transmission Interval is in Days The value programmed in Section [370] Seventh entry is in Days.
4	Handshake	ON	1600 Hz Handshake The communicator responds to a 1600 Hz handshake for BPS formats.
		OFF	Standard Handshake The communicator responds to the handshake designated by the format selected (1400 or 2300 Hz).
5	I.D. Tone	ON	I.D. Tone Enabled After the telephone number is dialed, the panel will emit a tone (as specified by Option 6) for 500 ms every two seconds to indicate that it is a digital equipment call, not voice.
		OFF	I.D. Tone Disabled After the telephone number is dialed, the panel will not emit an I.D. Tone
6	I.D. Tone Frequency	ON	2100 Hz I.D. Tone After the telephone number is dialed, the panel will emit a 2100Hz I.D. Tone. Enable I.D. Tone (Section [702], Option 5).
		OFF	1300 Hz I.D. Tone After the telephone number is dialed, the panel will emit a 1300Hz I.D. Tone. Enable I.D. Tone (Section [702], Option 5).

Option	International Code	On/Off	Description
7	DLS Window	ON	One Time 1-hour user Enabled DLS Window The User Enabled DLS Window is 1 hour in length and will be closed after a successful hang-up from a downloading call.
		OFF	Full 6-hour User Enabled DLS Window The User Enabled DLS Window is 6 hours in length and remains open after a successful hang-up from a downloading call. This option determines the length of the DLS window available on power up.
8	FTC Bell	ON	Bell on FTC when armed If a Failure to Communicate Trouble is generated while the system is armed, the Bell output will sound for the length of Bell time-out or until the system is disarmed.
		OFF	FTC Trouble only when armed If a Failure to Communicate Trouble is generated while the panel is armed, the Bell output will not sound but the keypad buzzer will sound trouble beeps until a key is pressed.

[703] - Delay Between Dialing Attempts

For standard (force) dialing, the panel will go off-hook, search for dialtone for 5 seconds, hang-up for 20 seconds, go off-hook, search for dialtone for 5 seconds, then dial. If there is no initial handshake recognized within 40 seconds, the panel will hang up. This programmable timer adds a delay before the next call is attempted, and is defaulted to 001 for a total of six seconds.

5.9 Module Programming

The programming sections listed below pertain to additional modules on the system. For instructions on programming these modules and a description of each programming section, see the associated *Installation Manuals*.

1. PC5400 Programming Section [801]
2. PC5900 Programming Section [802]
 - PC5900 Audio Verification Module provides Talk/Listen-in capability for audio verification of alarms. Up to 4 microphones and 2 speakers can be connected to the module. The talk/listen-in options are programmable by the central station operator using the telephone keys 1-9, [*] and [#]. Please refer to the PC5900 Installation Manual for more details.
2. Alternate Communicator Programming Section [803]
3. PC5132 Programming Section [804]
4. PC5100 Programming Section [805]

NOTE: All Talk/Listen and/or video sessions are disconnected when the panel communicates alarms to the central station.

Telephone 1 & 3 Listen-In Enabled Section [381], Option 5
Telephone 2 Listen-In Enabled Section [381], Option 6

5.10 Special Installer Instructions

[900] - Panel Version

This section will display the panel version.

[901] - Installer Walk Test Mode Enable / Disable

The **Installer Walk Test** can be used to test the alarm state of each zone of the panel. The walk test cannot be used to test zone type [24]. Before beginning the walk test, ensure the following conditions are met:

1. The panel is disarmed
2. The Keypad Blanking option is disabled (section [016]: [3])
3. The Fire Bell is Continuous option is disabled (section [014]: [8])
4. The Transmission Delay is disabled, if Transmission Delay is not required (section [377])

NOTE: Fire Troubles are not supported in Walk Test.

To perform a Walk Test, do the following:

1. Enter Installer Programming
2. Enter Section [901]

When any zone is violated the panel will activate the Bell Output for two seconds, log the event to the Event Buffer.

Check the event buffer to ensure that all zones and FAP keys are functioning properly.

NOTE: If there is no zone activity on the system for 15 minutes, the system will end the walk test and return to the normal state.

To stop the test, you must do the following:

1. Enter Installer Programming
2. Enter Section [901]

Zones do not have to be restored to stop the test. After the test is complete, check the Event Buffer to ensure that the Audible/Silent 24-hr. PGM alarms have been restored.

NOTE: The Alarm Memory is cleared upon entering Walk Test mode. When the Walk Test is complete, the Alarm Memory will indicate the zones tested. The Alarm Memory will be cleared the next time the panel is armed.

NOTE: While the walk test is in progress, all three LEDs (Arm, Ready, Trouble) will flash at a rapid rate. At the start of the Walk Test, a TS signal will be communicated. When the test is stopped a TE (test end) is communicated.

[902] - Reset Module Supervision

All modules will automatically enroll within one minute upon power up (except the PC5132 if there are no serial numbers programmed). If modules are to be removed, this section should be entered after the removal of the modules so that it may clear any supervisory troubles that may be present. When this mode is entered, the system will re-evaluate the components of the system.

NOTE: It may take up to a minute to enroll or delete a module. Before entering Section [903] to view the module field, this time should be taken into account.

If there is a module that is not properly communicating with the system and this section is entered, the module will be deleted from the system.

Once executed, all pending Supervisory Trouble Restores will not be logged or transmitted.

[903] - Module Supervision Field

When this mode is entered, the system will display all of the modules presently enrolled on the system as indicated below.

Indicator	Module
Lights 1-8	Keypads 1-8
Lights 9-14	Zone Expander Groups 1-6
Light 15	PC5100
Light 16	Zone Expander Group 7
Light 17	PC5132
Light 18	PC5208
Light 19	PC5204
Light 20	PC5400
Light 21	PC59XX
Light 22	Alternate Communicator
Light 23	Downlook Module
Light 24	ESCORT5580(TC)
Light 25	For Future Use
Light 26-29	PC520X 1-4

[904] - Module Placement Test

Module Selection

Upon entering Section [904], a 2 digit entry will be required to select the zone number to be tested. Valid entries are 01-32 for Zones 01-32 respectively. On an LCD Keypad, there are two ways to make a zone selection: direct entry of "01"- "32", or by scrolling across to the description of the module (i.e. "Zone 1"). If a module is selected that is not enrolled, an error tone will sound.

Placement Indication

After the zone is selected, the alarm contacts must be opened. This will register a signal strength value that will be indicated and enunciated on all keypads, as well as on the Bell. The system will remain in this test mode until [#] is pressed or Installer's timeout (20 minutes).

- GOOD signal will be indicated by Light 1 on an LED keypad or the word GOOD on an LCD keypad. It will be enunciated on the Keypad by 1 beep and on the Bell by 1 Squawk.
- BAD signal will be indicated by Light 3 on an LED keypad or the word BAD on an LCD keypad. It will be enunciated on the Keypad by 3 beep and on the Bell by 3 Squawk.
- Non-Enrolled zone will be announced on the Keypad by an error tone.

[906] - For Future Use

[989][Installer Code] - Default Master Code

This will allow the installer to default the Master Code to the factory defaults.

[990][Installer Code] - Installer Lockout Enable

If enabled, the panel will give a distinctive audible indication on power up (the phone line relay will click 10 times). This feature will have no effect on a Software Default (all programming will return to the factory defaults). However, if a hardware default is attempted while lockout is enabled, the default will not occur, and the fraudulent attempt will be logged to the event buffer.

Installer Lockout

If **Installer Lockout** is selected a hardware default cannot be performed. If a software default is performed all programming will restore to factory default.

When **Installer Lockout Disable** is selected the panel will restore all programming to factory defaults if a hardware or software default is performed on the main control panel.

To enable Installer Lockout perform the following:

1. Enter Installer Programming.
2. To enable Installer Lockout, enter section [990]
3. Enter the Installer Code.
4. Enter section [990] again.

[991][Installer Code] - Installer Lockout Disable

This disables the Installer Lockout feature described above.

To disable Installer Lockout perform the following:

1. Enter Installer Programming.
2. To disable Installer Lockout, enter section [991].
3. Enter the Installer Code.
4. Enter section [991] again.

[993]-[999] - Factory Defaults

On occasion it may be necessary to default the main control panel or one of the modules that can be connected. There are several different defaults available including defaulting the main control panel, Escort5580(TC) module, PC5132 Wireless Expander Module, PC5400 Printer module.

NOTE: Defaulting the main panel does not default the keypads. Refer to the Programming Worksheets Appendices A and B for instructions for defaulting keypads. Keypads must be manually reprogrammed in programming section [000].

Factory Default Main Panel (Hardware)

1. Remove AC and battery from the panel.
2. Remove all wires from the Zone 1 and PGM1 terminals.
3. With a piece of wire short the Zone 1 terminal to the PGM1 terminal.
4. Apply AC power to the main panel.
5. When Zone Light 1 is lit on the keypad the default is complete.
6. Remove AC power from the control
7. Reconnect all original wiring and power up the control.

NOTE: AC power must be used to power the panel. The panel will not default if the battery is used.

Factory Default Main Panel (Software) and other Modules

1. Enter Installer Programming.
2. Enter the appropriate programming section [99X].
3. Enter the Installer Code.
4. Enter the appropriate programming section [99X] again. The panel will take a few seconds to reset. When the keypad is operational, the default is complete.

[993][Installer Code] - Restore Alternate Comm. Factory Default Programming

When this section is successfully entered, all programming in the Alternate Communicator will be returned to the factory defaults.

[995][Installer Code] - Restore ESCORT5580(TC) Factory Default Programming

When this section is successfully entered, all programming in the ESCORT5580(TC) Module will be returned to the factory defaults.

[996][Installer Code] - Restore PC5132 Wireless Factory Default Programming

When this section is successfully entered, all programming in the PC5132 Wireless Expansion Module will be returned to the factory defaults.

[997][Installer Code] - Restore PC5400 Factory Default Programming

When this section is successfully entered, all programming in the PC5400 Serial Module will be returned to the factory defaults.

[998][Installer Code] - Restore PC5900 Factory Default Programming

When this section is successfully entered, all programming in the PC5900 Audio Interface Module will be returned to the factory defaults.

[999][Installer Code] - Restore Factory Default Programming

When this section is successfully entered, all programming in the PC1616/PC1832/PC1864 will be returned to the factory defaults. The programming for the ESCORT(TC), PC5132, PC5400 and PC59XX modules will not be defaulted. When this command is executed, the Module Supervision Field will be reset.

Section 6: Fire Monitoring

This section explains all Fire monitoring zones that can be programmed on the PC1616/PC1832/PC1864 and PC5700 fire module. Fire monitoring zone programming is the same as burglary zone programming. Instructions on zone programming are located in the PC1616/PC1832/PC1864 *Installation Manual*, see Partitions and Zones.

NOTE: 2-wire smoke detectors can only be connected to the dedicated 2-wire smoke zone on the PC1616/PC1832/PC1864, PGM2 and Aux+ terminals.

6.1 Partitions and Fire System Configuration

A fire system within a single building must not be partitioned in such a way that audible or visual alarm notification appliances would operate in one partition and not another.

Even though the system can be partitioned for security control purposes, any fire zone on any partition in the building must activate all fire monitoring zones in all system partitions.

The PC1616/PC1832/PC1864 provides two methods for achieving these results.

Fire Configuration 1

- Assign all fire monitoring zones to one partition.
- Assign at least one keypad to the same partition as the fire monitoring zones.
- Other types of zones can also be assigned to this partition without affecting the fire operation as described below.

Operation

The waterflow and any fire monitoring zones on the PC5700 module will be displayed, in the auto-scroll mode, on all partition and global keypads. If a zone on the PC5700 is in alarm, then fire silence and reset can be done from any partition keypad.

If the alarm is from a partition zone then fire alarm silence and reset can only be done directly on the fire partition keypad(s). To silence from other partition keypads or a global keypad requires that the keypad be loaned to the fire partition.

Fire Configuration 2

(Recommended)

- Assign all fire zones to all active partitions in the system. Do not program fire zones as 'silent'.
- One or more keypads can be located on any partition.

Operation

On alarm, the auto-scroll will display on all partition keypads. Fire alarm silence and fire system reset may be done directly on any partition keypad. To silence from a global keypad requires that the global keypad be loaned to one of the partitions.

NOTE: Assign command output 2 (sensor reset) to all partitions.

6.2 Fire Zones

All zones can be programmed as Fire Monitoring zones. This zone is always an end of line resistor type with normally open alarm contacts from the alarm initiating device(s). Multiple devices can be connected in parallel on a single zone. The zone wiring is supervised by the control panel for:

- Short Circuit: Fire Alarm
- Open Circuit: loss of the end of line resistor; this will be indicated as a Zone Trouble
- Ground Fault: resistance < 40kΩ to earth ground indicated as a Ground Fault Trouble on PC5700 zone 7

Typical Fire Devices used on this zone type are:

- Heat Detectors – fixed temperature and/or rate-of-rise
- Fire alarm panel outputs such as Alarms and Troubles
- Manual pull stations
- 4-wire smoke detectors

Standard Fire Operation

When a Fire Monitoring zone goes into alarm, the panel will activate the alarm notification output(s) and will immediately transmit a reporting code to the central station, if programmed. The alarm notification output(s) can be programmed to pulse—one second on, one second off—or to follow another programmed alarm notification pattern (see Section 5.3, 'Basic Programming', [005] System Times). If an open condition is present, the panel will immediately display and communicate a Trouble condition. All keypads will annunciate the Trouble by activating the Trouble light and beeping twice every ten seconds. The keypads can be silenced by pressing any key.

Auto Verify Fire

All zones can be programmed as Auto Verify Fire zones. For zones on the main panel or zone expanders, this zone is always an end of line resistor type with Normally Open alarm contacts from the alarm initiating device(s). Multiple devices can be connected on a single zone.

The zone wiring is supervised by the control panel for:

- Short Circuit: Fire Alarm
- Open Circuit: loss of the end of line resistor; this will be indicated as a Zone Trouble
- Ground Fault: resistance < 40kΩ to earth ground indicated as a Common Ground Fault Trouble.

NOTE: This zone type is only for smoke detectors that can be reset by the control panel. Do not mix contact type alarm-initiating devices on zones programmed for Auto Verify Fire. The following device can be used:

- 4-wire smoke detectors powered from the AUX+ output on the PC1616/PC1832/PC1864 main board

Four-Wire Smoke Detector Zones

All zones can be programmed for 4-wire smoke detectors. It is always an end of line resistor type with normally open alarm contacts from the fire alarm-initiating devices. Multiple contacts can be connected in parallel on a single zone.

For commercial applications, zones used for 4-wire smoke detectors can be programmed as Standard Fire. For residential applications, the zone can be programmed as Standard Fire.

Power for the 4-wire smoke detectors can be derived from the auxiliary (AUX+) output on the PC1616/PC1832/PC1864 main panel. This detector may be connected to any PGM 1-4. The PGM must be programmed as Sensor Reset (see *Programming Worksheets*). PGM2 can either be programmed for a 2-wire smoke detector or a 4-wire smoke detector, but both detectors cannot be programmed concurrently on PGM2. For a wiring diagram, see Appendix B-6 'Sensor Reset for 4-Wire Smoke Detectors'.

Two-Wire Smoke Detector Zones

PGM2 can be programmed for 2-wire smoke detectors. More than one smoke detector can be connected in parallel, refer to the Compatibility Chart in this manual for details (see Appendix B, diagram B.1). PGM2 must be programmed for 2-wire smoke support (PGM2 only) Option[4]. Refer to the PC1616/PC1832/PC1864 *Programming Worksheets*, 'Programmable Output Options'.

Fire Supervisory Zone

This zone is always an end of line resistor type with normally open alarm contacts from the Fire Supervisory initiating devices. A maximum of 20 Fire Supervisory devices can be connected in parallel on a single zone. The zone wiring is supervised by the control panel for:

- Short Circuit - Supervisory off-normal
- Open Circuit - loss of the end of line resistor; this will be indicated as a Zone Trouble

A Fire Supervisory zone monitors fire critical systems to indicate when those systems are in a condition that could prevent normal operation. These most commonly monitored devices are sprinkler gate valves to ensure they are not closed, which would prevent water from flowing to the sprinklers.

6.3 Fire System Operation

Manual Signal Silence

Once the panel is in alarm and the alarm notification appliances are active, entering a valid user code will silence the alarm signals.

Silencing will not deactivate any output programmed as Fire Strobe.

Manual Silencing initiates a Trouble condition by turning on the keypad Trouble LED and sounding the keypad buzzer. The buzzer may be silenced by entering an access code.

Automatic Signal Silence (Bell Time-out)

Ref: Section[014] Option [8] Fire Bell Follows Time-out

Ref: Section[005] Bell Time-out (default 004 minutes)

The fire alarm notification appliances may be set to silence automatically after a programmed time. The system is default programmed to silence the notification appliances four minutes after the last initiated fire alarm. If the Fire Time-out option is disabled, the notification appliance can only be silenced manually.

The Bell Time-out timer begins upon the first fire alarm. Each subsequent alarm will restart the timer.

Manual Sensor Reset ([*][7][2])

The Sensor Reset function is designed so that the user can manually reset latching smoke detectors by entering [*][7][2]. In order for this feature to function, the detectors to be reset must be connected to a programmable output (PGM1-4, AUX+).

Program the output as 'Sensor Reset 2' (PGM output option #03). The output pulse time is by default set at five seconds. For instructions on output programming, see your PC5020CF *Installation Manual*, Section 5.3 'Basic Programming', [009]-[011] Programmable Output Options.

RECOMMENDED: As a security measure, ensure that a code is required to activate [*][7][2]. This will require that a user enter a valid access code after entering [*][7][2] in order to reset smoke detectors.

Subsequent Alarm Operation

If the alarm notification appliances have been silenced – manually or automatically – and a subsequent fire alarm is initiated, the following will occur:

- Audible and visual notification appliances will activate as programmed.

- The Bell Time-out, if used, will restart for a full timing period before automatic silencing.
- The new alarm and all previous alarms/troubles will be displayed.

If a subsequent Fire alarm is initiated before the alarm notification appliances have been silenced, either manually or automatically, then the following will occur:

- The Bell Time-out, if used, will restart for a full timing period before automatic silencing.
- The new alarm will be shown.

Auto-Scroll LCD Keypad Display

When an alarm is initiated, the Alarm and selected Trouble conditions will be displayed on the system LCD keypad(s). If there is more than one Alarm or Trouble present simultaneously, the keypad will continuously scroll through each event. Items on the scroll list are displayed at two-second intervals. The keypad will beep as each message is displayed.

Although critical Troubles are displayed, Auto-scroll is only initiated upon a Fire Alarm. If a Fire Trouble is detected and a Fire Alarm is not present, the Trouble will be indicated as any other system trouble; the keypad Trouble light will turn on and the keypad buzzer will beep.

The following events are included in the Auto-scroll.

- **'Fire Alarm [Zone Label]'**: This message will appear for all Fire Alarms. Messages are displayed sequentially by zone number.
- **'Fire Trouble [Zone Label]'**: This message will appear for Fire off-normal conditions only and the keypad buzzer will beep once as it is displayed. Messages are displayed sequentially by zone number.
- **'Bell CCT Trouble'**: This message will appear if an open fault is detected on the PC1616/PC1832/PC1864 bell zone.
- **'Failure to Communicate'**: This message will appear when the panel cannot report to the central station.

Auto-scroll will stop when a valid user code is entered to silence the alarm notification appliances.

Fire Trouble Conditions

In all cases, when the panel detects a Trouble condition, the keypad Trouble light turns on and the keypad buzzer will sound two short beeps every 10 seconds. Pressing any key will silence the audible Trouble signal. The Trouble buzzer will resound if another Trouble is generated.

Fire Zone Trouble

A fire zone Trouble will be generated when an open circuit is detected on any fire zone.

AC Trouble

An AC Fail Trouble is generated if the AC fails on the PC1616/PC1832/PC1864. AC Troubles are grouped for common indication on a remote annunciator as an 'AC Trouble'.

See also Section 5.6 'Communicator Programming', [377] Communication Variables.

Battery Trouble

A battery Trouble is generated if the PC1616/PC1832/PC1864/PS5350 panel batteries are open or shorted. This Trouble condition only turns on the keypad Trouble light and sounds the keypad buzzer.

Ground Fault

Ground fault detection must be enabled for Commercial Fire Monitoring installations by connecting the EGNd terminal on the PC1616/PC1832/PC1864 to a solid earth ground. Upon detection of a resistance of <40kΩ between any extended conductor and earth ground, a Ground Fault Trouble will be generated via zone 7 of the PC5700 (see *Installation Instructions* for PC5700 fire module v2.0).

TLM Troubles

If the PC5700 module detects a TLM Trouble on telephone line 1 or 2, Zone 8 on the PC5700 will be violated automatically. The panel can only monitor both telephone lines if a PC5700 is connected.

NOTE: *TLM Trouble monitoring should not be disabled.*

Fail To Communicate (FTC)

If the control panel is unable to report to the central station, an FTC Trouble will be generated and the message 'Failure to Communicate' will be added to the Troubles list to advise the user that the central station may not have received the communication about the current alarm status.

AC Delays

AC Fail TX Delay

AC Fail TX Delay -UL Requirement

If the **AC Fail TX Delay** is programmed, the panel will delay reporting the AC Trouble to the central station for the programmed time.

NOTE: *For 24-hr battery backup (14Ah battery) program AC Fail Transmission Delay for 6 hours. For 60 hour battery backup (60ah battery) program AC Fail Transmission Delay for 15 hours.*

See section 5.6 'Communicator Programming', [377] Communication Variables.

Fire Reporting Codes

The following reporting codes should be programmed on every PC1616/PC1832/PC1864 system:

Fire Events

2-wire Alarm – This reporting code will be sent when a 2-wire smoke zone alarm occurs. The 2-wire smoke zone acts as a standard fire zone. The 2-wire Alarm Restoral reporting code will be sent when the alarm condition is restored.

2-wire Trouble – This reporting code will be sent when the 2-wire smoke detector zone has a trouble (open) condition. The 2-wire Trouble Restoral reporting code will be sent when the condition has restored.

[F] Key

The panel will transmit a Keypad Fire Alarm reporting code and the Keypad Fire Restoral reporting code when the Fire Keys on any keypad are pressed for two seconds.

NOTE: *For commercial applications, do not program the [F] key for keypads that are readily accessible by the public. For more information regarding this key, see the PC1616/PC1832/PC1864 Installation Manual Section 5.3, 'Basic Programming', [015] Third System Option Codes, Option [1].*

System Maintenance

Panel Battery Trouble – This code will be sent when the control panel battery is low, disconnected or if the battery fuse fails. The Battery Trouble Restoral reporting code will be sent when the condition is cleared.

Panel AC Trouble – This code will be sent when the AC power to the control panel is disconnected or interrupted. To

prevent communicating the trouble in the event of short power failures, the code will not be sent until the AC Failure Communication Delay has expired. When the Trouble is restored, the AC Line Trouble Restoral reporting code will be sent.

Panel Bell Trouble – This code will be sent when a bell Trouble occurs. This is when an open circuit is detected across the bell terminals. When the Trouble condition is restored, the Main Bell Trouble Restoral reporting code will be transmitted.

Panel AUX Trouble – This code will be sent when an auxiliary voltage supply Trouble occurs. When the voltage supply is restored, the Main Auxiliary Trouble Restoral code will be sent.

GND Fault Trouble – This reporting code will be sent when the earth ground connection detects a ground fault. The Ground Fault Restoral reporting code will be sent when the earth ground fault connection is restored.

NOTE: *The PC1616/PC1832/PC1864 EGNd terminal must not be connected to the key ground. Connecting earth ground to the key ground will interfere with system performance and generate a Ground Fault Trouble.*

Periodic Test – This is the reporting code that is sent to the monitoring station to test communications (see PC1616/PC1832/PC1864 *Installation Manual*, section 5.6, 'Communicator Programming', [377] Communication Variables).

Periodic Test TBL – This test transmission code is sent instead of a Periodic Test Transmission if any of the following conditions occur:

- Common Fire Trouble
- Fire Zone Alarm (all zones)
- Fire Alarm (5700)
- Fire Zone Trouble (all zones)
- Fire Zone(s) Bypassed
- AUX Trouble (main panel)
- Key Low Power
- Module Supervisory Fault
- [F] Key Alarm

Section 7: Listing Requirements

7.1 UL Listed Commercial and Residential Installations

The installation requirements listed below must be met for the following grades of service.

Grade AA Central Station and Police Connect (Standard or Encrypted Line Security Service)

The installation must use T-Link module which communicates over LAN/WAN to the Sur-Gard MLR-IP receiver or the TL200/250 which communicates over LAN/WAN/Internet to the SG System III receiver. Polling time must be 90 seconds. Compromise detection time must be 6 minutes.

Grade A Local

- The installation must have a bell which is UL Listed for mercantile local alarms (AMSECO MBL10B with model AB-12 bell housing).
- The digital communicator must be enabled.
- The control panel must be in the attack-resistant enclosure (DSC Model CMC-1 or PC4050CAR).

Grade B Central Station and Police Connect

- The installation must have a bell which is UL Listed for mercantile local alarms (AMSECO MBL10B with model AB-12 bell housing).
- The digital communicator must be enabled.
- The control panel must be in the attack resistant enclosure (DSC Model CMC-1 or PC4050CAR).

Grade C Central Station

- The digital communicator must be enabled.
- The control panel must be in the attack resistant enclosure (DSC Model CMC-1 or PC4050CAR).

All Commercial Installations

- The Entry Delay must not exceed 120 seconds
- The Exit Delay must not exceed 120 seconds.
- The minimum Bell Time-out is 15 minutes.

Residential Fire & Burglary Installations

- The Entry Delay must not exceed 45 seconds
- The Exit Delay must not exceed 60 seconds.
- The minimum Bell Time-out is 4 minutes.

Home Health Care Signaling Equipment

- There must be at least two keypads, one of either the LCD5500Z/LCD5520Z or LCD5501Z and one of the following models, PC5508Z, PC5516Z or PC5532Z.
- Each system shall be programmed to activate an audible Trouble signal within 90 seconds upon loss of microprocessor memory.
- The minimum Bell Time-out is 5 minutes.

Programming

The notes in the programming sections describing the system configurations for UL Listed installations must be implemented.

Control of the Protected Premises

In order to have a UL Certificated system the protected area is to be under the responsibility of one ownership and management (i.e., one business under one name). This may be a group of buildings attached or unattached with different addresses but under the responsibility of someone having mutual interest. The person of mutual interest is not the alarm-installing company.

Bell Location

The alarm sounding device (bell) must be located where it can be heard by the person or persons responsible for maintaining the security system during the daily arming cycle.

Protection of the Control Unit

The local control and the local power supply must be protected in one of the following ways:

- The control unit and audible alarm device must be in a protected area which is armed 24 hours a day.
- Each partition must arm the area protecting the control unit and the audible alarm device power supply. This may require duplicate protection armed by each partition. Access to this protected area, without causing an alarm, will require that all partitions be disarmed.
- In all cases described above, the protected area for the control unit must be programmed as not-bypassable.

Casual Users

The installer should caution the user(s) not to give system information to casual users (e.g. codes, bypass methods, etc. to baby-sitters or service people). Only the One-Time Use codes should be given to casual users.

User Information

The installer should advise the users and note in the User's Manual:

- Service organization name and telephone number
- The programmed exit time
- The programmed entry time
- Test system weekly

Two-Wire Smoke Detector Compatibility (if available)

- Maximum loop resistance: 24 Ohms
- Operating Voltage Range: 9.8 - 13.8 Vdc
- Maximum Alarm Current: 89 mA
- Compatibility Identifier: PC18-1

See **Section 5 PGM Wiring** for compatible 2-wire smoke detectors.

SIA FAR Installations

Minimum requirement system for SIA-FAR Installations:

- 1 PC1616/PC1832/PC1864 Control panel
- 2 Local annunciation devices

The local annunciation devices may be any combination of the following keypads, as long as there is at least one LCD keypad in the installation (Model LCD5500Z or PK5500).

- LCD5500Z
- LCD5501Z
- PK5500
- PK5508
- PKP-LCD
- PKP-ICN
- PK5501
- PK5516

The following optional subassembly modules also bear the SIA FAR classification and may be used if desired:

PC5108 Zone Expander Module

Compatible initiating devices: Bravo200 series, 300 series, 400 series, 500 series, 600 series, AC-100, Encore300 series, Force200 series, 210 series, MN240.

PC5208 Low Current PGM Output Module

The following optional accessory modules also bear the SIA FAR classification and may be used if desired.

PC5204 Auxiliary Power Supply with PGM output ports

Escort5580/Escort5580TC, PC5400 Printer Module

Caution

- For SIA FAR installations, only use modules / devices that are listed on this page.
- Fire Alarm Verification feature (Auto Verified Fire zone) is not supported on 2-wire smoke detectors zones. This feature may be enabled for 4-wire smoke detectors only.
- Call Waiting Cancel (Section 382 Option 4) feature on a non-Call Waiting line will prevent successful communication to the central station.
- All smoke detectors on the system must be tested annually by conducting the Installer Walk Test prior to exiting the walk test mode, a sensor reset must be conducted on the system, [*][7][2] to reset all latching 4-wire smoke detectors. Please refer to the smoke detector installation instructions on how to correctly test the detectors.

Notes

- Programming at installation may be subordinate to other UL requirements for the intended application.
- Cross zones have the ability to individually protect the intended area (e.g., motion detectors, which overlap).
- Cross zoning is not recommended for line security Installations nor is it to be implemented on exit / entry zones.
- There is a communication delay of 30 seconds in this control panel. It can be removed, or it can be increased up to 45 seconds at the option of the end user by consulting with the Installer.
- Do not duplicate any reporting codes. This applies for all communication formats other than SIA sending automatic programmed reporting codes.
- The control unit must be installed with a local sounding device and an off-premise transmission for SIA communication format.
- For ULC Listed Fire Monitoring Installations & module requirements, please refer to the ULC Installation Information sheet, part# 29002157.
- Use a CSA/cUL transformer, hardwired.
- All tamper circuits may be connected to the same zone.
Use ULC-LA for AC Power indication.

PC1616/PC1832/PC1864 Installer Programming Quick Reference Chart SIA False Alarm Reduction

SIA Feature Programming Section	Comments	Range/Default	Requirement
Exit Time [005], 3rd entry	Access to Entry and Exit delays for each partition and Bell Time Out for the system	For Full or auto arming: Range: 45- 255 seconds Default: 60 sec.	Required (programmable)
Progress Annunciation/ Disable - for Silent Exit [014], Option 6 ON	Enables audible exit beeps from the keypad for the duration of exit delay	Individual keypads may be disabled Default: All Enabled	Allowed
Exit Time Restart [018], Option 7 ON	Enables the exit delay restart feature	Default: Enabled	Required
Auto Stay Arm on Unvacated Premises [001]-[004] Zone type 05, 06	Function Key: Stay Arming. All Stay/Away type zones (05, 06) will be automatically bypassed	If no exit after full arm Default: Enabled	Required
Exit Time and Progress Annunciation/Disable or Remote Arming [005] and [014] bit 6	System Times and Audible Exit beeps can be disabled when using the Key fob to arm away the system	Default: Enabled	Allowed
Entry delay(s) [005], 1st and 2nd entry	Access to Entry and Exit delays for each partition and Bell Time Out for the system Note: Combined Entry delay and Communications Delay (Abort Window) shall not exceed 60s	Range: 30 sec. to 4 min. Default: 30 sees	Required (programmable)
Abort Window for Non-Fire zones [101]-[164] bit 7 ON	Access to zone attributes, i.e, swinger shutdown, transmission delay and cross zone. Individual zones attribute bit 7 (Transmission delay) is by default ON	May be disabled by zone or zone type Default: Enabled	Required
Abort Window - for Non-Fire zones [377], 4th entry	Access to the programmable delay before communicating alarms Note: Combined Entry delay and Communications Delay (Abort Window) shall not exceed 60s	Range: 15 - 45 sec. Default: 30 sees	Required (programmable)
Abort Annunciation [382], Option 3 ON	Enables the "Communication Cancelled" message display on all keypads	Annunciate that no alarm was transmitted Default: Enabled	Required
Cancel Annunciation [328], 8th entry	Access to the reporting code for Alarm Cancelled	Annunciate that a Cancel was transmitted Default: Enabled	Required
Duress Feature [*][5] Master Code 33rd and 34th entries	Do not derive code from an existing Master/User code (e.g., Master code is 1234, the duress code should not be 1233 or 1235)	No 1+ derivative of another user code. No duplicates with other user codes Default: disabled	Allowed
Cross Zoning [018] Option 6 [101]-[164] bit 9 OFF	This option enables Cross Zoning for entire system. Individual zones can be enabled for Cross zoning via Zone attribute bit 9 in sections [101] - [164]	Programming required Default: Disabled	Required
Cross Zone Timer [176]	Access to the programmable Cross Zone timer	May program Range: 001-255 sec./min. Default: 60 secs	Allowed
Swinger Shutdown for Alarms [377] 1st entry	Access to the swinger shutdown limit for zone alarms	For all non-fire zones shut down at 1 or 2 trips Default: 1 Trip	Required (programmable)
Swinger Shutdown Disable [101] - [164] bit 6 ON	Access to zone attributes, i.e., swinger shutdown, transmission delay and cross zone. Individual zones attribute bit 6 (Swinger shutdown enabled) is by default ON	For non-police response zones Default: Enabled	Allowed
Fire Alarm Verification Zone type [29]	Auto Verified Fire, use only with 4 wire type detectors that can be reset by the panel 4-wire smoke detector powered from AUX = and PGM1 - PGM4 (type 03, Sensor reset)	70 seconds reset and confirmation time Default: disabled	Required
Call Waiting Cancel Dial String [304], [382], Option 4 OFF	Access to the dialing sequence used to disable call waiting	Dependant on user phone line Default: disabled	Required
Testing			
System Test: [*][6] Master Code, Option 4	The system activates all keypad sounders, bells or sirens for 2 seconds and all keypad lights turn on. Refer to the <i>User Manual (part no. 29007165)</i> .		
Installer Walk Test Mode: [901]	This mode is used to test each zone on the system for proper functionality.		
Alarm Communications During Walk Test [382] Option 2:	Enables Communication of zone alarms while installer Walk Test is active.		
Walk Test End and Begin Reporting Codes [348], 1 st and 2 nd Entries	Access to the reporting codes for Walk Test Begin and Walk Test End.		

Appendix A: Reporting Codes

The following tables contain Contact ID and Automatic SIA format reporting codes. For more information on reporting code formats and notes about individual reporting codes, (see *Section 5.6 Communicator Programming PWS Sect 6*).

Contact ID

The first digit (in parentheses) will automatically be sent by the control. The second two digits are programmed to indicate specific information about the signal. For example, if zone 1 is an entry/exit point, you could program the event code as [34]. The central station would receive the following: *BURG - ENTRY/EXIT - 1 where the "1" indicates which zone went into alarm.

SIA Format - Level 2 (Hardcoded)

The SIA communication format used in this product follows the level 2 specifications of the SIA Digital Communication Standard - October 1997. This format will send the Account Code along with its data transmission. The transmission will look similar to the following at the receiver:

```
N Ri01    BA 01
N        = New Event
Ri01    = Partition /Area Identifier
BA      = Burglary Alarm
01      = Zone 1
```

NOTE: A system event will use the Area Identifier Ri00.

Section #	Reporting Code	Code Sent When...	Dialer Direction*	Automatic Contact ID Codes	SIA Auto Rep Codes**
[320]-[323]	Zone Alarms	Zone goes into alarm	A/R	See Table 3	See Table 3
[324]-[327]	Zone Restorals	Alarm condition has been restored	A/R		
[328]	Duress Alarm	Duress code entered at keypad	A/R	(1) 21	HA-00
[328]	Opening After Alarm	System disarmed with alarm in memory	A/R	(4) 58	OR-00
[328]	Recent Closing	Alarm occurs within two minutes of system arming	A/R	(4) 59	CR-00
[328]	Zone Expander Supervisory Alarm/Rest.	Panel loses/restores supervisory transmission over the Keybus from zone expansion modules, or keypads with zone inputs	A/R	(1) 43	UA-00/UH-00
[328]	Cross Zone (Police Code) Alarm	Two zones on the same partition go into alarm during any given armed-to-armed period (incl. 24Hr zones)	A/R	(1) 4A	BM-00/BV-00
[328]	Burglary Not Verified		A/R	(3) 78	XM-00
[328]	Alarm Cancelled		A/R	(4) A6	BC-00
[329]	[F] Key Alarm/Rest.	Keypad fire alarm (alarm and restore rep. codes sent together)	A/R	(1) 15	FA-00/FH-00
[329]	[A] Key Alarm/Rest.	Keypad auxiliary alarm (alarm and restore rep. codes sent together)	A/R	(1) AA	MA-00/MH-00
[329]	[P] Key Alarm/Rest.	Keypad panic alarm (alarm and restore rep. codes sent together)	A/R	(1) 2A	PA-00/PH-00
[329]	Aux Input Alarm/Rest	Option#23/24: a panic button wired to PGM 2 is pressed/access code is entered Option #04: a 2-wire smoke detector wired to PGM 2 goes into alarm/alarm is cleared.	A/R	(1) 4A	UA-99/UH-99
[329]	Aux Input Alarm/Rest	Option #04: a 2-wire smoke detector wired to PGM 2 goes into alarm/alarm is cleared.	A/R	(1) 11	FA-99/FH-99
[330]-[337]	Zone Tamper/Restoral	Zone is tampered / tamper condition restored	T/R	(1) 44	TA-ZZ/TR-ZZ
[338]	General System Tamper/Rest.	Enrolled module with tamper inputs has a tamper alarm/all module tampers restored	T/R	(1) 45	TA-00/TR-00
[338]	Keypad Lockout	Maximum number of incorrect access codes has been entered at a keypad	T/R	(4) 21	JA-00
[339-341]	Closings	System armed (user 01-34, 40-42 indicated)	O/C	(4) A1	CL-UU
[341]	Partial Closing	One or more zones bypassed when system armed	O/C	(4) 7A	CG-ZZ
[341]	Special Closing	Closing (arming) using one of the following methods: quick arm, auto arm, keyswitch, function key, maintenance code, DLS software, wireless key	O/C	(4) AA	CL-00
[341]	Late to Close	Whenever the Auto-arm prealert sounds (if the Late to Close option is enabled)	O/C	(4) A4	CI-00
[341]	Exit Fault		O/C	(3) 74	EE-00
[342-344]	Openings	System disarmed (user 01-34, 40-42 indicated)	O/C	(4) A1	OP-UU
[344]	Auto-arm Cancellation	Auto-arm cancelled	O/C	(4) A5	CE-00
[344]	Special Opening	Opening (disarming) using one of the following methods: key-switch, maintenance code, DLS software, wireless key	O/C	(4) AA	OP-00
[345]-[346]	Battery Trouble/Rest.	PC1616/PC1832/PC1864 battery is low/battery restored	MA/R	(3) A2	YT-00/YR-00
[345]-[346]	AC Line Trouble/Rest.	AC power to control panel is disconnected or interrupted/AC power restored (Both codes follow AC Failure Comm. Delay.)	MA/R	(3) A1	AT-00/AR-00
[345]-[346]	Bell Circuit Trouble/Rest.	Open or short circuit detected across bell terminals/bell circuit restored	MA/R	(3) 21	YA-99/YH-99
[345]-[346]	Fire Trouble/Rest.	Trouble occurs/restores on a fire zone	MA/R	(3) 73	FT-00/FJ-00

Section #	Reporting Code	Code Sent When...	Dialer Direction*	Automatic Contact ID Codes	SIA Auto Rep Codes**
[345]-[346]	Auxiliary Power Trouble/ Rest.	Aux voltage supply trouble/restoral	MA/R	(3) AA	YP-00/YQ-00
[345]	TLM Failure	Telephone line monitoring trouble	MA/R	(3) 51	LT-00
[346]	TLM Restore	Telephone line restored	MA/R	(3) 51	LR-00
[345]-[346]	Gen System Trouble/Rest.	"Service Required" trouble occurs (view troubles using [*][2])/trouble restored	MA/R	(3) AA	YX-00/YZ-00
[345]-[346]	Gen System Supervisory Trouble/Rest.	Control panel loses/restores communications with module(s) connected to the Keybus	MA/R	(3) 33	ET-00/ER-00
[347]	Phone# 1 or 2 FTC Restoral	Control panel has restored communications to central station on Phone# 1 or 2 (after FTC)	MA/R	(3) 54	YK-00
[347]	Event Buffer is 75% Full	Event buffer is almost full since last upload	MA/R	(6) 23	JL-00
[347]	DLS Lead In	Downloading session start	MA/R	(4) 11	RB-00
[347]	DLS Lead Out	Downloading session complete	MA/R	(4) 12	RS-00
[347]	Zone Fault/Rest.	One or more zones have faults/restored	MA/R	(3) 72	UT-ZZ/UJ-ZZ
[347]	Delinquency	Programmed amount of time (days or hours) for delinquency has expired without zone activity, or without system being armed	MA/R	(4) 54***	CD-00
[347]	Wireless Device Low Battery Trouble/Rest.	Wireless zones, panic pendants, handheld keypads, wireless keys have low battery/all low batteries restored	MA/R	(3) 84	XT-00/XR-00 XT-ZZ/XR-ZZ****
[347]	Installer Lead In	Installer's mode has been entered	MA/R	(6)27	LB-00
[347]	Installer Lead Out	Installer's mode has been exited	MA/R	(6)28	LS-00
[348]	Walk Test End	End of test	T	(6) A7	TS-00
[348]	Walk Test Begin	Beginning of test	T	(6) A7	TE-00
[348]	Periodic Test with Trouble	Periodic system test transmission with trouble	T	(6) A8	RP-01
[348]	Periodic Test	Periodic system test transmission	T	(6) A2	RP-00
[348]	System Test	[*][6] bell/communications test	T	(6) A1	RX-00
[349]	PC5700 Ground Fault Trouble/Restore	Ground/Fault/Trouble occurs on the PC5700	MA/R	(3) 1A	US-00
[349]	PC5700 TLM Line 1 Trouble/Restore	TLM Trouble /Restore occurs on the PC5700	MA/R	(3) 51	LT-XX
[349]	PC5700 TLM Line 2 Trouble/Restore	TLM Trouble /Restore occurs on the PC5700	MA/R	(3) 52	LR-XX

* A/R = alarms/restorals; T/R = tampers/restorals; O/C = openings/closings; MA/R = miscellaneous alarms/restorals; T = test transmissions
** UU = user number (user01-42); ZZ = zone number (01-64)
*** Use the "Fail to close" event code [(4)54] to report closing or activity delinquency. Ensure the central station is aware that this code is used.
**** Zones are identified, panic pendants, wireless keys, and handheld keypads are not.

Contact ID Zone Alarm/Restoral Event Codes

(as per SIA DCS: 'Contact ID' 01-1999):

Program any of these codes for zone alarms/restorals when using the standard (non-automatic) Contact ID reporting format.

Medical Alarms	(1)34 Entry / Exit
(1)AA Medical	(1)35 Day / Night
(1)A1 Pendant Transmitter	(1)36 Outdoor
(1)A2 Fail to Report In	(1)37 Tamper
Fire Alarms	(1)38 Near Alarm
(1)1A Fire Alarm	General Alarms
(1)11 Smoke	(1)4A General Alarm
(1)12 Combustion	(1)43 Exp. module failure
(1)13 Water Flow	(1)44 Sensor tamper
(1)14 Heat	(1)45 Module Tamper
(1)15 Pull Station	(1)4A Cross Zone Police Code
(1)16 Duct	24 Hour Non-Burglary
(1)17 Flame	(1)5A 24 Hour non-Burg
(1)18 Near Alarm	(1)51 Gas detected
Panic Alarms	(1)52 Refrigeration
(1)2A Panic	(1)53 Loss of Heat
(1)21 Duress	(1)54 Water Leakage
(1)22 Silent	(1)55 Foil Break
(1)23 Audible	(1)56 Day Trouble
Burglar Alarms	(1)57 Low bottled Gas level
(1)3A Burglary	(1)58 High Temp
(1)31 Perimeter	(1)59 Low Temp
(1)32 Interior	(1)61 Loss of Air Flow
(1)33 24 Hour	

SIA Format Automatic Zone Alarm/Restoral Codes

Zone Definition	SIA Auto Rep Codes*	Contact ID Auto Rep Codes*
Delay 1	BA-ZZ/BH-ZZ	(1) 3A
Delay 2	BA-ZZ/BH-ZZ	(1) 3A
Instant	BA-ZZ/BH-ZZ	(1) 3A
Interior	BA-ZZ/BH-ZZ	(1) 3A
Interior Stay/Away	BA-ZZ/BH-ZZ	(1) 3A
Delay Stay/Away	BA-ZZ/BH-ZZ	(1) 3A
Delayed 24-Hr Fire	FA-ZZ/FH-ZZ	(1) 1A
Standard 24-Hr Fire	FA-ZZ/FH-ZZ	(1) 1A
24-Hr Supervisory	US-ZZ/UR-ZZ	(1) 5A
24-Hr Supervisory Buzzer	UA-ZZ/UH-ZZ	(1) 4A
24-Hr Burg	BA-ZZ/BH-ZZ	(1) 3A
24-Hr Holdup	HA-ZZ/HH-ZZ	(1) 22
24-Hr Gas	GA-ZZ/GH-ZZ	(1) 51
24-Hr Heat	KA-ZZ/KH-ZZ	(1) 58
24-Hr Medical	MA-ZZ/MH-ZZ	(1) AA
24-Hr Panic	PA-ZZ/PH-ZZ	(1) 2A
24-Hr Emergency (non-medical)	QA-ZZ/QH-ZZ	(1) A1
24-Hr Sprinkler	SA-ZZ/SH-ZZ	(1) 54
24-Hr Freeze	ZA-ZZ/ZH-ZZ	(1) 59
24-Hr Latching	UA-ZZ/UH-ZZ	(1) 4A
Interior Delay	BA-ZZ/BH-ZZ	(1) 3A
Auto Verified Fire	FA-ZZ/FH-ZZ	(1) 1A
24-Hr Fire Supervisory	FS-ZZ/FV-ZZ	(2) AA
Day Zone	BA-ZZ/BH-ZZ	(1) 3A
Instant Stay/Away	BA-ZZ/BH-ZZ	(1) 3A
Final Door Set	BA-ZZ/BH-ZZ	(1) 3A
24-Hr Bell/Buzzer	UA-ZZ/UH-ZZ	(1) 4A
Night Zone	BA-ZZ/BH-ZZ	(1) 3A
Delayed 24-Hr Fire (Wireless)	FA-ZZ/FH-ZZ	(1) 1A
Standard 24-Hr Fire (Wireless)	FA-ZZ/FH-ZZ	(1) 1A

* ZZ = zones 01-64

Appendix B: Wiring Diagrams

B.1 PC1616/PC1832/PC1864 UL/ULC Wiring Diagram

PC1616/PC1832/PC1864 UL/ULC Wiring Diagram

APPLICABLE UL STANDARDS UL FILE NO. 54019

- UL1610 Central-Station Burglar Alarm Units
- UL609 Local Burglar Alarm Units and Systems
- UL365 Police Station Connected Burglar Alarm Units & Systems
- UL985 Household Fire Warning System Units
- UL1023 Household Burglar Alarm System Units
- UL1635 Digital Alarm Communicator System Units
- UL1837 Home Health Care Signaling Equipment
- ANSI/SIA CP-01-2000

SIA-FAR Minimum System Requirements:
1 PC1616/1832/1864 Panel
2 Local annunciation devices

Local annunciation devices may be any combination of these keypads:
LCD5500Z, LCD5501Z, PKP-LCD, PKP-ICN

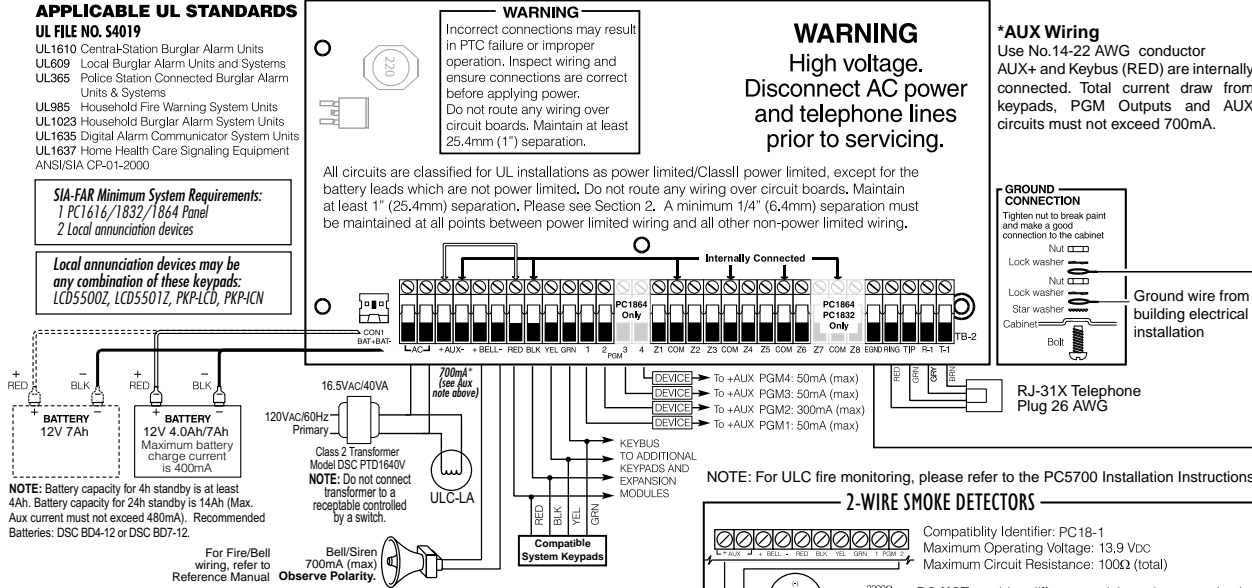

NOTE: Battery capacity for 4h standby is at least 4Ah. Battery capacity for 24h standby is 14Ah. (Max. Aux current must not exceed 480mA). Recommended Batteries: DSC BD-12 or DSC BD7-12.

For Fire/Bell wiring, refer to Reference Manual
Bell/Siren 700mA (max) Observe Polarity.

NOTE: For ULC fire monitoring, please refer to the PC5700 Installation Instructions

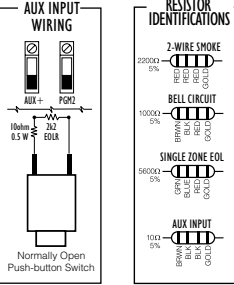
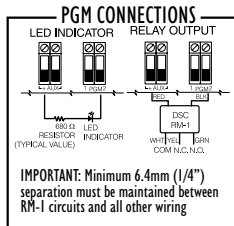
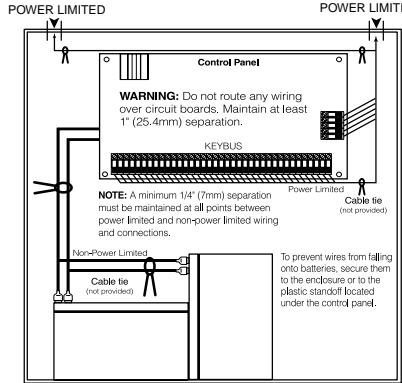

Temperature Range: 0°C-49°C [32°F-120°F] / Maximum Humidity: 85% R.H.
For detailed installation and operating instructions, refer to the Installation Guide #29007109, User Manual #29007165 and the Reference Manual #29007160 (available on the DSC website). The PC1616/PC1832/PC1864 is UL Listed for limited energy installations per NEC Article 760. Recognized limited energy cable should be used. Observe NEC wiring requirements and local codes defined by the authority having jurisdiction. Security detection devices that require power from the control panel must be UL Listed for the intended application and operate over the range of 11.6-12.6VDC (residential), 12.0VDC (commercial). The DSC Bravo Series are recommended UL Listed motion detectors. Compatible system keypads: PC5508Z/KP5508Z, PC5516Z/KP5516Z, PC5532Z/KP5532Z, LCD5500Z/KP5500Z, LCD5501, PKP-LCD, PKP-ICN, LCD5501Z32-433.

ULC NOTES

- For ULC Listed Fire Monitoring Installations & module requirements, please refer to the ULC Installation Information Sheet, part #29002157.
- Use a CSA/cUL transformer, hardwired.
- All tamper circuits may be connected to the same zone.
- Use ULC-LA for AC Power indication.

WARNING: Not to be removed by anyone except occupant. This equipment should be installed in accordance with the National Fire Code ANSI/NFPA 72 (National Fire Protection Association, Batterymarch Park, Quincy MA, 02269). Printed information describing proper installation, operation, testing, maintenance, evacuation planning, and repair service is to be provided with this equipment. For compliance with UL-985, at least one hardwired smoke detector is required.

This device complies with Parts 15 and 68 of the FCC rules. Operation is subject to the following 2 conditions: [1] this device may not cause harmful interference and [2] this device must accept any interference received, including interference that may cause undesired operation.
Model: PC1864 FCC Reg. No. F53ALO1BPC1864
Model: PC1832 FCC Reg. No. F53ALO1BPC1832
Model: PC1616 FCC Reg. No. F53ALO1BPC1614
REN = 0.1B Plug Type: RJ-31X MADE IN CANADA

NOTE: For ULC installations, please refer to the ULC Wiring Diagram part#18006238 and the ULC Installation Information Sheet part#29002157.

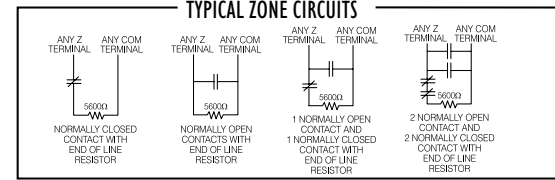
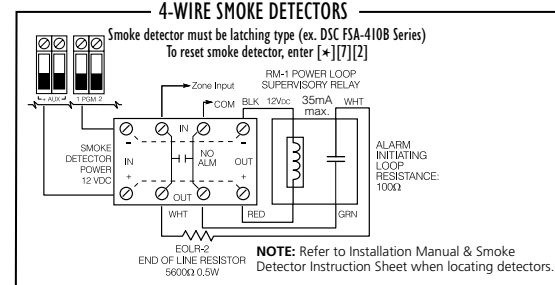
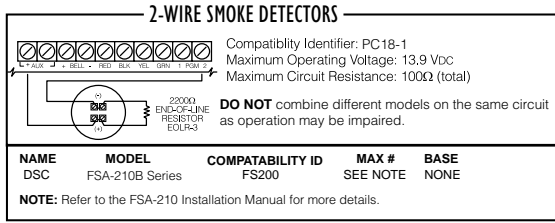

Circuit (zone)	Control Unit Delay - Sec.	Smoke Detector	
		Model	Delay - Sec. (a)

(a) The delay (power-up) time marked on the installation wiring diagram of the smoke detector or on the installed smoke detector(s) is to be used.

Control panel is suitable for the following UL installations: (1) Grade AA Central Station and Grade AA Police Connect with high line security (using T-LINK to communicate to the Sur-Gard MLR-IP Receiver). (2) Household Fire and Grade A Household Burglary and Home Health Care Signaling Equipment. (3) Grade A Local I Grade B Central Station and Police Connect with basic line security. (4) Grade C Central Station. Refer to Installation Manual

B.2 PC1616/PC1832/PC1864 Standard Wiring Diagram

North America Only

1. Insert Stand off into cabinet mounting hole in the desired location. Snap-in-place.
2. Position circuit board mounting holes over standoffs. Press firmly on board to snap-in-place.

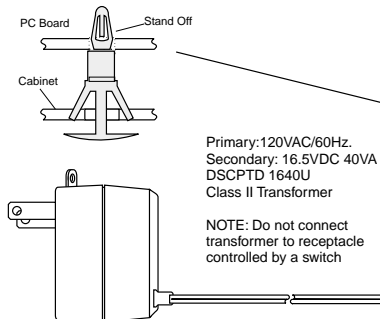

230 VAC/50 Hz International

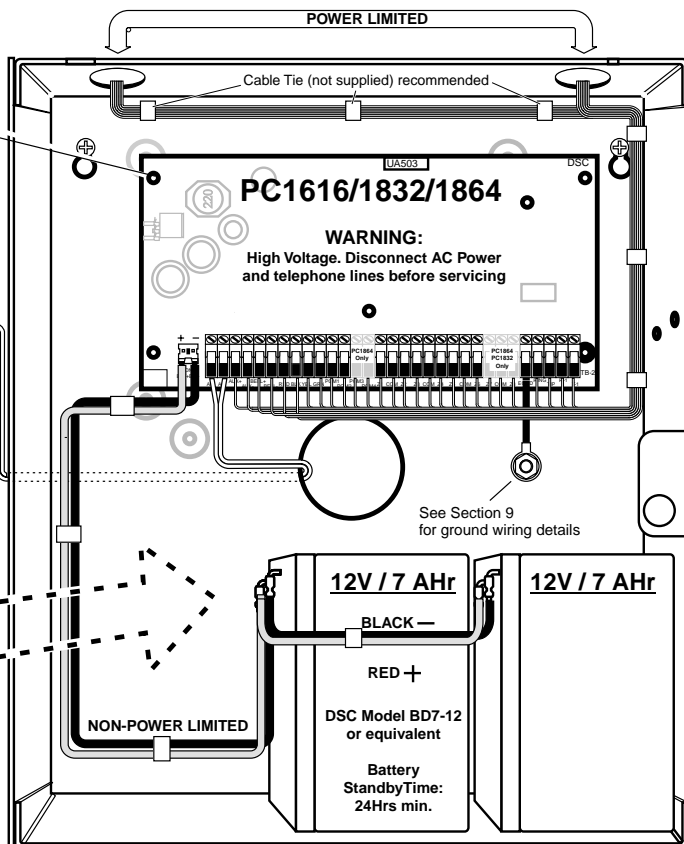
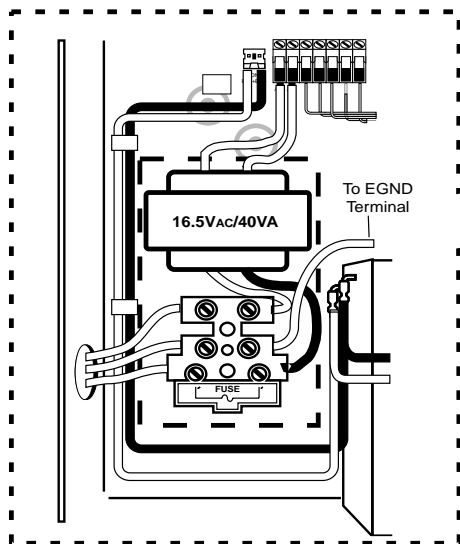

WARNING: Incorrect connections may result in PTC failure or improper operation. Inspect wiring and ensure connections are correct before applying power.

Incorrect connection of batteries may result in battery rupture or Fire Hazard. Do NOT allow metal objects to connect the Positive and Negative Terminals. Ensure that batteries are connected with correct polarity (Red to (+), Black to (-)). Failure to comply with this may result in battery rupture and/or Fire Hazard. All circuits are classified for UL Installations as Power Limited/Class II Power Limited except for battery leads which are not power limited.

Do NOT route any wiring over circuit boards. Maintain at least 1" (25.4mm) separation. A minimum of 1/4" (6.4mm) separation must be maintained at all points between power limited wiring and all other non-power limited wiring.

IMPORTANT:

- This equipment, Alarm Controller PC1616/1832/1864 shall be installed and used within an environment that provides the pollution degree max 2 and overvoltages category II NON-HAZARDOUS LOCATIONS, indoor only. The equipment is FIXED and PERMANENTLY connected and is designed to be installed by service persons only; [service person is defined as a person having the appropriate technical training and experience necessary to be aware of hazards to which that person may be exposed in performing a task and of measures to minimize the risks to that person or other persons.]
- The connection to the mains supply must be made as per the local authorities rules and regulations. An appropriate disconnect device must be provided as part of the building installation. Where it is not possible to rely on identification of the neutral in the AC Mains supply the disconnecting device must disconnect both poles simultaneously (line and neutral). The device shall disconnect the supply during servicing.
- The equipment enclosure must be secured to the building structure before operation.
- Internal wiring must be routed in a manner that prevents:
 - Excessive strain on wire and on terminal connections;
 - Loosening of terminal; connections;
 - Damage of conductor insulation
- Disposal of the used batteries shall be made according to the waste recovery and recycling regulations applicable to the intended market.
- Before servicing, DISCONNECT the telephone connection.

WARNING:
High Voltage. Disconnect AC Power and telephone lines before servicing

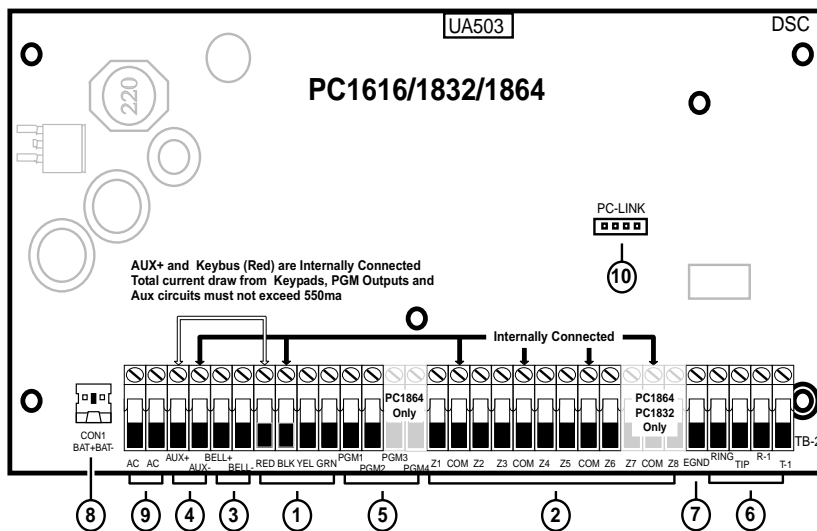

See corresponding Section NumberText for wiring details.

B.3 PC1616/PC1832/PC1864 European Wiring Diagram

1. Insert Stand off into cabinet mounting hole in the desired location. Snap-in-place.
2. Position circuit board mounting holes over standoffs. Press firmly on board to snap-in-place.

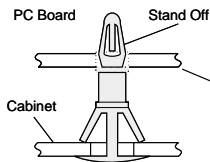

220 - 240VAC, 50/60Hz, 200mA

IMPORTANT!

Minimum 1/4" (6.4mm) separation must be maintained at all points between BATTERY/AC WIRING and all other wiring connections

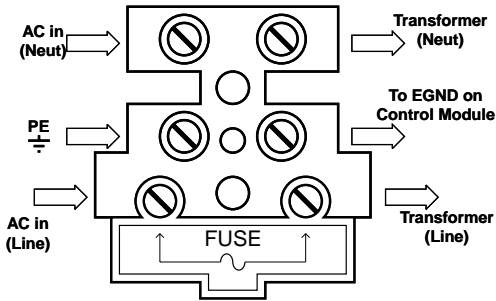

PC5003C Cabinet Shown
Use Model Power UC1 for (2) Battery Installations

IMPORTANT:

1. This equipment, Alarm Controller PC1616/1832/1864/ETC shall be installed and used within an environment that provides the pollution degree max 2 and overvoltages category II NON HAZARDOUS LOCATIONS, indoor only. The equipment is FIXED and PERMANENTLY CONNECTED and is designed to be installed by service persons only; [service person is defined as a person having the appropriate technical training and experience necessary to be aware of hazards to which that person may be exposed in performing a task and of measures to minimize the risks to that person or other persons.]
2. The connection to the mains supply must be made as per the local authorities rules and regulations: In the UK as per BS6701. An appropriate disconnect device must be provided as part of the building installation. Where it is not possible to rely on identification of the NEUTRAL in the AC MAINS SUPPLY, the disconnecting device must disconnect both poles simultaneously (LINE and NEUTRAL). The device shall disconnect the supply during servicing.
3. The equipment enclosure must be secured to the building structure before operation.
4. Internal wiring must be routed in a manner that prevents:
 - Excessive strain on wire and on terminal connections;
 - Loosening of terminal connections;
 - Damage of conductor insulation
5. Disposal of the used batteries shall be made according to the waste recovery and recycling regulations applicable to the intended market.
6. Before SERVICING, DISCONNECT the TELEPHONE CONNECTION.

WARNING:
High Voltage. Disconnect AC Power and telephone lines before servicing

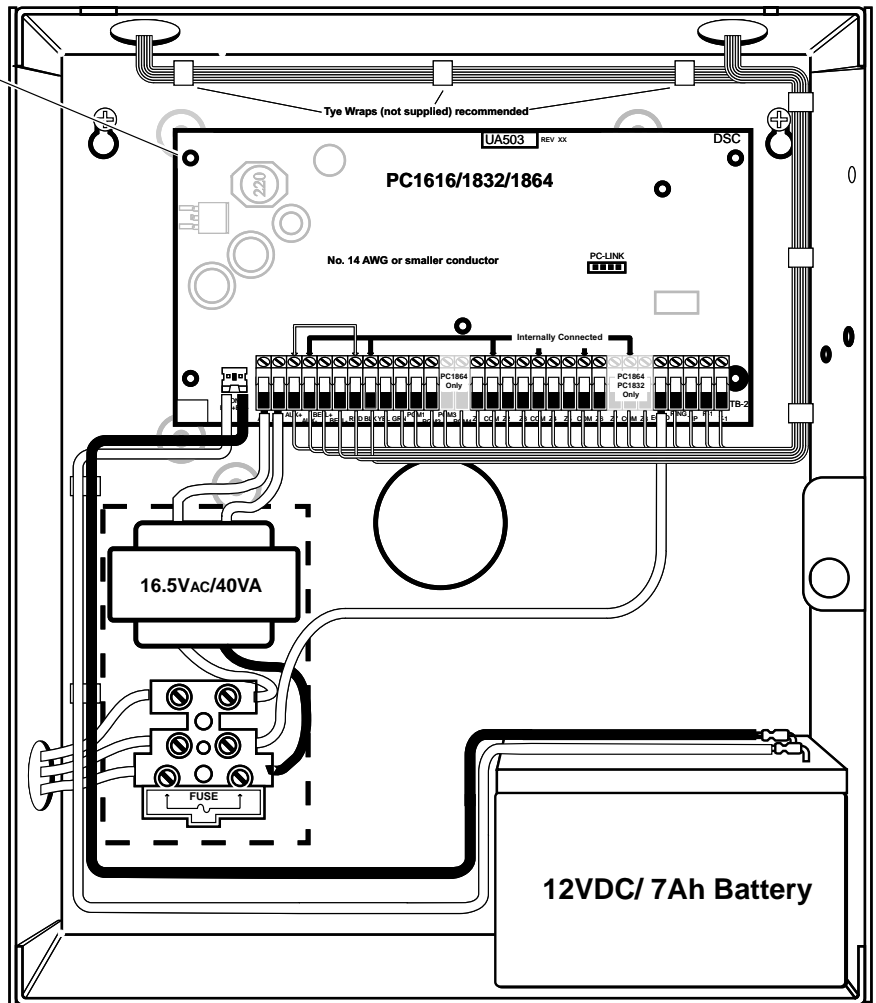

WARNING: Incorrect connections may result in PTC failure or improper operation. Inspect wiring and ensure connections are correct before applying power.

Do NOT route any wiring over circuit boards. Maintain at least 1"(25.4mm) separation.

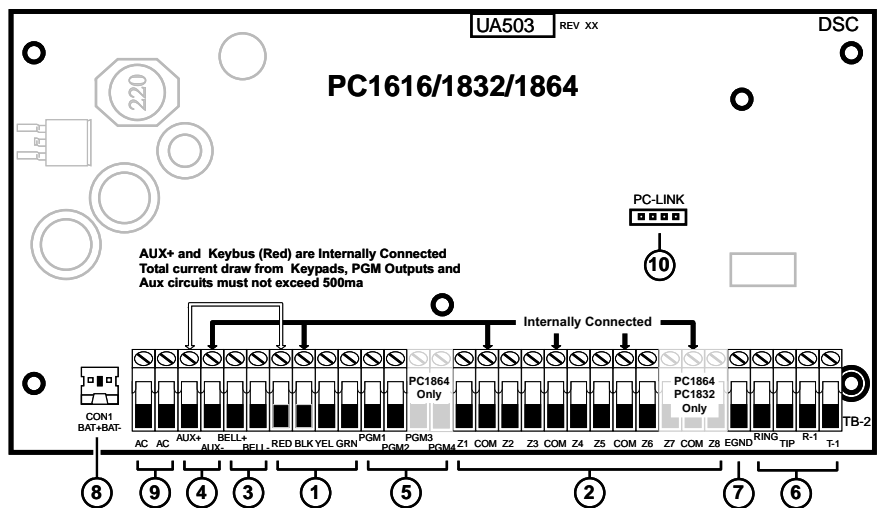

B.4 PC1616/PC1832/PC1864 and PC5700 Fire Module Communications Connections

For ULC Listed Fire Monitor Installations

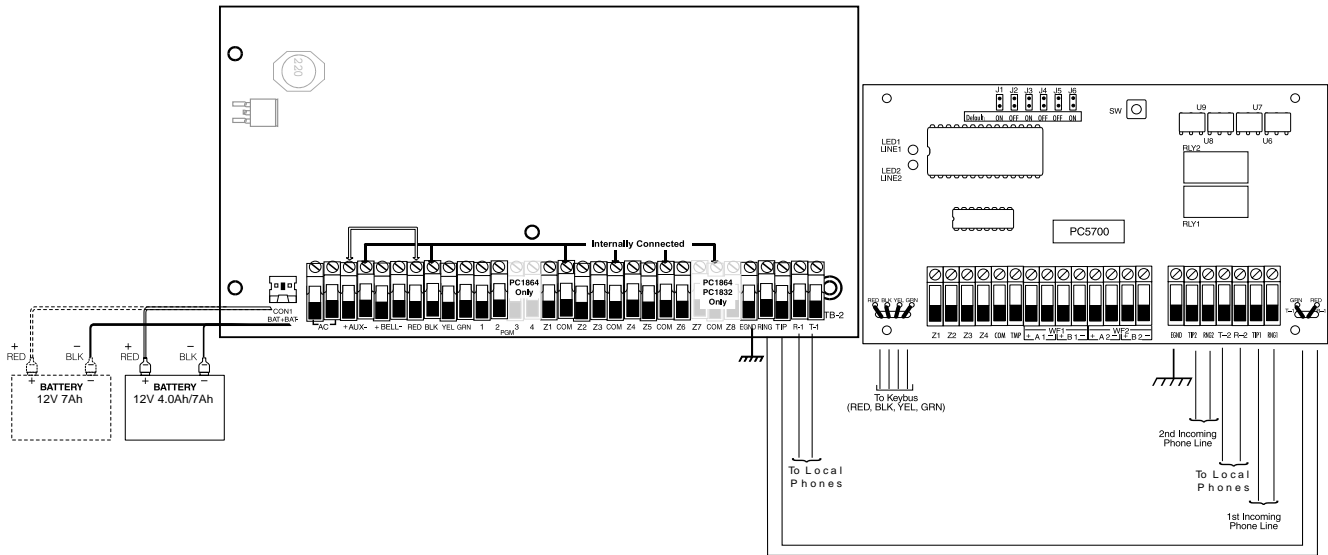

B.5 Sensor Reset for 2-Wire Smoke Detectors

AUX Connection

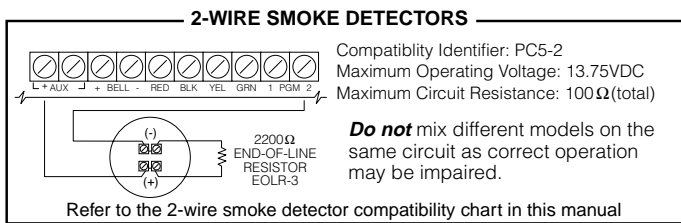

NOTE: Do not combine the 2-wire smoke detector and 4-wire smoke detector on PGM2 (only 2-wire smoke detectors on PGM2).

B.6 Sensor Reset for 4-wire Smoke Detectors

AUX Connection

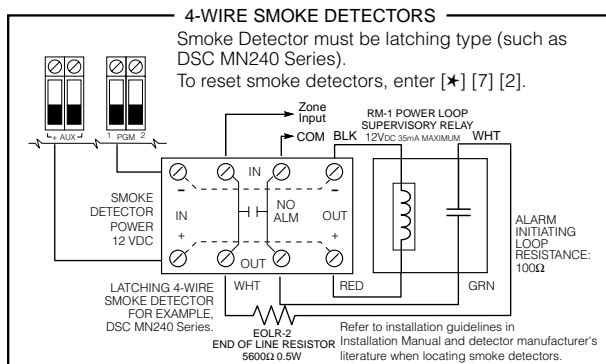

B.7 Other PGM Connections

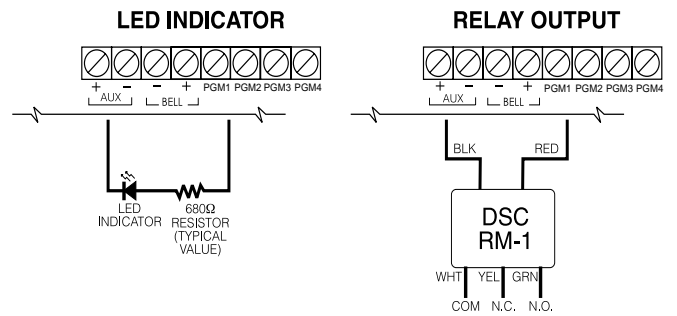

NOTE: For devices requiring more than 50mA, use a relay (DSC RM-1) or UL-recognized parts only for this application.

NOTE: The RM-1 relay module cannot be installed outside of the main panel enclosure.

Index

Numerics

200 Baud FSK **40**
2-Wire Smoke Reset **22**
4-Wire Smoke Detector Zones **51**

A

AC Delays **53**
 transmission **53**
AC Trouble **27, 52**
AC Trouble Beeps **29**
Access Codes Blocked **30**
Alarm
 display **52**
 operation **52**
Alarm Memory **14**
Arming **12**
Arming Without Entry Delay **16**
Audible 24-hr **23**
Audible Exit Beeps **26**
Audible Exit Fault **25**
Audible Wireless Zone Fault **29**
Auto Verify Fire **51**
Auto-arm Schedule **16**
Auto-arm Schedule Programming **25**
Auto-Scroll **52**

B

Backlighting **27**
Backlighting Boost **18**
Battery Connection **5**
Battery Trouble **52**
Bell Cut-off **52**
Bell Delay Timer **34**
Bell During Auto-arm **25**
Bell Squawk **25**
Bell Squawk on Away **28**
Burglary/Fire Bell Follower **22**
Bypass Access Code **26**
Bypass Status Display **27**

C

Cabinets **4**
CESA **40**
Command Output Functions **16**
Command Outputs **23**
Commands **13**
Communication Variables **41**
Communicator Call Directions **41**
Communicator Format Options **38**
Communicator Programming **35**
Contact ID **38**
Courtesy Pulse **22**
Cross Zone/Police Code **29**

D

Daylight Saving Time **33**
Daylight Savings Time **28**
Delay Fire and Burglary Output **23**
Dialing Attempts **33**
Disarming **13**

DLS, Enable **16**
Door Chime **14**
Double End of Line Resistors **9**
Double Hit **28**
Downloading Option Codes,
 First **45**
Downloading Options **45**
Duress Codes **14, 15**

E

Eighth System Option Codes **30**
End-of-Line **24**
Engineer's Reset **31**
Event Buffer Follows Swinger
 Shutdown **25**
Event Log **13**
Exit Delay Restart **29**
Exit Delay Termination **26**

F

26
Factory Defaults **50**
Fail To Communicate **53**
Fast Loop Response **33**
Fifth System Option Codes **27**
Fire Bell Timeout **26**
Fire Signaling **25**
Fire System
 configuration **51**
 partitions **51**
Fire Timeout **52**
Fire Trouble **52**
Fire Zone Wiring **9**
First International Option Codes **48**
First System Option Codes **24**
Fourth System Option Codes **27**
Function Key Programming **8**
Function Keys **17**

G

global keypad **18**
Green LED **29**
Ground Fault **53**
Ground Start **23**

H

Holdup Output **23**

I

Inhibit Arming **12**
Installer Lockout Enable **50**
Installer Programming **11, 16**
Installer Walk Test Mode **49**
Installer's Code **21**
International Programming **47**

K

Key **26**
Key Announcement **26**
Keybus Fault **29**
Keypad Assignment **7**
Keypad Blanking **27**
Keypad Buzzer Follow **22**
Keypad Commands **12**

Keypad Lockout **24**
Keypad Lockout Options **24**
Keypad Tamper **27**
Keypad Zone Assignment **10, 30**
Keypad Zones **10**
Keyswitch Zone Wiring **10**
Kissoff **23**

L

Latched System Event **22**
Late To Close **28**
LCD Keypad User Functions **16**
LCD5500Z **18**
Local Downlook Remote Trigger **50**

M

Maintenance Code **15, 21**
Master Code **21, 26**
Module Placement Test **50**
Module Supervision **8, 49**
Module Supervision Field **49**

N

Ninth System Option Codes **32**
Normally Closed Loops **8**

P

26
Pager Format **39**
Partition Keypad **18**
Periodic DLS Time of Day **42**
Periodic Test Transmission **28**
PGM Partition Assignment **47**
Police Code Output **23**
Post Dial Wait For Handshake **33**
Power Save **27**
Private Line Format **39**
Programmable Output Attributes **46**
Programmable Output Options **21**
Programming Access Codes **14**
Programming Sections **19**
Pulse Formats **40**

Q

Quick Arm **17**
Quick Arming/Function Key **26**
Quick Exit **17, 26**

R

Ready To Arm **22**
Remote Reset **31**
Removing Modules **8**
Reporting Codes **38, 53**
Residential Dial **39**
RF Delinquency **32**
RF Jam Event Log **27**
RF Jam Trouble Beeps **27**
Robofon **40**

S

Scantronics **40**
Second International Option Codes **48**
Second System Option Codes **25**
Sensor Reset **22, 52**
Settle Delay Timer **34**
SIA **38, 39**
Silence Bells
 automatic **52**
 manual **52**
Silent 24-hr Input **23**
Single End Of Line Resistors **9**
Sixth System Option Codes **28**
Stay/Away Arming **12**
Supervisor Codes **14, 15**
System Armed Status **22**
System Master Code **15**
System Tamper **22**
System Test **16**
System Times **21**
System Trouble **22**

T

Tamper/Faults Display **24**
Telephone Line Monitor **26, 41**
Tenth System Option Codes **32**
Terminal Descriptions **5**
Test Transmission Time of Day **42**
Time and Date **16, 18**
Transmission Delay **30**
Trouble
 AC **52**
 battery **52**
 display **52**
 fail to communicate **53**
 fire **52**
 ground fault **53**
Trouble Display **13, 24**
Troubles, Latching **29**

U

UL Requirements **54**
User Functions **16**
User Walk Test **16**

W

Wireless Key Disarming **27**
Wiring Diagrams **58**
 4-wire smoke **61**
 communications **61**
 outputs **61**
 power **61**

Z

Zone
 4-wire smoke **51**
 auto verify **51**
Zone Activity Log **10**
Zone Attributes **33**
Zone Bypassing **13**
Zone Loop **24**

LIMITED WARRANTY

Digital Security Controls warrants the original purchaser that for a period of twelve months from the date of purchase, the product shall be free of defects in materials and workmanship under normal use. During the warranty period, Digital Security Controls shall, at its option, repair or replace any defective product upon return of the product to its factory, at no charge for labour and materials. Any replacement and/or repaired parts are warranted for the remainder of the original warranty or ninety (90) days, whichever is longer. The original purchaser must promptly notify Digital Security Controls in writing that there is defect in material or workmanship, such written notice to be received in all events prior to expiration of the warranty period.

International Warranty

The warranty for international customers is the same as for any customer within Canada and the United States, with the exception that Digital Security Controls shall not be responsible for any customs fees, taxes, or VAT that may be due.

Warranty Procedure

To obtain service under this warranty, please return the item(s) in question to the point of purchase. All authorized distributors and dealers have a warranty program. Anyone returning goods to Digital Security Controls must first obtain an authorization number. Digital Security Controls will not accept any shipment whatsoever for which prior authorization has not been obtained.

Conditions to Void Warranty

This warranty applies only to defects in parts and workmanship relating to normal use. It does not cover:

- damage incurred in shipping or handling;
- damage caused by disaster such as fire, flood, wind, earthquake or lightning;
- damage due to causes beyond the control of Digital Security Controls such as excessive voltage, mechanical shock or water damage;
- damage caused by unauthorized attachment, alterations, modifications or foreign objects;
- damage caused by peripherals (unless such peripherals were supplied by Digital Security Controls);
- defects caused by failure to provide a suitable installation environment for the products;
- damage caused by use of the products for purposes other than those for which it was designed;
- damage from improper maintenance;
- damage arising out of any other abuse, mishandling or improper application of the products.

Digital Security Controls liability for failure to repair the product under this warranty after a reasonable number of attempts will be limited to a replacement of the product, as the exclusive remedy for breach of warranty. Under no circumstances shall Digital Security Controls be liable for any special, incidental, or consequential damages based upon breach of warranty, breach of contract, negligence, strict liability, or any other legal theory. Such damages include, but are not limited to, loss of profits, loss of the product or any associated equipment, cost of capital, cost of substitute or replacement equipment, facilities or services, down time, purchaser's time, the claims of third parties, including customers, and injury to property.

Disclaimer of Warranties

This warranty contains the entire warranty and shall be in lieu of any and all other warranties, whether expressed or implied (including all implied warranties of merchantability or fitness for a particular purpose) and of all other obligations or liabilities on the part of Digital Security Controls. Digital Security Controls neither assumes responsibility for nor authorizes any other person purporting to act on its behalf to modify or to change this warranty, nor to assume for it any other warranty or liability concerning this product.

This disclaimer of warranties and limited warranty are governed by the laws of the province of Ontario, Canada.

WARNING: Digital Security Controls recommends that the entire system be completely tested on a regular basis. However, despite frequent testing, and due to, but not limited to, criminal tampering or electrical disruption, it is possible for this product to fail to perform as expected.

Installer's Lockout

Any products returned to DSC which have the Installer's Lockout option enabled and exhibit no other problems will be subject to a service charge.

Out of Warranty Repairs

Digital Security Controls will at its option repair or replace out-of-warranty products which are returned to its factory according to the following conditions. Anyone returning goods to Digital Security Controls must first obtain an authorization number. Digital Security Controls will not accept any shipment whatsoever for which prior authorization has not been obtained.

Products which Digital Security Controls determines to be repairable will be repaired and returned. A set fee which Digital Security Controls has predetermined and which may be revised from time to time, will be charged for each unit repaired.

Products which Digital Security Controls determines not to be repairable will be replaced by the nearest equivalent product available at that time. The current market price of the replacement product will be charged for each replacement unit.

WARNING Please Read Carefully

Note to Installers

This warning contains vital information. As the only individual in contact with system users, it is your responsibility to bring each item in this warning to the attention of the users of this system.

System Failures

This system has been carefully designed to be as effective as possible. There are circumstances, however, involving fire, burglary, or other types of emergencies where it may not provide protection. Any alarm system of any type may be compromised deliberately or may fail to operate as expected for a variety of reasons. Some but not all of these reasons may be:

■ Inadequate Installation

A security system must be installed properly in order to provide adequate protection. Every installation should be evaluated by a security professional to ensure that all access points and areas are covered. Locks and latches on windows and doors must be secure and operate as intended. Windows, doors, walls, ceilings and other building materials must be of sufficient strength and construction to provide the level of protection expected. A reevaluation must be done during and after any construction activity. An evaluation by the fire and/or police department is highly recommended if this service is available.

■ Criminal Knowledge

This system contains security features which were known to be effective at the time of manufacture. It is possible for persons with criminal intent to develop techniques which reduce the effectiveness of these features. It is important that a security system be reviewed periodically to ensure that its features remain effective and that it be updated or replaced if it is found that it does not provide the protection expected.

■ Access by Intruders

Intruders may enter through an unprotected access point, circumvent a sensing device, evade detection by moving through an area of insufficient coverage, disconnect a warning device, or interfere with or prevent the proper operation of the system.

■ Power Failure

Control units, intrusion detectors, smoke detectors and many other security devices require an adequate power supply for proper operation. If a device operates from batteries, it is possible for the batteries to fail. Even if the batteries have not failed, they must be charged, in good condition and installed correctly. If a device operates only by AC power, any interruption, however brief, will render that device inoperative while it does not have power. Power interruptions of any length are often accompanied by voltage fluctuations which may damage electronic equipment such as a security system. After a power interruption has occurred, immediately conduct a complete system test to ensure that the system operates as intended.

■ Failure of Replaceable Batteries

This system's wireless transmitters have been designed to provide several years of battery life under normal conditions. The expected battery life is a function of the device environment, usage and type. Ambient conditions such as high humidity, high or low temperatures, or large temperature fluctuations may reduce the expected battery life. While each transmitting device has a low battery monitor which identifies when the batteries need to be replaced, this monitor may fail to operate as expected. Regular testing and maintenance will keep the system in good operating condition.

■ Compromise of Radio Frequency (Wireless) Devices

Signals may not reach the receiver under all circumstances which could include metal objects placed on or near the radio path or deliberate jamming or other inadvertent radio signal interference.

■ System Users

A user may not be able to operate a panic or emergency switch possibly due to permanent or temporary physical disability, inability to reach the device in time, or unfamiliarity with the correct operation. It is important that all system users be trained in the correct operation of the alarm system and that they know how to respond when the system indicates an alarm.

■ Smoke Detectors

Smoke detectors that are a part of this system may not properly alert occupants of a fire for a number of reasons, some of which follow. The smoke detectors may have been improperly installed or positioned. Smoke may not be able to reach the smoke detectors, such as when the fire is in a chimney, walls or roofs, or on the other side of closed doors. Smoke detectors may not detect smoke from fires on another level of the residence or building. Every fire is different in the amount of smoke produced and the rate of burning. Smoke detectors cannot sense all types of fires equally well. Smoke detectors may not provide timely warning of fires caused by carelessness or safety hazards such as smoking in bed, violent explosions, escaping gas, improper storage of flammable materials, overloaded electrical circuits, children playing with matches or arson.

Even if the smoke detector operates as intended, there may be circumstances when there is insufficient warning to allow all occupants to escape in time to avoid injury or death.

■ Motion Detectors

Motion detectors can only detect motion within the designated areas as shown in their respective installation instructions. They cannot discriminate between intruders and intended occupants. Motion detectors do not provide volumetric area protection. They have multiple beams of detection and motion can only be detected in unobstructed areas covered by these beams. They cannot detect motion which occurs behind walls, ceilings, floor, closed doors, glass partitions, glass doors or windows. Any type of tampering whether intentional or unintentional such as masking, painting, or spraying of any material on the lenses, mirrors, windows or any other part of the detection system will impair its proper operation.

Passive infrared motion detectors operate by sensing changes in temperature. However their effectiveness can be reduced when the ambient temperature rises near or above body temperature or if there are intentional or unintentional sources of heat in or near the detection area. Some of these heat sources could be heaters, radiators, stoves, barbecues, fireplaces, sunlight, steam vents, lighting and so on.

■ Warning Devices

Warning devices such as sirens, bells, horns, or strobes may not warn people or waken someone sleeping if there is an intervening wall or door. If warning devices are located on a different level of the residence or premise, then it is less likely that the occupants will be alerted or awakened. Audible warning devices may be interfered with by other noise sources such as stereos, radios, televisions, air conditioners or other appliances, or passing traffic. Audible warning devices, however loud, may not be heard by a hearing-impaired person.

■ Telephone Lines

If telephone lines are used to transmit alarms, they may be out of service or busy for certain periods of time. Also an intruder may cut the telephone line or defeat its operation by more sophisticated means which may be difficult to detect.

■ Insufficient Time

There may be circumstances when the system will operate as intended, yet the occupants will not be protected from the emergency due to their inability to respond to the warnings in a timely manner. If the system is monitored, the response may not occur in time to protect the occupants or their belongings.

■ Component Failure

Although every effort has been made to make this system as reliable as possible, the system may fail to function as intended due to the failure of a component.

■ Inadequate Testing

Most problems that would prevent an alarm system from operating as intended can be found by regular testing and maintenance. The complete system should be tested weekly and immediately after a break-in, an attempted break-in, a fire, a storm, an earthquake, an accident, or any kind of construction activity inside or outside the premises. The testing should include all sensing devices, keypads, consoles, alarm indicating devices and any other operational devices that are part of the system.

■ Security and Insurance

Regardless of its capabilities, an alarm system is not a substitute for property or life insurance. An alarm system also is not a substitute for property owners, renters, or other occupants to act prudently to prevent or minimize the harmful effects of an emergency situation.

FCC COMPLIANCE STATEMENT

CAUTION: Changes or modifications not expressly approved by Digital Security Controls could void your authority to use this equipment.

This equipment has been tested and found to comply with the limits for a Class B digital device, pursuant to Part 15 of the FCC Rules. These limits are designed to provide reasonable protection against harmful interference in a residential installation. This equipment generates, uses and can radiate radio frequency energy and, if not installed and used in accordance with the instructions, may cause harmful interference to radio communications. However, there is no guarantee that interference will not occur in a particular installation. If this equipment does cause harmful interference to radio or television reception, which can be determined by turning the equipment off and on, the user is encouraged to try to correct the interference by one or more of the following measures:

- Re-orient the receiving antenna.
- Increase the separation between the equipment and receiver.
- Connect the equipment into an outlet on a circuit different from that to which the receiver is connected.
- Consult the dealer or an experienced radio/television technician for help.

The user may find the following booklet prepared by the FCC useful: "How to Identify and Resolve Radio/Television Interference Problems". This booklet is available from the U.S. Government Printing Office, Washington D.C. 20402, Stock # 004-000-00345-4.

IMPORTANT INFORMATION

This equipment complies with Part 68 of the FCC Rules. On the side of this equipment is a label that contains, among other information, the FCC registration number and ringer equivalence number (REN) for this equipment. If requested, this number must be provided to the Telephone Company.

PC1864 Product Identifier	US: F53AL01BPC1864
PC1832 Product Identifier	US: F53AL01BPC1832
PC1616 Product Identifier	US: F53AL01BPC1614
REN:	0.1B
USOC Jack:	RJ-31X

Telephone Connection Requirements

A plug and jack used to connect this equipment to the premises wiring and telephone network must comply with the applicable FCC Part 68 rules and requirements adopted by the ACTA. A compliant telephone cord and modular plug is provided with this product. It is designed to be connected to a compatible modular jack that is also compliant. See installation instructions for details.

Ringer Equivalence Number (REN)

The REN is used to determine the number of devices that may be connected to a telephone line. Excessive RENs on a telephone line may result in the devices not ringing in response to an incoming call.

In most but not all areas, the sum of RENs should not exceed five (5.0). To be certain of the number of devices that may be connected to a line, as determined by the total RENs, contact the local Telephone Company. For products approved after July 23, 2001, the REN for this product is part of the product identifier that has the format.

US: AAAEQ##TXXXX. The digits represented by ## are the REN without a decimal point (e.g., 03 is a REN of 0.3). For earlier products, the REN is separately shown on the label.

Incidence of Harm

If this equipment PC1864/PC1832/PC1616 causes harm to the telephone network, the telephone company will notify you in advance that temporary discontinuance of service may be required. But if advance notice is not practical, the Telephone Company will notify the customer as soon as possible. Also, you will be advised of your right to file a complaint with the FCC if you believe it is necessary.

Changes in Telephone Company Equipment or Facilities

The Telephone Company may make changes in its facilities, equipment, operations or procedures that could affect the operation of the equipment. If this happens the Telephone Company will provide advance notice in order for you to make necessary modifications to maintain uninterrupted service.

Equipment Maintenance Facility

If trouble is experienced with this equipment PC1616, PC1832, PC1864 for repair or warranty information, please contact the facility indicated below. If the equipment is causing harm to the telephone network, the Telephone Company may request that you disconnect the equipment until the problem is solved. This equipment is of a type that is not intended to be repaired by the end user.

DSC c/o APL Logistics, 757 Douglas Hill Rd., Lithia Springs, GA 30122

Additional Information

Connection to party line service is subject to state tariffs. Contact the state public utility commission, public service commission or corporation commission for information.

Alarm dialling equipment must be able to seize the telephone line and place a call in an emergency situation. It must be able to do this even if other equipment (telephone, answering system, computer modem, etc.) already has the telephone line in use. To do so, alarm dialling equipment must be connected to a properly installed RJ-31X jack that is electrically in series with and ahead of all other equipment attached to the same telephone line. Proper installation is depicted in the figure below. If you have any questions concerning these instructions, you should consult your telephone company or a qualified installer about installing the RJ-31X jack and alarm dialling equipment for you.

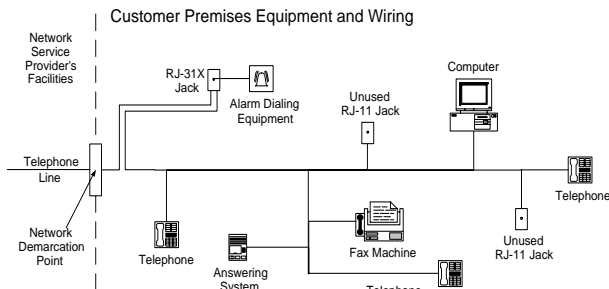

INDUSTRY CANADA STATEMENT

NOTICE: This Equipment meets the applicable Industry Canada Terminal Equipment Technical Specifications. This is confirmed by the registration number. The abbreviation, IC, before the registration number signifies that registration was performed based on a Declaration of Conformity indicating that Industry Canada technical specifications were met. It does not imply that that Industry Canada approved the equipment

NOTICE: The Ringer Equivalence Number (REN) for this terminal equipment is 0.1. The REN assigned to each terminal equipment provides an indication of the maximum number of terminals allowed to be connected to a telephone interface. The termination on an interface may consist of any combination of devices subject only to the requirement that the sum of the Ringer Equivalence Numbers of all devices does not exceed five.

PC1864 Registration numberIC: **160A-PC1864**
PC1832 Registration numberIC: **160A-PC1832**
PC1616 Registration numberIC: **160A-PC1614**

DSC erklærer herved at denne komponent overholder alle viktige krav samt andre bestemmelser gitt i direktiv 1999/5/EC.

Por este meio, a DSC, declara que este equipamento está em conformidade com os requisitos essenciais e outras determinações relevantes da Directiva 1999/5/EC.

"DSC bekräftar härmed att denna apparat uppfyller de väsentliga kraven och andra relevanta bestämmelser i Direktivet 1999/5/EC".

Con la presente la Digital Security Controls dichiara che questo prodotto è conforme ai requisiti essenziali ed altre disposizioni rilevanti relative alla Direttiva 1999/05/CE.

Por la presente, DSC declara que este equipo está en conformidad con los requisitos esenciales y otros requisitos relevantes de la Directiva 1999/5/EC.

Hierdurch erklärt DSC, daß dieses Gerät den erforderlichen Bedingungen und Voraussetzungen der Richtlinie 1999/5/EC entspricht.

'Δία του παρόντος, η DSC, δηλώνει ότι αυτή η συσκευή είναι σύμφωνη με τις ουσιώδεις απαιτήσεις και με όλες τις άλλες σχετικές αναφορές της Οδηγίας 1999/5/EC".

Hierbij verklaart DSC dat dit toestel in overeenstemming is met de eisen en bepalingen van richtlijn 1999/5/EC.

Par la présente, DSC déclare que cet article est conforme aux exigences essentielles et autres pertinentes stipulations de la directive 1999/5/EC.

DSC vakuuttaa laitteen täyttävän direktiivin 1999/5/EC olennaiset vaatimukset.

Hereby, DSC, declares that this device is in compliance with the essential requirements and other relevant provisions of Directive 1999/5/EC.

The complete R & TTE Declaration of Conformity can be found at www.dsc.com/intl/rttedirect.htm.

DSC®

©2006 Digital Security Controls

Toronto, Canada • www.dsc.com

Tech. Support: 1-800-387-3630 (Canada & U.S.), 905-760-3036



29007160R001