

Service Manual

635 / 680 / 790 / 900 Active Smart® Refrigerator/Freezer R134a & R600a Systems



care

The specifications and servicing procedures outlined in this manual are subject to change without notice. The latest version is indicated by the reprint date and replaces any earlier editions.

Fisher & Paykel Appliances Ltd
78 Springs Road,
East Tamaki
Auckland 2013
PO Box 58-732, Botany,
Auckland 2163,
New Zealand
Telephone: 09 273 0600
Facsimile: 09 273 0656

Fisher & Paykel Australia Pty Ltd
A.C.N. 003 335 171
19 Enterprise Street
P O Box 798
Cleveland, Queensland 4163
Telephone: 07 3826 9100
Facsimile: 07 3826 9164

Fisher & Paykel Singapore Pte Ltd
150 Ubi Avenue 4
Sunlight Building #02-00
Singapore 408825
Telephone: 65 65470100
Facsimile: 65 65470123

Fisher & Paykel Appliances
5800 Skylab Road
Huntington Beach
CA 92647
Telephone: 888 936 7872

Fisher & Paykel Appliances Ltd U.K
Maidstone Road,
Kingston, Milton Keynes
Buckinghamshire, MK10 0BD
England
Telephone: 0845 066 2200
Facsimile: 0845 331 2360

CONTENTS

1	SPECIFICATIONS	8
1.1	Cabinet Specifications – 230 - 240 Volt.....	8
1.2	Cabinet Specifications – 110 - 115 Volt.....	10
1.3	Compressor Specifications – R134a – 220 - 240 Volt.....	11
1.4	Compressor Specifications – R600a – 220 - 240 Volt.....	12
1.5	Compressor Specifications – R134a – 110 - 115 Volt.....	13
1.6	Model Number Identification – 635 / 680 / 790	14
1.7	Model Number Identification – 900	15
2	SERVICING REQUIREMENTS.....	16
2.1	Specialised Service Tools.....	16
2.1.1	Static Strap.....	16
2.1.2	Interface Light Pen Mk 2	16
2.2	Health & Safety	16
2.2.1	Good Work Practices	16
2.2.2	Environmental Health And Safety	16
2.2.3	Good Practice And Safety	16
3	INSTALLATION INSTRUCTIONS	17
3.1	Levelling	17
3.2	Door Hinging (Tasman Models Only)	18
3.3	Air Space Requirements	18
3.4	Temperature Adjustment	18
4	THEORY OF OPERATION	19
4.1	Terms	19
4.2	Internal Air Flow	20
4.2.1	Ice & Water Models	20
4.2.2	Non Ice & Water Models	21
4.3	Defrost Cycle.....	22
4.3.1	R134a System.....	22
4.3.2	R600a System.....	23
4.4	The Refrigeration Circuit.....	24
4.5	Evaporator.....	24
4.6	Condensate Disposal.....	25
4.7	Filter Drier	25
4.8	Internal Condenser	26
4.8.1	Condenser Lay Out 635 / 680 / 790 "T" Models	27
4.8.2	Condenser Lay Out 635 / 680 / 790 / 900 "B" Models	28
4.9	Compressor Compartment Layout.....	29
4.10	Cross Rail.....	29
4.11	Door and Door Hinge	29
4.12	Compressor.....	29
4.13	Thermal Fuse	29
4.14	Drain Heater Wire	29
4.15	Divider Partition.....	30
4.16	LCD Display Panel.....	31
4.17	Door Switches	31
4.18	Defrost Heater.....	31
4.19	Low Ambient Heater.....	32
4.20	PC / FC Fans	32
4.20.1	“B” Model Fan.....	32
4.20.2	“T” Model PC Fan.....	33
4.21	Interior Light	34
4.22	Thermistor Temperature Sensors.....	35
4.23	Basic Operation.....	36
4.23.1	Temperature Adjustment – Ice & Water Models	36
4.23.2	Temperature Adjustment – Non-Ice & Water Models	36
5	ELECTRONICS SECTION.....	37
5.1	Diagrammatic Overview Function Description.....	37
5.2	Control and Peripheral Functions	38
5.3	Power/Control Module	38

5.4	Display Module	39
6	VARIABLE CAPACITY COMPRESSOR	40
6.1	Variable Capacity Compressor Control Overview	40
6.2	Built-in Electronic Protections (Within the Module/Inverter)	40
6.2.1	Compressor Start-up	40
6.2.2	Overload Detection and Protection	40
6.2.3	Power Limitation (Temperature Protection)	41
6.2.4	Short Circuit Protection	41
6.3	VCC Module/Inverter Identification	41
6.4	Fault Finding	41
6.4.1	High Voltage Power Supply Circuit	41
6.5	VCC-3 Inverter With Diagnostic Function	42
6.5.1	Diagnostic Procedures	42
6.5.2	Testing The VCC3 Inverter (With Diagnostic Function)	44
7	DISPLAY INTERFACE – ICE & WATER MODELS	48
7.1	Display Functional Schematic	48
7.2	Display Interface Features	49
7.3	Features	49
7.3.1	Icemaker On/Off	49
7.3.2	Freezer Chill Mode	49
7.3.3	Bottle Chill Mode	49
7.3.4	Water Dispensing	49
7.3.5	Sabbath Mode	50
7.3.6	Key Silent Mode	50
7.3.7	Dispenser Lock	50
7.3.8	Key Lock	50
7.3.9	Filter Replacement Alert	50
7.4	Key Presses	51
7.5	Temperature Settings	51
8	ICEMAKER	52
8.1	Ice Production	52
8.2	Information About The Icemaker	52
8.3	Ice Bin Full Sequence	52
8.4	Safety First	53
8.5	Icemaker Fill Tube Heater	53
8.6	Pressure Limiting Valve	53
8.7	Water Inlet Valves	53
8.8	Noises	54
8.9	Ice & Water Common Complaints	54
9	WATER DISPENSER	55
9.1	Installation Precautions / Warning	55
9.2	Pressure Dispensing Pad	55
9.3	Initial Use	55
9.4	Water Filter and Cartridge	55
9.5	Changing The Water Filter	56
9.6	To Reset The Filter Icon	56
9.7	To Disable The Filter Alarm	56
10	DIAGNOSTICS	57
10.1	Ice & Water Models	57
10.1.1	Fault Codes	57
10.1.2	Testing Icemaker Sensor	61
10.1.3	Testing Icemaker Motor	61
10.1.4	Testing Water Valve	62
10.1.5	Diagnostic Modes	63
10.1.6	Input / Output Status	65
10.1.7	Fault History	65
10.1.8	To Manually Force A Defrost	65
10.1.9	LCD Display	65
10.1.10	To Manually Force The Icemaker	66
10.1.11	Data Download	66
10.2	Non-Ice & Water Models	67
10.2.1	Fault Codes	67

10.2.2	Diagnostic Mode For Service	70
10.2.3	Sensor Temperature Conversion	70
10.2.4	Input / Output Status	71
10.2.5	Data Download	72
10.2.6	To Manually Force A Defrost	72
10.2.7	Show Room Mode	72
10.2.8	Special Option Mode (Israel)	73
10.3	Problem Solving Checklist	74
11	ICEMAKER & WATER DISPENSER SERVICE PROCEDURES	75
11.1	Component Replacement	75
11.1.1	Icemaker PCB Replacement	75
11.1.2	Icemaker Unit Removal	75
11.1.3	Refitting Icemaker	75
11.1.4	Icemaker Temperature Sensor Replacement	75
11.1.5	Water Valve Replacement	75
11.1.6	Display Module Replacement	76
11.1.7	Water Dispenser Pad Replacement	77
11.1.8	Removing Water Tank	77
11.1.9	Refitting Water Tank	78
11.1.10	Replacing Icemaker Fill Tube Heater	78
11.1.11	Replacing PC Door On Ice & Water Models	81
11.1.11.1	Designer Doors	81
11.1.11.2	Classic Doors	84
12	SERVICING PROCEDURES	88
12.1	Safety Considerations	88
12.2	Electrical Safety Test	88
12.3	Doors and Door Gaskets	89
12.4	Removal Of Power/Control Module	89
12.4.1	Initialisation Of The Power/Control Module After Installation – Non-Ice & Water Models	90
12.5	Freezer Bin, Runner and Air Deflector Removal - E402B and E372B Models	90
12.6	FC Bin Removal - 900 Models	90
12.7	FC Drawer Removal - 900 Models	91
12.7.1	Refitting Of The FC Drawer	91
12.8	PC Fan Motor - “T” Models	92
12.9	PC Fan Motor - “B” Models	92
12.10	Defrost Element Replacement	92
12.11	Thermal Fuse	92
12.12	Cross / Base Rail Door Switches	93
12.13	Removal Of Display Module – Non-Ice & Water Models	93
12.14	PC Sensor Replacement	93
12.15	FC Sensor Replacement- “T” and “B” Models	93
12.16	FC Sensor Replacement - 900 Models	93
12.17	Icemaker Temperature Sensor Replacement	93
12.18	Replacement Of Low Ambient Heater - “T” Model	94
12.19	Replacement Of Low Ambient Heater - “B” Models	94
12.20	Replacement Of Low Ambient Heater - “B” Model (In Return Grill)	94
12.21	Interior LED Light Replacement	94
12.22	Flapper Element Replacement	95
12.23	Block/Edge Connectors	97
12.24	Fan Cover Removal Tool (T Models Only)	99
12.25	Active Smart® PC/FC Fan Motor Tester	99
13	WORKING ON THE SEALED SYSTEM	101
13.1	Safe Work Practices	101
13.2	Leak Detection	101
13.3	R600a Operating Pressures	101
13.4	Reclaiming	101
13.5	Brazing Off The System	102
13.6	Pressure Testing Of The Refrigeration System	102
13.7	Transporting Of Refrigerators	104
13.8	Evaporator Replacement	105
13.9	Refilling A Void In Foam Insulation After System Service Or Adjustment	105
13.9.1	Polyurethane Foam	106
13.9.2	Safe Practices	106

13.10	Removing Back Panel For Access To Water Lines And Joints.....	107
13.11	Embraco Compressor Fitted With External Overload	108
13.12	Matsushita “D” Series Compressor Fitted With External Overload And Run Capacitor	109
13.13	Compressor Replacement.....	110
13.14	Compressor Fault Diagnosis	111
13.14.1	Compressor Won't Start - Dead (PTC Relay Fitted)	111
13.14.2	Compressor Won't Start - Hums.....	112
13.14.3	Compressor Starts, Runs And Then Stops	112
14	WIRING DIAGRAMS	113
14.1	Non Ice & Water Models Power Module Wiring Connections	113
14.2	Non-Ice & Water Models Wiring Diagram.....	114
14.3	Ice & Water Models Power Module Wiring Connections.....	115
14.4	Ice & Water Models Wiring Diagram	116
14.5	900 Models Power Module Wiring Connections - Reciprocating Compressor	117
14.6	900 Models Wiring Diagram - Reciprocating Compressor	118
14.7	900 Models Power Module Wiring Connections – VC Compressor.....	119
14.8	900 Models Wiring Diagram - VC Compressor	120
14.9	“B” Model Wiring Route	121
14.10	“T” Model Wiring Route.....	122
15	SERVICE REFERENCE	123
15.1	Service Reference ‘B’ Models	123
15.2	Service Reference ‘T’ Models.....	127
16	FAULT FINDING FLOW CHART - SERVICING	130
16.1	Refrigerator Not Operating	131
16.2	No Power To Power/Control Module And/Or Display Module.....	132
16.3	PC/FC Warm.....	133
16.4	FC Too Cold – PC Too Warm.....	134
16.5	PC Too Cold	135
16.6	Ice/Condensation Forming.....	136
16.7	No Light.....	137
16.8	Door Switch Not Operating.....	138
16.9	Defrost Heater Faults.....	139
16.10	Compressor Faults	140
16.11	Compressor Runs Continuously.....	140
16.12	Compressor Will Not Run And Is Hot To Touch.....	141
16.13	Compressor Electrical Tests.....	141
16.14	Refrigeration System Faults	142
16.15	Not Dispensing Water.....	143
16.16	Not Producing Ice	144

1 SPECIFICATIONS

1.1 Cabinet Specifications – 230 - 240 Volt

DIMENSIONS

	E331T	E372B	E381T	E402B	E406B	E411T	E413T	E415H	E440T
Height with Standard Door	1425 mm	1595 mm	1595 mm	1700 mm	1700 mm	1700 mm	1595 mm	1700 mm	1700 mm
Height with Designer Door	N/A	N/A	N/A	1710 mm	N/A	N/A	N/A	N/A	N/A
Depth	700 mm	700 mm	700 mm	700 mm	700 mm	700 mm	700 mm	700 mm	700 mm
Width	635 mm	635 mm	635 mm	635 mm	680 mm	635 mm	680 mm	635 mm	680 mm

CAPACITY GROSS VOLUME IN LITRES (AS 1430)

Refrigerator PC	232 litres	250 litres	283 litres	280 litres	271 litres	314 litres	314 litres	229 litres	342 litres
Freezer FC	97 litres	123 litres	97 litres	123 litres	133 litres	97 litres	97 litres	97 litres	99 litres
Humidity Dr	N/A	N/A	N/A	N/A	N/A	N/A	N/A	85 litres	N/A
TOTAL	329 litres	373 litres	380 litres	403 litres	404 litres	411 litres	411 litres	411 litres	441 litres

ELECTRONICS – 230 – 240V (FOR SPARE PARTS)

Display Module	P/No. 881218P	P/No. 881218P	P/No. 881218P	P/No. 881218P	P/No. 881218P	P/No. 881218P	P/No. 881218P	P/No. 881218P	P/No. 881218P
Display Module - Ice & Water	N/A	N/A	N/A	P/No. 821074P	N/A	N/A	N/A	N/A	N/A
Power/Control Module - Non RoHS (AUS/NZ/ROW)	P/No. 820817P	P/No. 820817P	P/No. 820817P	P/No. 820817P	P/No. 820817P	P/No. 820817P	P/No. 820817P	P/No. 820817P	P/No. 820817P
Power/Control Module - RoHS (UK/IRE/EU)	P/No. 820818P	P/No. 820818P	P/No. 820818P	P/No. 820818P	P/No. 820818P	P/No. 820818P	P/No. 820818P	P/No. 820818P	P/No. 820818P

SUCTION LINE ASSY (FOR SPARE PARTS)

R134a Models	P/No. 813374	P/No. 817862	P/No. 813374	P/No. 817862	P/No. 817865	P/No. 817863	P/No. 817866	P/No. 817863	P/No. 817866
R600a Models	N/A	P/No. 821189	N/A	P/No. 821149	P/No. 821149	N/A	P/No. 821151	N/A	P/No. 821150

DEFROST ELEMENT – 230 - 240V (FOR SPARE PARTS)

R134a Models Wattage	P/No. 820673 295W	P/No. 820673 295W	P/No. 820673 295W	P/No. 820673 295W	P/No. 820675 322W	P/No. 820673 295W	P/No. 820675 322W	P/No. 820673 295W	P/No. 820675 322W
R600a Models Wattage	N/A	P/No. 821875 178W	N/A	P/No. 821875 178W	P/No. 821876 196W	N/A	P/No. 821876 196W	N/A	P/No. 821876 196W

DIMENSIONS

	E442B	E521T	E522B	RF540A/RF610A
Height with Standard Door	1700 mm	1700 mm	1700 mm (67")	1780 mm (70.1")
Height with Designer Door	1710 mm	N/A	1710 mm (67.3")	1790 mm (70.5")
Depth	700 mm	700 mm	700 mm (27.6")	730 mm (28.7")
Width	680 mm	790 mm	790 mm (31.1")	900 mm (35.4")

CAPACITY GROSS VOLUME IN LITRES (AS 1430)

Refrigerator PC	307 litres	400 litres	360 litres (12.7 c/ft)	433 litres (15.3 c/ft)
Freezer FC	135 litres	117 litres	159 litres (5.6 c/ft)	181 litres (6.4 c/ft)
Humidity Dr	N/A	N/A	N/A	N/A
TOTAL	442 litres	517 litres	519 litres (18.3 c/ft)	614 litres (21.7 c/ft)

ELECTRONICS – 230 - 240V (FOR SPARE PARTS)

Display Module	P/No. 814321P	P/No. 814321P	P/No. 814321P	N/A
Display Module - Ice & Water	P/No. 821074P	N/A	P/No. 821074P	P/No. 821074P
Power/Control Module - Non RoHS (AUS/NZ/ROW)	P/No. 820817P	P/No. 820817P	P/No. 820817P	(RF610A) P/No. 821024P
Power/Control Module –RoHS (UK/IRE/EU)	P/No. 820818P	P/No. 820818P	P/No. 820818P	(RF540A) P/No. 821025P

SUCTION LINE ASSY (FOR SPARE PARTS)

R134a Models	P/No. 817865	P/No. 817866	P/No. 817864	P/No. 817864
R600a Models	P/No. 821149	P/No. 821150	P/No. 821148	P/No. 821148

DEFROST ELEMENT – 230 - 240V (FOR SPARE PARTS)

R134a Models Wattage	P/No. 820675 322W	P/No. 860686 355W	P/No. 860686 355W	P/No. 860686 355W
R600a Models Wattage	P/No. 821876 196W	P/No. 821877 240W	P/No. 821877 240W	P/No. 821877 240W

1.2 Cabinet Specifications – 110 - 115 Volt

DIMENSIONS

	E402B	E415H
Height with Standard Door	1700 mm	1700 mm
Height with Designer Door	1710 mm	N/A
Depth	694 mm	694 mm
Width	635 mm	635 mm

CAPACITY GROSS VOLUME IN LITRES (AS 1430)

Refrigerator PC	280 litres	226 litres
Freezer FC	123 litres	97 litres
Humidity Dr	N/A	88 litres
TOTAL	403 litres	411 litres

ELECTRONICS – 100 - 110V (FOR SPARE PARTS)

Display Module	P/No. 881218P	P/No. 881218P
Display Module - Ice & Water	P/No. 820174P	N/A
Power/Control Module	P/No. 820819P	P/No. 820819P

SUCTION LINE ASSY (FOR SPARE PARTS)

R134a Models	P/No. 817862	P/No. 817863
--------------	--------------	--------------

DEFROST ELEMENT –100 - 110V 321W (FOR SPARE PARTS)

R134a Models		
100V	P/No. 820821P	P/No. 820821P
110V	P/No. 820699P	P/No. 820699P

1.3 Compressor Specifications – R134a – 220 - 240 Volt

	E331T	E372B	E381T	E402B	E406B		E411T	E413T	E415H
Make	Matsushita	Matsushita	Matsushita	Matsushita	Embraco	Matsushita	Matsushita	Matsushita	Matsushita
Model	DHS73C10RAW	DHS73C10RAW	DHS66C88RAW	DHS73C10RAW	EGZS90HLC	DB77C14RAY	DB77C14RAY	DHS73C10RAW	DHS66C88RAW
Part number	207216P	207216P	207215P	207216P	207188P	209492P	209492P	207216P	207215P
Volts	220 - 240	220 - 240	220 - 240	220 - 240	230	230 - 240	230 - 240	220 - 240	220 - 240
Hertz	50	50	50	50	50 - 60	50	50	50	50
Input Watts	123	123	113	123	129 / 153	147	147	123	113
Output Watts	210	210	190	210	226 / 278	213	213	210	190
Nominal BTU	717	717	649	717	770 / 950	742	742	717	649
Run current	0.57 amps	0.57 amps	0.53 amps	0.57 amps	0.71 amps	1.2 amps	1.2 amps	0.57 amps	0.53 amps
Refrigerant type	R134a	R134a	R134a	R134a	R134a	R134a	R134a	R134a	R134a
Start Resistance	18.5 ohms	18.5 ohms	23.3 ohms	18.5 ohms	21.7 ohms	16.43 ohms	16.43 ohms	18.5 ohms	23.3 ohms
Run Resistance	18.4 ohms	18.4 ohms	19.7 ohms	18.4 ohms	10.4 ohms	11.62 ohms	11.62 ohms	18.4 ohms	19.7 ohms
Oil charge (cm ³)	280 (Ester)	280 (Ester)	280 (Ester)	280 (Ester)	280 (Ester)	310 (Ester)	310 (Ester)	280 (Ester)	280 (Ester)
Relay PTC	PTHTM330MD3 207276	PTHTM330MD3 207276	PTHTM330MD3 207276	PTHTM330MD3 207276	PTH7M220MD3 207080	MM8-5DDT33M 209988	MM8-5DDT33M 209988	PTHTM330MD3 207276	PTHTM330MD3 207276
Overload	5TM22NFBYY 207224	5TM22NFBYY 207224	5TM205NFBYY 207222	5TM22NFBYY 207224	4TM283NFBYY-53 207289	MM3-18GCF 209083	MM3-18GCF 209083	5TM22NFBYY 207224	5TM205NFBYY 207222
Gas charge	120 Grams	130 Grams	120 Grams	140 Grams	150 Grams	150 Grams	130 Grams	140 Grams	130 Grams
Start Capacitor	N/A	N/A	N/A	N/A	N/A	N/A	N/A	N/A	N/A
Run Capacitor	4µF 814809P	4µF 814809P	4µF 814809P	4µF 814809P	4µF 814809P	4µF 814809P	4µF 814809P	4µF 814809P	4µF 814809P
Inverter	N/A	N/A	N/A	N/A	N/A	N/A	N/A	N/A	N/A

	E440T	E442B	E521T	E522B	RF540A/RF610A	RF540A/RF610A
Make	Matsushita	Matsushita	Matsushita	Matsushita	Embraco	Embraco
Model	DB77C14RAY	DB77C14RAY	DHS77C13RAW	DHS77C13RAW	EGZS100HCL	VEGY6H
Part number	209492P	209492P	207217P	207217P	207253P	819639P
Volts	230 - 240	230 - 240	220 - 240	220 - 240	220 - 240	220 - 240
Hertz	50	50	50	50	50 / 60	53 - 150
Input Watts	147	147	133	133	143 / 171	55.7 - 177
Output Watts	213	213	222	222	251 / 308	97 - 283
Nominal BTU	742	742	758	758	855 / 1050	330 - 965
Run current	1.2 amps	1.2 amps	0.64 amps	0.64 amps	0.8 amps	0.8 - 2.23 amps
Refrigerant type	R134a	R134a	R134a	R134a	R134a	R134a
Start Resistance	16.43 ohms	16.43 ohms	18.2 ohms	18.2 ohms	25.8 ohms	6.4 ohms
Run Resistance	11.62 ohms	11.62 ohms	15.2 ohms	15.2 ohms	9.84 ohms	6.4 ohms
Oil charge (cm ³)	310 (Ester)	310 (Ester)	280 (Ester)	280 (Ester)	280 (Ester)	430 (Ester)
Relay PTC	MM8-5DDT33M 209988	MM8-5DDT33M 209988	PTHTM330MP3 207276	PTHTM330MP3 207276	207080 7M220MD3	N/A
Overload	MM3-18GCF 209083	MM3-18GCF 209083	5TM232NFBYY 207226	5TM232NFBYY 207226	4TM302KFBYY 207259	N/A
Gas charge	140 Grams	150 Grams	155 Grams	150 Grams (5.3 oz)	180 Grams	180 Grams
Start Capacitor	N/A	N/A	N/A	N/A	N/A	N/A
Run Capacitor	4µF 814809P	4µF 814809P	4µF 814809P	4µF 814809P	4µF 814809P	N/A
Inverter	N/A	N/A	N/A	N/A	N/A	207213

1.4 Compressor Specifications – R600a – 220 - 240 Volt

	E372B	E402B		E406B	E413T	E440T
Make	Embraco	Embraco	Embraco	Embraco	Embraco	Embraco
Model	EMB55CLC	EMB66CLC	VEMC9C	EMB66CLC	EMB66CLC	EMB66CLC
Part number	207314P	207278P	207308P	207278P	207278P	207278P
Volts	220 - 240	220 - 240	220 - 240	220 - 240	220 - 240	220 - 240
Hertz	50	50	53 - 150	50	50	50
Input Watts	86	102	33 - 117	102	102	102
Output Watts	162	190	62 - 210	190	190	190
Nominal BTU	553	648	213 - 715	648	648	648
Run current	0.4 amps	0.5 amps	0.28 - 0.86 amps	0.5 amps	0.5 amps	0.5 amps
Refrigerant type	R600a	R600a	R600a	R600a	R600a	R600a
Start Resistance	11.6 ohms	12.7 ohms	8.1 ohms	12.7 ohms	12.7 ohms	12.7 ohms
Run Resistance	21 ohms	15.9 ohms	8.1 ohms	15.9 ohms	15.9 ohms	15.9 ohms
Oil charge (cm ³)	150 (Alquib/ISO5)	150 (Alquib/ISO5)	210 (Alquib/ISO5)	150 (Alquib/ISO5)	150 (Alquib/ISO5)	150 (Alquib/ISO5)
Relay PTC	EMB66QP2 20A 207292	EMB66QP2 20A 207292	N/A	EMB66QP2 20A 207292	EMB66QP2 20A 207292	EMB66QP2 20A 207292
Overload	4TM232KFBYY-53 207243	4TM232KFBYY-53 207243	N/A	4TM232KFBYY-53 207243	4TM232KFBYY-53 207243	4TM232KFBYY-53 207243
Gas charge	50 Grams	50 Grams	50 Grams	55 Grams	52 Grams	52 Grams
Start Capacitor	N/A	N/A	N/A	N/A	N/A	N/A
Run Capacitor	4µF 814809P	4µF 814809P	N/A	4µF 814809P	4µF 814809P	4µF 814809P
Inverter	N/A	N/A	207309	N/A	N/A	N/A

	E442B		E521T	E522B		RF540A	RF610A
Make	Embraco	Embraco	Embraco	Embraco	Embraco	Embraco	Embraco
Model	EGX80CLC	VEMC9C	EGX80CLC	EGX90CLC	VEMB11C	VEMB11C	EGX100CLC
Part number	207279P	207308P	207279P	207280P	207306P	207306P	207281P
Volts	220 - 240	220 - 240	220 - 240	220 - 240	220 - 240	220 - 240	220 - 240
Hertz	50	53 - 150	50	50	53.3 - 143.3	53.3 - 143.3	50
Input Watts	107	33 - 177	107	117	58 - 161	58 - 161	133
Output Watts	199	62 - 210	199	216	108 - 283	108 - 283	248
Nominal BTU	679	213 - 715	679	737	510 - 965	510 - 965	846
Run current	0.49 amps	0.28 - 0.86 amps	0.49 amps	0.85 amps	0.43 - 1.16 amps	0.43 - 1.16 amps	0.61 amps
Refrigerant type	R600a	R600a	R600a	R600a	R600a	R600a	R600a
Start Resistance	22.45 ohms	8.1 ohms	22.45 ohms	22.45 ohms	8.1 ohms	8.1 ohms	17.6 ohms
Run Resistance	18.35 ohms	8.1 ohms	18.35 ohms	18.35 ohms	8.1 ohms	8.1 ohms	17.3 ohms
Oil charge (cm ³)	280 (Alquib/ISO5)	210 (Alquib/ISO5)	280 (Alquib/ISO5)	280 (Alquib/ISO5)	210 (Alquib/ISO5)	210 (Alquib/ISO5)	280 (Alquib/ISO5)
Relay PTC	PTH7M220MD3 207080	N/A	PTH7M220MD3 207080	PTH7M220MD3 207080	N/A	N/A	PTH7M220MD3 207080
Overload	4TM189NFBYY-53 209890	N/A	4TM189NFBYY-53 209890	4TM189NFBYY-53 209890	N/A	N/A	4TM283KFBYY-53 207154
Gas charge	55 Grams	50 Grams	60 Grams	60 Grams	55 Grams	62 Grams	70 Grams
Start Capacitor	N/A	N/A	N/A	N/A	N/A	N/A	N/A
Run Capacitor	4µF 814809P	N/A	4µF 814809P	5µF 814812P	N/A	N/A	5µF 814812P
Inverter	N/A	207309	N/A	N/A	207307	207307	N/A

1.5 Compressor Specifications – R134a – 110 - 115 Volt

	E402B	E415H	RF540A/RF610A
Make	Embraco	Embraco	Embraco
Model	EGZS70HLP	EGZS70HLP	VEGY6H
Part number	207206P	207206P	819652P
Volts	115	115	115
Hertz	60	60	53.3 - 150
Input Watts	116	116	55.7 - 177
Output Watts	204	204	97 - 283
Nominal BTU	695	695	330 - 965
Run current	1.04 amps	1.04 amps	0.8 - 2.23 amps
Refrigerant type	R134a	R134a	R134a
Start Resistance	6.94 ohms	6.94 ohms	6.4 ohms
Run Resistance	4.88 ohms	4.88 ohms	6.4 ohms
Oil charge (cm ³)	280 (Ester)	280 (Ester)	430 (14.54 oz) (Ester)
Relay PTC	7M4RMD3 207068	7M4RMD3 207068	N/A
Overload	4TM319NFBYY 207205	4TM319NFBYY 207205	N/A
Gas charge	140 Grams (4.9 oz)	120 Grams (4.2 oz)	180 Grams (6.3 oz)
Start Capacitor	N/A	N/A	N/A
Run Capacitor	N/A	N/A	N/A
Inverter	N/A	N/A	207214

1.6 Model Number Identification – 635 / 680 / 790

1	2	3	4	5	6	7	8
E	402	B	R	E	C	FP	WW
Type of refrigeration system E = Electronic	Approximate capacity of cabinet in litres 402 = 402 litres	Freezer location T = Top freezer B = Bottom freezer H = Humidity drawer	Door hinging R = Right hand L = Left hand	Style D = Designer E = Elegance I = Inox M = Iridium T = Tasman	Series	Brand FP = Fisher & Paykel	Colour of the cabinet and doors WW = White cabinet / white doors SA = Sandstone cabinet / sandstone doors SM = Silver cabinet / matt stainless doors SX = Silver cabinet / brushed stainless doors

Example:

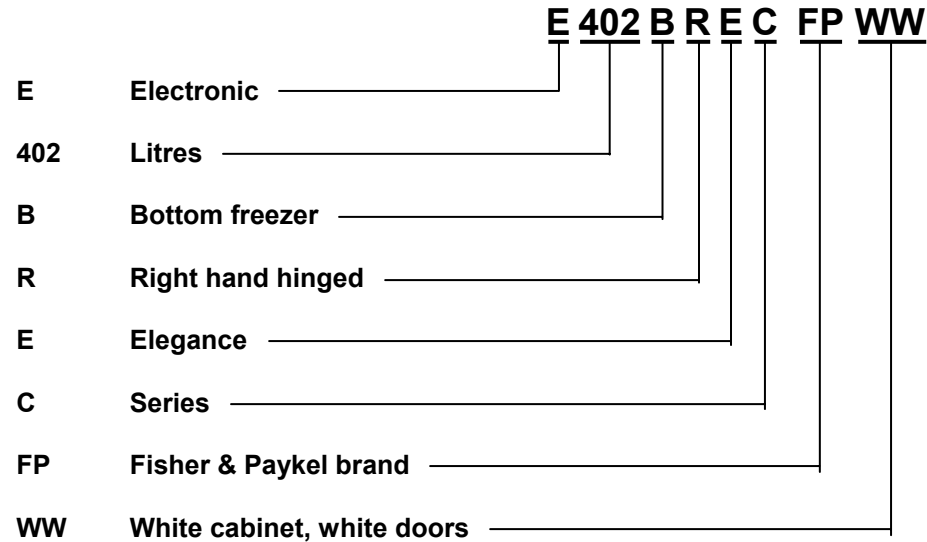

1.7 Model Number Identification – 900

1	2	3	4	5	6	7	8	9
RF	610	A	D	U	M	2	FP	SG
Product Type	Capacity of cabinet in Litres 610 = 610 litres	French Doors	Designer Handles	Ice & Water	Colour M = Iridium X = S/S Ezkleen	Iteration	Brand	Market

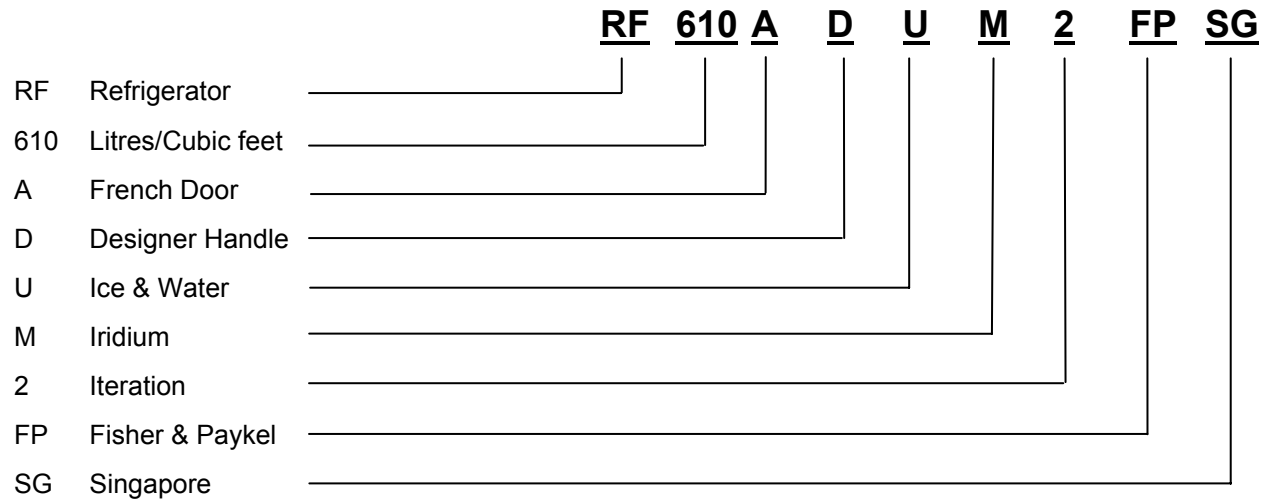

2 SERVICING REQUIREMENTS

2.1 Specialised Service Tools

For the servicing of this product, specialised tools are needed.

2.1.1 Static Strap

To be used as ESD protection when replacing any of the electronic boards.

2.1.2 Interface Light Pen Mk 2

Used in conjunction with a diagnostic programme on a laptop computer to retrieve and download data from the electronic power/control module.

2.2 Health & Safety

2.2.1 Good Work Practices

1. Take care while removing all plastic components, especially when cold.
2. Leave the product clean and tidy when service work is completed.
3. Extreme heat in cabinets will cause plastic deterioration or distortion and thermal fuses in the evaporator to go open circuit (be careful with heat guns).

2.2.2 Environmental Health And Safety

When servicing products, consider health and safety issues and requirements that must be adhered to at all times. Specific safety issues are:

1. Electrical safety.
2. Electrostatic discharge.
3. Mixing of foam insulation.
4. Vapours while brazing.
5. Reclaiming of refrigerant.

2.2.3 Good Practice And Safety

1. Take care when removing or servicing all electrical components to avoid electrical shock or short circuit conditions.
2. Take care when removing plastic components at low temperatures as breakages can occur with these components.
3. Extreme heating of plastic components can cause distortion of those parts being heated.
4. Avoid overheating temperature sensitive devices such as the element thermal fuses and cabinet sensors.
5. Avoid using solvents and citrus-based cleaners on all plastic parts. We advise only warm soapy water be used.

CAUTION – R600a REFRIGERANT (ISOBUTANE)

Some models of refrigerators contain R600a refrigerant within the sealed in system. This refrigerant is **flammable**. All care must be taken when servicing these products. Vent well before brazing. Avoid any open flames or ignition source.

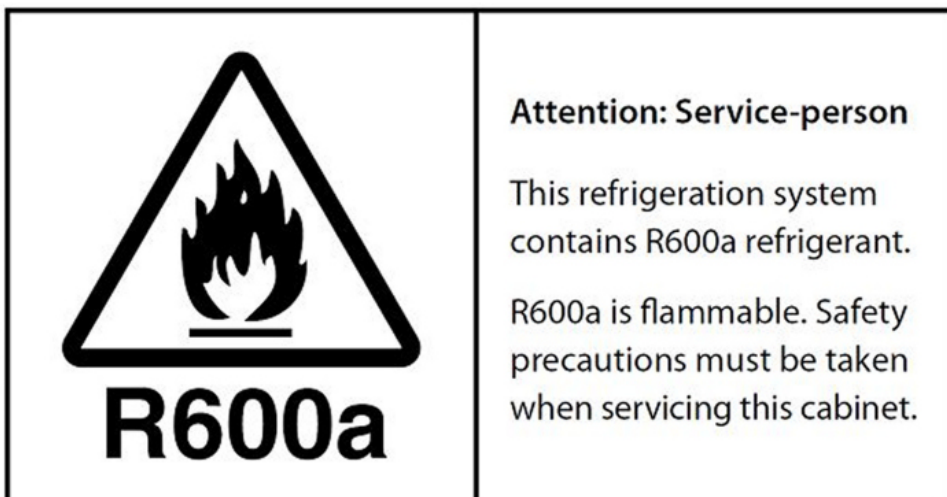

3 INSTALLATION INSTRUCTIONS

3.1 Levelling

The word 'level' is somewhat of a misnomer, as a 'spirit level' need not be used to set the appliance level. It is preferable to have the appliance level in appearance where both doors will close with the aid of the door closing cams. It is also important that the appliance sits solidly on the floor.

- Front and rear rollers are fitted ex factory. These are not adjustable.
- Cabinet levelling can be done by adjustment of the front levelling feet fitted ex factory. Refer to Diagram 3.1B).
- Weight should be lifted off cabinet for ease of adjustment.

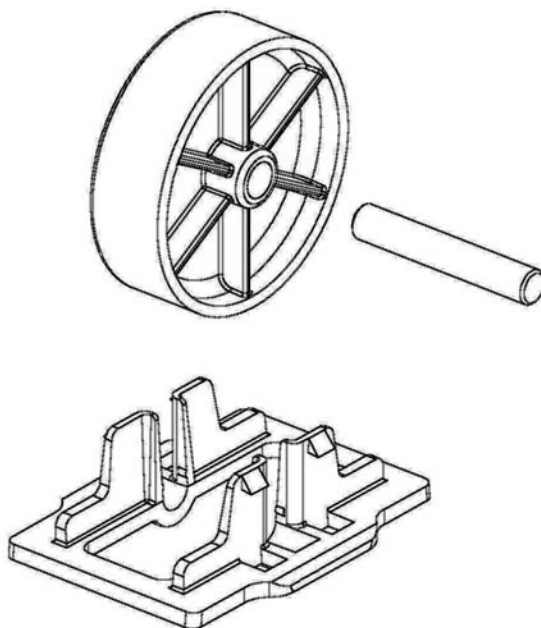

Diagram 3.1A
Rear Roller

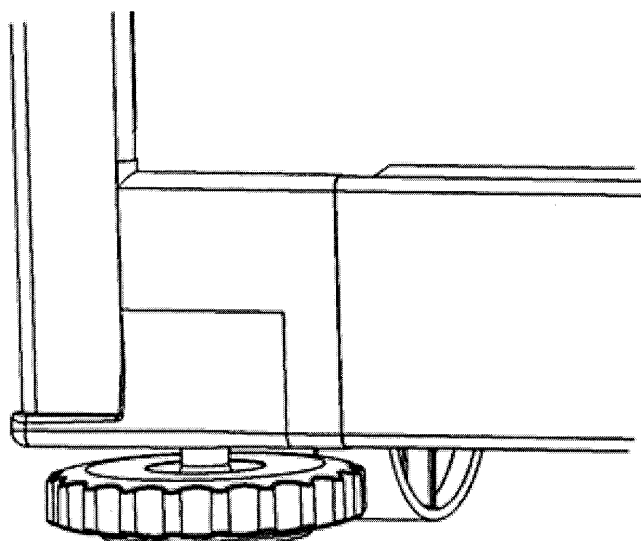

Diagram 3.1B
Front Roller and Levelling Wheel

3.2 Door Hinging (Tasman Models Only)

The product leaves the factory hinged right hand or left hand. The door hinging can be changed by obtaining a door hinge conversion kit appropriate for the cabinet being converted. There are a number of kits changing the door hinging from RH to LH or from LH to RH. They also include two door B & T models, single door models and "H" models in the 635, 680 and 790 cabinet widths, along with handle colours of white and silver. Inox and Elegance models will require a complete door change.

3.3 Air Space Requirements

On all refrigerators and freezers it is important that an air gap is left around the product:

50mm (2 inches) clearance at the top.

20mm ($\frac{3}{4}$ inch) clearance on each side.

3.4 Temperature Adjustment

Refer **BASIC OPERATIONS** in Section 4.23.

4 THEORY OF OPERATION

4.1 Terms

CABINET WRAPPER

Pre-painted steel.

LINER

A one-piece vacuum formed ABS liner with a plug-in divider

DIVIDER PARTITION

Injected moulding of HIPS, with two outer injected moulded housings, and an insulated ducted moulded polystyrene inner core.

FAN MOTORS

DC 12 volt brushless variable speed fan motors for air circulation in both the FC and PC compartments.

EVAPORATOR

Aluminium fin on tube type mounted vertically on the back wall of the FC.

SUCTION and CAPILLARY LINE

Foamed into the back of the cabinet with all joints of the evaporator having been joined by induction brazing in the FC.

POWER/CONTROL MODULE

Contains the microprocessor that controls all functions of the refrigerator and gathers data from the sensors. This module also contains support circuitry to switch the various outputs.

DISPLAY MODULE

Using signals from the power/control module, this module generates the LCD or LED display.

REED SENSORS

A reed switch encapsulated within a plastic housing, mounted on the cross and base rails behind a plastic cover. A magnet housed just under the lower end cap of each door activates this sensor when the door is closed.

TERMS

Within this manual the following terms are used:

PC = Provision compartment

FC = Freezer compartment

LOW AMBIENT HEATER

Two types are used. A PCB type used in the air duct of "T" models. A blanket wire type used in the divider of "B" models.

4.2 Internal Air Flow

4.2.1 Ice & Water Models

The freezer fan draws air through the evaporator and into a duct in the rear wall of the freezer compartment. This air exits through the fan grill at the top of the freezer compartment. The air behind the freezer coil cover is also diverted through the divider partition to another fan, which supplies the cold air into the PC compartment. The amount of air is controlled electronically by two sensors, which in turn regulate, through the power/control module, the speed of both PC and FC fans to maintain selected temperatures in each compartment.

Air from the PC returns to the FC evaporator by way of the return air duct, which is built into the divider partition. This air is drawn across the evaporator by the FC fan motor to be recirculated again throughout the PC/FC compartments.

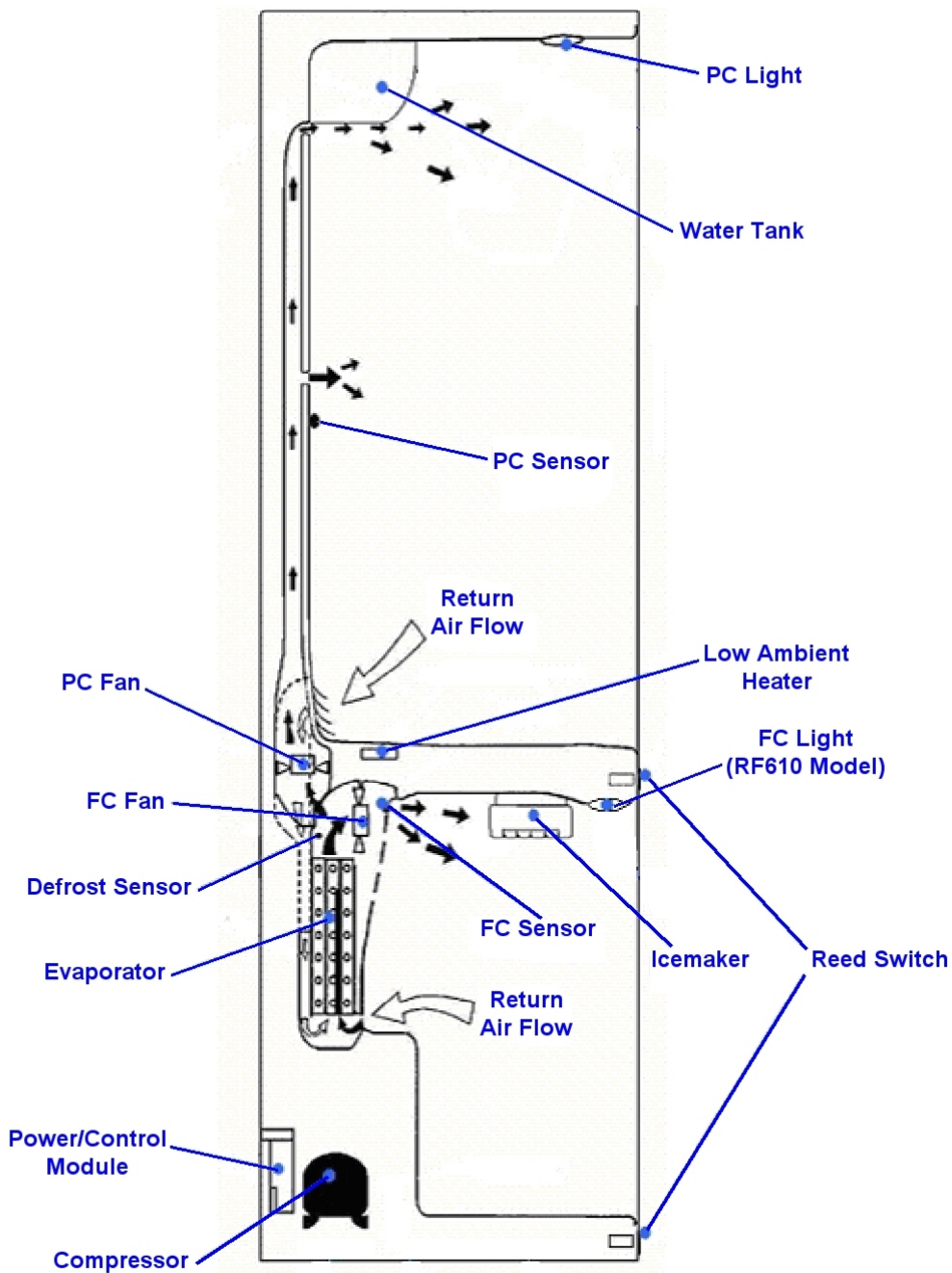

Diagram 4.2

4.2.2 Non Ice & Water Models

The freezer fan draws air through the evaporator and into a duct in the rear wall of the freezer compartment. This air exits through the fan grill at the top of the freezer compartment. The air behind the freezer coil cover is also diverted through the divider partition to another fan, which supplies the cold air into the PC compartment. The amount of air is controlled electronically by two sensors, which in turn regulate the speed of both PC and FC fans to maintain selected temperatures in each compartment.

Air from the PC returns to the FC evaporator by way of the return air duct, which is built into the divider partition. This air is drawn across the evaporator by the evaporator FC fan motor to be recirculated again throughout the PC / FC compartments.

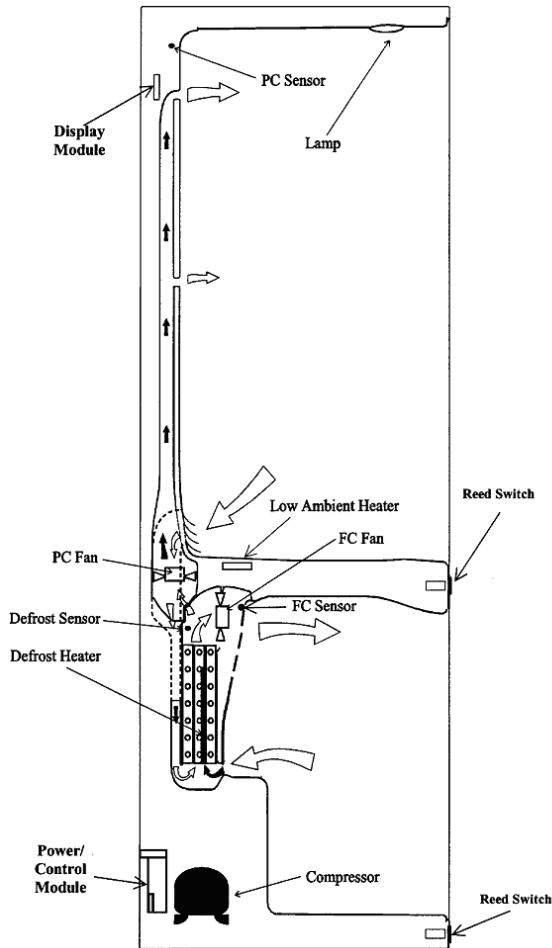

Diagram 4.2.2A
“B” Model Active Smart®

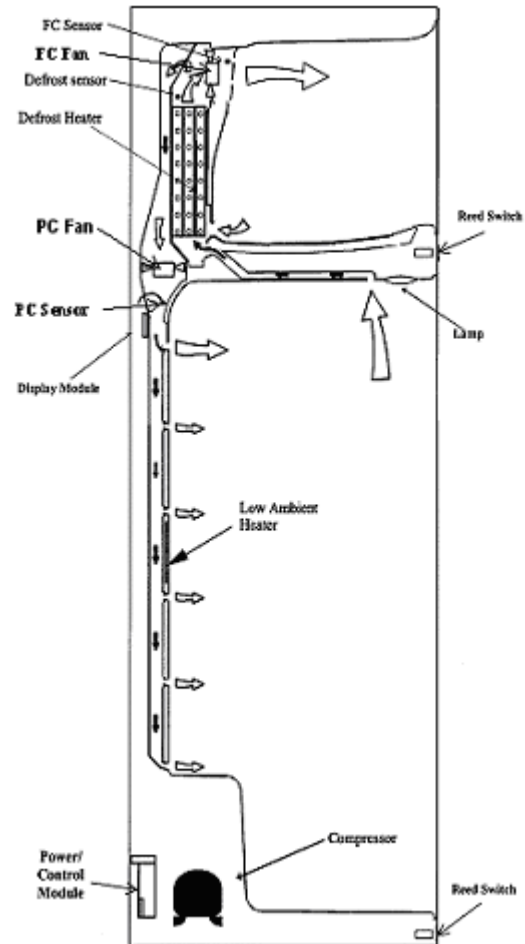
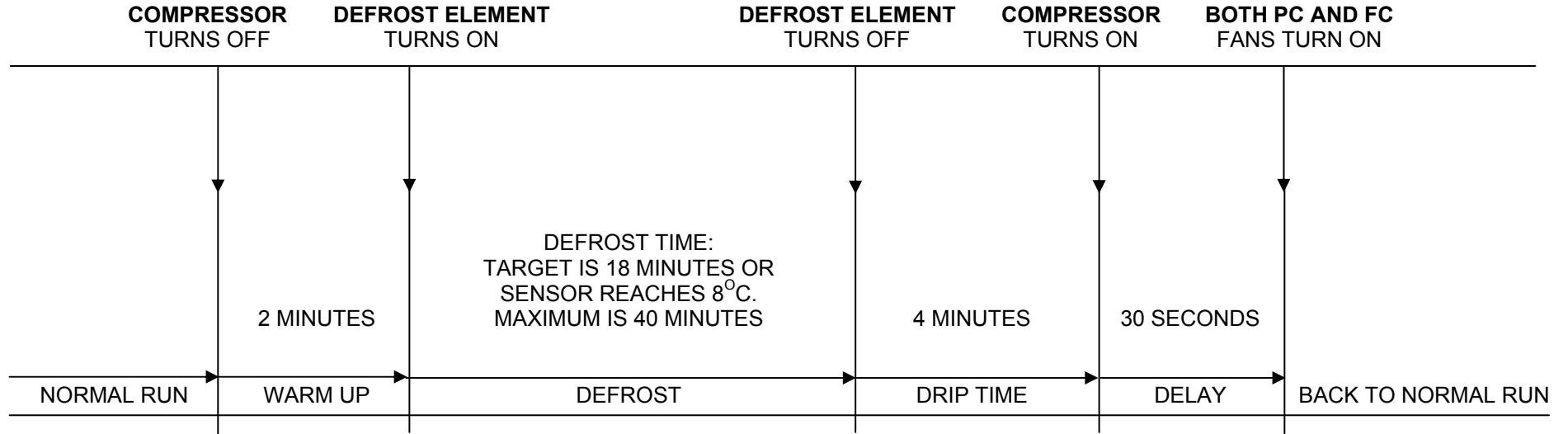

Diagram 4.2.2B
“T” Model Active Smart®

4.3 Defrost Cycle

4.3.1 R134a System

The following table outlines the defrost cycle of an R134a refrigerant system Active Smart® refrigerator.



If 40 minutes has elapsed, defrost would be aborted if defrost sensor has not reached 8°C (46°F). If 2 defrosts are aborted, Fault Code 2 is displayed.

Diagram 4.3.1

4.3.2 R600a System

The following table outlines the defrost cycle of an R600a refrigerant system Active Smart refrigerator.

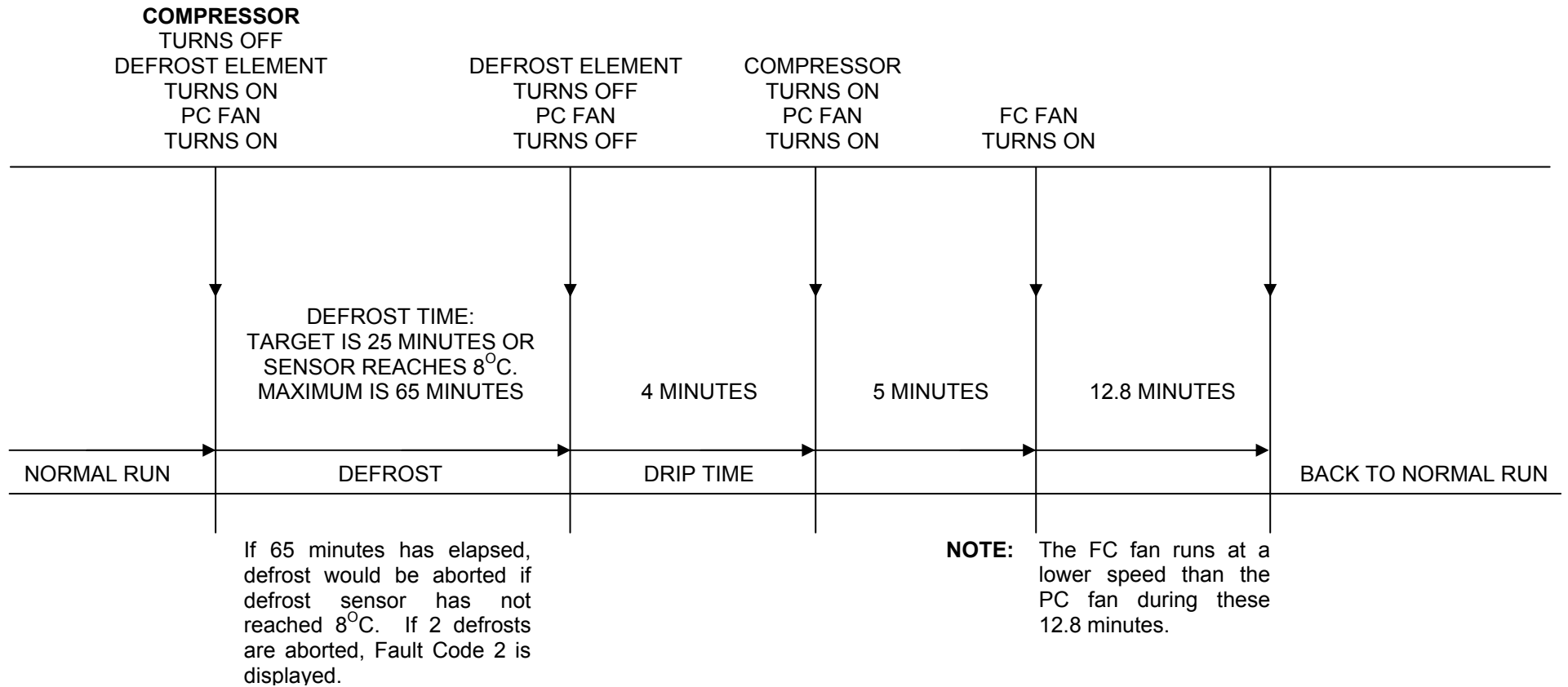

Diagram 4.3.2

4.4 The Refrigeration Circuit

The compressor discharges high pressure, high temperature gas into the back panel condenser circuit first, returning via the oil cooler in the compressor and entering the side condenser in the cabinet by way of the base tube. This tube runs from the compressor compartment forward to the front bottom edge of the cabinet, returning down the left hand side to be connected to the left hand side condenser coil.

A loop from this condenser coil forms the cross rail mullion on dual temperature cabinets. The condenser then continues across the top front edge of the cabinet to form the right hand side condenser entering the filter drier, which is mounted vertically in the unit compartment.

Now the high-pressure gas has been condensed, the liquid refrigerant flows through the capillary tube entering the evaporator mounted in the freezer compartment. The liquid refrigerant then boils off due to the low suction pressure applied to within the evaporator from the compressor. The heat-laden vapour is drawn back to the compressor by way of the suction line to start the cycle all over again.

The above information relates to the cabinet, not the drawing below.

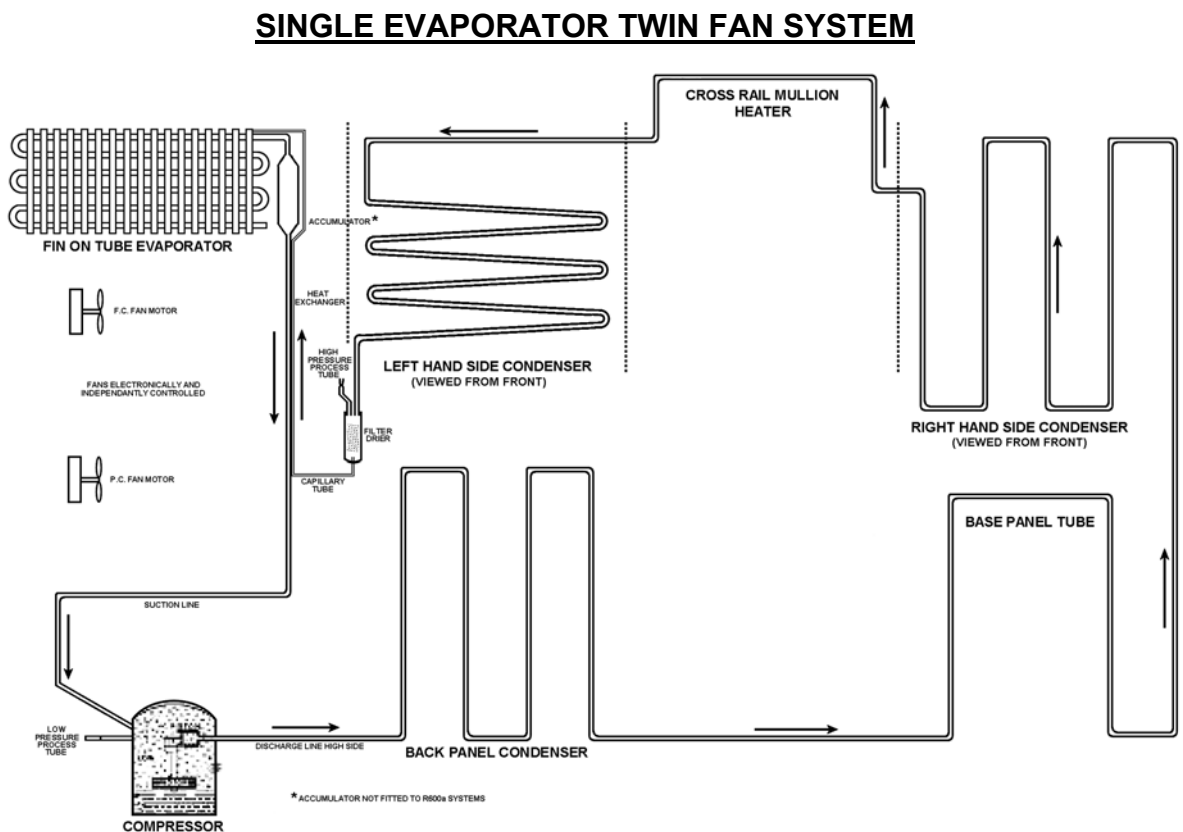

Diagram 4.4

4.5 Evaporator

The evaporator on R134a models is of the Fin and Tube type with the expansion and suction inlet/outlet on the left hand side. The defrost element is fitted to the left and right hand end plates of the evaporator and clamped into position.

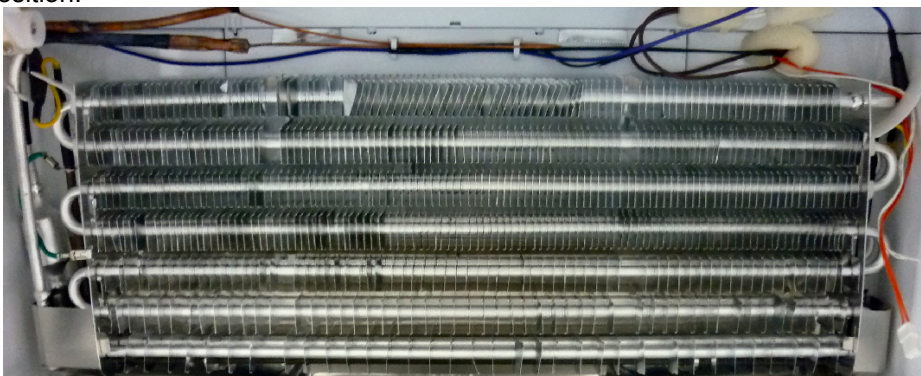

Diagram 4.5.1

The evaporator on R-600a models is of the Fin and Tube type with the expansion and suction inlet/outlet on the left hand side. The defrost element is fitted to the right hand end plate of the evaporator and clamped into position. The R-600a evaporator does not have an accumulator fitted. This is to reduce the risk of oil slugging with the type of refrigerant used.



Diagram 4.5.2

4.6 Condensate Disposal

During the defrost cycle, which is electronically timed and controlled, live frost is melted off the evaporator by means of heat from the defrost element. Condensate from the evaporator defrosting drops into a collection trough, which has an outlet hole in the centre of the liner. A tube then allows the condensate to flow into a water evaporation tray above the compressor.

4.7 Filter Drier

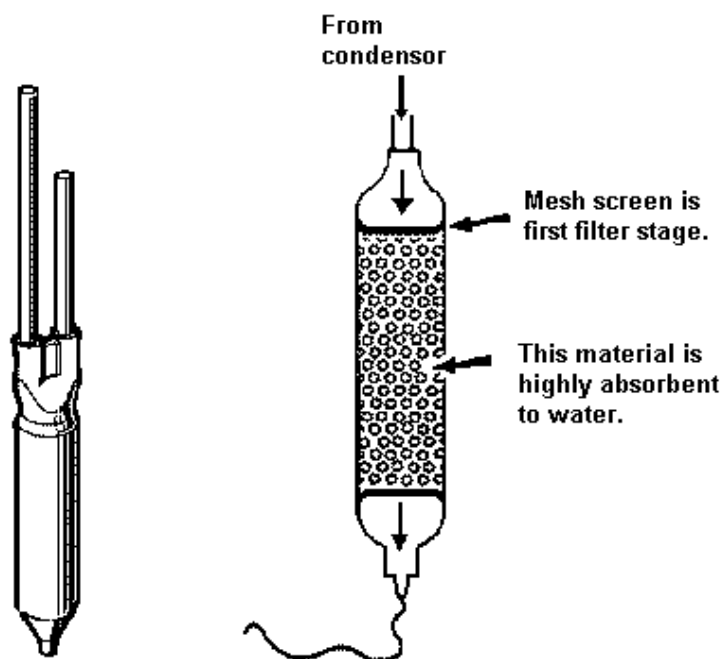

Diagram 4.7

The filter drier or molecular sieve, as the name suggests, is both a filter and a drier. Whenever a system is opened it is essential that the filter drier is replaced. ALWAYS ensure that replacement filter driers are kept well sealed and airtight prior to being fitted to a system.

NOTE: When filter driers are replaced on systems being serviced, it is important that the filter drier is either cut from the system or the desiccant is removed before heat is applied to the old filter drier. Failure to do so will drive any moisture held in the desiccant back into the system.

ALWAYS mount vertically or as near to vertical as possible and use the correct desiccant to suit the refrigerant being used.

XH7 or XH9 suits R-600a.

4.8 Internal Condenser

The internal condenser is made in three sections (refer circuit diagram below). One third of the condenser is attached to the inside of the back panel, and the other parts are attached to the inside of the right and left sides of the cabinet wrapper (as viewed from the back) all being foamed into place. It is very important, if pressure testing the high side circuit, to split the condenser into its three sections to locate which section is at fault. Always ease the back panel away from the cabinet slightly before pressure testing the internal pipe work. This will prevent a pressure build-up within the cabinet should any leak be found internally in the foam insulation. Such a leak could pressurise and damage the cabinet liner.

The back panel condenser comes as part of the back panel and should always be replaced as a complete assembly if the back panel is ever removed. On fitting a new back panel assembly always replace the mastic vapour-sealing compound before fitting the back panel into the triple fold of the cabinet.

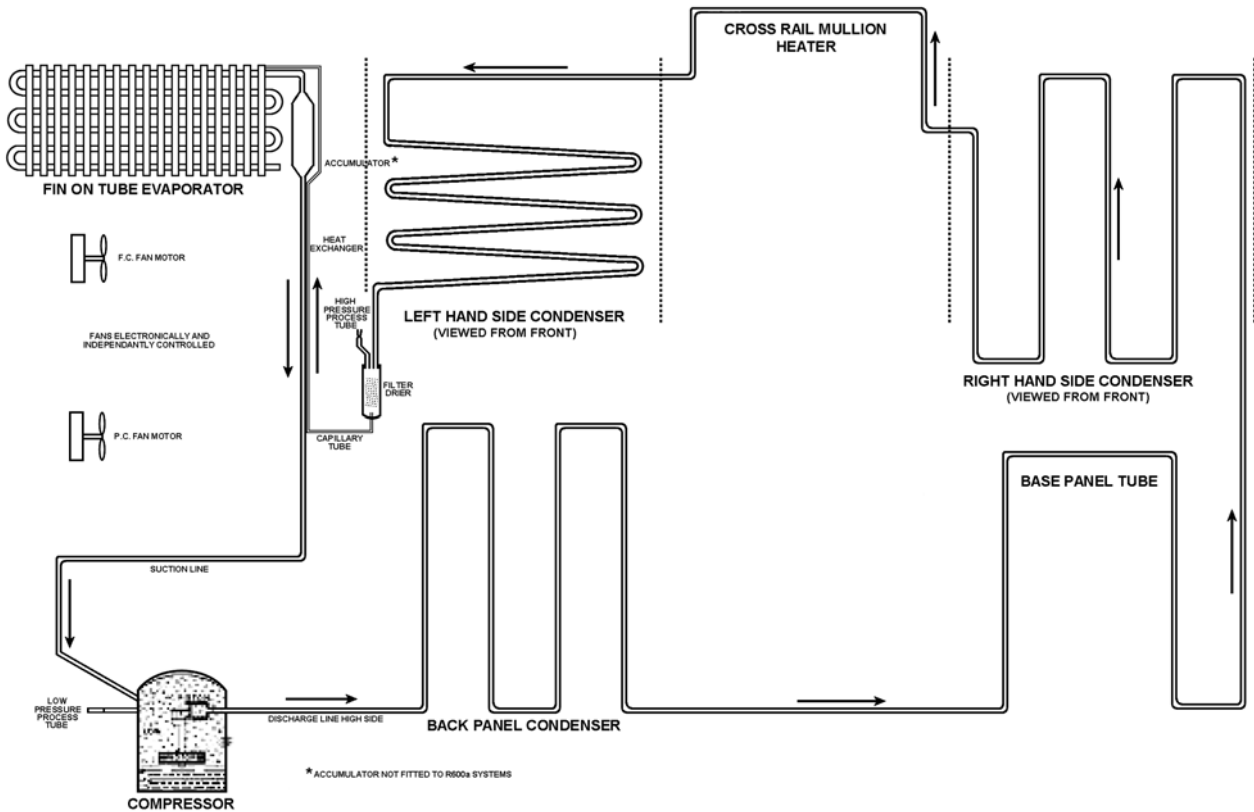
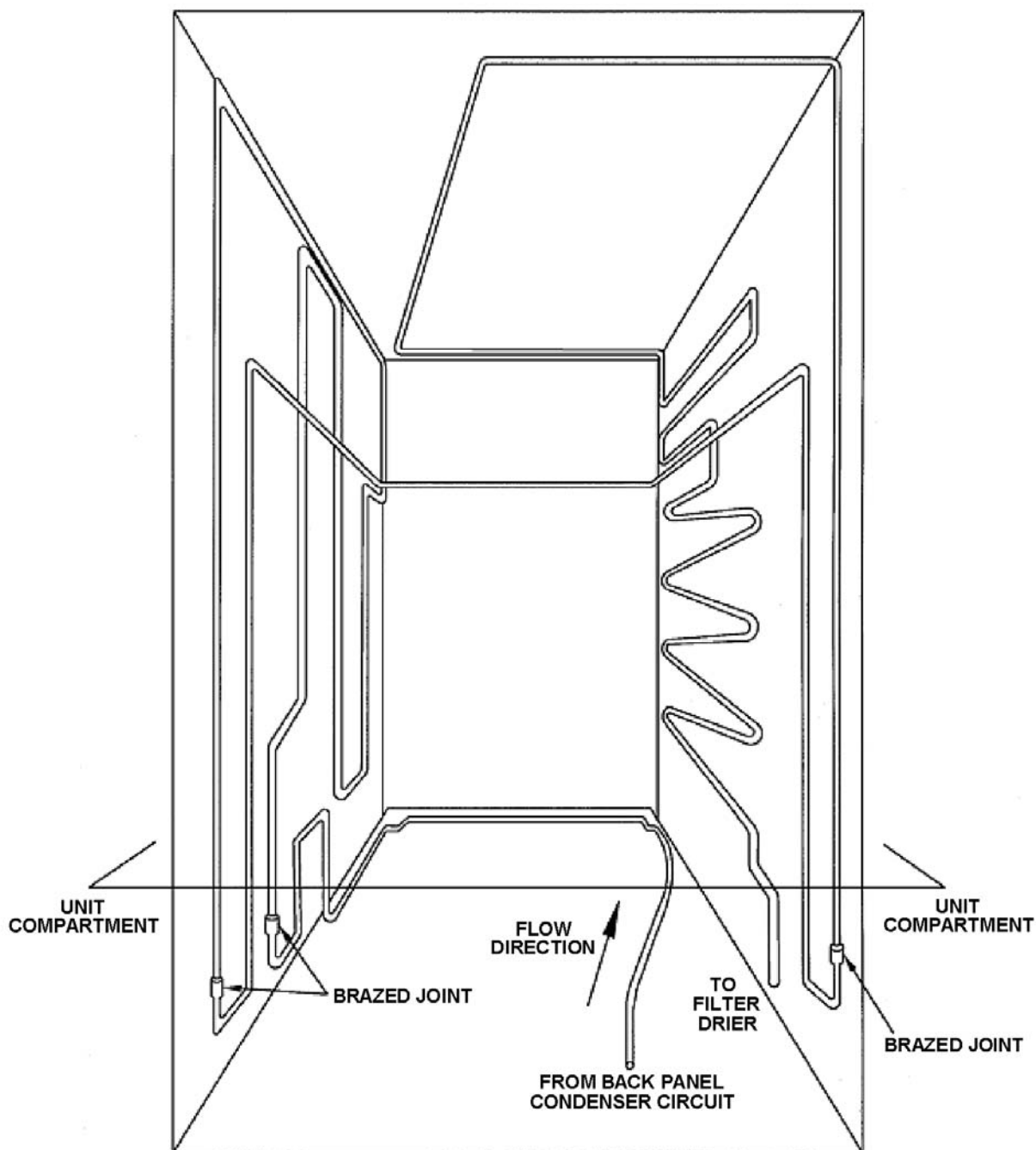

Diagram 4.8

4.8.1 Condenser Lay Out 635 / 680 / 790 "T" Models

CONDENSER WITH TUBE CROSS RAIL



BACK PANEL CIRCUIT REMOVED FOR CLARITY
ALL BRAZED CONDENSER JOINTS ARE EXTERNAL IN UNIT COMPARTMENT

Diagram 4.8.1

4.8.2 Condenser Lay Out 635 / 680 / 790 / 900 "B" Models

CONDENSER WITH TUBE CROSS RAIL

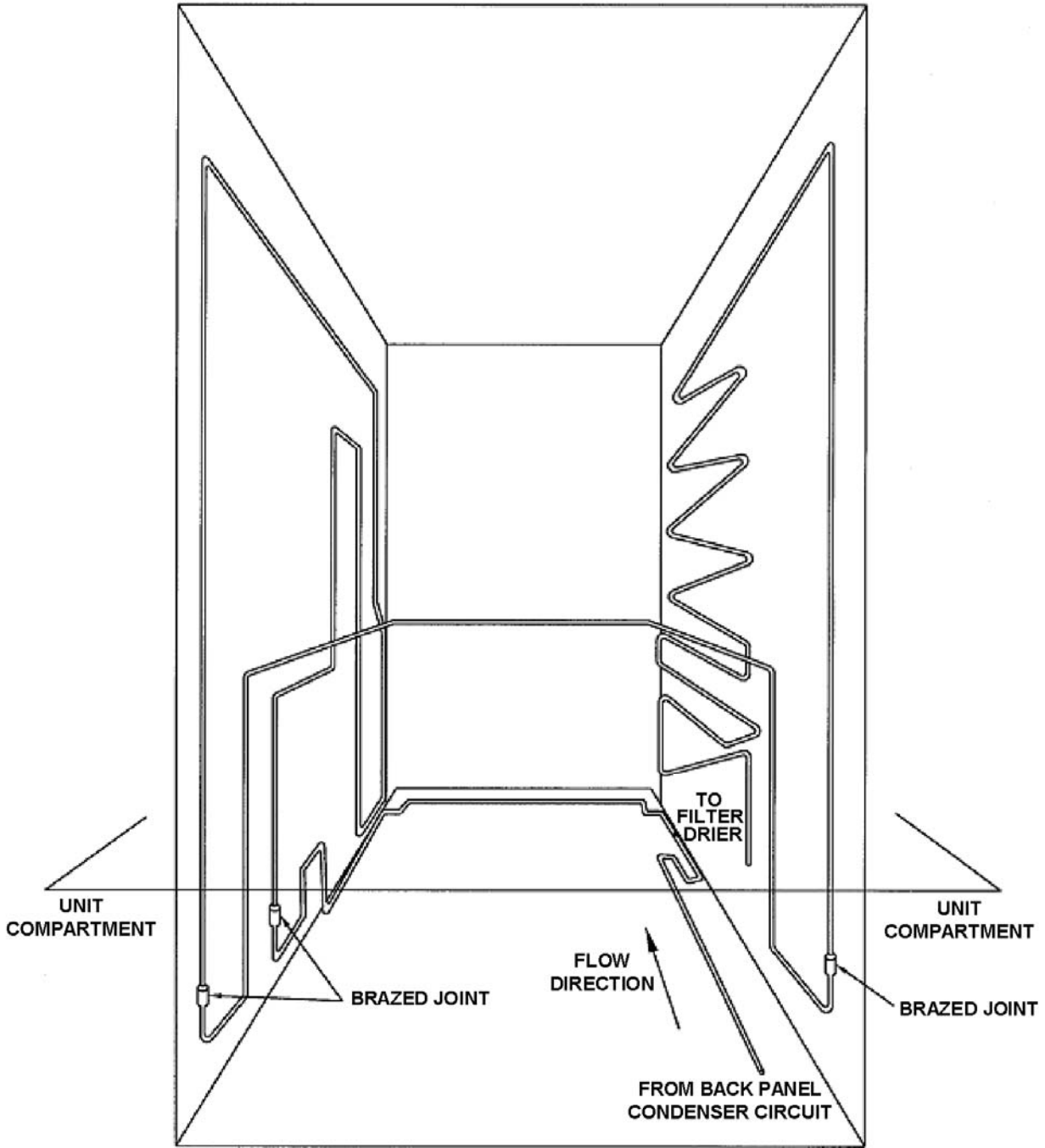

**BACK PANEL CIRCUIT REMOVED FOR CLARITY
ALL BRAZED CONDENSER JOINTS ARE EXTERNAL IN UNIT COMPARTMENT**

Diagram 4.8.2

4.9 Compressor Compartment Layout

The diagrams below will assist in identifying the various pipes within the compressor compartment. They should be read in conjunction with the full system diagram (refer to Diagram 4.4).

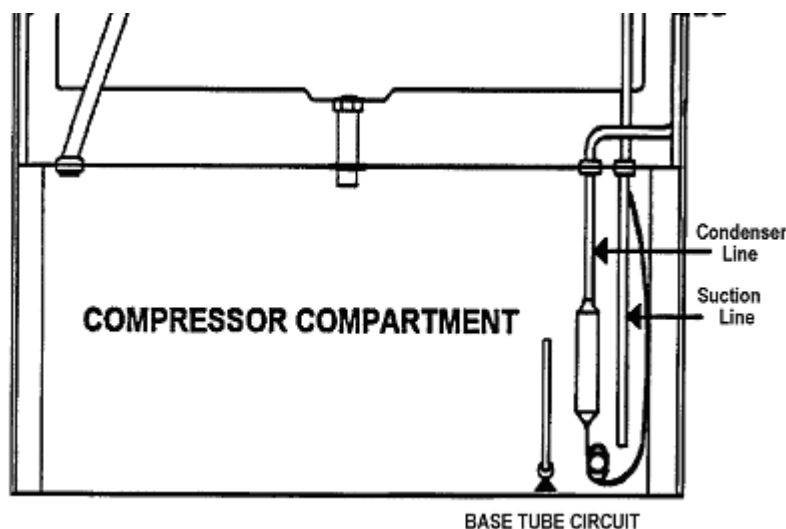

Diagram 4.9

4.10 Cross Rail

The cross rail contains part of the condenser copper tubing (mullion heater) providing heat to the gasket area between the PC and FC compartments, preventing sweating of the gasket. Also mounted on the cross rail is the Reed Sensor, under the plastic cover in the centre.

4.11 Door and Door Hinge

On the Designer models, the upper door hinge is concealed and cannot be seen with the door closed. The upper door height is extended past the top of the cabinet to cover the hinge area.

4.12 Compressor

The compressor is turned on when cooling is required. It is switched by a Triac (solid state switching device) on the power/control module.

4.13 Thermal Fuse

There are two thermal fuses mounted in the wiring harness of the defrost element, having a tripping temperature of 72°C. Once open circuit they cannot be reset. Replacement is part of the element heater assembly.

These fuses in both leads of the element protect the refrigerator from any over heating through failure of the element itself or a triac failure in the power/control module. Both sides are protected in case phase and neutral are reversed.

NOTE: Care should be taken if manually defrosting the evaporator if using heat guns, that the thermal fuses are not over heated.

4.14 Drain Heater Wire

A drain heater wire is fitted to all cabinets except R134a B models. This drain heater helps to prevent the drain tube from blocking with ice. The wire clips onto the double-pass defrost element, with the tail of the heater wire in the drain tube, thus conducting heat from the defrost element into the drain tube area during defrost.



Diagram 4.14

4.15 Divider Partition

This is moulded in two outer pieces and has an inner polystyrene moulded duct assembly that is wax coated. This provides a barrier between the FC and PC compartments, also allowing return air from the PC to move back to the FC evaporator in 'T' models. In both models it houses the PC fan motor. In 'B' models it houses also the low ambient heater. The divider is fitted into the cabinet as an assembly and cannot be replaced.

“B” DIVIDER PARTITION

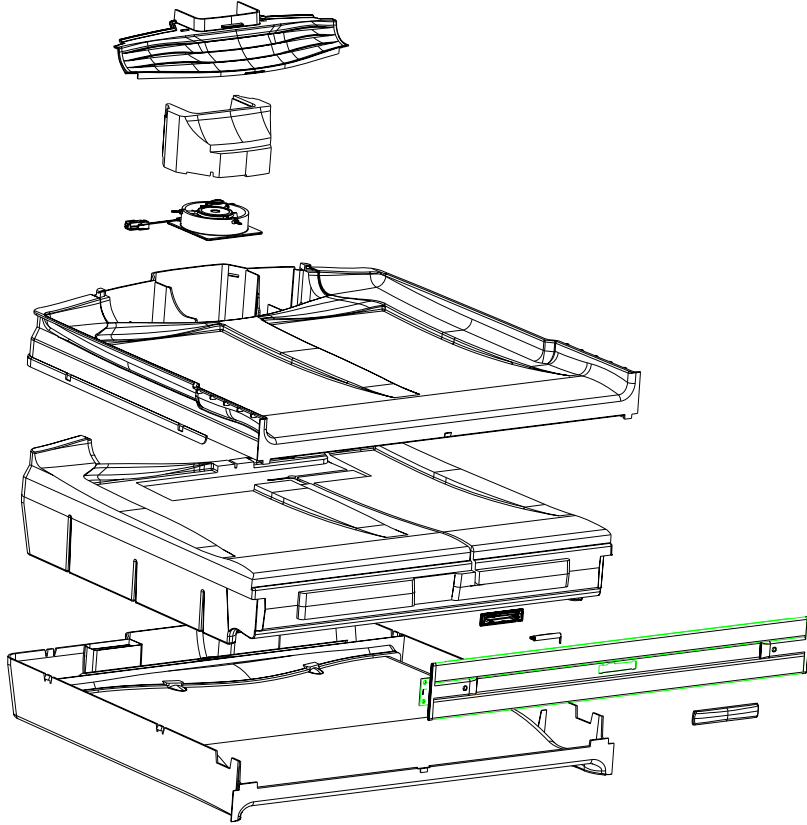

Diagram 4.15A

“T” DIVIDER PARTITION

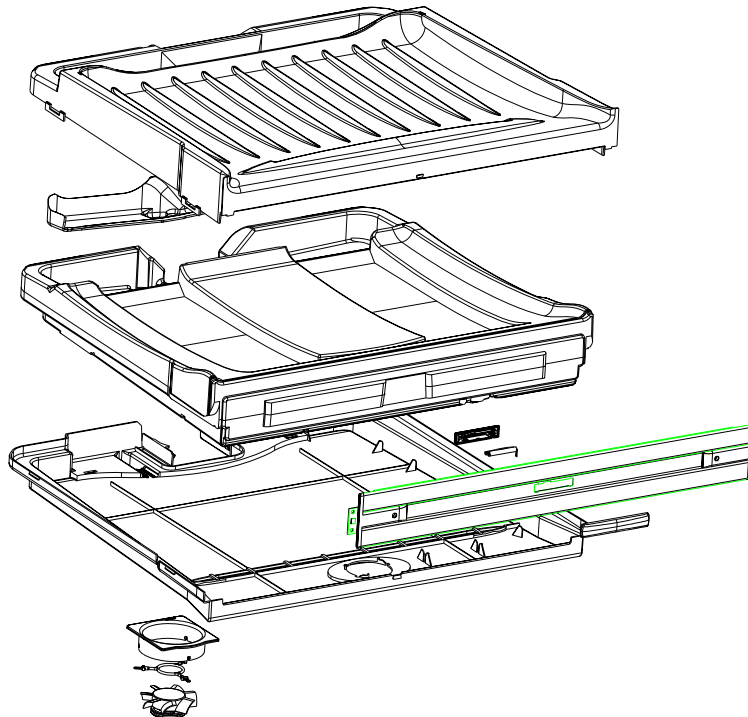

Diagram 4.15B

4.16 LCD Display Panel

The ice & water models are fitted with an LCD display on the exterior of the PC door. This is the user interface. Refer to Section 5 for further details of the display interface.

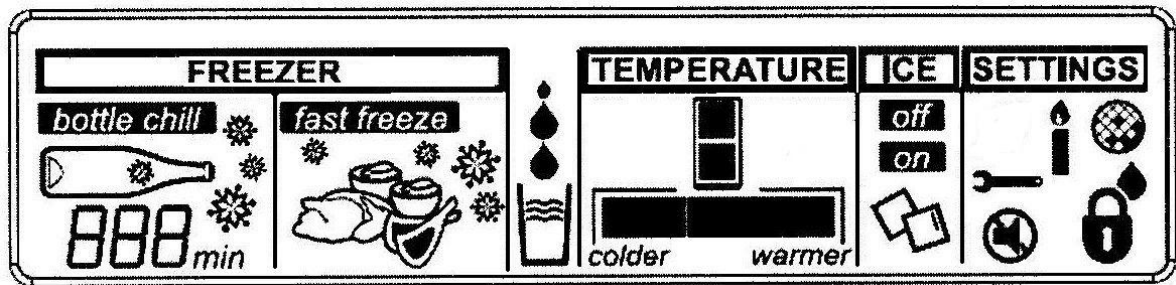

Diagram 4.16

4.17 Door Switches

“Reed” switches are used to detect the opening and closing of the doors. They are activated by two small magnets that are built into the PC and FC doors. The reed switches are encapsulated within a plastic housing, which is clipped under the plastic covers on the base and cross rails.

4.18 Defrost Heater

A heating element is used to defrost the ice accumulated on the evaporator. The defrost heating element used on the evaporator is of an inconvol folded type having both wiring terminations at one end. The defrosts are adaptive to the usage and environment and are controlled by the power/control module and sensed by the defrost sensor located on the evaporator chassis registering $+8^{\circ}\text{C}$ before terminating the defrost heater element. Previous defrost history, the number of door openings, and the compressor run time are used to determine the interval between defrosting. The typical time interval for defrosts is between 12 hours and 1 day. However it can be as short as 3 hours or as long as 70.8 hours depending on the usage and environment.

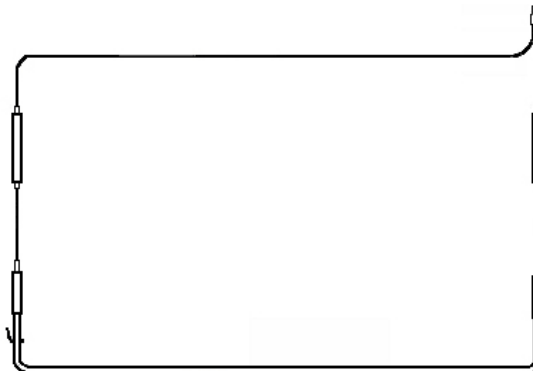

R134a Evaporator Defrost Element

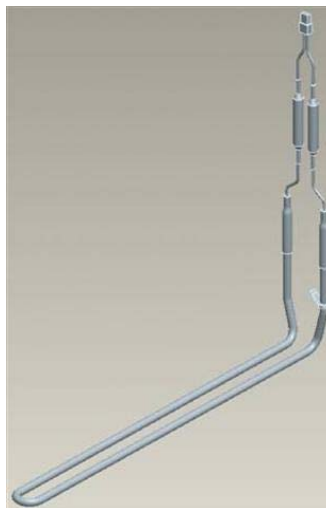

R600a Evaporator Defrost Element

Diagram 4.18

4.19 Low Ambient Heater

In low ambient temperatures, a 12 Volt, 7 Watt low power heater is used to keep the temperature in the Provision compartment above freezing. The ambient heater is controlled by the power/control module, which uses pulse width modulation (PWM) to run the heater at 58% to give 4.1 watts of heat. The ambient heater is situated in the air duct of the "T" models and in the divider partition on "B" models. The element has the purpose of warming the area if the ambient becomes too low, hence in the "B" models the element is on when the compressor cycles off as the crispers could freeze. The low ambient heater in "T" models operates when the percentage of compressor run time for the last four cycles drops below 30%. It switches off when the percentage run time increases to above 35%. The heater will always be switched off during defrosting. There may be less than 4 cycles in the calculation if a defrost has occurred or there were long cycle times.

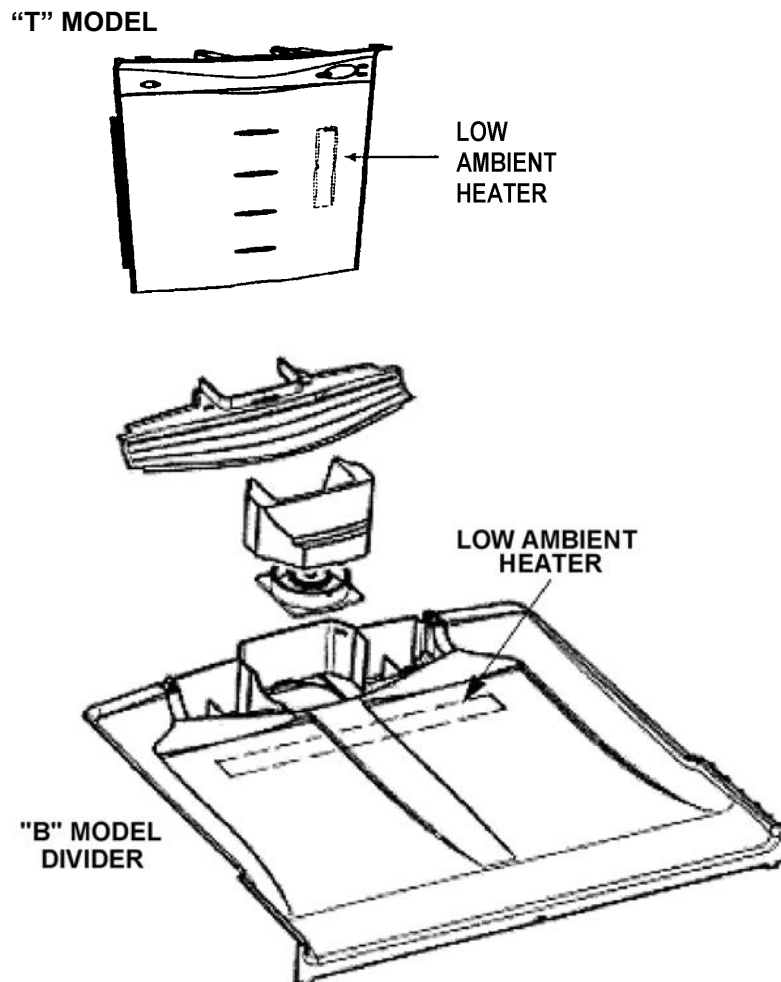

Diagram 4.19

4.20 PC / FC Fans

4.20.1 "B" Model Fan

There are two 12 Volt DC electrically commutated motors (ECMs). They provide the required cooling air flow to both compartments. The motor speeds are controlled using a pulse width modulating (PWM) technique. The power/control module controls the on/off of the compressor, and the fans. The speed of the FC fan is set, and the speed of the PC fan is regulated using pulse width modulation.

The freezer compartment fan will always be set at the maximum FC fan speed, with the PC fan being adjusted to meet the requirement of that compartment. We alter the speed of the FC fan under certain loading conditions. Therefore the PC fan speed will be set at the average speed used from the previous cycles under normal door openings and loading conditions.

When the compressor is turned on, provided the doors are closed both the fans will also be switched on except immediately following a defrost cycle, where there is a delay of 5 minutes after the compressor has started before the FC fan starts.

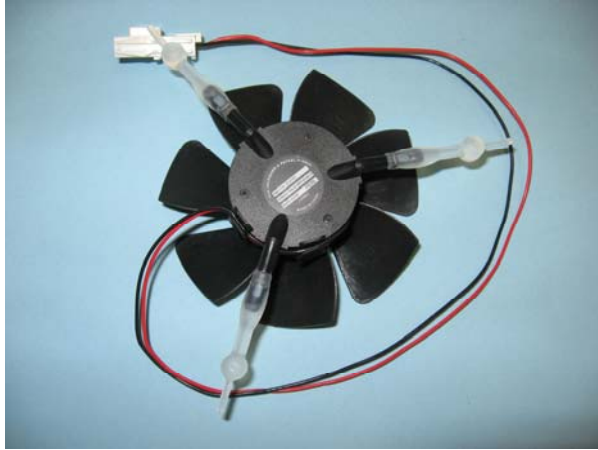

FC Fan (Viewed from front)

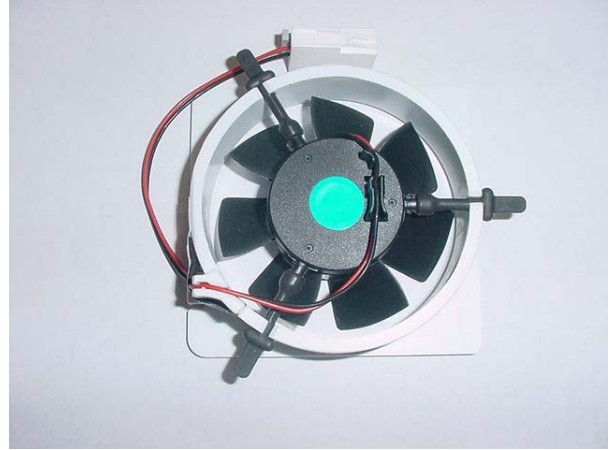

“B” Model PC Fan (Viewed from PC side)

Diagram 4.20.1

4.20.2 “T” Model PC Fan

The PC fan in the “T” model cabinets has an air shroud duct fitted to the base of the fan. This is to deflect the airflow down the duct and prevent air leaks in the area of the top of the duct.



“T” Model PC Fan



Fan in Position

Diagram 4.20.2

NOTE: The same PC fan assembly is supplied as a spare part for both “B” and “T” models. This part comes with the air shroud duct for use in “T” models. When the spare part is used in “B” models, the air shroud duct should be discarded, as it is not used in “B” models.

4.21 Interior Light

The interior light of this cabinet uses a LED mounted on a small PCB board located in the roof of the PC (and FC in some models). The light fittings can be rectangle or oval.

On opening the door, the light has a soft start feature, increasing in brightness to a preset level. To prevent overheating of the lens cover, the lamp is turned off after 5 minutes if the door is left open, and the module will beep continuously indicating that the door has been left open.

“T” models have one LED on the PC board; “B” models have either two or three LEDs on the PC board.

The power/control module controls the light.

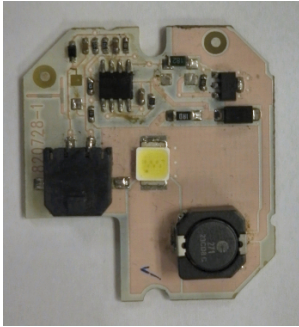

“T” Model PCB Board



Board in Housing



“B” Model Board, Housing & Cover

Diagram 0

NOTE: It is important that the polarity to the LED lamp is correct, as it will not operate if transposed.

4.22 Thermistor Temperature Sensors

These sensors are used to monitor temperatures within the refrigerator. They are:

1. A defrost sensor mounted above the evaporator used to measure the temperature when in defrost.
2. An FC sensor mounted on the evaporator coil cover used to measure the temperature in FC.
3. A PC sensor mounted in the PC on the duct cover and used to sense the PC temperature.
4. On ice & water models, an ice tray sensor mounted on the bottom of the ice cube tray used to measure the temperature of the ice tray.
5. On ice & water models, a water tank sensor mounted at the rear of the water tank used to measure the temperature of the water tank.

Thermistor sensors are used for temperature measurement. Their electrical resistance changes as the temperature changes. The table below lists some typical resistance values. The temperature can be read using Diagnostic Mode as described in the Section 10.1.5 (ice & water models) or Section 10.2.3 (non-ice & water models).

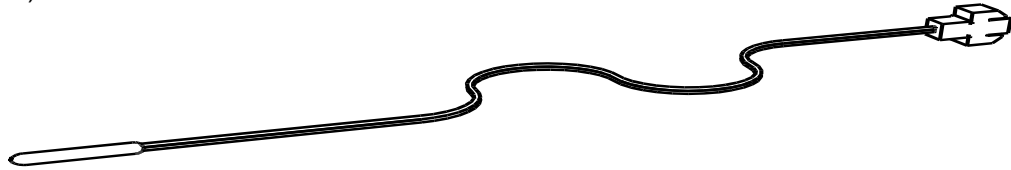

THERMISTOR SENSOR RESISTANCE TABLE

TEMPERATURE (°C)	RESISTANCE (K Ohms $\pm 5\%$)
-30.0	25.17
-25.0	19.43
-20.0	15.13
-15.0	11.88
-10.0	9.392
-5.0	7.481
0.0	6.000
5.0	4.844
10.0	3.935
15.0	3.217
20.0	2.644
25.0	2.186
30.0	1.817
35.0	1.518
40.0	1.274
45.0	1.075
50.0	0.9106

Diagram 4.22

4.23 Basic Operation

4.23.1 Temperature Adjustment – Ice & Water Models

To adjust Compartment Temperatures:

1. Use the **MENU** button to scroll to the **TEMPERATURE** screen on the LCD display.
2. Use the **MENU** button to select the compartment to change.
3. Use the **UP** or **DOWN** arrows to adjust the temperature. The temperature setting will be indicated on the icon below.

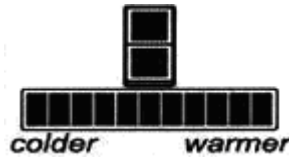

Diagram 4.23.1

4.23.2 Temperature Adjustment – Non-Ice & Water Models

To adjust Compartment Temperatures:

1. Press the **MODE** button.
The provision compartment light on the refrigerator diagram will flash on and off. The temperature indicator illustrated by a thermometer will show the temperature setting for this compartment.
2. The temperature can be altered by pressing the **TEMPERATURE UP** or **TEMPERATURE DOWN** buttons. Fewer LED lights on the thermometer means a cooler temperature.
3. To adjust the freezer temperature press the **MODE** button again. The freezer temperature light will flash on the refrigerator diagram.
4. The freezer temperature can be altered by pressing the appropriate **TEMPERATURE UP** or **TEMPERATURE DOWN** buttons.

Successively pressing the **MODE** button will automatically select between the compartments. A return to the provision compartment will be accompanied by a longer beep.

LEDs INDICATE APPROXIMATE TEMPERATURE

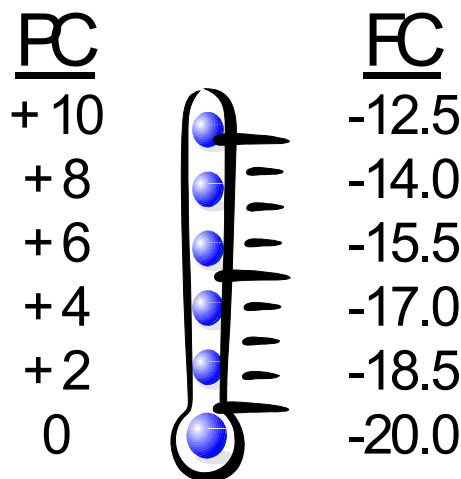

Diagram 4.23.2

Temperatures shown are average temperatures. One degree C incremental temperature adjustment is indicated by the “half” lights that illuminate as the temperature up / down button is pressed.

5 ELECTRONICS SECTION

5.1 Diagrammatic Overview Function Description

The electronic system consists of several parts:

Power/control module, display module, compressor, defrost heater, low ambient heater, door flapper heater, produce compartment fan, freezer compartment fan, light, temperature sensors, icemaker sensors, solenoids and door sensors.

The purpose of the power/control module is to turn on the compressor, which cools the evaporator, then to use the fans to efficiently cool the compartments. Both fans turn on with the compressor. The freezer compartment (FC) fan is kept at a constant speed while the produce compartment (PC) fan is regulated to provide the balanced cooling for both compartments. The function of the microprocessor in the power/control module is to provide independence of both compartments to their set temperatures, although the environment of one compartment effects the other as they are linked by the ducts as can be seen by the internal air flow of the cabinet. (Refer to diagrams 4.2, 4.2.2A and 4.2.2B).

ELECTRONIC FUNCTIONAL SCHEMATIC

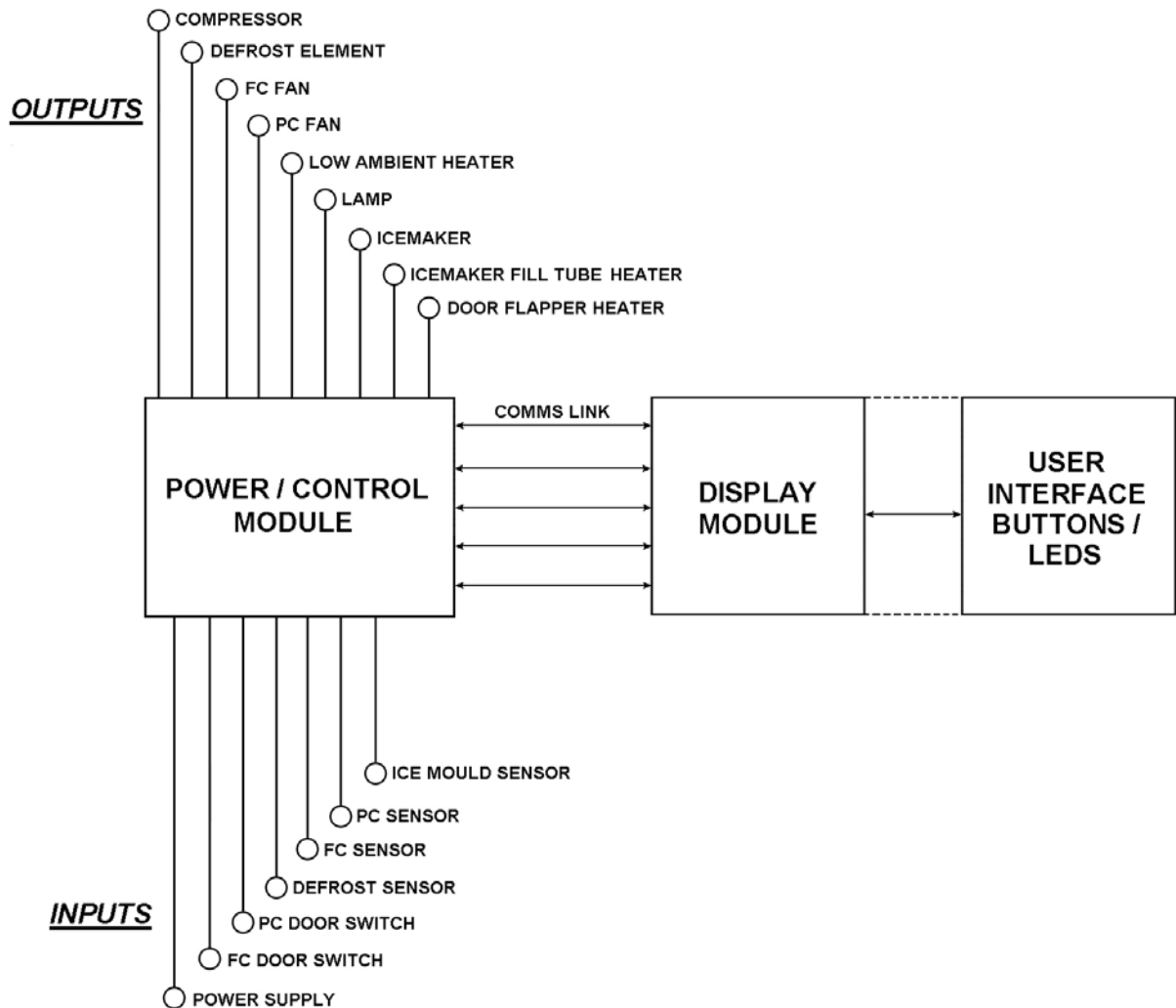

Diagram 5.1

5.2 Control and Peripheral Functions

The control system consists of the power/control module located in the unit compartment of the refrigerator, the slave display module located either in the back of the produce compartment or, in the case of ice and water models, on the outside of the door, and various sensors and actuators controlled by the power/control module. The function and brief description of each of these units is defined below (refer to Electronic Functional Schematic – Diagram 5.1).

5.3 Power/Control Module

There are two types of power/control modules used on these Active Smart® cabinets, one for the non-ice & water cabinets and the other for those cabinets having the ice & water feature.

NOTE: While the two types of modules are not interchangeable, the ice & water module can be used on a non-ice and water model.

This module is the electronic brain and control centre of the refrigerator. It contains a microprocessor, support circuitry and switching devices. The power/control module controls the Provision Compartment (PC) and Freezer Compartment (FC) temperatures by sensing the temperature and door state and operating the compressor and fans accordingly. This module also houses the alarm beeper.

The speed of the fans is controlled by pulse width modulation (PWM). The power/control module controls the motor speed by driving them with short pulses. These pulses vary in duration to change the speed of the motor. The longer the pulses, the faster the motor turns, and vice versa.

The micro controller in the power/control module uses its internal memory for control; its ROM (Read Only Memory), for program and fixed constant storage including tables, the RAM (Random Access Memory) for variable storage and access. It uses an external Electrically Erasable Programmable Read Only Memory (E 2 PROM) for storage of variables and history data which is retained even when the power is turned off.

The power/control module contains a special type of memory device call an E 2 PROM. The information on the fridge operation, faults and diagnostic information is stored in this memory. They include the temperature setting, the history of FC, PC temperatures (approx 18 hours), defrost history (the last 12 defrosts) and fault history. This will help the service person find and remedy the cause of failure. All this memory will be retained even when the fridge is disconnected from mains power supply.

Compressor Start Delay

All Active Smart® products will not start the compressor until one minute after both doors are closed, i.e. if the compressor is off and compartments warm up above their respective switch (turn on) temperatures, and the doors are open, the compressor will not switch on until one minute after the doors are closed. However, the compressor will start after 90 seconds irrespective of whether the doors are open or not. (Primarily introduced for Orthodox Jewish compliance to ensure there is no link between door opening and compressor starting.)

The piezo beeper is used to signal prolonged door opening and other fault conditions:

1. The PC door alarm sounds if the door is left open for 90 seconds and the FC door alarm sounds if door is left open after 60 seconds. Both PC and FC alarm will sound every 30 seconds until the door is closed.
2. If the doors are left open longer than 5 minutes, the alarm will sound continuously and the PC light will turn off. The alarm will stop with the closing of the door. The light is only reactivated by closing and opening the door.
3. On non-ice & water models, all electronic faults, when detected, will sound the alarm and the LED's on the display module will flash indicating the fault code. The pressing of any button will cancel the alarm but the fault code will remain until the cabinet has been serviced.
4. On ice & water models, a spanner symbol and LCD fault code will appear automatically if there is a fault in the temperature measuring system, defrost system, icemaker, fans or low ambient heater.

When the PC door is opened, an alarm will sound. The number of beeps also indicates the fault code. Pressing any of the control buttons can deactivate this alarm.

There are two types of power/control modules used on these Active Smart® cabinets, one for non-ice & water cabinets and the other for those cabinets having the ice & water feature.

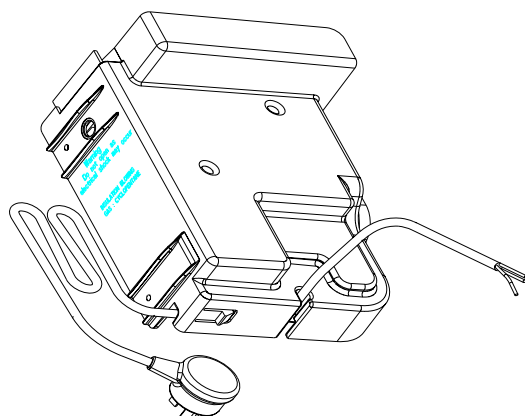

Non-Ice & Water Module



Ice & Water Module

Diagram 5.3

5.4 Display Module

On the non-ice & water models, this module contains the user interface. It is controlled via a 5-wire communications interface from the power/control module.

The user interface of push button switches and Light Emitting Diode (LED) display on the display module printed circuit board is used to input and display the required set temperatures for the refrigerator compartments.

The user interface is positioned at the right hand side of the fresh food compartment (PC). The interface automatically displays the current temperature setting for the PC compartment. This is shown as a series of LED lights on a thermometer symbol. To adjust the temperature of the PC, simply press the **TEMPERATURE UP** or **TEMPERATURE DOWN** buttons to the appropriate setting (refer to Section 4.23.2).

Press the **MODE** button on the left-hand side of the interface to select the FC compartment setting. The indicator light will flash for 8 seconds to show a new compartment has been selected. Press the up or down buttons to adjust the temperature as necessary.

Further presses of the **MODE** button will toggle between the PC and FC compartments.

Non-Ice & Water Display Module

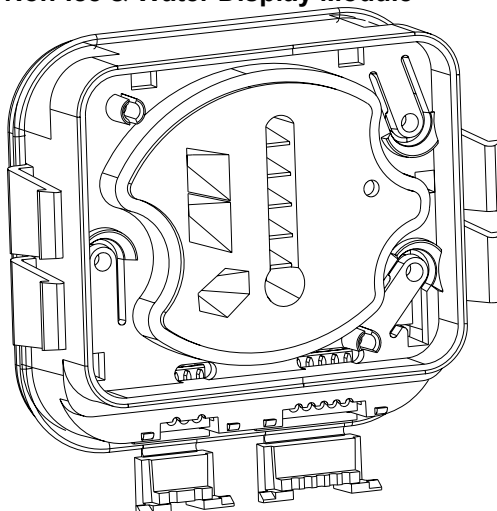

Diagram 5.4

6 VARIABLE CAPACITY COMPRESSOR

Some Active Smart® refrigerators are fitted with variable capacity compressors (VCC) depending on the model and market. The compressor is turned on when cooling is required and is switched by the power/control module sending a low voltage frequency signal to the inverter.

The VCC improves energy efficiency and maintains a more stable temperature in both the provision compartment and the freezer compartment. The compressor windings are wired in a 3 phase star formation with the resistance between any two pins being the same (6.4 ohms).

6.1 Variable Capacity Compressor Control Overview

The power/control module on VCC product is identical to that on non-VCC product. The power/control module senses if it is connected to a VCC compressor and uses the appropriate algorithm.

The compressor can operate at speeds between 1590 and 4300 rpm inclusive. On the Fisher & Paykel product we operate the compressor at a select number of different speeds between 1590 and 4300 rpm to reduce the variation in sound produced by the compressor. An electronic module/inverter connected between the power/control module and the compressor controls the speed. This it does by supplying a modulated DC 3 phase supply to the compressor. **Warning: Permanent damage will occur if the compressor is directly connected to the AC supply line.**

The power/control module monitors, amongst other things, the refrigerator compartment temperatures (via thermistors) and the defrost cycle, and from this information sends signals to the electronic module/inverter to determine compressor speeds.

Whenever the compressor starts, it is run at 2200 rpm for 2.5 seconds to establish lubrication, and is then run at 1590 rpm for a further 27 seconds before changing to any other higher speed as requested by the power/control module. This is to provide a softer start before the compressor potentially ramps up to some higher speed.

Whenever the refrigerator is plugged in/turned on, and/or after a defrost, in the first cooling cycle the control will run the compressor, after its initial start procedure, at its maximum speed, which is 4300 rpm. The compressor will stay at its maximum speed until both compartments have reached their cut-out temperature, at which point the compressor will switch off and the refrigerator goes into the warm-up cycle.

In the subsequent cooling cycles, the algorithm will vary the compressor speed according to the amount of cooling required to achieve an average temperature in each compartment (as measured by the thermistors), equal to the compartment set temperatures with a 1 hour run-time.

In low ambient, where the heat load and/or cabinet usage is low, the compressor will be likely to run at its minimum speed (1590rpm), and switch off more frequently than once every hour, similar to most non-VCC product.

When the compressor is running at slow speeds, the evaporator may not be fully flooded, but this is normal.

6.2 Built-in Electronic Protections (Within the Module/Inverter)

6.2.1 Compressor Start-up

In case any anomaly occurs during compressor starting, the control will wait 6 seconds before repeating the start-up. If the compressor doesn't start after 12 trials, the control will wait 8 minutes before repeating the start-up procedure (this condition may be when pressures are not equalised between suction and discharge sides in the refrigeration system, eg; after an interruption in the mains supply).

6.2.2 Overload Detection and Protection

The control can detect an overload condition by monitoring the current consumed by the compressor. If overload is detected, the control reduces the current by reducing the speed of the compressor until the overload disappears, when the speed will return to the required value.

If the overload increases, the control will continue to decrease the current until the minimum speed of 1590 rpm may be reached, at which point the compressor may "stall", and the control will return to the start-up procedure.

6.2.3 Power Limitation (Temperature Protection)

The control limits the power supplied to the compressor to 200 watts to keep all electrical components below a safe operating limit. The power is limited in the same way as the current in the overload protection.

6.2.4 Short Circuit Protection

In a case where a short circuit occurs, (eg; motor winding damage, connection faults etc), the same current limiting control is actuated to reduce further damage. In the case of a major failure, a fuse within the inverter will break the current supplied to the control. This fuse cannot be replaced in servicing.

6.3 VCC Module/Inverter Identification

The module/inverter has an identification label giving the following information:

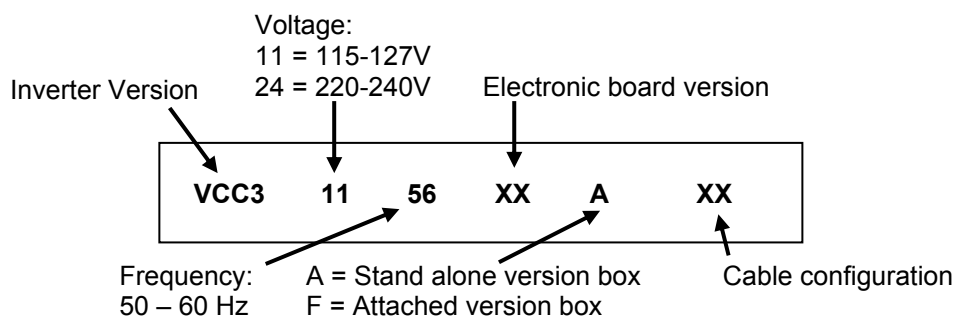

6.4 Fault Finding

6.4.1 High Voltage Power Supply Circuit

Whenever power is supplied to the refrigerator, there should always be mains voltage (230V or 110V as supplied to the appliance by the household supply) in the high voltage harness between the power/control module and the VCC module/inverter. Live testing of the inverter is **NOT** recommended. Check the resistance of the compressor; check the continuity of the harness from the power/control module. If there is continuity through the harness, replace the power/control module.

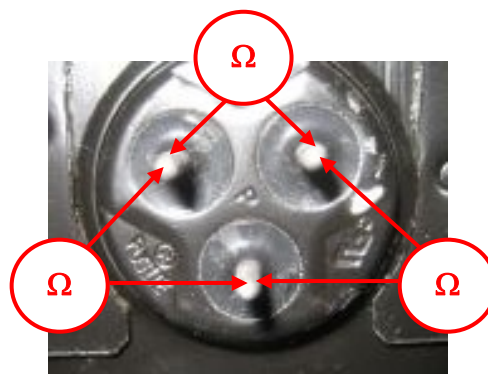

VC COMPRESSOR FUSITE PINS

The later Active Smart[®] cabinets fitted with VCC use a new type of inverter (VCC-3 inverter) having a LED fault code to assist in the diagnostics of both the compressor and the inverter. It uses one single LED lamp to convey, by means of flashes and the interval between flashes, the fact that the inverter is operating as it should be or, if there is a fault, the current fault.

6.5 VCC-3 Inverter With Diagnostic Function

This function has been added to the new generation of VCC inverter in order to help Service Technicians diagnose faults.

6.5.1 Diagnostic Procedures

Diagnostic codes for VCC-3 inverter.

Through a translucent front cover, the VCC-3 inverter flashes a green LED to indicate a fault due to inverter failure, compressor failure or lack of signal from the power/control module.

The LED flashes every 0.5 seconds inside a flash cycle, and each flash lasts 125 milliseconds.

Flashing Cycles:

- Flash Code 1: 1 cycle every 15 seconds (1 flash every 15 seconds).
- Flash Code 2: 2 cycles every 5 seconds (2 flashes every 5 seconds).
- Flash Code 3: 3 cycles every 5 seconds (3 flashes every 5 seconds).
- Flash Code 4: 4 cycles every 5 seconds (4 flashes every 5 seconds).



VCC-3 Diagnostic Codes	
1 Flash	- No failure detected.
2 Flashes	- No signal from power/control module.
3 Flashes	- Inverter failure.
4 Flashes	- Compressor failure.

Figure 1 – Label on the VCC-3 inverter box

Figure 2 – LED position on the inverter box

Code	Compressor Status	Probable Root Causes	Service Action
1 Flash (every 15 seconds)	ON	No Fault Detected. All OK with the inverter.	➤ Check other refrigerator components in case the system is not refrigerating.
	OFF	No signal from power/controller module. - No power to power/control module?	➤ Unplug VCC from the power supply and wait 2 minutes. ➤ Reconnect the VCC to the power supply and wait for 12 minutes.
2 Flashes (every 5 seconds)	OFF	No signal from power/controller module.	➤ Check frequency cable connection. ➤ Check the power to the power/control module. ✳ If the frequency cable connection and power/control module are OK: ➤ Replace the inverter.
3 Flashes (every 5 seconds)	OFF	Compressor / inverter cable interrupted (open circuit). - Inverter damaged? - Compressor winding open circuit?	➤ Check inverter/compressor cable is connected. ➤ Check compressor winding resistance across all three terminals of the compressor fusite. ✳ If the winding resistances are with in specification and both inverter & compressor cables are OK: ➤ Replace the inverter.

Code	Compressor Status	Probable Root Causes	Service Action
4 Flashes (every 5 seconds)	OFF	Compressor damaged / system damaged.	<ul style="list-style-type: none"> ➤ Check compressor input power. ➤ Check compressor winding resistance across all three terminals of the compressor fusite. ➤ Check for earth leakage (current) between the fusite pins and frame shell of the compressor. ✳ If these resistances or leakage are out of specification: <ul style="list-style-type: none"> ➤ Replace the compressor. ✳ If the winding resistance is within specification: <ul style="list-style-type: none"> ➤ Check the inverter and compressor cabling for open circuit. ➤ Unplug the VCC from the power supply and wait 2 minutes. ➤ Reconnect the VCC to the power supply and wait for 12 minutes. ✳ If the inverter still shows 4 flashes code and the compressor is OFF: <ul style="list-style-type: none"> ➤ Replace the compressor.
LED OFF (No LED on)	OFF	<ul style="list-style-type: none"> - No Input power signal. - Inverter damaged. 	<ul style="list-style-type: none"> ➤ Check the input power signal (230 volts). If there is no signal: <ul style="list-style-type: none"> ➤ Check the input power connection from the power/control module. ✳ If the voltage is within specification: <ul style="list-style-type: none"> ➤ Unplug the VCC from the power supply and wait 2 minutes. ➤ Reconnect the VCC to the power supply and wait for 12 minutes. ✳ If the inverter has no LED showing and the compressor is OFF: <ul style="list-style-type: none"> ➤ Replace the inverter. ✳ If the inverter has no LED showing and the compressor is ON: <ul style="list-style-type: none"> ➤ The diagnostic function of the inverter is not working properly.

NOTE

- Before replacing the inverter or the compressor, check that there is no fault in the refrigeration system, for example excessive head pressure on the high side, system over charged with refrigerant, blocked capillary tube, etc.
- After each Service Action has been carried out, follow the next inverter LED fault indication.

6.5.2 Testing The VCC3 Inverter (With Diagnostic Function)

With the aid of a multi-meter, a number of points can be tested on the inverter while it is in a running state. To carry out these tests the probes on the meter need to be sharp and have fine points. The inputs to the inverter and the output can be checked.

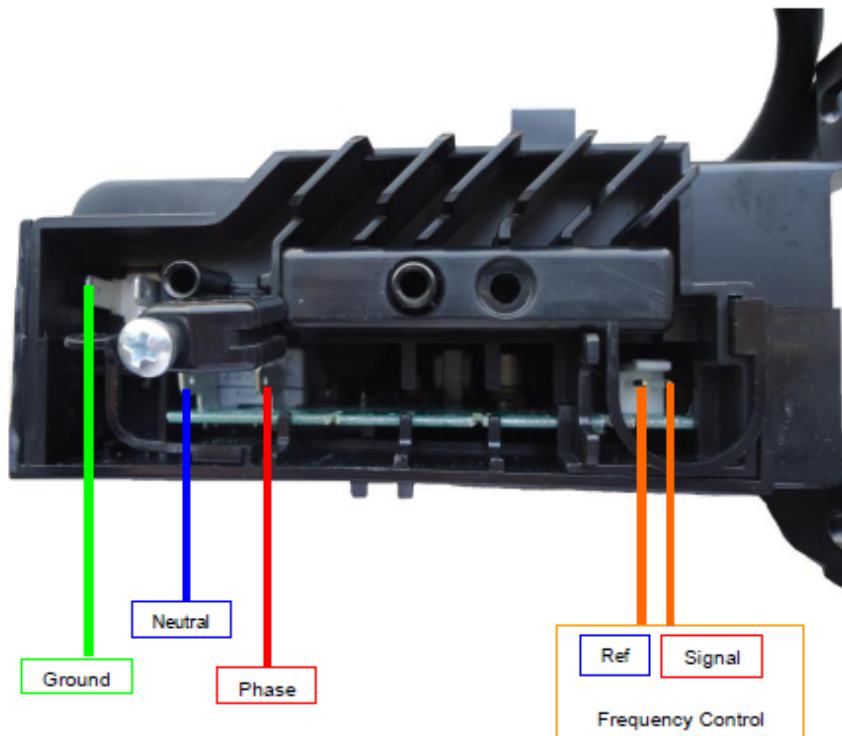
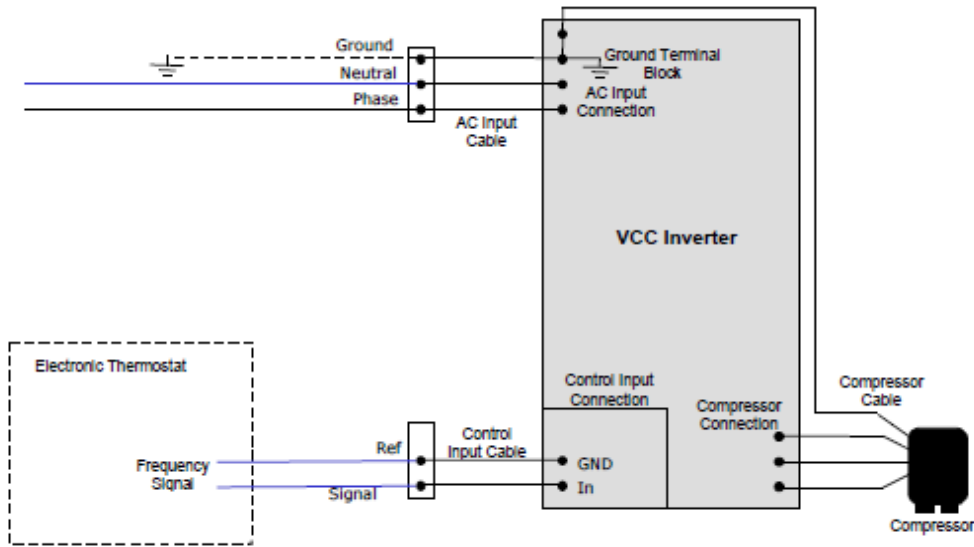

Step 1 – Check the compressor windings resistance.

- With the refrigerator disconnected from the power supply, remove the compressor cover and unplug the fusite terminal connection from the compressor.
- Select the Ohms range on the multi-meter and measure the resistance of all three windings. The resistance should be the same across all three windings. Refer to winding resistances in compressor specifications, Sections 1.3, 1.4 and 1.5.
- Check for leakage to ground from the windings within the compressor.
- Reconnect the fusite plug to the compressor and refit the compressor cover.

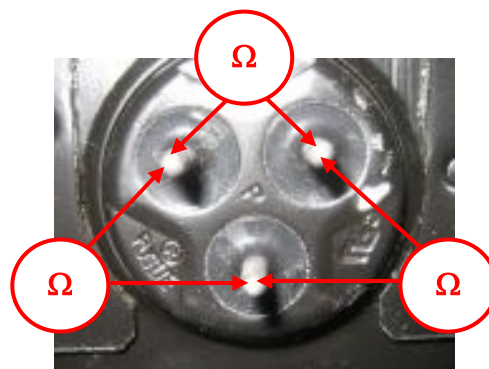

Step 2 – Check the input voltage to the inverter.

- Remove the protective terminal cover from the inverter, reconnect the appliance to the power supply and set the compressor running.
- Select the multi-meter to measure AC volts. With the probes measure the input voltage as shown at the two terminals indicated or at the input harness edge connector.

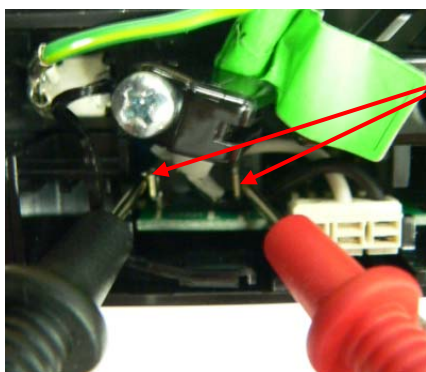

OR

At the back of the edge connector

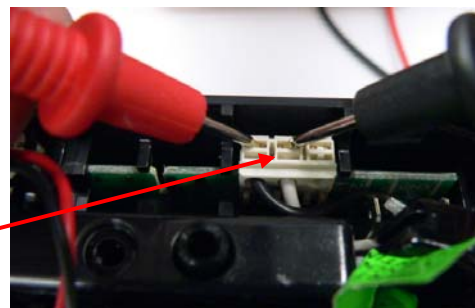

A normal cabinet with no fault:

- Will measure mains voltage (110volts or 230volts) AC input into the inverter.
- The compressor will be running (this can be felt by placing a hand on the compressor shell).
- The LED on the inverter board will be flashing once every 15 seconds as all is normal.

Step 3 – Check the input frequency of the inverter.

- Switch the multi-meter to the frequency range (if it has one). The frequency input into the Inverter from the power controller can be measured.
- There are two terminals alongside the edge connector that this measurement can be taken from in the inverter. How fast the compressor is running will depend on how cold the PC & FC are. Depending on the compressor and the speed it is running at at the time the reading is taken, the frequency will vary between about 53Hz and 177 Hz.
- If unable to obtain a frequency reading from the power controller to the inverter, suspect the fault to be in the power controller.

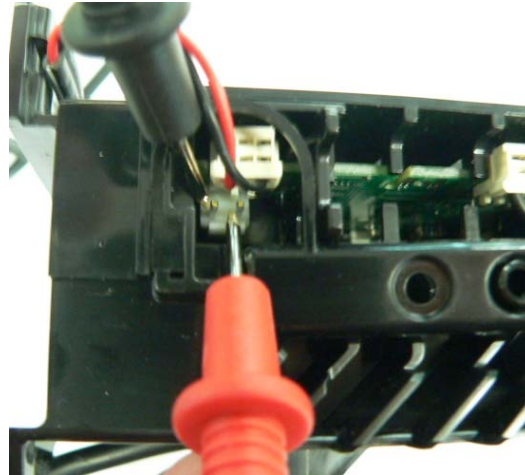
**Output Voltage**

The measurement of an output voltage using a multimeter/voltmeter will not give a valid reading in a no load state, because once the inverter is unable to "sense" the motor inductance on its output it will cease to operate.

The best method would be to use a current probe connected to an oscilloscope and measure one of the output phases (blue, black or brown wires) from the inverter, while the inverter is still connected to the compressor.

While it is appreciated that oscilloscopes and current probes are not commonly available to service technicians, it is not a valid test to even try to measure the output voltage, and that is one of the reasons why we have introduced this type of inverter with the built-in LED diagnostic feature.

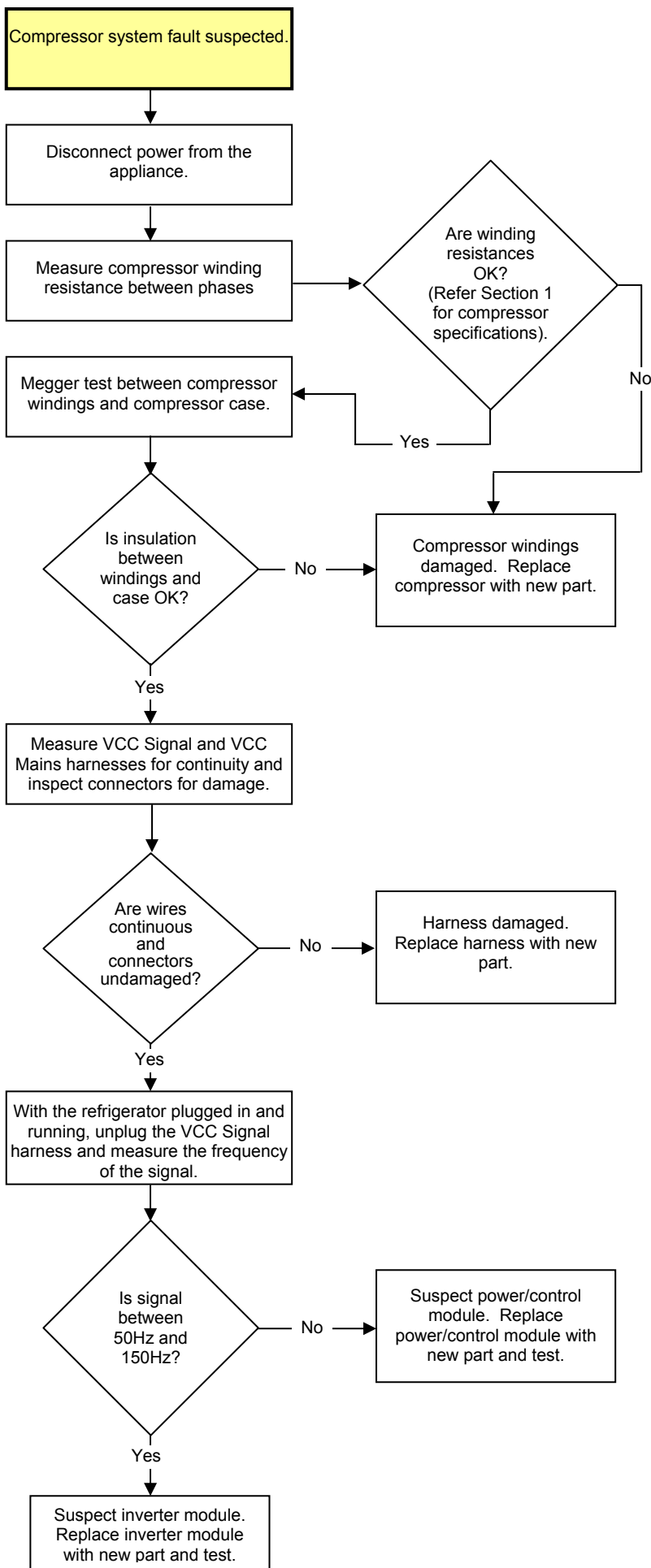

Equipment Required

- Multimeter with resistance (Ω) scale and frequency (Hz) scale.
- Insulation tester (“megger”).
- Spare VCC Inverter.

Note: A damaged compressor could cause damage to the inverter module. If the compressor windings are damaged, the inverter may need to be replaced as well.

Note: A damaged harness could cause damage to the inverter module. If the harness wires have shorted to each other or to the refrigerator chassis, the inverter may need to be replaced as well.

Note: Damage to the power/control module which leaves all other functions of the refrigerator working correctly but the compressor not running is unlikely, but not impossible.

Please double-check that there is no fault in the inverter, compressor or wiring before replacing the power/control module.

7 DISPLAY INTERFACE – ICE & WATER MODELS

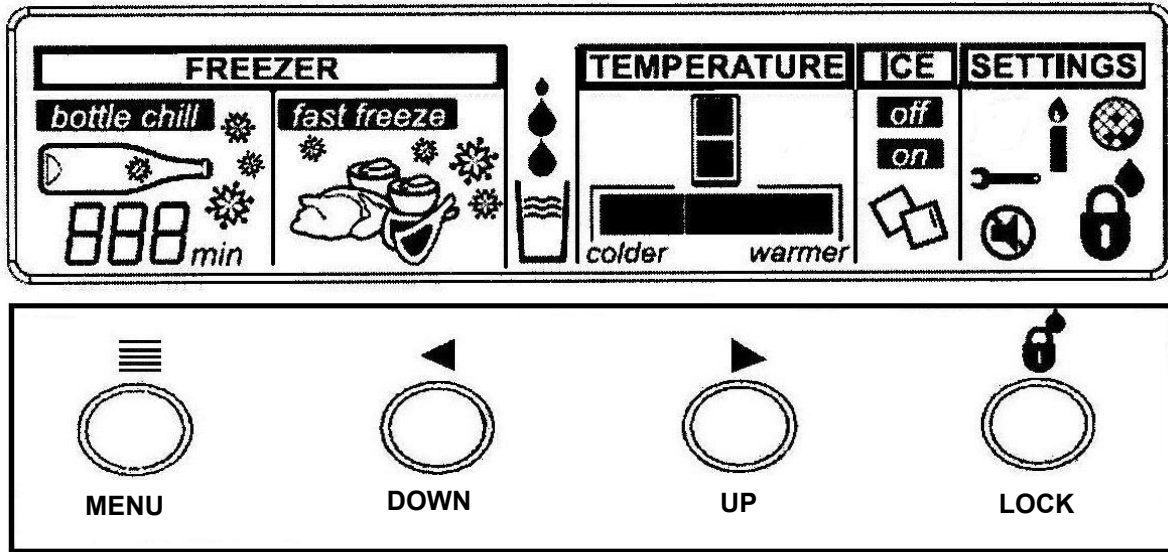

Menu

The **MENU** button allows the user to scroll through the main menu options (Chill, Temperature, Ice and Settings)

Arrow Buttons

The **ARROW** buttons are used to scroll through the settings of each function.

Lock

The **LOCK** button enables and disables the water dispenser and all the buttons.

7.1 Display Functional Schematic



7.2 Display Interface Features

- Icemaker on/off.
- Bottle chill mode – 10, 15, 20, 25, 30 minute timer with alarm.
- Freezer chill mode – nominated freeze time at lower temperature set point.
- Water dispensing.
- Sabbath mode enable/disable.
- Key silent mode enable/disable.
- Dispenser lock.
- Key lock.
- Filter replacement alert.
- Fault alert.
- Diagnostics.
- Temperature set points.

7.3 Features

7.3.1 Icemaker On/Off

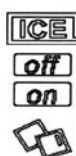

This mode turns the icemaker on or off.

To access the ice mode, press the **MENU** button until **ICE** is highlighted. Then use an **ARROW** button to scroll to the icemaker ON or OFF.

7.3.2 Freezer Chill Mode



Freezer chill is a function that rapidly freezes food in the FC by temporarily dropping the freezer to its coldest temperature set point for a 12-hour period.

To access, use the **MENU** button to scroll to **FREEZER**, then use the up or down button to get fast freeze.

To deactivate manually, use the **MENU** button and scroll to **FREEZER**. Press the **DOWN** button until the icon disappears.

7.3.3 Bottle Chill Mode



Bottle Chill allows the customer to put a bottle in the freezer for a designated amount of time. When that amount of time has elapsed an alarm will sound telling the customer to take the bottle out of the FC. The freezer automatically changes to its lowest set point.

The times are 10, 15, 20, 25 and 30 minutes.

To activate this mode, use the **MENU** button to scroll to **FREEZER**, then use the **UP** button until this icon appears. Use the **UP** button to select the time in minutes. Once selected, the alarm countdown will commence.

7.3.4 Water Dispensing

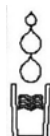

This icon will animate when the water is being dispensed.

7.3.5 Sabbath Mode



When in this mode, the alarms are deactivated and the interior light and back light on the display will not come on. The interior fan will not turn off when the door is opened.

7.3.6 Key Silent Mode



When in this mode, the beeper does not operate when the buttons on the keypad are pressed. **NOTE:** Faults, bottle chill, and the door will still alarm when the refrigerator is set in Key Silent mode.

When this icon is displayed, it indicates the product is in Key Silent mode.

To activate or deactivate, hold the **MENU** button for four (4) seconds.

7.3.7 Dispenser Lock



This mode disables the water dispensing pad and prevents water from being dispensed.

To activate this mode, press the **LOCK** button for 2 seconds.

7.3.8 Key Lock



This mode disables all the buttons.

To activate this mode, press the **LOCK** button for 4 seconds.

7.3.9 Filter Replacement Alert























This icon will appear when the water filter needs changing. The filter needs replacing every 2800 Litres or 6 months. This will flash when dispensing water.

To deactivate the warning, press the **LOCK** and **UP** buttons simultaneously for 4 seconds.

7.4 Key Presses

To activate any mode, certain combinations of key presses are required.

The key-presses are as follows. Key presses used by the service technician are those shown shaded.

Version 2 LCD Display			
Function	Key Presses	Action	Press Time
Dispenser Lock	Lock 	On/Off	Hold down for 2 seconds
Key Lock	Lock 	On/Off	Hold down for 4 seconds
Diagnostic Mode	Menu + Up  + 	On	Hold down for 4 seconds
Manually Forced Defrost	Menu + Down  + 	On	Hold down for 4 seconds
Sabbath Mode	Lock + Menu + Down  +  + 	On/Off	Hold down for 4 seconds
Disable Filter Alarm	Menu + Up + Lock  +  + 	On/Off	Hold down for 4 seconds
Show Off Mode	Menu + Down + Up  +  + 	On/Off	Hold down for 4 seconds
Filter Reset	Lock + Up  + 	Reset	Hold down for 4 seconds
Manually Force Icemaker Harvest	Lock + Down + Up  +  + 	Activates once	Hold down for 4 seconds

7.5 Temperature Settings

PC Setting

0.0°C	0.5°C	1.0°C	1.5°C	2.0°C	3.0°C	4.0°C	5.0°C	6.0°C	7.0°C	8.0°C
32°F	32.9°F	33.8°F	34.7°F	35.6°F	37.4°F	39.2°F	41°F	42.8°F	44.6°F	46.4°F

Colder

Warmer

FC Setting

-21.0°C	-20.0°C	-19.5°C	-18.5°C	-18.0°C	-17.5°C	-17.0°C	-16.5°C	-15.5°C	-15°C	-14.0°C
-5.8°F	-4.0°F	-3.1°F	-1.3°F	-0.4°F	0.5°F	1.4°F	2.3°F	4.1°F	5°F	6.8°F

Colder

Warmer

Default factory settings are +3°C (37.4°F) for the provision compartment and -18°C (-0.4°F) for the freezer compartment.

NOTE: Crowbar setting for the PC is -4°C (24.8°F) and for the FC is -26°C (-14.8°F). Temperatures shown are average temperatures.

8 ICEMAKER

8.1 Ice Production

The icemaker comes out of the factory defaulted to off. To turn the icemaker on, press the **MENU** button to scroll until the **ICE** option has been scrolled to.

Press the **UP** or **DOWN** buttons to turn the icemaker on or off. When the cubes are frozen, the icemaker motor will turn the ice cube tray and twist the tray causing the ice cubes to dislodge and fall out of the tray. The tray will then return to its normal position and refill with water.

NOTE: If the FC is above -10°C (14°F) or the ice bin is full, or has been removed, or fitted the wrong way around, the icemaker will not operate.

8.2 Information About The Icemaker

- The icemaker moulds in these later cabinets have 30% larger ice block moulds in the tray. The tray can be identified by a number of dimples in the middle of the side edge.



- The water fill time has been increased to 5.7 seconds to allow the tray to fill. This has been achieved by the use of 16-watt inlet water valves, thus increasing the flow rate to both the water dispenser and the icemaker unit.
- The solenoid valves are not interchangeable with those used on earlier model cabinets.
- The temperature of the FC needs to reach below -10°C (14°F) before the icemaker commences to operate.
- When first switched on, the icemaker carries out a harvest with no water in the ice tray.
- Once the ice tray resumes its normal position, the water will fill the tray. At this stage it will calculate the amount of time taken to do a cycle, and then flips. After this point it will run normally, calculating the amount of time for each batch. The rate of production will depend on the temperature of the freezer.

NOTE: If the temperature is above -10°C (14°F), the ice/water tray will sit in this position and will not turn to dispense.

- The cubes will be ejected from the mould into the ice bin. It is suggested that the ice cubes are levelled with the ice scoop occasionally for maximum storage.
- The large and small freezer bins can be rotated if a large amount of ice is required.

To manually force a harvest.

Press the **DOWN**, **UP** and **LOCK** buttons together and hold for 4 seconds. The icemaker will rotate and empty the contents of the ice tray, then return to its normal position. The ice tray will then fill with water.

NOTE:

- A forced harvest will operate without the product being down to temperature. If the harvest does not work, the sensor may be not connected or may be open circuit. The icemaker sensor must be in circuit for a forced harvest to work.
- When forcing a harvest of the icemaker, the bin must be in place for the harvest to occur.

8.3 Ice Bin Full Sequence

When the ice bin is full, the icemaker starts a sequence of testing to ensure ice harvest can continue. If the icemaker senses the bin is full, the motor resumes its normal position. Twenty minutes later, the testing sequence commences until such time as the ice level is reduced by usage. The testing sequence happens every 20 minutes.

Bin in position

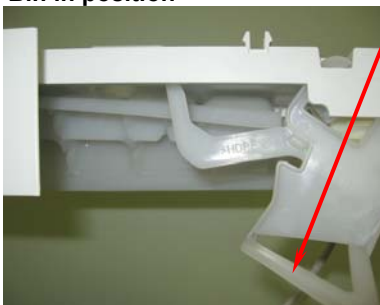

Bin lever – senses if there is a bin in position or not.

If there is no bin, lever will be in the down position as shown.

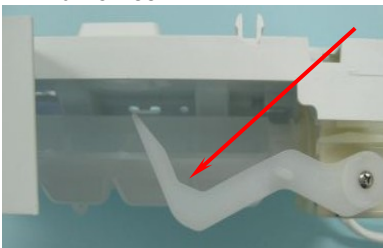

Bin full of Ice

Lever sensing if ice bin is full.

If bin is not full, icemaker continues rotation to eject ice.



8.4 Safety First

- When first placed into operation, discard the first bin of ice, as this will remove any impurities that may have been in the water system.
- Do the same after vacations or extended periods when ice is not used.
- Ice cubes, when not used, will become cloudy, will shrink, and will taste stale. The ice bin will need to be emptied and cleaned periodically.
- Avoid contact with moving parts of the ejector mechanism.
- Do not place fingers on the automatic ice making mechanism while the refrigerator is turned on.

8.5 Icemaker Fill Tube Heater

There is a heater located under the fill tube nozzle to prevent the fill tube from freezing. It is connected in series with the low ambient heater.

8.6 Pressure Limiting Valve

The pressure limiting valve must be fitted between the water supply tap and the inlet hose to the refrigerator to limit the pressure of the water supply. It must be fitted a minimum of 250mm (10 inches) from the tap to prevent water hammer.

The valve has an outlet pressure of 600Kpa. The flow direction is marked by an arrow on the side of the valve.



Diagram 8.6

8.7 Water Inlet Valves

The water inlet valves are rated at 16 watts and have a flow rate of 2 litres (0.5 gallon) per minute. Both coils are coloured red. The earlier water inlet valves were coloured blue and rated at 10 watts. The 16-watt valve is not interchangeable with the older 10-watt valves.

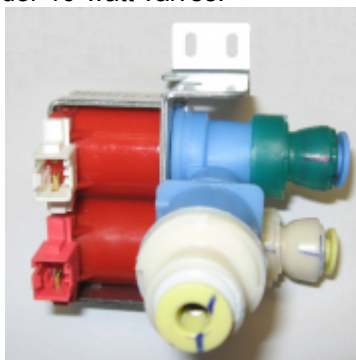

Diagram 8.7

8.8 Noises

The introduction of ice & water into Active Smart® products introduced some unfamiliar noises, which are normal. The noises are difficult to hear and may not be heard during the day, but during the night they may sound louder.

Cracking Noise

The ice cracking is due to the ice tray being twisted to loosen the ice cubes in the ice tray.

Humming

There will be a low humming noise when the ice tray motor/gearbox rotates the tray to flip the ice cubes from the tray.

Clunking Noise

Ice falling into the ice bin may initially make a noise that will lessen with subsequent harvests. The reason for this is that initially there is no ice in the bin, but as the bin fills with ice the noise lessens.

Water Filling

After the ice tray empties and returns to its normal position, the water valve opens to fill the tray. The noise will be a hissing or water running noise. How often this noise occurs will be dependent on the time the water takes to freeze, form into ice blocks and then harvest into the ice bin.

8.9 Ice & Water Common Complaints

The following are common complaints/problems/concerns regarding ice and water, which may or may not have occurred. Explanation for these faults is given for the serviceman to better deal with customers having concerns.

Sublimation

When ice is not being used on a continual basis, cold dry air from the evaporator passes over the ice, causing the ice to dehydrate (evaporate, moisture is removed) and the ice will slowly disappear.

Ice Sticking Together

If the FC door is left open for an extended period or the ice bin is removed and allowed to warm up, the customer may find the ice cubes sticking together in the bin to form a large block.

Where a large block of ice is formed, the block will need to be removed to start the ice making process again.

Another reason for large blocks of ice can be due to water leaking from the fill tube onto the ice tray and overflowing the mould, check for leaking diaphragm in the water inlet valve.

Discolouration / Metallic Taste

Where the water or ice cubes are discoloured, they should not be used. If the water is a greenish-blue colour the reason for this happening is copper oxide. This is not a common fault but may happen where the water supply to the house is in a copper pipe but for whatever reason the pipe is not earthed. To overcome this problem, the pipe work should be earth bonded to the earth of the house.

Bad Taste

Any fresh food, which is not sealed or wrapped when placed into the freezer, may contaminate the ice with the taste of the unwrapped foodstuff. The ice will need to be thrown out and the ice-making process started again. The customer must be advised to wrap all foodstuffs.

Ice Appears Cloudy

This problem occurs when air or air bubbles are in the water, which normally happens in the early stages and will disappear with use.

Particles In Ice And / Or Water

This is normally due to a new filter where carbon dust in the new filter needs to be flushed out of the system. The particles are harmless and safe for consumption; however, customers are advised to flush the system of three (3) litres of water at every filter replacement (refer to Use and Care manual).

9 WATER DISPENSER

9.1 Installation Precautions / Warning

- **DO NOT** use with water that is microbiologically unsafe or of unknown quality without adequate disinfection before or after the system. (**WARNING** – connect to potable water supply only.)
- **DO NOT** install on line pressures above 827 kPa (119 psi) or below 150kPa (22 psi).
- **DO NOT** use on hot water supply (38°C [100°F] maximum).
- **DO NOT** cut any length of water tube shorter than 500mm (20 inches).
- **DO NOT** install near electrical wires or water pipes that will be in the path of drilling when selecting the location of the filter system.
- **DO NOT** mount the filter in such a position that it will be struck by other items, such as wastebaskets, etc.
- **DO NOT** install the filter or any water tubing in direct sunlight, as prolonged exposure to light can weaken plastic components.
- **DO NOT** install the filter in a location that is susceptible to freezing temperatures as damage to the filter housing could occur.
- **DO NOT** screw the filter to the refrigerator.
- **DO NOT** install the filter or any water tubing in high temperature areas e.g. in a ceiling cavity.
- **AVOID** contamination of pipes during installation.
- **DO NOT** use copper tubing. The plastic tubing supplied should always be used.
- **DO NOT** continuously dispense water for longer than 2 minutes.

IMPORTANT

- All connections must be checked for leaks.
- If unsure of connection process and/or leaks, then contact your local plumber to install and check the system for you.
- Ensure that the 6mm (¼") tubing is routed away from sharp objects, sharp corners (beware of kinking tube as this will stop water flow), clear of the refrigerator unit compartment and not in a location where it can be squashed.
- Ensure that all push-fit connections are firmly pushed into place. The tube should push in 20mm (¾") before reaching the stop.
- If the tubing is removed at any point, re-cut the end and re-insert. The tubing must be fully inserted to avoid leaks.
- To remove the tube from connection points, turn off the isolating tap, then push in the collet and gently pull the tubing at the same time.

9.2 Pressure Dispensing Pad

This pad is located at the rear of the dispensing area and is used to dispense water. Water can be dispensed by pressing the dispenser pad. The display will light up and the water fill icon will appear when the water is dispensed.

The dispenser will not operate while the PC door is open.

9.3 Initial Use

Press the glass or container into the pressure-dispensing pad.

Note: Pressing very hard against the water dispensing pad will NOT make the water dispenser operate any faster or produce greater quantities of water.

Initially allow approximately a one-minute delay from when the pressure-dispensing pad is pushed until the water is dispensed. While the tank is filling, no water sign will appear.

Dispense at least 8 to 10 litres (8 to 10 quarts) of water through the system, stopping intermittently to ensure that air in the tank is flushed out. Failure to do so will result in excessive dripping from the dispenser.

9.4 Water Filter and Cartridge

The product is supplied with a water filter and cartridge. It is recommended that the filter be mounted in a vertical position. Where the filter is positioned is up to the customer.

The replacement icon will appear and blink when the filter needs to be replaced. This is approximately every 6 months.

9.5 Changing The Water Filter

- Turn water off. It is also recommended that the pressure is released by dispensing water with the tap off.
- Grasp and firmly twist the cartridge in an anticlockwise direction (to the left when installed in the recommended orientation).
- Pull the cartridge away from the filter head (down when installed in the recommended orientation).
- Discard the old filter.
- Remove the protective cap on the spigot on the head of the new cartridge.
- Push the cartridge upwards towards the head while rotating it in a clockwise direction (to the right when installed in the recommended orientation).
- Reset the filter icon on the display (this will be set to remind the customer the filter is due to be replaced).

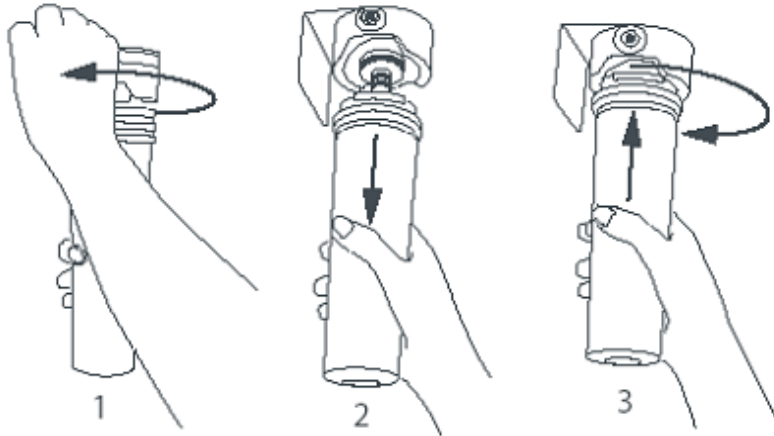

Diagram 9.5

9.6 To Reset The Filter Icon

- Press the **UP** and **LOCK** buttons for 4 seconds to reset the filter monitor.
Note: Do not reset the monitor before the filter is changed, or monitoring will be inaccurate.

9.7 To Disable The Filter Alarm

Disable the alarm if no filter is to be fitted.

- Press and hold the **MENU**, **UP** and **LOCK** buttons for 4 seconds to turn this feature on/off.

10 DIAGNOSTICS

10.1 Ice & Water Models

A spanner symbol and LCD fault code will appear automatically if there is a fault in the temperature measuring system, defrost system, icemaker, fans or low ambient heater. (Refer to the diagram below.)

When the PC door is opened, an alarm will sound. The number of beeps also indicates the fault code. Pressing any of the control buttons can deactivate these alarms.

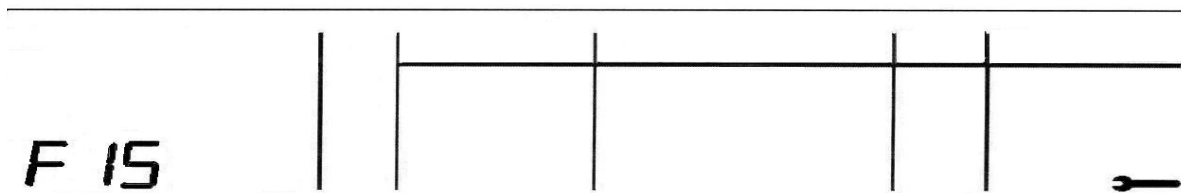

Example: When a fault develops, the LCD fault code appears, together with the spanner (wrench) symbol.

After rectifying the problem, the fault code and spanner will disappear. Faults are only rectified when that feature is used. So in the case of a defrost fault, the code will remain until a defrost is initiated and it is successful.

10.1.1 Fault Codes

Fault Code 1

Reason: On the last power up, the power module failed self test.
 Primary Action: Replace power module.

Fault Code 2

Reason: The previous 2 defrosts were aborted after 40 minutes.
 Primary Action: Check defrost element assembly in the FC. If faulty, replace.

Fault Code 3

Reason: The resistance of all the temperature sensors are outside the normal range (> 45K Ohms).
 Primary Action: Check the 6-way RAST connector at the power module.
 Secondary Action: Re-terminate the 6-way RAST connector.
 Tertiary Action: Replace the power module.

Fault Code 4

Reason: The resistance of all the temperature sensors are outside the normal range (< 660 Ohms).
 Primary Action: Check the 6-way RAST connector at the power module.
 Secondary Action: Re-terminate the 6-way RAST connector.
 Tertiary Action: Replace the power module.

Fault Code 5

Reason: The resistance of the FC sensor is outside the normal range (> 45K Ohms).
 Primary Action: Check the sensor connection at the power module.
 Secondary Action: Replace the sensor.

Fault Code 6

Reason: The resistance of the FC sensor is outside the normal range (<660 Ohms).
 Primary Action: Check the sensor connection at the power module.
 Secondary Action: Replace the sensor.

Fault Code 7

Reason: The resistance of the Evaporator sensor is outside the normal range (> 45K Ohms).
 Primary Action: Check the sensor connection at the power module.
 Secondary Action: Replace the sensor.

Fault Code 8

Reason: The resistance of the Evaporator sensor is outside the normal range (<660 Ohms).
 Primary Action: Check the sensor connection at the power module.
 Secondary Action: Replace the sensor.

Fault Code 9

Reason: The resistance of the PC sensor is outside the normal range (> 45K Ohms).
 Primary Action: Check the sensor connection at the power module.
 Secondary Action: Replace the sensor.

Fault Code 10

Reason: The resistance of the PC sensor is outside the normal range (< 660 Ohms).
 Primary Action: Check the sensor connection at the power module.
 Secondary Action: Replace the sensor.

Fault Code 11

Reason: The current measured for the ambient heater, PC fan and FC fan is lower than expected.
 Primary Action: Check the 6-way fan/LAH RAST connector at the power module.
 Secondary Action: Re-terminate the 6-way fan/LAH RAST connector.
 Tertiary Action: Replace power/control module.

Fault Code 12

Reason: The current measured for the ambient heater, PC fan and FC fan is higher than expected.
 Primary Action: Check the 6-way fan/LAH RAST connector at the power module.
 Secondary Action: Re-terminate the 6-way fan/LAH RAST connector.
 Tertiary Action: Replace the power/control module.

Fault Code 13

Reason: The low ambient heater is drawing less current than expected. Either the heater or wiring is open circuit or the heater is faulty.
 Primary Action: Check the wiring and connections at both the heater and the power module.
 Secondary Action: Check the low ambient heater resistance. If not within limits, replace.

Fault Code 14

Reason: The low ambient heater is drawing more current than expected. Either there is a short in the heater, or the heater is faulty.
 Primary Action: Check the wiring and connections at both the heater and the power module.
 Secondary Action: Check the low ambient heater resistance. If not within limits, replace.

Fault Code 15

Reason: The PC fan is drawing less current than is expected. Either the wiring is open circuit or the fan is faulty.
 Primary Action: Check the PC fan wiring and connections at both the fan and the power module.
 Secondary Action: Check the fan. If faulty, replace.

Fault Code 16

Reason: The PC fan is drawing more current than is expected. Either the wiring is shorted or the fan is faulty.
 Primary Action: Check the PC fan wiring and connections at both the fan and the power module.
 Secondary Action: Check the fan. If faulty, replace.

Fault Code 17

Reason: The FC fan is drawing less current than is expected. Either the wiring is open circuit or the fan is faulty.
 Primary Action: Check the FC fan wiring and connections at both the fan and the power module.
 Secondary Action: Check the fan. If faulty, replace.

Fault Code 18

Reason: The FC fan is drawing more current than is expected. Either the wiring is shorted or the fan is faulty.
 Primary Action: Check the FC fan wiring and connections at both the fan and the power module.
 Secondary Action: Check the fan. If faulty, replace.

Fault Code 19

Reserved.

Fault Code 20

Reason: The flapper heater current is low.
 Primary Action: Check the Molex connections for the flapper heater.
 Secondary Action: Check the resistance of the heater. If open circuit, replace the heater.

Fault Code 21

Reason: The flapper heater current is high.
 Primary action: Check for short circuit of the heater. If faulty, replace the heater.

Fault Code 22

Reason: The resistance of the PC sensor 2 is outside the normal range (> 45K Ohms). PC2 sensor cold.
 Primary Action: Check the connection at the module. Check the resistance of the sensor.
 Secondary Action: Replace the sensor.

Fault Code 23

Reason: The resistance of the PC sensor 2 is outside the normal range (< 660 Ohms). PC 2 sensor hot.
 Primary Action: Check the connection of the sensor at the module. Check the resistance of the sensor.
 Secondary Action: Replace the sensor.

Fault Code 24

Reason: The resistance of the ice tray sensor is outside the normal range (> 45K Ohms). Sensor cold.
 Primary Action: Check the connections of the sensor at the module. Check the resistance of the sensor.
 Secondary Action: Replace the sensor.

Fault Code 25

Reason: The resistance of the ice tray sensor is outside normal range (< 660 Ohms). Sensor hot.
 Primary Action: Check the connections of the sensor at the module. Check the resistance of the sensor.
 Secondary Action: Replace the sensor.

Fault Code 26

Reason: The icemaker motor timed out.
 Primary Action: The icemaker gearbox is not returning to the start position and ends signal to controller.
 Secondary Action: Check the gearbox, and if faulty, replace.

Fault Code 27

Reason: The icemaker motor current is high.
 Primary Action: Check the motor for an obstruction. Check the wiring at both the icemaker gearbox and the power module.
 Secondary Action: Clear for an obstruction. Test the motor operations. Check the gearbox motor resistance. If not within limits, replace motor.

Fault Code 28

Reason: The icemaker solenoid current is high.
 Primary Action: Check the connections to the solenoid. Check the resistance of the solenoid.
 Secondary Action: Correct loose connections. Replace the solenoid if faulty.

Fault Code 29

Reason: the icemaker solenoid current is low.
 Primary Action: Check the connection to the solenoid. Check the resistance of the solenoid.
 Secondary Action: Correct loose connections at the module or the water valve. Replace the solenoid if open circuit.

Fault Code 40

Reason: Icemaker solenoid transistor 1 short circuit. A transistor on the controller that drives the icemaker solenoid has failed. This could be as a result of a fault in the solenoid.
 Primary Action: Check the solenoid resistance. If not within limits, replace the solenoid. Check the wiring and connections at the solenoid and the module. If OK, replace the power/control module.

Fault Code 41

Reason: Icemaker solenoid transistor 2 short circuit.
 Primary Action: Check the solenoid resistance. If not within limits, replace the solenoid. Check the wiring and connections at the solenoid and the module. If OK, replace the power/control module.

Fault Code 42

Reason: Icemaker fill tube heater short circuit. (No audio alarm for this fault.)
 Primary Action: Check the heater resistance. If not within limits, replace the heater. Refer to Section 11.1.10 for details.

Fault Code 43

Reason: Icemaker fill tube heater open circuit. (No audio alarm for this fault.)
 Primary Action: Check the heater resistance. If not within limits, replace the heater. Refer to Section 11.1.10 for details.

DISPLAY FAULTS

If a fault has occurred relating to the display board, the fault code will show on the LCD display just like any other fault.

NOTE: There will be no alarm/beeping if these faults occur.

Code	Fault
F30	No display signal received (shorted or broken wire).
F31	No display signal received (shorted or broken wire) clock or data line.

10.1.2 Testing Icemaker Sensor

The icemaker sensor is located on the bottom of the ice cube tray. The testing is carried out at the power module.

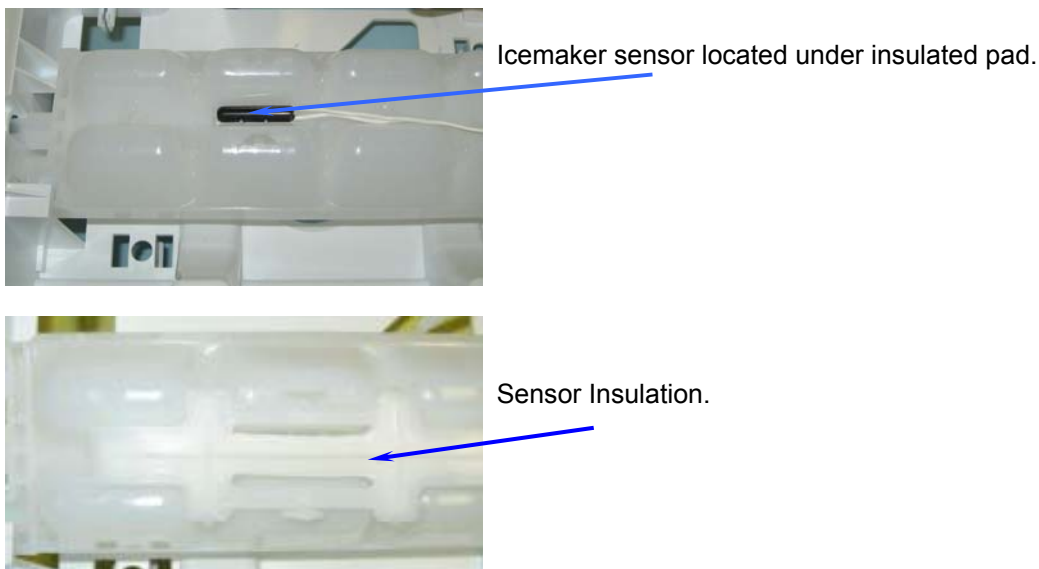

- Disconnect the refrigerator from the power supply.
- Remove the power module from the product.
- Test the two white wires marked "0V" and "Ice Sensor" on the controller.
- Testing of the sensor resistance should be in a known stable temperature, such as a glass of water full of ice cubes. Refer to sensor resistance table (refer to Section 4.22).

10.1.3 Testing Icemaker Motor

Testing of the icemaker motor is carried out at the power module.

NOTE: Before any testing is carried out, ensure the product has an ice bin in place and the icemaker arm is in the down position.

Procedure:

- Disconnect the refrigerator from the power supply.
- Remove the power module to expose connectors.
- Remove the connector marked *Icemaker* from the module.
- Check the resistance of the motor between pins 5 and 6 – resistance should be $35\Omega \pm 5\%$.
- Check the tact switch continuity between pins 4 and 7 – the switch should be closed.

NOTE: To identify pin numbering, Pins 10 and 11 are White wires

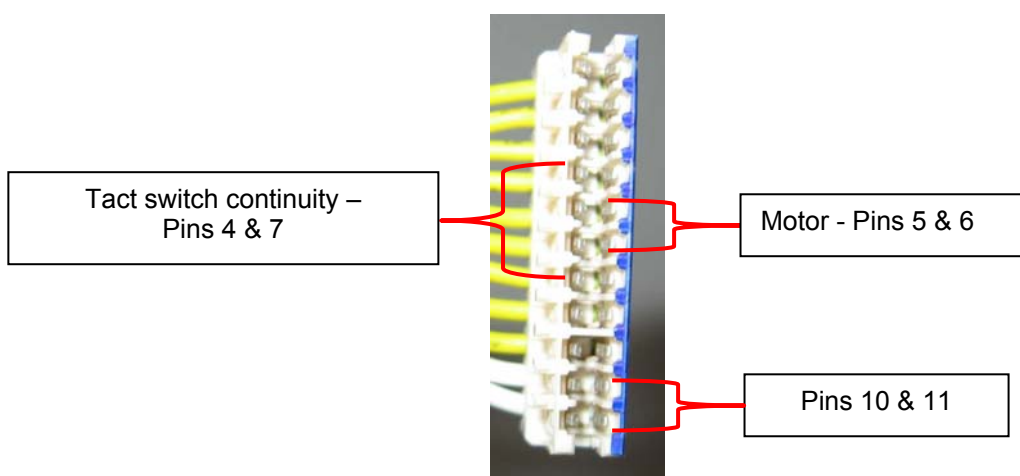

If the icemaker sensor needs to be replaced, refer to Section 11.1.4.

321144

The alternative method of testing the icemaker unit is to use a 9-volt battery plus battery terminal and a multi meter. The meter probes should be placed into the back of the icemaker 4 way socket onto the yellow and blue wires. Check the continuity of the circuit to the tact switch in the ice mould tray. The switch should be closed.

By applying a 9 volt DC supply across the white and red wires of the plug to the icemaker motor, it is possible to drive the ice mould tray forward to a full twist of the tray and the tact switch will close again.

Note:

- 9-volt battery positive to the red wire to go forward.
- 9-volt battery positive to the white wire to go backwards.



Checking the tact switch

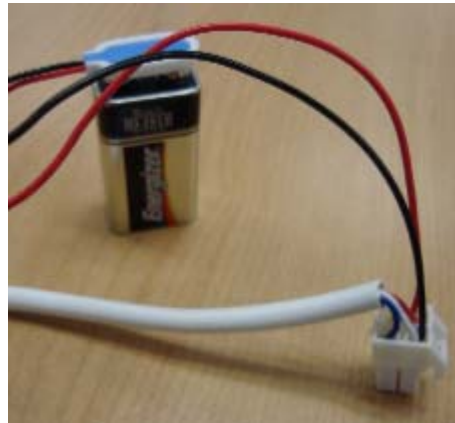

Advancing the motor

10.1.4 Testing Water Valve

The water valves are located in the compressor unit compartment.

- Disconnect the refrigerator from the power supply.
- Remove the connector from the valve.
- Resistance of the water valves is $14 \Omega \pm 5\%$ (blue coils) and $10 \Omega \pm 5\%$ (red coils).

When testing for voltage at the ice or water valve:

- Disconnect the refrigerator from the power supply.
- Remove the connector from the water valve.
- Place the meter probes into the connector of the valve that is faulty (ice valve or water dispenser valve).
- Reconnect the refrigerator to the power supply.
- Place a glass into the dispenser to operate the valve (for water dispenser valve only).
- Place the product into a forced harvest (for icemaker only).

The voltage at the connector (once disconnected from the valve) should be 12 volts DC. Care should be taken not to damage the connector or wiring.

10.1.5 Diagnostic Modes

To enter diagnostic modes, press and hold the **MENU** button, then press the **UP** button for 4 seconds. The PC sensor temperature will be displayed on the LCD as shown in Diagram A. The actual temperature of the PC is shown.

NOTE 1: All temperatures shown on display are in degrees Celsius.

NOTE 2: The door alarms do not operate when the appliance is in diagnostic mode.

PC Sensor Temperature

NOTE: 4.0 shown on display, indicates the temperature of the PC sensor is 4.0°C (39.2°F).

Diagram A

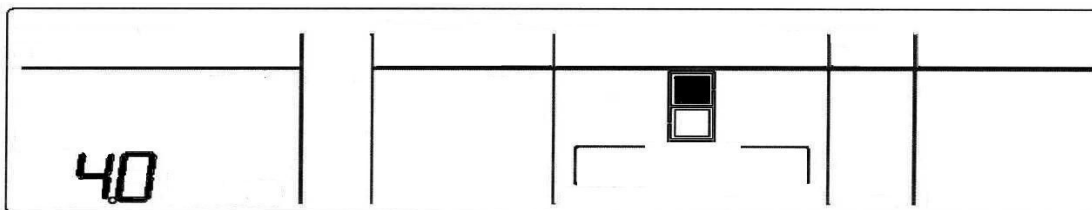

PC Sensor Temperature

FC Sensor Temperature

Press the **UP** button once more – FC sensor temperature.

NOTE: 12.0 min shown indicates the temperature of the FC sensor is -12°C (10.4°F).

Diagram B

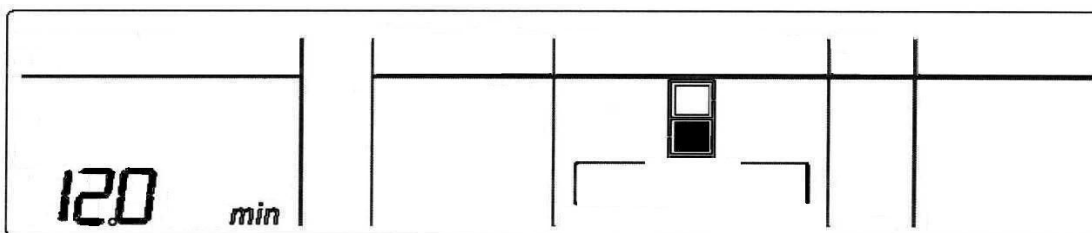

FC Sensor Temperature

Defrost Sensor Temperature

Press the **UP** button once more – Defrost sensor temperature.

NOTE: 18.0 min shown indicates the temperature of the Defrost sensor is -18°C (0.4°F).

Diagram C

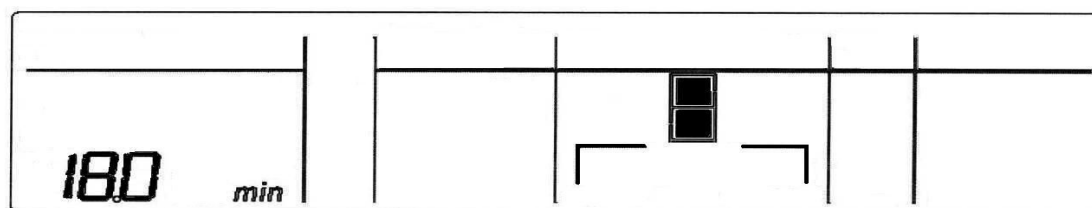

Defrost Sensor Temperature

Input/Output Status

Press the **UP** button once more – Input/Output status.

IO shown indicates the product is in input/output status. The LCDs that are highlighted indicate what components are on (refer to Section 10.1.6).

NOTE: When the PC door is opened, the backlight will turn off. The LCD for the FC or PC door will come on when either door is opened.

The IO shown stands for Input/Output, not a temperature.

Diagram D

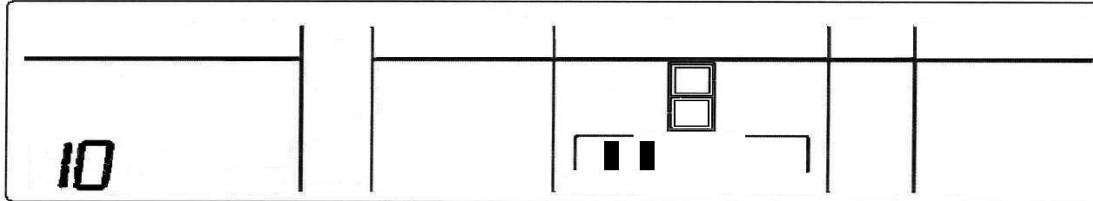

Input/Output Status

PC2 Sensor Temperature

Press the **UP** button once more – PC2 sensor. This sensor is attached to the water tank.

NOTE: 5.0 shown indicates the temperature of the PC2 sensor is 5°C (41°F).

Diagram E

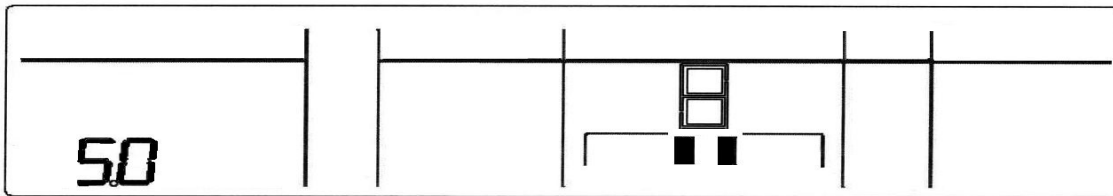

PC Sensor 2

Icemaker Sensor Temperature

Press the **UP** button once more – Icemaker sensor.

NOTE: 12.0 min shown indicates the temperature of the Icemaker sensor is -12°C (10.4°F).

Diagram F

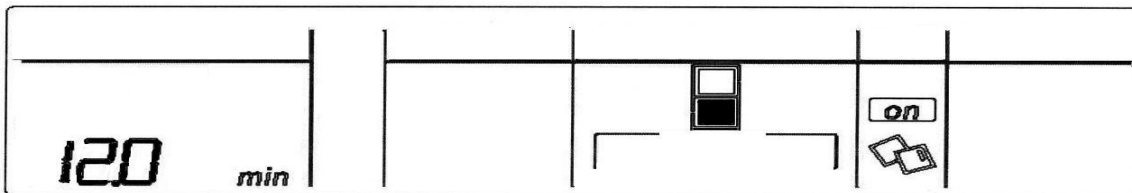

Icemaker Sensor

Fault History

Press the **UP** button once more – Fault History.

H O will be showing.

Diagram G

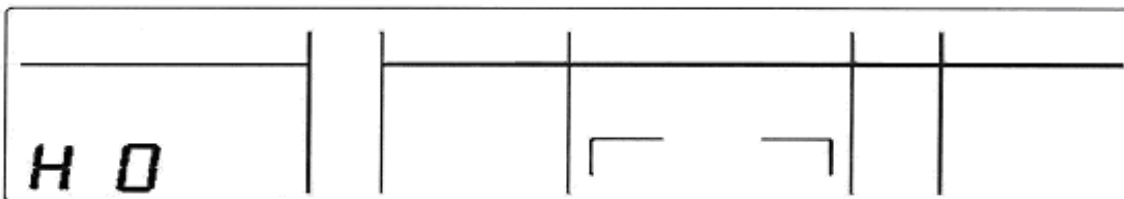

Fault History

To exit the diagnostic mode, press the **MENU** button. If not terminated manually, the diagnostic mode will time out and go back to default display after 5 minutes.

10.1.6 Input / Output Status

To enter input / output status:

- Press and hold the **MENU** button, then press the **UP** button for 4 seconds. This enters the Diagnostic mode.
- Press the **UP** button three times. The current input /output status will be displayed.
 - If a device is on or a door is open, the respective LCD will be on.
 - Return to normal operation by pressing the **MENU** button.
 - **NOTE:** Only the first 6 LCD's are used. The last 5 are not used.

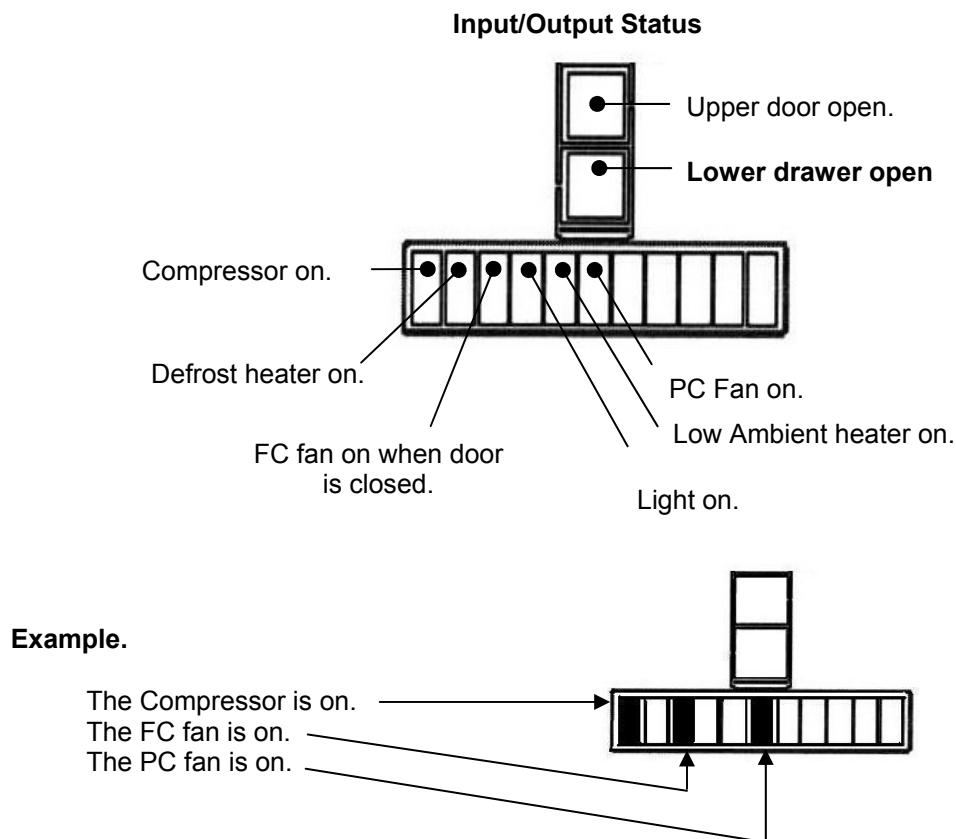

NOTE: In I/O mode the illumination of the LCD will turn off if either PC doors are opened.

10.1.7 Fault History

The Fault History will indicate the last fault that occurred with the product. However, this will only be displayed for a periods of 4 days, after which it can only be accessed through a download. It will also indicate if there are any further faults with the display board. If an icemaker display fault has occurred, these will be indicated by fault codes F40 or F41 on the LCD Display.

NOTE: This is fault history and may not necessarily be a current fault.

10.1.8 To Manually Force A Defrost

While pressing and holding the **MENU** button, press the **DOWN** button for 4 seconds.

NOTE: The defrost cycle will not **start** if the defrost sensor is above +8°C.

The defrost cycle follows a predefined sequence. Refer to Section 4.3 for details of the defrost cycle.

10.1.9 LCD Display

When the PC door is opened, the backlight of the display will turn off and the functions will not operate i.e.: the water dispenser will not work and temperature setting etc. cannot be altered.

However, if the door is left open for 5 minutes, the interior light will turn off and the alarm will sound. At this point the display will start working and all functions will be operative.

10.1.10 To Manually Force The Icemaker

Press **LOCK** button first, then press the **DOWN** and **UP** buttons and hold all three buttons for 4 seconds. This will activate the icemaker.

NOTE: If the bins are removed to observe the icemaker operation, the icemaker will start to rotate. However, if the bin lever device is in a down position, the icemaker will not rotate. The lever-lock needs to be either removed or pushed backwards for the icemaker to complete a full rotation.



Bin lever in down position. When in this position, the icemaker will not rotate/harvest.

10.1.11 Data Download

To place the product into download mode, press and hold the **MENU** button, then press the **UP** button for four seconds, then press the **DOWN** button.

Once the product is in a download mode, either of the flashing LEDs either side of the dispenser pad switch can be used. Place the download pen towards the LED and start the download. The display will have the letters "dl", signifying the product is in a download mode.

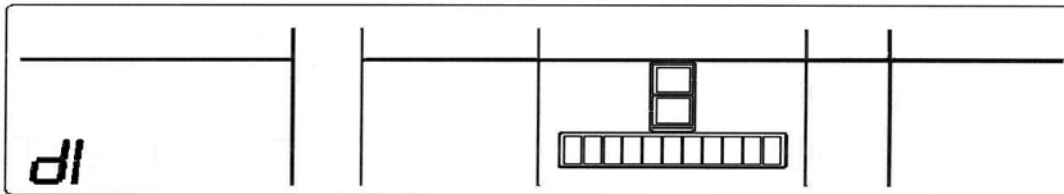

10.2 Non-Ice & Water Models

10.2.1 Fault Codes

If a fault should develop in the temperature measurement system, defrost system, fans or low ambient heater, a fault code will be shown automatically on the display and the fault audio alarm will sound. At the same time, the bottom LED will flash red alternately with the fault LED(s). When any control button is pressed, the audio alarm is turned off although the display will continue to be “flashed” instead of the normal “back-lit” display.

The refrigerator goes through a sequence of tests whenever it is turned on at the power supply or whenever the door is closed while it is on. It takes 20 seconds to complete the test sequence, and opening a door will interrupt it. If, for example, there is a fault with the fans/low ambient heater connector at the power/control module (it may be unplugged), and a door is opened as soon as the fault audio alarm sounds, the fault code shown will be code 13 (low ambient heater drawing less current than expected). This is because the low ambient heater is the first item tested and so the refrigerator will fault for this but carry on with more tests. If the doors are left closed until the tests are completed (after 20 seconds), the fault code shown will be code 11 (the current measured for the ambient heater, PC fan and FC fan is lower than expected). It is therefore recommended that if the fault audio alarm sounds as soon as the refrigerator is turned on, or as soon as the doors are closed, the service technician should wait for 20 seconds before opening the door to check the fault code. This will allow the refrigerator to complete the sequence of tests and will ensure that the fault code displayed is the correct one.

To reset the audio alarm, disconnect the refrigerator from the power supply for a few seconds. If this is not done, the audio alarm will automatically reset after 72 hours.

Fault codes will be in a binary code and the LEDs that flash will have the following binary values:

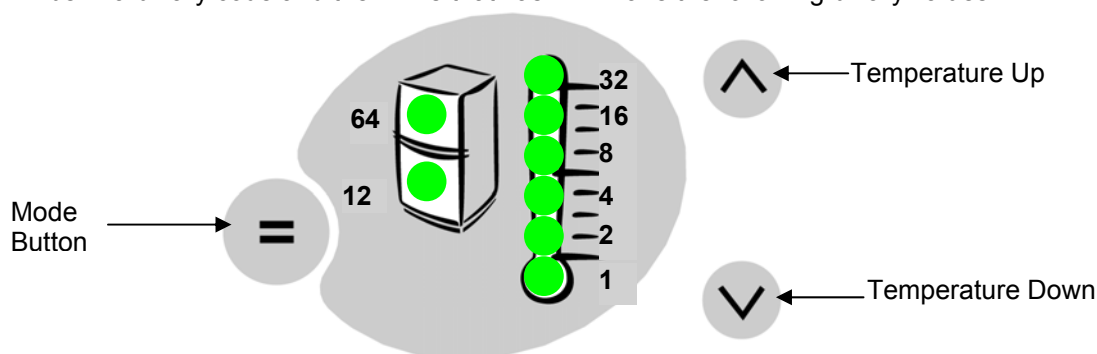

To determine the value of the displayed fault code, add up the values of the LEDs that are flashing (ignore the flashing red LED). The faults and their respective fault code that can be checked and serviced in the field are as follows:

Fault Code: 1

Reason: On the last power up, the power/control module failed its self-test.
 Primary Action: Replace the power/control module.

Fault Code: 2

Reason: The previous 2 defrosts were aborted after 60 minutes.
 Primary Action: Check the defrost heater assembly in the FC. If faulty, replace.
 Secondary Action: Check the power/control module is supplying mains voltage (230V or 110V as appropriate) to the heater during defrost. If not, replace the power/control module.

Fault Code: 3

Reason: The resistance of all the temperature sensors is outside the normal range (> 45K Ohms).
 Primary Action: Check the 6-way RAST connector at the power/control module.
 Secondary Action: Re-terminate the 6-way RAST connector.
 Tertiary Action: Replace the power/control module.

321144

Fault Code: 4

Reason: The resistance of all the temperature sensors are outside the normal range (< 660 Ohms).
Primary Action: Check the 6-way RAST connector at the power/control module.
Secondary Action: Re-terminate the 6-way RAST connector.
Tertiary Action: Replace the power/control module.

Fault Code: 5

Reason: The resistance of the FC sensor is outside the normal range (> 45K Ohms).
Primary Action: Check the sensor connection at the power/control module.
Secondary Action: Replace the sensor.

Fault Code: 6

Reason: The resistance of the FC sensor is outside the normal range (< 660 Ohms).
Primary Action: Check the sensor connection at the power/control module.
Secondary Action: Replace the sensor.

Fault Code: 7

Reason: The resistance of the evaporator sensor is outside the normal range (> 45K Ohms).
Primary Action: Check the sensor connection at the power/control module.
Secondary Action: Replace the sensor.

Fault Code: 8

Reason: The resistance of the evaporator sensor is outside the normal range (< 660 Ohms).
Primary Action: Check the sensor connection at the power/control module.
Secondary Action: Replace the sensor.

Fault Code: 9

Reason: The resistance of the PC sensor is outside the normal range (> 45K Ohms).
Primary Action: Check the sensor connection at the power/control module.
Secondary Action: Replace the sensor.

Fault Code: 10

Reason: The resistance of the PC sensor is outside the normal range (< 660 Ohms).
Primary Action: Check the sensor connection at the power/control module.
Secondary Action: Replace the sensor.

Fault Code: 11

Reason: The current measured for the ambient heater, PC fan and FC fan is lower than expected.
Primary Action: Check the 6-way fan/LAH RAST connector at the power/control module.
Secondary Action: Re-terminate the 6-way fan/LAH RAST connector.
Tertiary Action: Replace the power/control module.

Fault Code: 12

Reason: The current measured for the ambient heater, PC fan and FC fan is higher than expected.
Primary Action: Check the 6-way fan/LAH RAST connector at the power/control module.
Secondary Action: Re-terminate the 6-way fan/LAH RAST connector.
Tertiary Action: Replace the power/control module.

Fault Code: 13

Reason: The low ambient heater is drawing less current than expected. Either the heater or wiring is open circuit or the heater is faulty.
Primary Action: Check the wiring and connections at both the heater and the power/control module.
Secondary Action: Check the ambient heater resistance. If not within limits, replace.

Fault Code: 14

Reason:

The low ambient heater is drawing more current than expected. Either there is a short in the heater or wiring, or the heater is faulty.

Primary Action:

Check the wiring and connections at both the heater and the power/control module.

Secondary Action:

Check the ambient heater resistance. If not within limits, replace.

Fault Code: 15

Reason:

The PC fan is drawing less current than expected. Either the wiring is open circuit or the fan is faulty.

Primary Action:

Check the PC fan wiring and connections at both the fan and the power/control module.

Secondary Action:

Check the fan. If faulty, replace.

Fault Code: 16

Reason:

The PC fan is drawing more current than expected. Either the wiring is shorted or the fan is faulty.

Primary Action:

Check the PC fan wiring and connections at both the fan and the power/control module.

Secondary Action:

Check the fan. If faulty, replace.

Fault Code: 17

Reason:

The FC fan is drawing less current than expected. Either the wiring is open circuit or the fan is faulty.

Primary Action:

Check the FC fan wiring and connections at both the fan and the power/control module.

Secondary Action:

Check the fan. If faulty, replace.

Fault Code: 18

Reason:

The FC fan is drawing more current than expected. Either the wiring is shorted or the fan is faulty.

Primary Action:

Check the FC fan wiring and connections at both the fan and the power/control module.

Secondary Action:

Check the fan. If faulty, replace.

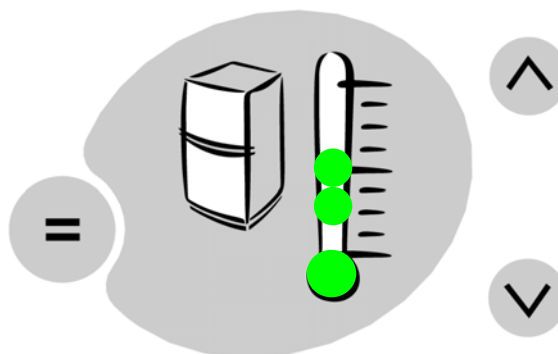

Example Fault Code: $8 + 4 + 1 = 13$
 $13 =$ Low Ambient Heater Open Circuit

10.2.2 Diagnostic Mode For Service

To Select The Diagnostic Mode:

Press and hold the **MODE** button, then press the **TEMPERATURE UP** button.

The LEDs indicate the PC sensor temperature. The current PC sensor temperature is displayed in a code form (refer Section 10.2.3).

Return to normal operation by pressing the **MODE** button.

CAUTION: In reading temperatures there is a need to enter the required mode when the door is first opened, as all temperature readings are only sensor temperature/air temperatures and these will change rapidly with the increase in air temperature as soon as the door is opened.

When in diagnostic mode, press the **TEMPERATURE UP** button.

1 time = FC sensor temperature. The current FC sensor temperature is displayed in a code form (refer Section 10.2.3).

2 times = Defrost sensor temperature. The current defrost sensor temperature is displayed in a code form (refer Section 10.2.3).

3 times = Inputs/outputs status (refer Section 10.2.4).

To exit the diagnostic mode, press the **MODE** button. If not terminated manually, diagnostic mode will time out and go back to default display after 5 minutes.

NOTE: The door alarms do not operate when the appliance is in diagnostic mode.

10.2.3 Sensor Temperature Conversion

To obtain the temperature of either compartment sensor or defrost sensor:

1. Enter the diagnostic mode (refer Section 10.2.2) and scroll to the appropriate sensor temperature.
2. Add up the binary number indicated by the LED light pattern (refer diagram below).
3. Subtract 40 from the result to get the temperature.

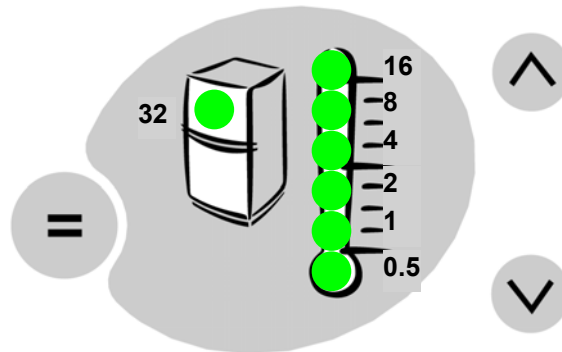

Example:

Add up the number corresponding to each LED that is on:

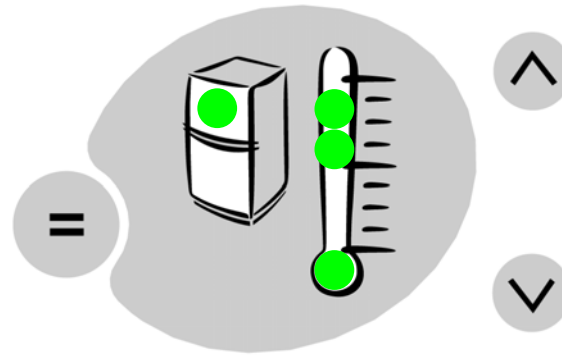

$$0.5 + 4 + 8 + 32 = 44.5$$

Subtract 40 from the result

$$44.5 - 40 = 4.5^{\circ}\text{C}$$

Hence the temperature is **4.5°C**.

10.2.4 Input / Output Status

The Input/Output Status menu displays what devices (e.g. light, PC door, FC door, compressor, etc) are currently running or turned on.

To enter the menu, the steps are:

- 1a. Press and hold the **MODE** button (a short beep will sound).
- 1b. Whilst still holding the **MODE** button, briefly press the **TEMPERATURE UP** button (a short beep will sound). This enters diagnostic mode.
 - Steps 1a and 1b need to be completed within 8 seconds.
2. Press the **TEMPERATURE UP** button 3 times.
 - The respective LED turns on when a device is running, as shown below.

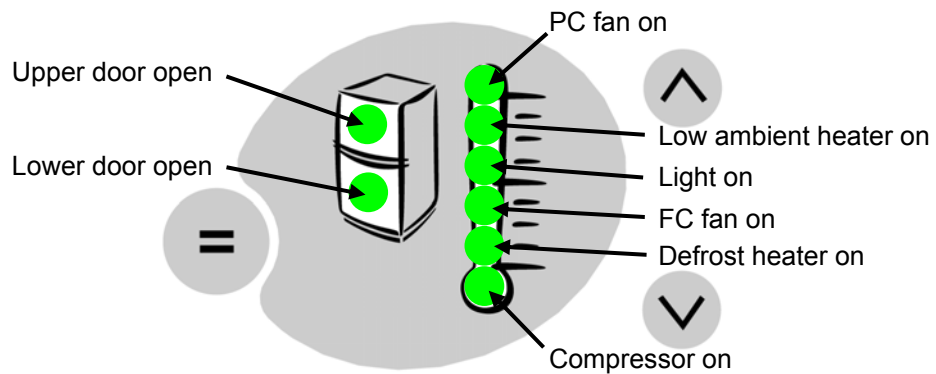

3. Return to normal operation by pressing the **MODE** button.

10.2.5 Data Download

To retrieve information from the power/control module, one of the following is required:

- A Light Pen (part number 425930) and a Cassiopeia Smart Tool.
- A Light Pen (part number 425930) and a laptop computer with the Fisher & Paykel Smart Tool diagnostic program loaded.

The steps to download data are:

- 1a. Press and hold the **MODE** button (a short beep will sound).
- 1b. Whilst still holding the **MODE** button, briefly press the **TEMPERATURE UP** button (a short beep will sound). This enters diagnostic mode.

Steps **1a** and **1b** need to be completed within 8 seconds.

2. Press the **TEMPERATURE DOWN** button once; this enters data download mode. A red LED turns on and should be visible on the display.

3. Place the Light Pen over the top of the red LED until downloading is complete.

4. Return to normal operation by pressing the **MODE** button.

If additional help or information is required, please refer to the instructions provided with the Smart Tool, or ask your Technical Representative.

10.2.6 To Manually Force A Defrost

To manually force a defrost, the steps are:

- 1a. Press and hold the **MODE** button (a short beep will sound).
- 1b. Whilst still holding the **MODE** button, briefly press the **TEMPERATURE DOWN** button (a long beep will sound).

Steps **1a** and **1b** need to be completed within 8 seconds.

- 1c. Repeat step **1b** and the cabinet will go directly into defrost mode. If the compressor is running, it will be heard to stop.

NOTE: If the **MODE** and **TEMPERATURE DOWN** buttons are pressed only once, the forced defrost will not occur when the compressor cycles off.

2. To check if the appliance is in defrost mode, repeat step **1a** and **1b**.

If a long beep sounds, then the defrost cycle has started.

3. To exit manual defrost mode, turn the refrigerator off at the power supply, and then while pressing the **MODE** button, switch the refrigerator on again at the power supply. If this is not done, the refrigerator will automatically exit from the manual defrost mode when the defrost is completed.

NOTE: The defrost cycle will not **start** if the defrost sensor is above +8°C (46°F) as this is the termination (or cut-out) temperature for the defrost.

The defrost cycle follows a predefined sequence. Refer to Section 4.3 for details of the defrost cycle.

10.2.7 Show Room Mode

Enter the diagnostic mode (press **MODE** and **TEMPERATURE UP** buttons together) then hold the **TEMPERATURE UP** button only for 3 seconds. The Show Room Mode will be entered, which turns off the normal system control leaving only the PC light operating with no door alarms. There will be a “long” beep and while the doors are opened the LED display will go through an attention grabbing sequence unless buttons are pressed, at which time the display will respond as normal. 8 seconds after the last button press the display sequence will continue. The interior light will switch off after 5 minutes and can only be re-activated by closing and opening the PC door. The mode may be exited by switching off the appliance at the power supply.

10.2.8 Special Option Mode (Israel)

The Active Smart® refrigerator is fitted with a special option mode, should the customer wish to disconnect the operation of the interior lights and the alarm.

To enter this mode the customer is required to have both the PC and FC doors open, and to push and hold the compartment select **MODE** button on the display board for 10 seconds.

When the cabinet is in this special option mode the following will not operate:

- The interior light will not turn on when the PC door is opened.
- There will be no set temperature lights (LEDs) displayed on the display module.
- The door alarm will be disconnected and will not sound even if the doors were to be left open.

NOTE: When in the special option mode, the PC icon will be illuminated, indicating that the appliance is in this mode.

The customer may exit this mode at anytime by pushing and holding the compartment select **MODE** button for 10 seconds. If not exited manually, the refrigerator will automatically exit this mode after 80 hours.

NOTE: When in the special option mode, the Active Smart® will operate as normal apart from the items mentioned above. In normal operation, the set temperature LEDs and interior light will be seen when the PC door is opened.

10.3 Problem Solving Checklist

Problem	Possible Causes	What to do.
Icemaker makes unfamiliar sounds or seems too loud.	Normal icemaker operation.	Refer to normal operating noises (Section 8.8).
Automatic Icemaker does not work	Icemaker has not been switched on.	Switch on icemaker.
	Bin is in the wrong way or no bin at all.	Place bin so scoop is on the right hand side. Ice bin sits directly under icemaker on top left hand side of freezer.
	Water supply turned off or not connected.	Connect to water supply or turn water on.
	Freezer compartment not working.	Icemaker will not operate if temperature of FC is above -10°C (14°F). Refer diagnostics and rectify.
	Water pressure too low.	Check water pressure.
	Water line/squashed.	Check water lines for kinks/ squashed.
	Fill tube heater faulty.	Check fill tube heater (refer to Section 11.1.10).
	Filter clogged.	Water filter may need replacing.
Ice cubes have odour /taste	Unsealed packages may be transmitting odour/taste.	Old cubes need to be discarded. Ensure food packaging is sealed.
	Interior of freezer needs cleaning.	Ice storage bin needs to be emptied and washed. Refrigerator requires cleaning.
	Poor taste from incoming water.	Filter may need changing. If no filter has been installed, filter may need to be installed.
Slow ice cube freezing	Door may have been left ajar.	Check door closing to identify any potential causes (gasket sticking, door closing hook).
	Freezer compartment too warm.	Check PC and FC settings. Check temperature of FC and download if required for any potential reasons for poor temperatures (e.g. excessive usage).
Water has poor taste/odour	Refrigerator not used for extended period.	Dispense 3 litres of water so fresh water supply is replenished.
Water dispenser does not work and/or icon flashing.	Water supply turned off or not connected.	Press dispenser for 2 minutes to remove trapped air from water line and to fill the water system.
	Supply line may be blocked. On first installation there may be air in the water system.	Check supply for kinks or leaks. To remove air, run a litre or a quart of water through the dispenser.
	Filter may be blocked and needs replacing.	Replace filter
	Dispenser lock activated.	Hold down the LOCK button for 2 seconds.
	Water frozen in tank.	Check the setting of the PC and FC and increase if necessary. Check download to review excessive usage and cycle of compressor.
Water in first glass is warm	Water dispenser not used for extended periods.	Allow 24 hours for water to cool to set temperature.
	Tank capacity used recently.	Allow water time to cool.
Filter warning icon is flashing	Filter needs replacing.	Replace filter as soon as possible.
Wet ice/ice clumping	Low water pressure.	Check pressure-reducing valve. Check for low pressure.
	Filter blocked.	Replace filter.

11 ICEMAKER & WATER DISPENSER SERVICE PROCEDURES

Safety Considerations

CAUTION
ALL TERMINALS AND INTERNAL PARTS SHOULD BE TREATED AS LIVE.

**ALL SERVICING SHOULD BE CARRIED OUT WITH THE REFRIGERATOR
 DISCONNECTED FROM THE POWER SUPPLY.**

11.1 Component Replacement

11.1.1 Icemaker PCB Replacement

- The icemaker PCB is fitted to the outside of the power/control module.
- Disconnect the refrigerator from the power supply.
- Remove the power/control module from the unit compartment.
- Using a flat bladed screwdriver, lever the PCB cover from the power/control module.
NOTE: Care should be taken, as too much pressure may cause the clip on the cover to break.
- Remove the RAST connector from the icemaker PCB and remove the PCB.
- Refit in reverse order.

11.1.2 Icemaker Unit Removal

- Disconnect the refrigerator from the power supply.
- Remove all baskets/trays from the freezer.
- Remove left hand side rail supports.
- Remove the clip and insulation pad holding the icemaker sensor to the bottom of the ice tray.
- Remove the sensor from under the icemaker tray.
- Place fingers at the rear of the icemaker and with a brisk downward motion pull the icemaker from the roof of the freezer.

NOTE: Both front and rear clips should have dislodged. If only the rear clip has dislodged, place fingers in the front of the icemaker and once again briskly pull the icemaker down.

- Disconnect the icemaker harness.

11.1.3 Refitting Icemaker

- Refit the sensor to the underneath of the icemaker tray.
- Refit the wiring connector.
- Place the harness into the groove on the edge of the body of the icemaker.
- Locate the clips and align the icemaker to the clips.
- With an upward pressure, re-clip the icemaker.

NOTE: If either front or rear clips do not re-clip, further pressure will need to be exercised to re-clip the icemaker.

11.1.4 Icemaker Temperature Sensor Replacement

- Remove the icemaker (refer to Section 11.1.2).
- The sensor wires are to be cut as close to the sensor as possible. Strip the wires back 10mm ($\frac{3}{8}$ inch) on the new sensor and on the wiring in the cabinet to allow the wires to be soldered or crimped together.
- Place heat shrink onto both wires of the sensor.
- Solder the wires, slide the heat shrink over the joints and heat the heat shrink.

11.1.5 Water Valve Replacement

- Ensure the water is turned off at the supply tap.
- Disconnect the refrigerator from the power supply.
- Pull the product away from the wall to access the rear of the product.
- To remove the water tube from the water valve, push the inner part of the clip inwards and hold down while pulling the tube from the valve. Drain the water (approximately 1½ litres) into a container.
- Remove the RAST connector from the water valve.
- Remove the two screws holding the valve to the back wall of the unit compartment.
- Refit in reverse order.

11.1.6 Display Module Replacement

The display module is located on the front of the door.
To remove the module:

Step 1

Disconnect the refrigerator from the power supply.

Push the tabs upwards and gently pull the panel forward once the tabs release.

A small screwdriver or key may need to be used to dislodge the tabs from the housing.

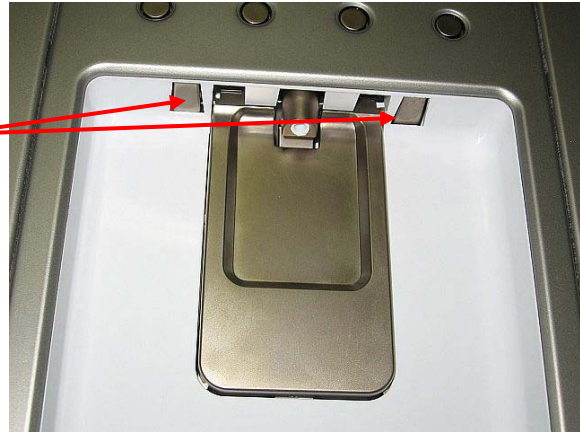

Step 2

Two locating pins on the base of the front panel hold the housing at the bottom.

NOTE: The housing cannot be removed, as wiring looms prevent its removal.

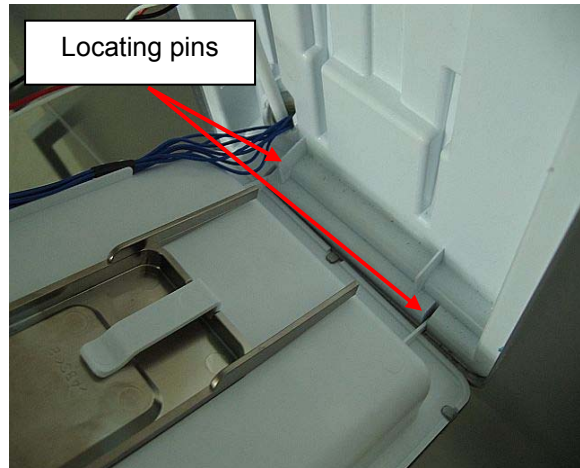

Step 3

Disconnect the RAST connectors from the module.

Pull the two bottom tabs forward.

Remove the module.

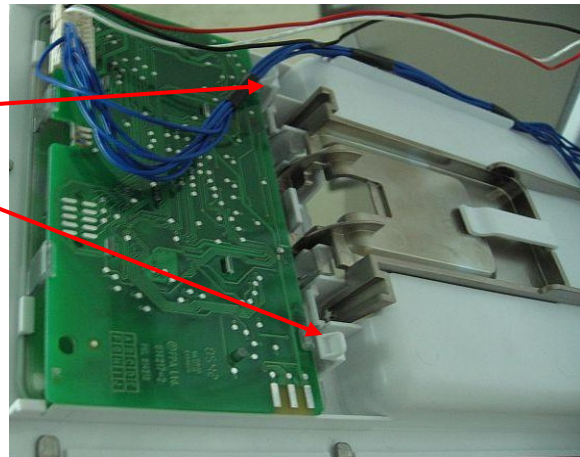

Step 4

Refit in reverse order.

Ensure the wiring is placed and clipped into the correct position.

Ensure the water hose is in the correct position prior to clipping the panel into position.

If necessary, replace the water hose between the door hinge and the dispenser.

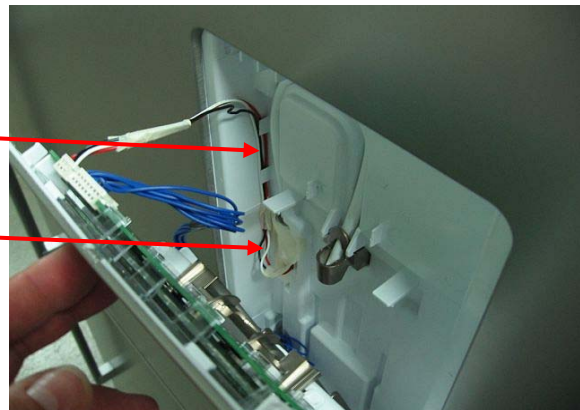

11.1.7 Water Dispenser Pad Replacement

Remove the display module (refer to Section 11.1.6).
To remove the pad, lift the sensor pad upward.

To refit the sensor pad, ensure the retaining clip is as shown.



11.1.8 Removing Water Tank

Located behind a cover above the PC duct cover.

- Turn the water off at the source.
- Remove all shelves.
- Remove the PC duct cover.
- Remove the PC sensor from the PC duct cover.
- Unclip the water reservoir cover from the cabinet liner.
- The reservoir is removed by sliding a flat bladed plastic putty knife or spatula on top of the tank, and with a folding motion of the spatula, lever the tank lip from the LH side to the RH side until the clip is lifted from the liner and the tank is removed.



Diagram A

Diagram A – tank in position.

Diagram B Fit a spatula on the RH side of the lip and move to the RH side until unclipped.



Diagram B

- Remove the water tubes from the tank.



Hoses are accessible once the tank is removed.

11.1.9 Refitting Water Tank

- Place the bottom section of the tank onto the protrusion on the PC liner (refer Diagrams C and D).



Diagram C



Diagram D

- Push the tank towards the rear of the liner until the top lip is clipped into position.
- Refit the cover (as per Diagram E).



Diagram E

- Fit the duct insulation and duct cover.
- Fit the PC sensor into the PC cover.
- Replace shelves and crisper.
- Turn the water on and flush out the system until all the air has been removed from the water tank

11.1.10 Replacing Icemaker Fill Tube Heater

Fault	Icemaker fill tube heater faulty.
Symptoms	Icemaker not going / no ice / fill tube frozen.
Checks	<p>Force a harvest using diagnostics mode (refer to Section 10.1.10). If tray will not flip / water will not enter ice moulds, this indicates a fault.</p> <p>Ensure icemaker is on before doing a product download. Smart Tool download (refer to Section 10.2.5) will indicate a fault code:</p> <ul style="list-style-type: none"> 42 = icemaker current high = short circuit. 43 = icemaker current low = open circuit. <p>Test the heater resistance at the power/control module terminal. (The heater is the pink wire plugged into "door heater" slot at the bottom of power/control module.) Resistance should be approx 120 Ohms. Open or short circuit indicates a fault.</p>
Explanations	<p>In French Door cabinets produced between 20th December 2011 and 20th March 2012, the power/control module had a fail safe feature built into the software should the Mk2 icemaker fill tube heater fail. This prevented the icemaker harvesting and calling for water should the fill tube heater go open circuit.</p> <p>On these cabinets, where the icemaker fails to harvest, check for an open circuit fill tube heater. Since 20th March 2012, this feature has been removed from the software. Spare parts power/control modules, if fitted, do not have this feature in the software.</p>
Actions	<p>Replace icemaker fill tube heater with spares kit, part number 821689P.</p> <p>This kit contains:</p> <ul style="list-style-type: none"> Replacement heater 3M Insulation Displacement Terminals Instruction sheet Stainless spring clip Aluminium foil tape
Tools Required	<ul style="list-style-type: none"> Screwdrivers Long-nosed pliers

Heater Replacement Instructions:

Step 1

Disconnect the refrigerator from the power supply.

Remove the icemaker assembly to expose ice spout (refer to Section 11.1.2).

The icemaker heater can just be seen beneath the spout (arrowed).



Step 2

Using long-nosed pliers, grip the end of the heater and pull forwards. The heater is taped to the spout, so may require a little force before it will come loose.



Step 3

Pull the heater out of its pocket to expose the pink harness. There is surplus harness.



Step 4

Cut the faulty heater from the harness, but make sure to allow sufficient wire on the cabinet side to splice in the new heater.

Check the resistance of the heater to ensure this is the faulty part, not the harness.



Step 5

Use two of the 3M Insulation Displacement terminals to splice the replacement heater onto the harness. There is no polarity to check.

Ensure that the wires are fully inserted into the terminals before squeezing the connection closed.

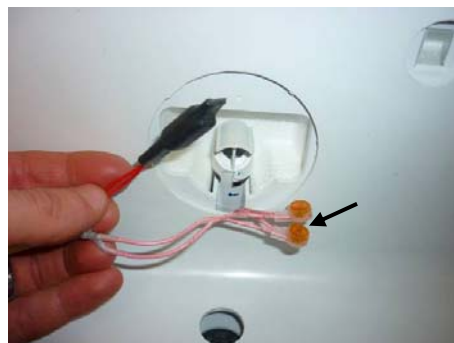

321144

Step 6

Insert the heater back into the pocket with the wires sticking out backwards.

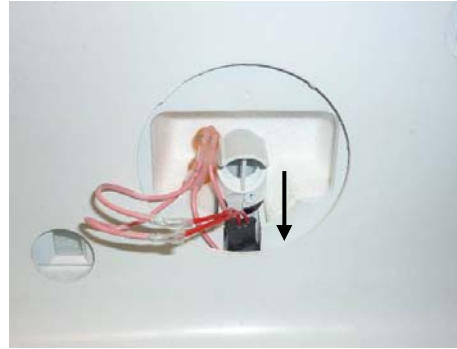

Step 7

Insert the stainless spring clip under the heater to ensure contact between the heater and the ice tube. The bottom loop clips onto the liner plastic, leaving the double fold above it.

Loop the wires and connectors around the spout.

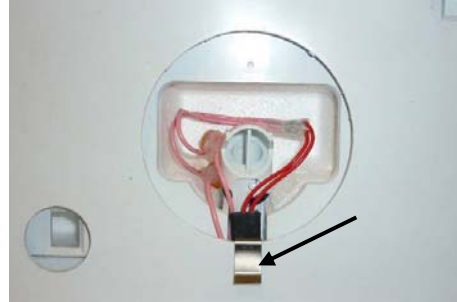

Step 8

Ensure the wires are well clear of the water outlet around the spout. **Tape the wires against plastic surfaces in the spout recess to ensure they cannot fall into the path of the water.** This is important to ensure there is no water splashing, icing up, or ice cube tainting.

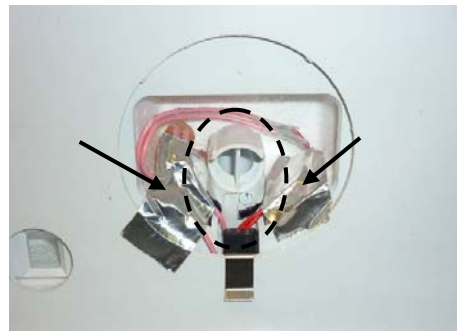

Side view of the finished repair.

Step 9

Check the heater resistance at the module connection to ensure the heater has been successfully repaired.

The icemaker assembly can now be reassembled and the power restored. Check the icemaker operates as normal by forcing a harvest (refer to Section 10.1.10).



11.1.11 Replacing PC Door On Ice & Water Models

11.1.11.1 Designer Doors

- Turn the power off to the refrigerator.
- Turn off the water (if connected).
- Remove the display module and unclip the harness from the display (refer to Section 11.1.6).
- Disconnect the water tube from the check valve.



- With the door in the open position, remove the hinge cover.

NOTE: Removing the hinge cover will allow a screwdriver to be used to remove the hinge cover trim without damaging the hinge cover.



- With a flat bladed screwdriver, and using the hinge bracket as a lever, gently lever the centre of the hinge cover trim upwards, ensuring that it is raised evenly.



- Lift the hinge cover trim from the door.



- Close the door.
- Unplug the wiring harness edge connector and remove the three hinge bracket mounting screws.
- Rotate the hinge bracket and lift clear.
- Unclip the water tube and harness from the guide assembly, noting its layout for refitting.



321144

- Remove the harness guide arm from the door.

NOTE: The guide arm is locked into the door hinge bush by means of a key on the arm itself. The door hinge bush can be removed by removing the single screw that holds it to the door cap.



- Withdraw the tube from the door conduit.
- Fit the harness to the bullet supplied with the replacement door and tape the harness to the bullet.

NOTE: This is required to pull the harness through the conduit.



- Ease the bullet into the conduit and draw the harness out of the door.



Once the harness is removed from the door, the door can be removed from the cabinet.

- Using the bullet as mentioned above, place the RAST connector and hose as shown.

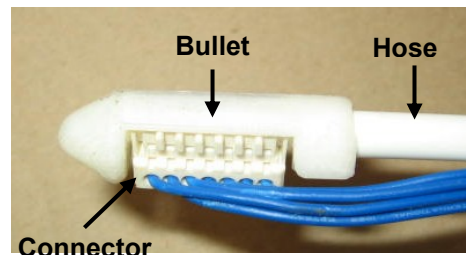

- Feed the harness and hose through the door conduit.

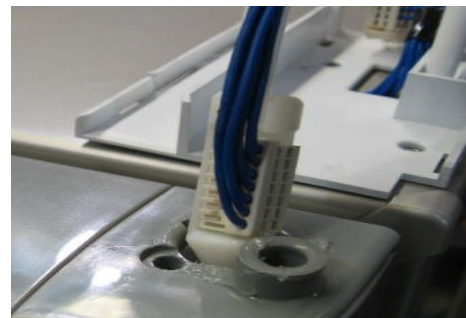

- Transfer the check valve, together with the tube from the check valve to the dispenser nozzle, to the new door.
- Reconnect the hose at the check valve. This valve maintains a positive pressure in the water tank and water discharge system.

NOTE: The hose may need to be trimmed on the end to prevent leaks.

Ensure that the hose is clipped into position correctly.



- Refit the LCD housing, ensuring that the wiring harness is firmly in place and is not preventing the housing from closing.



- Refit the hinge bush and guide arm.
NOTE: The tape mark on the bottom of harness guide arm gives the correct amount of wire length under the hinge cover to couple to the edge connector. The lay of the harness in relationship to the water tube is important to prevent fatigue of the wiring harness. The wiring harness should have the same loop length as the water tube and sit underneath the tube.
- Refit the hinge bracket and the wiring harness edge connector.
- Check that the door is even and sealing correctly all around.
- Refit the water tube and harness to the guide assembly.
- Refit the cabinet hinge cover.
- Refit the hinge cover trim to the top of the door as shown, applying even pressure to the clips when re-assembling otherwise they may break.



11.1.11.2 Classic Doors

- Turn the power off to the refrigerator.
- Turn off the water (if connected).
- Remove the hinge cover.
- Disconnect the RAST connector.
- Remove the top hinge bracket.

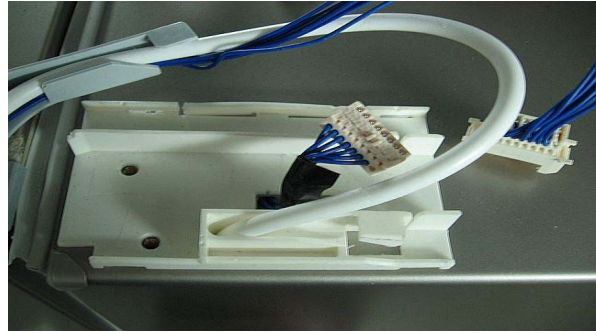
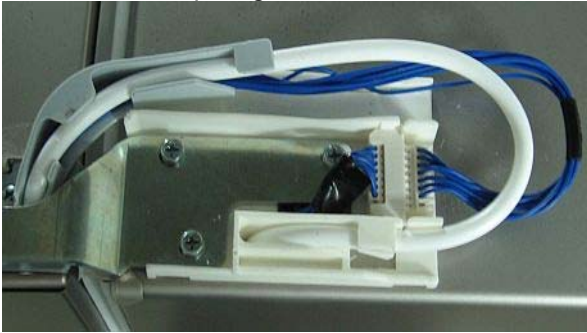

- Remove the screw from the door.
- Remove the hose and wiring harness from the guide.



- Turn the guide 90 degrees to the door and lift to remove it from the door.



- Remove the hose from the door conduit.



- Fit the harness to the bullet supplied with the replacement door and tape the harness to the bullet.

NOTE: This is required to pull the harness through the conduit.



- Ease the bullet into the conduit and draw the harness out of the door.



- Once the harness is removed from the door, the door can be removed from the cabinet.
- Fit the new door to the cabinet.
- From the harness RAST connector, measure 300 mm (11¾ inches) and place a mark on the harness.

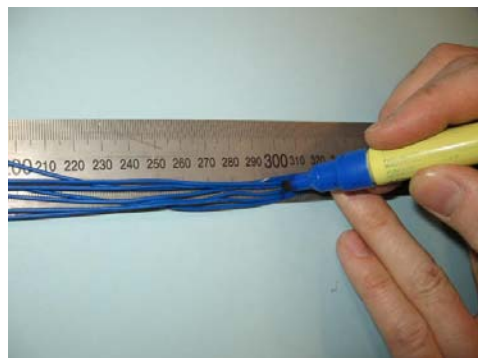

- The mark on the harness is to be placed in the middle of the guide.

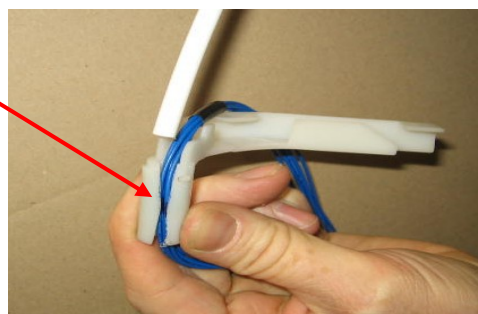

- Push the hose through the guide until the hose equals the same length of the harness.
- NOTE:** By connecting the harness, it makes the measuring easier.



- Using the bullet, place the RAST connector and hose as shown.

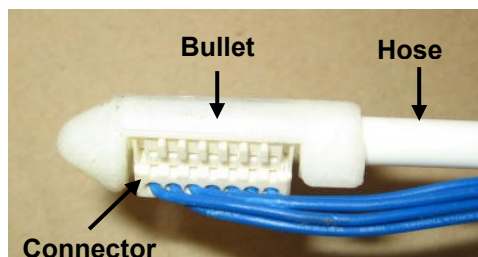

321144

- Feed the harness and hose through the door conduit.

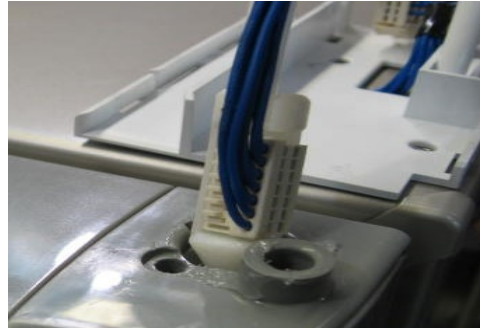

- Reconnect the hose at the dispenser nozzle.

NOTE: The hose may need to be trimmed on the end to prevent leaks.

Ensure that the hose is clipped into position correctly.

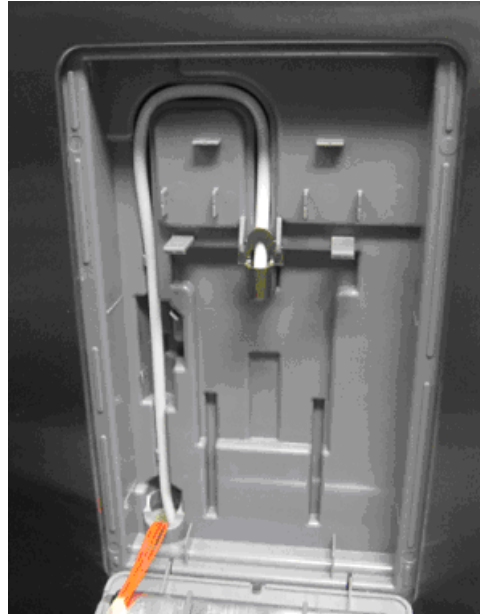

- Refit the LCD housing, ensuring that the wiring harness is firmly in place and is not preventing the housing from closing.



- Refit the guide to the door, ensuring that the key on the guide lines up with the key-way in the door.

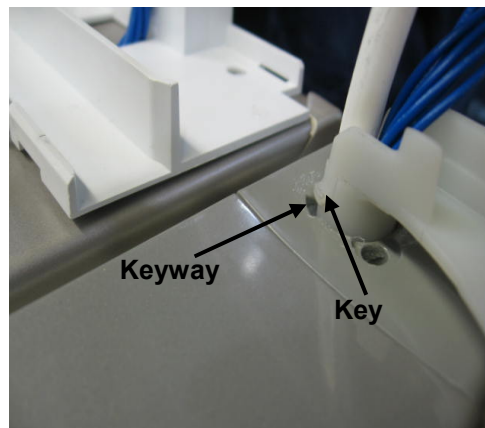
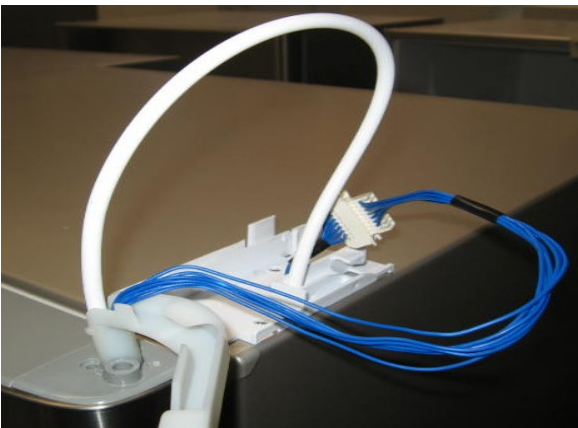

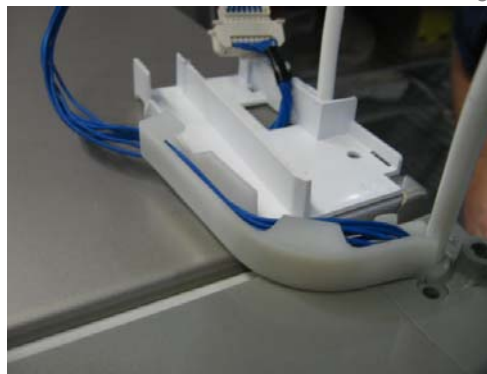

- Refit the hinge bracket.
- Check that the door is even and sealing correctly all around.
- Reconnect the RAST connector.
- Refit the hinge cover.



NOTE: If the original water tube is to be refitted, check the end of the tube for any damage, and if the tube has small pieces of plastic protruding, cut 6 to 10 mm ($\frac{1}{4}$ to $\frac{3}{8}$ inch) of tube from the end. This should be carried out with a sharp bladed knife.

12 SERVICING PROCEDURES

12.1 Safety Considerations

CAUTION

ALL TERMINALS AND INTERNAL PARTS SHOULD BE
TREATED AS LIVE.

ALL SERVICING SHOULD BE CARRIED OUT WITH THE REFRIGERATOR
DISCONNECTED FROM THE POWER SUPPLY.

Before servicing this appliance, your body should be at the same voltage potential. **An antistatic wrist strap must be used when handling electronic components.**

Printed circuit boards removed from the refrigerator for return to Fisher & Paykel must be protected from possible electrostatic damage (ESD) while in transit by the use of the specialised packaging in which the replacement was received.

ELECTROSTATIC DISCHARGE SENSITIVE DEVICES



CAUTION
ELECTROSTATIC
SENSITIVE DEVICES
OBSERVE HANDLING
PRECAUTIONS

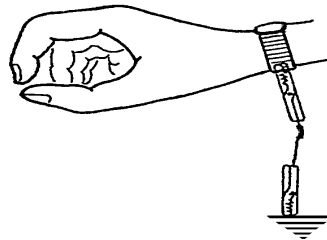

GROUNDED
TO EARTH

Diagram 12.1

12.2 Electrical Safety Test

Whenever any part of the electrical circuit is serviced or disturbed in the course of carrying out service adjustments or procedures, it is essential that an insulation and earth continuity test be carried out using a two-scale megger. This is to be done with the appliance disconnected from power.

Insulation:	At least 1 megohm
Earth Continuity:	No greater than 0.5 ohm

NOTE: Electronic printed circuit boards can be damaged if meggered incorrectly as phase / earth or neutral / earth.

Therefore to carry out an insulation megger test where the appliance is fitted with a electronic printed circuit board, short out both the phase and neutral conductors together at the 3 pin plug with one test lead of the megger. Connect the other lead of the megger to the earth / cabinet of the refrigerator under test.

Earth continuity can be measured between the earth pin on the 3-pin plug and the cabinet of the refrigerator.

12.3 Doors and Door Gaskets

Integrally foamed doors with the outer door panel and inner door liner foamed as one unit are becoming more common for manufacturers. This means that only the door gasket can be replaced as a separate part.

All replacement doors are supplied minus the door gasket. The door gasket is a replaceable part of the door. It is held in place against the door liner by means of a moulding that locks the gasket in place once pushed into it. There are no screws or retainers to remove or fit.

To Remove the Gasket

Pull on any section of the gasket to pull it away from the moulding.

To Replace the Gasket

Having removed the old gasket, lay the new gasket around the door gasket moulding. First fit all corners, then push the remaining gasket into place around the door.

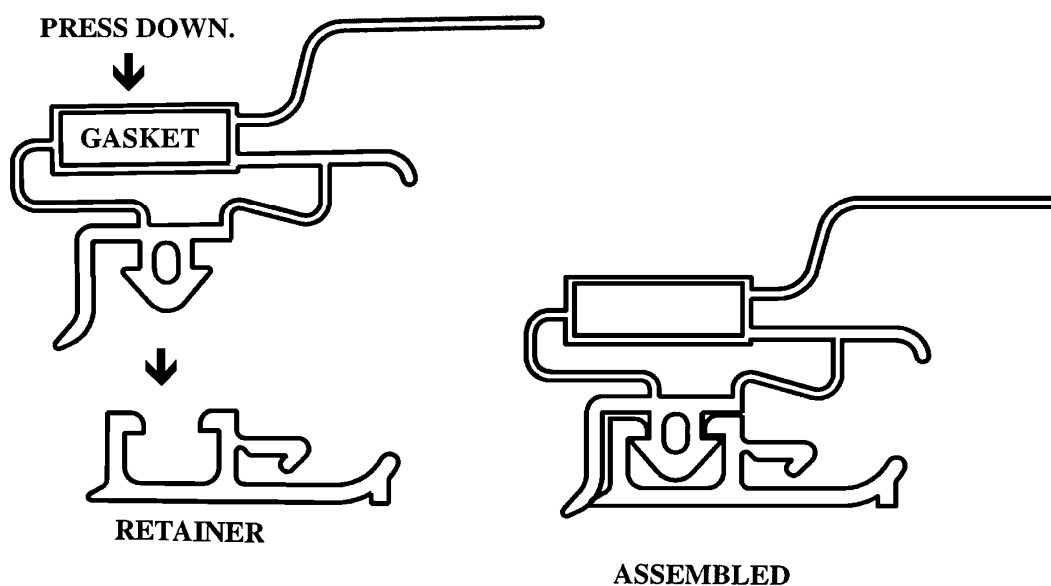

Diagram 12.3

12.4 Removal Of Power/Control Module

Located in the unit compartment on the right hand side and held in place by 2 self-tapping screws.

1. Disconnect the refrigerator from the power supply.
2. Remove both the mounting screws and the earth screw (on the green / yellow earth wire) on the compressor mounting tray.
3. Pull the power/control module outwards to disengage the mounting lugs at the back of the module.
4. Remove all connectors along the top edge of the power/control module.
5. Remove the defrost connector (brown wires) and H-rail heater connector (if fitted, purple wires) from the connector area on the side.
6. Remove the compressor connector (4 way connector) and gently pull the compressor cable from the cable retention clips.
7. Refit in reverse order.

NOTE: It is important that the power/control module is clipped securely to the side of the unit compartment and the copper earth spring clip is not damaged, as this maintains good earthing and provides a low inductance path to the chassis for RF voltage. Check that the flat pins at the back of the module are properly engaged with the lugs on the unit compartment when refitting.

12.4.1 Initialisation Of The Power/Control Module After Installation – Non-Ice & Water Models

The power/control module needs to know whether it is fitted into a “B” or “T” model upon installation because it needs to turn on the interior light, and to identify the PC and FC compartments for the selected temperature settings.

To initialise, the serviceperson must have the FC door closed, the PC door open and then press any of the buttons on the user interface in the PC. This will initialise the module for the cabinet it is fitted into. Until then, the interior light may not turn on, indicating that the power/control module has not been initialised.

If the power/control module is moved from one cabinet to another and the model option is wrong, the PC light will turn on only when the FC door is opened. Initialise the power/control module as described in the previous paragraph.

If the power/control module is not initialised, as may be the situation for a new service module, the lights will not turn on. If the operator presses a button with both doors opened, the illegal *raspberry* audible feedback will sound, indicating that the module is unable to be initialised. The service installation document, which is included with the new service module, will give instructions on the initialisation of the module.

12.5 Freezer Bin, Runner and Air Deflector Removal - E402B and E372B Models

1. Disconnect the refrigerator from the power supply.
2. Remove the top shelf by lifting the rear of the shelf to release it from its locked position and slide the shelf forward.
3. Remove the limit stops from the top rear edge of the plastic bins and slide the bins out of the runners.
4. The runners must be in the fully retracted position. Twist and rotate the inner runner upwards to release it from the outer runner.
5. Pull the inner runner forward, sliding out of the outer runner to remove.
6. To remove the outer runner, gently lever out the small lock clip with a small screwdriver.
7. Carefully slide the runner out of the FC liner.
8. Remove the air deflector by pushing in towards the centre to bow the deflector slightly. This will cause the clip legs to disengage from the front cover and allow the deflector to be removed.
9. Refit in reverse order.

12.6 FC Bin Removal - 900 Models

1. Open the FC drawer and remove all ice and storage bins.
2. Remove the safety clip from the tray. (Refer photo 12.6)

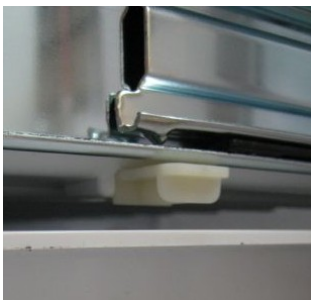

Remove safety clip from slide to remove tray.

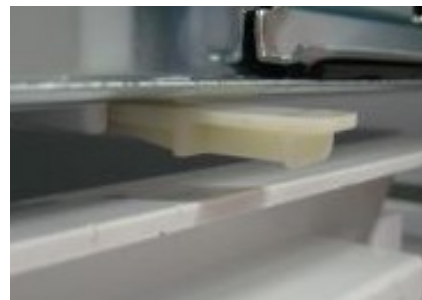

Photo 12.6

3. Remove the tray.
4. To remove the bin, pull it back towards the freezer.
5. Lift the front of the bin and turn the bin 90° and remove from the FC.
6. Refit the bins in reverse order.

12.7 FC Drawer Removal - 900 Models

1. Remove all Ice and Storage Bins as in Section 12.6.
2. Push the locking tab on each of the FC bracket mount slides as shown in Photo 12.7
3. Once the tabs have been released, the FC drawer can be lifted up.
4. Locating tabs on the bracket mount slides need to be removed out of the slide to remove the FC drawer.

Note: The anti-wracking device comes out with the drawer.



Push Locking Tab in to release bracket from slide.

Photo 12.7



Locking Tab

12.7.1 Refitting Of The FC Drawer

1. There are two locating tabs on the drawer that are required to be fitted first. (Refer Photo 12.7.1)

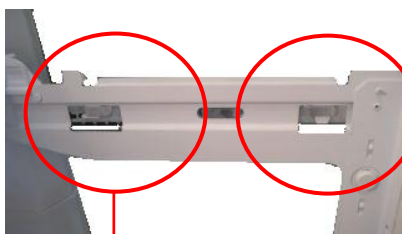

Step 1



Step 2

Photo 12.7.1

2. Align the rear locating tab into the slot as shown in step 1.
3. Align the front locating tab into the slot as shown in step 2.
4. Fit the anti-wracking bar into the wracking pinion gear ready to fit to the drawer.
5. Both anti-wracking pinion gears need to be fitted simultaneously. (If this is not achieved, damage to the gearing may occur or the drawer will not close correctly.) Refer Photo 12.7.1.1.



Photo 12.7.1.1



Photo 12.7.1.2

6. Place the anti-wracking pinion on an angle and slide both pinion gears into position on the slide.
7. Fit the locking tab into position as shown in Photo 12.7.1.2

12.8 PC Fan Motor - "T" Models

1. Disconnect the refrigerator from the power supply.
2. Remove all PC shelving.
3. Remove the bottom PC air duct cover.
4. Remove the polystyrene duct cover insulation.
5. Disconnect the low ambient heater.
6. Remove 1 screw from the top duct cover and unclip.
7. Unplug the PC fan motor plug.
8. Withdraw the fan downwards.
9. Refit in reverse order.

NOTE: When refitting the PC fan motor, ensure there is a loop in the wiring harness between the fan motor and its housing.



12.9 PC Fan Motor - "B" Models

1. Disconnect the refrigerator from the power supply.
2. Remove all PC shelving.
3. Remove the duct grill in the PC.
4. Remove the PC duct cover and polystyrene insulation.
5. Using 2 fingers, withdraw the fan motor upwards. It is mounted horizontally in the divider partition.
6. With the motor out, this will expose a small multi plug and socket connection to the fan motor and wiring harness. Unplug.
7. To refit back together, fit the wiring harness multi plug first into the pocket of the divider partition.
8. Using your 2 fingers, slip the motor back into the divider partition to fit horizontally.
9. Refit the duct covers and test.

NOTE: The back of the fan motor faces upwards.

12.10 Defrost Element Replacement

1. Disconnect the refrigerator from the power supply.
2. Remove all the bins from the freezer and remove the FC drawer (900 Models).
3. Remove the FC cover by removing two screws. Removal of the icemaker will make removal of the FC cover easier (Ice & Water models). (Refer Removing Icemaker, Section 11.1.2.)
4. Remove the fan grille cover. This unclips with the aid of a small screwdriver.
5. Unplug the fan motor and remove the FC sensor.
6. Lift the evaporator upwards to clear the bottom of the liner drain and pull the bottom edge of the evaporator forward.
7. Remove the cable ties from the thermal fuses.
8. Disconnect the element from the connector.
9. Remove the end deflectors from both ends of the evaporator.
10. Using long nose pliers, bend the aluminium tabs to remove the defrost element.
11. Remove the thermal fuses from the air deflectors.
12. Refit the element in reverse order.

12.11 Thermal Fuse

This is part of the element assembly and is to be replaced as part of the defrost heater element assembly. Having a trip temperature of 72° C (161°F), they are not resettable.

12.12 Cross / Base Rail Door Switches

1. Disconnect the refrigerator from the power supply.
2. Remove the door switch cover (located in the centre of the cross and base rails).
3. Unclip the encapsulated reed switch from the housing.
4. Replacement of the switch is done by cutting the old switch from the wiring and soldering in a new switch, making sure both connecting wires are not shorting but are insulated with heat shrink sleeving. Take care not to leave too much excess wire, as the reed switch must be able to be fitted back in to the housing.
5. Refit in reverse order.

12.13 Removal Of Display Module – Non-Ice & Water Models

1. Disconnect the refrigerator from the power supply.
2. Remove all PC shelving.
3. Remove the bottom PC air duct cover.
4. Remove the polystyrene duct cover insulation.
5. Disconnect the low ambient heater – “T” model only.
6. Remove 1 screw from the top duct cover and unclip – “T” model only.
7. Compress the clips on the display module and release it from the duct cover.
8. Remove the PC sensor from its location.
9. Unplug the 5 and 3 way edge connectors from the display module.

12.14 PC Sensor Replacement

1. Disconnect the refrigerator from the power supply.
2. Remove all PC shelving.
3. Remove the bottom PC air duct cover.
4. Remove the polystyrene duct cover insulation.
5. Disconnect the low ambient heater - “T” model only.
6. Remove 1 screw from the top duct cover and unclip - “T” model only.
7. Remove the PC sensor from its location.
8. Replacement of the new sensor is done by cutting the wiring back from the sensor end and soldering in a new sensor, making sure both connecting wires are not shorting, but are insulated with heat shrink sleeving.
9. Refit in reverse order.

12.15 FC Sensor Replacement- “T” and “B” Models

1. Disconnect the refrigerator from the power supply.
2. Prise out the fan shroud using a flat blade screwdriver at the bottom of the grill cover.
3. Unclip the FC fan motor.
4. Remove the FC fan motor plug connection.
5. Unclip the FC sensor and remove the evaporator coil cover.
6. Replacement of the new sensor is done by cutting the wiring back from the sensor end and soldering in a new sensor, making sure both connecting wires are not shorting, but are insulated with heat shrink sleeving.
7. Refit in reverse order.

12.16 FC Sensor Replacement - 900 Models

1. Disconnect the refrigerator from the power supply.
2. Remove all bins/trays from the freezer and remove the FC drawer.
3. Remove the FC cover by removing two screws. Removal of the icemaker will make removal of the FC cover easier. (Refer Removing Icemaker, Section 11.1.2.)
5. Remove the fan grille cover. This unclips with the aid of a small screwdriver.
6. Move the FC cover to access the FC sensor. (Removal of the FC cover is not necessary.)
7. Cut the FC sensor as close as possible to the sensor.
8. Replacement of the new sensor is done by cutting the wire off the new sensor about 60mm (2¼ inches) from the sensor, stripping the wire back about 10mm ($\frac{3}{8}$ inch), stripping the old sensor wiring back about 10mm ($\frac{3}{8}$ inch), and soldering the new sensor to the old wiring, making sure both connecting wires are not shorting but are insulated with heat shrink sleeving.
9. Refit in reverse order.

12.17 Icemaker Temperature Sensor Replacement

1. Remove the icemaker (refer to Section 11.1.2).
2. The sensor wires are to be cut as close to the sensor as possible. Strip the wires back 10mm ($\frac{3}{8}$ inch) on the new sensor and on the wiring in the cabinet to allow the wires to be soldered together.
3. Place heat shrink onto both wires of the sensor.
4. Solder the wires, slide the heat shrink over the joints and heat the heat shrink.

12.18 Replacement Of Low Ambient Heater - "T" Model

1. Disconnect the refrigerator from the power supply.
2. Remove all PC shelving.
3. Remove the bottom PC air duct cover.
4. Remove the polystyrene duct cover insulation.
5. Disconnect the low ambient heater.
6. Refit in reverse manner.

12.19 Replacement Of Low Ambient Heater - "B" Models

This element is mounted in the floor of the divider and is not replaceable. If it should be found to be open circuit, a replacement low ambient heater can be fitted to the air duct cover.

Should a failure occur, replace the heater with the following part: -

- Part Number: 883371 – Low Ambient Heater

The replacement heater should be attached to the air duct cover as shown in the diagram below and connected to the harness plug along side the PC fan harness socket.

NOTE: Even though the element may not be used in high ambient areas, the electronics check to see that it is in circuit every time it cycles the compressor, so it cannot be left disconnected.



Fitting the Low Ambient Heater (LAH)

The Low Ambient Heater is to be fitted horizontally onto the PC Duct Cover.

1. Disconnect the refrigerator from the power supply.
2. Remove all PC shelving and crisper bins.
3. Remove the PC duct cover.
4. Disconnect the old LAH and cut the connector off the heater section of the harness.
5. Remove the paper backing off the replacement heater and place the heater 150mm (6 inches) from the base of the PC duct cover as shown on left.
6. Connect the new LAH to the plug socket that the old one was connected to.
7. Refit the duct cover; ensuring the wiring is not caught in the cover.
8. Refit the shelving and crisper bins.

12.20 Replacement Of Low Ambient Heater - "B" Model (In Return Grill)

This element is mounted in the return grill of the divider. It is of the blanket wire type on an aluminium tape stuck to the grill itself.

1. Disconnect the refrigerator from the power supply.
2. Remove all the PC shelving and crisper bins.
3. Remove the PC duct cover.
4. Remove the PC air return grill and unplug the element from the harness.
5. Peel off the old element and replace with the new.
6. Refit the return air grill and duct cover, ensuring the wiring is not caught in the cover.
7. Refit the shelving and crisper bins.

12.21 Interior LED Light Replacement

1. Disconnect the refrigerator from the power supply.
2. Remove the light cover. (This can be done by using a small screwdriver and levering the cover off the front clips.)
3. The faulty LED PCB is removed by pulling the PCB out of the socket and disconnecting the edge connector.
4. Connect the edge connector to the new LED PCB.
5. Push the LED PCB into position with the components facing downward.
NOTE: The PCB will not operate if fitted upside down.
6. Reconnect the refrigerator to the power supply.
7. Ensure that the light operates, then refit the light cover.

12.22 Flapper Element Replacement

1. Disconnect the refrigerator from the power supply.
2. Open the left hand PC door to expose the flapper.
3. Remove the flapper spring. Refer Photo 12.22.1.
 - a. Using a pair of long nose pliers, remove the top part of the spring from flapper.
 - b. Once removed, the spring can be left in position.



Photo 12.22.1

4. Remove the bottom end cap off the flapper. Refer Photo 12.22.2

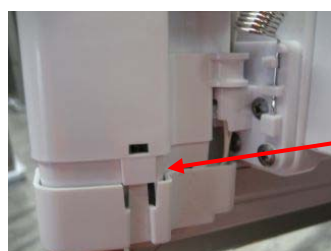

Locking clips are to be pushed in to remove cap.

Photo 12.22.2

5. Remove the top screws holding the top flapper hinge to the door liner. Refer Photo 12.22.3



Second screw located in front of hinge.

Photo 12.22.3

6. Remove the flapper off the bottom hinge and turn over to expose the bottom of the flapper.
7. Slide the element forward. Note: The element is taped onto the steel insert and may offer some resistance. Care should be taken not to damage the insert or the product. Refer Photo 12.22.4

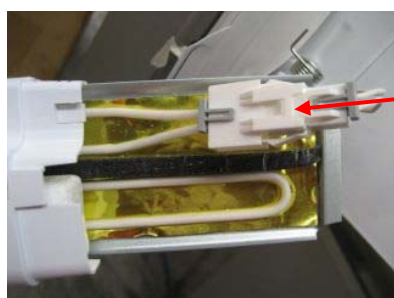

Pull element enough to expose JST connector.

Photo 12.22.4

8. Disconnect the JST connector and remove the entire element.
9. Replacement and re-fitment of the element is in reverse order. **Cautionary NOTE:** Ensure the element wiring is routed and/or is not under tension as it may cause early failure of the element. Refer Photo 12.22.5

321144



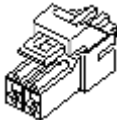

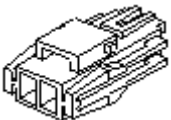

Photo 12.22.5

12.23 Block/Edge Connectors

Should a connector need replacement, it is important that the wiring connections be kept in the correct order to the connector. The wiring harness uses one colour of wire throughout all circuits. The circuit wiring should be traced with the aid of a multimeter before a connection is made.

When wiring any DC voltage supply or components, it is important that the correct polarity be observed.

The following diagrams show all these connectors and their Fisher & Paykel part numbers.

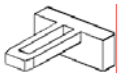
JST PLUGS AND SOCKETS			
	TYPE	DESCRIPTION	PART NUMBER
	JST PLUG 2 PIN 4 PIN 6 PIN 8 PIN	YLP-02V YLP-04V YLP-06V YLP-08V	819611 819612 819613 819614
	JST PIN TERMINAL (Fits the plug above)	SYM-01T-P0.5A (26/20 AWG) SYM-41T-P0.5A (20/16 AWG) (There are two sizes of terminals to suit the wire gauges)	819609P 819610P (Sold as packet of 10)
	JST SOCKET 2 PIN 3 PIN 4 PIN 6 PIN 8 PIN	YLR-02V YLR-03V YLR-04V YLR-06V YLR-08V	819615 819616 819617 819618 819619
	JST SOCKET TERMINAL (Fits the socket above)	SYF-01T-PO.5A (26/20 AWG) SYF-41T-PO.5A (20/16 AWG) (There are two sizes of terminals to suit the wire gauges)	819607P 819608P (Sold as packet of 10)
	RETAINER 2 WAY 3 WAY (Common to both plugs and sockets)	YLS-02V YLS-02V	819620 819621

To make a connection on an edge connector, cut the wire end square and insert it into the correct location on the edge connector itself. With the wire fully inserted, apply pressure to the terminal, which will lock the wire and terminal together.

If possible, when replacing a connector the connections should be made one at a time. For example, first cut the wire in pin 1 of the old connector and insert it into pin 1 on of the new connector. Push the pin fully home to lock the wire in place, and then move on to pin 2.

Note that these connectors contain a wall between the cavities to 'code' or polarize the connector. This is especially important in the case of the 4 and 6 way connectors in the power/control module. Also note that the replacement connectors are un-coded (to reduce the number of spare parts required) and therefore care must be taken that the connector is replaced in the correct socket. Check the wiring diagram and labelling on the power/control module if unsure.

STOCKO EDGE CONNECTORS

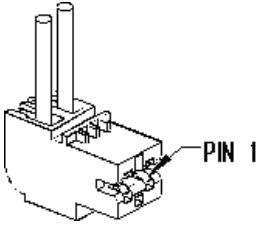
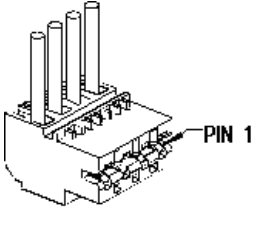
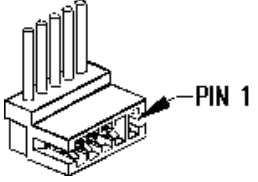
	TYPE	DESCRIPTION	PART NUMBER
	EDGE CONNECTOR (Mains Cord) (Defrost Heater) (Run Capacitor)	9290-02-AB01-000-960 9290-02-BA01-000-960 9290-02-EE01-000-960 NOTE 1	881588 881599 881600
	EDGE CONNECTOR (Compressor Cable)	9290-04-EF02-000-960	881591
	EDGE CONNECTOR (New edge connector series with internal coding – note the wall.) 3 WAY 5 WAY 6 WAY	7234-003-500-450 7234-005-500-450 7234-006-500-450 NOTE 2	873251 881135 873247

NOTE 1: In the part names of these connectors, the -02- refers to it being a 2 way connector, and the -AB01- (for example) refers to the coding of the connector.

NOTE 2: To minimize the number of spare parts that need to be carried, these new edge connectors with internal coding can be replaced with their un-coded equivalents, the part numbers of which are shown above. In the part names of these connectors, the -003- refers to it being a 3 way connector (for example).

12.24 Fan Cover Removal Tool (T Models Only)

The following illustration shows a tool that can be made in your workshop. This tool can be used to release and remove the freezer compartment fan cover in the Active Smart® “T” model refrigerators. If preferable, the tool can be made from a screwdriver with a shaft length of approximately 200mm (8 inches) long and 4.5 mm ($\frac{3}{16}$ inch) diameter.

B models are removed by grasping the bottom of the evaporator cover and pulling up and forward.

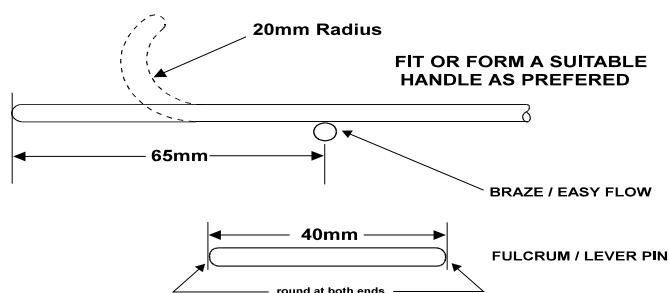
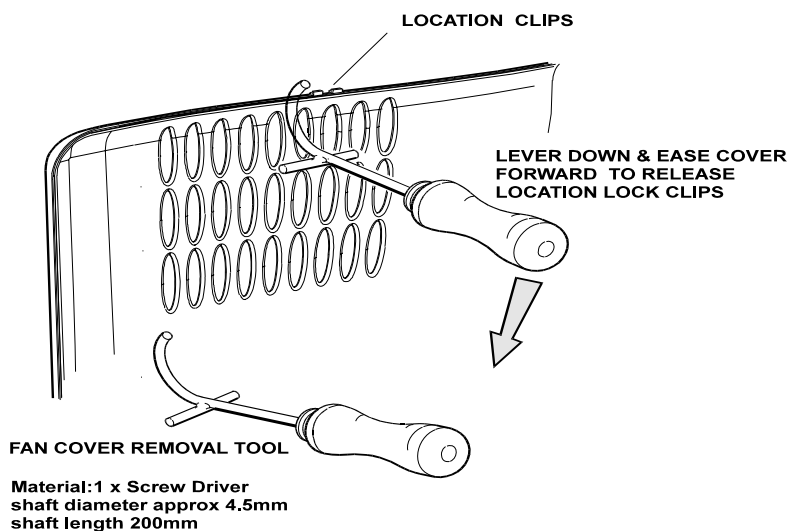

Diagram 12.24

12.25 Active Smart® PC/FC Fan Motor Tester

Testing a PC or FC fan motor with a multi meter is not possible, due to the electronics contained within the motor. The simple way to test a fan motor is to apply a DC voltage with a 9-volt battery.

Parts required are:

Component	Qty	Part Number
JST Plug 2 Pin	1	819611
JST Pin Terminal	2	819610
A 9-volt battery terminal connector obtainable from any electronic goods supply store.		
A 9-volt battery		

NOTE: When wiring the plugs, ensure that the polarity is correct, as the motors will not run if the polarity is reversed.

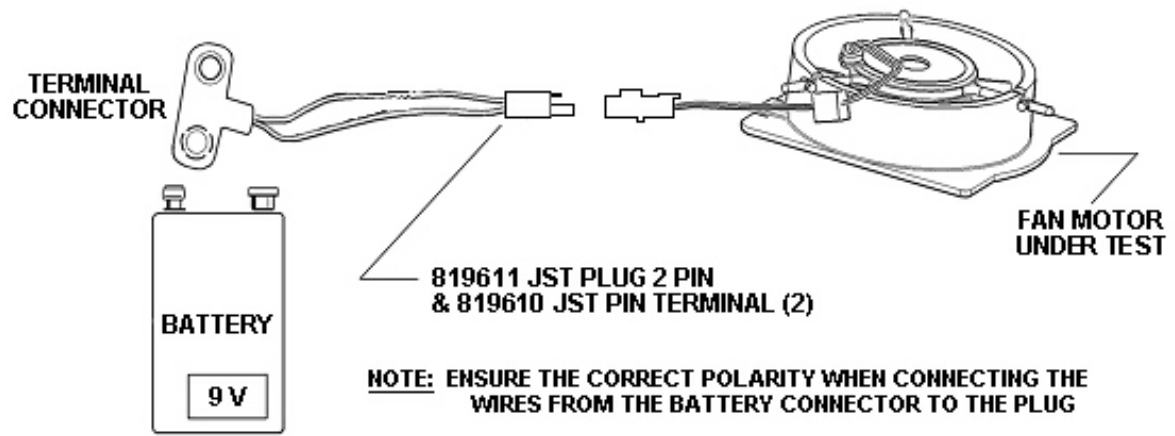

Diagram 12.25

13 WORKING ON THE SEALED SYSTEM

13.1 Safe Work Practices

Safe work practices cannot be overstated. If your work practices are not to a safe standard, you may cause damage not only to your customer's property, but also to yourself.

It is important that on all refrigeration systems being serviced, the type of refrigerant is identified before work commences. The serial plate will indicate the gas type and so will the label on the compressor.



Do **NOT** charge flammable refrigerants into refrigerators designed to operate on R12 or R134a.

If the system contains R600a refrigerant:

- Don't work on the appliance in a confined space. Always work in a well-ventilated area.
- Don't use mechanical devices to speed up the defrosting process.
- Don't use electrical tools (e.g. battery drill) that could be a source of ignition inside the appliance in case the appliance should have a gas leak.
- Always purge the system with Dry Nitrogen prior to lighting a gas torch.

13.2 Leak Detection

There are special leak detectors available for R600a. Don't use your old leak detector that you have for R12 / R134a with the R600a system unless it specifies that it can be used for R600a.

Leak detection fluid and a small paintbrush works well.

13.3 R600a Operating Pressures

The working pressures are a lot lower than what we have seen with R12 and R134a systems.

- The high side 600Kpa / 90PSI @ 32°C
 350Kpa / 50PSI @ 18°C
- The low side -50Kpa / -14.8 inches vacuum @ 32°C
 -30Kpa / -9 inches vacuum @ 18°C

13.4 Reclaiming

If venting R600a out of a system that is being worked on, there is no legal requirement to reclaim it. Note, however, that the refrigerant is flammable.

- Be aware of the surroundings.
- Have no ignition sources nearby.
- Either release it outside or use a hose to vent it outside.
- R600a is heavier than air and will hang around at floor level.

13.5 Brazing Off The System

Brazing off a system that uses flammable refrigerant is no more dangerous than a brazing of a refrigeration system that contains R12 that, when burnt, produces phosgene gas.

R600a will burn if it leaks from the system and is ignited.

Crimp-off pliers should be adjusted to prevent any leak. It is recommended that two pair of pliers are used for the process.

Points to remember are:

- Always work in a well-ventilated area.
- Have your crimp-off pliers adjusted correctly.
- Crimp the filter dryer process pipe off first.
- Open the high side valve on the service manifold and allow liquid trapped in the high side hose to enter the system, as this is part of the total refrigerant charge.
- Disconnect the hose/fitting. Close the end of the tube and braze off.
- Repeat the process on the compressor process pipe.

Should the system be undercharged after the service manifold is disconnected, the problem could have arisen from the fitting of a line tap valve to the process pipe, in that it is very easy to introduce non-condensables into the system at this point due to the negative pressure in the compressor shell. The practice of charging through line tap valves is not recommended.

As the amount of gas needed is so small to make the correction, it is best to evacuate and recharge the system again with the correct charge.

13.6 Pressure Testing Of The Refrigeration System

CAUTION – R-600a REFRIGERANT (ISOBUTANE)

The refrigerant contained within the sealed in system is **flammable**. All care must be taken when servicing these products. Vent well before brazing. Avoid any open flames or ignition source. The gauges, charging cylinder and other such equipment used with R-600a must not be used with other refrigerants such as R-134a, as this could cause cross contamination of the oils used in the systems. Gauges etc. should be clearly marked to ensure that they are used only for R-600a refrigerant.

The use of the in-line pressure gauge can speed up and eliminate the incorrect diagnosis of a leak within a refrigeration system. In some cases it has been found to be the services manifold that was being used that was leaking and not the system. There are very few parts on the in-line pressure gauge that can leak.

Rule one:

In pressure testing any cabinet, before disconnecting any joint please be 100% sure that it is not the joint that is at fault, otherwise a lot of time can be lost looking for a joint/leak that doesn't exist.

Rule two:

Only use dry nitrogen to pressure test a system.

NOT REFRIGERANT OR COMPRESSED AIR. NEVER OXYGEN

Rule three:

Don't over pressurise the system. It could be dangerous.

How to use the In-line Pressure Gauge:

Step 1:

Reclaim the refrigerant from the system (refer to Section 13.4) and purge the system with Dry Nitrogen.

Step 2:

Cut and connect the pipe circuit to be tested to the in-line pressure gauge and braze this joint.

Step 3:

At the other end of the pipe circuit being tested, crimp off the pipe with crimp off pliers and braze this end off to totally seal the circuit.

Step 4:

Connect a nitrogen bottle to the in-line pressure gauge by means of a hose with a Schrader valve depressing key in the hose coupling.

Step 5:

Open the nitrogen bottle fully with the regulator backed off.

Step 6:

Increase the regulator pressure in the circuit being tested to **150 psi**.

Step 7:

Close the nitrogen bottle valve, then back off the pressure regulator.

Step 8:

Disconnect the hose coupling to the Schrader valve fitting.

Step 9:

Seal the Schrader valve with its sealing cap.

Step 10:

Use a bit of masking tape to mark the face of the pressure gauge at the set pressure. Record date and time on the tape also.

Step 11:

Check all exposed brazed joints with soap bubbles, including the joints on the in-line pressure gauge.

Step 12:

Allow the pipe circuit under test to sit on drop off test. This could take a number of days for a result.

NOTE: In some cases a leak may not be found by pressurising the circuit, whereas a vacuum pulled on the same circuit will. Keep this in mind as oil within the circuit can block a hole.

In some cases, if the brazed joint is warmed while under pressure, this can thin the oil and help to expose the leak. A heat gun or hair dryer is useful.

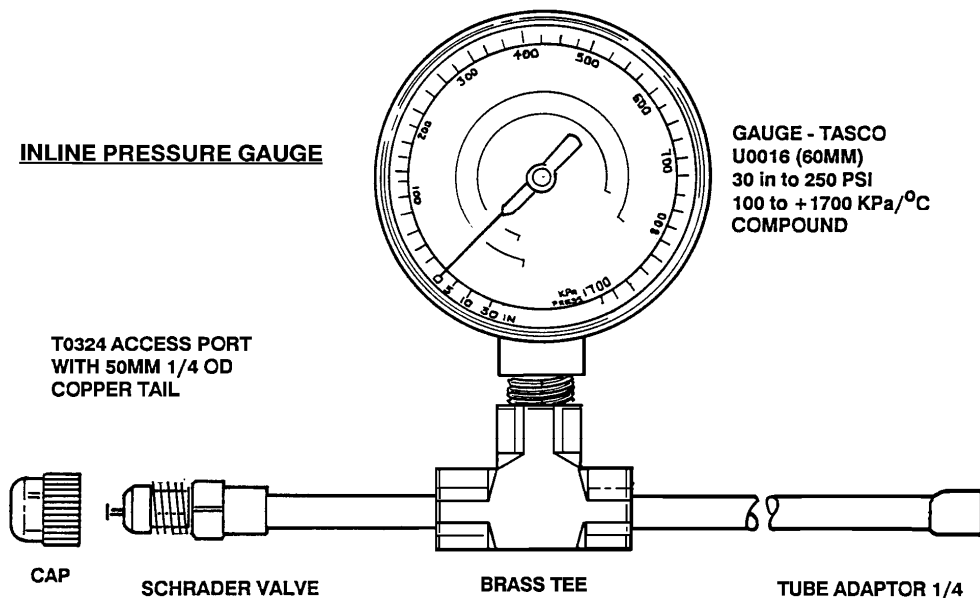

Diagram 0

13.7 Transporting Of Refrigerators

It is recommended that:

If a cabinet is to be transported lying down, then the cabinet should be placed on one side only. This is the right-hand side when standing facing the front of the refrigerator. If looking at the back of the refrigerator when it is laid down in this manner, you will see the power cord entering the cabinet at the bottom and the discharge and suction pipes on the compressor uppermost (refer to Diagram 13.7A).

It is not recommended to lay the cabinet on its back or with the suction line facing down, as this could lead to problems with oil from the compressor crank case running into the suction line coupling from inside the compressor over time and being pumped into the high side of the system when the refrigerator is plugged into the power, thus causing problems such as a blocked capillary or the compressor not pumping due to oil being slugged in the system.

To overcome the likelihood of this occurring, the cabinet should be stood upright for a minimum of 20 minutes before being connected to the power supply at the time of installation.

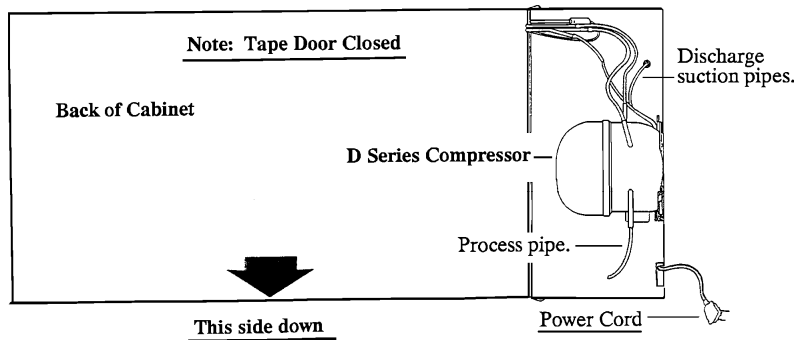

Diagram 13.7A

NOTE: We mark all our refrigerator and freezer cartons with a number of stars on one side of the carton. If the product is to be laid on its side for transporting at any time, the side of the carton with stars on should face upwards (refer to Diagram 13.7B). If transporting a cabinet that has been used, be sure to empty the water evaporator tray prior to laying the cabinet down as water from the water evaporator tray can enter the electronic power/control module which is attached to the side of the unit compartment.

Ideally, the product should be transported standing upright.

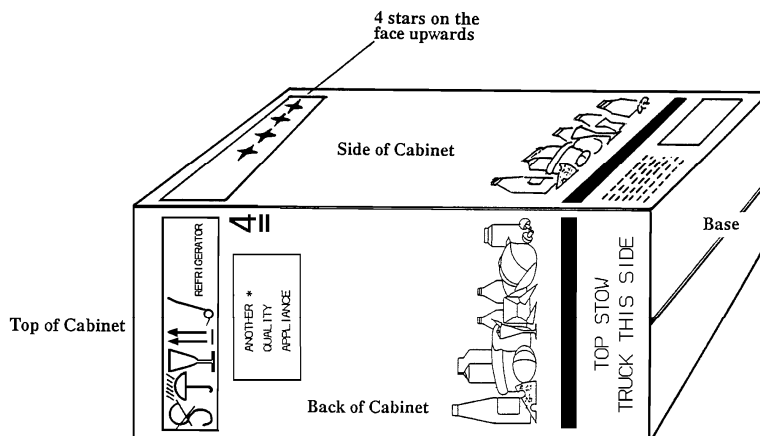

Diagram 13.7B

13.8 Evaporator Replacement

The evaporator is located in the FC compartment mounted on the back wall on its own carrier, with a grill covering a fan motor that is housed in the front cover.

Having determined that the evaporator needs replacing:

1. Recover the refrigerant.
2. Remove the FC door.
3. Remove the evaporator coil cover.
4. Clean both suction and capillary pipes with emery cloth.
5. With the tube cutter, cut the suction pipe as close as possible to the induction brazed joint (cutting the suction capillary side of the joint).
6. With a file or knife cut the capillary where it enters the transition joint on the evaporator.
7. With the element wiring disconnected, the evaporator can be removed.
8. Take the replacement evaporator and fit it to the carrier, fitting the defrost element assembly and fitting the heat shrink sleeving onto the pipes.
9. Align the evaporator and joints ready to be soldered into position.
10. Lay the product on its back.
11. Place a protective covering over the back of the liner to protect it should solder drop onto it while the joint connections are being made.
12. Fit the suction and capillary lines together, with a protective heat shrink sleeving first being placed on the pipe clear of the heated area. Care must be taken when brazing near the plastic liner.
13. The same applies for the capillary, applying more heat to the transition joint as it is heavier in material than the capillary.
14. Pressure test both joints.
15. Slide the heat shrink sleeving over the joint and heat, having placed damp rags around the area of the ABS liner as heating the heat shrink can cause the liner to be overheated. It is also important to keep the thermal fuse in the element circuit away from the heat gun, as heat from the heat gun can cause the thermal fuse to go open circuit.

13.9 Refilling A Void In Foam Insulation After System Service Or Adjustment

When 50ml of each foam component is mixed together, sufficient insulation will be formed to fill a space of approximately 25cm x 25cm x 5cm deep (3 litres volume). "Freefoam" means that the space being filled is not fully enclosed.

The foam is handled as follows:

1. Roughly determine the volume of the void to be foamed and then determine how much activator and resin is required. Do a test run mixing a $\frac{1}{4}$ cup of each to estimate your requirement (on waste cardboard).
2. Measure equal quantities of activator and resin into a large wax cup or similar and mix briskly with a wooden spatula for 10-15 seconds. The mixture will start to feel warm and this indicates that mixing is complete.
3. Pour the mixture into the void and allow to foam. More can be added if necessary.
4. When the foam is firm, remove any excess with a sharp knife, apply a film of wax to the foam, apply a vapour seal to the triple fold, then refit the back panel, making sure the panel is perfectly vapour sealed.
5. **DO NOT OPERATE THE APPLIANCE FOR AT LEAST FOUR HOURS AFTER FOAMING.**
6. Foam solvent for cleaning while the foam is still in a liquid state is methylated spirits.

CAUTION

1. Avoid splashing the mixture onto the cabinet. Once set, foam is almost impossible to remove.
2. When clearing a pocket for foaming it is recommended to leave a layer of old foam against the ABS plastic liner for support and to prevent pressure of the foam causing a bulge on the PC inside surface.

13.9.1 Polyurethane Foam

The insulation material being used in refrigerator and home freezer cabinets is polyurethane foam. Polyurethane foam is a two-part mix, consisting of a pre-mix and an isocyanide. The pre-mix contains: polyol, catalyst, silicone surfactant, water and fluorocarbon-II. The isocyanate is 4,4¹ diphenyl methane diisocyanate, or M.D.I. for short. In the past, tollene di-isocyanate, or T.D.I. for short, was used. When the cabinet is "foamed" in the factory, the pre-mix and isocyanate are conditioned at a prescribed temperature in advance. When the two ingredients are mixed together, they start to expand. Heat is produced by the chemical reaction, which causes the fluorocarbon-II to boil, giving off a gas and creating a froth. It is this froth that produces the cell structure. The size of the cells formed is controlled, to a large degree, by the silicone surfactant, and this is critical in order to provide the required insulation properties.

Precautions necessary when using these Chemicals:

Vapours from the pre-mix and isocyanate can be hazardous to your health, as can be skin contact from both liquids. When using foam, make sure that adequate protective clothing is worn and sufficient ventilation is present to remove the vapours that will be given off by the mixture. Should any of the chemicals come in contact with your skin, rinse off with water. If a gas torch is used whilst repairing a refrigerator or freezer, care must be taken not to set the foam alight, as cyanide fumes will be given off, as well as phosgene generated from the burnt fluorocarbon present. Both of these gases can be dangerous if they are allowed to accumulate and, for this reason sufficient ventilation must be present when doing repair work that is liable to cause the generation of gases.

13.9.2 Safe Practices

- (a) Do not inhale any vapour from the liquids.
- (b) Measure chemicals by weight only and NOT by volume. (Not essential for small quantities used for filling voids after repair).
- (c) Avoid contact with skin or clothing.
- (d) Use only in accordance with the recommended safety procedures.
- (e) Remove, wash and decontaminate clothing before re-use.
- (f) Do not smoke near foam operations.
- (g) Isocyanate contact with the eyes:

Splashes of isocyanate in the eye are an irritant and may cause severe chemical conjunctivitis. If **any** chemical used in the foaming process enters the eyes, they should be washed out as soon as possible with copious amounts of clean water for at least 15 minutes. It has been found that this will require the help of another person to hold the victim's eye open. Foam that is frothing is particularly dangerous if it enters the eyes.

Contact lenses must **NOT** be worn when working with isocyanates, for the chemicals can get in behind these lenses and irreparable damage may occur to the eye while the lens is being removed prior to flushing with water.

DO'S AND DON'TS WHEN USING THESE CHEMICALS

- DO** wear sufficient protection - overalls, gloves and goggles - as directed by supervision or written instructions.
- DO** check that first aid facilities are always at hand.
- DO** avoid personal contact with the chemical.
- DO** wash thoroughly immediately on leaving the work area.
- DO** seek medical attention at the first sign of breathing or chest troubles.
- DO** take care when using a gas torch in the repair of a refrigerator and protect the foam from the heat.
- DO** provide sufficient ventilation so as to avoid breathing any vapours whenever foam materials are handled, mixed or poured. **THIS IS ESSENTIAL.** Cyanide fumes will be given off, together with phosgene from the fluorocarbon present in each foam cell.
- DON'T** let familiarity with the chemical breed contempt.
- DON'T** ignore splashes on the skin - wash them off immediately with soap and water.
- DON'T** take food or drink into an area where isocyanates are used.
- DON'T** neglect splashes in the eye (see note above).

SUGGESTED METHODS FOR VENTILATION

In a workshop, fixed and/or portable ducting, with exhaust fans, can provide good ventilation.

In a customer's house, various alternatives are possible:

- (a) A portable ducted fan exhausting to the open air.
- (b) Turn on a kitchen X-pelair fan and work near it.
- (c) If the clothes dryer exhausts to the outside air, turn the fan on and work near it.
- (d) Use the household vacuum cleaner as a vent.
- (e) Work outside.

In service applications, the quantities used may be small, but observance of these safe practices is advisable.

13.10 Removing Back Panel For Access To Water Lines And Joints

For models having an internal condenser, firstly recover the refrigerant, then disconnect the condenser piping to the back panel.

Lay the cabinet face down using a protective covering on the floor to prevent any damage to the front of the cabinet.

Lever the back panel up at the bottom corners with a screwdriver. With heavy-duty pliers on either side, pull up sharply. The back panel will come away from the foam insulation and out of the retaining channel. Some force will be required initially, however once started, the panel will come away easier.

After removing the rear panel, commence cutting away the foam insulation to expose the joints. Clear away enough foam insulation.

Caution: Prevent naked flame and heat on the foam and on the ABS plastic liner. Use a heat absorbent material between pipes, liner and foam or both. (Refer to Section 13.9 for foaming.)

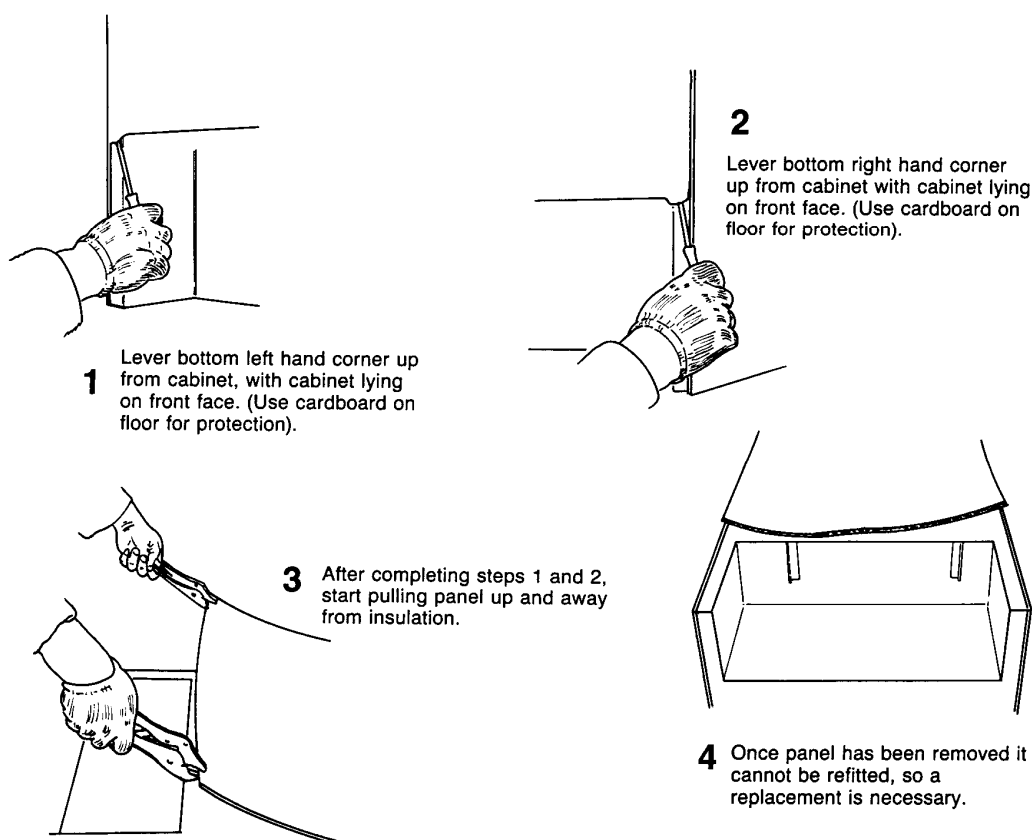

Diagram 13.10

13.11 Embraco Compressor Fitted With External Overload

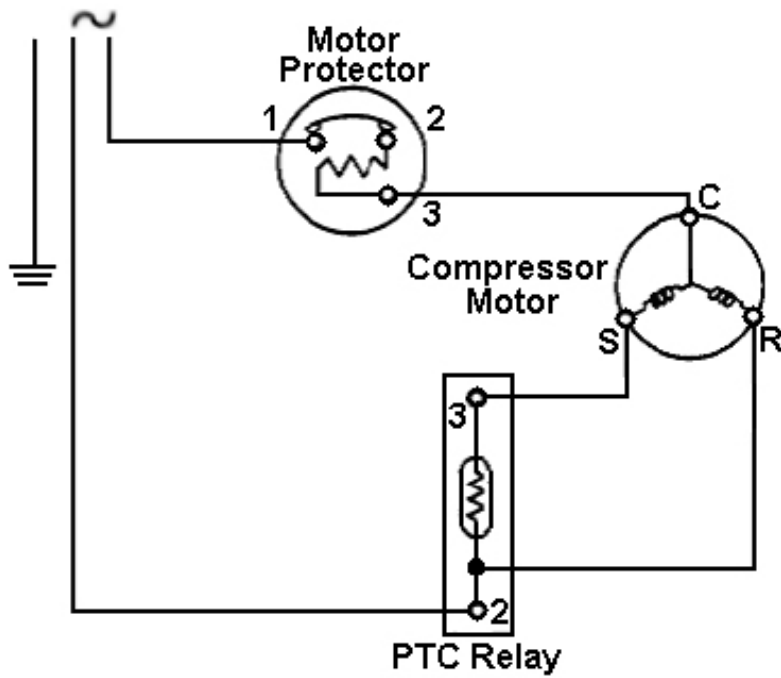
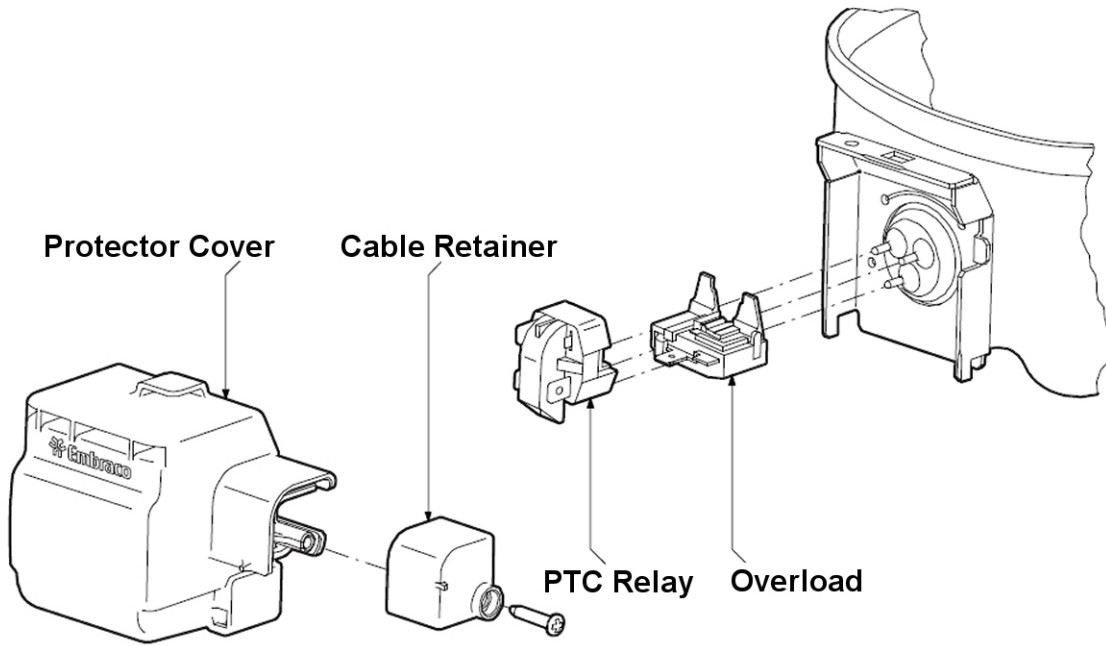

Diagram 13.11

13.12 Matsushita Compressor Fitted With External Overload And Run Capacitor

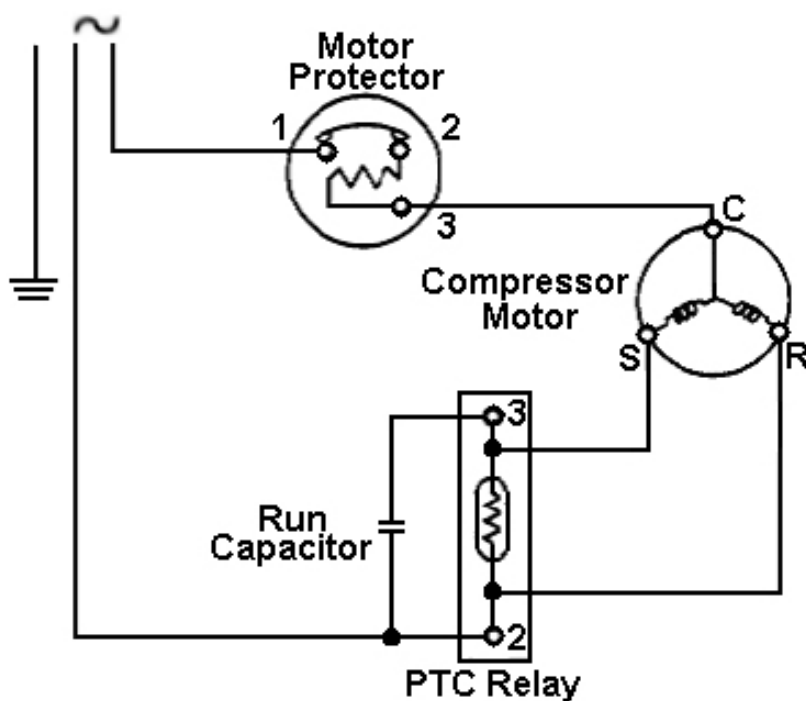
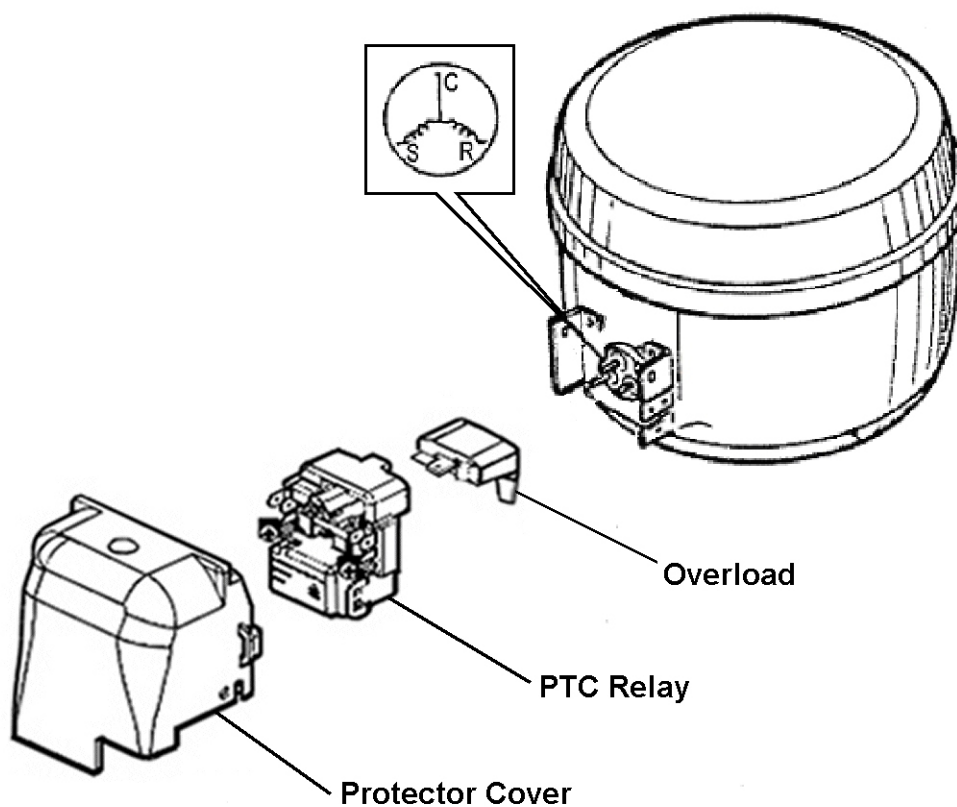

Diagram 13.12

13.13 Compressor Replacement

CAUTION – R-600a REFRIGERANT (ISOBUTANE)

The refrigerant contained within the sealed in system is **flammable**. All care must be taken when servicing these products. Vent well before brazing. Avoid any open flames or ignition source. The gauges, charging cylinder and other such equipment used with R-600a must not be used with other refrigerants such as R-134a, as this could cause cross contamination of the oils used in the systems. Gauges etc. should be clearly marked to ensure that they are used only for R-600a refrigerant.

1. Disconnect the power cord from wall outlet. Empty the freezer.
2. Recover the refrigerant or vent to atmosphere from the system by fitting a line tap valve to the process pipe on the compressor and connecting to the recovery unit.
3. Disconnect the electrical harness leads from the relay and overload. (Electric's must be returned with the failed compressor).
4. Unbrazed the compressor suction, discharge and oil cooler lines. Cut if a blockage suspected.
5. Remove the retaining clips from the compressor mounting pins to lift clear of the unit compartment. Seal the compressor lines.
6. Fit the new compressor to the mounting pins and place back into the cabinet.
7. Braze in the suction and discharge lines.
8. Replace the filter drier. (Cut from the system, do not heat.)
NOTE: Do not push the capillary tube too far into the filter or it may become blocked by the filter screen.
9. Pressurise the system and test for leaks.

COMPRESSOR PIPING LAYOUT

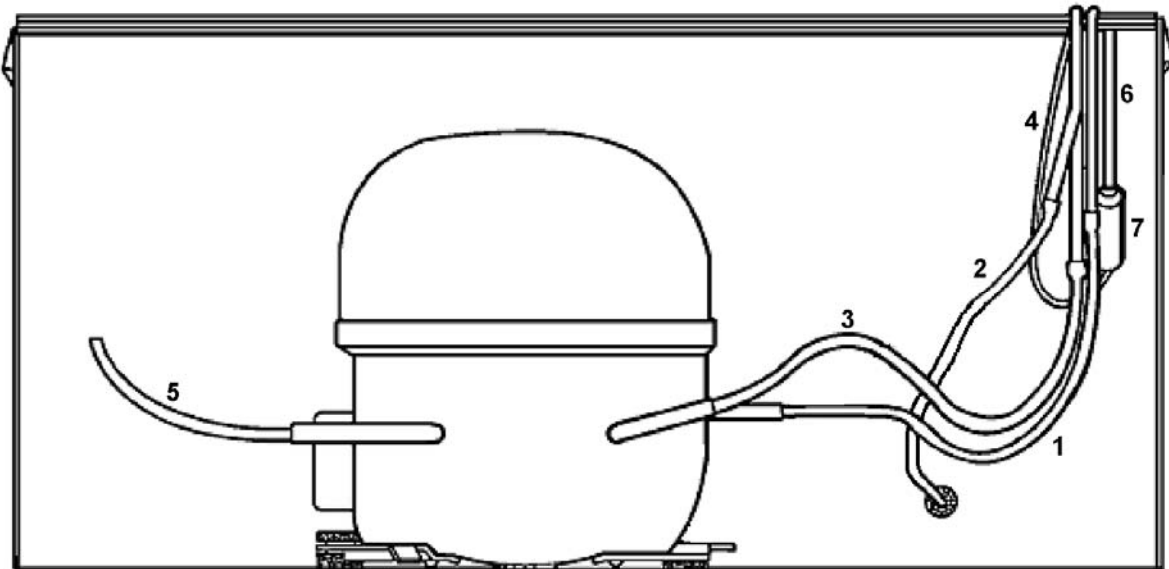

Diagram 13.13

1. Discharge line to Condenser Back Panel.
2. Condenser Back Panel to Base Tube.
3. Suction Line.
4. Capillary.
5. Service Tube (process pipe).
6. End of Side Condenser/Throat Heater Circuit.
7. Filter Drier.

13.14 Compressor Fault Diagnosis

13.14.1 Compressor Won't Start - Dead (PTC Relay Fitted)

Checks to be carried out:

1. Check the fuse and power outlet.
2. Check that there is the correct voltage from the power/control module to the compressor.
3. Continuity test from the 3-pin plug, terminal block and harness to relay.
4. Check the overload for continuity.
5. Test the PTC Relay.
Remove it from the compressor, and using an ohmmeter check the resistance through the PTC itself between M and S terminals or 2 and 3 terminals. The PTC will have a low resistance at a low temperature (30-60 ohms at 18°C).
6. With the PTC removed, check the run and start windings of the compressor using an ohmmeter. Refer to the compressor specifications page for these figures.

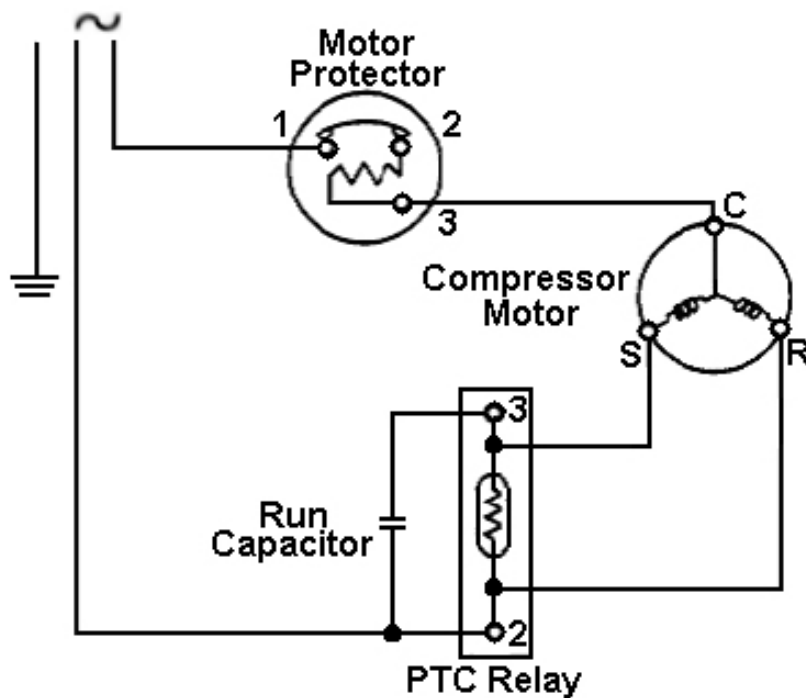

Diagram 13.14.1

13.14.2 Compressor Won't Start - Hums

Possible Causes:

1. Voltage may be low e.g. 10% low. Test the voltage under load.
2. Check the voltage to the compressor from the power/control module.
3. System pressures may not be equalised; too short an off cycle.
4. Check the start and run windings with an ohmmeter.

13.14.3 Compressor Starts, Runs And Then Stops

Possible Causes:

1. Low voltage - high voltage.
2. Check the compressor voltage matches the supply voltage.
3. The system may be grossly overcharged, causing liquid refrigerant to enter the compressor low side causing slugging of oil.
4. Check the current draw - overload protector.
5. The high pressure side may be fully or partially blocked. Very high head pressure. Normally a blockage before the condenser.
6. The condenser too hot, e.g. air movement blocked or ambient temperature too high. The refrigerator may be too close to a heating appliance.
7. Check the compressor pipe connections. The oil cooler may not be correctly connected. High head pressure.
8. Check that the correct relay and / or overload is fitted and that it is operating correctly.
9. Overload - connect an amp meter, switch on and note the current draw. If the current normal as per service specifications, and the overload activates, the overload must be defective or of the wrong type. Short out the overload, and if the compressor runs normally, then the overload is faulty.
10. Test, with an ohmmeter, the compressor windings for continuity and correct resistance. Refer to the compressor specifications.

14 WIRING DIAGRAMS

14.1 Non Ice & Water Models Power/Control Module Wiring Connections

RAST 2.5 harness colours:

- Display – Blue
- Cross Rail Reed Switch – Black
- Base Rail Reed Switch – Red
- Other colours as noted on the diagram. For the connector part numbers refer to Section 12.23.
- Sensors – PC – Brown
- Sensors – Evap – Black
- Sensors – FC – White
- FC Fan / LAH - T model – Yellow
- PC Fan - T model – Pink
- Fans / LAH – B model – Orange

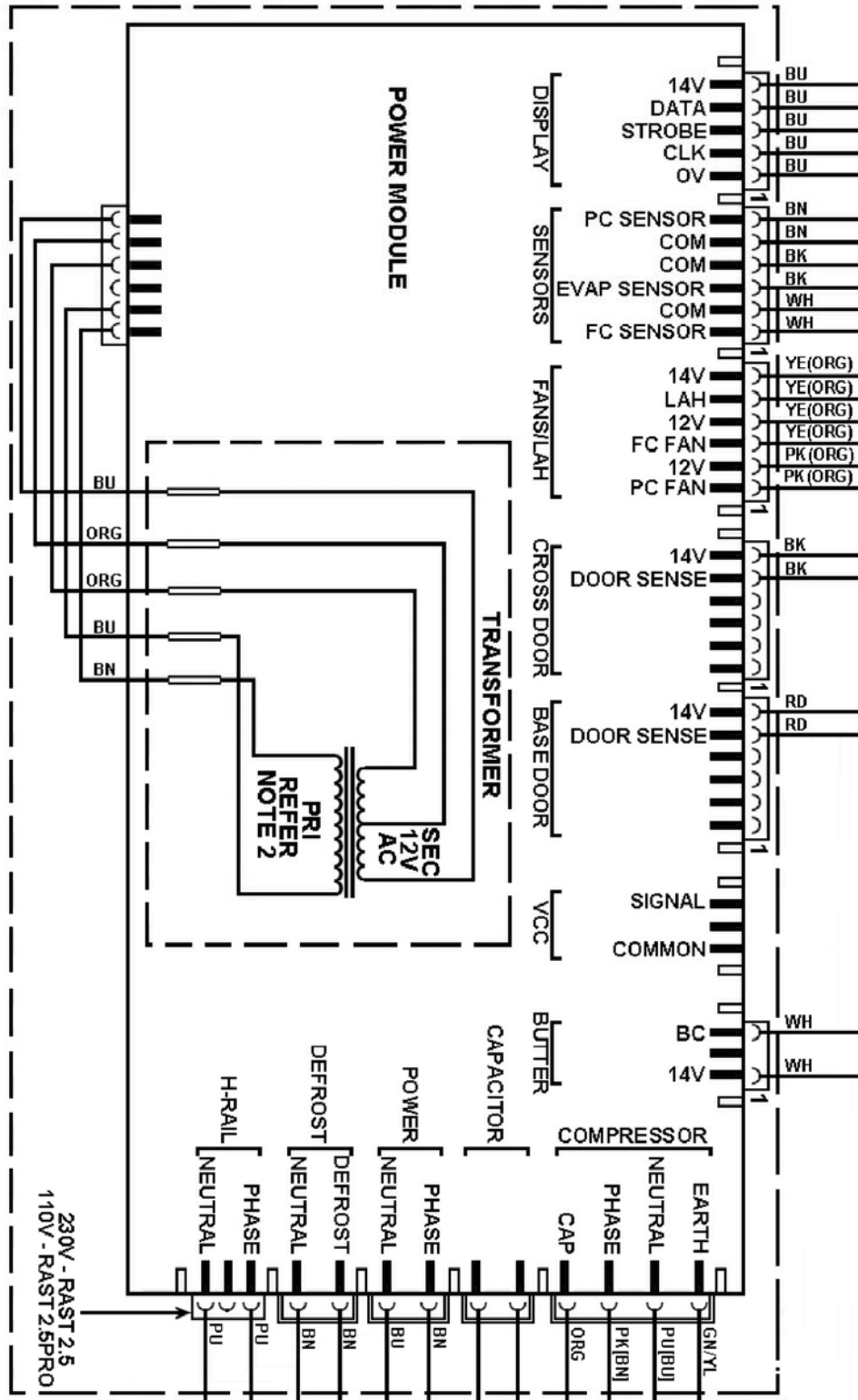

14.2 Non-Ice & Water Models Wiring Diagram

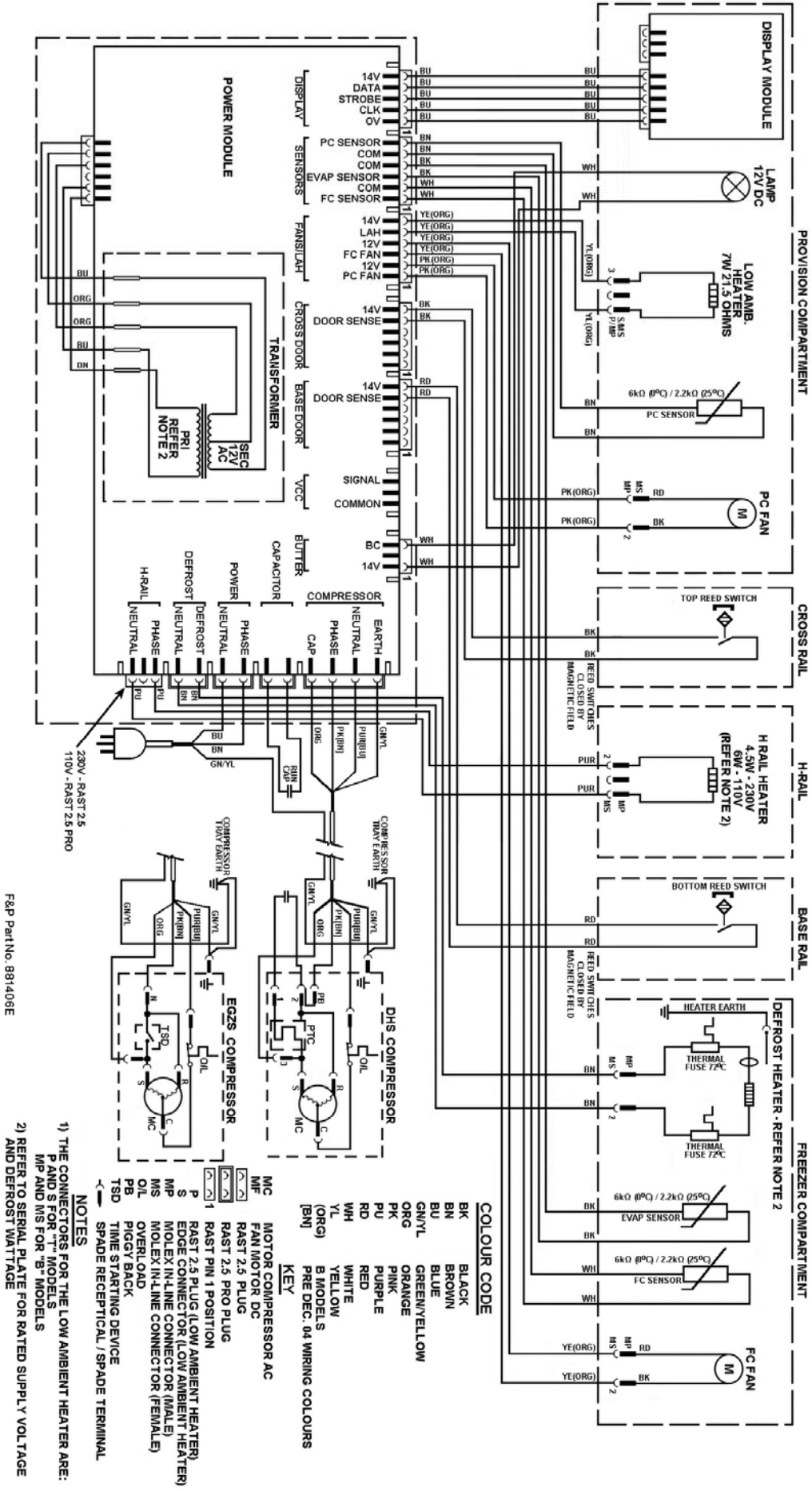

F&P Part No. 9814409E

14.3 Ice & Water Models Power/Control Module Wiring Connections

RAST 2.5 harness colours:

Display – Blue
 Cross Rail Reed Switch – Black
 Base Rail Reed Switch – Red
 Other colours as noted on the diagram. **For the connector part numbers refer to Section 12.23.**

Sensors – PC – Brown
 Sensors – Evap – Black
 Sensors – FC – White

FC Fan / LAH - T model – Yellow
 PC Fan - T model – Pink
 Fans / LAH – B model – Orange

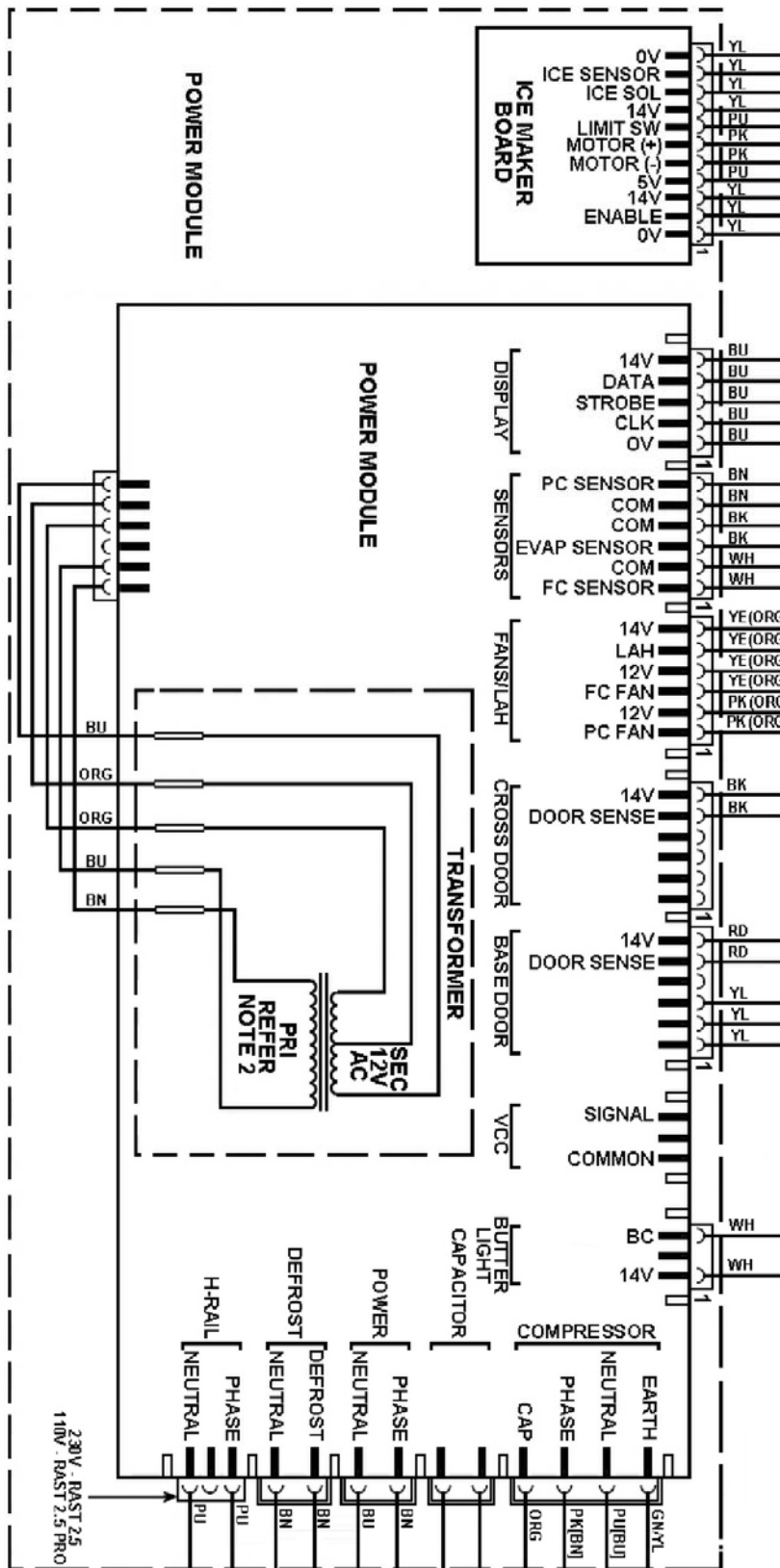

14.4 Ice & Water Models Wiring Diagram

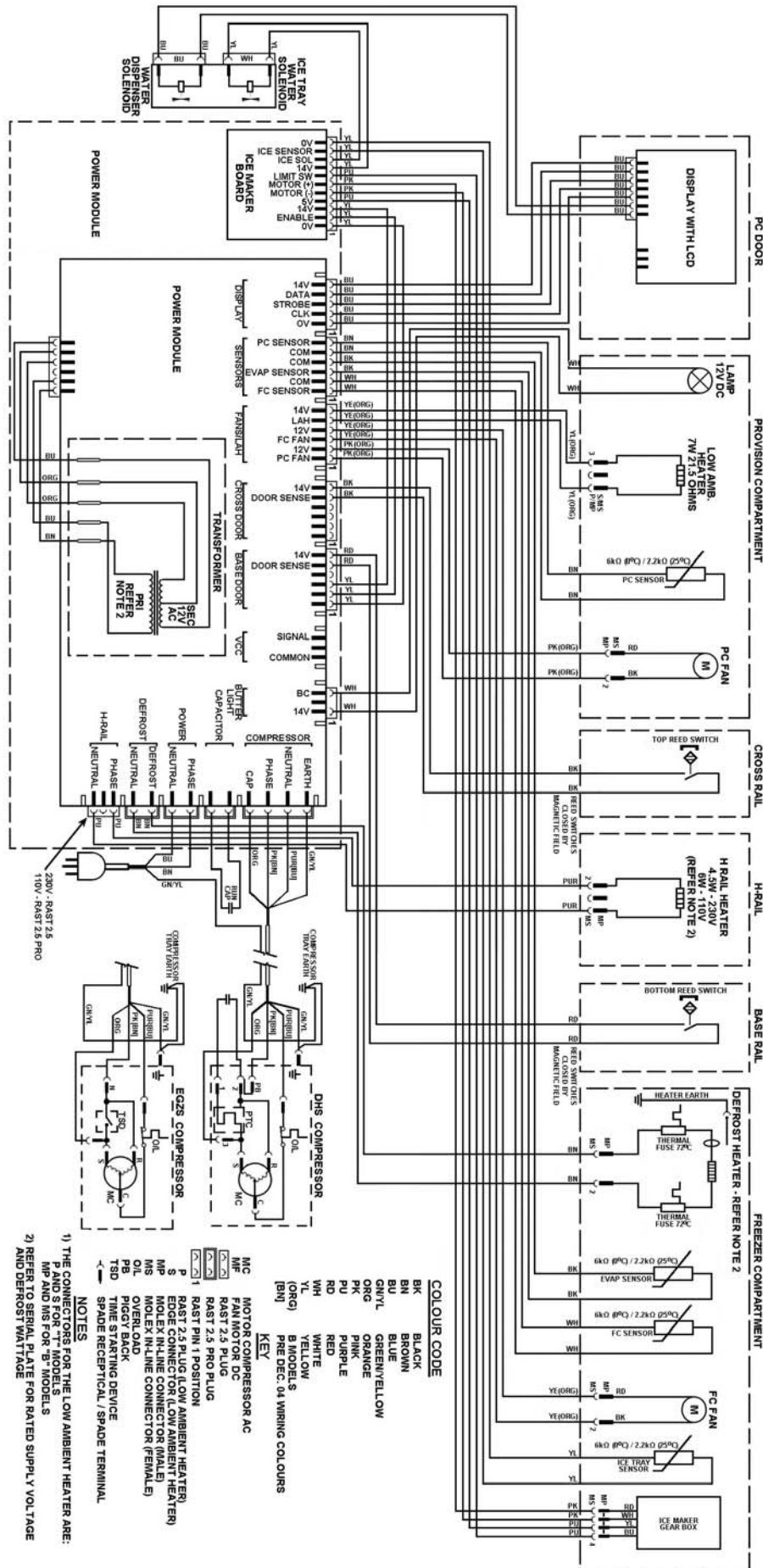

14.6 900 Models Wiring Diagram - Reciprocating Compressor

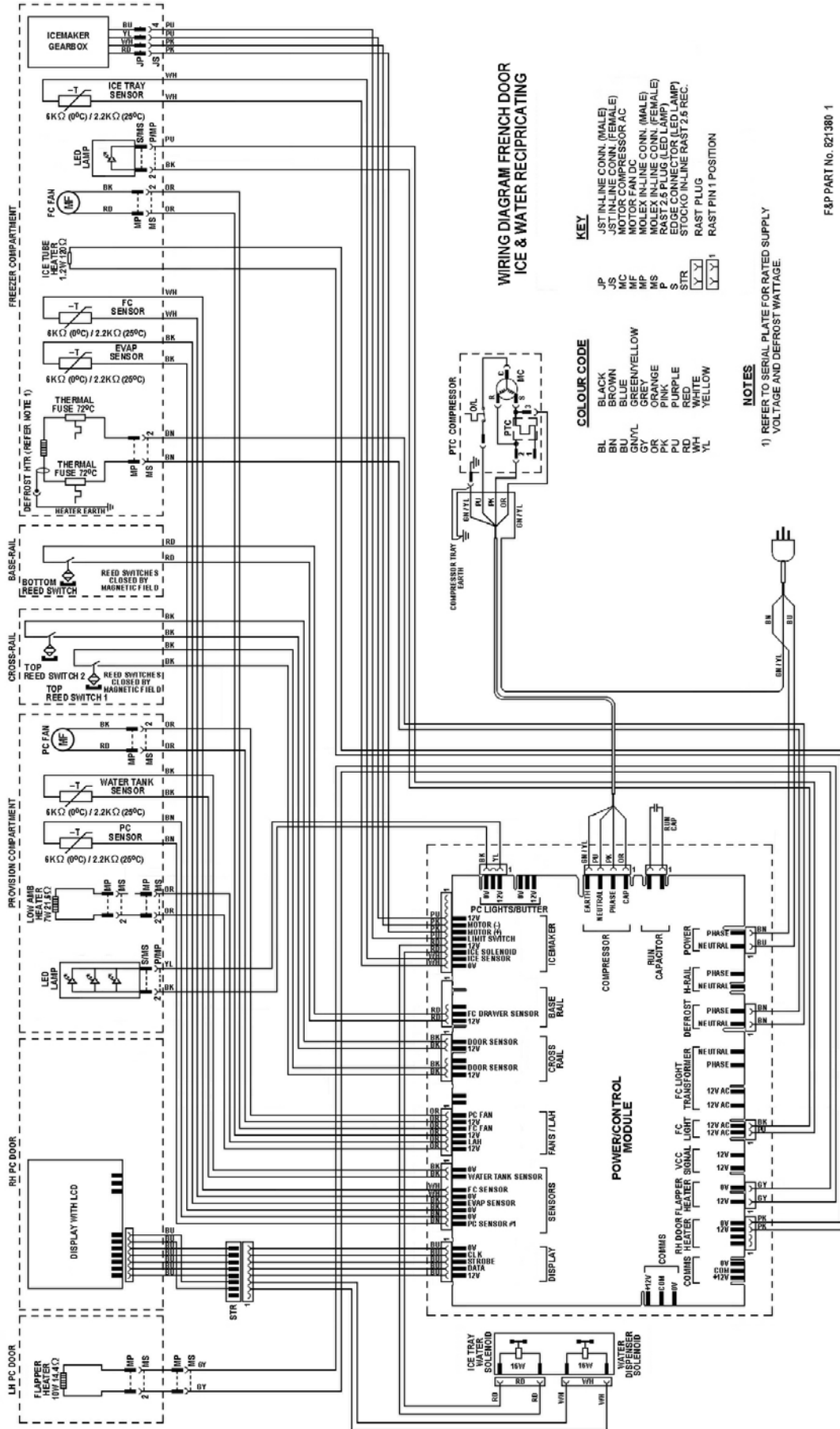

F&P PART No. 621380-1

14.8 900 Models Wiring Diagram - VC Compressor

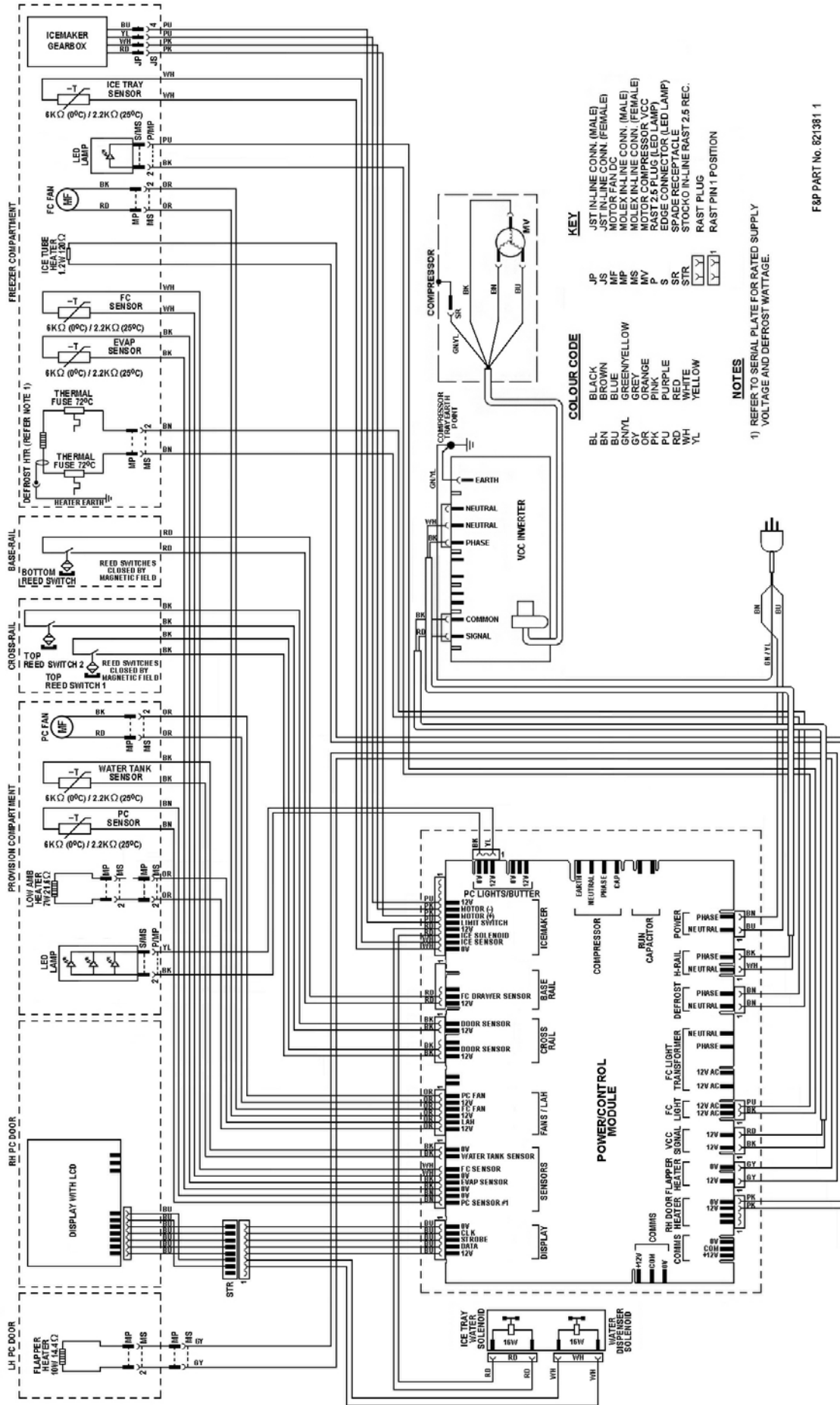

F&P Part No. 821381 1

14.9 "B" Model Wiring Route

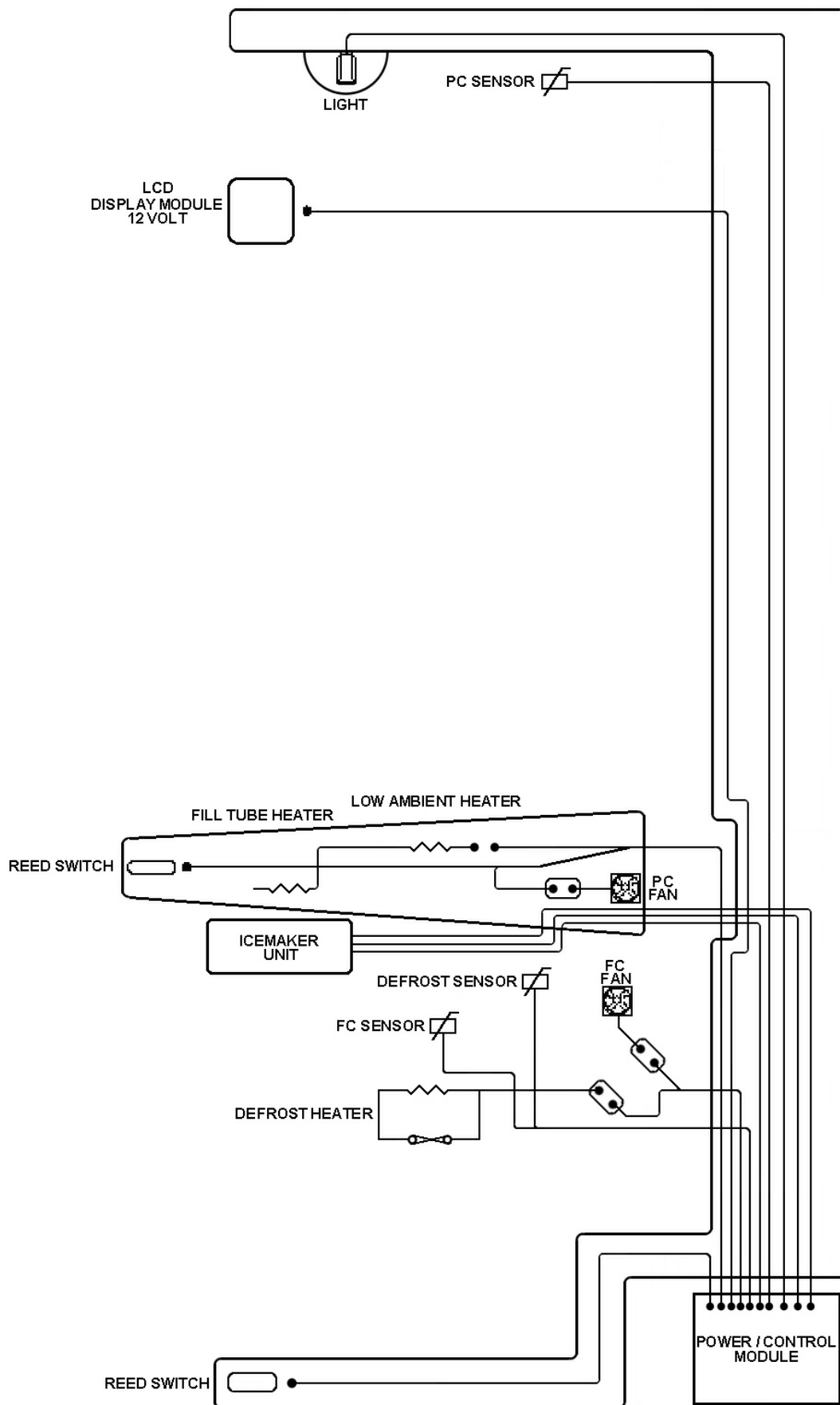

Diagram 14.9

14.10 "T" Model Wiring Route

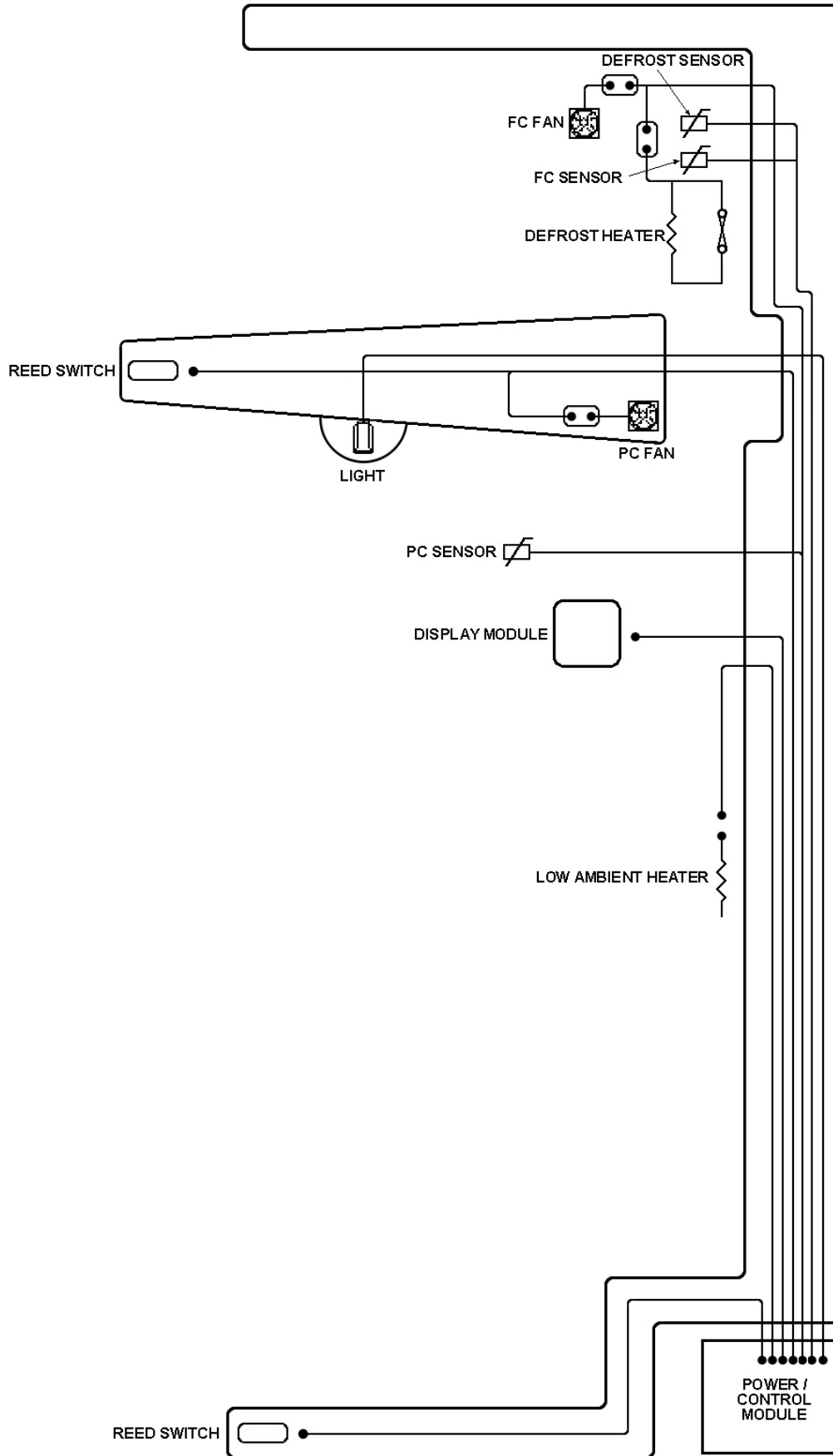

Diagram 14.10

15 SERVICE REFERENCE

15.1 Service Reference 'B' Models

Problem	Possible Causes	What To Do
PC TOO COLD		
Cold Crispers.	* Ambient heater open circuit.	- Check for fault code (refer to Sections 10.1.1 or 10.2.1). - Check continuity of element using multimeter.
Ice In Crispers.	* PC fan fitted upside down.	- Fan hub with label on to be facing PC.
	* PC fan not going.	- Check for fault code (refer to Sections 10.1.1 or 10.2.1). - Check voltage to plug, check wiring polarity.
	* Air leakage base duct cover.	- Seal with foam tape on duct divider spigot.
	* PC sensor location.	- Remove insulation pad.
Cold Compartment Warm Top.	* PC fan not going.	- Check for fault code (refer to Sections 10.1.1 or 10.2.1). - Check for mechanical obstruction. - Check polarity. - Check for broken wires. - Replace fan.
Total Compartment Too Cold.	* FC fan not going.	- Check for fault code (refer to Sections 10.1.1 or 10.2.1). - Check for mechanical obstruction. - Check for broken wires. - Check polarity. - Replace fan.
	* Short of gas.	- Check run percentage, if high check evaporator. - Check fully flooded evaporator, check for leak.
	* PC sensor inaccurate.	- Check calibration of sensor ice point using interface binary (refer to Sections 10.1.5 or 10.2.3) or refer to thermistor resistance table (refer to Section 4.22).
PC TOO WARM		
Warm Compartment Cool Bottom.	* PC fan not going.	- Check for fault code (refer to Sections 10.1.1 or 10.2.1). - Check for mechanical obstruction. - Check polarity. - Check for broken wires. - Replace fan.
	* PC fan upside down.	- Fan hub with label on to be facing PC. Refit.
	* Return duct iced up.	- De-ice duct area behind chassis. - Check PC duct insulation for good seal in return duct. - Check doors are sealing.

Problem	Possible Causes	What To Do
Total Compartment Warm.	* PC duct blocked.	- Defrost evaporator chassis. - Check for door seal.
	* Evaporator ice up.	- Check defrost element, check continuity. - Check door seal / door left open.
	* No refrigeration.	- Does compressor run? If no, check power supplies. If yes, check refrigeration system. If running, check for live frost/fully flooded evaporator. If not, check for leak.
	* Fans not working.	- Check for fault code (refer to Sections 10.1.1 or 10.2.1). - Is there a 12Volt supply, PC light working? - If yes, check fan connection(s) at fan end, also at power/control module end of the harness. - If no, check for power/control module failure.
	* Power/control module failure.	- Are lamp / interface LED's working? - If not, check display module connection. - If OK, is compressor running? - If not, replace power/control module.
FC TOO COLD		
Total compartment too cold.	* FC sensor location.	- Check set temperature. Sensor clipped and located in correct position?
	* Faulty sensor.	- Check calibration of sensor ice point using interface binary (refer to Sections 10.1.5 or 10.2.3) or refer to thermistor resistance table (refer to Section 4.22).
	* PC fan not going.	- Check for fault code (refer to Sections 10.1.1 or 10.2.1). - Check for mechanical obstruction. - Check polarity. - Check for broken wires. - Replace fan.
FC TOO WARM		
Bottom warm top frozen.	* Iced up evaporator.	- Check defrost element is working, replace if faulty. - Check doors are sealing or have they been left open? Adjust and advise customer. - FC fan jammed? Clear restriction, replace fan if necessary. - Check defrost sensor position, reposition onto chassis if not already there.
Total compartment warm.	* PC fan not going.	- Check for fault code (refer to Sections 10.1.1 or 10.2.1). - Check for mechanical obstruction. - Check polarity. - Check for broken wires. - Replace fan.
	* No refrigeration.	- Does compressor run? If no, check power supplies. If yes, check refrigeration system. If running, check for live frost / fully flooded evaporator, if not, check for leak.

Problem	Possible Causes	What To Do
TOTAL CABINET TOO WARM		
	* No refrigeration.	<ul style="list-style-type: none"> - Does compressor run? If no, check power supplies. If yes, check refrigeration system. If running, check for live frost/fully flooded evaporator. If not, check for leak. - Compressor is not running, check power/control module voltage outputs. Check compressor and ancillaries. - Check reed switches are working OK.
FC COOLING PC WARMING		
	* Iced up evaporator.	<ul style="list-style-type: none"> - Check defrost circuit continuity. - Check doors are sealing. - PC fan running? If not, refer 'PC Too Warm'.
	* Iced up return duct.	<ul style="list-style-type: none"> - De-ice duct area. - Check PC duct insulation for good seal in return duct. - Check doors are sealing.
ALARM ON		
	* Defrost heater.	<ul style="list-style-type: none"> - Check display for any fault code. - Check defrost element continuity. - Put cabinet into manual defrost (refer to Sections 10.1.8 or 10.2.6), wait for defrost relay to "click" on (refer to Section 4.3). - If no "click", check power/control module. - If "click" heard, check the defrost heater 230v output at the power/control module.
	* Sensors.	<ul style="list-style-type: none"> - Check display for fault codes 0 - 5. - Sensors above or below limit? Refer thermistor resistance table (Section 4.22).
	* Door switch fault.	<ul style="list-style-type: none"> - Check that no fault code is shown on the display. - Check that PC/FC doors activate reed switches by using Input/Output test (refer to Sections 10.1.6 or 10.2.4). - Check operation of reed switches with magnet. - Check wiring harness to power/control module.
FAULT DISPLAYED, NO ALARM		
	* Display flashing fault code, but no alarm sounding.	<ul style="list-style-type: none"> - Alarm has been switched off by user. - Piezo alarm faulty. Replace power/control module.
LIGHT NOT FUNCTIONING		
	* Blown LED PCB.	<ul style="list-style-type: none"> - Check power supply to socket 7 volts. If nil, check plug at power/control module.
	* Reed Switch.	<ul style="list-style-type: none"> - Check reed switch is working by using a magnet. - Check reed switch operation using Input/Output test (refer to Sections 10.1.6 or 10.2.4).
	* Poor connection.	<ul style="list-style-type: none"> - Lamp holder, replace where possible. - Connector on power/control module.

Problem	Possible Causes	What To Do
CONSOLE NO LED LIGHTS		
	* Power/control module no power.	- Check harness and plugs on 5-way display module harness at both ends.
	* Power/control module not initialised.	- Initialise power/control module (refer to Section 12.4.1). - If raspberry noise made when attempting to initialize, check door switches.
NOISY FAN FC		
	* Ice on cover.	- Clear ice off cover and check doors are sealing.
	* Ice on grill.	- Clear ice off grill and check doors are sealing.
	* Fan off mountings.	- Refit.
	* Wires touching.	- Tuck wires away from fan blade.
	* Capillary touching.	- Shift capillary from fan area, making sure it is not touching any part of the cabinet.
	* Fan motor noisy.	- Fit replacement.
	* Wires pulled tight.	- Re route wiring.
ICE BUILD UP COMPARTMENT		
	* Doors not sealing.	- Check gaskets are sealing, adjust gaskets - Fit drain valve to drain tube.
REFRIGERATION NOISE		
	* Popping, farting.	- Check capillary is straight where it enters evaporator.
	* Gurgling, whistling.	- Check alignment of capillary and apply sound dampening tape.

15.2 Service Reference 'T' Models

Problem	Possible Causes	What To Do
PC TOO COLD		
Total Compartment Too Cold.	* FC fan not going.	<ul style="list-style-type: none"> - Check for fault code (refer to Sections 10.1.1 or 10.2.1). - Check for mechanical obstruction. - Check for broken wires. - Check polarity. - Replace fan.
	* Short of gas.	<ul style="list-style-type: none"> - Check run percentage. If high, check evaporator. - Check fully flooded evaporator, check for leak.
	* PC sensor inaccurate.	<ul style="list-style-type: none"> - Check calibration of sensor ice point using interface binary (refer to Sections 10.1.5 or 10.2.3) or refer to thermistor resistance table (refer to Section 4.22).
PC TOO WARM		
Total Compartment Warm.	* Evaporator ice up.	<ul style="list-style-type: none"> - Check defrost element, check continuity. - Check door seal/door left open.
	* No refrigeration.	<ul style="list-style-type: none"> - Does compressor run? If no, check power supplies. If yes, check refrigeration system. - If running, check for live frost/fully flooded evaporator. If not, check for leak.
	* Fans not working.	<ul style="list-style-type: none"> - Check for fault code (refer to Sections 10.1.1 or 10.2.1). - Is there a 12Volt supply, PC light working? - If yes, check fan connection(s) at fan end, also at power/control module end of the harness. - If no, check for power/control module failure. - Check fan is not a Y97-16 stalling on fan speed 3.
	* Power/control module failure.	<ul style="list-style-type: none"> - Are lamp / interface LED's working? - If not, check display module connection. - If OK, is compressor running? - If not, replace power/control module.
	* PC delivery duct blocked.	<ul style="list-style-type: none"> - De-ice area behind chassis.
FC TOO COLD		
Total Compartment Too Cold.	* FC sensor location.	<ul style="list-style-type: none"> - Check set temperature. - Sensor clipped and located in correct position?
	* Faulty sensor.	<ul style="list-style-type: none"> - Check calibration of sensor ice point using interface binary (refer to Sections 10.1.5 or 10.2.3) or refer to thermistor resistance table (refer to Section 4.22).
	* PC fan not going.	<ul style="list-style-type: none"> - Check for fault code (refer to Sections 10.1.1 or 10.2.1). - Check for mechanical obstruction. - Check for broken wires. - Check polarity. - Replace fan.

Problem	Possible Causes	What To Do
FC TOO WARM		
Total Compartment Warm.	* PC fan not going.	<ul style="list-style-type: none"> - Check for fault code (refer to Sections 10.1.1 or 10.2.1). - Check for mechanical obstruction. - Check for broken wires. - Check polarity. - Replace fan.
	* No refrigeration.	<ul style="list-style-type: none"> - Does compressor run? If no, check power supplies. If yes, check refrigeration system. - If running, check for live frost/fully flooded evaporator. If not, check for leak.
TOTAL CABINET TOO WARM		
	* No refrigeration.	<ul style="list-style-type: none"> - Does compressor run? If no, check power supplies. If yes, check refrigeration system. - If running, check for live frost/fully flooded evaporator. If not, check for leak. - If compressor is not running, check power/control module voltage outputs. - Check compressor and ancillaries.
FC COOLING PC WARMING		
	* Iced up evaporator.	<ul style="list-style-type: none"> - Check defrost circuit continuity. - Doors sealing? Adjust. - PC fan running? If not, refer 'PC Too Warm'.
ALARM ON		
	* Defrost heater.	<ul style="list-style-type: none"> - Check display for any fault code. - Check defrost element continuity. - Put cabinet into manual defrost (refer to Sections 10.1.8 or 10.2.6), wait for defrost relay to "click" on (refer to Section 4.3). - If no "click", check power/control module. - If "click" heard, check the defrost heater 230v output at the power/control module.
	* Sensors.	<ul style="list-style-type: none"> - Check display for fault codes 0-5. - Sensors above or below limit? Refer thermistor resistance table (Section 4.22).
	* Door switch fault.	<ul style="list-style-type: none"> - Check that no fault code is shown on the display. - Check that PC/FC doors activate reed switches by using Input/Output test (refer to Sections 10.1.6 or 10.2.4). - Check also reed switches with magnet. - Check wiring harness to power/control module.
FAULT DISPLAYED, NO ALARM		
	* Display flashing fault code, but no alarm sounding.	<ul style="list-style-type: none"> - Alarm has been switched off by user? - Piezo alarm faulty on board of power/control module? Replace module.

Problem	Possible Causes	What To Do
LIGHT NOT FUNCTIONING		
	* Blown LED PCB.	- Check power supply to socket 7 volts. If nil, check plug at power/control module.
	* Reed Switch.	- Check reed switch is working by using a magnet. - Check reed switch operation using Input/Output test (refer to Section 10.2.4).
	* Poor connection.	- Lamp holder, replace where possible. - Connector on power/control module.
CONSOLE NO LED LIGHTS		
	* Power/control module no power.	- Check harness and plugs on display module harness at both ends.
	* Power/control module not initialised.	- Initialise power/control module (refer to Section 12.4.1). - If raspberry noise made when attempting to initialize, check door switches.
NOISY FAN PC		
	* Ice around gasket.	- Replace assembly with new fan kit.
	* Wires touching.	- Tuck wires away from fan blade.
	* Faulty fan.	- Replace fan.
NOISY FAN FC		
	* Ice on cover.	- Clear ice off cover and check doors are sealing.
	* Ice on grill.	- Clear ice off grill and check doors are sealing.
	* Fan off mountings.	- Refit.
	* Wires touching.	- Tuck wires away from fan blade.
	* Capillary touching.	- Shift capillary from fan area make sure it is not touching any part of the cabinet.
	* Fan motor noisy.	- Fit replacement.
	* Wires too tight.	- Re route wiring.
ICE BUILD UP COMPARTMENT		
	* Doors not sealing.	- Check gaskets sealing, adjust gaskets. - Fit drain valve to drain tube.

16 FAULT FINDING FLOW CHART - SERVICING

- 16.1 Refrigerator Not Operating
- 16.2 No Power To Power/Control Module And/Or Display Module
- 16.3 PC/FC Warm
- 16.4 FC Too Cold – PC Too Warm
- 16.5 PC Too Cold
- 16.6 Ice/Condensation Forming
- 16.7 No Light
- 16.8 Door Switch Not Operating
- 16.9 Defrost Heater Faults
- 16.10 Compressor Faults
- 16.11 Compressor Runs Continuously
- 16.12 Compressor Will Not Run And Is Hot To Touch
- 16.13 Compressor Electrical Tests
- 16.14 Refrigeration System Faults
- 16.15 Not Dispensing Water
- 16.16 Not Producing Ice

16.1 Refrigerator Not Operating

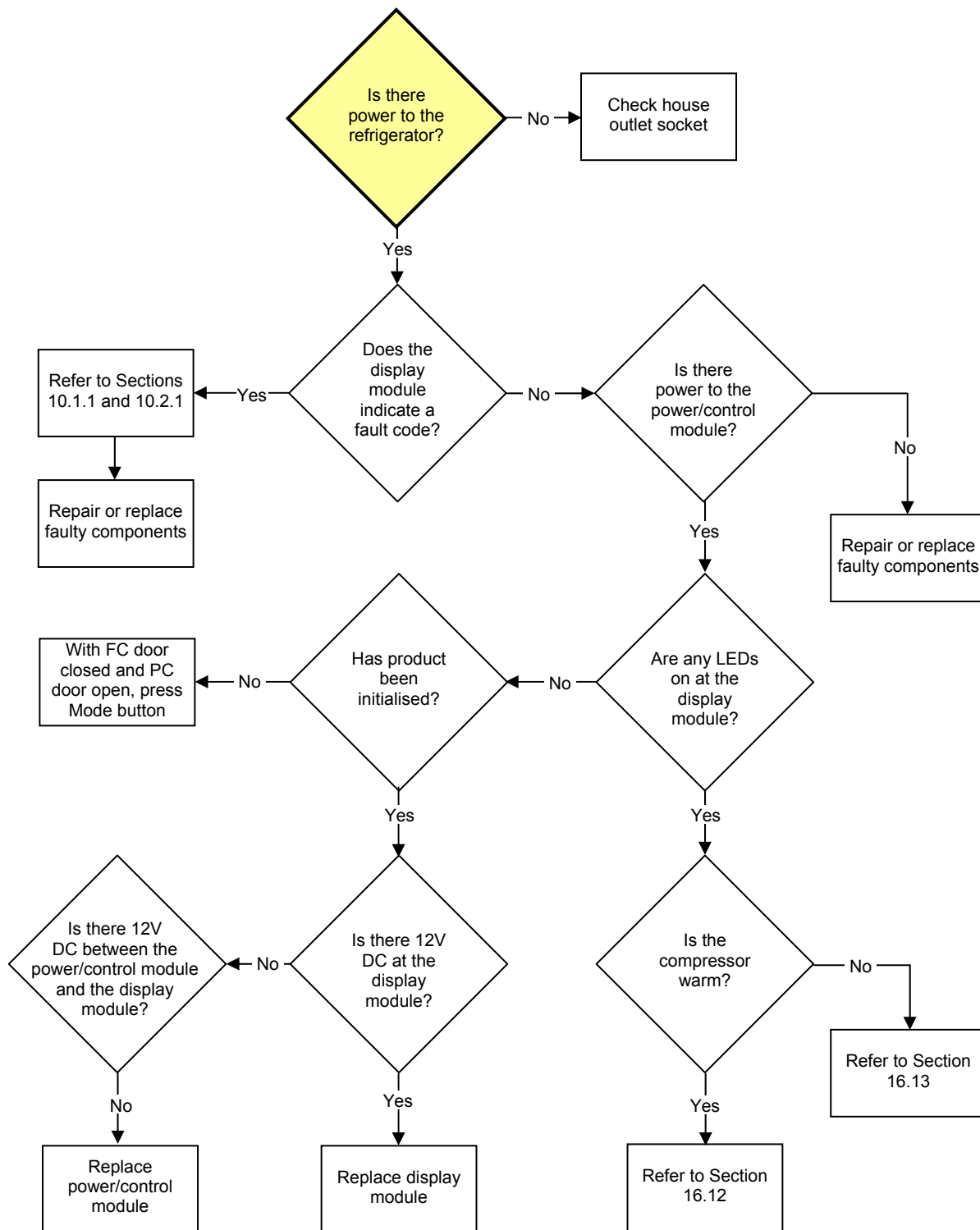

16.2 No Power To Power/Control Module And/Or Display Module

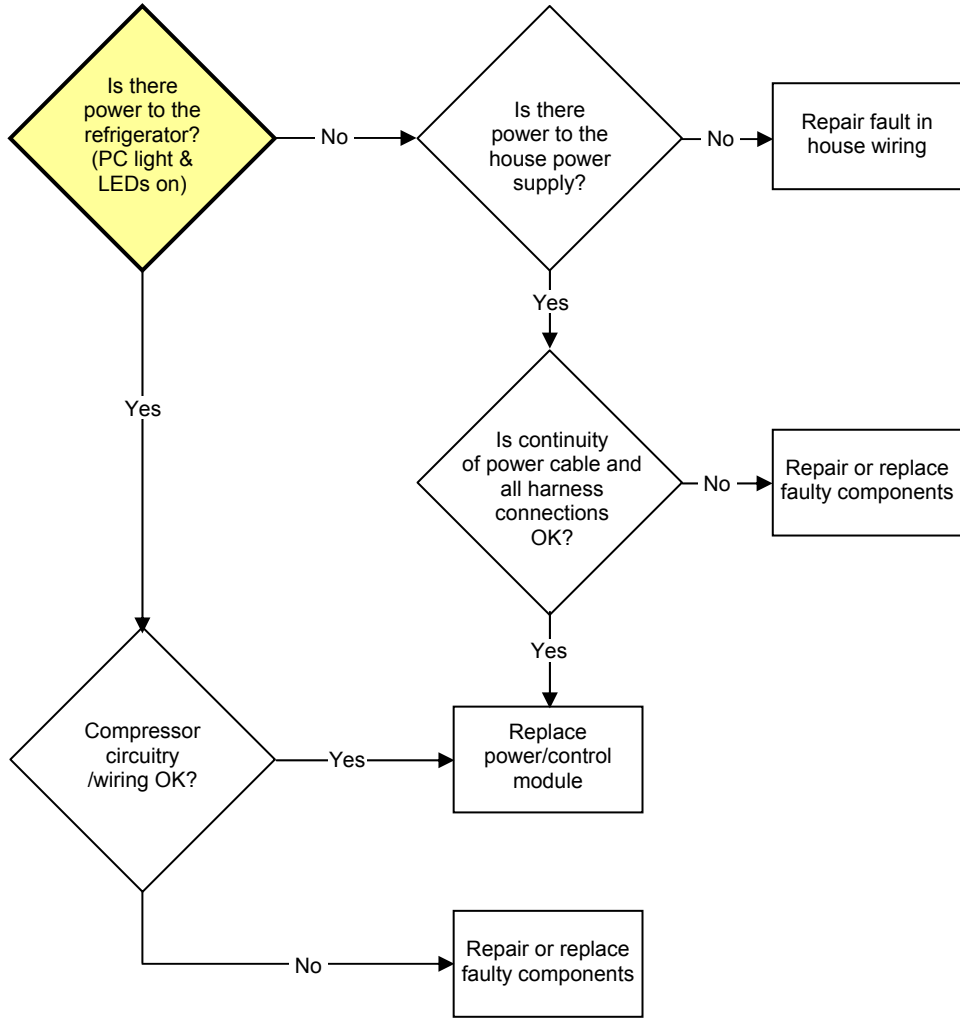

16.3 PC/FC Warm

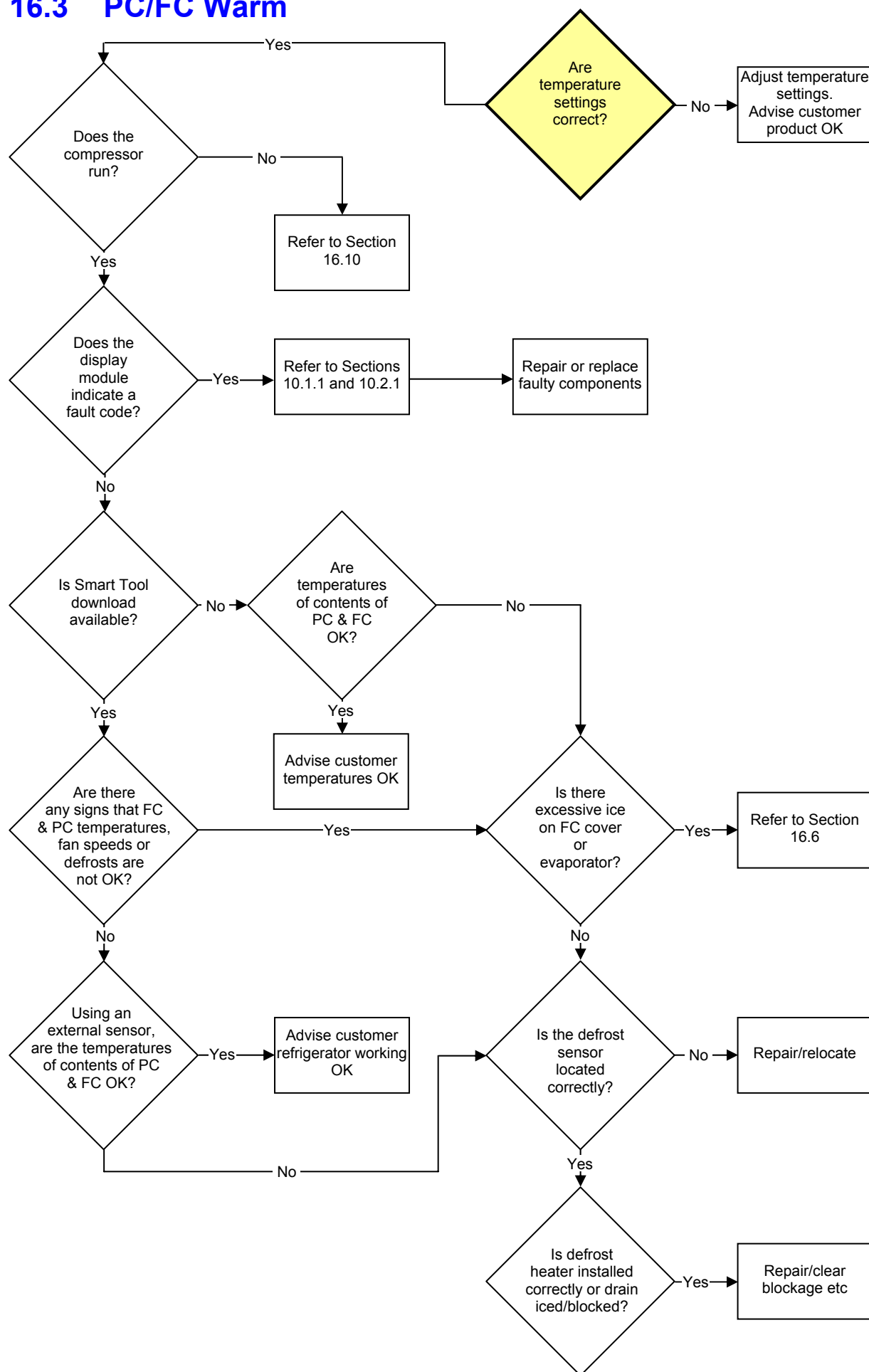

16.4 FC Too Cold – PC Too Warm

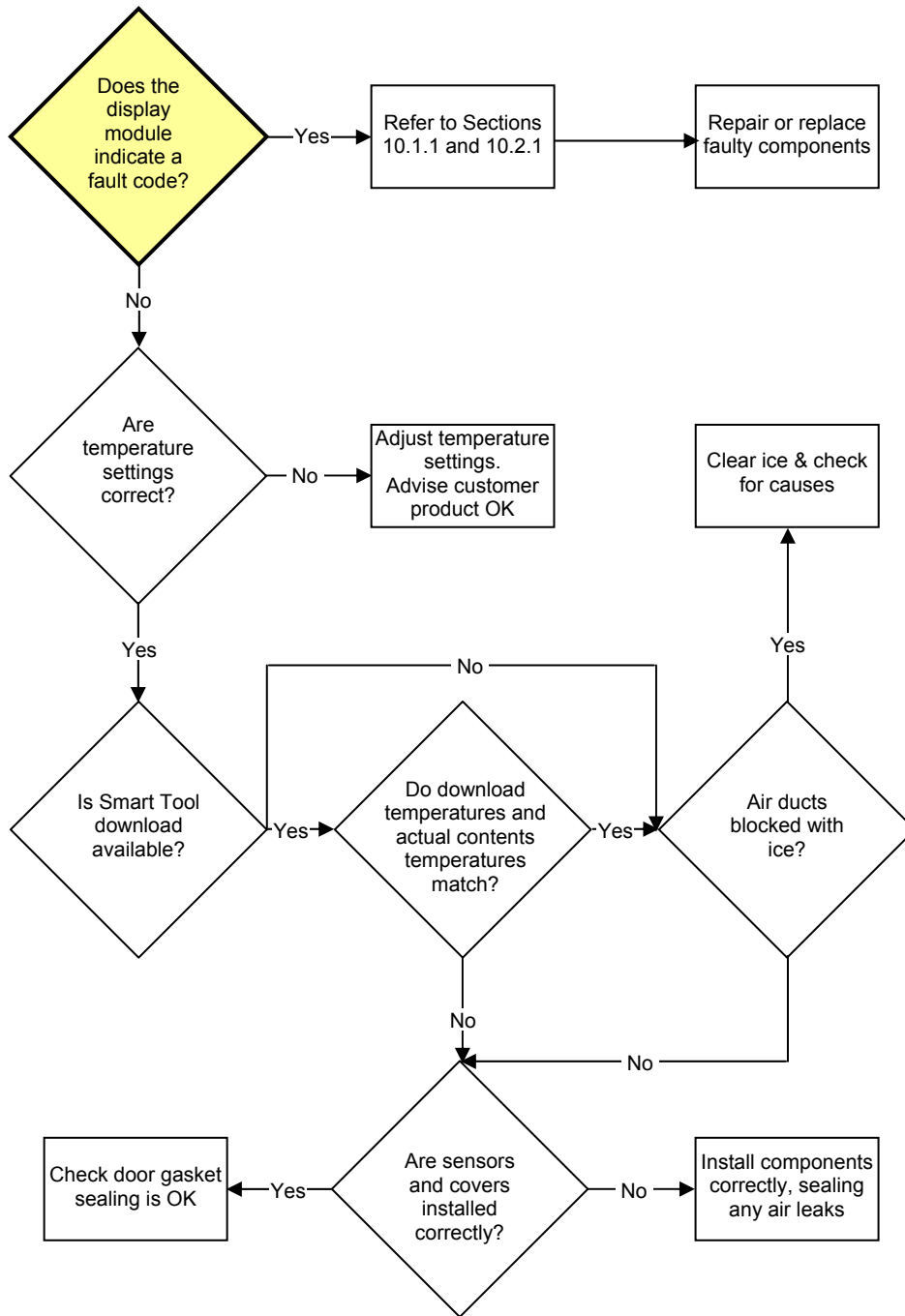

16.5 PC Too Cold

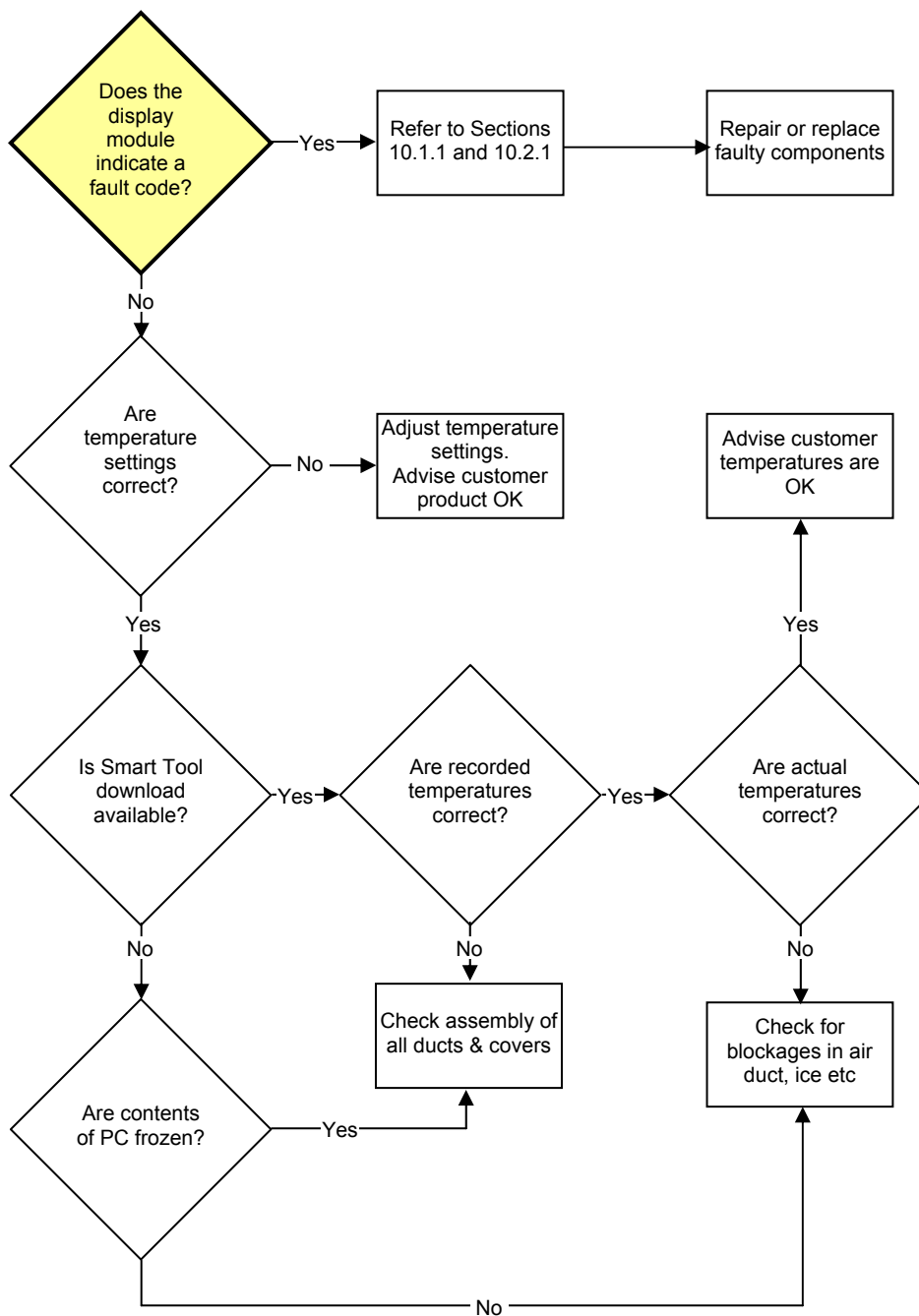

16.6 Ice/Condensation Forming

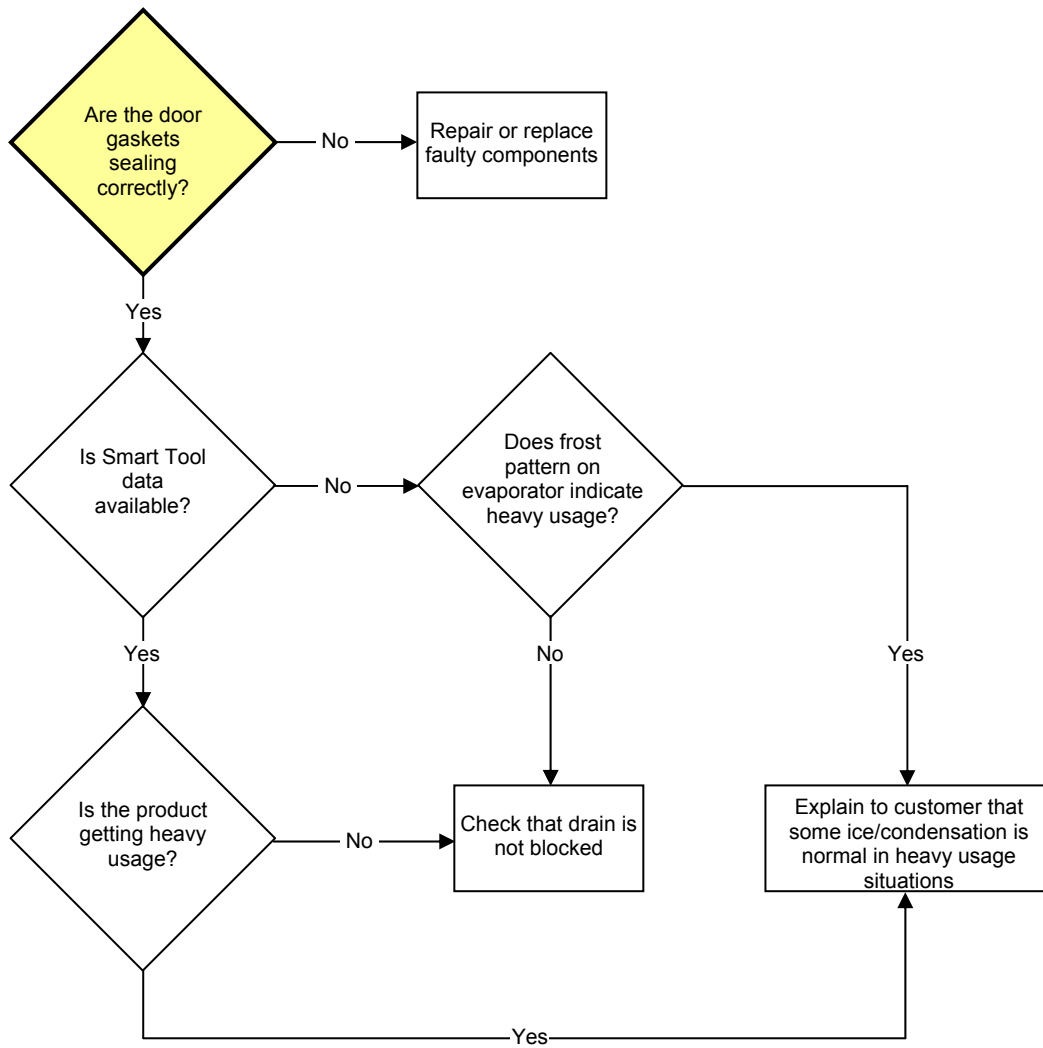

16.7 No Light

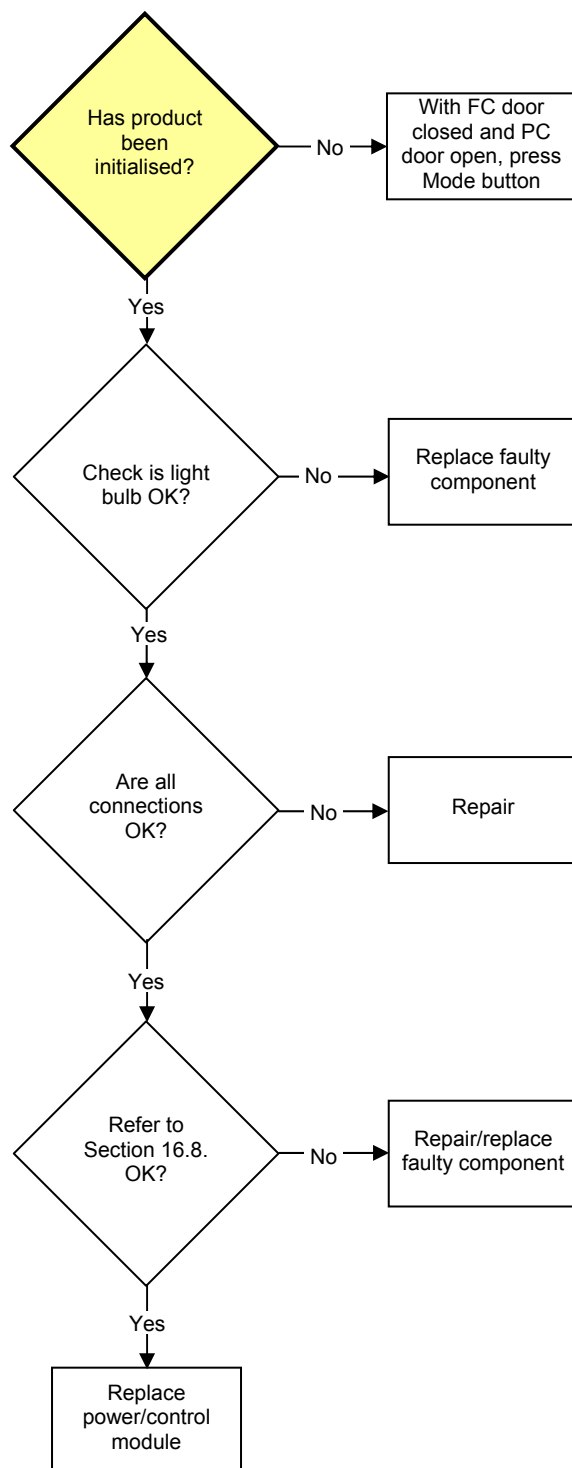

16.8 Door Switch Not Operating

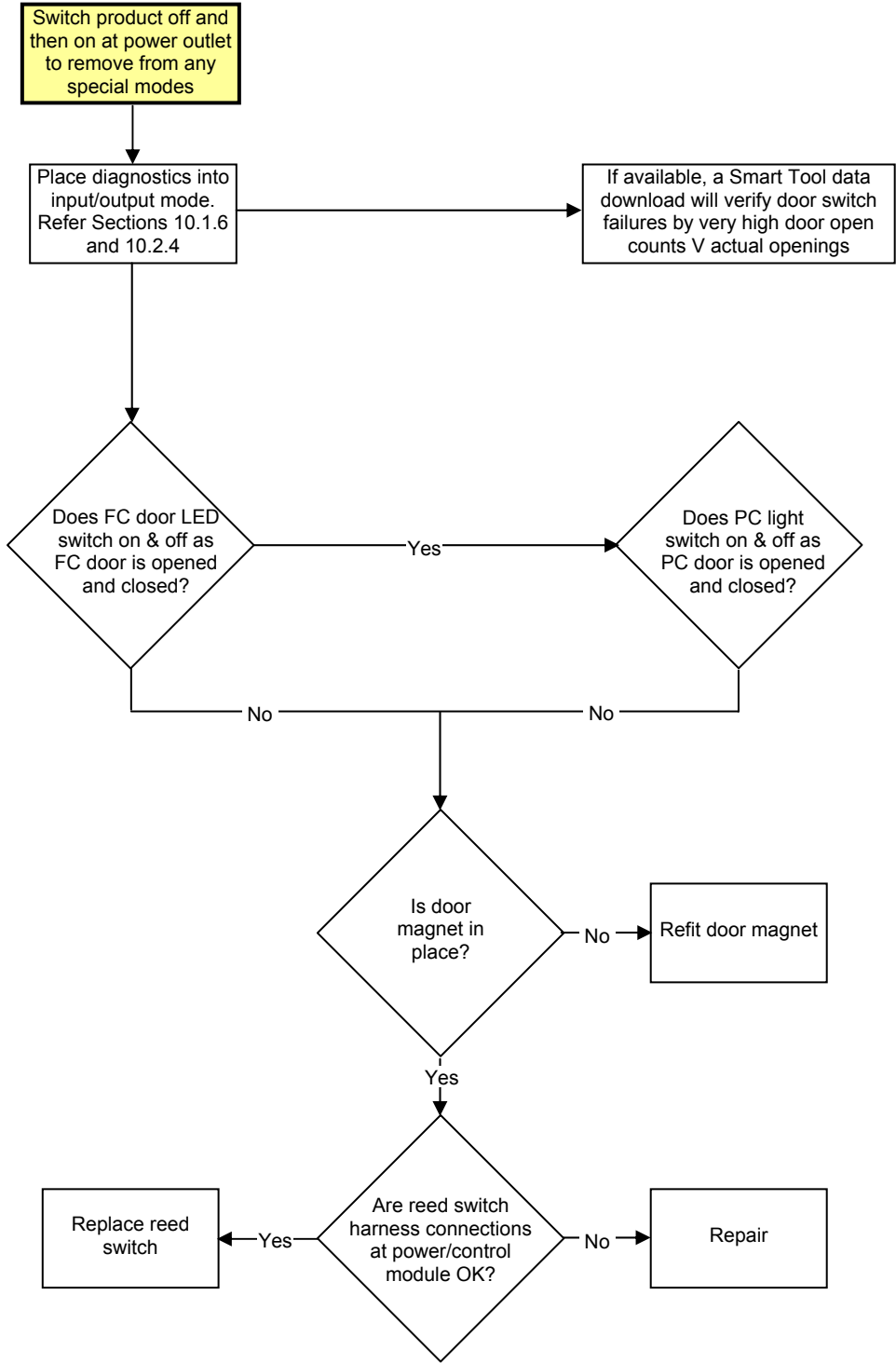

16.9 Defrost Heater Faults

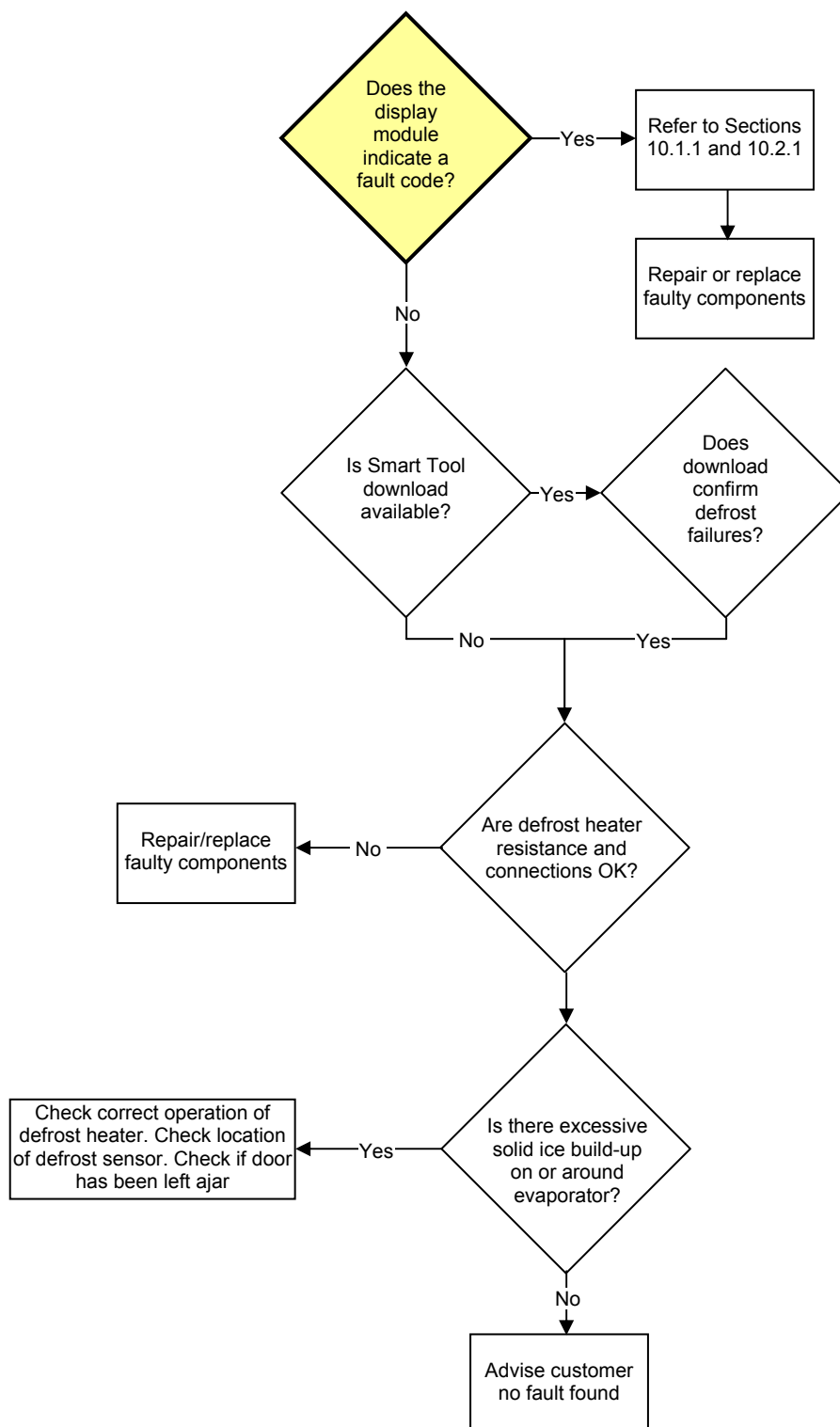

16.10 Compressor Faults

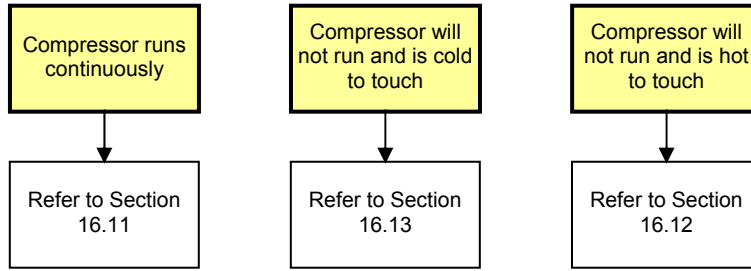

16.11 Compressor Runs Continuously

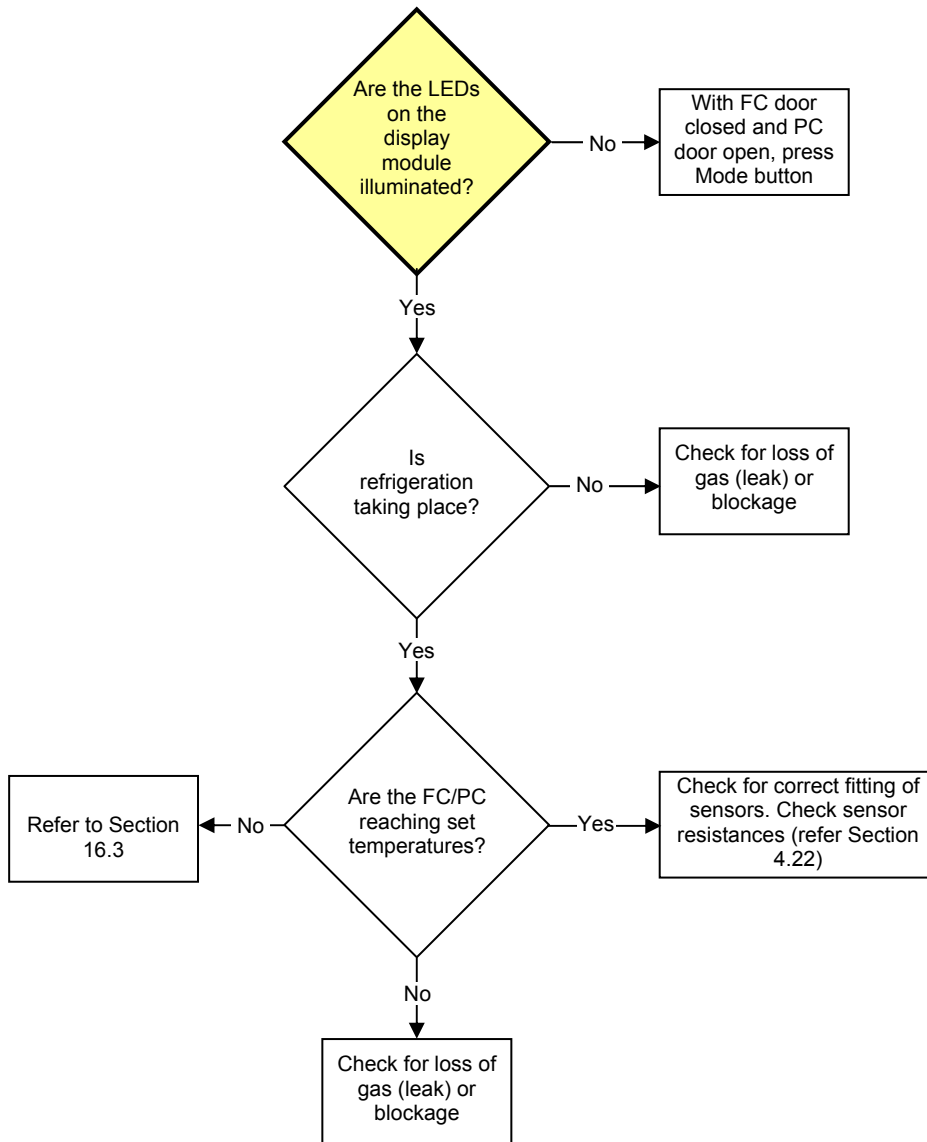

16.12 Compressor Will Not Run And Is Hot To Touch

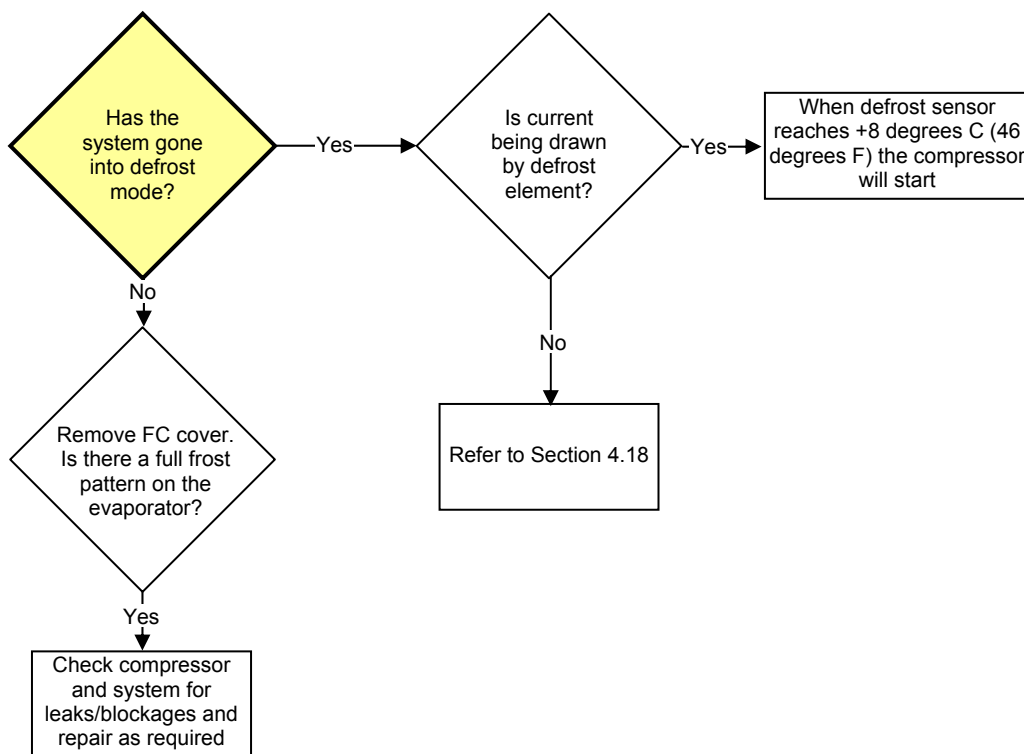

16.13 Compressor Electrical Tests

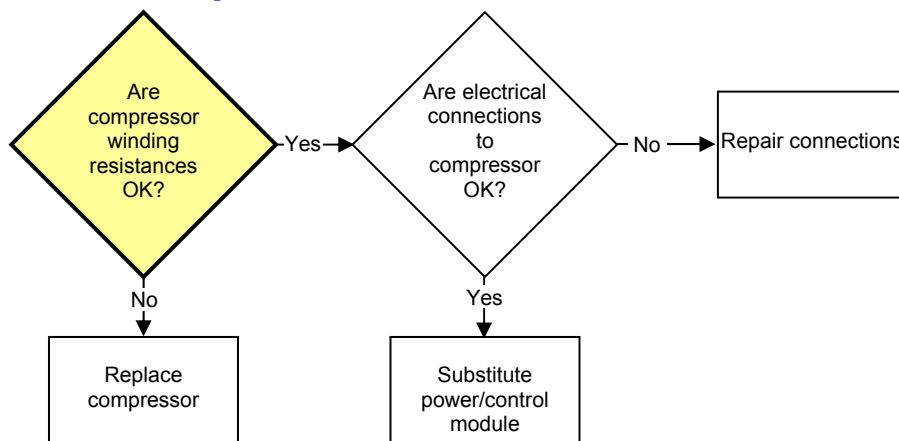

16.14 Refrigeration System Faults

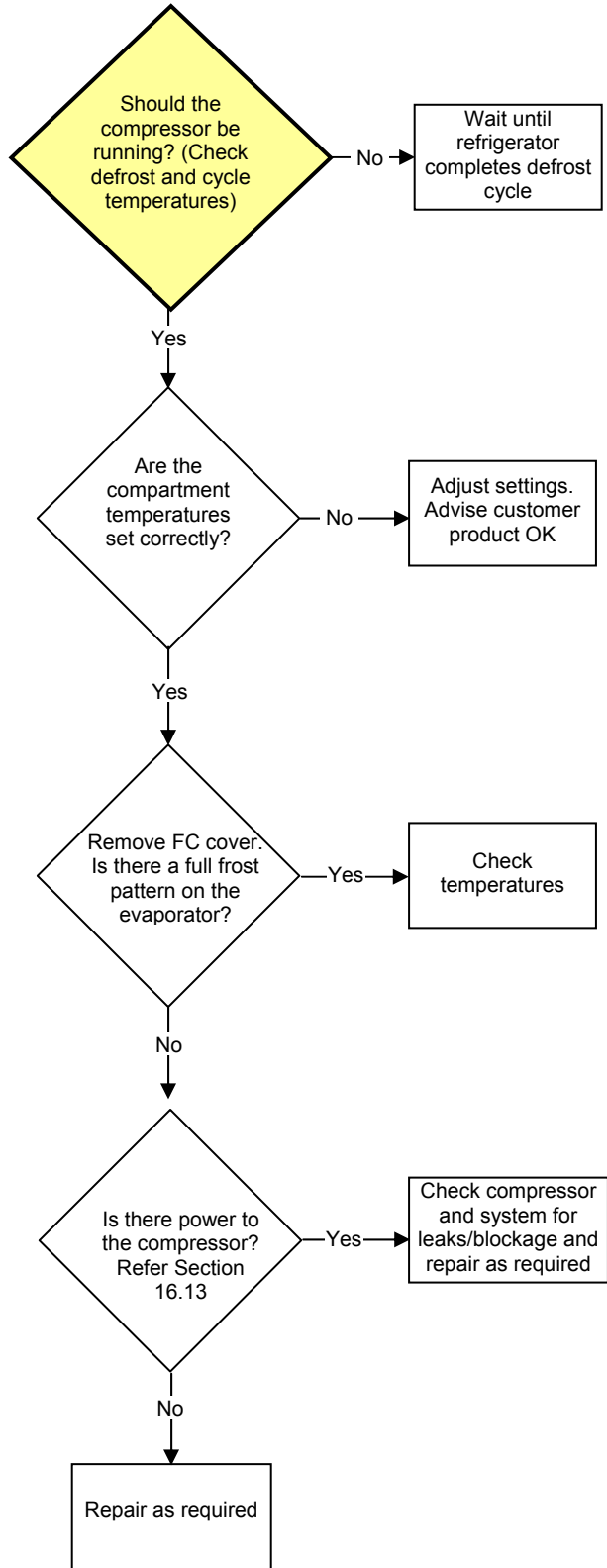

16.15 Not Dispensing Water

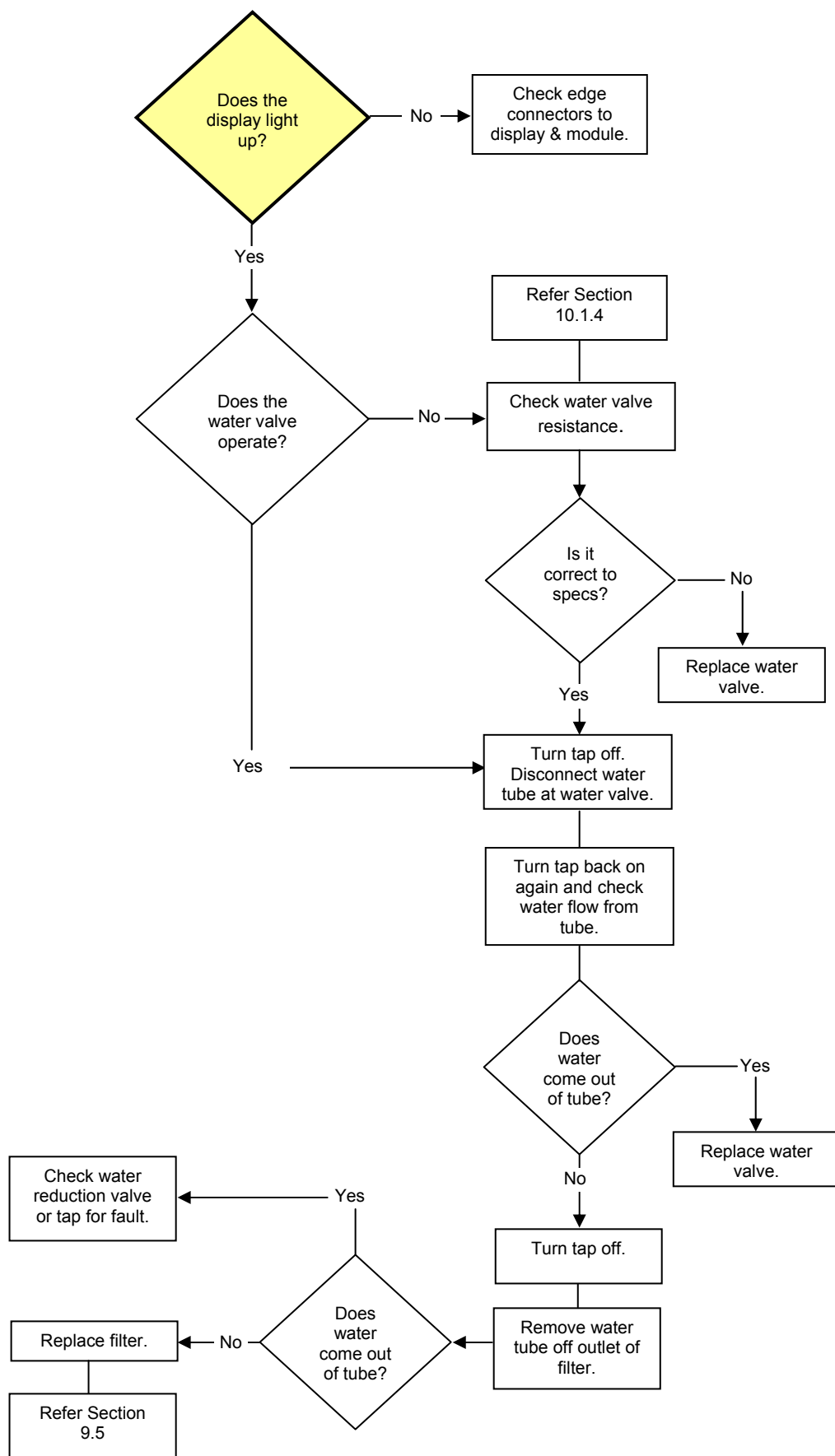

16.16 Not Producing Ice

