

Module 1

Regulations

Objectives

After you have completed this module, you will be able to:

- List some key regulations on raising chickens in your community
- Describe the reasons for a Premises Identification Number (PID)
- Access information on regulations on direct marketing of your poultry meat and eggs.





There are several regulations that impact small poultry owners. This first module introduces you to those regulations.

Local Regulations

Before you purchase any poultry, you need to understand the regulations in your own community. Not every municipality allows you to own chickens. Each municipality has its own set of guidelines and regulations.

Example Local Regulations

The City of Red Deer allows residents to keep some chickens within the city but with many rules and regulations surrounding the bylaw. The City of Edmonton is running a pilot project with a vote on a bylaw to be held later in 2015.

It is your responsibility to understand and follow the guidelines for your specific location; each city and county has different livestock regulations.



Your Local Regulations

Find out the regulations in your area. List some of the key points below.

Are chickens allowed? _____

Number of chickens? _____

Types of chickens? _____

Other key restrictions: _____

Premises Identification Number (PID)

According to the *Animal Health Act*, all poultry owners are required by law to register their home/farm with a Premises Identification Number (PID). The PID number is helpful in:

- Tracking disease
- Monitoring health safety concerns
- Locating animals in a natural disaster
- Planning an emergency response.

There is no fee for a PID; however, you must apply within 30 days of acquiring ownership of an animal (chicken).



To acquire a PID number, go to:
<http://www.agriculture.alberta.ca/premises>



Direct Marketing of Eggs and Poultry Meat

Federal and provincial laws and regulations serve producers and consumers, protecting their health and livelihoods. If you want to make your poultry products available to the public, familiarize yourself with the regulations on selling eggs and meat, as well as labeling and advertising your product. The regulations specify:

- Types of products that can be produced
- How to label products properly
- Types of farm setups that are best for both producer and consumer.

Farm Setups

There are several different types of farm setups that you can consider to make your poultry product available to the public (see Table 1-1 Farm Setups).

Table 1-1 Farm Setups

Farm Gate	Sell your product directly from your farm
Farm Store	Sell your product from a separate building located on your farm
Community Supported Agriculture (CSA)	Sell your product through a group of shareholders working together to provide for the community

Off-farm Setups

As a poultry producer, you can also sell through “off-farm setups”. These off-farm setups include farmers’ markets, shops and restaurants, and online direct orders. Once again, check regulations in your area. In Alberta, product sales at farmers’ markets must be approved by Alberta Farmers’ Markets. When you sell to businesses, shops and restaurants, you may have to meet specific handling and storage criteria.



Example Sale of Ungraded Eggs

According to Purchase and Sale of Eggs and Processed Egg Regulation, uninspected and ungraded eggs can be sold directly to consumers if they meet the following criteria:

- Clean with no visible cracks
- Cooled to a temperature of 7°C or less
- Stored at 4°C
- The words UNINSPECTED clearly visible on a carton “2 centimetres in height”
- No use of cartons that are already labeled (this is a patented design).

Supply Management System

In Canada, poultry products are controlled by a supply management system. Supply management matches the supply of poultry products to consumer demand. In this system, registered poultry producers acquire quota which allows them to produce poultry meat or eggs over a given time period.

If you choose to operate outside of the quota system, there is a limited number of birds that you are able to produce in a year. This number is set by each governing provincial body. In Alberta, the legislating bodies, Egg Farmers of Alberta and the Alberta Chicken Producers, have legislated specific numbers of chickens you may raise per year if you are operating outside of the quota system (see Table 1-2 Quota Limits in Alberta) and may also control the marketing methods for exempt products.

Table 1-2 Quota Limits in Alberta

Type	Exempt	Need Quota	Who to Contact for Quota
Egg	Less than 300 hens in possession	Over 300 hens	Egg Farmers of Alberta http://eggs.ab.ca/ 1-877-302-2344
Meat	Less than 2000 broilers produced in calendar year	Over 2000 meat birds	Alberta Chicken Producers http://www.chicken.ab.ca 1-877-822-4425



For more information on the legislation, go to:
[http://www1.agric.gov.ab.ca/\\$department/deptdocs.nsf/all/agdex14045](http://www1.agric.gov.ab.ca/$department/deptdocs.nsf/all/agdex14045)



For more information on selling poultry meat at farmers' markets, go to:
[http://www1.agric.gov.ab.ca/\\$department/deptdocs.nsf/all/agdex10326](http://www1.agric.gov.ab.ca/$department/deptdocs.nsf/all/agdex10326)



Marketing Your Eggs Outside the Quota System

If you choose to operate outside of the quota system, you need to know where you can market your products. In particular, the sale of eggs from a farm without quota needs to be carefully managed.

Example Marketing Eggs Without Quota

- Eggs from a farm without quota may need to be graded (assessed for interior quality, weight, cleanliness and shell quality) depending on where you want to sell them.
- Eggs sold at farmers' markets and at the farm gate do not need to be graded: however, if you sell eggs to a commercial establishment such as a restaurant, bakery or hotel, you must find a Canadian Food Inspection Agency (CFIA) registered grading facility and contact the Egg Farmers of Alberta for an exemption status. Once you are granted an exemption status and have paid the marketing levy on eggs, you may market eggs through an egg grading station.

Additional Requirements for Raising & Marketing Chickens

Although you may be exempt from license and quota if you produce fewer than 2000 broilers in a year, there are still some residency and marketing requirements. You must live on the land where the broilers are produced and must ensure that no more than the exempted level of chickens is raised on the same parcel of land within the calendar year. In addition, the exempted chicken must be consumed by your family or sold directly to the end consumer from one of three locations:

- Property where the chicken is raised
- Adjacent property to where the chicken is raised
- From a stall at a Farmers' Market.

Exempted chicken cannot be sold to grocery stores, meat shops or restaurants. Meat inspection laws apply and are detailed later in this guide.





Module 2

Basic Chicken Needs



Objectives

After you have completed this module, you will be able to:

- Feed different types of chickens according to their specific needs
- Avoid toxic plants and other foods dangerous for chickens
- Provide suitable water sources for your chickens
- Manage light requirements for various types of chickens and provide the required air quality and ventilation.





The first module introduced you to the regulations on raising poultry in your community and selling poultry meat and eggs. This module takes you a step further. You will examine some basic needs of chickens and how these vary depending on the type of chicken raised

There are many different types of birds that you may choose to raise. The box below describes the most common.

Type of Chickens

- Egg laying bird, also known as a laying hen
- Meat type bird, also referred to as a broiler
- Dual purpose bird that can lay eggs and be used for a small amount of meat at the end of its cycle.

All of these birds need to be managed specifically for what they are to produce.

Example Management of Different types of Birds

Laying hens need to be carefully managed for egg production, with light cycles being of critical importance. Broilers, on the other hand, need to be managed differently for meat production with nutrition being critical, and dual purpose birds require a balance between laying hen management and broiler management.

A dual purpose bird will not begin to lay until 5 months of age and will not be slaughter ready until 20 weeks of age, at the earliest. If you are raising your dual purpose bird for meat, it should be slaughtered before it starts laying eggs. If you want to raise your birds for eggs, photostimulate at 20 weeks and they should begin to lay at 22 weeks of age.

Not all heritage breeds are dual purpose. Some breeds such as the white and brown leghorn are more suited for laying eggs.

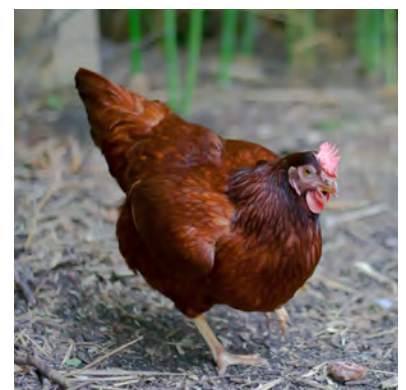

Feeding Needs of Chickens

As chickens grow, their dietary needs change, creating a need to separate their nutrition into phases – promoting the best nutrition in all stages of life for each type of bird. Similar to human development, the metabolism in chickens changes as they grow; the feed must also change to meet the nutritional requirements.

Example Different Dietary Needs of Chickens

- Chicks need a diet high in protein and energy to promote a significant amount of muscle development. During the laying phase, the right energy/protein ratio of the diet is important to keep a steady production and egg size. The increased amount of calcium in this diet plays an important role in the egg's shell quality.
- Growers need a diet that develops bones and muscles.
- Finishers need a diet that maintains body weight.
- Layers need calcium for egg development.

You need to customize what you feed to the type of chicken that you want to produce. Purchase commercial feeds from a reliable feed store to help you find the right feed for your flock. Also, consult with a poultry nutritionist to help you customize a nutrition program to address the specific needs of your flock.

If you are making a custom diet, pay attention to mixing vitamins in the feed properly, as some of it precipitates to the bottom. Many poultry producers aim for good feed conversion ratio (FCR). FCR is the amount of body mass produced from the amount of food ingested. Factors that may affect FCR can include feed type, health status and husbandry practices.

How Chickens Break Down Food

Chickens break down their food in their gizzard by ingesting grit, which helps to grind the food. Oyster shell is the most common type of soluble grit as it contains calcium which supports egg shell development. If chickens are fed scratch or whole grains, they will need grit to digest these larger particles. If you are feeding commercial mash, crumble or pellets, you will not need additional grit. Chicks should not eat grit until after their first week of life.

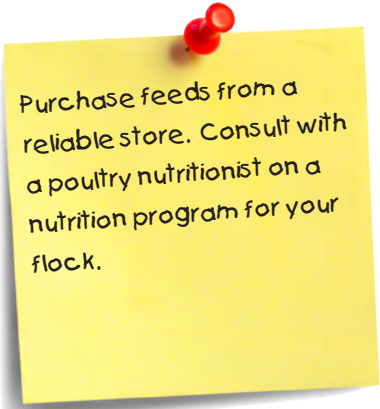

Purchase feeds from a reliable store. Consult with a poultry nutritionist on a nutrition program for your flock.



Types of Feed Forms

There are three main types of feed forms: mash, crumble and pellet as illustrated in Figure 2-1 Feed Forms.

Figure 2-1 Feed Forms



Mash (Finely Ground Feed)

Finely ground feed is less expensive than pellets but not as digestible. Since the ingredients are mixed in a mash form, the particle size is very important for this type of feed. If the particle size is too small, birds will not eat it but, if it is too large, it encourages the birds to pick the bigger particles and leave behind the other components. This may result in birds with nutrient deficiency due to the unbalanced diet.

Crumble (Medium-Sized Feed)

Crumble is made by crumbling pelleted feed. It is recommended for baby chicks for the first week or two of age.

Pellets (Large-Sized Feed)

A pellet is compressed mash. Although pellets are more expensive than mash, the rations are more digestible. During the production of pellets, the mash diet is combined with steam and forced into small holes. This heats up the matter, breaking down carbohydrates and denaturing proteins, making them more available to birds. Since everything is bound together, it ensures the birds eat a balanced diet.

A good pellet must be resistant to breaking. Good pellet diets must be uniform in shape and size and should not contain much broken particles among intact ones. This type of feed is recommended for growing and adult birds.

Pellets are recommended for growing and adult birds.



Foods Aiding Digestion

There are several types of food that help digestion in chickens as illustrated in Figure 2-2 Foods Aiding Digestion.

Grit

Grit consists of crushed limestone and granite. Grit helps the bird's gizzard grind the food. There are different sized grit particles. Chick grit is smaller, to help with easy digestion, and chicken grit is larger sized.

Scratch

Scratch is a treat consisting of different grains that are of larger particle size.

Oyster Shells

Oyster shells are generally offered free choice, for hens that are laying eggs. Oyster shells are an excellent source of calcium which aids in egg shell formation.

Figure 2-2 Foods Aiding Digestion

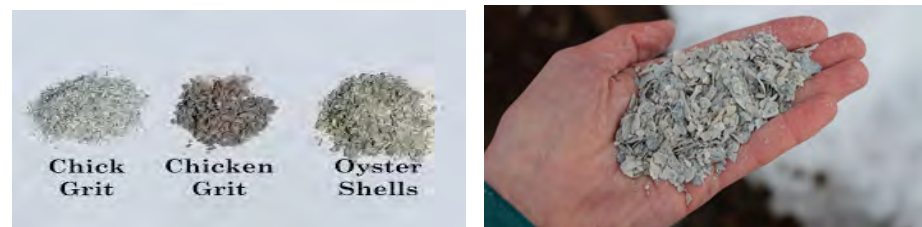

Feeding Strategies

Each chicken type needs different feeding strategies. If you raise heritage chickens, there can be a huge variation in how much each type of bird will eat. Heritage chickens generally do not over-eat as they tend to be more active than commercial breeds. Heritage chicken breeds come into lay generally 4 weeks later than commercial breeds and some breeds will not be large enough to be processed until 20 weeks of age.

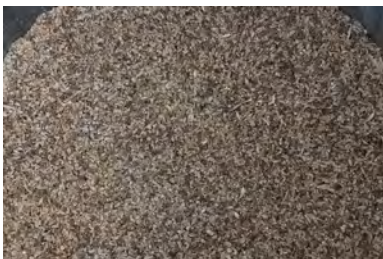

For a laying type bird, use the feeding schedule in Table 2-1 Feeding Schedule for Laying Chickens.

Table 2-1 Feeding Schedule for Laying Chickens

Age	Feed Type	Purpose
0 – 6 weeks	Starter	High protein and energy content for muscle development
6 – 19 weeks	Grower	Lower protein and same energy content for growth
20 weeks and up	Layer	Lower energy and higher protein and calcium for better egg size and shell quality

For a meat-type bird, use the feeding schedule in Table 2-2 Feeding Schedule for Meat Chickens

Table 2-2 Feeding Schedule for Meat Chickens

Age	Feed Type	Purpose
0 – 6 weeks	Starter	High protein and energy content for muscle development
6 – 13 weeks	Grower	Lower protein and same energy content for growing bird
13 – 20 weeks	Finisher	Lowers the protein level
1 month prior to consumption	Unmedicated Finisher	Prevents medication residue entering meat



Determine the Feed Needs of Your Chickens

If you have a flock or planning to have one, summarize the types of feed most appropriate for your flock and research where you might find the feed in your community. Consider both the types of feed and the protein, energy and calcium content.

Type of Chicken	Type of Feed Required	Local Feed Store and Location
_____	_____	_____
_____	_____	_____
_____	_____	_____

With the heritage breeds, there may be quite a bit of variation in size, so make sure the smallest birds are able to reach food and water.

Feed and Water Placement

As chickens grow, adjust the feeder height in order to keep it lined up with the crop (a bit above the dorsal line). If it is too high, it prevents birds from eating and, if it is too low, birds may waste feed and increase the risk of breast and leg injuries as a result of laying down for long periods while eating. The same applies for water, except that the height must be at the head level (this is to stimulate the natural way that chickens drink water by stretching their necks).

Winter Feed Rations and Water Requirements

If you house your chickens over the winter months, make sure your feed supplier can provide your feed throughout the winter. Some feed stores stock their feed for the summer but do not replenish in the winter. If you plan on keeping your birds over the winter, it may be necessary to pre-purchase your feed and store it for use over the winter.

During winter months it is important to make sure that feed is available at all times. Particularly in the cold winter months, there is an increase in energy requirement as the chickens try to stay warm. If cold, a chicken will use all its energy to keep itself warm and will not have a good feed conversion ratio. To help your chickens maintain a positive energy balance in winter, add oil to the feed to provide extra energy in the form of excess fat. This can be broken down in the chicken's body to provide the energy needed for keeping warm.

If you are supplying scratch in the winter, provide it at night after the chickens have eaten their complete diet first, allowing them to digest the scratch throughout the night. Since scratch is comprised mainly of carbohydrate, overnight digestion will turn it into easily used sugar and raise the chicken's internal temperature.

Finally, it is important to ensure that your chickens can access water throughout the winter without getting wet. Use nipple drinkers with a heated hose or heated water dishes. The desirable temperature for the water ranges from 10°C to 27° C; if the water is too cold or too warm, birds won't drink it.

If you allow your chickens access to the outdoors during the winter, keep the feed free of snow. Snow can cause feed contamination through mould, which can contribute to health problems in chickens.



Food and Plants to Avoid

This section looks at foods that should not be fed to chickens as well as plants that are toxic to chickens.

Unsuitable Table Food For Chickens

Do not feed food from the table to chickens. Much of it is toxic for chickens as described in Table 2-3 Table Food Toxic or Undesirable for Chickens.

Table 2-3 Table Food Toxic or Undesirable for Chickens





Table Food	Effect on Chickens
Nightshade Family (tomatoes, potatoes, eggplant)	<ul style="list-style-type: none">- contain toxic substance called solanine- can cause digestive and neurological problems that damage the digestive system
Salty foods	<ul style="list-style-type: none">- salt poisoning may result from an overabundance of salt
Bread	<ul style="list-style-type: none">- bread should not be fed as a major part of diet- enters the large intestine and begins to ferment because of bacteria- could create an infection
Onions (Spanish, shallot, white, garlic, pearl, red, sweet, ramp, scallion, cipollini)	<ul style="list-style-type: none">- contains a toxin called thiosulphate- can destroy red blood cells, cause jaundice, anemia or death- gives eggs an off taste
Dried or undercooked beans	<ul style="list-style-type: none">- contains a poison called hemagglutinin- disrupts the digestive cycle and causes severe pain- contains phytohemagglutinin and lectin- the lectin are toxic to chickens and lower the nutritional value of beans
Avocado: skin, pit, leaves	<ul style="list-style-type: none">- contain the toxin persin- can cause myocardial necrosis
Raw eggs, shell	<ul style="list-style-type: none">- encourages chickens to deliberately break and eat their own eggs
Candy, chocolate, sugar	<ul style="list-style-type: none">- contains toxin called methylxanthines theobromine- is poisonous to chickens
Apple seeds	<ul style="list-style-type: none">- contain trace amounts of cyanide- can lead to death

Alberta Wild Plants Toxic to Chickens

If you let your chickens have access to pastures or areas not monitored regularly, be aware of some common wild plants found in Alberta that are toxic to chickens. Check the area to ensure no poisonous plants, either wild or ornamental, are accessible. See Table 2-4 Plants Toxic to Chickens for a list of plants that could potentially damage your flock.



Table 2-4 Plants Toxic to Chickens

Name	Location in Alberta	Why it's toxic	What it looks like
Jimsonweed	Southern Alberta	Contains toxic tropane alkaloids Reduces weight gain	
Purple Cockle (<i>Agrostemma githago</i>)	Southern Alberta	Contains toxic saponin githagin which poisons the stomach. Symptoms of poisoning include diarrhea, vomiting, and shallow breathing	
Black Nightshade "potato family"	Alberta	Contains toxic glycoalkaloids If ingested in large quantities, may end in death	
False Hellebore	Eastern Alberta	Contains steroidal alkaloids which are toxic to poultry	
Death Camas	Alberta	Contains toxic alkaloids If ingested, can cause incoordination, coma and death	



Black henbane	Alberta	Contains toxic alkaloids If ingested, may end in death	
---------------	---------	---	---

Water Needs of Chickens

A chicken will normally drink double the amount of food it consumes by weight. Clean and fresh water must always be made available to your chickens. Particularly during extreme weather, summer and winter, take extra care to maintain clean and fresh water.

Types of Waterers

Water can be supplied to chickens in a variety of ways, each with some advantages and disadvantages.

Nipple Drinker

The most common system in poultry barns currently is the nipple drinker (see Figure 2-3). The nipple drinker is supplied by a central water line and allows access to water through multiple nipples along the line. Nipple drinkers provide a clean option for water and are adjustable to chicken height fairly easily. The biggest problem with nipple drinking lines is that they can be a challenge to properly clean and disinfect.

Figure 2-3 Nipple Drinker



Bell Drinking System

The bell drinking system (see Figure 2-4) is an open water system, allowing for the chickens to have easy access to water; however, it can be contaminated by litter, feed and feces more easily than the nipple drinking system. Additionally, when bumped, the bell drinking system can spill, promoting a high moisture level in the litter.

Figure 2-4 Bell Drinker



Cup Drinking System

Similar to the bell drinker, there is a cup drinking system available for household flocks. The cup system contains a similar water reservoir to the bell drinker; however, the cup drinker is often fixed to minimize water spillage.



Choose a Watering System

Indicate the pros and cons of each of the watering systems and check the one that might be best suited to your needs.

	Pros	Cons
Nipple Drinker	_____	_____
Bell Drinker	_____	_____
Cup System	_____	_____



Cleaning of Watering Systems

With any systems that have standing water, it is important to establish a routine cleaning system as bacteria grow and illnesses spread more easily in dirty water containers. Fill watering containers that do not automatically fill at least twice daily. Ensure proper cleaning at least once daily, removing any visible contaminants to maintain bird health. You may also want to consider filtering for organic matter, silt and algae, to avoid plugging lines.

If your water source is from a well or rainwater, routinely test the water to ensure it is at quality standards for your chicken. Different substances in your water supply, such as iron, can promote the growth of deadly bacteria. Also, some water sources have a higher saline content, which, when coupled with the salt in a chickens' diet, can dehydrate your chicken.

Check the water's characteristics such as colour, smell and taste as described in Table 2-5 Water Characteristics.

Table 2-5 Water Characteristics

Colour	Meaning	Smell	Meaning	Taste	Meaning
Reddish Brown	Iron	Rotten Eggs	Hydrogen Sulphide	Bitter	Ferrous and Manganese Sulphates
Blue	Copper			Salty	Salt



Calculate Water Needed for Your Flock

To calculate the water necessary for your flock, go to:
http://www.agric.gov.ab.ca/app19/calc/livestock/waterreq_dataentry1.jsp

Write down the number of gallons per year that you will need for your flock: _____



*Contact a water specialist to ensure your water is appropriate for your chickens. Edmonton: 780-427-2181 – irrigation and farm development office, Alberta Agriculture and Rural Development
Lethbridge: 403-381-5846 – water agriculture water specialist, Alberta Agriculture and Rural Development*





To purchase a water testing kit, go to:

<https://ca.idexx.com/water/water-testing-solutions.html>

Platinum Brooding <http://www.platinumbrooding.com/toolsandsensors>

Online rural water quality information tool <http://www.agric.gov.ab.ca/app84/rwqit>

Light (intensity) is measured in lux or foot-candles (10 lux = 1 foot candle).

Light Needs of Meat Bird

	1 hr	4 hr
Dark		
Light	23 hr	20 hr



Light Needs of Chickens

Two components of light that are important to a healthy flock are duration and intensity. It is crucial to use a lighting program that manages these components. The photoperiod (duration) influences the rate of sexual development including reproductive and egg production cycles. If stimulated too early, growth development problems and risk of prolapse increases. If you use an indoor lighting system, chickens will need specific light intensity to meet their age requirements. If light intensity is too high, it can increase the risk of aggression and possibly cannibalism. If light intensity is too low, it can cause a reduction in food and water intake.

Dual purpose chickens develop slower than modern commercial breeds. Generally, heritage breeds do not begin to lay eggs until 4 weeks later than commercial breeds. You need to make light adjustments if using a commercial chicken lighting program. Chickens should be stimulated (increase photoperiod) at 20 weeks of age. This means you must increase the length of light a half hour each day until the duration reaches 16 hours. By photostimulating birds at 20 weeks, you allow their frame size to mature before they start to lay eggs. If your birds are stimulated at 20 weeks of age, by 22 weeks of age, your birds should be well into production.

Before you photostimulate your birds, they must be approaching a mature weight and should also be displaying bright red combs and noticeably pinkish/reddish faces. Chickens ready for photostimulation will act flighty and be spooked more easily.

Light Needs of Dual Purpose Chickens

Dual purpose chickens can be raised either for meat or egg production. If your aim is for meat, use a broiler lighting program. If your aim is for eggs, use a broiler breeder lighting program.

Meat Bird (Broiler)

Chicks up to 3 days should have 23 hours of light and 1 hour of darkness. Chicks older than 3 days should be given 20 hours of light and 4 hours of darkness until market age (20 weeks). Provide 80 lux on enclosed houses to stimulate birds to eat on the first days of life.

Egg Bird (Broiler Breeder)

Chicks up to 3 days should have 23 hours of light and 1 hour of darkness. After the third day, diminish light one hour per day until it reaches 10 hours. To prevent cannibalism, provide no more than 10 lux on enclosed houses. At 20 weeks of age, increase lighting to half an hour a day until it reaches 14 hours. Keep the duration of daylight constant during the whole production phase. For open houses, increase the amount of light given until it reaches the longest day of the year. Provide a minimum of 30 lux on enclosed houses to avoid floor eggs. If chickens do not have enough light, they will not seek out the nest box to lay their eggs.

Air Quality Needs of Chickens

Air quality consists of several factors including humidity, dust, odour, gas levels, ventilation and temperature. You want to keep the coop dry and keep the carbon dioxide and ammonia amounts low. You should monitor for ammonia, carbon dioxide and humidity.

- Ammonia must be kept below 25 parts per million (ppm)
- Carbon dioxide should be below 3,000 ppm
- Humidity should be between 50 to 60 percent during the brooding stage.

Ventilation Needs of Chickens

Ventilation is required to minimize dust, provide fresh oxygen and decrease the amount of harmful gases. Ventilation needs to change seasonally. In summer, ventilation is needed to remove excess heat. In winter, ventilation is needed to remove ammonia and carbon dioxide. In both summer and winter, you need to manage moisture. The amount of moisture added by the birds must be removed. Some consequences of not removing enough moisture are high ammonia buildup and water-soaked litter. Both increase the chance of illness and disease for your chickens.

There are different ways you can ventilate your coop/barn.

- Natural ventilation uses natural forces such as wind and thermal buoyancy to provide fresh air in your coop/barn. This can include open window, ventilation slot, gable or louvered vents.
- Mechanical ventilation can consist of an electrical fan or wind turbine.

Regardless of the type of ventilation you use, remember to protect any openings that are exposed to the elements. You do not want snow, hail, sleet or rain entering the coop. If the roosts (where chickens sleep/perch) are too close to a ventilation opening, you risk chilling your birds.

Make sure predators cannot get into your coop.



Light Bulbs

For a list of light bulbs used in poultry operations and a comparison of light output and cost variability go to: http://www.growingforward.alberta.ca/cs/groups/growing_forward2/documents/document/bnqt/mjy0/~edisp/agucmint-264479.pdf

Note: LED lights last longer, provide sufficient amount of light and are also energy cost efficient.



See Platinum Brooders selection of meters <http://www.platinumbrooding.com/toolsandsensors>





For temperature and humidity measurement tools (infra-red thermometer, rectal thermometer, litter temperature probe), go to: <http://www.platinumbrooding.com/toolsandsensors>

Temperature Needs of Chickens

When you measure temperature, it is important to measure at chicken height and at the highest point the chicks can reach, and also at the coldest time of the night (4 am). Temperature and humidity go together, and humidity can change the temperature drastically.

When you move the chicks from the brooder into the coop/barn, make sure the pullet/growing chick is fully feathered. To lower the temperature, raise the heat source upwards and measure at chick height.

See Table 2-6 Temperature Requirements of Chickens for temperature requirements for chickens of different ages.

Table 2-6 Temperature Requirements of Chickens

Chicks	When first placed in the coop/barn, air temperatures should be approximately 32.2°C (90° F)
Growing Birds	Temperature can be reduced by about 1°C (5° F) per week
Fully Feathered	Once the bird is fully feathered, keep a steady temperature of 21.1° C (70°F)



Victory Farm, an organic egg farm, offers a video on when to move pullets (growing chickens) from the brooder into the coop: <http://victoryfarm.org/entry/movingpullets.html>

Shelter Needs of Chickens

Chickens must be provided with a shelter. The next module looks at the need for shelter, some shelter designs and sanitation and pest control of the coop/barn.



Conclusion

This module has introduced you to some of the basic needs of chickens at different stages of growth. These basic needs include feed, water, light, air quality, ventilation, temperature and housing. You were also introduced to foods and plants that can be toxic to chickens. Because housing is a bigger topic, it is covered in more depth in Module 3.

Use the following checklist to help you assess how well you are meeting the needs of your chickens.



Checklist

- I have done the Exercise on page 2-12 to determine the type of feed I need for my flock.
- I have done the Exercises on page 2-12 and 2-13 to determine the amount of water I need per year and the type of waterer suitable for my needs.
- I have checked that my source of water is suitable for chickens.
- I have determined the light needs of the chickens I raise and the ways to obtain this lighting.
- I have selected a meter to monitor for ammonia, carbon dioxide, humidity and temperature.





Module 3

Chicken House Design and Sanitation



Objectives

After you have completed this module, you will be able to:

- Choose a design for a chicken house that suits the needs of your flock
- Develop a cleaning routine for your chicken coop
- Take steps to sanitize and disinfect your chicken coop to protect both the flock and people.





The previous module looked at the basic needs of chickens, including feed, water, light, ventilation and air quality. This module continues with a more in-depth look at housing needs of the flock and looks at several different types of chicken house designs and features within these designs. You will be able to select a design that suits your needs and budget. The last part of the module looks at how to clean the chicken coop and the need to sanitize and disinfect it for the protection of your flock and family, as well as control of pests.

Chicken House Design

Shelter serves two purposes:

- Protection from predators
- Protection from environmental conditions.

Predators

Predators are not limited to but can include jays, crows, eagles, hawks, owls, foxes, rats, skunks, badgers, weasels, ferrets, fishers, martins, minks, lynxes, cougars, coyotes, wolves, black bears, grizzly bears, snakes, dogs and cats.

Environmental Conditions

During the summer months, chickens are more likely to suffer heat stress. In the winter months, chickens are more likely to suffer from illnesses derived from excess moisture, freezing conditions and increase in gases.

Position the chicken house to reduce any wind exposure. Place your windows in the coop facing south to catch more light during the winter months. If you want eggs throughout the winter months, provide an artificial light source. Ensure you build a sturdy roof that can withstand the weight of heavy winter snow.

Consider the R-value on insulation to determine what to use; some common materials are polyurethane spray foam insulation, glass wool insulation, fibreglass insulation and reflective insulation. Include a vapour layer so insulation material does not become moist or wet. Chickens will eat insulation if it is not properly covered and hidden (a plastic sheet is not enough protection).



Check with local authorities for guidelines (especially if you are in an urban setting), as they may have specific regulations on how many birds you can keep in the space you have.



Types of Chicken Coops

There are several different types of chicken coops. One is a stand-alone chicken coop without a run. It gives the birds shelter but no access to a run. If you would like to give your chickens access to the outdoors, you can build a run or a fence. Build the run or fence to separate your chickens from other outdoor wildlife (birds, cats, dogs, coyotes) and prevent chickens from escaping.

Another type of housing is an enclosed coop with access to outdoors as illustrated in Figure 3-1 Two Chicken House Designs with Outdoor Runs.

Figure 3-1 Two Chicken House Designs with Outdoor Runs



A variation on the chicken coop with an outdoor run is illustrated in Figure 3-2 Chicken Tractor (coop with wheels). With this design you have the ability to move the coop to access new grass.

Figure 3-2 Chicken Tractor (coop with wheels)



<http://poultryguide.com>



For more information on housing designs, go to:

Layer house for 300 hens:
<http://www.cps.gov.on.ca/english/po5000/po5255.htm>

Broiler barn: <http://www.cps.gov.on.ca/english/plans/E5000/5310/M-5310L.pdf>

Additional housing needs:
<http://www.ag.ndsu.edu/extension-aben/buildingplans/poultry>

<http://canadianhomesteadandpreparednesssupply.com/cackellac-chicken-tractors/>

<http://managingwholes.com/poultry-pens.htm>





Choose a Housing Design

Spend some time looking at different housing designs and the advantages and disadvantages of each. Try to look at at least three designs that might suit your needs. Keep in mind the need for protection from predators and harsh environmental conditions.

Design	Advantages	Disadvantages	Cost
1. _____ _____ _____	_____ _____ _____	_____ _____ _____	_____ _____ _____
2. _____ _____ _____	_____ _____ _____	_____ _____ _____	_____ _____ _____
3. _____ _____ _____	_____ _____ _____	_____ _____ _____	_____ _____ _____

Coop Necessities

In addition to a shelter, there are some necessary features that should accompany a coop in order for your chickens to carry out their natural behaviours. Below is a list of coop necessities.

Roosts and Perching

Roosts or perches are where the birds will sleep. Perches should not be higher than 3 feet (0.9 m) off the ground; any roost higher than that can cause injuries such as bruised feet and egg ruptures. Under the perches allow for at least 12 inches (30 cm) of clearance. Place roosts higher than nest boxes, as chickens will try to seek out the highest perch possible. Ensure that nest boxes are closed during the evening to dissuade chickens from sleeping in nesting areas at night. As birds raised for meat grow larger, generally they do not use a roost but instead will roam on the floor.

Figure 3-3 Design of the Roost or Perch



Nest Boxes

Hens prefer nesting boxes that are private, not crowded and comfortably bedded. They will lay eggs in nest boxes that are shaded or in the darker areas of the barn/coop. In a line of nesting boxes, hens tend to congregate to the nest boxes on the ends where they feel more protected. Provide one nest box per 3 to 4 birds. Use wood shavings and chopped straw for nest bedding. Avoid using cedar wood shavings and newspaper.



Floor Litter

Chickens need a dry environment. Provide 2-5 inches (5-12 cm) of absorbent litter material such as wood shavings, straw and chips to diminish the moisture content. See Figure 3-4.

Figure 3-4 Absorbent Litter



Dust Bath

Chickens will roll around in loose materials such as sand, dirt and mulch. This behaviour helps clean their feathers and remove parasites. See Figure 3-5.

Figure 3-5

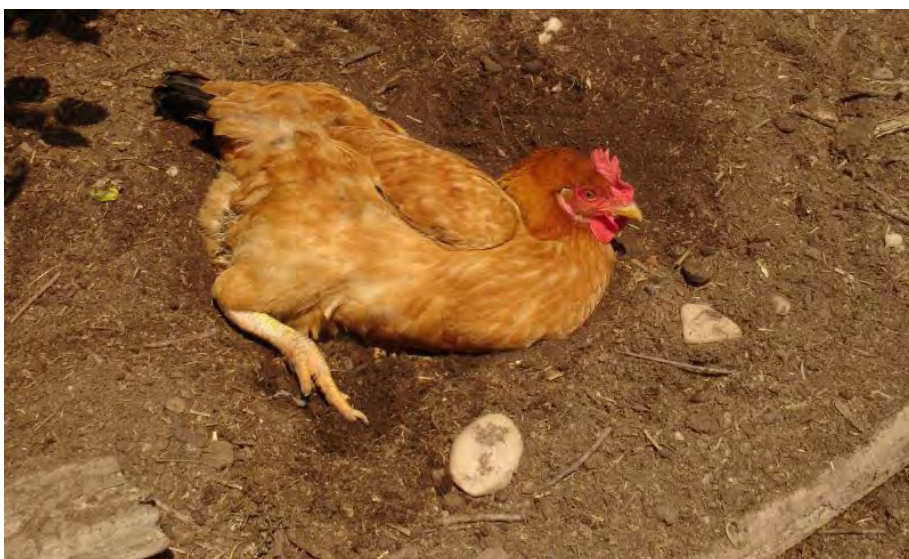

Keeping the Coop Clean

The first step to ensuring a healthy living environment for your birds is to clean the barn/coop. Soiled bedding or litter increases the ammonia and moisture levels in the poultry house. Spilled water, blown-in snow, mud tracked in from the run, fecal matter and dirty feathers can all lead to soiled litter. It is crucial to clear out bedding and wet litter, and replace it with fresh clean bedding and litter. Make sure you clean out the run, nest boxes and the floor.

Some clean up duties should be done daily, whereas others can be done on a monthly or yearly basis.

Daily Cleaning Chores

Remove soiled litter from nest boxes. Nest boxes can easily become soiled if the chickens are allowed to roost during the night. Avoid this by closing the nest boxes or have them slightly tilted to discourage hens from remaining in nest boxes over the night. Clean waterers and soiled feeders, and clean up any spilled feed.

Install a Droppings Board

If you install a droppings board underneath the roost, the board will capture the chicken manure. This will make it easier for you to clean up and observe abnormal manure droppings (see Figure 3-6 Droppings Board). This can help you detect malnutrition or disease. Remove fecal matter from the droppings board daily by using a scraper tool. Scrape the fecal matter into a bucket and remove it from the coop.

Figure 3-6 Droppings Board



Due to a large amount of dust, dirt and fecal matter, it is important to take the necessary precautions before cleaning the coop. Safety gear that can be worn includes eye goggles, coveralls, long sleeves, boots, face mask and plastic gloves.



Deep Bedding Method

One option during the winter months is to use a deep bedding method. This method adds fresh litter over top of old and allows for the litter and manure to compost underneath in order to provide warmth to the chickens. Bedding needs to be of absorbent material such as pine shavings. Turn the litter once a month to avoid caking that can lead to foot injuries.

Sanitation

Effective sanitation (cleaning) helps protect the animals in your care as well as the people around you. Sanitizing can lower pest numbers and viral and bacterial infections. The birds in your care will benefit from a clean environment.

Take the following steps to ensure effective sanitation.

Six Steps to Effective Sanitation

- Step 1** Move all birds out of the coop to a safe location. Remove barn equipment and soak it in sanitizing detergent. Rinse the detergent off with water and let dry in the sun.
- Step 2** Remove all organic material such as feathers, carcasses, manure, litter, bedding, food, dust and dirt from the walls, roosts, floors and ceilings. Do not forget to remove the nesting material from the nest boxes and any organic material found in the outdoor run. To remove organic material, use a shovel and broom. Dispose of the material according to municipal regulations.
- Step 3** Use a pressured water hose to spray the ceiling, light fixtures, walls and nest boxes. This will remove some of the ingrained dirt, dust and organic matter.
- Step 4** Put sanitizing detergent in the soap shooter nozzle and pressure wash the coop.
- Step 5** Rinse off the sanitizing detergent with water.
- Step 6** Allow for a minimum of two weeks between disinfecting the poultry house and filling it with new birds.

Try Chrisal, a probiotic cleaner that minimizes the amount of ammonia in air, eliminates biofilm, and reduces cellulitis and unwanted odours. Any probiotic cleaners used have a lag time for you to “seed the environment”. Thus these should not be used as your sole method of cleaning.

Keep the birds out of the coop for the period of time recommended on the disinfectant container.

Always allow for downtime. Downtime is the time between disinfecting the poultry house and filling it with new birds. Allow a minimum of two weeks downtime.



Disinfectants

Disinfectants use antimicrobial agents to destroy or inactivate microorganisms that may be harmful to your flock. Disinfectants are most effective after a thorough sanitation of your coop is complete. See a list of some common disinfectants in Table 3-1 Some Common Disinfectants

It is important to read and follow all directions, including how to use, disposal, expiry dates, dilution rates and exposure times. If you are using a product beyond its expiry date, it is less effective.

Table 3-1 Some Common Disinfectants

Product	Description	Effective Against
Proquat	A strong disinfectant that is used to disinfect hatcheries, poultry equipment, floors and walls	It is an effective disinfectant against Herpes simplex virus, influenza A2 and fowl laryngotracheitis.
Virkon	Oxidative disinfectant that kills up to 500 strains of bacteria and fungi	It is effective against exotic Newcastle disease, avian influenza and salmonella.
Profilm	A disinfectant that when mixed with water becomes formaldehyde	It is effective against foot and mouth disease virus, mycoplasma pneumonia and salmonella.

Pests

Pests can include anything that may damage property and livestock. Insects, rodents and predators all pose risks to your animal feed, chickens, housing units and your own health. Pests can carry disease, injure and kill birds, as well as contaminate and consume animal feed.

Control rodent pests with traps (see Figure 3-7 Mouse Trap) and poisons.

Figure 3-7 Mouse Trap



Use the following checklist to ensure you control any pests.

Pest Control Checklist

- If trees are located near the poultry house, remove low hanging branches, clear away fallen leaves and prune branches 3-4 feet (1 m) from the rooftop.
- Keep barns and coops free of cracks that can let in unwanted visitors such as insects, rodents and birds.
- Close off any entry points (pipes, cracks in walls and foundation, ventilation slats).
- Clean up any feed spills or broken eggs. Remove and properly dispose of any dead animals.
- Remove materials and clutter (plywood, old feed containers and old fencing) from poultry coop/barn to decrease available hiding and nesting areas.
- Control rodent population with traps and poisons.



Available at Peavey Mart: Debantic (2 kg) - Protection against pests such as flies, darling beetles, lice, mites and fowl ticks
http://farmersshowcase.com/wpcontent/uploads/2015/01/BNYBANF45495_Debantic_50WP_TechSheet_Eng_FINAL.pdf

Conclusion

You should now have the tools to choose a housing design and coop necessities that fit the needs of your poultry flock. Keep in mind the need for proper sanitation and pest control in order to keep your flock and the people who work around the flock healthy.

In Module 4, you start to look at egg management, including techniques for achieving quality eggs, coop requirements for quality eggs, egg handling and washing and health advice on prolapse.

Use the following checklist to help you determine what you have done and what you still need to do.



Checklist

- I have researched several housing designs for chicken and made some decisions on what best fits my poultry flock.
- I understand the importance of sanitation and the six step process for effectively completing the task.
- I have included steps to control pests.





Module 4

Egg Management



Objectives

After you have completed this module, you will be able to:

- Reduce undesirable laying behaviors of your chickens
- Design a lighting program that allows hens to come into and stay in lay
- Train your chickens to use the nest boxes for laying their eggs
- Properly handle eggs to maintain quality and safety.





In Module 3, you looked at housing for your flock and some of the requirements to make it safe and healthy for the flock and those caring for the birds. In this module you focus on creating conditions that provide for optimal egg production and quality.

In order to have quality eggs, you need to follow sound management techniques. Included in this section are coop necessities for egg layers, an egg handling and washing guide, as well as health advice for a condition called prolapse.

Undesirable Behaviours of Laying Hens

At approximately 22 weeks of age, a dual purpose hen begins to lay eggs. The key is to train her where to lay her eggs before she begins. Chickens are flock-minded and will copy whoever lays first and lay their eggs in the same place. If a chicken of the flock disappears to a quiet dark place (that is not a nesting box) and remains there, there is a high chance that she is attempting to lay an egg. Correct her behaviour and move her to the nest box immediately.

Another behaviour that needs to be corrected is one where a chicken eats her own eggs. Once a chicken tastes a raw egg, it is nearly impossible to stop her from breaking her own eggs. To prevent the behaviour, collect eggs 3 times daily. During hot and cold weather, collect eggs more frequently.

Lighting

Egg laying hens take approximately 5 to 6 months from hatch before they are ready to lay eggs. To bring chickens properly into lay, as a small flock producer, you must pay attention to several things.

- First, ensure the weight of the bird is approaching that of a fully grown chicken (3-4 lb. or 1.4-1.8 kg for a hen).
- Secondly, pay attention to the amount of light available to the hen.

Chickens come into puberty by being photostimulated. Photostimulation most often occurs during the spring when the daylight hours get longer. Chicken producers have found that lighting inside a barn can also induce photostimulation in places where light cycles change. In Alberta, in particular, lighting in your barns during the winter becomes essential to keeping your birds in a lay cycle.

Training your chickens to use nest boxes is covered in more detail later in this module.

Module 5 focuses on other undesirable behaviours of chickens.



While increasing the light by 30 minutes does bring the hens into sexual maturity earlier, those that are brought into lay slower (with the 15 minutes of additional light per week) are found to stay in lay longer. In the end, both systems were found to have the equivalent number of eggs laid per cycle.

Recommended Step-up Lighting Program

- Start with 8 hours of light initially. This is the maximum amount of light your chickens should receive until they are at least 16 weeks of age.
- Once chickens have reached 16 weeks of age, increase the length of the day by 15 to 30 minutes per week until they have reached 14 to 17 hours of light per day.



Create a Lighting Schedule

Based on the guidelines above and using a calendar, create a schedule for increasing the length of light until the recommendation of 14 to 17 hours per day is reached. Indicate the age of your birds when this recommendation is reached. Note that your birds should be 5 to 6 months old.

Nest Boxes

Until your chickens have reached laying age, do not allow them access to the nest box. If they have access to the nest box, they view the box as another area to soil instead of an area to lay eggs. Once you have started lighting the birds, allow them access to the nest boxes during the times that the light is on, but do not allow access during the night.

As discussed earlier, if you provide appropriately sized nest boxes filled with comfortable bedding, it encourages the birds to lay their eggs in a cleaner environment. Provide 1 nest box for every 3 to 4 hens. Nest boxes should be big enough for hens to stand up in as well as be able to turn around (see Figure 4-1 Nest Box Size).



Figure 4-1 Nest Box Size

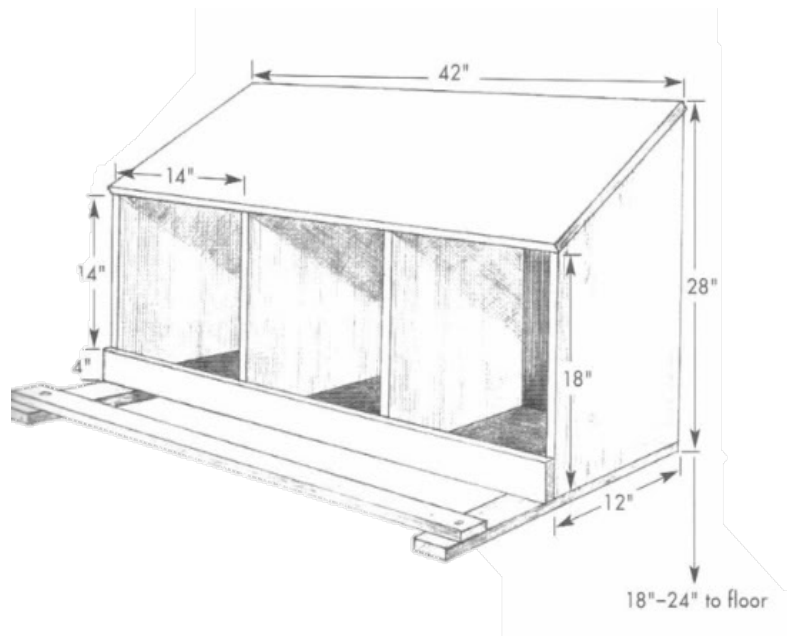

Particularly when your birds are going through puberty and learning to lay eggs, it is important to train them to lay their eggs in a clean area. To train your birds to use the nest boxes, there are several key things you can do to encourage them to lay eggs in the nest boxes.

Train Your Birds to Use Nest Boxes

- Walk your barns frequently during the first weeks of lay. Pick up any eggs that are found on the floor immediately.
- Place a golf ball in each of the available nest boxes to encourage "mimicking" behaviour.
- Ensure that the floor area of your coop has no shady areas.
- If you catch a hen displaying laying behaviors (seeking dark corners, pacing), place her in a nest box.
- Once your birds are nest box trained, pick up eggs in your coop at least twice a day.

If you remove eggs frequently, you reduce the broody behaviour expressed by your chickens and you reduce the level of bacteria exposure by the eggs.



Proper Egg Handling Techniques

Eggs that are used for human consumption (also known as table eggs) need to be handled properly to reduce the potential for bacterial contamination. This contamination can occur from either vertical or horizontal transmission as illustrated in Figure 4-2 Bacterial Contamination of Eggs.

Figure 4-2 Bacterial Contamination of Eggs

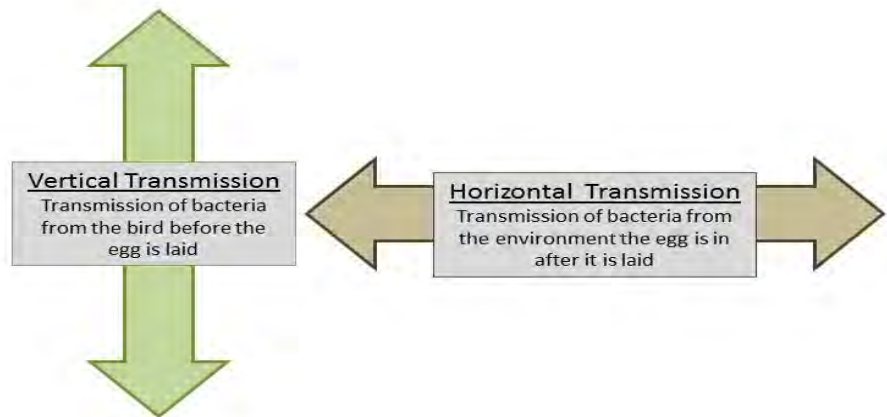

You can reduce horizontal transmission of bacteria by proper egg handling techniques and proper environment.

While it is difficult to influence the vertical transmission, you can dramatically reduce horizontal transmission by providing a proper environment and using proper egg handling techniques.

Proper egg handling not only reduces the bacterial load, it also promotes food safety. Egg shells are not a solid surface. Instead, they have microscopic openings called pores to allow for the exchange of gasses and moisture. While these pores are important for the eggs, proper handling of eggs is crucial to keep these pores clean. Eggs can become dirty from fecal matter, broken egg yolk, shavings and feathers.

At times, you may find a little bit of blood on an egg, especially when the birds are coming into lay. This indicates that a hen has laid an egg that was slightly too big for her. When you see blood on an egg, visually examine the bird for a prolapse.



Prolapse in Chickens

Prolapse is when a hen's oviduct becomes exposed on the exterior of the body. This can become a serious condition if left untreated. See Figure 4-3 Treating Prolapse in Chickens for information on identifying and treating prolapse.

Figure 4-3 Treating Prolapse in Chickens

Prolapse in Chickens



When laying an egg it is normal for some tissues to become exposed.

However, sometimes there are complications with laying an egg and a prolapse occurs. There are several different types of prolapse.



Oviductal

Oviductal prolapse:

Call the Vet immediately.



Uterine



Cloacal

Uterine and Cloacal Prolapse:
Keep tissue moist. Remove the swelling using a light dusting of sugar on exposed tissues. Once swelling reduced, you can try to reinsert tissue using water based k y jelly and gently re-insert tissue with the help of a q-tip. If you encounter resistance, do not force! Call your vet.

You can treat some types of prolapse yourself while others require a veterinarian.





With a pencil indicate on the shell the day that each egg was picked (table eggs are generally good for 6 weeks) so that you do not keep eggs past their expiry date.

“Residual clean” means that even after you have cleaned an egg it will maintain its level of cleanliness for a time.

Egg Wash can be purchased through United Farmers of Alberta (UFA), Peavey Mart and most agriculture supply stores.



Collecting Eggs

When you collect your eggs, take two different buckets into your coop. Use one bucket for clean eggs (ones without visible soiling) and another bucket for dirty eggs. By keeping your eggs separate, you reduce the chance that a dirty egg will spread its dirt onto a clean egg. Make sure you wash your hands before you pick up your eggs to avoid contamination from your hands.

Washing Eggs

Once you have collected your eggs, take your eggs to a separate location with an available sink. Because you will potentially be dealing with fecal matter, locate the sink away from food preparation areas.

Visibly Clean Eggs

Because visibly clean eggs still contain the potential to harbour bacteria, gently clean them with Clorox wipes prior to refrigeration. You can use one Clorox wipe for every five eggs and safely maintain the same level of cleanliness. Using Clorox wipes provides a “residual clean” that will promote the greatest degree of food safety. The Clorox wipes and egg wash both contain chemicals that will continue to work even after the eggs have been removed from the solution or wipes. The Clorox wipes reduce the amount of bacteria on the shell.

Visibly Dirty Eggs

With eggs that have a visible amount of dirt on them (less than the size of a quarter), wash the eggs with hot water (above 41°C) and a special egg soap called “Egg Wash”.

Avoid using other cleaners (like dish soap) as they do not clean eggs properly. Once washed, to ensure a residual clean that will promote the greatest degree of food safety, wash eggs with a Clorox wipe, using the ratio of one wipe to every five washed eggs to maintain the highest level of cleanliness.

Discard for eggs with dirt spots greater than the size of a quarter, as they have potential for high bacterial counts. To avoid eggs that are very dirty, maintain a high level of cleanliness in your coop and train your birds to use the well bedded nest boxes. Keep misshapen, dirty and cracked eggs separate from clean eggs.

Refrigerating and Cooking Eggs

Once the eggs are cleaned, place them in the fridge but avoid storing them with strong smelling food such as onions which can alter the taste of the eggs. Consume eggs safely, following recommended cooking guidelines.

Conclusion

This module has provided you with some guidelines for maintaining quality and safety of your eggs through proper handling during collecting and washing of the eggs. You have also examined how to provide light and nest boxes that promote optimal laying conditions for chickens.

The next module is a short one and deals with both appropriate and inappropriate chicken behaviour.

Use the following checklist to assess your egg management practices.



Checklist

- I have nest boxes that are an appropriate size for my chickens.
- I understand the importance of light stimulation for laying hens.
- I can recognize inappropriate laying behaviour and take actions to correct it.
- I can recognize and deal with prolapse in chickens.
- I have a system for collecting, washing and storing eggs to ensure quality and safety.



See the following website for cooking guidelines:
<http://www.eggs.ca>





Module 5



Appropriate / Inappropriate Behaviours in Chickens

Objectives

After you have completed this module, you will be able to:

- Describe appropriate behaviors in chickens
- Recognize inappropriate behaviours in chickens and take steps to prevent these behaviours.





In Module 4, you focused on how to manage your flock to produce quality and safe eggs. In this module, you start to look at the health of your flock by examining appropriate and inappropriate behaviours of chickens.

You must be able to recognize appropriate and inappropriate behaviour in chickens. This can help you recognize an unhealthy or unsuitable bird in your flock. To observe any problematic behaviours, try sitting on a chair in your chicken coop for short observation periods throughout the week.



Below are two charts that can help you determine some appropriate and inappropriate behaviours in your flock.

Chickens have three types of feather pecking: gentle, aggressive and severe. The first is appropriate while the second two are not.

Pecking Behaviour



Chickens explore their surroundings by pecking. Although pecking is appropriate behaviour, it can lead to the ingestion of foreign materials. Foreign materials could include bits of plastic from children and pet toys, paint chips and yard decorative materials. An accumulation of such materials can build up in their digestive tract or lodge in their gizzard. This could lead to choking and eventually death, reduced feed conversion and possibly a nutrient deficiency.

Appropriate Chicken Behaviours

Behaviour	Reasons for Behaviour
<p>Foraging</p> 	<p>Foraging behaviour is displayed by ground scratching and/or pecking. A chicken will perform these behaviours regardless of what is in the environment.</p>
<p>Nesting</p> 	<p>Nesting behaviour is displayed when hens search for a covered nest; hens want to feel secluded and hidden. Provide 1 nest box to every 3 to 4 birds. Nesting is considered a behaviour need in poultry.</p>







<p>Gentle Pecking</p> 	<p>Chickens gently peck each other's feathers as an allogrooming or exploratory behaviour. Pecking is also used as a form of communication between birds.</p>
<p>Preening</p> 	<p>Chickens clean themselves by inspecting their feathers and rubbing oil from their preen gland onto their feathers. They also rearrange their feathers and make sure each one is securely fastened.</p>
<p>Dust-bathing</p> 	<p>Dust-bathing is a social behaviour that both cleans feathers and aids in parasite removal. It is believed to be comfort behaviour in poultry.</p>
<p>Perching</p> 	<p>Perching is displayed when birds rest on anything that removes them off the floor or litter. The higher a bird perches, the more it is trying to get away from the other birds. Perches may act as a way to decrease aggression in the flock.</p>
<p>Roosting</p> 	<p>Roosting refers to behaviour where the bird rests or sleeps on branches or wooden beams higher than the ground.</p>

<p>Moulting</p> 	<p>Moulting in older laying hens rejuvenates the productive tissues which allow them to get ready for the next production cycle. Chickens will lose their feathers, replenish their skeletal calcium stores and regrow their reproductive tracts. It takes extra energy and protein for the birds to regrow their feathers. When moulting, chickens cease to lay eggs.</p>
<p>Aggression</p> 	<p>Chickens can display aggressive behaviour towards new birds in the flock. If you are introducing new birds to your flock, quarantine them for 30 days, in an area that is visible to the current flock. When you allow the birds to mix, monitor the birds 3 times a day to ensure the safety and welfare of your flock.</p>

Inappropriate Chicken Behaviours

Behaviour	Causes	Prevention
<p>Aggressive feather pecking is displayed when a chicken pecks at another chicken's head or neck which can draw blood or induce bad bruising.</p> 	<ul style="list-style-type: none"> • Overcrowding • Inadequate number of nest boxes • Hunger • Too much light • Overheating • Not enough stimuli • Flocks of different ages and colours grouped together 	<ul style="list-style-type: none"> • Ensure required space • Add outdoor runs, more roosts and nest boxes (1 box to every 4 hens) • Ensure correct feed and lighting program for your flock

<p>Severe feather pecking is when a hen actually grasps and pulls on the feather.</p> 	<ul style="list-style-type: none"> • Redirected foraging behaviour 	<ul style="list-style-type: none"> • Check temperature to see if birds too hot or too cold • Provide forage areas and enrichment toys to prevent boredom
<p>Repetitive pecking is displayed as obsessive pecking at empty feeders, water containers and walls.</p> 	<ul style="list-style-type: none"> • Hunger • Too much light • Not enough stimuli 	<ul style="list-style-type: none"> • Ensure correct feed and lighting program for your flock • Provide forage areas and enrichment toys to prevent boredom
<p>Setting/ brooding is when a chicken refuses to leave the nest box, saves her eggs and refuses to lay anymore.</p> 	<ul style="list-style-type: none"> • When a hen goes "broody" it means she wants to try to hatch a clutch of eggs 	<ul style="list-style-type: none"> • Purchase fewer broody breeds. • Move her out of the nesting box and monitor her closely. • Make sure she is eating and drinking. If she refuses to leave the nest box, separate her from the flock and nest, place her in an area where the flock can still see her. Give her water and food and, after a week, reintroduce her to the flock. Repeat if happens again.

<p>Lacking energy is displayed when the tail is droopy, eyes are sleepy, wings are droopy and there is a messy bum.</p> 	<ul style="list-style-type: none"> • Disease • Temperature is too hot. <p>Sick chickens will isolate themselves from the group</p>	<ul style="list-style-type: none"> • Correct any management problems such as temperature or nutrient deficiencies. • Call veterinarian if you suspect a disease.
<p>Refusal to eat or drink</p> 	<ul style="list-style-type: none"> • Could be a sign of disease so observe closely. <p>Sick chickens will isolate themselves from the group</p>	<ul style="list-style-type: none"> • Call a veterinarian if you suspect a disease. If the disease is a provincially reportable or notifiable you must report to the Office of the Chief Provincial Veterinarian within 24 hours at 780-427-3448 (M-F, 8:15 am to 4:30 pm) and at 1-800-524-0051 (after business hours)

For a list of Provincially Reportable and Notifiable Diseases, go to:

[www1.agric.gov.ab.ca/\\$department/deptdocs.nsf/all/cpv12455#report](http://www1.agric.gov.ab.ca/$department/deptdocs.nsf/all/cpv12455#report)

[www1.agric.gov.ab.ca/\\$Department/deptdocs.nsf/all/cpv12455/\\$FILE/rand_vet_card_june_2011.pdf](http://www1.agric.gov.ab.ca/$Department/deptdocs.nsf/all/cpv12455/$FILE/rand_vet_card_june_2011.pdf)



Chicken Behaviour

Check your understanding of chicken behaviour by indicating whether the following behaviours are appropriate or inappropriate. Indicate the reason for the behaviour. If the behaviour is inappropriate, indicate how to prevent it.

Behaviour	Appropriate		Reason	Prevention
	Yes	No		
Obsessive pecking				
Moulting				
Rolling in the dust				
Refusal to leave nest box				
Ground scratching				
Aggression				

Conclusion

You should now be aware of both appropriate and inappropriate behaviours in chickens and be able to take some steps to reduce behaviour that is not appropriate.

The next module focuses on the specific care of chicks including their specific needs and some problems that can arise.

Use the following checklist to assess whether your management practices prevent inappropriate behaviours.



Checklist

- I prevent overcrowding by providing 1 nest box for every 4 hens.
- I introduce new chickens to the flock by first quarantining for 30 days where they are visible to existing flock.
- I ensure proper feed and water is supplied to the flock.
- I monitor the temperature to see if birds are too hot or too cold.
- I monitor for brooding and take actions to correct the behaviour



Module 6

Care of Chicks



Objectives

After you have completed this module, you will be able to:

- Reduce your risk of spreading salmonella when you handle chicks
- Provide an environment that meets the temperature, food and water requirements of chicks
- Recognize the symptoms of common chick problems and prevent or treat these problems.





In Module 5, you learned to recognize appropriate and inappropriate behaviours in chickens. This knowledge can help you prevent any undesirable behaviours.

This module is specific to baby chicks. Chicks require special care in order to survive and thrive. Proper care during a chick's first few weeks of life is crucial to having healthy adult chickens.

Health Risks

Salmonella is a health risk to those who own and handle chicks. Do not allow children under the age of three to handle chicks. Children at this age have a tendency to place foreign objects into their mouths. Poultry, including baby chicks, carry salmonella and can cause severe illness in people, especially in at-risk age groups such as the very young and old.

Spread of Salmonella

Salmonella is found in the intestine of the chicken but can spread to the feathers, the beak and feet. The young chick will clean itself and spread the salmonella all over its body. Salmonella can also be found in the environment of the chicken coop, making it very easy to track into the house. To decrease the risk of spreading salmonella to yourself and others, wash your hands thoroughly before and after touching live birds (such as chicks).

Holding Baby Chicks

Handle chicks using two hands. Use one hand to support the feet underneath and the other hand to contain the chick with the head being free to move (see Figure 6-1 Proper Holding of a Chick). If chicks are held too tightly, they may suffocate.

Figure 6-1 Proper Holding of a Chick

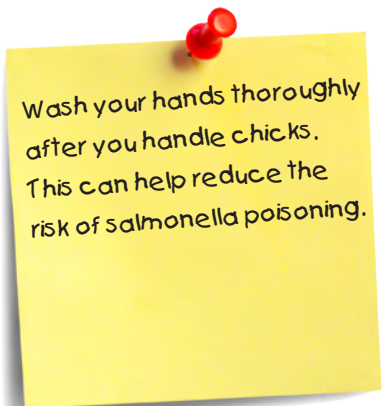

Necessities for Survival

Some of the necessities for the survival of chicks include a brooder and the proper temperature, water and food.

Brooder

The brooder is where you house your chicks. It keeps the chicks and heat contained. Chicks grow very quickly in the first few weeks of life. When the chicks grow, they need to be moved to a larger brooder. There are many designs of brooders on the market with the most common ones including cardboard or wooden boxes, or large plastic totes (see Figure 6-2 Brooder from Large Plastic Tote). The sides of the brooder need to be high enough (more than 2 feet) to keep chicks in. If the brooder is too short, you will find chicks perched on top of it or outside of the brooder. To discourage the chicks from leaving the brooder, you can place a wire mesh over the top. Chicks need enough space inside the brooder to move away from the heat source if it is too hot.

Figure 6-2 Brooder from Large Plastic Tote



You can purchase a brooder or make your own.



Temperature

Once the chicks arrive, place them in the brooder, close to the heater, food and water. It is important to measure the surrounding air temperature at the height of the chicks. The temperature should be 32.2°C (90°C). Chicks are dependent on external heat sources, so a working, height-adjustable heat lamp is crucial. You can remove the heater once the chicks are fully feathered, when they will then have sufficient insulation from their feathers.

See Figure 6-3 Effect of Temperature on Chick Distribution for illustrations on what happens when the temperature is too high or low or when there is a draught.

Figure 6-3 Effect of Temperature on Chick Distribution

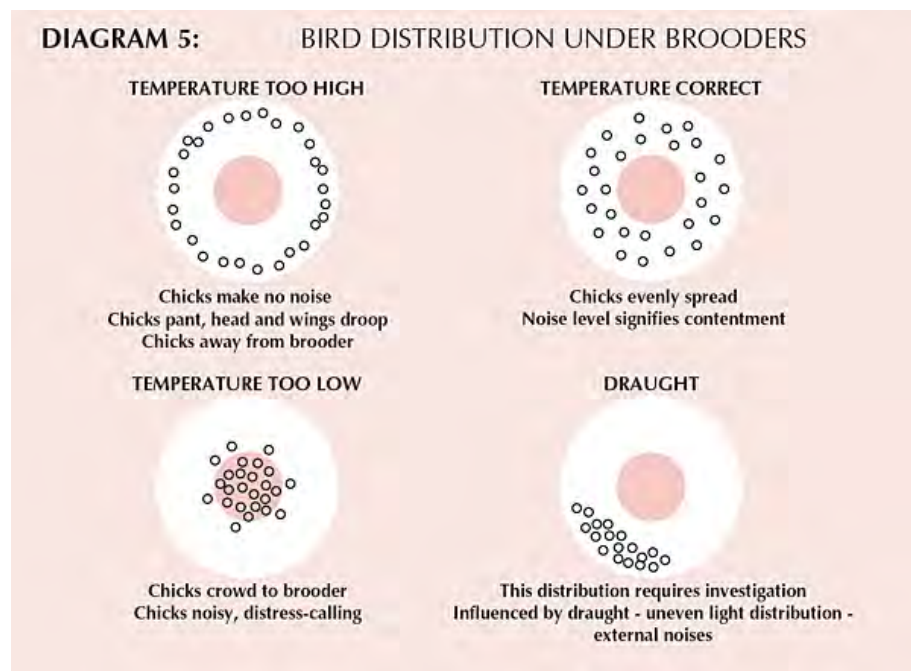

Water

Guide the chicks to the water source, and dip their beaks into water. Chicks need your physical prompting during their first drink of water in order to learn how to drink. Place waterers at a height that chicks can reach. Keep a close watch on the chicks to ensure that each one has learned how to drink.

See more detailed information on the correct temperature below.



The University of Minnesota has created three educational videos that can help you prepare the brooder for your chicks. A subscript is included with each video. <http://www.extension.umn.edu/food/small-farms/videos/>



www.agriculture.gov.sk.ca



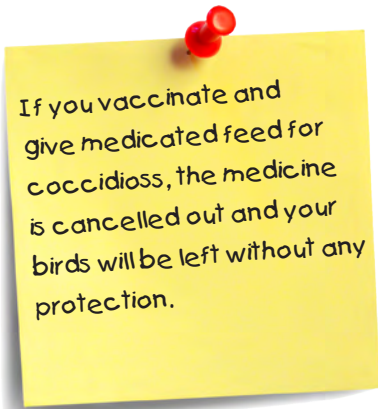

If you vaccinate and give medicated feed for coccidiosis, the medicine is cancelled out and your birds will be left without any protection.

Food

Commercial feed stores sell chick starter. If you are mixing your own feed, get some advice from a feed mill or feed store. Do not provide grit to chicks until after their first week of life.

Coccidiosis



Find out whether your chicks have been vaccinated for coccidiosis. You can then decide whether to feed them medicated feed. If they are not vaccinated, feed them medicated feed. If they have been vaccinated against coccidiosis, feed them unmedicated feed.

Common Chick Problems

The following chart (Table 6-1 Common Chick Problems) provides a list of common chick problems, the cause of these problems and some possible ways to prevent or solve the problem.



Table 6-1 Common Chick Problems

Problem	Cause	Prevention / Solution
Suffocation/smothering	<ul style="list-style-type: none"> • Temperature too cold so chicks will huddle to stay warm but may suffocate chicks underneath • Chicks when frightened will pile together at the risk of suffocating a chick underneath • Chicks may have been held too tightly during handling 	<ul style="list-style-type: none"> • Adjust temperature • Use a calm approach • Use appropriate handling techniques • Wear darker colours (navy, blue, black); birds respond in a calmer manner to darker colours
Starve-Out Chicks do not eat within the first 2-3 days	<ul style="list-style-type: none"> • Chicks in transit too long • Temperature around feeders is too hot or too cold • Feeders are too high or located where chicks cannot find them 	<ul style="list-style-type: none"> • Purchase chicks from reliable source • Monitor temperature around feeders • Adjust temperature if necessary
Dehydration	<ul style="list-style-type: none"> • Brooding temperatures are too high • Chicks need to be shown the water source and physically have their beaks dipped in the water 	<ul style="list-style-type: none"> • Constantly monitor • Supply fresh water • Dip new chicks' beaks in water upon arrival
Pasty Butt Feces stuck to chick's vent (where manure & eggs come out) 	<ul style="list-style-type: none"> • Stress during transport • Overheated • Too cold • Wrong feed 	<ul style="list-style-type: none"> • Constantly monitor • Take immediate action • Gently swab with damp cotton swab, washcloth or paper towel and dry gently • Adjust temperature if too hot or cold • Adjust feed
<u>Omphalitis</u> Yolk sac infection from unhealed navels -lack of energy -lack of appetite -sudden death	Possible contamination in hatchery	<ul style="list-style-type: none"> • Buy from reputable source • No known treatment
<u>Spraddle Legs</u> Also called perosis/slipped tendon  image from poultryhelp.com	What is the cause??	<ul style="list-style-type: none"> • Use bedding that provides adequate traction (avoid newspaper as it is too slippery). • Treat gently by bringing legs closer together and using a bandage to correct legs
Curled Toe Paralysis -nutrient deficiency -lack of riboflavin  Image from poulvet.com	Laying hens (chicks' parents) were fed non-supplemented layer ration	<ul style="list-style-type: none"> • Provide multivitamin supplement in water



Chick Problems

Check your understanding of chick problems, their causes and prevention or treatment by completing the chart below.

Cause or Condition	Possible Problems	Treatment or Prevention
Temperatures too hot	_____	_____
Wrong feed or ration	_____	_____
Temperature too cold	_____	_____
Stress during transport	_____	_____
Chicks are frightened	_____	_____

Conclusion

This module has introduced you to some specific requirements of baby chicks in order for them to survive and thrive during the first few weeks of life. You should have an understanding of specific problems that chicks may experience and know how to treat or prevent these problems.

The next module looks at the unique challenges that owners in Alberta face in dealing with winter conditions.

Use the following checklist to assess how well your management practices meet the needs of baby chicks.



Checklist

- I take steps to prevent salmonella contamination of myself and others.
- I hold baby chicks in the proper manner and teach others proper handling.
- I provide an environment that meets the temperature, food and water requirements of chicks.
- I recognize the symptoms of common chick problems and prevent or treat these problems.



Module 7

Care of Chickens During the Winter

Objectives

After you have completed this module, you will be able to:

- Select a chicken breed that is suited to the climate in Alberta
- Prevent frostbite in birds spending time outdoors and prevent freezing of eggs
- Winterize the coop by using insulation, widened perches and proper ventilation.





In Module 6, you examined the specific requirements to keep chicks healthy during the first few weeks of life. In this module you focus on keeping your flock healthy during the winter in Alberta.

Winter can bring unique challenges to poultry owners through increasing chances of frost bite, respiratory illnesses and behaviour problems. Potential behaviour problems can include both aggressive and severe feather pecking. Your goal over the winter is to have healthy birds that display the following.

Example Signs of a Healthy Bird

- Bright coloured eyes, red combs and wattles
- Complete plumage
- Active
- Eating and drinking normally
- No evidence of parasites.





Breed Selection

If your goal is to maintain chickens over the winter, it is important to be selective when choosing your chicken breed. Choose breeds with small combs and wattles to decrease the chance of frostbite. Choose a bird with lots of feathers to provide insulation. See Table 7-1 Breeds Suitable for Winter for a list of suitable breeds.



Table 7-1 Breeds Suitable for Winter

Breed	Features
Chantecler 	Cushion comb



<p>Dominique</p> 	<p>Rose comb, thick down</p>
<p>Hamburg</p> 	<p>Rose comb</p>
<p>Wyandotte</p> 	<p>Rose comb, thick feather</p>
<p>Jersey Giant</p> 	<p>Single comb</p>
<p>Orpington</p> 	<p>Single comb</p>



<p>Plymouth Rock</p> 	<p>Single comb</p>
<p>Rhode Island Red</p> 	<p>Single comb</p>
<p>Light Sussex</p> 	<p>Single comb</p>

Frostbite

Exposure to extreme cold temperatures can result in damage to the wattle, comb and toes. At first, wattles, combs and toes turn pale, and then turn black, swell or shrivel (see Figure 9-1 Frozen Comb). The frostbitten parts may eventually fall off. If frostbite does occur, separate the bird from the flock and apply a warm damp cloth to the injured area for approximately 10 minutes.

To prevent frostbite, reduce moisture (humidity) in the coop by removing any wet litter and providing proper ventilation to allow moist air to escape the coop. If chickens are allowed outside, monitor the amount of time spent outdoors.



If a chicken moults during the winter, it is at risk of developing frost bite. Keep moulting chickens indoors and provide a heat source and extra protein in their feed.

Figure 9-1 Frozen Comb



Egg Handling in Winter

Without proper insulation in the nest boxes, eggs have the potential to freeze. Eggs that are frozen are cracked and look as if they are hard boiled (see Figure 9-2 Frozen Cracked Eggs). Collect eggs often to prevent breakage and wastage.

To keep hens laying all year round, you need to provide supplemental light to account for the decrease in natural light during the winter months. Chickens require 14 hours of daylight to stay in production. To conserve electricity, use a time sensor.

Figure 9-2 Cracked Frozen Eggs



Enrichment

When chickens are enclosed in a space, especially if they have previously been allowed outdoors, they become bored and may display an increase in severe feather pecking. Chickens love to dust bathe and forage (see Figure 9-3 Chicken Dust Bathing and Figure 9-4 Chicken Foraging). Place peat or sand to encourage dust bathing. Enrichment of the environment, such as dangling strings or hiding treats inside of straw bales, can contribute to chicken health and decrease severe feather pecking.

Figure 9-3 Chicken Dust Bathing



Figure 9-4 Chicken Foraging



Winterizing the Coop

In the poultry house, either due to a draft, improper ventilation or mismanaged heating system, there can be inconsistent temperatures that can create hot and cold regions. Temperature fluctuations can increase the likelihood of a disease or illness.

Make Your Coop More Winter Proof

- Position the chicken house to reduce any wind exposure.
- Place your windows in the chicken coop facing south to catch more light during the winter months.
- Ensure the roof is sturdy enough to withstand the weight of heavy winter snow.

Draft-Free

If you are using fixed housing with an outdoor run, you can add plastic to the sides of the run to protect the flock from wind-chill and drafts. Once wind ruffles a chicken's feathers, it reduces the insulation value of the feathers.

Ventilation

As much as you need warm air to stay in the coop, you also need to let moisture out. Too much moisture in the coop can be deadly for chickens. Provide an inlet for fresh air and an outlet for warm air to escape. Placement of ventilation is crucial and must be up high near the roof. The ventilation must also be protected from the elements; you do not want snow, hail, sleet or rain to enter the coop. You also need to ensure predators cannot get into the coop.



Example Types of Natural Ventilation

Natural ventilation can include inlet door opening, open window(s), ventilation slot, gable or louvered vents. Mechanical ventilation can consist of an electrical fan or wind turbine. If the roosts are too close to the ventilation opening, you risk giving your chickens a draft.



Roosts

When chickens roost at night, their feet can overhang and subject them to frostbite. If you provide a widened perch, the chicken's feet will be less likely to freeze. See Figure 9-5 Chickens Roosting on Widened Bench.

Figure 9-5 Chickens Roosting on Widened Bench



Insulation

Some common insulation materials are polyurethane spray foam, glass wool, fiberglass and reflective materials, or straw bales. Add a vapour layer to prevent condensation on the wall. Insulation must never be exposed as chickens will ingest insulation material. Cover up any insulation with plywood, duct tape or feed sacks. Look at R-value, and make sure it is designed for the temperatures experienced in the winter.

Conclusion

In Alberta, you face some harsh winter conditions. You must be able to protect your flock from the cold winter temperatures. This module has provided some ways to protect your chickens from frostbite and make the coop more draft-proof and insulated.

The next module looks at bird health and disease. You are introduced to methods of vaccination as well as common infectious diseases of poultry in Alberta.



Use the following guide to determine which R-value is best for you:

Canada

http://www.cmhc-schl.gc.ca/en/co/grho/grho_010.cfm

USA

<http://www.naima.org/insulation-knowledge-base/residential-home-insulation/how-much-insulation-should-be-installed.html>



Use the following checklist to assess how well your flock is protected during the winter.



Checklist

- I have selected breeds that can withstand the cold winter conditions in Alberta.
- I take steps to prevent frostbite, particularly if chickens spend time outside.
- I have winterized the coop with insulation, widened perches and proper ventilation.
- I have provided some enrichment for the chickens to prevent boredom and undesirable behaviours.



Module 8

Health and Disease of the Flock

Objectives

After you have completed this module, you will be able to:

- Describe the various means of vaccination and the need to adhere to withdrawal times
- Collect items for a first-aid kit for your flock
- Recognize the signs of various infectious diseases and reporting requirements.





In the previous module you looked at the unique challenges that winter brings to poultry owners through increasing chances of frostbite, respiratory illnesses and behaviour problems.

This module focuses on how the health of a flock can be affected by environmental factors, poor management techniques and disease causing agents. Birds can suffer stress from severe weather, overcrowding and poor nutrition. Any one or all of these factors can result in disease.

You can ward off some diseases by practicing good husbandry; however, you will need to address some diseases with vaccines.

Vaccinations

Vaccines are important to the health of your flock because they prevent diseases by boosting a chicken's immune system. Diseased birds can continue to affect other birds of your flock and risk spreading disease to other flocks if you have contact with other chicken farmers.

Note that hatcheries may sell chicks with a vaccination package. It is recommended that you purchase vaccinated chicks from the hatchery.

As a chicken owner, adhere to the following best practices:

- If the birds need to be vaccinated, seek veterinary assistance to ensure proper administration.
- Make sure your birds are getting the vaccine you ordered.
- Ensure proper storage and administration of the vaccine according to label or prescribed directions.
- Clean and disinfect tools that are used to administer vaccines.





For more information on vaccines, go to:

www.poultryhub.org/health/health-management/vaccination/

www.canadianpoultry.ca/principles_of_vaccination.htm

Withdrawal Times

Adhere to all vaccination withdrawal times. A withdrawal time on a drug label indicates the drug's elimination rate, or the number of days that must pass before you can safely butcher a bird for meat. In the case of laying hens, it is recommended that you add another ten days to the withdrawal date as residue from the drug can stay in the developing egg for that long. Most vaccinations and antibiotics have specified withdrawal times listed in the instructions on the bottle or insert sheet.

Vaccination Methods

Depending on the type of vaccination, there can be different methods used. Table 8-1 Vaccination Methods provides a list and brief description of the types of vaccination that could be used by your veterinarian.

Table 8-1 Vaccination Methods

Vaccination Method	Description
In Ovo-Vaccination	This vaccine is administered to the egg at the hatchery at 18-19 days of incubation.
Intramuscular Injection	The vaccine is injected into the breast muscle, thigh, wing, tail or head.
Subcutaneous Injection	The vaccine is injected at the back of the neck, under the skin or the inguinal fold.
Ocular	The vaccine is dropped into the eye using an eyedropper.
Nasal	The vaccine dust or drop is placed into the nostril.
Oral	The vaccine is given through the mouth.
Drinking Water	The vaccine is added to the drinking water.
Cloacal	An abrasive applicator is dipped into the vaccine and inserted into the cloaca through a twisting motion.
Feather Follicle	Some feathers are removed and the vaccine brushed into the follicle.
Wing Stab	The vaccine is inserted into the leading edge of the wing.
Spray	An atomiser spray falls onto the body of the chickens and is ingested as other chickens peck droplets.



Chicken First-Aid Kit

Your chickens may get sick or injured and some may even need to be euthanized.



Assemble a First-Aid Kit

Use the following checklist to help you assemble a first-aid kit to treat minor injuries or diagnose disease or euthanize a bird.

- The number to reach your veterinarian: _____
- Euthanasia Guide <http://www.chickenfarmers.ca/wp-content/uploads/2014/05/CFC-Euthanasia-Guidelines.pdf>
- Separate cage /pen or kennel to separate a sick or injured bird from the flock
- Spare heat lamp to warm a chilled bird that needs to be separated, or use as backup for brooder supplies
- Band-aids to correct straddle leg in chicks
- Thermometer
- Sterile sewing kit with dissolvable thread
- Tweezers to remove debris or inspect wounds
- Rubber/latex gloves to protect yourself and your chicken from spreading any bacteria infection or disease
- Gauze
- Adhesive cloth bandaging tape
- Instant vitamin mix and electrolytes for dehydrated birds

Disease

As the owner of chickens, you need to be able to recognize signs of disease and notify authorities immediately if you suspect a serious bird disease.

Reportable Diseases

You, as the bird owner, are legally responsible to notify authorities if a reportable disease is found on your farm. This list of reportable diseases can vary depending on the type of birds you own.



Reportable Diseases for Domestic Chickens, Bantams, Pheasants and Peafowl

- Infectious laryngotracheitis
- Highly pathogenic avian influenza or low pathogenic H5 or H7 influenza virus
- Newcastle disease
- Salmonella Gallinarum
- Salmonella Pullorum
- Salmonella Enteritidis
- Salmonella Heidelberg
- Salmonella Typhimurium
- Disease caused by any toxic substance that is a threat to animal health or human health.

For a complete list of reportable diseases, go to: [http://www1.agric.gov.ab.ca/\\$department/deptdocs.nsf/all/cpv12455](http://www1.agric.gov.ab.ca/$department/deptdocs.nsf/all/cpv12455)

Health Questions

For any health questions about your flock, call Alberta Agriculture and Rural Development : Edmonton 780 427 1923 or Airdrie 403 945 8575.

Products Available at Peavey Mart:: Electrolytes Plus - Aid in recovering from stress of parasites, vaccinations and weather stresses.



Common Infectious Diseases in Alberta

For a list of some of the common infectious diseases of chickens, see Table 8-1.

A table that matches symptoms with the possible disease can be found at <http://edis.ifas.ufl.edu/ps044>

Table 8-1 Common Infectious Diseases in Alberta

Disease	Symptoms	Prevention
<p>Avian Influenza (AI)</p> <p>Avian Influenza is a high risk disease because it is highly infectious. It has a high impact on the producer and the poultry industry. The disease is usually spread from migratory birds and waterfowl. Birds with AI undergo high mortality, a severe drop in quality and quantity of egg production (eggs may lack shells), poultry products are closed to export markets, and culling of the flock is mandatory to stop the spread of the disease.</p>	<p>Birds lack energy and are inactive, increase water consumption, have swollen combs and wattles around eyes, red patches on legs, tremors of head and neck, and paralysis. The disease spreads between birds and premises through manure.</p>	<p>To prevent the spread of disease, use biosecurity measures: keep the coop clean, do not share any farm equipment, dedicate boots to poultry barn and use boot wash before and after visiting birds, and restrict visitors.</p>
<p>Coccidiosis</p> <p>Coccidiosis damages the gastrointestinal tract which hinders nutrient uptake which results in poor feed conversion and weight loss.</p>	<p>Symptoms of a coccidiosis case within a flock can include watery and bloody feces, poor performance (drop in egg production) and mortality.</p>	<p>Prevention methods include vaccination or medicated feed.</p> <p>Never vaccinate and give medicated feed at the same time.</p>
<p>Escherichia coli infection</p> <p>Escherichia coli infection (E.coli) causes infection in chickens if large numbers gain entry to the bloodstream from the respiratory tract and intestine.</p>	<p>It can lead to gross lesions and death in young poults.</p>	<p>Chickens can be vaccinated against certain strains, but clean living conditions decrease the chance of E.coli infection developing.</p>
<p>Infectious Bronchitis</p> <p>Infectious bronchitis is a highly contagious disease that can be spread through contact with infected equipment, feces and aerosols, and through ingesting contaminated feed, water and litter.</p>	<p>Symptoms include lack of appetite and decreased water consumption. Birds will have watery eyes and nostrils and make a high pitched chirping sound. Egg shells can become rough and the egg white becomes watery.</p>	<p>The best line of defense is to purchase clean birds and vaccinate your flock.</p>
<p>Infectious Laryngotracheitis (ILT)</p> <p>Infectious laryngotracheitis (ILT) is a highly contagious respiratory disease caused by the herpes virus.</p>	<p>With the mild form of ILT, symptoms include watery nostrils and eyes, and decrease in egg production. A severe form of ILT has symptoms such as severe coughing, and mouth and beak may have traces of blood and there is high mortality.</p>	<p>Prevention is through strict biosecurity measures: keep the coop clean, do not share any farm equipment, dedicate boots to poultry barn and use boot wash before and after visiting birds, and restrict visitors.</p>
<p>Marek's Disease</p> <p>Marek's disease is a highly contagious alpha-herpes virus.</p>	<p>Symptoms include transient paralysis, early mortality syndrome, cytolytic infection, atherosclerosis and persistent neurologic disease.</p>	<p>The best line of defense is to buy vaccinated chicks from a reputable source and keep the coop clean.</p>



<p>Mycoplasma Synoviae</p> <p>Mycoplasma synoviae infection in poultry (infectious synovitis) is a chronic infection found in the upper respiratory tract. This infection is found in mostly multi-aged flocks.</p>	<p>If infected, birds slow their movements and become lethargic, some form breast blisters, others show signs of respiratory distress (heavy breathing and wheezing).</p>	<p>To prevent this disease, keep chickens the same age.</p> <p>Do not buy chicks from flocks that have had mycoplasma synovia.</p>
<p>Staphylococcus Aureus</p> <p>Staphylococcus aureus infection is normally caused from contamination from an open navel at a hatchery, or an infected wound.</p>	<p>Symptoms include decrease in weight gain and egg production, lameness and mortality. Note: Can cause food poisoning in people.</p>	<p>To avoid infections, remove objects that may cause injury.</p> <p>To prevent food borne illness in humans, thoroughly wash your hands before and after touching any live or raw poultry. Cook poultry products thoroughly.</p>
<p>Ecto (External Parasites)</p> <p>Parasites such as lice and mites are common in poultry and will live on or just under the bird's skin. Parasites generally live off the chicken's blood.</p>	<p>Symptoms can include decreased food and water intake, red itchy skin and feather removal.</p>	<p>Periodically examine your birds to avoid infestation. Inspect your birds for mite infestation, under the feathers near the flesh. Once the parasite is identified, take the appropriate measure.</p>
<p>Newcastle Disease</p>	<p>Symptoms include sudden onset of hoarse chirps, watery discharge in nostrils, face swelling and even paralysis.</p>	<p>Vaccinate your flock and increase biosecurity measures.</p>
<p>Salmonella</p>	<p>See Module 9</p>	
<p>Campylobacter</p>	<p>See Module 9</p>	

For more information on Mycoplasma synoviae, go to:
http://www.merckmanuals.com/vet/poultry/mycoplasmosis/mycoplasma_synoviae_infection_in_poultry_infectious_synovitis.html

For more information on External Parasites go to:
<http://www.extension.org/pages/66149/external-parasites-of-poultry#.VPYFJU1rY2w>

To help determine the parasite type and subsequent treatment, please go to: <http://www.ksre.ksu.edu/bookstore/pubs/MF2387.pdf>





Given the following symptoms, indicate some possible diseases. Use the resource below and Table 8-1 to match symptoms with the possible disease: <http://edis.ifas.ufl.edu/ps044>

Clinical Signs for Common Poultry Diseases

Clinical Signs	Combined Symptoms	Possible Cause
Coughing	Coughing with blood	
Wheezing	If lethargic, shows signs of respiratory distress such as heavy breathing and gasping	
Eye and nasal discharge	Accompanied with high pitch chirping, egg shells become rough and egg whites watery	
Swelling of face, wattles	Accompanied with red/white spots on legs/comb, reduced appetite, tremors and paralysis	
Paralysis	If accompanied with hoarse chirps, watery discharge and paralysis If accompanied with high mortality rate and green watery diarrhea	

Adapted from <http://edis.ifas.ufl.edu/ps044>

See page 8-10 for possible answers.

Conclusion

In this module you have looked at the various methods of vaccination and the reasons you might purchase vaccinated chicks or have your own flock vaccinated. Table 8-1 provided you with a list of common chicken diseases, symptoms of those diseases and some ways to prevent the diseases.

The next module looks at some of the human health risks associated with keeping chickens and provides you with ways to reduce that risk.

Use the following checklist to assess whether your management practices help prevent some of the common diseases of chickens.

For a quick reference guide of disease risk, go to Appendix A: Biosecurity Risk Levels of Selected Poultry Diseases: <http://www.ontariochicken.ca/uploads/userfiles/files/biosecurity%20protocols%20for%20the%20poultry%20services%20sector.pdf>

For a guide to poultry anatomy and diseases, go to: http://www.lahinternational.com/clientuploads/pdf/PoultryAnatomyEng_w.pdf





Checklist

- I vaccinate or purchase vaccinated chicks to prevent those diseases that can be controlled by vaccination.
- I practice the following biosecurity measures: keep the coop clean, do not share any farm equipment, dedicate boots to poultry barn and use boot wash before and after visiting birds, and restrict visitors.
- I know the reportable diseases and follow the standards for reporting of these diseases.

Answers: Clinical Signs for Common Poultry Diseases

Clinical Signs	Combined Symptoms	Possible Cause
Coughing	Coughing with blood	Infectious Laryngotracheitis
Wheezing	If lethargic, shows signs of respiratory distress such as heavy breathing and gasping	Mycoplasma Synoviae
Eye and nasal discharge	Accompanied with high pitch chirping, egg shells become rough and egg whites watery	Infectious Bronchitis
Swelling of face, wattles	Accompanied with red/white spots on legs/comb, reduced appetite, tremors and paralysis	Avian Influenza
Paralysis	If accompanied with hoarse chirps, watery discharge and paralysis If accompanied with high mortality rate and green watery diarrhea	Newcastle Disease Marek's Disease



Module 9

Keep Your Family Safe



Objectives

After you have completed this module, you will be able to:

- Describe several food-borne illnesses and how to prevent them
- Take five simple steps to protect you and your family from getting ill
- Choose personal protective equipment to protect you from injury and illness when working with chickens and in the coop.





In the previous module you looked at diseases of chickens and how to keep your flock healthy through vaccination and biosecurity measures.

This module focuses on the safety of your family. Safety for your family involves preventing the spread of disease, following food safety guidelines and wearing personal protective equipment. Included in this module are common food-borne diseases and preventative measures against illness and injury.

Infection and Disease Spread from Poultry to People

One of the serious diseases that can spread from poultry to people is avian influenza. People risk contracting avian influenza if they are in direct contact with infected live birds or have had close contact with a person infected with avian influenza. To prevent the spread of disease, use biosecurity measures: keep the coop clean, do not share any farm equipment, dedicate boots to poultry barn and use boot wash before and after visiting birds, and restrict visitors.

For more information on avian influenza, see Module 8.

Food Borne Illnesses from Contaminated Meat and Eggs

There are several food-borne toxins that can affect human health. These illnesses generally come from contaminated meat and eggs. Food-borne pathogens that are common in poultry are campylobacter and salmonella; however, there are other less common food-borne pathogens that can contaminate poultry and eggs. The pathogens include listeria, staphylococcus and clostridium perfringens.

Salmonella

Salmonella is a food-borne pathogen from anaerobic bacteria that is transmitted from the parent stock (laying hen) to the egg. Salmonella from an infected bird can be ingested via the meat and eggs. If you eat salmonella infected foods, you can get food poisoning. Food poisoning can be very serious for children and older people in particular.

Prevention

To prevent salmonella, wash your hands after handling baby chicks, chickens, animal feed, barn equipment, chicken housing equipment and materials. Wash your hands after handling fresh eggs. Cook poultry products to a safe inner temperature (See *Five Steps to Avoid Getting Sick* on page 9-6).



For more information on salmonella, go to:
<http://www.cdc.gov/healthypets/resources/salmonella-baby-poultry.pdf>



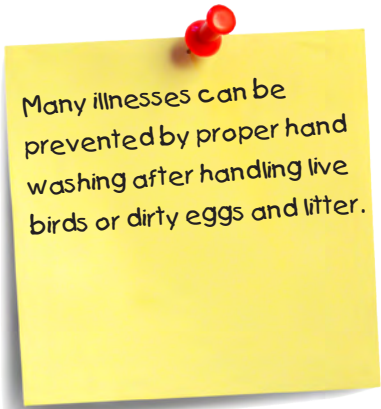

Many illnesses can be prevented by proper hand washing after handling live birds or dirty eggs and litter.

Campylobacter jejuni

Campylobacteriosis is an illness caused by the campylobacter bacteria. It is found in the intestines of wild and domestic animals. Poultry can carry the disease without becoming ill, but campylobacter jejuni can spread from animals to humans through close contact with infected animals, improper food handling and poor hygiene practices such as not washing hands before eating food after handling dirty eggs, litter and live birds. The campylobacter attacks the digestive system, and a person may experience abdominal pain, vomiting, diarrhea and fever.

Prevention

To prevent campylobacter, follow food safety guidelines when you prepare, cook and serve your poultry products. Always wash your hands before and after touching raw poultry and eggs. Also always wash your hands before and after touching live birds, including chicks.

Listeria Monocytogenes

Listeria is a food-borne illness that is caused by the Listeria monocytogenes bacterium. This bacterium is naturally carried by animals, such as poultry, and can contaminate the meat if it is not handled safely. If you use chicken manure as a fertilizer, you may contaminate vegetables in your garden. Symptoms of listeria include flu-like symptoms such as fever and diarrhea but also confusion and incoordination.

Prevention

To prevent this illness, wash your hands before and after you prepare food. Prepare meat on a separate cutting board to prevent cross-contamination. Always wash and disinfect kitchen tools such as knives. Listeria bacteria can grow in your refrigerator. It is crucial to wipe up, wash and disinfect any spills. When you defrost chicken, make sure any juices are contained and will not contaminate other foods.

Staphylococcus

Staphylococcus is a bacterium that can be found in the mouth and nose of animals and people. It is commonly transferred to food by the food handler. If the food is not properly refrigerated, bacteria will grow and contaminate the food.



Prevention

To prevent sickness from staphylococcus, wash your hands properly before and after touching live animals and poultry products. Always refrigerate or freeze food at maximum two hours after cooking. Check refrigerator and freezer temperatures and adjust if not cold enough.

Clostridium Perfringens

Clostridium perfringens is a bacterium that is found in the environment, especially in soils, sewage and dust. Food can become contaminated with the bacteria when a food handler improperly handles the food with unwashed hands and does not store the food properly. The bacteria are more commonly found at establishments that serve large quantities of food. The bacteria affect the gut and tend to cause symptoms such as bloating, increased gas, diarrhea and nausea.

Prevention

To prevent contamination, always wash your hands thoroughly before handling food and store and refrigerate properly. Once food is cooked, if it is let stand too long, the bacteria will contaminate the food. (See Five Steps to Avoid Getting Sick on page 9-6).

See Table 9-1 for a summary of some common food-borne pathogens, the cause of contamination and symptoms of the contamination.

Table 9-1 Common Food-Borne Illness from Poultry

Pathogen	Exposure	Symptoms
Campylobacter jejuni	Raw poultry, undercooked poultry, live poultry, dirty eggs	Diarrhea, abdominal pain, fever, nausea, vomiting
Salmonella	Raw poultry, undercooked poultry, live poultry, dirty eggs	Fever, chills, diarrhea, abdominal cramps, headache (with sudden onset), nausea, vomiting
Listeria	Contaminated poultry and poultry by-products	Vomiting, nausea, severe headache, constipation, cramps, diarrhea, persistent fever



Five Steps to Avoid Getting Sick

Most food-borne illnesses can be avoided by following some simple food safety measures. Take the following five simple steps to protect you and your family from food-borne illness.

Step 1 Shopping

- Bag meats separately from other produce.
- Buy perishable items before the expiry date.

Step 2 Preparation

- Wash your hands before and after touching raw poultry and other foods.
- Wash your hands after using the washroom and changing diapers.
- Designate separate cutting boards for meat, vegetables and fruit, and dairy. This will prevent cross contamination.
- Always use clean knives when preparing food.

Step 3 Storage

- Keep refrigerator at 4° C or colder.
- Do not leave foods in the danger zone (between 4°C and 60°C).
- Cook, refrigerate or freeze poultry and eggs within 2 hours.
- Label the date the product was stored.

Step 4 Cooking

- Use a clean thermometer to determine inner temperature of meat.
- Cook poultry so that the inner temperature is a minimum of 73.8°C; this includes breasts, thighs and legs.
- Cook egg dishes to a minimum inner temperature of 71.1°C.
- Reheat leftovers to a minimum of 74°C.

Step 5 Serving

- Serve hot foods at 60°C and above.
- Serve cold foods at 4°C and below.
- Wash hands before and after serving food.

You can avoid most food-borne illnesses by proper hygiene and food handling practices.





Emergency Numbers

Write down any emergency numbers missing from the list below and post the list at the entrance of your barn or coop.

Poison Control: 1-800-332-1414

Fire/Police/Ambulance: 911

Crime Stoppers: 1-800-222-TIPS (8477)

Ag-Info Centre Toll-free in Alberta: 310 FARM (310-3276)

Medical Clinic: _____

Hospital: _____

Veterinarian: _____

Personal Protective Equipment

Personal protective equipment (PPE) is designed to protect you from injury and illness. In a poultry coop/barn, PPE includes safety mask and respirators, ear plugs and muffs, safety goggles and glasses, rubber or steel-toed boots, long sleeved overalls, hair net and plastic gloves. To decrease the risk of bringing bacteria, bugs and disease from your flock into your home, place boot washes at the entrance of your coop, wash your hands and wear personal protective equipment when dealing with your poultry flock.

Chickens make a lot of dust, noise and odours. Your flock size will determine the level of all these factors. Dust can harbour many pathogens that can negatively affect your health. If you have prolonged exposure to dust, you can develop respiratory problems later in life. By wearing personal protective equipment such as a face mask, you can protect yourself from developing respiratory problems.

Chickens have sharp talons and beaks. These can injure anyone who comes into contact with chickens, including their owners. If someone is perceived as weak, chickens can turn on the individual and become aggressive. Roosters are especially prone to being aggressive. Children are at particular risk of injury; do not leave children unattended with chickens, regardless of flock size.

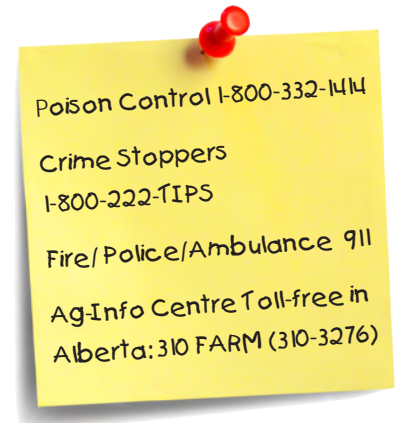

Conclusion

You should now be able to protect your family from food-borne illnesses from live poultry and poultry products. By following the five steps outlined in this module, you can likely prevent most food-borne illness.

The next and final module focuses on the safety of your chickens and what you can do to reduce any potential threats. It also provides guidance on euthanasia and safe disposal of dead chickens.

Use the following checklist to assess how well your animal and food handling practices protect you and your family.



Checklist

- I am aware of the common food-borne pathogens and understand how to protect my family from the illnesses caused by these pathogens.
- I follow the five steps to shop, prepare, store, cook and serve poultry products to prevent illness.
- I have posted a list of emergency numbers at the door of the poultry coop or barn.



Module 10



Safety for Your Chickens (Biosecurity)

Objectives

After you have completed this module, you will be able to:

- Prevent threats from wild animals and birds
- Reduce the risk of disease transmission from one bird to another and from people on the farm and visitors
- Keep records in case of emergency or disease outbreak
- Dispose of dead birds and euthanize birds in a safe and humane manner.





In the previous module, you looked at how to keep your family safe from diseases and food-borne illness from poultry and poultry products. This module focuses on safety of your flock.

Although much of the material in this module has been covered or touched on in other modules, this module brings together the biosecurity issues into one concluding module.

There are a number of potential threats that can compromise your flock. Pets, wild and domestic animals, and people may spread disease to your chickens. The word many poultry owners use when referring to securing their livestock from these types of threats is biosecurity.

Location of Chicken Coop

Ideally, the location of your chicken coop or farm should be away from other farms and backyard operations. Put up gates and signage to let others know that your property contains birds. The gates protect your birds from intruders and also prevent the spread of disease by vehicles, bicycles and foot traffic. If you let other bird owners know you have birds on your property, they can take steps to prevent contaminating your birds with any disease agent they may be carrying from their birds on their clothes and boots.

Predators

If domestic or wild animals see your farm as a food source, there is a higher risk of the spread of disease. Wild animals that pose as threats to your farm can include skunks, weasels, wolverine, mice, squirrels, foxes, coyotes, cougar, lynx, grizzly and black bear. Wild birds that pose a threat to your farm include pigeons, robins, chickadees, blue jays, crows, ravens, falcons, eagles, hawks, owls, geese and ducks.

To avoid attracting unwanted guests:

- Promptly clean up any spilled feed and litter.
- Keep food in sealed containers.
- Prevent foreign entry by fortifying your coop and thereby protecting your chickens from underground, air and ground level entries. If left unchecked, predators, pests and wild birds will find ways into the chicken coop/ barn.



Owners and Their Families

As an owner, you can protect your flock by taking the following precautions:

- Regularly wash your hands and body before and after entering any poultry housing units.
- Designate a change of clothes and boots specific to farm work.
- Wear appropriate safety gear such as face mask, hairnet and goggles.
- Thoroughly wash any egg collecting trays, baskets, trays, feed and water containers, cages and tools.
- Provide non-mouldy food and clean water daily.
- Provide fresh bedding and nest box materials weekly.
- Dispose of any dead birds and soiled litter according to municipal bylaws.
- Remove and dispose of any cracked or dirty eggs that will not be used.

Visitors to Your Farm

- Maintain a visitor log book that records contact information and the purpose for the visit.
- Record the following information: if a visitor has been in contact with other birds in the last 72 hours and if they own their own birds or have any allergies, such as dust.
- Provide protective gear including booties, foot baths, facial masks, hair nets, plastic gloves and extra clean coveralls for any visitors who enter the poultry premises.
- To reduce the risk of spreading disease, avoid borrowing from or sharing equipment with other bird owners.
- Use your own tools and thoroughly sanitize and disinfect before using.

Recognize and Report Disease

Keep records of all incoming birds on your farm and breeder contact information. If a bird gets sick, record the date, time and age of the bird. For traceability purposes, keep a logbook of all visitors on your farm.



Example Signs of a Sick Bird

Signs to look for include lack of energy, movement, or appetite, coughing, gasping, sneezing, lack of coordination or tremors, diarrhea, pale combs and wattles, swelling around neck, eyes and head, or sudden death.

Federally Reportable Diseases

If you suspect or have a confirmed reportable disease, you must report it to the Office of the Chief Provincial Veterinarian: at 780-427-3448 or toll-free by first dialing 310-0000.

Separate Sick, New or Returning Birds

Remove sick birds from your flock and quarantine them as described below. For any new and returning birds, keep separate from the flock, and quarantine them until it is safe to reintroduce them. Follow the procedure below for quarantining your birds.

Quarantine

A quarantine zone is a location on your property that is separate from the main flock. If you have a small yard, your quarantine zone could be a section of your garage or on the opposite side of the property. If you do have a larger yard, a minimum distance is 30 feet.

To decrease the risk of introducing a disease to your flock, monitor the quarantined birds for 30 days and watch for any signs of sickness before placing birds with the flock. If no signs of sickness are detected, place the birds in a separate pen that enables quarantined chickens to be seen by the others in the flock. Keep them separate for a week within eyesight of other chickens before releasing them, this allows the rest of your flock to become accustomed to the new birds.

Record Keeping

Record keeping is a critical part of biosecurity. Keep records of supplies purchased, management techniques, veterinary reports and customers. These records are necessary in case of emergency, food recall, disease outbreak or food safety issues.



See Module 8 for a list of federally reportable diseases.

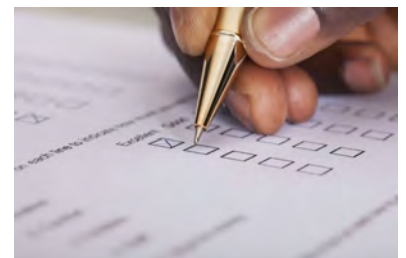

Example Type of Emergencies or Food Recalls

Emergencies can include fire, flooding, theft or equipment failure. Food recalls can include poultry products as well as poultry feed. This can be due to contamination on premises or a food-borne illness.



Records to Keep

Use the following checklist to ensure you are keeping records that are necessary in the case of a disease outbreak, such as avian influenza. This information can help the investigation.

- Flock records (e.g., mortality, production, feed and water intake)
- Veterinary records and laboratory reports
- Detailed description of farm management practices
- Records of purchase/sale of feed, poultry, etc.
- Movement on and off the premises during the past 21 days (e.g., feed trucks, power, gas)
- Farm visitor logbooks
- Site map of the farm
- Contact information for the farm veterinarian.

Educate Yourself

Keep yourself up to date on health and safety concerns and the latest biosecurity practices. Educate employees, family members and neighbours. Create a culture of health and safety on your property. Ensure easy access to protective gear such as face masks, plastic gloves, hairnet, designated work boots and work clothing.

For a short video on keeping diseases out of your flock, go to:

<http://www.inspection.gc.ca/animals/terrestrial-animals/biosecurity/tools/video/eng/1320092234079/1322158553549>

<http://www.inspection.gc.ca/animals/terrestrial-animals/biosecurity/tools/eng/1344790074044/1344790183249>



Mortality

Alberta designates five ways to safely dispose of dead chickens: burial, incineration, composting, rendering and natural disposal. The Alberta government has a guide that includes a decision-making tree, to help you decide which method of disposal.

For a guide to disposal of dead chickens, go to:
<http://www.agric.gov.ab.ca/livestock/poultry/mortality.pdf>

If you suspect that the chicken died from an infectious or reportable disease, contact an inspector or the chief provincial veterinarian.

If you suspect or have a confirmed reportable disease, you must report it to the Office of the Chief Provincial Veterinarian at: 780-427-3448 or toll-free by first dialing 310-0000.

To contact the Canadian Food Inspection Agency, go to: <http://www.inspection.gc.ca/english/animal/disemala/rep/repe.shtml>

For more information on composting techniques, go to page 44 of <http://www.agric.gov.ab.ca/livestock/poultry/mortality.pdf>

For information on Alberta Destruction and Disposal of Dead Animals Regulation, go to:
[http://www1.agric.gov.ab.ca/\\$department/deptdocs.nsf/all/rsb10366](http://www1.agric.gov.ab.ca/$department/deptdocs.nsf/all/rsb10366)

Help for Diagnosing and Treating Disease

Alberta Agriculture and Rural Development (ARD) has developed a program that aims at helping small flock non-quota holding farmers to diagnose and treat disease. When mortality occurs and disease is suspected, chicken owners and their veterinarians can drop off birds at one of four labs located in Fairview, Edmonton, Airdrie and Lethbridge. There, birds will undergo a post mortem examination. To inquire further about this, contact Dr. Colleen Christianson in Airdrie at 403 948 8575.



See Module 1 Regulations for more information on processing chickens.

Euthanasia

When you work with chickens, you may have to euthanize one or more of them. Cervical dislocation is a common way of euthanizing a bird.

For a step-by-step guide, go to:

<http://www.chickenfarmers.ca/wp-content/uploads/2014/05/CFC-Euthanasia-Guidelines.pdf>

Processing Chickens

In order to eat the meat of your chickens, they need to be slaughtered and processed. In Alberta, meat processing regulations require that chickens to be sold to the public must be processed at a federal or provincial inspected facility. If you butcher an animal and process on your own property, you and your family can eat it, but you cannot sell the meat to the public.

If you are shipping meat between provinces or exporting out of the country, the chickens must be processed at a federally inspected facility. Some retailers may require you to process your chicken at a federally inspected facility.

Note: Chickens that have finished their egg laying cycle are sometimes referred to as “spent hens”. The meat derived from these hens is excellent for making soups and stews.

When your birds (meat, dual, spent hens) are ready to be processed, take the steps outlined in Table 10-1.

Table 10-1 Steps to Get Birds Ready for Processing

Remove feed 8 –to12 hours before processing your birds	Follow the withdrawal feed times to prevent feed ending up in the crop and digestive tract, which increases the chance of fecal contamination of the carcass. If food is left to digest, you may be charged or your bird condemned. A condemned bird is thrown out, but you will still be charged a processing fee.
Turn lights off 2 hours before crating	Turn off the lights to calm the chickens down and reduce stress and the possibility of injury. Alarmed chickens will flap their wings and this can result in bruised, broken and damaged wings.
Keep vaccination records	Adhere to vaccination and medicated feed withdrawal times to prevent the meat processed being contaminated with the drug residue.



Conclusion

This module wraps up some of the biosecurity steps you should take to prevent threats from predators, reduce the risk of disease transmission from other birds and people and dispose of dead birds and euthanize those birds that require it. You should also be able to keep good records should there be an emergency or disease outbreak.

Use the following checklist to assess your biosecurity practices



Checklist

- I have located and designed the chicken coop to reduce the risk of predators.
- I have taken steps to reduce the risk of disease transmission from both family and visitors.
- I know the federally reportable diseases and to whom to report these diseases.
- I quarantine sick or new animals.
- I keep good records in case of emergency, food recall, disease outbreak or food safety issues.
- I know the regulations surrounding processing chickens, disposal of dead chickens and euthanasia.





References





References

Module 1 Regulations

Regulations - <http://eggs.ab.ca/industry/becoming-an-egg-farmer/>
[http://www1.agric.gov.ab.ca/\\$department/deptdocs.nsf/all/agdex10326](http://www1.agric.gov.ab.ca/$department/deptdocs.nsf/all/agdex10326)
[http://www1.agric.gov.ab.ca/\\$department/deptdocs.nsf/all/agdex14045](http://www1.agric.gov.ab.ca/$department/deptdocs.nsf/all/agdex14045)

Module 2 Basic Chicken Needs

Feed - <http://www.championfeeds.com/downloads/documentloader.aspx?id=1519>
http://extension.usu.edu/files/publications/publication/AG_Poultry_2008-02pr.pdf
<http://www.dummies.com/how-to/content/how-to-choose-commercial-chicken-feed.html>
Food Toxic to Chickens - Adapted from http://readynutrition.com/resources/10-foods-you-should-not-feed-your-chickens_09022014/
Plants Toxic to Chickens - Adapted from: <http://www.cbif.gc.ca>
Light - <https://connect.extension.iastate.edu/p7k8epk4pbz/?launcher=false&fcsContent=true&pbMode=normal>
Shelter and Air Quality - Adapted from http://www.agf.gov.bc.ca/ahc/poultry/small_flock_manual.pdf
Ventilation - Adapted from <http://www.thepoultrysite.com/articles/2321/key-factors-for-poultry-house-ventilation> and <http://en.engormix.com/MA-poultry-industry/management/articles/ventilation-rates-t2118/124-p0.htm>

Module 3 Chicken House Design and Sanitation

<http://msucares.com/poultry/diseases/sanitation.html>

Module 4 Egg Management

<http://www.extension.org/pages/71004/raising-chickens-for-egg-production#.VP9sneFySTY>
<http://www.thepoultrysite.com/articles/1548/smallscale-egg-handling-1/>

Module 5 Appropriate/Inappropriate Behaviours in Chickens

Explanation of Behaviour - http://www.extension.org/pages/66175/normal-behaviors-of-chickens-in-small-and-backyard-poultry-flocks#.VE_Eqhbsqc4
Moulting - http://journals.cambridge.org/download.php?file=%2FWPS%2FWPS61_04%2FS0043933905000395a.pdf&code=7e7de6c97133786a83c2e95bce65491e



Module 6 Care of Chicks

<http://www.gov.mb.ca/agriculture/livestock/production/poultry/brooding-temperatures-for-small-poultry-flocks.html>

http://www.hylinena.com/UserDocs/products/Lohmann_Alternative_System.pdf

Module 7 Care of Chickens During the Winter

<http://www.backyardchickenelearning.com/identify-your-chicken-by-its-comb-type/>

<http://www.livestockconservancy.org/index.php/heritage/internal/chicken-chart>

<http://www.the-chicken-chick.com/2013/11/surviving-winter-with-chickens.html>

<http://www.aces.edu/dept/poultryventilation/documents/Nwsltr-55GetReadyforWinter.pdf>

Module 8 Health and Disease of the Flock

Disease Overview - <http://www.merckmanuals.com/> and www.canadianpoultry.ca

Vaccinations - Adapted from <http://www.poultryhub.org/health/health-management/vaccination/>

Medicated Feed/Vaccinations - <http://www.farad.org/publications/miscellaneous/LayingHensEggResidues.pdf>

Module 9 Keep Your Family Safe

Food-borne Illnesses – Adapted from

<http://www.thepoultrysite.com/articles/2041/strategies-to-control-salmonella-in-poultry>

<https://myhealth.alberta.ca/health/Pages/conditions.aspx?hwid=ug2074&#ug2074-sec>

<http://www.phac-aspc.gc.ca/fs-sa/fs-fi/campylo-eng.php>

Food-borne Illness Table - Adapted from <http://www.inspection.gc.ca/>

Module 10 Safety for Your Chickens (Biosecurity)

<http://www.thepoultrysite.com/articles/862/backyard-flock-tip-biosecurity-and-beyond>

http://safemanitoba.com/sites/default/files/uploads/animal_web.pdf

Ready to be Processed - <http://www2.ca.uky.edu/agc/pubs/ASC/ASC210/ASC210.pdf>

Manure Management Statistics on Laying Hens Excrement - <http://msucares.com/pubs/infosheets/is1973.pdf>

